





ANNUAL REPORT OF THE  
BOARD OF REGENTS OF  
THE SMITHSONIAN  
INSTITUTION

SHOWING THE  
OPERATIONS, EXPENDITURES, AND  
CONDITION OF THE INSTITUTION  
FOR THE YEAR ENDED JUNE 30

1943



(Publication 3741)

UNITED STATES  
GOVERNMENT PRINTING OFFICE  
WASHINGTON : 1944

LETTER OF TRANSMITTAL

---

SMITHSONIAN INSTITUTION,  
*Washington, December 28, 1943.*

*To the Congress of the United States:*

In accordance with section 5593 of the Revised Statutes of the United States, I have the honor, in behalf of the Board of Regents, to submit to Congress the annual report of the operations, expenditures, and conditions of the Smithsonian Institution for the year ended June 30, 1943. I have the honor to be,

Very respectfully, your obedient servant,

C. G. ABBOT, *Secretary.*

## CONTENTS

---

	Page
List of officials .....	vii
The Smithsonian in wartime .....	1
Summary of the year's activities of the branches of the Institution.....	5
The establishment.....	9
The Board of Regents.....	10
Finances.....	11
Publications.....	11
Library.....	12
Appendix 1. Report on the United States National Museum.....	13
2. Report on the National Gallery of Art.....	25
3. Report on the National Collection of Fine Arts.....	35
4. Report on the Freer Gallery of Art.....	41
5. Report on the Bureau of American Ethnology.....	47
6. Report on the International Exchange Service.....	56
7. Report on the National Zoological Park.....	65
8. Report on the Astrophysical Observatory, including the Division of Astrophysical Research and the Division of Radiation and Organisms.....	75
9. Report on the library.....	77
10. Report on publications.....	82
Report of the executive committee of the Board of Regents.....	89

## GENERAL APPENDIX

---

Solar radiation as a power source, by C. G. Abbot.....	99
Some biological effects of solar radiation, by Brian O'Brien.....	109
The sea as a storehouse, by E. F. Armstrong, D. Sc., F. R. S.....	135
Progress in new synthetic textile fibers, by Herbert R. Mauersberger.....	151
Petroleum geology, by William B. Heroy.....	161
The 1942 eruption of Mauna Loa, Hawaii, by Gordon A. Macdonald.....	199
New metals and new methods, by C. H. Desch, F. R. S.....	213
Oceanography, by Henry C. Stetson.....	219
The ocean current called "The Child," by Eliot G. Mears.....	245
Maps, strategy, and world politics, by Richard Edes Harrison and Robert Strausz-Hupé.....	253
The natural-history background of camouflage, by Herbert Friedmann.....	259
Dangerous reptiles, by Doris M. Cochran.....	275
The plants of China and their usefulness to man, by Egbert H. Walker.....	325
Natural rubber, by O. F. Cook.....	363
Lessons from the Old World to the Americas in land use, by Walter Clay Lowdermilk.....	413

	Page
Areal and temporal aspects of aboriginal South American culture, by John M. Cooper.....	429
Origin of the Far Eastern civilizations: A brief handbook, by Carl Whiting Bishop.....	463
Contours of culture in Indonesia, by Raymond Kennedy.....	513
The Arab village community of the Middle East, by Afif I. Tannous.....	523
Chemotherapeutic agents from microbes, by Robert L. Weintraub.....	545
Sulfonamides in the treatment of war wounds and burns, by Charles L. Fox, Jr., M. D.....	569
The yellow fever situation in the Americas, by Wilbur A. Sawyer.....	575
Some food problems in wartime, by George R. Cowgill.....	591



## LIST OF PLATES

---

	Page
Secretary's Report:	
Plates 1, 2.....	42
Solar radiation as a power source (Abbot):	
Plates 1-3.....	108
Biological effects of solar radiation (O'Brien):	
Plate 1.....	134
The sea as a storehouse (Armstrong):	
Plates 1-4.....	150
Eruption of Mauna Loa (Macdonald):	
Plates 1, 2.....	212
Ocean current called "The Child" (Mears):	
Plates 1, 2.....	252
Maps (Harrison and Strausz-Hupé):	
Plates 1-5.....	258
Camouflage (Friedmann):	
Plates 1-16.....	274
Dangerous reptiles (Cochran):	
Plate 1.....	324
Plates 2-23.....	324
Plants of China (Walker):	
Plates 1-12.....	362
Natural rubber (Cook):	
Plates 1-20.....	412
Land use (Lowdermilk):	
Plates 1-4.....	428
Aboriginal South American culture (Cooper):	
Plates 1-4.....	462
Far Eastern civilizations (Bishop):	
Plates 1-12.....	512
Indonesia (Kennedy):	
Plates 1-12.....	522
Arab village community (Tannous):	
Plates 1-14.....	544
Chemotherapeutic agents (Weintraub):	
Plates 1-5.....	568



# THE SMITHSONIAN INSTITUTION

June 30, 1943

*Presiding Officer ex officio.*—FRANKLIN D. ROOSEVELT, President of the United States.

*Chancellor.*—HARLAN F. STONE, Chief Justice of the United States.

*Members of the Institution:*

FRANKLIN D. ROOSEVELT, President of the United States.

HENRY A. WALLACE, Vice President of the United States.

HARLAN F. STONE, Chief Justice of the United States.

CORDELL HULL, Secretary of State.

HENRY MORGENTHAU, Jr., Secretary of the Treasury.

HENRY L. STIMSON, Secretary of War.

FRANCIS BIDDLE, Attorney General.

FRANK C. WALKER, Postmaster General.

FRANK KNOX, Secretary of the Navy.

HAROLD L. ICKES, Secretary of the Interior.

CLAUDE R. WICKARD, Secretary of Agriculture.

JESSE H. JONES, Secretary of Commerce.

FRANCES PERKINS, Secretary of Labor.

*Regents of the Institution:*

HARLAN F. STONE, Chief Justice of the United States, Chancellor.

HENRY A. WALLACE, Vice President of the United States.

CHARLES L. McNARY, Member of the Senate.

ALBEN W. BARKLEY, Member of the Senate.

BENNETT CHAMP CLARK, Member of the Senate.

CLARENCE CANNON, Member of the House of Representatives.

FOSTER STEARNS, Member of the House of Representatives.

EDWARD E. COX, Member of the House of Representatives.

FREDERIC A. DELANO, citizen of Washington, D. C.

ROLAND S. MORRIS, citizen of Pennsylvania.

HARVEY N. DAVIS, citizen of New Jersey.

ARTHUR H. COMPTON, citizen of Illinois.

VANNEVAR BUSH, citizen of Washington, D. C.

FREDERIC C. WALCOTT, citizen of Connecticut.

*Executive Committee.*—FREDERIC A. DELANO, VANNEVAR BUSH, CLARENCE CANNON.

*Secretary.*—CHARLES G. ABBOT.

*Assistant Secretary.*—ALEXANDER WETMORE.

*Administrative assistant to the Secretary.*—HARRY W. DORSEY.

*Treasurer.*—NICHOLAS W. DORSEY.

*Chief, editorial division.*—WEBSTER P. TRUE.

*Librarian.*—LEILA F. CLARK.

*Personnel officer.*—HELEN A. OLMSTED.

*Property clerk.*—JAMES H. HILL.

## UNITED STATES NATIONAL MUSEUM

*Keeper ex officio.*—CHARLES G. ABBOT.

*Director.*—ALEXANDER WETMORE.

*Associate Director.*—JOHN E. GRAF.

## SCIENTIFIC STAFF

## DEPARTMENT OF ANTHROPOLOGY:

Frank M. Setzler, head curator; A. J. Andrews, chief preparator.

*Division of Ethnology*: H. W. Krieger, curator; Arthur P. Rice, collaborator

*Division of Archeology*: Neil M. Judd, curator; Waldo R. Wedel, associate curator; R. G. Palne, senior scientific aid; J. Townsend Russell, honorary assistant curator of Old World archeology.

*Division of Physical Anthropology*: T. Dale Stewart, curator; M. T. Newman, associate curator.\*

Collaborator in anthropology: George Grant MacCurdy. Associate in anthropology: Aleš Hrdlička.

## DEPARTMENT OF BIOLOGY:

Waldo L. Schmitt, head curator; W. L. Brown, chief taxidermist; Aime M. Awl, illustrator.

*Division of Mammals*: Remington Kellogg, curator; D. H. Johnson, associate curator; H. Harold Shamel, senior scientific aid; A. Brazier Howell, collaborator; Gerrit S. Miller, Jr., associate.

*Division of Birds*: Herbert Friedmann, curator; H. G. Deignan, associate curator; W. A. Weber, assistant curator; Alexander Wetmore, custodian of alcoholic and skeleton collections; Arthur C. Bent, collaborator.

*Division of Reptiles and Batrachians*: Doris M. Cochran, associate curator.

*Division of Fishes*: Leonard P. Schultz, curator; E. D. Reid, senior scientific aid.

*Division of Insects*: L. O. Howard, honorary curator; Edward A. Chapin, curator; R. E. Blackwelder, associate curator.

Section of Hymenoptera: S. A. Rohwer, custodian; W. M. Mann, assistant custodian; Robert A. Cushman, assistant custodian.

Section of Myriapoda: O. F. Cook, custodian.

Section of Diptera: Charles T. Greene, assistant custodian.

Section of Coleoptera: L. L. Buchanan, specialist for Casey collection.

Section of Lepidoptera: J. T. Barnes, collaborator.

Section of Forest Tree Beetles: A. D. Hopkins, custodian.

*Division of Marine Invertebrates*: Waldo L. Schmitt, curator; C. R. Shoemaker, associate curator; James O. Maloney, aid; Mrs. Harriet Richardson Searle, collaborator; Max M. Ellis, collaborator; J. Percy Moore, collaborator; Joseph A. Cushman, collaborator in Foraminifera.

*Division of Mollusks*: Paul Bartsch, curator; Harald A. Rehder, associate curator; Joseph P. E. Morrison, assistant curator.

Section of Helminthological Collections: Benjamin Schwartz, collaborator.

*Division of Echinoderms*: Austin H. Clark, curator.

*Division of Plants (National Herbarium)*: W. R. Maxon, curator; Ellsworth P. Killip, associate curator; Emery C. Leonard, assistant curator; Conrad V. Morton, assistant curator; Egbert H. Walker, assistant curator; John A. Stevenson, custodian of C. G. Lloyd mycological collection.

Section of Grasses: Agnes Chase, custodian.

Section of Cryptogamic Collections: O. F. Cook, assistant curator.

Section of Higher Algae: W. T. Swingle, custodian.

Section of Lower Fungi: D. G. Fairchild, custodian.

Section of Diatoms: Paul S. Conger, custodian.

\*Now on war duty.

## DEPARTMENT OF BIOLOGY.—Continued.

Associates in Zoology: Theodore S. Palmer, William B. Marshall, A. G. Böving, W. K. Fisher.

Associate in Botany: Henri Pittier.

Collaborator in Zoology: Robert Stelling Clark.

Collaborators in Biology: A. K. Fisher, David C. Graham.

## DEPARTMENT OF GEOLOGY:

R. S. Bassler, head curator; Jessie G. Beach, aid.

*Division of Mineralogy and Petrology*: W. F. Foshag, curator; E. P. Henderson, associate curator; B. O. Reberholt, senior scientific aid; Frank I. Hess, custodian of rare metals and rare earths.

*Division of Invertebrate Paleontology and Paleobotany*: Charles E. Resser, curator; Gustav A. Cooper, associate curator; Marion F. Willoughby, senior scientific aid.

Section of Invertebrate Paleontology: T. W. Stanton, custodian of Mesozoic collection; Paul Bartsch, curator of Cenozoic collection.

*Division of Vertebrate Paleontology*: Charles W. Gilmore, curator; C. Lewis Gazin, associate curator\*; Norman H. Boss, chief preparator.

Associates in Mineralogy: W. T. Schaller, S. H. Perry.

Associate in Paleontology: E. O. Ulrich, T. W. Vaughan.

Associate in Petrology: Whitman Cross.

## DEPARTMENT OF ENGINEERING AND INDUSTRIES:

Carl W. Mitman, head curator.

*Division of Engineering*: C. W. Mitman, head curator in charge; Frank A. Taylor, curator.\*

Section of Transportation and Civil Engineering: Frank A. Taylor, in charge.\*

Section of Aeronautics: Paul E. Garber, associate curator,\* F. C. Reed, acting associate curator.

Section of Mechanical Engineering: Frank A. Taylor, in charge.\*

Section of Electrical Engineering and Communications: Frank A. Taylor, in charge.\*

Section of Mining and Metallurgical Engineering: Carl W. Mitman, in charge.

Section of Physical Sciences and Measurement: Frank A. Taylor, in charge.\*

Section of Tools: Frank A. Taylor, in charge.\*

*Division of Crafts and Industries*: Frederick L. Lewton, curator; Elizabeth W. Rosson, senior scientific aid.

Section of Textiles: Frederick L. Lewton, in charge.

Section of Woods and Wood Technology: William N. Watkins, associate curator.

Section of Chemical Industries: Frederick L. Lewton, in charge.

Section of Agricultural Industries: Frederick L. Lewton, in charge.

*Division of Medicine and Public Health*: Charles Whitebread, associate curator.

*Division of Graphic Arts*: R. P. Tolman, curator.

Section of Photography: A. J. Olmsted, associate curator.

DIVISION OF HISTORY: T. T. Belote, curator; Charles Carey, assistant curator; Catherine L. Manning, philatelist.

\*Now on war duty.

## ADMINISTRATIVE STAFF

*Chief of correspondence and documents.*—H. S. BRYANT.  
*Assistant chief of correspondence and documents.*—L. E. COMMERFORD.  
*Superintendent of buildings and labor.*—R. H. TREMBLY.  
*Assistant superintendent of buildings and labor.*—CHARLES C. SINCLAIR.  
*Editor.*—PAUL H. OEHSE.  
*Accountant and auditor.*—N. W. DORSEY.  
*Photographer.*—A. J. OLMSTED.  
*Property clerk.*—LAWRENCE L. OLIVER.  
*Assistant librarian.*—ELISABETH H. GAZIN.

## NATIONAL GALLERY OF ART

*Trustees:*

THE CHIEF JUSTICE OF THE UNITED STATES, *Chairman.*  
 THE SECRETARY OF STATE.  
 THE SECRETARY OF THE TREASURY.  
 THE SECRETARY OF THE SMITHSONIAN INSTITUTION.  
 DAVID K. E. BRUCE.  
 FERDINAND LAMMOT BELIN.  
 DUNCAN PHILLIPS.  
 SAMUEL H. KRESS.  
 JOSEPH E. WIDENER.  
*President.*—DAVID K. E. BRUCE.  
*Vice President.*—FERDINAND LAMMOT BELIN.  
*Associate Vice President.*—CHESTER DALE.  
*Director.*—DAVID E. FINLEY.  
*Administrator.*—H. A. MCBRIDE.  
*Secretary-Treasurer and General Counsel.*—HUNTINGTON CAIRNS.  
*Chief Curator.*—JOHN WALKER.  
*Assistant Director.*—MACGILL JAMES.

## NATIONAL COLLECTION OF FINE ARTS

*Acting Director.*—RUEL P. TOLMAN.

## FREER GALLERY OF ART

*Director.*—A. G. WENLEY.  
*Assistant Director.*—GRACE DUNHAM GUEST.  
*Associate in research.*—J. A. POPE.  
*Superintendent.*—W. N. RAWLEY.

## BUREAU OF AMERICAN ETHNOLOGY

*Chief.*—MATTHEW W. STERLING.  
*Senior ethnologists.*—H. B. COLLINS, JR., JOHN P. HARRINGTON, JOHN R. SWANTON.  
*Senior archeologist.*—FRANK H. H. ROBERTS, JR.  
*Senior anthropologist.*—JULIAN H. STEWARD.  
*Associate anthropologist.*—W. N. FENTON.  
*Editor.*—M. HELEN PALMER.  
*Librarian.*—MIRIAM B. KETCHUM.  
*Illustrator.*—EDWIN G. CASSEDY.

## INTERNATIONAL EXCHANGE SERVICE

*Secretary (in charge).*—CHARLES G. ABBOT.

*Acting Chief Clerk.*—F. E. GASS.

## NATIONAL ZOOLOGICAL PARK

*Director.*—WILLIAM M. MANN.

*Assistant Director.*—ERNEST P. WALKER.

## ASTROPHYSICAL OBSERVATORY

*Director.*—CHARLES G. ABBOT.

**DIVISION OF ASTROPHYSICAL RESEARCH:** Loyal B. Aldrich, assistant director;  
William H. Hoover, senior astrophysicist.

**DIVISION OF RADIATION AND ORGANISMS:** Earl S. Johnston, assistant director;  
Edward D. McAlister, senior physicist; Leland B. Clark, engineer (precision instruments); Robert L. Weintraub, associate biochemist.





# REPORT OF THE SECRETARY OF THE SMITHSONIAN INSTITUTION

C. G. ABBOT

FOR THE YEAR ENDED JUNE 30, 1943

*To the Board of Regents of the Smithsonian Institution.*

GENTLEMEN: I have the honor to submit herewith my report showing the activities and condition of the Smithsonian Institution and the Government bureaus under its administrative charge during the fiscal year ended June 30, 1943. The first 12 pages contain a summary account of the affairs of the Institution; it will be noted that many activities usually included in this section are missing, wartime conditions having forced their suspension. Appendixes 1 to 10 give more detailed reports of the operations of the National Museum, the National Gallery of Art, the National Collection of Fine Arts, the Freer Gallery of Art, the Bureau of American Ethnology, the International Exchanges, the National Zoological Park, the Astrophysical Observatory, which now includes the divisions of astrophysical research and radiation and organisms, the Smithsonian library, and of the publications issued under the direction of the Institution. On page 89 is the financial report of the executive committee of the Board of Regents.

## THE SMITHSONIAN IN WARTIME

At the close of the fiscal year, 33 employees of the Institution had joined the armed forces and 5 had left to serve in special capacities in the various war agencies. Those leaving included 10 members of the scientific staff. Many of those remaining at the Institution devoted 100 percent of their time to war projects assigned by the Army, Navy, or war agencies, and all other staff members were occupied in varying degree with such projects, depending on the extent to which their special knowledge was in demand. In short, all personnel and facilities of the Institution and its branches were made available and were extensively used in the prosecution of the war.

The Institution's normal activities were kept alive to the extent of continuing observations the cessation of which would leave permanent gaps in records essential to future investigations, and of maintaining and caring for the National collections. All other research

and exploration projects not necessary for the orderly resumption of cultural activities after the war have been suspended for the duration with one exception, namely, those activities related to a closer cultural cooperation with the other American republics. Such cooperation is of vital importance not only for better relations between neighboring countries in the present time of emergency, but also as a permanent program after the war. The Institution is particularly well fitted to take part in such a program because of its many years of friendly contact with the scientists and scientific institutions of the other American republics.

Thus the wartime policy of the Institution has been to use all its resources to aid in winning the war, while continuing insofar as possible the recording and publishing of essential scientific observations and such curatorial work as is necessary for the proper care of the National collections.

The Smithsonian War Committee, appointed by me early in 1942, has continued to meet regularly with the aim of originating or considering plans to increase the Smithsonian's contributions to the war effort. The Committee has made many recommendations during the year, most of which I have approved and put into effect. Several war projects have also come to the Institution through my own contacts with Army and Navy officials or through contacts made by other Smithsonian staff members.

It seems desirable to present here, as a record of the Institution's part in the war, a brief statement of such of its wartime activities as can be made public. As regards the year's publications, most of which related to the war or to the other American republics, a statement will be found farther on in this report under the heading "Publications." It will be seen that much of the Institution's contribution is of an indirect nature, for the obvious reason that an organization can only undertake work for which its staff has the requisite training and experience. In total war, however, accurate knowledge of obscure peoples and places and other subjects chiefly of academic interest in normal times suddenly becomes of vital importance to the Army and Navy. In furnishing some of this information, urgently needed and often hard to get, lies the Institution's major contribution.

*Strategic information to war agencies.*—As stated, the Institution's greatest usefulness, as in the case of other similar organizations, derived from the specialized knowledge of its scientific staff, which provided the answers to innumerable urgent questions continually facing the Army, Navy, and war agencies. More than a thousand recorded inquiries had been answered up to the close of the fiscal year, and probably as many more for one reason or another were

not included in the record. The great majority of these were not simple questions that could be answered on the spot, but were of such a nature that considerable time was required to provide a complete answer. Many inquiries involved a series of conferences or the writing of extended illustrated reports. A list of selected examples tabulated by the War Committee shows not only the very wide range of these questions, but also the extent to which modern total war depends on scientific knowledge. The Institution was in a peculiarly favorable position to render this type of service because of its location in Washington, the headquarters also of the War and Navy Departments and most of the war agencies. It had the further advantage of being closely associated with the Ethnogeographic Board, discussed in the next paragraph.

*Ethnogeographic Board.*—Early in the fiscal year the Institution joined with the American Council of Learned Societies, the Social Science Research Council, and the National Research Council in sponsoring the Ethnogeographic Board, a nongovernmental agency whose function is to act as a clearinghouse between the above institutions and other scientific and educational organizations throughout the country, and the Army, Navy, and war agencies within the Government. The Director of the Board is Dr. William Duncan Strong, formerly of the Smithsonian Bureau of American Ethnology and at present on leave from Columbia University. The offices of the Board are in the Smithsonian building, a portion of its operating costs have been defrayed by the Institution, and three members of the scientific staff of the Bureau of American Ethnology have been detailed to assist the Director of the Board. The War and Navy Departments assigned liaison officers, and under the energetic leadership of Dr. Strong the Board has become the focal point for the finding of the best sources of strategic information in the fields of science within its scope.

*War research projects.*—A number of research and consultation projects have come to the Institution through the Ethnogeographic Board, the Smithsonian War Committee, and contacts of various officials of the Institution. As these were all of a strictly confidential character, nothing can be said about them except that they were concerned with many different branches of science, including anthropology, biology, geology, physics, and meteorology. These projects occupied practically the entire time of the instrument and mechanical shops of the Astrophysical Observatory, the division of radiation and organisms, and the division of engineering, as well as the time of numerous members of the scientific staff.

*Inter-American cooperation.*—For many years the Institution has been in close contact with scientists and cultural organizations in the

other American republics through its anthropological, zoological, and botanical explorations and field work in that area and through the wide exchange of its publications for those of scientific institutions of Mexico and South and Central America. Thus the Institution has been in an excellent position to undertake several major projects designed to improve cultural relations with our neighboring countries to the south. Under the direction of Dr. Julian H. Steward, of the Bureau of American Ethnology, a Handbook of the Indians of South America has been brought practically to completion and is expected to be published during the coming year as a Bulletin of the Bureau. This comprehensive publication, which will form four volumes of text and two of bibliography, is a truly cooperative undertaking, for 50 percent of the contributors are scientists in the other American republics. Also on the initiative of Dr. Steward, and with Dr. Ralph L. Beals as temporary director, an Inter-American Society of Geography and Anthropology has been organized, with membership open to scientists anywhere in the hemisphere. More than 700 members have already been enrolled from nearly all countries on both continents. A journal with articles in English, Spanish, and Portuguese will record the activities of the Society. The first part of a "Checklist of the Coleopterous Insects of Mexico, Central America, the West Indies, and South America," prepared under the direction of Dr. R. E. Blackwelder, is now in press as a Bulletin of the National Museum. A long-needed tool for entomologists, this check list will be used for years to come by scientists of the entire hemisphere. A number of Smithsonian scientists have visited other American republics during the year in the interest of closer professional collaboration.

*Other wartime activities.*—The new series of publications, Smithsonian War Background Studies, will be described in detail in another place. I will say here only that the series is filling a real need for authentic information on the less well-known peoples and regions involved in the war, and the demand for the books was so great that editions had to be increased progressively from 3,500 to 8,000 copies. In addition both the Army and Navy ordered editions of from 1,000 to 10,000 copies of several of the papers for the use of service personnel.

One of the first recommendations of the Smithsonian War Committee was for a roster of the technical and geographical knowledge of the Institution's staff. The roster has been at the service of the Ethnogeographic Board and has been of material aid in enabling the Army, Navy, and war agencies to locate quickly the specialist or the knowledge they needed.

Under the direction of the Smithsonian library, a file of illustrations of strategic areas appearing in Smithsonian publications and in the more obscure technical journals has been completed and made available to war agencies. A brief description of the resources of the Smith-

sonian library of nearly a million volumes has been distributed to key personnel.

For the benefit of members of the armed forces, the Museum buildings have been kept open all day Sunday. A set of six colored post cards showing striking Museum exhibits was given to servicemen entering the Arts and Industries building, where facilities for writing and mailing the cards were made available. More than 300,000 cards were given during the year. A small leaflet welcoming service men and women to the Institution was also made available; in it is described the part played by Army and Navy personnel in the past in building up the National collections. At the close of the year a collector's manual for members of the armed forces was in preparation, and a plan was being worked out to provide docents for Museum tours for service personnel.

#### SUMMARY OF THE YEAR'S ACTIVITIES OF THE BRANCHES OF THE INSTITUTION

*National Museum.*—Throughout the year members of the scientific staff have been occupied with furnishing technical information and carrying on research connected with the conduct of the war. The Museum buildings have been kept open all day Sundays for the benefit of service men and women. The Museum collections were increased by 230,231 specimens, bringing the total number of catalog entries to 17,808,471. Outstanding among the new accessions were the following: In anthropology, 1,443 specimens of pottery and figurine fragments from various localities in the United States and Mexico, a ceremonial mace of serpentine from Maré, Loyalty Islands, and weapons, armor, and musical instruments from the Philippines; in biology, a complete skeleton of the African bush elephant, birds from New Guinea and Eritrea, the latter a hitherto unrepresented locality, two large collections of fishes—one comprising more than 50,000 specimens transferred from the Fish and Wildlife Service, the other nearly 35,000 specimens collected in Venezuela by the curator of fishes, and the Frank C. Baker collection of mollusks, comprising 10,000 specimens, one of the important mollusk collections of North America; in geology, the John W. Langsdale collection of minerals, a 316-carat star sapphire and a 54-carat blue Brazilian topaz, five volumes containing 1,500 photomicrographs of the structure in meteoric irons, presented by Dr. Stuart H. Perry, associate in mineralogy, and a collection of 2,000 Triassic fossils from Nevada; in engineering and industries, an original truss of an iron railroad bridge built in America in 1845, two sets of aircraft identification models used by our armed forces, and a collection of specimens to be used as an exhibit of alternates and substitutes developed recently to cope with shortages of war materials; in history, the finest accession of firearms, swords, and daggers received

by the Museum in recent years, the gift of Ralph G. Packard. The few expeditions that were in the field during the year were concerned with matters connected with the conduct of the war or were the result of pre-war commitments. Because of travel difficulties, the number of visitors dropped to 1,355,269 as compared with slightly over 2,000,000 in the previous year. A definite count showed that servicemen averaged 25 to 35 percent of the total number of visitors. The Museum published its Annual Report, 3 Bulletins, 1 Contribution from the National Herbarium, and 25 Proceedings papers. Staff changes included the death of Dr. Leonhard Stejneger, head curator of the department of biology, and the appointment of Dr. Waldo L. Schmitt, curator of the division of marine invertebrates, to succeed him. Numerous members of the staff were furloughed for military and naval duty.

*National Gallery of Art.*—The total attendance at the Gallery for the year was 1,508,081, a daily average of 4,132 of whom more than one-fourth were service men and women. Special activities for members of the armed forces have included Sunday evening musical concerts, Sunday night suppers for servicemen, and the Servicemen's Room, which has furnished a place of relaxation for many men in the service. Among the outstanding acquisitions of the year were a collection of 23 paintings from Chester Dale; the Widener collection of paintings, sculpture, and other objects of art, one of the greatest donations ever made to any Museum; and the famous Rosenwald collection of prints, numbering over 6,500 items. A number of special exhibitions were held during the year, including an exhibition of Chilean contemporary art, the Thomas Jefferson Bicentennial exhibition, and an exhibition sponsored by Life magazine of 125 paintings by leading American artists, in cooperation with the War Department, in United States battle zones. There were printed during the year a check list of the Widener collection, a new general information pamphlet, a catalog, a portfolio of colored reproductions, and nine pamphlets dealing with the Gallery and its collections. The daily Gallery tours of the collection have been supplemented by tours for service men and women on Saturdays. A motion picture on the National Gallery of Art was completed in cooperation with the Office of Strategic Services; this will be widely circulated among educational institutions and the general public.

*National Collection of Fine Arts.*—Because of crowded conditions in Washington the annual meeting of the Smithsonian Art Commission was not held, and proffered gifts of works of art are being held by the National Collection of Fine Arts to be passed upon at the next meeting of the Commission. Two members of the Commission died during the year: John E. Lodge, chairman of the subcommittee on Oriental art, and Charles L. Borie, chairman of the Commission

since 1935. Fourteen miniatures were acquired through the Catherine Walden Myer fund. Five paintings were purchased under the Henry Ward Ranger bequest; by the terms of the bequest these are assigned to various art institutions and under certain conditions are prospective additions to the National Collection of Fine Arts. Seven special exhibitions were held, as follows: Oil paintings, water colors, and pastels by Señorita Carmen Madrigal Nieto, of Costa Rica; oil paintings by Señorita Pachita Crespi, of Costa Rica; oil paintings by Frank C. Kirk, of New York; miniatures by members of the Pennsylvania Society of Miniature Painters; oil paintings and designs by Simon Lissim, of New York; water colors by Leonora Quarterman, of Savannah, Ga.; oil paintings by Walter King Stone, of Ithaca, N. Y.

*Freer Gallery of Art.*—Additions to the collections included Chinese bronze, Persian gold, Persian and Indian paintings, Chinese porcelain, and Chinese and Persian pottery. Besides the regular curatorial work, the staff devoted much of its time to supplying information to war agencies and to translating matter from Chinese and Japanese sources, amounting to hundreds of typewritten pages. In addition, Chinese and Japanese names on maps of war areas were identified and transliterated to the number of more than 5,000. The Director gave a series of lectures to Washington school teachers on Chinese culture as reflected in the fine arts in furtherance of a plan to disseminate knowledge of China in the public schools. Visitors to the gallery numbered 53,769 for the year, and 12 groups were given docent service or instruction in the study room. John Ellerton Lodge, Director of the Freer Gallery from its beginning in 1920, died on December 29, 1942. Under Mr. Lodge's wise administration was developed the work of the Gallery in the study and the acquisition of Oriental fine arts. He was succeeded as Director by Archibald G. Wenley, associate in research at the Gallery.

*Bureau of American Ethnology.*—Activities concerned with the other American republics have been emphasized during the year, and a large part of the time of the staff has been devoted to war projects. Several members have worked nearly full time in cooperation with the Ethnogeographic Board in preparing strategic information for the Army, Navy, and war agencies. M. W. Stirling, Chief, directed the fifth National Geographic-Smithsonian archeological expedition to southern Mexico. Excavations at the site of La Venta in southern Tabasco resulted in the discovery of construction details of the stone-fenced enclosure, one of the central features of the site. Three rich burials contained jade offerings of high quality. Dr. J. R. Swanton completed the proofreading of his 850-page bulletin entitled "The Indians of the Southeastern United States," and did further work on the now extinct language of the Timucua Indians of Florida.

Dr. J. P. Harrington investigated the Chilcotin languages of northern California, and later in the year devoted his time to the preparation of material for the linguistic section of the Handbook of South American Indians. Dr. F. H. H. Roberts, Jr., investigated a site in eastern Wyoming from which more than 70 projectile points of the Yuma type were recovered. Dr. Roberts devoted the last two-thirds of the year to the preparation of a series of "survival" articles from data furnished by members of the Smithsonian staff. These articles were made available to the armed forces through the Ethnogeographic Board. Dr. J. H. Steward continued his work as editor of the Handbook of South American Indians, assisted by Dr. Alfred Métraux of the Bureau staff. The Handbook, which will consist of four volumes of text and two of bibliography, was three-fourths completed at the close of the year. Dr. H. B. Collins, Jr., was engaged in furnishing regional and other information to the armed services, mostly in connection with the Ethnogeographic Board. Dr. W. N. Fenton devoted most of his time to projects received by the Ethnogeographic Board from the armed services, and continued to serve as a member of the Smithsonian War Committee. Miss Frances Densmore completed two large manuscripts on Indian music. The Bureau published its Annual Report and three Bulletins. The Bureau library has been much in use as a source of material for the Ethnogeographic Board and the war agencies.

*International Exchanges.*—The International Exchange Service is the official United States agency for the interchange of governmental and scientific publications between this country and all other countries of the world. During the year the Service handled a total of 513,460 packages of publications with a total weight of 248,648 pounds. Although the war prevents shipments to many foreign countries, nevertheless consignments went forward during the year to all countries in the Western Hemisphere and to a number in the Eastern Hemisphere, namely, Great Britain and Northern Ireland, Republic of Ireland, Portugal, the U.S.S.R., Union of South Africa, India, Australia, and New Zealand. Packages which cannot be forwarded during the war are held for later delivery. Because of the limited space at the Institution, arrangements were made to store the large accumulation of such material at the Library of Congress. In April 1942 the Office of Censorship placed a ban on the sending abroad of the Congressional Record and the Federal Register; in February 1943 this ban was lifted, and the Record and Register were again forwarded to those countries that could be reached.

*National Zoological Park.*—By reducing maintenance work to the absolute minimum, it has been possible to carry on the primary function of the Zoo, the exhibition of a wide variety of animal life in the



best possible condition, in spite of the increasing shortages of manpower, food, and materials. The functioning of the Zoo is thought to be particularly important in wartime because it provides free recreation and enjoyment for thousands of war workers and members of the armed forces. Although automobile traffic to the Zoo practically ceased, nevertheless a greatly increased number of visitors walked or came by bus or streetcar. The total number of visitors for the year was 1,974,500. Officials of the Zoo have furnished much information regarding animals to the War and Navy Departments, other Government agencies, and medical groups. Conditions have precluded expeditions by the Zoo for the collection of animals, and few animals are offered for sale by dealers. New specimens, therefore, have come mainly through gift and exchange. In addition, 101 mammals were born and 83 birds hatched at the Zoo during the year. Despite adverse conditions, six species never before in the collection were obtained; these included a specimen of the rarely exhibited spectacled bear of the northern Andes and a white starling from Java, also rare in captivity. At the close of the year the collection contained 2,435 animals representing 684 species and subspecies.

*Astrophysical Observatory.*—A prediction of the march of solar variation from 1939 through 1945, based on periodicities revealed by the solar-constant values published in volume 6 of the *Annals of the Observatory*, shows that the years 1940 to 1947 will be the most important years to study the sun's variation since the early twenties. For this reason, every effort has been made to keep the three field observatories in Chile, California, and New Mexico in operation. Up to the close of the year, these efforts had been successful. Further studies of the short-interval changes of solar radiation in their relation to weather have been even more convincing than previous results. The weather effects of individual solar changes are found to last at least 2 weeks. Most of the time of the staff at Washington has been devoted to war-research problems assigned by the war services. In the division of radiation and organisms, the regular research program was discontinued in August 1942, and since then practically the entire time of the staff has been directed toward solving war problems.

#### THE ESTABLISHMENT

The Smithsonian Institution was created by act of Congress in 1846, according to the terms of the will of James Smithson, of England, who in 1826 bequeathed his property to the United States of America "to found at Washington, under the name of the Smithsonian Institution, an establishment for the increase and diffusion of knowledge among men." In receiving the property and accepting the trust, Congress determined that the Federal Government was

without authority to administer the trust directly, and, therefore, constituted an "establishment" whose statutory members are "the President, the Vice President, the Chief Justice, and the heads of the executive departments."

#### THE BOARD OF REGENTS

Changes in the Board of Regents during the fiscal year were as follows:

Senator Charles L. McNary, of Oregon, having been reelected to the Senate for the term beginning January 3, 1943, was reappointed by the Vice President on February 4, 1943, as a regent to succeed himself.

On October 26, 1942, the Honorable William P. Cole, Jr., of Maryland, resigned from the House of Representatives, which automatically terminated his term as a regent; on January 12, 1943, the Speaker appointed Representative Edward E. Cox, of Georgia, to succeed him.

The term of Dr. Roland S. Morris, of Pennsylvania, as a citizen regent, expired February 20, 1942. By Joint Resolution of Congress approved July 28, 1942, he was reappointed to succeed himself for the statutory term of 6 years.

The roll of regents at the close of the fiscal year was as follows: Harlan F. Stone, Chief Justice of the United States, Chancellor; Henry A. Wallace, Vice President of the United States; members from the Senate—Charles L. McNary, Alben W. Barkley, Bennett Champ Clark; members from the House of Representatives—Clarence Cannon, Foster Stearns, Edward E. Cox; citizen members—Frederic A. Delano, Washington, D. C.; Roland S. Morris, Pennsylvania; Harvey N. Davis, New Jersey; Arthur H. Compton, Illinois; Vannevar Bush, Washington, D. C.; and Frederic C. Walcott, Connecticut.

*Proceedings.*—The annual meeting of the Board of Regents was held on January 15, 1943. The regents present were Chief Justice Harlan F. Stone, Chancellor; Vice President Henry A. Wallace; Representatives Clarence Cannon, Foster Stearns, and Edward E. Cox; citizen regents Frederic A. Delano, Roland S. Morris, Harvey N. Davis, Arthur H. Compton, and Vannevar Bush; and the Secretary, Dr. Charles G. Abbot.

The Secretary presented his annual report covering the year's activities of the parent Institution and of the several Government branches, which was accepted by the Board, as was also the report by Mr. Delano, of the executive committee, covering financial statistics of the Institution. The Secretary stated that owing to the exigencies of wartime travel, there had been no meeting of the Smithsonian Art Commission during the year.

In his special report the Secretary outlined some of the more important recent activities carried on by the Institution and the branches, with special emphasis on phases of the work directly connected with the war.

#### FINANCES

A statement on finances will be found in the report of the executive committee of the Board of Regents, page 89.

#### PUBLICATIONS

In normal times the Institution publishes the results of researches by members of its scientific staff in several series, namely, the Smithsonian Miscellaneous Collections, the Bulletins and Proceedings of the National Museum, Contributions from the National Herbarium, the Bulletins of the Bureau of American Ethnology, and the Annals of the Astrophysical Observatory. It also publishes the Annual Reports of the Board of Regents, which contain a selection of articles summarizing developments in all branches of science, and other occasional publications. In wartime, however, publication has been restricted largely to material that relates to the war or is of value in strengthening cultural relations with the American nations to the south of us. Otherwise only such papers were sent to the printer during the year as seemed for one reason or another to be of sufficient importance to the advancement of science to warrant publication even in wartime. This wartime policy will not be apparent from the titles listed in this year's report on publications, however, because a large proportion of the papers issued went to the printer in the previous fiscal year before the policy went into effect.

The new series, Smithsonian War Background Studies, begun in the summer of 1942, was planned for the purpose of making available authentic information on the less well-known areas and peoples involved in the war. Twelve numbers had been issued at the close of the fiscal year, and four others were in press. As the Far East and the Pacific islands are probably the least well-known of the war areas, the majority of the papers deal with those regions. A complete list of the papers issued and in press will be found in the report on publications, appendix 10. The demand for papers in the series was immediate and much larger than had been anticipated. The editions of the first few papers had been set at 3,500 copies, nearly twice as large as the usual editions of Smithsonian papers, but these were soon exhausted. Reprints of these were issued, and editions of later papers were successively increased until at the end of the year 8,000 copies were being printed. The demand, as might be expected, was greatest from Army and Navy organizations and personnel and from universities and schools. In addition to the

Smithsonian editions, the Army and Navy ordered from 1,000 to 10,000 copies of nearly all the papers in the series.

Aside from the War Background Studies, there was a constant demand from Army, Navy, and war agencies for other Smithsonian publications, notably the Smithsonian Meteorological Tables, Smithsonian Physical Tables, and World Weather Records. Of the Meteorological Tables, 5,557 copies were asked for by various Army units, most of them going to the Signal Corps.

Among the outstanding publications of the year not related to the war may be mentioned "Compendium and Description of the West Indies," by Antonio Vázquez de Espinosa, translated by Charles Upson Clark, a detailed itinerary of Spanish America written by a Carmelite missionary in 1628 or 1629; "Fishes of the Phoenix and Samoan Islands Collected in 1939, during the Expedition of the U. S. S. *Bushnell*," by Leonard P. Schultz, curator of the division of fishes in the National Museum, who accompanied the expedition; and "The Native Tribes of Eastern Bolivia and Western Matto Grosso," by Alfred Métraux.

A total of 88 publications were issued during the year, and 194,057 copies of these and other Smithsonian publications were distributed.

#### LIBRARY

The use of the Smithsonian library during the year by the scientific staff of the Institution was almost entirely in connection with the war, and more than 35 war agencies have made inquiries, borrowed books, and sent research workers to use the collections. The branch libraries of the National Museum and the Bureau of American Ethnology especially have been constantly used by war workers because of their extensive resources of geographical and ethnological material. Receipt of foreign publications again dropped somewhat but not so sharply as during the preceding year. The quantity and quality of scientific publications is still maintained at a high level among our allies abroad. The publication and receipt of domestic scientific serials continues to be practically normal. Among the outstanding gifts of the year were a microfilmed set of the records of Linnean collections and manuscripts of the Linnean Society of London, and a collection of 350 books from Ralph G. Packard to accompany the collection of arms and armor given by him to the Museum. The record of the year's activities includes 6,955 accessions, bringing the total holdings of the library to 907,645; 159 new exchanges arranged; 3,631 "wants" received; 5,012 volumes and pamphlets cataloged; 11,236 books and periodicals loaned; and 2,135 volumes sent to the bindery.

Respectfully submitted.

C. G. ABBOT, *Secretary*.

## APPENDIX 1

### REPORT ON THE UNITED STATES NATIONAL MUSEUM

SIR: I have the honor to submit the following report on the condition and operation of the United States National Museum for the fiscal year ended June 30, 1943:

Appropriations for the maintenance and operation of the National Museum for the year totaled \$892,630, which was \$61,652 more than for the previous year.

#### THE MUSEUM IN WARTIME

Although there has been a decrease in the total number of visitors to the Museum below that normal for times of peace, the number recorded, 1,355,269, indicates the great interest that exists in the exhibits. The change in hours to allow the public halls to be open all day Sunday has permitted many people to visit the buildings whose time schedules would not have otherwise made such visits possible. This is particularly true of service men and women, about 2,000 of whom have been included among the visitors each week end.

Last year's report indicated steps taken for adequate safeguard of collections. These precautions have gone forward, and a program of training has been initiated among groups of employees for the protection of visitors, employees, and the various buildings. Air-raid alarm systems have been installed, fire-fighting, air-raid, and first-aid equipment procured, air-raid shelters designated, and complete black-out facilities where necessary established. Practice air-raid drills were held, both in cooperation with the District of Columbia and independently of the city-wide drills.

Throughout the year members of the staff have been occupied with considerable work connected with the conduct of the war, either through direct contact with various war agencies or through the Ethnogeographic Board. This has included "spot" information in various fields, research, and experiment. The variety of these subjects is indicated by the following enumeration of some of the items on which data were requested: Camouflage plants; natural vegetation of specific regions; illustrations of poisonous plants and of emergency food plants and data regarding them; destruction of mosquito-harboring epiphytes; distribution of certain plants of known economic

importance; botanical exploration; the palatability of the flesh of land, fresh-water, and marine animals, their use for food, and methods of capture; the serviceability of hides and skins for various purposes; disease transmission; noxious, poisonous, or otherwise dangerous animals; intermediate hosts of animal and human parasites; aid in the preparation of survival manuals and other military and naval handbooks; distributional lists of insects and other animals of medical importance; outlines for insect surveys in foreign areas; instruction in mosquito identification; collection and preservation of specimens, especially those of medical importance; supplying duplicate sets of insect material not otherwise readily obtainable for the use of Army and Navy medical schools; biological and oceanographic problems; marine fouling organisms; bibliographic surveys; recommendations regarding personnel.

Assistance has been given in the identification of tribal culture patterns chiefly of the island peoples of the West Pacific area and of continental southeastern Asia. Other information provided, in this instance obtained from Museum photographic files, related to the need of our aviators and soldiers to recognize religious caste markings, and, to assist in the orientation of aviators, the types of house construction in various parts of southern Asia. A mass of information directly based on the collections was given to such agencies as the Board of Economic Warfare and the War Production Board, bearing directly on the development of the use of substitute materials for civilian use. Various articles describing the more remote peoples and their cultures were prepared and published.

#### COLLECTIONS

The Museum collections were increased by 230,231 specimens, which were included in 1,177 separate accessions. Because of wartime conditions a decrease of 211 accessions, 54,351 specimens, in comparison with the number received during the previous year was not unexpected. The five departments registered specimens received as follows: Anthropology, 2,514; biology, 213,823; geology, 9,725; engineering and industries, 2,266; and history, 1,902. Most of the accessions were acquired as gifts from individuals or as a transfer of specimens by Government departments. The complete report on the Museum, published as a separate document, includes a detailed list of accessions, but the more important are summarized below. Catalog entries in all departments now total 17,808,471.

*Anthropology.*—Transferred to the division of archeology by Government departments were 1,443 specimens of earthenware vessels, potsherds, and figurine fragments from several localities in Mexico

and the United States. Important gifts from individuals included 24 earthenware vessels, clay heads, and projectile points from Mexico; 2 wooden figurines excavated in Florida; and 1 obsidian mirror from a stream bed in Ecuador. Outstanding among the specimens donated to the division of ethnology was a ceremonial mace of serpentine from the Island of Maré. This specimen is an excellent example of the ceremonial weapons described in French scientific literature on New Caledonia and the Loyalty Islands. Other ethnological objects of special interest are weapons, pieces of armor, inscriptions on bamboo, and musical instruments from the Philippine Islands, and fishing paraphernalia, tools, utensils, dance masks, a feathered dance headdress, and hand-woven costumes from various South and Central American localities. The collection of ceramics was augmented by porcelain articles from Capo di Monte molds, dating to about 1821, and examples of painted terra cotta made presumably by Greek colonists at Apulia, Italy, during the fourth century B. C., and excavated at Pompeii. Interesting examples of American glass included "Burmese" and "Peachblow" articles manufactured in Massachusetts and "Case" glass from West Virginia. Among the various collections assigned to the section of period art and textiles were antique jewelry from Scotland, Hungary, Portugal, France, Egypt, China, Ceylon, and the Philippine Islands; Spanish, French, and Chinese antique ornamental fans; and a handsomely ornamented snuffbox bearing the registry mark of Bergen, Norway, presented by Mrs. Stejneger at the expressed wish of the late Dr. Leonhard Stejneger, for many years head curator of the department of biology. Notable gifts to the division of physical anthropology included Indian skeletal remains from two ossuaries on a farm in Prince Georges County, Md., completing a collection from this locality begun in former years, and a midget's skull of 485 cc. capacity, the smallest human adult skull thus far reported.

*Biology.*—The first complete skeleton of the African bush elephant (*Loxodonta cylotis*) to come to the national collections and four small rodents collected in the endemic plague area in Boliva were the most noteworthy accessions in the division of mammals.

Particularly welcome among the birds accessioned during the year were several forms new to the collection: Representatives of the pheasant genus *Anurophasis* and the shrike genus *Eulacestoma* from New Guinea; 2 specimens of the black-lored grass warbler (*Cisticola nigrilora*); 65 species of Ecuadorian birds; the type of the warbler *Prinia flaviventris delacouri*; and 8 avian specimens from Eritrea, a hitherto unrepresented locality. Another interesting accession included birds from the widely scattered collections of the United States Exploring Expedition of 1838-42.

Two rare forms of West Indian snakes were added to the collection of reptiles and amphibians—*Darlingtonia haetiana*, from Haiti, and *Typhlops richardii*, from St. Thomas.

Two large collections of fishes were received, one by transfer from the Fish and Wildlife Service, comprising more than 50,000 specimens, and one of nearly 35,000 specimens brought from Venezuela by the curator of fishes. Rare forms accessioned include *Ochmacanthus reinhardti* and *Urinophilus erythrurus* from South America. To the type series were added cotypes of *Cynopotamus biserialis* and paratypes of *Notolepidomyzon intermedius*.

A large accession, comprising 4,300 miscellaneous insects, the balance of the private collection of the late George P. Engelhardt, was received by the division of insects, accompanied by Mr. Engelhardt's extensive and valuable entomological library. As in former years, the Bureau of Entomology and Plant Quarantine and its Division of Foreign Plant Quarantines, of the United States Department of Agriculture, transferred to the Museum collection a large number of insects, this year the total being approximately 46,000 specimens. Six specimens of *Cycloscosmia truncata*, the third known occurrence of this trap-door spider since it was discovered a century ago, came as a gift.

To the type collection of marine invertebrates were added the cotype of *Derocheilocaris typicus*, upon which a new genus, new family, and new order of crustaceans were based, and numerous allotypes, holotypes, and paratypes of crayfishes, worms, ostracods, and amphibians. A collection of approximately 700 specimens of miscellaneous invertebrates from the Gulf of Mexico was received by transfer.

One of the important mollusk collections of North America, comprising approximately 10,000 specimens, was bequeathed to the Museum by Dr. Frank C. Baker, together with 17 bound volumes of his own published writings. Of special interest was a donation of 1,500 shells, 50 corals, and a collection of echinoderms from New Caledonia, the first material of consequence received in many years from this now important part of the world.

Twelve of the seventeen accessions to the collection of helminths contained type material: Types of *Opecoelina pharynmagna*, *Protostrongylus agerteri*, *P. frosti*, *Protogynella blarinae*, and *Diorchis reynoldsi*; cotypes of *Parallintoshius tadaridae* and *Euparyphium ochoterenai*; paratypes, holotypes, and allotypes of *Halocercus kirbyi*, *Corymosoma obtuscens*, and species of *Acanthocephala*; slides bearing cotype specimens of *Hymenolepis parvisaccata*; and additional slides representing four new species.

Several large collections of plants, mostly from Mexico, Central America, and South America, were received as gifts or in exchange.



Eight of these collections comprised more than 1,000 specimens each.

*Geology.*—Ten accessions pertaining to minerals—a 1,842-gram individual of the Harrisonville, Mo., meteorite, and nine slices of meteorites—were added by purchase through the income from the Roebing fund. The largest single accession of minerals was the gift of the John W. Langsdale collection, including many good examples from old American and European localities. The outstanding addition to the gem collection was the 316-carat star sapphire known as Star of Artaban. This beautiful stone ranks with the finest of the Museum's individual gems. Another notable gem stone was a 54-carat blue Brazilian topaz obtained through the Frances Lea Chamberlain fund. Dr. Stuart H. Perry, associate in mineralogy, presented an album of five volumes containing approximately 1,500 photomicrographs of the structure in meteoric irons, which, with the negatives received from Dr. Perry last year, has resulted in the most complete file of the metallurgy of meteoric irons in existence. Dr. Perry also donated a 4,640-gram specimen of the Modoc, Kans., meteorite.

The most important additions to the collections of invertebrate paleontology and paleobotany were the Devonian invertebrates collected in the Mississippi Valley States by Prof. A. S. Warthin, Jr., and Dr. G. A. Cooper. In return for assistance by Dr. C. E. Resser, Dr. Franco Rasetti, of Laval University, presented a splendid set of fossils and casts of types from the classic locality at Levis, opposite Quebec City, Canada. The income from the Springer fund provided 12 Devonian crinoids from Ontario, one of the most important accessions of the year to the collection of fossil echinoderms. A collection of about 2,000 Triassic fossils from Nevada will undoubtedly include many types when the study of these fossils has been completed. Among the accessions recorded in the section of Cenozoic invertebrates were topotypes of the foraminifer *Pseudophragmina* (*Porporocyclina*) *peruviana* and holotype and paratypes of the foraminifer *Paranonion venezuelanum*.

In the division of vertebrate paleontology a large series of specimens from the Oligocene beds of Niobrara County, Wyo., was accessioned. Specimens worthy of special mention are nearly complete articulate skeletons of various mammals known as *Merycoidodon*, *Leptomeryx*, *Pseudocynodontis*, *Deinictis*, and *Hoplophoneus*. Good series of skulls and partial skeletons of the fossil horse *Mesohippus*, the small camel *Poebrotherium*, the early rhinoceros *Hyracodon*, the squirrel *Ischromys*, and the rabbit *Palaeolagus* were included. Also added to the collection by exchange were the nearly complete skeleton of the primitive deer *Hypertragulus calcaratus* Cope, to be mounted for the exhibition series; a skull and lower jaws of the Miocene horse *Parahippus leonensis* and a right ramus of *P. blackbergi*; the type of

a fossil bird *Geochen rhuax* Wetmore; and 297 teeth of the pavement-toothed shark *Ptychodus mortoni*.

*Engineering and industries.*—From the viewpoint of engineering history, the most interesting and valuable accession was an original truss of an iron railroad bridge designed, constructed, and erected by the Reading Railroad Co. in 1845. The specimen, approximately 34 feet long, is the only remaining part of the first iron-truss, double-track railroad bridge built in America, also believed to be the first iron-truss bridge erected in the United States.

Early in the present war there was instituted as part of the training program of our armed forces the use of accurately made scale models of the types of airplanes used by the United Nations and the Axis, to teach recognition at sight of both friend and enemy. Lt. Paul E. Garber, U. S. Navy, on military furlough from the Museum, was actively engaged in the development of this program, and through him the Museum received two groups of these models. Bequeathed to the extensive propeller collection by the inventor, Dr. S. Albert Reed, was a full-sized model, known as the D-1, of an aluminum-alloy propeller that is now recognized as one of the early successful types. Another accession of historical interest, likewise presented by the inventor, H. H. Franklin, was comprised of four die castings, which are excellent examples of early attempts to produce finished castings in metal dies. Of current interest is the accession of a scale model of a plant used for producing high-grade motor fuel for aviation gasoline blending stock. An exhibit of timely educational value in the section of mineral technology is one of abrasives and grinding-machine operations. This exhibit, which has been studied frequently by the personnel of Government war agencies, has been modernized during the year, and 178 specimens were added.

In the division of crafts and industries there were received several specimens of special interest because of their bearing on the war: A new surgical stitching instrument operated as a sewing-machine attachment, together with a felt sampler showing numerous types of surgical suturing; a sample of cap ribbon of a new type adopted by the United States Navy, in which letters in gold leaf are fused into a cut ribbon of acetate rayon, instead of the silk ribbon embroidered with gold thread formerly used; specimens of nylon and cotton woven webbing used for the harness connecting the aviator to his parachute; and new specimens to be used as an exhibit of alternates and substitutes developed recently to cope with shortages of war materials. Of special interest in the public-health collections was the addition of a collection of food models arranged to show the daily food requirement. Important additions to the wood collection were 13 samples of tropical American woods that had been received by the Bureau of

Ships, Navy Department, for testing in some phase of their wartime shipbuilding program.

In the division of graphic arts a large collection of war posters constitutes a valuable addition to the pictorial and historical record of our participation in the war. Many were designed by outstanding American artists, a fact that enhances their purely historical value.

The most important accession received by the section of photography was a Woodward Solar Camera. No other example is known to exist, and it came to light largely as a result of the Nation-wide drive for scrap metal. This type of camera was manufactured under patents dated between 1857 and 1877, and it was the first means available to commercial photographers during the latter half of the nineteenth century for making photographic enlargements on the then slow bromide paper, using the sun as a source of illumination.

*History.*—The three most important accessions of the year in the division of history were in the fields of art, arms, and numismatics. The first of these, received by bequest, consisted of five paintings of unusual interest not only because of their artistic and historical value but also because they complete the collection of paintings on historical subjects by J. L. G. Ferris, 71 of which were presented by Mrs. Ferris in 1932, after the death of her husband. The finest accession of firearms, swords, and daggers received by the National Museum in recent years came as a gift from Ralph G. Packard. The collection illustrates the evolution of firearms from the matchlock to the automatic of the present day and includes all the methods of ignition used during the past 350 years. The accession of most importance to the numismatic section was the large collection of coins, medals, medalets, and tokens presented by the Hon. Frederic A. Delano, a regent of the Smithsonian Institution.

Additions to the stamp collection of unusual interest were stamps of Great Britain overprinted "M. E. F." (Middle East Force) for use in the former Italian territory of Eritrea, and stamps issued by the Norwegian Government in London (used on letters carried by Norwegian warships and merchant vessels), and by the exiled Yugoslavian Government in England.

#### EXPLORATIONS AND FIELD WORK

Field explorations for the year were concerned in the main with matters connected with the conduct of the war or with commitments dating back to the pre-war period. With the usual program curtailed, the scope of the investigations has been changed, though valuable results in a variety of directions have been achieved.

*Anthropology.*—Dr. Waldo R. Wedel, associate curator, division of archeology, was detailed to the Bureau of American Ethnology

from January 16, 1943, to June 1, 1943, in order to assist M. W. Stirling, Chief of the Bureau, in archeological excavations near La Venta, in the State of Tabasco, Mexico. These excavations, constituting an important program of research among the Pan American republics, were sponsored jointly by the Smithsonian Institution and the National Geographic Society.

*Biology.*—In pursuance of the program for the furtherance of cultural relations with scientists in the other American republics in cooperation with the Department of State, three members of the department of biology—Dr. Remington Kellogg, curator of mammals, Ellsworth P. Killip, associate curator of plants, and Dr. Waldo L. Schmitt, curator of marine invertebrates—visited South America for periods of approximately 3 months each.

Dr. Kellogg left Washington on March 2 for Rio de Janeiro, Brazil, and returned May 15, 1943. He spent most of his time working in collaboration with members of the staff at the Museu Nacional at Rio de Janeiro, with additional contacts at the Departamento de Zoologia at São Paulo and the Museu Goeldi at Belém. The work of field stations and laboratories engaged in the study and control of tropical diseases was observed, particular attention being given to research work involving Brazilian mammals suspected of being, or known to be, the hosts of vectors of transmissible diseases. Through the friendly cooperation of the Fundação Rockefeller, Dr. Kellogg was enabled to spend a week at its yellow-fever field station near Therezopolis in the Serra das Orgãos.

Mr. Killip was occupied during March, April, and most of May in Venezuela. Part of the time was given to field work and part to work with Dr. Henri Pittier, director of the Servicio Botánico, and his associates, in the identification of large collections recently made in little-known parts of the Republic. Short collecting trips were made to Santa Lucía in the State of Miranda, Rancho Grande in the Parque Nacional, Barquisimeto in the State of Lara, and El Junquito in the mountains near Caracas. At the invitation of O. E. Nelson, in charge of the Venezuelan office of the Rubber Reserve Corporation, Mr. Killip accompanied a rubber-investigation party to the Río Paragua, a river rising in the Pacaraima Mountains. Most of the plant collecting was done between the town of La Paragua and the Cerro Guaiquinima, a region that had never before been explored botanically.

Dr. Schmitt left Miami, Fla., on April 13 for Brazil, Uruguay, and Argentina, and returned to Washington on June 30, 1943. He consulted with members of the staffs of various scientific institutions and spent some time examining collections, particularly of fresh-water crustaceans, some of which have considerable economic importance. In Brazil he visited the Museu Nacional in Rio de Janeiro, the Univer-

sity of São Paulo and the Departamento de Zoologia at São Paulo, and the Museu Paranaense in Curityba. In Uruguay he studied at the Museo Nacional, the Museo Instituto Geológico del Uruguay, the Museo de Pedagógico and the Museo de Enseñaza Secundaria de Universidad, all in Montevideo, and the museum of the Liceo in Paysandú. In Argentina he examined collections and visited the staff of the Museo Argentino de Ciencias Naturales and the University at Buenos Aires, the La Plata Museum at La Plata, the Museo Cornelio Moyano and the Universidad de Cuyo, both at Mendoza, the Universidad de Córdoba at Córdoba, and the Universidad de Tucumán at Tucumán. The director and staff members of the laboratories of the Dirección Regional de Paludismo assisted him on numerous occasions throughout northern Argentina, particularly in Tucumán, Salta, and Jujuy. His field work, accomplished when time and other obligations permitted, included studies in Brazil at Alto da Serra, São Paulo, and at several localities in the vicinity of Curityba, Paraná, in Uruguay at Paso de los Toros, Salto, and Paysandú, and in Argentina at Mendoza, Tucumán, Salta, San Lorenzo, and Quijano.

Philip Hershkovitz, who before the outbreak of the war had started his investigations on the mammalian fauna of the northeastern part of Colombia under the Walter Rathbone Bacon Traveling Scholarship, between June 30, 1942, and April 16, 1943, worked mainly in the Department of Magdalena, Colombia. More recently Mr. Hershkovitz has moved camp to the Department of Bolívar.

M. A. Carriker, Jr., under the W. L. Abbott fund of the Smithsonian Institution, continued work on the Colombian avifauna in northeastern Colombia, and Walter A. Weber, also traveling under the Abbott fund, accompanied the archeological expedition sponsored jointly by the Smithsonian Institution and the National Geographic Society to Tabasco, Mexico, during which expedition he obtained about 600 specimens of birds for the Museum collections. Mr. Weber also visited the Instituto de Biología at Mexico City.

*Geology.*—While field work for upbuilding the exhibits has been curtailed, researches in general geology were increased. Late in July Prof. A. S. Warthin, Jr., and Dr. G. A. Cooper left for a survey of Devonian rocks in Illinois and adjacent States. The purpose of the trip was to correlate isolated areas of Devonian exposures in Illinois with the better-known sequences in Missouri and Iowa, and for the first time such correlations were established in that promising area for new oil fields. After the return of Dr. Warthin, Dr. Cooper went to southeastern Missouri to report on a deposit from which several bones of a dinosaur had been taken.

Later in the year, under the cooperative work between the Department of State and the Smithsonian Institution, and as the result of a

special request by Ing. Luis Flores C., of the Instituto Geológico de México in Mexico City, Dr. Cooper was detailed to make an economic survey in Mexico. This field work, which was in connection with search for war minerals, resulted in the discovery of a long sequence of Cambrian rocks associated with ore deposits.

Dr. W. F. Foshag, on detail from the Museum, spent the entire year in continuation of his work in Mexico supervising surveys for strategic minerals for the United States Geological Survey.

Only brief mention was made in last year's report of the field expedition of the Smithsonian Institution to Wyoming under the direction of C. W. Gilmore, since it extended well into the present fiscal year. Accompanied by George F. Sternberg, George B. Pearce, and Alfonso Segura, of the Museo Nacional in San José, Costa Rica, the party spent 2½ months in a systematic search of the Hat Creek Basin area, Niobrara County, Wyo., for Oligocene vertebrate fossils. This work resulted in assembling a collection which, when combined with the specimens obtained in 1932, gives the Museum for the first time an adequate representation of this important fauna.

#### MISCELLANEOUS

*Visitors.*—Curtailement of train and bus travel and the rationing of gasoline resulted in a further reduction in the number of visitors at the various Museum buildings. The total recorded during the year was 1,355,269, as against 2,042,817 for the previous year. The largest attendance for a single month was in August 1942, with 163,413 visitors, and the second largest was in July 1942, with 136,111. The attendance in the four Smithsonian and Museum buildings was as follows: Smithsonian building, 264,117; Arts and Industries building, 516,910; Natural History building, 424,055; Aircraft building, 150,187.

From November 1, 1942, to June 30, 1943, a separate count was made of members of the armed forces who visited the buildings during the first 7 days of each month. This count served to show that attendance by servicemen averaged 25 to 35 percent of the total number of visitors.

*Publications and printing.*—The sum of \$27,750 was available during the fiscal year for the publication of the Annual Report, Bulletins, and Proceedings of the National Museum. Publications issued numbered 30—the Annual Report, 3 Bulletins, 1 Contribution from the National Herbarium, and 25 Proceedings papers. A list of these publications is given in the report on publications, appendix 10.

Volumes and separates distributed during the year to libraries, institutions, and individuals throughout the world aggregated 55,631 copies.

*Special exhibits.*—Twelve special exhibits were held during the year under the auspices of various educational, scientific, recreational, and governmental groups. In addition the department of engineering and industries arranged 27 special displays—12 in graphic arts and 15 in photography.

#### CHANGES IN ORGANIZATION AND STAFF

To afford a more usual description of the functions of Dr. Alexander Wetmore's position, on January 16, 1943, his title was changed to Assistant Secretary, Smithsonian Institution, Director, United States National Museum.

In the department of anthropology Dr. Joseph E. Weckler, Jr., associate curator in the division of ethnology, resigned on January 6, 1943.

Following the death of Dr. Leonhard Stejneger, head curator of the department of biology for many years, Dr. Waldo L. Schmitt, curator of the division of marine invertebrates, was advanced to the position of head curator of the department on June 16, 1943. Dr. Doris M. Cochran's title was changed on March 27, 1943, to associate curator in charge of the division of reptiles and batrachians. In the division of mollusks, Dr. Harald A. Rehder was reallocated to associate curator and Dr. Joseph P. E. Morrison to assistant curator on September 1, 1942. On July 1, 1942, Walter A. Weber was appointed assistant curator on the staff of the division of birds to succeed S. Dillon Ripley, II.

During the absence of Frank A. Taylor, who is now on military duty, the head curator of the department of engineering and industries, Carl W. Mitman, assumed charge of the division. In the division of engineering Fred C. Reed was appointed acting associate curator on August 1, 1942, while Paul E. Garber is on military furlough. Other division of engineering staff appointments, to be effective only for the duration of the war, are: Kenneth M. Perry, advanced from exhibits worker to senior scientific aid, August 1, 1942; Burlie Parks, transferred from the Museum property office to the position of exhibits worker formerly held by Mr. Perry. Dr. Wallace E. Duncan, assistant curator, section of chemical industries, resigned on July 31, 1942. The vacancy caused by his resignation was filled November 2, 1942, by the transfer of Joseph W. Schutz from the Social Security Board.

An honorary appointment was conferred on Dr. Walter K. Fisher as associate in zoology on June 25, 1943. The honorary title of Dr. T. Wayland Vaughan was changed on July 28, 1942, from associate in marine sediments, department of biology, to associate in paleontol-

ogy in the department of geology, to represent his existing activities more properly.

Employees furloughed for military duty during the year were as follows: Everett A. Altizer, on July 6, 1942; Paul E. Garber, on July 6, 1942; Samuel T. Fetterman, on July 20, 1942; Dr. Charles L. Gazin, on July 20, 1942; Preston L. Travers, on July 22, 1942; John L. Theunissen, on August 24, 1942; Ernest Desantis, on September 30, 1942; John B. J. Peck, on September 30, 1942; Glen P. Shephard, on October 15, 1942; Dr. Marshall T. Newman, on December 3, 1942; Harold W. McGiverin, on December 11, 1942; and Frank T. Taylor, on April 14, 1943. Furloughed for duty in private industry: Edward Zuranski, on January 23, 1943, and Charles F. Huselstein, on May 28, 1943.

Through the operation of the retirement act, Joseph H. Boswell, principal guard (sergeant), on June 30, 1943, retired at his own option with 17 years of government service.

The year was marked by the death of several staff members long connected with the Museum. The death of Dr. Leonhard Stejneger on February 28, 1943, has deprived the Museum of one of its most widely known scientists. Harry S. Jones, principal mechanic, foreman of electricians, died suddenly September 11, 1942; John D. Ray, junior laborer, died October 28, 1942; and Jennie T. Jackson, charwoman, on August 29, 1942. In addition to these the honorary staff lost Dr. Samuel W. Woodhouse, collaborator, section of ceramics, department of anthropology, by death on February 2, 1943, and Dr. Mary J. Rathbun, associate in zoology, department of biology, whose death occurred on April 4, 1943.

Respectfully submitted.

ALEXANDER WETMORE, *Assistant Secretary,*  
*Director, U. S. National Museum.*

Dr. C. G. ABBOT,  
*Secretary, Smithsonian Institution.*



## APPENDIX 2

### REPORT ON THE NATIONAL GALLERY OF ART

SIR: I have the honor to submit, on behalf of the Board of Trustees of the National Gallery of Art, the sixth annual report of the Board covering its operations for the fiscal year ended June 30, 1943. This report is made pursuant to the provisions of the act of March 24, 1937 (50 Stat. 51), as amended by the public resolution of April 13, 1939 (Pub. Res. No. 9, 76th Cong.).

#### ORGANIZATION AND STAFF

During the fiscal year ended June 30, 1943, the Board was comprised of the Chief Justice of the United States, Harlan F. Stone; the Secretary of State, Cordell Hull; the Secretary of the Treasury, Henry Morgenthau, Jr.; and the Secretary of the Smithsonian Institution, Dr. C. G. Abbot, ex officio; and five general trustees, David K. E. Bruce, Duncan Phillips, Ferdinand Lamot Belin, Joseph E. Widener, and Samuel H. Kress.

At its annual meeting held February 8, 1943, the Board reelected David K. E. Bruce, President, and Ferdinand Lamot Belin, Vice President, of the Board, to serve the ensuing year. The executive officers continuing in office during the year were Huntington Cairns, who succeeded Donald D. Shepard, resigned, as Secretary-Treasurer and General Counsel, and took office on January 13, 1943; David E. Finley, Director; Harry A. McBride, Administrator; John Walker, Chief Curator; and Macgill James, Assistant Director. During the year Donald D. Shepard was appointed Adviser to the Board; Elizabeth Mongan was appointed Curator of Painting, Decorative and Graphic Arts; and David Keppel was appointed Associate Curator of Prints.

The three standing committees of the Board, provided for in the bylaws, as constituted at the annual meeting of the Board, held February 8, 1943, were:

#### EXECUTIVE COMMITTEE

Chief Justice of the United States, Harlan F. Stone, chairman  
David K. E. Bruce, vice chairman  
Secretary of the Smithsonian Institution, Dr. C. G. Abbot  
Ferdinand Lamot Belin  
Duncan Phillips

## FINANCE COMMITTEE

Secretary of the Treasury, Henry Morgenthau, Jr., chairman  
 David K. E. Bruce, vice chairman  
 Secretary of State, Cordell Hull  
 Ferdinand Lammot Belin  
 Samuel H. Kress

## ACQUISITIONS COMMITTEE

David K. E. Bruce, chairman  
 Ferdinand Lammot Belin, vice chairman  
 Duncan Phillips  
 Joseph E. Widener  
 David E. Finley, ex officio

All positions with the Gallery (with the exception of the executive and honorary officers) are filled from the registers of the United States Civil Service Commission or with its approval. By June 30, 1943, the permanent Civil Service staff numbered 232 employees. Since the opening of hostilities, 41 members of the staff, or approximately 18 percent, have joined the armed forces.

## APPROPRIATIONS

For salaries and expenses, for the upkeep and operation of the National Gallery of Art, the protection and care of the works of art acquired by the Board, and all administrative expenses incident thereto, as authorized by the Act of March 24, 1937 (50 Stat. 51), as amended by the public resolution of April 13, 1939 (Pub. Res. No. 9, 76th Cong.), the Congress appropriated for the fiscal year ending June 30, 1943, the sum of \$563,825.00. This amount includes regular appropriations of \$541,365.00 and a supplemental deficiency appropriation for the payment of "overtime compensation" authorized by the Acts of Congress in the amount of \$22,460.00. From this appropriation the following expenditures and encumbrances were made:

## EXPENDITURES AND ENCUMBRANCES

Personal services.....	\$449, 825. 00
Printing and binding.....	3, 506. 88
Supplies and equipment, etc.....	108, 758. 15
Unencumbered balance.....	1, 734. 97
Total.....	\$563, 825. 00

In addition to the above-mentioned appropriations aggregating \$563,825.00, the Gallery received \$32,264.58 from the Federal Works Agency, Public Buildings Administration, to cover expenses incurred in connection with the special protection of masterpieces of painting and sculpture which have been evacuated from the Gallery.

## ATTENDANCE

The total attendance from July 1, 1942, to June 30, 1943, was 1,508,081, a daily average of 4,132 visitors, over 25 percent of this number being men and women in the uniformed military services. In spite of war conditions the number of visitors at the National Gallery of Art has been increasing. The first 6 months of the calendar year 1943 the attendance was 876,460, as compared with 577,360 during the first 6 months of 1942, while the attendance during June—the last month of the fiscal year—was 164,202 in 1943, compared with 91,810 in 1942.

Among the activities contributing to the consistent growth of popularity of the Gallery are the Sunday night openings, the special exhibitions of contemporary art, the variety and excellence of the Sunday evening musical concerts, the Sunday night suppers for servicemen, and the Servicemen's Room, which has furnished a place of relaxation for many men in the military services who, especially on week ends, visit the Gallery.

## PUBLICATIONS

In the information rooms in the Gallery building, the Gallery continues to pursue and expand its policy of making catalogs, color reproductions, and similar publications available to the public at moderate cost. There is also available, without charge, a general information booklet containing a short account of the history of painting and sculpture from the thirteenth to the nineteenth centuries, as illustrated by the Gallery's collections, and clearly marked floor plans to guide visitors in their study of the various exhibits. The booklet is of great assistance to visitors and may be obtained at the information rooms on request.

## AIR-RAID PROTECTION

The Gallery staff, which is organized to form five air-raid services, namely, fire, police (including morale), health (first aid), maintenance, and evacuation, has been kept in constant training through the medium of weekly building air-raid drills. Drills held in coordination with the District of Columbia authorities, when visitors were in the building, gave evidence of the measure of efficiency which has been reached by the protective organization in the Gallery.

## ACQUISITIONS

## GIFTS OF PRINTS

On December 29, 1942, the Board of Trustees accepted from Mr. and Mrs. J. Watson Webb two sets of etchings by James Abbott

McNeill Whistler, and on February 8, 1943, the Board accepted from Mrs. J. Watson Webb an engraving of St. Jerome by Albrecht Durer; on March 15, 1943, the Board accepted from Lessing J. Rosenwald, a gift of his collection of prints and drawings, consisting of some 6,500 items; on April 12, 1943, the Board accepted from Mrs. George Nichols a gift of four prints; and on June 7, 1943, the Board accepted from David Keppel a gift of a set of Vedute by Piranesi.

#### GIFTS OF PAINTINGS AND SCULPTURE

On August 1, 1942, the Board of Trustees accepted from The A. W. Mellon Educational and Charitable Trust a gift of 62 paintings, 2 engravings, and a bronze bust of the late Andrew W. Mellon, by Jo Davidson; on September 3, 1942, the Board accepted from the Honorable Frederic A. Delano a gift of a portrait of "Captain Warren Delano" by Charles Loring Elliott; on December 1, 1942, the Board accepted from Mrs. Jesse Isidor Straus a gift of a terra-cotta group, "La Surprise," signed by Clodion; also on December 1, 1942, the Board accepted from Clarence Van Dyke Tiers two paintings, "Henry Pratt" by Thomas Sully, and the "Duke of Portland" by Matthew Pratt. On December 1, 1942, the Board accepted from Mrs. Robert Noyes a bequest of a portrait by Gilbert Stuart of "William Rickart." On February 8, 1943, and on June 7, 1943, the Board of Trustees accepted from Chester Dale gifts of 23 paintings. On June 7, 1943, the Board accepted from Miss Ethlyn McKinney a gift of a painting by Childe Hassam, entitled "Allies Day, May 1917"; also on June 7, 1943, the Board accepted from J. H. Whittemore Company a gift of two paintings, "The White Girl" and "L'Andalouse," both by Whistler.

On June 7, 1943, the Board of Trustees accepted from the Works Progress Administration a donation of the Index of American Design consisting of 22,000 or more documented drawings and water colors made under the auspices of the United States Government as a pictorial record of American source material in design and craftsmanship from early Colonial days to the close of the nineteenth century.

Another notable gift was that of Joseph E. Widener, given to the Gallery in memory of his father, the late Peter A. B. Widener. This gift was made on September 9, 1942, and consisted of a collection of paintings, sculpture, tapestries, jewels, furniture, ceramics and other objects of art. In this collection the National Gallery of Art has received one of the greatest donations ever made to any museum. The Widener collection was begun many years ago by Peter A. B. Widener, who died in 1915. After his father's death, Joseph Widener continued to build up the collection, and in his choice revealed a faultless discrimination.

On March 18, 1943, the National Gallery of Art announced the gift of the famous collection of prints of Lessing J. Rosenwald. The collection consists of over 6,500 items, including representative examples of print-making from the fifteenth century to the present, a number of drawings, original wood blocks and copper plates, letters and valuable reference books relating to the history of engraving. The collection was carefully built up by Mr. Rosenwald during the last 20 years. Because of his extraordinary knowledge and discrimination, he has brought together one of the greatest collections of the graphic arts ever assembled by a private individual.

#### LOAN OF WORKS OF ART RETURNED

During the year the following works of art which had been placed on loan at the Gallery were returned:

To Dr. A. C. Miller the seven paintings loaned by him to the Gallery and listed in this report under the heading "Loans of Works of Art to the Gallery."

#### LOAN OF WORKS OF ART BY THE GALLERY

During the year 13 architectural drawings of the National Gallery building by the late John Russell Pope were placed on loan with the National Academy of Design, New York, N. Y.

#### EXHIBITIONS

The following exhibitions were held at the National Gallery of Art during the last year:

An exhibition of bronze busts of South American Presidents was shown in the West Garden Court of the Gallery from June 27 through July 19, 1942. The countries represented were Chile, Ecuador, Uruguay, Venezuela, Paraguay, Argentina, Bolivia, Peru, Colombia, and Brazil.

Sponsored by Life magazine, an exhibition of 118 paintings of military life and activities done in oils, water colors, and charcoal by artists serving in the United States armed forces was shown in the Gallery from July 5 through August 2, 1942.

A group of seventeenth- and eighteenth-century prints from the Gallery's own collection was exhibited from August 7 through September 29, 1942.

An exhibition of Chilean Contemporary Art consisting of 150 oil paintings, water colors, drawings, and prints selected from the great Chilean Exhibition assembled by the University of Chile during the observance of the 400th anniversary of Santiago, Chile's capital, was shown in the Gallery from October 10 through November 8, 1942.

An exhibition of 350 war posters sponsored by Artists for Victory, Inc., was shown in the Gallery from January 9 through February 19, 1943.

An exhibition of drawings and water colors on loan from French museums and others was held in the Gallery from February 28 through March 28, 1943. An exhibition of Whistler etchings, the gift of Mrs. J. Watson Webb, was shown in the Gallery from February 28 through March 28, 1943.

The Thomas Jefferson Bicentennial Exhibition, commemorating the two-hundredth anniversary of his birth, was held at the National Gallery of Art from April 13 through May 15, 1943. Displayed were numerous portraits of Thomas Jefferson, as he appeared to his contemporaries during his long and varied career. A unique set of portraits of the first five Presidents, painted by Gilbert Stuart, formed an important group. There were also portraits of Jefferson's friends and contemporaries, including Houdon, the celebrated French sculptor, and Gilbert Stuart. Included in the exhibition were architectural drawings of buildings Jefferson designed, among them Monticello, the Virginia Capitol at Richmond, and the University of Virginia.

An exhibition of American paintings, gifts from The A. W. Mellon Educational and Charitable Trust, Chester Dale, and Clarence Van Dyke Tiers, was held in the Gallery from May 25 through June 13, 1943.

Life magazine also sponsored an exhibition of 125 paintings made by leading American artists in cooperation with the War Department, in United States battle zones, which was shown in the Gallery from June 20 through July 20, 1943. An exhibition of prints, water colors, and books by William Blake, from the Lessing J. Rosenwald collection, was opened to the public on Easter Sunday, April 25, 1943, and has been on exhibition in the Gallery since that date.

#### SALE OR EXCHANGE OF WORKS OF ART

During the year no works of art belonging to the Gallery were sold or exchanged.

#### LOANS OF WORKS OF ART TO THE GALLERY

During the year the following works of art were received on loan:

From the Belgian Government:

<i>Title</i>	<i>Artist</i>
La Cuisinière.....	Aertsen, Pieter
La Calvaire.....	Bles, Herri met de
Nature Morte.....	Brueghel, Jan, the elder
La Parabole du Semeur.....	Brueghel, Pieter, the elder
La Vierge à la Soupe au lait.....	David, Gerard

<i>Title</i>	<i>Artist</i>
Sainte Famille.....	Goes, H. van der
Saint Ives Patron des Avocats.....	Jordaens, Jacob
La Martyre de Saint Sebastien.....	Memling, Hans
Portrait d'Homme.....	Mostaert, Jan
Portrait de Georges de Zelle, Medecin.....	Orley, B. van
La Sagesse Victorieuse de la Guerre et de la Discorde, sous le Gouvernement de Jacques I d'Angleterre .....	Rubens, Peter Paul
La Vierge au Myosotis.....	Rubens, Peter Paul
La Guirlande des Fleurs.....	Seghers, Daniel
Apollon et les Muses.....	Vos, Martin de

From Chester Dale, New York, N. Y.:

Art reference library, large rug, and desk

From National Collection of Fine Arts, Washington, D. C.:

Oil painting, High Cliff, Coast of Maine, by Winslow Homer

From Dr. A. C. Miller, Washington, D. C.

<i>Title</i>	<i>Artist</i>
Madonna and Child.....	Lucas Cranach, the elder
Portrait of a Man.....	Sir Anthony Van Dyck
Portrait of a Man.....	Ambrosius Benson
Portrait of a Woman.....	Ambrosius Benson
Portrait of a Man.....	Barthel Bruyn, the elder
Portrait of a Man on Parchment.....	Peter Gertner
Portrait of a Woman on Parchment....	Peter Gertner

From John S. Broome, Washington, D. C.:

Oil painting, Lost on the Grand Banks, by Winslow Homer

#### VARIOUS GALLERY ACTIVITIES

The Sunday evening concerts, which were instituted on June 7, 1942, primarily for the benefit of service men and women and war workers in the city, have been so successful that they have been continued. The exhibition galleries have been open from 2:00 to 10:00 p. m. each Sunday evening throughout the year. Concerts of orchestral music and string quartets have been provided with funds donated by Chester Dale, and by The A. W. Mellon Educational and Charitable Trust, and later from the Gallery's trust fund received from The A. W. Mellon Educational and Charitable Trust. In addition, concerts have been donated by such well-known artists as Albert Spalding, violinist, Frances Nash, pianist, and by artists in the armed forces attached to the Navy School of Music, the Army Music School, the Army Air Forces Band. The Ballet Russe de Monte Carlo contributed a performance in the East Garden Court on May 2, 1943, especially for the wounded servicemen from the local hospitals.

## CURATORIAL DEPARTMENT

The curatorial work for the year consisted of the installation of over 600 works of art from the Widener collection, and of 173 other gifts, and of 18 temporary exhibitions; in giving various lectures on the collections and related fields in conjunction with the program of the educational department; and in further cataloging the works of art. A check list of the works of art in the Widener collection, with an introduction, was compiled and printed, and a new general information pamphlet was devised and printed for free distribution to visitors at the Gallery.

During the past year the staffs of the curatorial and the educational departments have collaborated in issuing a catalog, a portfolio of colored reproductions, and nine pamphlets dealing with the Gallery and its collections. Six members of the staff have contributed twelve articles to several periodicals and pamphlet series. Two books and several articles are currently in preparation.

In the course of the year, approximately 9,420 works of art were submitted to the acquisitions committee (including 1,945 prints from the Widener collection and approximately 6,500 from the Rosenwald collection) with recommendations regarding their acceptability for the collections of the National Gallery of Art; 21 private collections were visited in connection with offers to the Gallery of gifts or loans; 126 consultations were held concerning over 250 works of art brought to the Gallery for expert opinion; 11 visits were made outside the Gallery to give expert opinion; and 32 letters were written in answer to inquiries involving research in the history of art.

## RESTORATION AND REPAIR OF WORKS OF ART

During the year, as authorized by the Board and with the approval of the Director and Chief Curator, Stephen Pichetto, Consultant Restorer to the Gallery, together with his staff, has undertaken such restoration and repair of paintings and sculpture in the collection as has been found to be necessary. All this work was carried on in the restorer's rooms in the Gallery except in one case, when an unusually delicate and complicated restoration was required; this painting is being restored in Mr. Pichetto's studios in New York.

## WORKS OF ART STORED IN A PLACE OF SAFEKEEPING

Early in January 1942, a limited number of fragile and irreplaceable works of art in the Gallery collections were removed to a place of greater safety. These works, stored in a place adapted for the purpose, have since been under constant guard by members of the



Gallery's guard force and under supervision and inspection by a member of the curatorial staff of the Gallery.

#### EDUCATIONAL PROGRAM

The attendance (97,000) for the educational program was double that of the previous year (47,000).

The Gallery tours of the collection, conducted twice daily, Monday through Friday, and once on Saturday, have been supplemented by tours for service men and women on Saturdays. In addition to these tours, slide lectures on the collection, given by members of the curatorial and educational departments, were continued, and more than 22,000 persons attended the consistently popular feature, the "Picture of the Week," a 10-minute discussion of single paintings.

New features introduced by the department during the past year included film lectures, music lectures, and noon-hour concerts of recorded music, all of which have been well attended.

Changes in personnel due to wartime conditions placed unusual responsibilities and added work on the members of the department and because of this increased pressure it was not possible for the educational staff to assume extra assignments. The following projects, however, were completed: cataloging the collection of approximately 3,500 slides; preparation of manuscripts for lectures on the Gallery for the Federation of Women's Clubs; slide lecture on the Gallery, for circulation by the American Federation of Arts; various articles for publication in art magazines; and the planning and supervision of the motion picture on the National Gallery of Art. This motion picture was completed in June 1943, by the Gallery staff in cooperation with the Office of Strategic Services. Accompanied by a special musical score and commentary, the film includes views of the exterior and interior of the building, air-conditioning and lighting equipment, and a color sequence showing many of the outstanding works of art on exhibition. It is expected that the film will be widely circulated among educational institutions and the general public in this country and abroad.

#### LIBRARY

A total of 746 books and 106 pamphlets and periodicals were presented to the Gallery; 33 books and 110 pamphlets and periodicals were purchased by the Gallery; 472 photographs and drawings were presented as gifts; 27 books and 316 pamphlets and periodicals were acquired through exchange; 1 film was presented as a gift, and 22 subscriptions to periodicals were made.

## PHOTOGRAPHIC DEPARTMENT

Prints totaling 11,401, 459 black-and-white slides, and 2,034 color slides have been made by the photographic laboratory. The prints have been placed on file in the library, where they are for sale and for the use of the Gallery staff. The slides have been made available for the staff in connection with the public lectures given in the Gallery and have likewise been lent to lecturers outside the Gallery and to other galleries.

## OTHER GIFTS

During the year there were gifts to the Gallery of plants for the garden courts; also certain expenses were paid by others on behalf of the Gallery, the donors being Mrs. William Corcoran Eustis, David E. Finley, Dumbarton Oaks Research Library and Collection of Harvard University, Life magazine, The A. W. Mellon Educational and Charitable Trust, and the Toledo Museum of Art. Gifts of money were made to the Gallery during the year by Mrs. Florence Becker, Maj. Curtis Bryan, Chester Dale, Mrs. William Corcoran Eustis, David E. Finley, Mrs. David E. Finley, Sr., S. R. Guggenheim, Samuel H. Kress and Samuel H. Kress Foundation, Lt. Paul Mellon, Mrs. Stephen S. Pichetto, Donald D. Shepard, Mrs. Gertrude Clarke Whittall, Joseph E. Widener, Avalon Foundation, and The A. W. Mellon Educational and Charitable Trust.

## AUDIT OF PRIVATE FUNDS OF THE GALLERY

An audit has been made of the private funds of the Gallery for the year ended June 30, 1943, by Price, Waterhouse & Co., a nationally known firm of public accountants, and the certificate of that company on its examination of the accounting records maintained for such funds has been submitted to the Gallery.

Respectfully submitted.

F. L. BELIN, *Acting President.*

Dr. C. G. ABBOT,  
*Secretary, Smithsonian Institution.*

## APPENDIX 3

### REPORT ON THE NATIONAL COLLECTION OF FINE ARTS

SIR: I have the honor to submit the following report on the activities of the National Collection of Fine Arts for the fiscal year ended June 30, 1943:

#### APPROPRIATIONS

For the administration of the National Collection of Fine Arts by the Smithsonian Institution, including compensation of necessary employees, purchase of books of reference and periodicals, traveling expenses, uniforms for guards, and necessary incidental expenses, \$31,993 was appropriated, of which \$20,487.44 was expended for the care and maintenance of the Freer Gallery of Art, a unit of the National Collection of Fine Arts. The balance was spent for the care and upkeep of the National Collection of Fine Arts, nearly all of this sum being required for the payment of salaries, traveling expenses, purchase of books and periodicals, and necessary disbursements for the care of the collection.

#### THE SMITHSONIAN ART COMMISSION

Owing to crowded transportation and hotel facilities, it was decided to omit the December 1942 annual meeting of the Smithsonian Art Commission. Several proffered gifts of art works have been deposited with the National Collection of Fine Arts to be passed upon at the next meeting of the Commission.

The Commission lost two of its members by death during the year. John E. Lodge, a member of the Commission since its inception and chairman of the subcommittee on Oriental art, died December 29, 1942, and Charles L. Borie, a member of the Commission since 1926 and chairman since 1935, died May 11, 1943.

#### THE CATHERINE WALDEN MYER FUND

Fourteen miniatures, water color on ivory, were acquired from the fund established through the bequest of the late Catherine Walden Myer, as follows:

28. "Portrait of a Man," by Raphael Peale (1774-1825); from Miss Dora Lamb, Chattanooga, Tenn.

29. "Portrait of Mr. Lewis," by James Peale (1749-1831); from Edmund Bury, Philadelphia, Pa.
30. "Portrait of a Man," by Walter Robertson (before 1765-1802); from Card & Osborne, Inc., Washington, D. C.
31. "Emily Appleton," by Sarah Goodridge (1788-1853); from Miss Bessie J. Howard, Boston, Mass.
32. "Portrait of a Lady," by an unknown artist; from Miss Bessie J. Howard, Boston, Mass.
33. "Beulah Appleton," by Sarah Goodridge (1788-1853); from Gimbel Bros., New York City.
34. "Dr. William Beckman," by Alexander Robertson (1772-1841); from Gimbel Bros., New York City.
35. "John Trumbull Ray," by Thomas S. Cummings (1804-1894); from Gimbel Bros., New York City.
36. "Edward Appleton," by Sarah Goodridge (1788-1853); from Miss Bessie J. Howard, Boston, Mass.
37. "Matilda Barrington," by Elkanah Tisdale (about 1771-after 1834); from Miss Bessie J. Howard, Boston, Mass.
38. "Portrait of a Young Lady," by Robert Fulton (1765-1815); from Miss Bessie J. Howard, Boston, Mass.
39. "Self Portrait," by Sarah Goodridge (1788-1853); from Miss Bessie J. Howard, Boston, Mass.
40. "Mr. Hargreaves," by Thomas Hargreaves (1775-1846); from Stephen K. Nagy, Philadelphia, Pa.
41. "Portrait of M. B.," by Phillip A. Peticolas (1760-1843); from Mrs. Dora Lee Curtis, Arlington, Va.

#### LOANS ACCEPTED

An oil painting, "Maid of the Mist," by Thomas Cole (1801-1848), was lent by Mrs. L. T. Gager.

A marble bust of Hon. Charles Evans Hughes, by Bryant Baker, was lent by Mr. Hughes.

The following were lent anonymously: 435 Chinese jade ornaments; 122 Chinese jade, stone, glass, and porcelain snuff bottles; 44 Chinese mirrors; 1 Imperial plate, Kuang Hsu (1875-1912), dragon design in cobalt blue, with stand; 1 Flambé or transmutation copper glaze bowl, Yung Chêng or Ch'ien Lung, eighteenth century, with stand; 1 Imperial bowl, K'ang Hsi (1662-1722), phoenix and dragon design, blue, white, and peachblow, and 1 Imperial tea bowl, K'ang Hsi (1662-1722), Imperial yellow with dragons in green and aubergine.

#### LOANS TO OTHER MUSEUMS AND ORGANIZATIONS

An oil portrait, "Alice Barney with Jabot," by Alice Barney, was lent to the Society of Washington Artists to be shown in connection with their exhibition held at the Corcoran Gallery of Art from January 23 to February 14, 1943. (Returned February 20, 1943.)

A miniature, "Portrait of a Colonial Gentleman," signed "Copley 1773," No. 20 in the Catherine Walden Myer Fund Collection, was

lent to the Worcester Art Museum to be included in a loan exhibition "New England Painting, 1700-1775" held at the Worcester Art Museum in collaboration with the American Antiquarian Society, February 17 to March 31, 1943. (Returned May 8, 1943.)

A bronze bust of Jeanne d'Arc, by Berthe Girardet, with a pedestal, was lent to the Hecht Co., where it was shown March 13 to 31, 1943, in connection with a drive for the recruiting of WAC's.

An oil painting, "High Cliff, Coast of Maine," by Winslow Homer, was lent to the National Gallery of Art on May 15, 1943, subject to recall by the Smithsonian Institution at any time.

#### WITHDRAWALS BY OWNERS

Two oil paintings, "Henry, First Earl of Mulgrave," by Sir Thomas Lawrence, and "Landscape with Cottage," by Hobbema, were withdrawn from the Perkins Collection by their owners, Mrs. Feroline Wallach and Mrs. Mabel Ruggles, respectively, on July 14, 1942.

An oil painting, "Portrait of Theophilus Parsons, First Chief Justice of Massachusetts," by Gilbert Stuart, was withdrawn by the owner, Theophilus Parsons, on October 1, 1942.

A pair of Meissen ewers was withdrawn by the owners, Mr. and Mrs. J. D. Patten, on November 10, 1942.

A miniature, "Portrait of a Boy," by Joseph Wood, was withdrawn by the owner, Miss Sarah Lee, on March 23, 1943.

#### THE HENRY WARD RANGER FUND PURCHASES

The paintings purchased by the Council of the National Academy of Design from the fund provided by the Henry Ward Ranger bequest, which, under certain conditions, are prospective additions to the National Collection of Fine Arts, and the names of the institutions to which they have been assigned, are as follows:

Title	Artist	Date of purchase	Assignment
115. Wreck at Lobster Cove.....	Andrew Winter, N. A. (1893-)	April 1940.	-----
116. Farm in Winter.....	Milton W. Holm (1903 -)	.....do.....	Greenville Public Library, Greenville, S. C.
117. Old Chinese Gulch.....	Emil J. Kosa, Jr. (1903 -)	April 1941.	The Montgomery Museum of Fine Arts, Montgomery, Ala.
118. Arrangement.....	Cathal B. O'Toole, A. N. A. (1903 -)	.....do.....	The Bronxville Public Library, Bronxville, N. Y.
119. Furbelows.....	Albert Sterner, N. A. (1863 -)	May 1942	St. Gregory College, Shawnee, Okla.

#### THE NATIONAL COLLECTION OF FINE ARTS REFERENCE LIBRARY

A total of 1,103 publications (527 volumes and 576 pamphlets) were accessioned during the year. This number includes 258 volumes and

66 pamphlets added by purchase, and 77 volumes of bound periodicals. The Parke-Bernet priced catalogs accounted for 53 volumes and 60 pamphlets among the purchases.

Miss Anna M. Link was appointed librarian October 16, 1942.

#### OTHER ACTIVITIES

The following paintings have been cleaned or restored since July 1, 1942:

"The Storm King on the Hudson," by Samuel Colman, was relined.

"Mountain Scene," by F. E. Church, was cleaned.

"Mountain Scene," by I. Diday, was cleaned.

"Painting Representing Falls, supposed to be Genesee Falls, N. Y." by William Winstanley, was relined and restored. From the geologic formation seen in the painting, it was determined that the falls could not be Genesee Falls of New York, but could be part of the Great Falls of the Potomac. This painting belonged to George Washington and is now the property of the division of history of the National Museum.

"Moonlight Scene from a Grotto on a Rocky Coast," by an unknown artist, was cleaned. This painting belonged to George Washington and is now the property of the division of history of the National Museum.

"Portrait of Judge Denny," by Thomas Sully, was relined. Property of the Supreme Court.

"Portrait of Col. Timothy Pickering" was varnished and the frame restored. Property of the War Department.

Advice and supervision was given the United States Capitol regarding the large Halsall naval painting, "The Monitor and Merrimac," painted in 1884.

Eight exhibition cases containing ancient necklaces, rare Persian paintings, ceramics, jewelry, cameo glass, and miniatures were moved from the first floor to the ground floor.

Eight of the antique wooden and terra-cotta statues in the Gellatly Collection are now shown on shelves against a monk's-cloth background. The rearrangement made possible the removal of two large pedestals, greatly improving the general appearance of the large gallery.

Another rearrangement made possible by the addition of two exhibition cases has brought together nearly all the rare Chinese glass, jade, and pottery.

K. T. Wu and C. M. Wang, of the Library of Congress, translated the inscription on the Northern Wei stele (357, Gellatly Collection), and made a number of rubbings of this Chinese statue.

The huge vase showing a copy of Guido Reni's "Aurora" and a self portrait of Guido Reni (226, Pell Collection) was appropriately placed in the center of the National Museum rotunda.

The largest task of the year was the making of a sheet catalog with cross references of the paintings and sculpture of the collection. The

works of art were carefully described and identified both as to artist and subject, but there still remain some dates and measurements to be checked.

## SPECIAL EXHIBITIONS

The following exhibitions were held:

*July 1 through 27, 1942.*—Exhibition of 20 oil paintings, 17 water colors, 2 pastels, by Señorita Carmen Madrigal Nieto, of Costa Rica, and 1 map of Costa Rica and 1 vacation advertisement, was sponsored by the Minister of Costa Rica, Señor Dr. Don Luis Fernández, and the Pan American Union.

*September 15 through 30, 1942.*—Exhibition of 30 oil paintings by Señorita Pachita Crespi, of Costa Rica, was sponsored by the Minister of Costa Rica, Señor Dr. Don Luis Fernández, and the Pan American Union.

*November 5 through 29, 1942.*—Exhibition of 61 oil paintings by Frank C. Kirk, of New York City.

*December 12, 1942, through January 17, 1943.*—Exhibition of 95 miniatures by 46 members of the Pennsylvania Society of Miniature Painters.

*January 8 through 31, 1943.*—Exhibition of 50 oil paintings and 10 designs on Lenox vases and platters by Simon Lissim, of New York City.

*February 5 through 28, 1943.*—Exhibition of 70 water colors by Leonora Quarterman, of Savannah, Ga.

*June 4 through 27, 1943.*—Exhibition of 46 oil paintings by Walter King Stone, of Ithaca, N. Y.

Ten special graphic arts exhibits were held in the gallery as follows:

*July 15 through August 30, 1942.*—Exhibition of 32 "Prints by 24 Masters," selected from the collection of the division of graphic arts.

*September 1942.*—Exhibition of 35 prints of "Pop" Hart, selected from the collection of the division of graphic arts.

*October 1942.*—Exhibition of 37 pencil drawings by Mrs. Beatrice Field, of Winchester, Mass.

*November 1942.*—Exhibition of 35 wood cuts and linoleum cuts by Norman Kent, of Geneva, N. Y.

*December 1942.*—Exhibition of 35 etchings by Ralph Fabri, of New York, N. Y.

*January 1943.*—Exhibition of 30 color prints by the American Color Print Society.

*February 1943.*—Exhibition of 18 lithographs by Peter Hurd, of San Patricio, N. Mex.

*March 1943.*—Exhibition of 27 etchings and 7 pen drawings by Mrs. Helen Miller, New York, N. Y.

*April 1943.*—Exhibition of 35 etchings by James McBey, of New York, N. Y.

*May 1943.*—Exhibition of 12 drypoints and 20 wax-pencil drawings by George T. Tobin, of New Rochelle, N. Y.

#### PUBLICATIONS

**TOLMAN, R. P.** Report on the National Collection of Fine Arts for the year ended June 30, 1942. Appendix 3, Report of the Secretary of the Smithsonian Institution for the year ended June 30, 1942, pp. 46-50.

**LODGE, J. E.** Report on the Freer Gallery of Art for the year ended June 30, 1942. Appendix 4, Report of the Secretary of the Smithsonian Institution for the year ended June 30, 1942, pp. 51-55.

Respectfully submitted.

R. P. **TOLMAN**, *Acting Director.*

**DR. C. G. ABBOT**,

*Secretary, Smithsonian Institution.*



## APPENDIX 4

### REPORT ON THE FREER GALLERY OF ART

SIR: I have the honor to submit the twenty-third annual report on the Freer Gallery of Art for the year ended June 30, 1943.

#### THE COLLECTIONS

Additions to the collections by purchase are as follow:

##### BRONZE

- 42.14 Chinese, 14th to 12th century B. C. Shang dynasty. Ceremonial covered vessel of the type *yu* in the form of two horned owls standing back to back. Patination: Outside, gray-green with much red (cuprite) in the furrows of the design; inside, bare metal with incrustations of malachite, cuprite and azurite. 0.236 x 0.213 over all. (Illustrated.)

##### GOLD

- 43.1. Persian, 10th century (A. D. 967-977). Būyid period. Small ewer of yellow gold. Decoration chiseled in high relief on a delicately granulated ground, and engraved. Two inscriptions in excellent Kufic script, the upper reading: "Blessing and happiness and power to Abū Maṣṣūr al-Amīr Bakhtiyār ibn Mu'izz ad-Dawla. May God prolong his days." The lower inscription repeats good wishes. H. 0.137; over all 0.160. Weight: 503 grams. (Illustrated.)
- 43.8 Persian, 11th to 12th century. Medal, with designs executed in relief:  
Obverse: a bearded king, enthroned; two attendants.  
Reverse: the same king, mounted, with a falcon on his left hand. He is accompanied by an eagle and is trampling a dragon.  
Diameter: 0.043.

##### PAINTING

- 43.2. Persian (Mesopotamia), A. D. 1224. Baghdād school.  
By 'Abdallāh ibn al-Fadl. Leaf from an Arabic translation of the *Materia Medica* of Dioscorides. Book IV, Caps. 83-84. Two miniatures in color:  
A. Mushrooms.  
B. Autumn Crocus.  
Text in *naskhī* script; two rubrics. Paper leaf: 0.320 x 0.225.

##### PAINTING AND CALLIGRAPHY

- 42.15. A leaf from a royal album upon which are mounted:  
A. Indian, 17th century, Mughal. By Bichitr. The Emperor Jahāngīr, enthroned upon an hourglass, receiving the homage of a *mullah*, two European courtiers and a native prince. In colors and gold. Signature. 0.275 x 0.180.

- B. Indo-Persian, 18th century (A. D. 1727). By Muḥammad Ṣādiq. Floral borders painted in naturalistic style on a gold ground. Signature. Gr. W. 0.060.
- C. Persian, early 17th century: a page of *nasta'liq* writing by 'Imād al-Hasanī (on the reverse side).
- 42.16. A leaf from a royal album (as above) on which are mounted:
- A. Indian, 17th century. Mughal. School of Shāh Jahān. An imaginary meeting between the Emperor Jahāngīr and Shāh 'Abbas I, who are attended by two courtiers with gifts. In colors and gold. 0.275 x 0.200.
- B. Indo-Persian, 18th century (A. D. 1727). By Muḥammad Ṣādiq. Floral borders, dated. Gr. W. 0.060.
- C. Persian, early 17th century (A. D. 1608). A page of *nasta'liq* writing by 'Imād al-Hasanī (on the reverse side).
- 42.17. Two leaves from a royal album (as above) on which are mounted:
- 42.18. A. Indian, 17th century. Mughal, school of Shāh Jahān. Shāh Jahān holding a night audience for a large company of *mullahs*: a double-page composition mounted on two facing pages. In color and gold. 0.305 x 0.460 over all.
- B. Indo-Persian, 18th century (A. D. 1727). By Muḥammad Ṣādiq. Floral borders. Signature and date. Gr. W. 0.043.
- C. Persian, 17th century. Two pages of *nasta'liq* script, unsigned (on the reverse sides).

## PORCELAIN

- 42.19. Chinese, A. D. 1662-1722. Ch'ing dynasty, K'ang Hsi period. Ching-tê Chên. Flower vase with "ox-blood" glaze. H. o. 176.
- 42.20. Chinese, A. D. 1662-1722. Ch'ing dynasty, K'ang Hsi period. Ching-tê Chên. Flower vase with "peach-bloom" glaze. Six-character mark in underglaze blue. Ivory stand. H. o. 198.
- 43.5. Chinese, A. D. 1662-1772. Ch'ing dynasty, K'ang Hsi period. Ching-tê Chên. Circular, covered box for seal cinnabar, with a "peach-bloom" glaze. Six-character mark in underglaze blue. 0.072 x 0.036.
- 43.6. Chinese, A. D. 1662-1722. Ch'ing dynasty, K'ang Hsi period. Ching-tê
- 43.7. Chên. Two water-pots glazed in very pale greenish-blue inside and out. Both have a six-character mark in underglaze blue. a, 0.087 x 0.087; b, 0.089 x 0.088.

## POTTERY

- 43.4. Chinese, 7th to 10th century. T'ang dynasty. Sepulchral vase with serpent handles; slightly beveled foot and concave base. Body of a hard, close-grained, buff-white clay, covered with a transparent glaze tending to pale green. 0.529 x 0.286. (Illustrated.)
- 42.21. Chinese, 11th to 12th century. Sung dynasty. Chü-lu hsien. Pillow, square in section with concave sides; vent-hole in one end. Body of hard, buff clay covered with a faintly crackled glaze over an ivory-white slip. A Ch'ien Lung (18th century) inscription of 78 characters and 2 seals painted in reddish-brown. 0.124 square x 0.209 over all.
- 42.13. Persian, 11th century. So-called Aghkand. Bowl, shallow, flat rimmed; low ring foot. Body of soft, red earthenware covered with a thin, transparent glaze of greenish cast over a white slip. Bird decoration incised with areas of the design colored green, yellow, and aubergine underglaze. 0.076 x 0.283. (Illustrated.)



43.1



42.13

RECENT ADDITIONS TO THE COLLECTION OF THE  
FREER GALLERY OF ART



43.4



42.14

RECENT ADDITIONS TO THE COLLECTION OF THE  
FREER GALLERY OF ART.

43.3. Persian, early 13th century. Kāshān. Large, shallow bowl with flaring rim and bold foot ring (repairs; restorations in the rim). Body of soft, firm, buff clay covered with an opaque white glaze. Decoration painted in turquoise green, blue, dark red, aubergine, and flesh-color overglaze. Inside: the assault by a band of horsemen upon a walled town defended by bowmen; outside: six hero scenes. Inscription in black *naskhī* script. 0.111 x 0.478.

The work of the curatorial staff has been devoted to the study and recording of the new acquisitions listed above and to other Arabic, Chinese, Japanese, and Syrian objects submitted for purchase. In addition to this work within the collection, 1,941 objects of Oriental provenance and 235 photographs of such objects were examined, and oral or written reports made upon them. Written translations of 105 inscriptions in Oriental languages were made upon request. In addition to this regular curatorial work, that contributing to the war services which occupied a major part of the time of the staff is summarized as follows:

#### WAR WORK

Aside from answering many inquiries from, and supplying information to, various Government agencies, a considerable amount of translation has been made for the Government from both Chinese and Japanese sources, amounting to hundreds of pages of typewritten matter. Work upon maps of the war areas has entailed the identification and transliteration of Chinese and Japanese names to the number of more than 5,000. This work is continuing.

In May 1943 three lectures on Chinese culture as reflected in the fine arts were given at the Freer Gallery by the Director in response to the combined request of the United States Office of Education and the acting superintendent of the public schools of the District of Columbia, in furtherance of their plan to disseminate knowledge of China in the public schools. The audiences were composed of Washington teachers (total number 264). The subjects of the lectures were as follows:

May 8: A short discussion of art in general. China and her people.

May 15: Bronze and jade. Purpose and use.

May 22: Chinese painting.

A lecture on Asiatic painting, illustrated with Freer Gallery slides, was given by Miss Guest on October 2, 1942, in the St. Francis Auditorium of the Art Museum, Santa Fe, N. Mex., for the benefit of the Indian Service Club. The sum realized (\$160) made possible the Christmas boxes sent by the club to its members in the armed forces in this country and abroad.

## CHANGES IN EXHIBITION

Four hundred eighty-eight changes were made in exhibition, as follows:

Arabic (Āmīda) painting.....	2
Chinese bronze.....	103
Chinese gold.....	6
Chinese jade.....	104
Chinese marble.....	2
Chinese painting.....	38
Chinese porcelain.....	14
Chinese pottery.....	95
Chinese silver.....	2
Chinese silver-gilt.....	6
Chinese sculpture, bronze.....	10
Chinese sculpture, stone.....	2
Egyptian [Fostât] pottery.....	1
Korean bronze.....	1
Korean pottery.....	39
Persian pottery.....	2
Persian silver.....	1

## ATTENDANCE

The Gallery has been open to the public every day from 9 until 4:30 o'clock with the exception of Mondays, Christmas Day and New Year's Day.

The total attendance of visitors coming in at the main entrance was 53,700. Sixty-nine other visitors on Mondays bring the grand total to 53,769. The total attendance on weekdays was 30,759; Sundays, 22,941. The average weekday attendance was 118; the average Sunday attendance, 441. The highest monthly attendance was in August, with 5,832 visitors; the lowest in December, with 2,571 visitors.

There were 1,026 visitors to the main office during the year; the purposes of their visits were as follows:

For general information.....	316
To see objects in storage.....	175
Far Eastern paintings and textiles.....	37
Near Eastern paintings and manuscripts.....	27
Oriental pottery, jade, glass, bronze, sculpture, lacquer, and bamboo.....	82
Byzantine objects.....	9
<i>Washington Manuscripts</i> .....	20
To read in the library.....	168
To make tracings and sketches from library books.....	18
To see building and installation.....	14
To obtain permission to photograph or sketch.....	7
To submit objects for examination.....	97
To see members of the staff.....	103
To see exhibition galleries on Monday.....	11
To examine or purchase photographs.....	273

## DOCENT SERVICE

Eight groups were given docent service in the exhibition galleries (total 415); four groups were given instruction in the study room (total 21).

## PERSONNEL

It is with great sadness that we have to record the death on December 29, 1942, of John Ellerton Lodge, Director of the Freer Gallery from its beginning in the autumn of 1920. Under his wise administration the Freer collections and endowment were founded as a public institution for the further prosecution of the study and the acquisition of Oriental fine arts. Both branches of this work were developed simultaneously. The first led to the training of language students and to field work in China, as well as to studies within the collection; the second, to an immense and very significant expansion in every field: the sections devoted to Chinese bronzes, jades, painting, and pottery raised to higher levels of quality; the sections devoted to Near Eastern and East Indian manuscripts, paintings, ceramics, glass and metal work created almost in entirety upon small and, for the most part, unimportant nuclei in the original collection.

Elizabeth Hill Maltby, librarian since December 17, 1935, resigned her position on August 15, 1942. On the same day Frances Poncelet, who had reported for duty July 27, was appointed librarian.

Archibald G. Wenley, associate in research, was appointed Acting Director on January 1, 1943. On January 16 he was appointed Director.

William R. B. Acker, language assistant, was placed on furlough December 31, 1942, being detached for service with the Office of War Information.

Daisy Furscott Bishop terminated her long service at the Freer Gallery on January 27, 1943, being transferred to the library of the Smithsonian Institution.

John A. Pope, formerly Lecturer on Chinese Art at Columbia University, was appointed associate in research on April 1, 1943.

Grace T. Whitney worked intermittently at the Gallery in the Near East section between October 22, 1942, and June 16, 1943.

Joseph H. Boswell, principal guard, who had been on duty here since September 1923, retired at his own request June 30, 1943.

Other changes in personnel are as follows:

Appointments: Joseph P. Germuiller, guard, recalled from retirement August 1, 1942; Charles W. Frost, guard, August 25, 1942; Norman E. Baldwin, guard, November 16, 1942; James W. Burns, guard, by temporary transfer from the United States National Mu-

seum, May 11, 1943; George S. Young, cabinetmaker, employed for special help in the cabinet shop, February 16, 1943.

Separations from the service: Everett A. Altizer, guard, on indefinite furlough for naval duty, July 6, 1942; Glen P. Shephard, guard, on indefinite furlough for military duty, October 15, 1942; Norman E. Baldwin, guard, resigned February 26, 1943; Charles W. Frost, guard, by transfer to Airport Detachment No. 5, Gravelly Point, Va., April 13, 1943; Joseph P. Germuiller, guard, retired June 19, 1943.

Respectfully submitted.

A. G. WENLEY, *Director.*

Dr. C. G. ABBOT,

*Secretary, Smithsonian Institution.*



## APPENDIX 5

### REPORT ON THE BUREAU OF AMERICAN ETHNOLOGY

SIR: I have the honor to submit the following report on the field researches, office work, and other operations of the Bureau of American Ethnology during the fiscal year ended June 30, 1943, conducted in accordance with the act of Congress of June 27, 1942, which provides "\* \* \*" for continuing ethnological researches among the American Indians and the natives of Hawaii and the excavation and preservation of archeologic remains. \* \* \*"

During the fiscal year, activities concerned with the other American republics have been emphasized, and the energies of various staff members of the Bureau have been directed to an increasing extent to projects bearing on the war effort. In particular, members of the Bureau staff have cooperated with the Ethnogeographic Board in preparing information for the armed services, and it is expected that efforts in this direction will increase as the war continues.

#### SYSTEMATIC RESEARCHES

On January 13, 1943, M. W. Stirling, Chief of the Bureau, left Washington on the fifth National Geographic Society-Smithsonian Institution archeological expedition to southern Mexico. Excavations were continued at the site of La Venta in southern Tabasco and resulted in the discovery of numerous new details of construction of the rectangular stone-fenced enclosure, one of the central features of the site. Three rich burials of important personages were uncovered containing offerings principally of jade of unusually high quality. Two mosaic floors in the form of jaguar masks made of polished green serpentine were discovered, one at a depth of more than 20 feet. During the course of the work an exploration trip was made up the Rio de las Playas, one of the headwater streams of the Tonalá River, in order to verify the existence of a ruin in this vicinity. The collections obtained during the course of excavations at La Venta were shipped to the National Museum in Mexico City. Mr. Stirling was assisted throughout the season by Dr. Waldo R. Wedel, of the division of archeology of the United States National Museum.

During the course of the fiscal year Mr. Stirling contributed to the War Background Studies of the Smithsonian Institution an article entitled "Native Peoples of New Guinea," which was published as

No. 9 of that series. He also contributed several articles to the Ethnogeographic Board for distribution to the armed forces. During the year Mr. Stirling's paper entitled "Origin Myth of Acoma and Other Records" was issued as Bulletin 135 of the Bureau.

Dr. John R. Swanton, ethnologist, devoted a considerable portion of the year to the reading and correcting of galley and page proof of his work entitled "The Indians of the Southeastern United States," which is being published as Bulletin 137 of the Bureau. This will be a volume of approximately 850 pages exclusive of the index.

Some further work was done on the materials preserved from the now extinct language of the Timucua Indians of Florida, but it was decided to discontinue this for the present. These materials—consisting of a catalog of Timucua words and English-Timucua index to the same, photocopies of the religious works in Timucua and Spanish printed in Mexico in the seventeenth century, and typed copies of these with some interlinear translation—have been labeled carefully and placed in the manuscript vault.

Time was also devoted to the extraction of ethnographical notes from the volumes of Early Western Travels, edited by Reuben Gold Thwaites. A paper entitled "Are Wars Inevitable?" was contributed as No. 12 to the War Background Studies of the Smithsonian Institution. A few investigations were undertaken for the Board on Geographical Names, of which Dr. Swanton is a member.

Dr. John P. Harrington, ethnologist, was occupied during the first part of the year in an investigation of the Chilcotin languages of northern California. The results of this work indicated that Chilcotin was introduced into California from Canada in pre-European times, but owing to the varying rate in time reckoning for the accomplishment of linguistic changes, the length of Chilcotin occupancy in California cannot be estimated. With the exception of a small area south of the mouth of the Klamath River, Chilcotin occupies the entire coastal region of northern California to the mouth of Usal Creek in Mendocino County. In addition to the linguistic connections discovered, local traditions were obtained linking the Chilcotin peoples with a more northern group. Two separate stories were recorded deriving the Hupa from the region north of the mouth of the Klamath River, and one was obtained deriving the Indians of a part of the Eel River drainage from the Hupa region.

Since his return to Washington, Dr. Harrington has been engaged in the preparation of material for the linguistic section of the Handbook of South American Indians. This work resulted in the discovery that Witoto is Tupí-Guaraní, and also the very interesting finding that Quechua is Hokan. The Hokan hitherto had been known to extend only to the Subtiaba language of the west coast of Central America. Detailed studies of Quechua and of Cocama have been made

for the purpose of making comparisons with other South American languages and with a view to discerning possible further linguistic affiliations. In addition to this work, Dr. Harrington has also made an extensive study of the grammar of the Jivaro language of South America.

At the beginning of the fiscal year Dr. Frank H. H. Roberts, Jr., senior archeologist, was engaged in prospecting and testing an interesting site in the Agate Basin, on a tributary of the Cheyenne River between Lusk and Newcastle, in eastern Wyoming. Dr. Roberts had been sent to make preliminary investigations at this location, despite the general policy of no regular field work for the duration of the war, because of the possibility that much information might be lost as a result of erosive activities in the area and from disturbance of the deposits by amateur collectors hunting for specimens. The site gave evidence of having been the scene of a bison kill on the edges of a marsh or meadow. Animal bones and artifacts were found in a stratum that breaks out of the bank some 20 feet above the bottom of an eroding gully. This layer is covered by an overburden that deepens rapidly as it is followed back into the bank, and at a depth of 4 feet, where the tests were terminated, was still continuing. All the bones found, of which there were many, proved to be modern bison. Associated with these were projectile points, which, although they suggest an affinity with the Collateral Yuma type—a form that has been considered relatively early in the Plains area—nevertheless do not have all the significant characteristics of that type. The points have unhesitatingly been called Yuma by numerous people who have examined them, and there is no question of their belonging in that general category, although they should not be considered classic forms. All the points found at the site are consistent in pattern, yet have a considerable range in size. In the seventy-some points or large and easily identified fragments found there, no shouldered, barbed, or tanged forms appear. The material unquestionably represents a cultural unit without intrusions from other sources. Dr. Roberts dug 32 examples out of undisturbed deposits. The remaining specimens are in the collections of local residents, who picked them up as they weathered out of the gully bank. Only a few end and side scrapers have been found, probably because of the fact that the camp proper has not yet been located, but they are typical of those associated with the so-called early hunting complexes. Geologic studies have not yet been made of the deposits. They indicate some antiquity, but that they are not as old as the age formerly postulated for Yuma remains is demonstrated by the fact that the bison represented are all modern forms. It is hoped that when present conditions are over, the site can be

thoroughly excavated and detailed studies made of the material. The site was found by William Spencer, of Spencer, Wyo., and was reported to the Smithsonian Institution by Robert E. Frison, deputy game warden, Wyoming State Game and Fish Commission of Newcastle. Permission for the investigations was granted by Leonard E. Davis, owner of the land.

Leaving Newcastle, Wyo., on August 1, Dr. Roberts proceeded to Tucumcari and San Jon, N. Mex., for the purpose of disposing of some of the equipment stored there at the close of the 1941 season and arranging for storage of the remainder for the duration.

On his return to Washington, Dr. Roberts resumed his office activities. Galley and page proofs were read for his report, "Archeological and Geological Investigations in the San Jon District, Eastern New Mexico," which appeared in the Smithsonian Miscellaneous Collections, volume 103, No. 4. Manuscript was prepared and galley and page proofs were read for a paper entitled "Egypt and the Suez Canal," which was published as No. 11 in the Smithsonian Institution War Background Studies. By request, an article, "Evidence for a Paleo-Indian in the New World," was written for the *Acta Americana*, an international quarterly review published by the Inter-American Society of Anthropology and Geography. During the period from October 1 to June 30 a series of survival articles was prepared from data furnished by members of the Smithsonian staff. These articles were made available to the armed forces through the office of the Ethnogeographic Board. Dr. Roberts devoted considerable time to the task of gathering this information from the Institution's authorities in the various fields of science and working it into articles for general reading. He also furnished information on various subjects in response to requests from numerous members of the armed services. At the close of the fiscal year he was engaged in assisting in the preparation of a survival manual for the Ethnogeographic Board.

On April 1, 1943, Dr. Roberts was designated as Acting Chief of the Bureau of American Ethnology whenever the Chief, by reason of absence, illness, or other cause, is unable to discharge the duties of his position.

Dr. Julian H. Steward, anthropologist, continued his activities as editor of the Handbook of South American Indians, one of the Smithsonian projects conducted under funds transferred from the State Department for "Cooperation with the American Republics." He also prepared a number of articles for publication in the Handbook. The Handbook, which is three-fourths completed, will consist of four volumes of text and a two-volume bibliography. Material has been contributed to it by 100 specialists on the Indian tribes of Central and South America and the Antilles.

Dr. Steward took an active part in the creation of the Inter-American Society of Anthropology and Geography, the purpose of which is the development of cooperative anthropological and geographic research. Dr. Ralph L. Beals was appointed to take over the work of organizing and developing the society. The society has approximately 700 members throughout the Americas, and the first issue of its quarterly journal, *Acta Americana*, was in press at the close of the fiscal year.

Plans were developed for cooperative Institutes of Social Anthropology to assist in training students and in carrying on field work in the other American republics.

Dr. Steward served as a member of committees concerned with cooperative work in the field of inter-American relations and was a member of the Board of Governors of the National Indian Institute of the United States. He also represented the Smithsonian Institution at the inauguration of Dr. Everett Needham Case as president of Colgate University.

Dr. Alfred Métraux, ethnologist, continued his work as assistant to Dr. Julian H. Steward in preparing the Handbook of South American Indians. In addition to editing materials furnished by other contributors, Dr. Métraux completed a large amount of manuscript material of his own for use in the Handbook. Through an arrangement with the National University of Mexico, Dr. Métraux went to Mexico City to teach from March until the end of the fiscal year. During the year Dr. Métraux's paper entitled "The Native Tribes of Eastern Bolivia and Western Matto Grosso" was issued as Bulletin 134 of the Bureau.

During the fiscal year Dr. Henry B. Collins, Jr., ethnologist, was engaged in work relating to the war, for the most part in connection with the Ethnogeographic Board. Early in July 1942 Dr. Collins was detailed by the Secretary of the Smithsonian Institution and by the Chief of the Bureau to assist in handling requests for regional and other information received by the Ethnogeographic Board from the armed services and other war agencies. On February 28, 1943, he was elected Assistant Director of the Board and in this capacity continued in charge of research relating to the above-mentioned requests.

At the beginning of the fiscal year Dr. William N. Fenton, associate anthropologist, was engaged, at the request of the Pennsylvania Historical Commission, in a brief field trip among the Seneca Indians on the Cornplanter Grant in northwestern Pennsylvania. The object of this work was to collect Indian geographic names and traditions on hunting and fishing along the Allegheny River.

Following his return to Washington, Dr. Fenton devoted most of his time during the remainder of the year to projects received

by the Ethnogeographic Board from the armed services and other war agencies. One of the results of his work has been a strategic file of personnel in the United States familiar with foreign countries. Growing out of the Roster of Personnel, World Travel, and Special Knowledge Available to War Agencies at the Smithsonian Institution, as first compiled by the Smithsonian War Committee early in 1942, the present World File of Regional Specialists at the Ethnogeographic Board now includes over 2,500 names of individuals, their travel and special knowledge. Cross-indexed by name, as well as by country, this index has enabled the Director of the Board to locate promptly any person in response to requests from the armed forces for authorities who might possess unusual information, photographs, maps, and knowledge of languages of a given area. Certain officers as well as civilian specialists have returned repeatedly to the Smithsonian building to consult this file. In recognition of this work, in February Dr. Fenton was elected a research associate of the Ethnogeographic Board.

At the request of the War Department, Office of Chief of Engineers, to the Institution, Dr. Fenton delivered a lecture on "The Nature and Diversity of Human Culture" to a class in Psychology of Administration.

Dr. Fenton has continued membership on the Smithsonian War Committee, acting as its secretary.

Work on the Indian place names of western New York and western Pennsylvania has continued by correspondence with Messrs. M. H. Deardorff, Warren, Pa., and Chas. E. Congdon, of Salamanca, N. Y. At the end of the fiscal year, another correspondent, Dr. Elizabeth L. Moore, of Meredith College, had about completed the translation of J. F. Lafitau's *Moeurs des Sauvages Amériquains* (2 vols., Paris, 1724), a project reported last year.

Publications for the year include: Songs from the Iroquois Longhouse: Program Notes for an Album of American Indian Music from the Eastern Woodlands, published jointly by the Smithsonian Institution and the Library of Congress as vol. 6 of Folk Music of the United States (Archive of American Folk Song); Contacts between Iroquois Herbalism and Colonial Medicine, *in* Smithsonian Report for 1941; Last Seneca Pigeon Hunts, *in* Warren County Pennsylvania Almanac, 1943; and Fish Drives among the Cornplanter Seneca, *in* Pennsylvania Archaeologist; also several book reviews in professional and other journals. At the close of the fiscal year, the paper entitled "The Last Passenger Pigeon Hunts of the Cornplanter Senecas," which had been prepared with M. H. Deardorff for the Anthropological Papers of the Bureau, had been accepted for publication in the Journal of the Washington Academy of Sciences.

In December 1942 Dr. Philip Drucker, assistant ethnologist, received a commission in the United States Naval Reserve and was granted a military furlough. Dr. Drucker had spent the preceding portion of the fiscal year in preparing final reports on archeological work previously conducted in Mexico by the National Geographic Society-Smithsonian Institution archeological expeditions. These reports, in press at the end of the fiscal year, will appear as Bulletins of the Bureau.

#### SPECIAL RESEARCHES

Miss Frances Densmore, a collaborator of the Bureau, continued work on the study of Indian music by completing two large manuscripts—Seminole Music, and Music of Acoma, Isleta, Cochiti, and Zuñi Pueblos. She also devoted considerable time to a study of the traces of foreign influences in the music of the American Indians. During a portion of the year she was engaged in writing a handbook of the Smithsonian-Densmore collection of sound recordings of American Indian music for the National Archives.

Miss Densmore presented to the Bureau a record of her field work on Indian music and customs for the Bureau from 1907 to 1941, and completed the bibliography of her writings on that subject. She also presented the original phonograph record of a speech in the Ute language by the famous Ute chief Red Cap, made in 1916, and a similar record of a speech in the Yuma language by Kacora, made in 1922, with accompanying information.

In 1943 Miss Densmore completes 50 years' study of the music, customs, and history of the American Indians.

#### EDITORIAL WORK AND PUBLICATIONS

The editorial work of the Bureau continued during the year under the immediate direction of the editor, M. Helen Palmer. There were issued one Annual Report and three Bulletins, as follows:

Fifty-ninth Annual Report of the Bureau of American Ethnology, 1941-1942. 12 pp.

Bulletin 132. Source material on the history and ethnology of the Caddo Indians, by John R. Swanton. 332 pp., 19 pls., 5 text figs.

Bulletin 134. The native tribes of eastern Bolivia and western Matto Grosso, by Alfred Métraux. 182 pp., 5 pls., 1 text fig.

Bulletin 135. Origin myth of Acoma and other records, by Matthew W. Stirling. 123 pp., 17 pls., 8 text figs.

The following Bulletins were in press at the close of the fiscal year:

Bulletin 133. Anthropological papers, numbers 19-26:

No. 19. A search for songs among the Chitimacha Indians in Louisiana, by Frances Densmore.

- No. 20. Archeological survey on the northern Northwest Coast, by Philip Drucker. With appendix, Early vertebrate fauna of the British Columbia Coast, by Edna M. Fisher.
- No. 21. Some notes on a few sites in Beaufort County, South Carolina, by Regina Flannery.
- No. 22. An analysis and interpretation of the ceramic remains from two sites near Beaufort, South Carolina, by James B. Griffin.
- No. 23. The eastern Cherokees, by William Harlen Gilbert, Jr.
- No. 24. Aconite poison whaling in Asia and America: An Aleutian transfer to the New World, by Robert F. Heizer.
- No. 25. The Carrier Indians of the Bulkley River: Their social and religious life, by Diamond Jenness.
- No. 26. The quipu and Peruvian civilization, by John R. Swanton.
- Bulletin 136. Anthropological papers, numbers 27-32:
- No. 27. Music of the Indians of British Columbia, by Frances Densmore.
- No. 28. Choctaw music, by Frances Densmore.
- No. 29. Some ethnological data concerning one hundred Yucatan plants, by Morris Steggerda.
- No. 30. A description of thirty towns in Yucatan, Mexico, by Morris Steggerda.
- No. 31. Some western Shoshoni myths, by Julian H. Steward.
- No. 32. New material from Acoma, by Leslie A. White.
- Bulletin 137. The Indians of the southeastern United States, by John R. Swanton.
- Bulletin 138. Stone monuments of southern Mexico, by Matthew W. Stirling.
- Bulletin 139. An introduction to the ceramics of Tres Zapotes, Veracruz, Mexico, by C. W. Weiant.
- Bulletin 140. Ceramic sequences at Tres Zapotes, Veracruz, Mexico, by Philip Drucker.
- Bulletin 141. Ceramic stratigraphy at Cerro de las Mesas, by Philip Drucker.
- Bulletin 142. The contemporary culture of the Cáhita Indians, by Ralph L. Beals.

Publications distributed totaled 10,793.

#### LIBRARY

Accessions during the fiscal year totaled 321. There has been a sharp decrease in all classes of accessions, owing to reduced funds in the case of purchases and to war conditions in the case of gifts and exchanges.

The Library of Congress cards for nonserial matter on hand at the beginning of the fiscal year, amounting to several thousand, have been prepared and filed. Cards for foreign periodicals and society transactions have been prepared and filed, including shelf-list cards. A record of holdings appears on each of these shelf-list entries and some are now in their permanent form.

Several thousand pamphlets, including a number of valuable ones pertaining to the Indian Territory and the Five Civilized Tribes, were reclassified and reshelfed.

The library has been much in use as a source of material for the Ethnogeographic Board and the war agencies.



## ILLUSTRATIONS

During the year E. G. Cassedy, illustrator, continued the preparation of illustrations, maps, and drawings for the publications of the Bureau and for those of other branches of the Institution.

## COLLECTIONS

Collections transferred by the Bureau of American Ethnology to the department of anthropology, United States National Museum, during the fiscal year were as follows:

*Accession  
number*

162682. Archeological materials collected at Tres Zapotes, Tuxtla District, southern Veracruz, Mexico, during the winters of 1938-39 and 1939-40 by the National Geographic Society-Smithsonian Institution expedition under M. W. Stirling. (1,359 specimens.)
163712. 14 ethnological specimens originally obtained by C. Spencer from the Payamino Indians, eastern Ecuador, and 3 archeological specimens from excavations along the Napo River in the vicinity of Eden, Ecuador. (17 specimens.)
165123. Stone ax blade and 5 bark-cloth dance masks collected by Dr. Irving Goldman from the Kобеua (Cubeo) Indians, southeastern Colombia. (6 specimens.)

## MISCELLANEOUS

During the course of the year information was furnished by members of the Bureau staff in reply to numerous inquiries concerning the North American Indians, both past and present, and the Mexican peoples of the prehistoric and early historic periods. Various specimens sent to the Bureau were identified and data on them furnished for their owners.

*Personnel.*—Indefinite furloughs for military service were granted to Dr. Philip Drucker and Walter B. Greenwood on December 31, 1942, and January 15, 1943, respectively; Miss Nancy A. Link was appointed editorial clerk in connection with the preparation of the Handbook of South American Indians on August 15, 1942, by transfer from the Bureau, and resigned on January 23, 1943; Mrs. Eloise B. Edelen was appointed editorial assistant on August 24, 1942, on the Bureau roll; John E. Anglim was appointed senior illustrator for the Handbook on August 12, 1942, and resigned on April 21, 1943, to be inducted into the Army; Mrs. Verne E. Samson was appointed editorial clerk for the Handbook on December 22, 1942; Mrs. Ruth S. Abramson resigned as assistant clerk-stenographer on May 28, 1943.

Respectfully submitted.

M. W. STIRLING, *Chief.*

DR. C. G. ABBOT,  
*Secretary, Smithsonian Institution.*

## APPENDIX 6

### REPORT ON THE INTERNATIONAL EXCHANGE SERVICE

SIR: I have the honor to submit the following report on the activities of the International Exchange Service for the fiscal year ended June 30, 1943:

From the appropriation "General Expenses, Smithsonian Institution" there was allocated for the expenses of the Service \$45,808. This amount was reduced by the Bureau of the Budget by setting aside a reserve of \$10,000, making the sum available \$35,808. This latter included \$928 to meet within-grade promotions to certain employees as provided for by the Ramspeck Act.

In addition to the above, \$1,500 was allotted to the Institution by the Department of State from a special Congressional appropriation to that Department for carrying on its work of promoting the cultural relations between the United States and other American republics. The money transferred to the Institution was used by the Exchange Service to send packages of publications by mail directly to their destinations in Argentina and Brazil, the only countries in South America with which there are no reciprocal arrangements for the exchange of publications under governmental frank.

The number of packages received during the year for distribution at home and abroad was 513,460, a decrease from last year of 47,691. These packages weighed a total of 248,648 pounds, a decrease of 77,758 pounds. This material is classified as follows:

	Packages		Weight	
	Sent	Received	Sent	Received
			<i>Pounds</i>	<i>Pounds</i>
United States parliamentary documents sent abroad.....	390, 777	-----	128, 325	-----
Publications received in return for parliamentary documents.....		873		2, 529
United States departmental documents sent abroad.....	59, 664	-----	49, 803	-----
Publications received in return for departmental documents.....		907		2, 403
Miscellaneous scientific and literary publications sent abroad.....	56, 654	-----	58, 621	-----
Miscellaneous scientific and literary publications received from abroad for distribution in the United States.....		4, 585		8, 967
Total.....	507, 095	6, 365	234, 749	13, 899
Grand total.....	513, 460		248, 648	

Packages are forwarded abroad partly by freight to exchange bureaus for distribution, and partly by mail directly to their destina-

tions. The number of boxes shipped abroad was 643, an increase over last year of 44 boxes. Of these, 418 were for depositories of full sets of United States governmental documents, and 225 were for depositories of partial sets and for various establishments and individuals abroad. The number of packages sent by mail was 100,074.

As has been stated in previous reports, the war has made it necessary for the Institution to suspend shipments to many foreign countries. However, since last year's report was issued, shipping conditions have improved sufficiently to make it possible to add a few countries in the Eastern Hemisphere to those to which consignments are being transmitted. The countries to which shipments were being made at the close of the fiscal year 1943 were as follows:

Eastern Hemisphere:

- Great Britain and Northern Ireland.
- Republic of Ireland (formerly Irish Free State).
- Portugal.
- Union of Soviet Socialist Republics.
- Union of South Africa.
- India.
- Australia.
- New Zealand.

Western Hemisphere: All countries.

It was stated in the last report that packages for places in the Western Hemisphere were sent by mail and that there was some delay in transit due to examination of their contents by the censor. The Office of Censorship has been good enough to make special arrangements whereby packages mailed abroad by the Smithsonian Institution now pass the postal censor with little delay.

#### FOREIGN DEPOSITORIES OF GOVERNMENTAL DOCUMENTS

The number of sets of United States official publications received for transmission abroad through the International Exchange Service is 91 (55 full and 36 partial sets). On account of war conditions it is possible at this time to forward only 54 of these sets. The remaining 37 sets are being withheld for the duration.

Through arrangements with the Librarian of Congress, the large number of boxes of governmental documents that had accumulated at the Institution and were overtaxing the limited space here, are now stored in the Library of Congress.

The partial-set depository of the Dominican Republic has been changed to the Library of the University of Santo Domingo, and the depository in Paraguay, to the Ministry of Foreign Affairs, Library Section, Asunción.

A complete list of the depositories follows. Under present war conditions, consignments are forwarded only to those countries listed on the previous page.

DEPOSITORIES OF FULL SETS

- ARGENTINA:** Dirección de Investigaciones, Archivo, Biblioteca y Legislación Extranjera, Ministerio de Relaciones Exteriores y Culto, Buenos Aires.
- AUSTRALIA:** Commonwealth Parliament and National Library, Canberra.
- NEW SOUTH WALES:** Public Library of New South Wales, Sydney.
- QUEENSLAND:** Parliamentary Library, Brisbane.
- SOUTH AUSTRALIA:** Public Library of South Australia, Adelaide.
- TASMANIA:** Parliamentary Library, Hobart.
- VICTORIA:** Public Library of Victoria, Melbourne.
- WESTERN AUSTRALIA:** Public Library of Western Australia, Perth.
- BELGIUM:** Bibliothèque Royale, Bruxelles.
- BRAZIL:** Instituto Nacional do Livro, Rio de Janeiro.
- CANADA:** Library of Parliament, Ottawa.
- MANITOBA:** Provincial Library, Winnipeg.
- ONTARIO:** Legislative Library, Toronto.
- QUEBEC:** Library of the Legislature of the Province of Quebec.
- CHILE:** Biblioteca Nacional, Santiago.
- CHINA:** Bureau of International Exchange, Ministry of Education, Chungking.
- COLOMBIA:** Biblioteca Nacional, Bogotá.
- COSTA RICA:** Oficina de Depósito y Canje Internacional de Publicaciones, San José.
- CUBA:** Ministerio de Estado, Canje Internacional, Habana.
- CZECHOSLOVAKIA:** Bibliothèque de l'Assemblée Nationale, Prague.
- DENMARK:** Kongelige Danske Videnskaberne Selskab, Copenhagen.
- EGYPT:** Bureau des Publications, Ministère des Finances, Cairo.
- ESTONIA:** Riigiraamatukogu (State Library), Tallinn.
- FINLAND:** Parliamentary Library, Helsinki.
- FRANCE:** Bibliothèque Nationale, Paris.
- GERMANY:** Reichstauschstelle im Reichsministerium für Wissenschaft, Erziehung und Volksbildung, Berlin, N. W. 7.
- PRUSSIA:** Preussische Staatsbibliothek, Berlin, N. W. 7.
- GREAT BRITAIN:**
- ENGLAND:** British Museum, London.
- LONDON:** London School of Economics and Political Science. (Depository of the London County Council.)
- HUNGARY:** Library, Hungarian House of Delegates, Budapest.
- INDIA:** Imperial Library, Calcutta.
- IRELAND:** National Library of Ireland, Dublin.
- ITALY:** Ministero dell'Educazione Nazionale, Rome.
- JAPAN:** Imperial Library of Japan, Tokyo.
- LATVIA:** Bibliothèque d'État, Riga.
- LEAGUE OF NATIONS:** Library of the League of Nations, Geneva, Switzerland.
- MEXICO:** Dirección General de Información, Secretaría de Gobernación, Mexico, D. F.
- NETHERLANDS:** Royal Library, The Hague.
- NEW ZEALAND:** General Assembly Library, Wellington.
- NORTHERN IRELAND:** H. M. Stationery Office, Belfast.

- NORWAY:** Universitets-Bibliothek, Oslo. (Depository of the Government of Norway.)
- PERU:** Sección de Propaganda y Publicaciones, Ministerio de Relaciones Exteriores, Lima.
- POLAND:** Bibliothèque Nationale, Warsaw.
- PORTUGAL:** Biblioteca Nacional, Lisbon.
- RUMANIA:** Academia Română, Bucharest.
- SPAIN:** Cambio Internacional de Publicaciones, Avenida de Calvo Sotelo 20, Madrid.
- SWEDEN:** Kungliga Biblioteket, Stockholm.
- SWITZERLAND:** Bibliothéque Centrale Fédérale, Berne.
- TURKEY:** Department of Printing and Engraving, Ministry of Education, Istanbul.
- UNION OF SOUTH AFRICA:** State Library, Pretoria, Transvaal.
- UNION OF SOVIET SOCIALIST REPUBLICS:** All-Union Lenin Library, Moscow 115.
- UKRAINE:** Ukrainian Society for Cultural Relations with Foreign Countries, Kiev.
- URUGUAY:** Oficina de Canje Internacional de Publicaciones, Montevideo.
- VENEZUELA:** Biblioteca Nacional, Caracas.
- YUGOSLAVIA:** Ministère de l'Éducation, Belgrade.

## DEPOSITORIES OF PARTIAL SETS

- AFGHANISTAN:** Ministry of Foreign Affairs, Publications Department, Kabul.
- BOLIVIA:** Biblioteca del Ministerio de Relaciones Exteriores y Culto, La Paz.
- BRAZIL:**  
**MINAS GERAES:** Directoria Geral de Estatistica em Minas, Bello Horizonte.
- BRITISH GUIANA:** Government Secretary's Office, Georgetown, Demerara.
- CANADA:**  
**ALBERTA:** Provincial Library, Edmonton.  
**BRITISH COLUMBIA:** Provincial Library, Victoria.  
**NEW BRUNSWICK:** Legislative Library, Fredericton.  
**NOVA SCOTIA:** Provincial Secretary of Nova Scotia, Halifax.  
**PRINCE EDWARD ISLAND:** Legislative and Public Library, Charlottetown.  
**SASKATCHEWAN:** Legislative Library, Regina.
- CEYLON:** Chief Secretary's Office, Record Department of the Library, Colombo.
- CHINA:** National Library of Peiping.
- DOMINICAN REPUBLIC:** Biblioteca de la Universidad de Santo Domingo, Ciudad Trujillo.
- ECUADOR:** Biblioteca Nacional, Quito.
- GUATEMALA:** Biblioteca Nacional, Guatemala.
- HAITI:** Bibliothéque Nationale, Port-au-Prince.
- HONDURAS:**  
 Biblioteca y Archivo Nacionales, Tegucigalpa.  
 Ministerio de Relaciones Exteriores, Tegucigalpa.
- ICELAND:** National Library, Reykjavik.
- INDIA:**  
**BENGAL:** Secretary, Bengal Legislative Council Department, Council House, Calcutta.  
**BIHAR AND ORISSA:** Revenue Department, Patna.  
**BOMBAY:** Undersecretary to the Government of Bombay, General Department, Bombay.  
**BURMA:** Secretary to the Government of Burma, Education Department, Rangoon.

**PUNJAB:** Chief Secretary to the Government of the Punjab, Lahore.

**UNITED PROVINCES OF AGRA AND OUDH:** University of Allahabad, Allahabad.

**JAMAICA:** Colonial Secretary, Kingston.

**LIBERIA:** Department of State, Monrovia.

**MALTA:** Minister for the Treasury, Valleta.

**NEWFOUNDLAND:** Department of Home Affairs, St. John's.

**NICARAGUA:** Ministerio de Relaciones Exteriores, Managua.

**PANAMA:** Ministerio de Relaciones Exteriores, Panama.

**PARAGUAY:** Ministerio de Relaciones Exteriores, Sección Biblioteca, Asunción.

**SALVADOR:**

Biblioteca Nacional, San Salvador.

Ministerio de Relaciones Exteriores, San Salvador.

**THAILAND:** Department of Foreign Affairs, Bangkok.

**VATICAN CITY:** Biblioteca Apostolica Vaticana, Vatican City, Italy.

#### INTERPARLIAMENTARY EXCHANGE OF THE OFFICIAL JOURNAL

In the last report it was stated that the sending of the daily issues of the Congressional Record and the Federal Register was discontinued in April 1942, at the request of the Office of Censorship. The ban placed on the forwarding of these journals was lifted in February 1943, and the regular transmission of the Record and the Register were resumed. Copies of the back numbers were forwarded, in order that the series of the journals would be complete in the files of the depositories. The number of copies of each of these journals delivered to the Institution for this interparliamentary exchange was reduced from 71 to 58—the number that it was possible to forward under the curtailed operations of the Service.

The Biblioteca Benjamin Franklin, Mexico, D. F., was added to those countries receiving the Record and Register. A list of the countries to which these journals are now being forwarded follows:

#### DEPOSITORIES OF CONGRESSIONAL RECORD

##### ARGENTINA:

Biblioteca del Congreso Nacional, Buenos Aires.

Cámara de Diputados, Oficina de Información Parlamentaria, Buenos Aires.

Boletín Oficial de la República Argentina, Ministerio de Justicia e Instrucción Pública, Buenos Aires.

##### AUSTRALIA:

Commonwealth Parliament and National Library, Canberra.

**NEW SOUTH WALES:** Library of Parliament of New South Wales, Sydney.

**QUEENSLAND:** Chief Secretary's Office, Brisbane.

**WESTERN AUSTRALIA:** Library of Parliament of Western Australia, Perth.

##### BRAZIL:

Biblioteca do Congresso Nacional, Rio de Janeiro.

**AMAZONAS:** Archivo, Biblioteca e Imprensa Publica, Manaus.

**BAHIA:** Governador do Estado da Bahia, São Salvador.

**ESPIRITO SANTO:** Presidencia do Estado do Espirito Santo, Victoria.

**RIO GRANDE DO SUL:** "A Federação," Porto Alegre.

**SERGIPE:** Biblioteca Publica do Estado de Sergipe, Aracajú.

**SÃO PAULO:** Diario Oficial do Estado de São Paulo, São Paulo.

**BRITISH HONDURAS:** Colonial Secretary, Belize.

**CANADA:**

Library of Parliament, Ottawa.

Clerk of the Senate, Houses of Parliament, Ottawa.

**CUBA:** Biblioteca del Capitolio, Habana.

**GREAT BRITAIN:** Library of the Foreign Office, London.

**GUATEMALA:** Biblioteca de la Asamblea Legislativa, Guatemala.

**HAITI:** Bibliothèque Nationale, Port-au-Prince.

**HONDURAS:** Biblioteca del Congreso Nacional, Tegucigalpa.

**INDIA:** Legislative Department, Simla.

**IRISH FREE STATE:** Dail Eireann, Dublin.

**MEXICO:**

Dirección General de Información, Secretaría de Gobernación, Mexico, D. F.

Biblioteca Benjamin Franklin, Mexico, D. F.

**AGUASCALIENTES:** Gobernador del Estado de Aguascalientes, Aguascalientes.

**CAMPECHE:** Gobernador del Estado de Campeche, Campeche.

**CHIAPAS:** Gobernador del Estado de Chiapas, Tuxtla Gutierrez.

**CHIHUAHUA:** Gobernador del Estado de Chihuahua, Chihuahua.

**COAHUILA:** Periódico Oficial del Estado de Coahuila, Palacio de Gobierno, Saltillo.

**COLIMA:** Gobernador del Estado de Colima, Colima.

**DURANGO:** Gobernador Constitucional del Estado de Durango, Durango.

**GUANAJUATO:** Secretaría General de Gobierno del Estado, Guanajuato.

**GUERRERO:** Gobernador del Estado de Guerrero, Chilpancingo.

**JALISCO:** Biblioteca del Estado, Guadalajara.

**LOWER CALIFORNIA:** Gobernador del Distrito Norte, Mexicali.

**MÉXICO:** Gaceta del Gobierno, Toluca.

**MICHOACÁN:** Secretaría General de Gobierno del Estado de Michoacán, Morelia.

**MORELOS:** Palacio de Gobierno, Cuernavaca.

**NAYARIT:** Gobernador de Nayarit, Tepic.

**NEUVO LEÓN:** Biblioteca del Estado, Monterrey.

**OAXACA:** Periódico Oficial, Palacio de Gobierno, Oaxaca.

**PUEBLA:** Secretaría General de Gobierno, Puebla.

**QUERÉTARO:** Secretaría General de Gobierno, Sección de Archivo, Querétaro.

**SAN LUIS POTOSÍ:** Congreso del Estado, San Luis Potosí.

**SINALOA:** Gobernador del Estado de Sinaloa, Culiacán.

**SONORA:** Gobernador del Estado de Sonora, Hermosillo.

**TABASCO:** Secretaría General de Gobierno, Sección 3a, Ramo de Prensa, Villahermosa.

**TAMAULIPAS:** Secretaría General de Gobierno, Victoria.

**TLAXCALA:** Secretaría de Gobierno del Estado, Tlaxcala.

**VERACRUZ:** Gobernador del Estado de Veracruz, Departamento de Gobernación y Justicia, Jalapa.

**YUCATÁN:** Gobernador del Estado de Yucatán, Mérida.

**NEW ZEALAND:** General Assembly Library, Wellington.

**PERU:** Cámara de Diputados, Lima.

**UNION OF SOUTH AFRICA:**

Library of Parliament, Cape Town, Cape of Good Hope.

State Library, Pretoria, Transvaal.

**URUGUAY:** Diario Oficial, Calle Florida 1178, Montevideo.

**VENEZUELA:** Biblioteca del Congreso, Caracas.

## FOREIGN EXCHANGE AGENCIES

As a matter of information for those making use of the facilities of the International Exchange Service in the distribution of their publications in India, it should be stated that since the inauguration of the Provincial Autonomy authorized in the Government of India Act of 1935 (which did not come into force until several years thereafter), the Superintendent of Government Printing and Stationery in Bombay no longer acts as the distributing exchange agency for British India, which work it had conducted since 1918. Except in a few instances where the governments of other provinces reimburse the Bombay Agency for expenses incurred in transmitting publications to governmental offices, the exchange activities of the Superintendent of Government Printing and Stationery now are confined to the distribution of packages in the Province of Bombay. To other provinces packages are sent direct from Washington by mail.

There is given below a list of bureaus or agencies to which consignments are forwarded in boxes by freight when the Service is in full operation. To all countries not appearing in the list, packages are sent to their destinations through the mails. As stated previously, shipments are sent during wartime only to the agencies in those countries listed on page 57.

## LIST OF AGENCIES

ALGERIA, via France.

ANGOLA, via Portugal.

AZORES, via Portugal.

BELGIUM: Service Belge des Échanges Internationaux, Bibliothèque Royale de Belgique, Bruxelles.

CANARY ISLANDS, via Spain.

CHINA: Bureau of International Exchange, Ministry of Education, Chungking.

CZECHOSLOVAKIA: Service des Échanges Internationaux, Bibliothèque de l'Assemblée Nationale, Prague 1-79.

DENMARK: Service Danois des Échanges Internationaux, Kongelige Danske Videnskabernes Selskab, Copenhagen V.

EGYPT: Government Press, Publications Office, Bulaq, Cairo.

FINLAND: Delegation of the Scientific Societies of Finland, Kasärngatan 24, Helsinki.

FRANCE: Service Français des Échanges Internationaux, 110 Rue de Grenelle, Paris.

GERMANY: Amerika-Institut, Universitätstrasse 8, Berlin, N. W. 7.

GREAT BRITAIN AND IRELAND: Wheldon & Wesley, 721 North Circular Road, Willesden, London, N. W. 2.

HUNGARY: Hungarian Libraries Board, Ferenciektere 5, Budapest, IV.

INDIA: Superintendent of Government Printing and Stationery, Bombay.

ITALY: Ufficio degli Scambi Internazionali, Ministero dell'Educazione Nazionale, Rome.

JAPAN: International Exchange Service, Imperial Library of Japan, Uyeno Park, Tokyo.



**LATVIA:** Service des Échanges Internationaux, Bibliothèque d'État de Lettonie, Riga.

**LUXEMBOURG,** via Belgium.

**MADAGASCAR,** via France.

**MADEIRA,** via Portugal.

**MOZAMBIQUE,** via Portugal.

**NETHERLANDS:** International Exchange Bureau of the Netherlands, Royal Library, The Hague.

**NEW SOUTH WALES:** Public Library of New South Wales, Sydney.

**NEW ZEALAND:** General Assembly Library, Wellington.

**NORWAY:** Service Norvégien des Échanges Internationaux, Bibliothèque de l'Université Royale, Oslo.

**PALESTINE:** Jewish National and University Library, Jerusalem.

**POLAND:** Service Polonais des Échanges Internationaux, Bibliothèque Nationale, Warsaw.

**PORTUGAL:** Secção de Trocas Internacionaes, Biblioteca Nacional, Lisbon.

**QUEENSLAND:** Bureau of Exchanges of International Publications, Chief Secretary's Office, Brisbane.

**RUMANIA:** Ministère de la Propagande Nationale, Service des Échanges Internationaux, Bucharest.

**SOUTH AUSTRALIA:** South Australian Government Exchanges Bureau, Government Printing and Stationery Office, Adelaide.

**SPAIN:** Junta de Intercambio y Adquisición de Libros y Revistas para Bibliotecas Públicas, Ministerio de Educación Nacional, Avenida Calvo Sotelo, 20, Madrid.

**SWEDEN:** Kungliga Biblioteket, Stockholm.

**SWITZERLAND:** Service Suisse des Échanges Internationaux, Bibliothèque Centrale Fédérale, Berne.

**TASMANIA:** Secretary to the Premier, Hobart.

**TURKEY:** Ministry of Education, Department of Printing and Engraving, Istanbul.

**UNION OF SOUTH AFRICA:** Government Printing and Stationery Office, Cape Town, Cape of Good Hope.

**UNION OF SOVIET SOCIALIST REPUBLICS:** International Book Exchange Department, Society for Cultural Relations with Foreign Countries, Moscow, 56.

**VICTORIA:** Public Library of Victoria, Melbourne.

**WESTERN AUSTRALIA:** Public Library of Western Australia, Perth.

**YUGOSLAVIA:** Section des Échanges Internationaux, Ministère des Affaires Étrangères, Belgrade.

C. W. Shoemaker, Chief Clerk of the Exchanges until his retirement in November 1941, died on January 6, 1943. Mr. Shoemaker had been with the Institution 59 years. He had a translating knowledge of many languages and, in addition to his duties as Chief Clerk, served as translator for the Smithsonian and its branches.

Mrs. Mary D. Gass, clerk-stenographer in the International Exchanges for over 18 years, was transferred to the Translating Bureau of the Department of State June 21, 1943.

John W. Cusick, assistant clerk in the International Exchanges, was retired November 30, 1942, after having been with this office for over 17 years. Prior to his appointment in the Exchanges, he

was a guard in the National Museum. Mr. Cusick was a veteran of many wars, having served in the Spanish-American War, the Vera Cruz Campaign, the Philippine Insurrection, and the First World War. Mr. Cusick died at Marathon, N. Y., on June 30, 1943.

Paul M. Carey, skilled laborer, was granted military leave on August 12, 1942, for the purpose of enlisting in the armed forces of the United States.

Leigh Lisker, translator, having been drafted, was granted military leave March 22, 1943.

Respectfully submitted.

F. E. GASS, *Acting Chief Clerk.*

DR. C. G. ABBOT,

*Secretary, Smithsonian Institution.*

## APPENDIX 7

### REPORT ON THE NATIONAL ZOOLOGICAL PARK

SIR: I have the honor to submit the following report on the operations of the National Zoological Park for the fiscal year ended June 30, 1943:

The regular appropriation made by Congress was \$261,510, all of which was expended. Legislation that became effective during the year provided for salary increase in certain classes and grades and for overtime payments for increased hours of work. This resulted in a considerable increase in cost for personal services, which, however, was largely offset by savings through delay in filling positions or failure to fill them, as well as by savings in regular operating costs and special items. As a result, the deficiency amounted to only \$7,690, which was supplied through the Urgent Deficiency Appropriation Act, 1943.

Money was provided in the 1943 Appropriation Act for the construction of an incinerator and for the purchase of two trucks, but priorities could not be obtained. Plans and specifications were completed for the incinerator, and the project will go forward as soon as funds and materials are available.

The primary function of the Zoo is to exhibit a wide variety of animal life in the best possible condition, and in order to accomplish this aim under wartime conditions it was necessary to curtail all phases of maintenance work about the Zoo that could be slighted without harm to the animals. In this way it has been possible to keep the Zoo going in a satisfactory manner in spite of the shortages of manpower, food, and materials incident to wartime.

Because of the longer evenings due to the change to war time, the time of closing the Zoo buildings and gates has been delayed 1 hour, the opening hour remaining the same. It is believed that this lengthening of hours in the evening has materially contributed to the enjoyment of the Zoo by the public.

#### PERSONNEL

As in most other agencies, there has been a considerable personnel turn-over at the Zoo, several employees having gone into agencies more directly concerned with the war and others having gone else-

where or retired. In spite of efforts to fill vacancies, many positions have remained unfilled for some time. The abolition of the Saturday half-holiday, however, has made it less difficult to maintain fairly adequate care of the Zoo.

#### MAINTENANCE AND IMPROVEMENTS

No extensive improvements have been attempted during the year. Activities have been confined to maintenance work, and because of the difficulty in obtaining critical materials this has frequently been of a temporary or makeshift nature. Many things that should be done have been postponed until circumstances are more propitious.

#### NEEDS OF THE ZOO

The needs of the Zoo remain the same as outlined in previous reports. On account of war conditions no request is being made for unusual expenditures at this time.

#### VISITORS FOR THE YEAR

The attendance for the year was:

July	250,000	February	108,600
August	204,400	March	148,150
September	202,800	April	269,050
October	169,300	May	186,200
November	186,800	June	140,650
December	37,600		
January	70,950	Total	1,974,500

The sharp curtailment in driving occasioned by gasoline rationing, tire mileage restrictions, and the prohibition against pleasure driving brought about a drastic reduction in the number of visitors coming to the Zoo by automobile, but an increased number of visitors walked or came by bus and streetcar.

In previous years a census has been made each day of the cars parked in the Zoo at about 3 p. m., for the purpose of determining the proportional attendance by States, Territories, and foreign countries. Owing, however, to the almost total cessation of automobile traffic to the Zoo, the record from such a census would have been of no value during the past year. It may be pointed out that in the previous year District of Columbia cars comprised about 39 percent; Maryland, 22 percent; Virginia, 15 percent; Pennsylvania, 4 percent; the remaining 20 percent were from other States, Territories, and foreign countries.

Prior to the curtailment of automobile and bus travel, numerous groups and classes came to the Zoo from a distance of several hundred miles. Of course these have been almost completely eliminated, and there has been a reduction in the number of groups and classes from

Maryland, Virginia, and the District, although this attendance has held up fairly well.

Many of the wartime residents in Washington who have not previously had an opportunity to visit a large zoo, now take their rest and recreation in the National Zoo. The ease of reaching the Park and the fact that it is open every day practically from daylight to dark and without cost enable many people to obtain relaxation they could not otherwise enjoy. Service men and women constitute a substantial proportion of the visitors. It is plain to be seen that many of the service people anticipating going overseas are endeavoring to learn something of the animal life that they might find in the region to which they may be sent. There is also an increasing attendance by servicemen recuperating from injuries or sickness.

Medical groups have come to the Zoo specifically for the purpose of studying certain types of animals and to receive instruction regarding snakes. The Zoo officials receive many requests from various agencies of the Government including the War and Navy Departments for information to assist them on biological problems.

The Zoo continues to be a regular study ground for art and biology classes, as well as an important focal point for letters, telephone calls, and queries regarding care of animals, their behavior, and methods to be followed in preventing or remedying injuries from animals.

#### AIR-RAID PRECAUTIONS

As pointed out in the last report, it is anticipated that in the event of air raids the Zoo will be one of the safest places in the city. However, plans were made and have been kept up to date for meeting such contingencies as may arise in the event of air raids or other emergencies.

#### ACQUISITION OF SPECIMENS

Specimens are usually acquired by purchase, gift, deposit, exchange, natural reproduction, or collecting expeditions by members of the Zoo staff. Conditions have prevented travel by the Zoo personnel for collecting specimens, and the customary array of animals offered for sale by animal dealers has been greatly reduced both in kinds and numbers; therefore the importance of gifts and deposits is relatively greater than before. The return of members of the armed forces from foreign lands has resulted in a gratifying number of gifts of small animals that have been picked up by these persons as pets or specifically for the Zoo. When Army and Navy personnel evince an interest before going abroad in obtaining specimens for the Zoo, efforts are made to arrange for importation permits to facilitate entry of the animals into this country. Such permits are required by a law which

rigidly excludes all animals except under permit in order that this country may be properly safeguarded against introduction of animals or disease pests that might become serious menaces.

#### GIFTS

Among the gifts to the Zoo, the following may be mentioned as particularly prized accessions:

*Mammals.*—Two Bailey's lynx from the Fish and Wildlife Service, through Louis H. Laney, Albuquerque, N. Mex.; a white-tailed doe from Mrs. A. C. Henry, East Falls Church, Va.; two polar bear cubs from the Greenland Administration, through Henrik de Kauffman, Envoy Extraordinary and Minister Plenipotentiary for Denmark in Washington, and Tage Nielsen, manager of the Danish Consulate General, Greenland Section, New York; a woolly monkey from Mrs. Jenny Shifflette, Washington, D. C.

*Birds.*—A Leadbeater's cockatoo from Judith R. Shearer, Orange, Va.; two mute swans from Mrs. Eleanor Patterson, Washington, D. C.; a peafowl from H. S. Rawdon, Bethesda, Md.; two Nepal kallege from Lowry Riggs, Rockville, Md.; a cheer pheasant from Charles Denley, Washington, D. C.

The Hershey Estates Zoo presented 80 specimens.

The full list of donors and their gifts follows:

#### DONORS AND THEIR GIFTS

- Clinton P. Anderson, Bethesda, Md., red salamander.
- Miss Ann Bartlett, Washington, D. C., worm snake.
- Dr. Paul Bartsch, Washington, D. C., Cuban conure.
- Charles Beck, Fredericksburg, Va., bald eagle.
- Dr. Edgar Beckley, Washington, D. C., snapping turtle.
- Mickey Bing, Washington, D. C., Pekin duck.
- Mrs. Raymond Bittinger, Ridgeley, W. Va., 2 rhesus monkeys.
- Miss M. Bitzmann, Washington, D. C., horned lizard.
- Morris M. Brown, Colonial Beach, Va., ring-billed gull.
- Mrs. L. D. Buford, Washington, D. C., fence lizard.
- B. Harrison Carl, Cumberland, Md., alligator.
- Mrs. H. F. Clark, Washington, D. C., 5 guinea pigs.
- Mrs. H. G. Clark, Washington, D. C., sparrow hawk.
- Miss Arlene Cole, Route 2, Arlington, Va., Pekin duck.
- J. A. Connolly, Washington, D. C., black widow spider.
- L. E. Cronin, College Park, Md., through John N. Hamlet, Cooper's hawk.
- Mrs. Anna Davis, Baltimore, Md., common marmoset.
- Charles Denley, Washington, D. C., cheer pheasant.
- Marguerite Dent and Patricia Swive, Washington, D. C., Pekin duck.
- Robey Dodson, Washington, D. C., South American gray fox.
- J. R. Earle, Arlington, Va., raccoon.
- Billy and Dick Eckert, Washington, D. C., 2 white rabbits.
- Dr. J. C. Eckhardt, Washington, D. C., zebra finch.

- 'T. Ellery, Washington, D. C., 4 sparrow hawks.  
 Fish and Wildlife Service, through Louis H. Laney, Albuquerque, N. Mex.,  
 2 Bailey's lynx.  
 Miss Fisher, Washington, D. C., orange-winged parrot.  
 P. Ford, Martinsville, Va., albino raccoon.  
 J. A. Fowler, Washington, D. C., 2 pilot snakes, black snake, 10 painted turtles,  
 4 snapping turtles, 4 spotted turtles, 4 mud turtles, 4 Carolina box tortoises.  
 Janet and Lynn Fulmer, Washington, D. C., 2 common rabbits.  
 E. W. Gentz, College Park, Md., 4 flying squirrels.  
 G. M. Gooch, Washington, D. C., red-tailed hawk.  
 Spencer Gordon, Washington, D. C., 2 angel fish.  
 Mrs. Goy, Washington, D. C., gray fox.  
 Greenland Administration, through Henrik de Kauffman, Envoy Extraordinary  
 and Minister Plenipotentiary for Denmark in Washington, and Tage Nielsen,  
 manager of the Danish Consulate General, Greenland Section, New York,  
 2 polar bear cubs.  
 Mrs. F. G. Guttenplan, Washington, D. C., alligator.  
 E. H. Halbach, Washington, D. C., opossum.  
 Mrs. Haltsman (address unrecorded), common goat.  
 Mrs. A. V. Hanson, Washington, D. C., yellow-naped parrot.  
 Maury Hanson, Jr., Bethesda, Md., screech owl.  
 Mrs. Haughwout, Colmar Manor, Md., barred owl.  
 Mrs. S. T. Hellman, Washington, D. C., 2 guinea pigs.  
 Mrs. A. C. Henry, East Falls Church, Va., Virginia deer.  
 Hershey Estates Zoo, Hershey, Pa., snowy owl, sea lion, prehensile-tailed por-  
 cupine, 7 spotted turtles, 7 snapping turtles, 2 Cumberland terrapins, 10 box  
 turtles, 10 wood turtles, 1 South American turtle, 2 hinge-back turtles, 5  
 western painted turtles, brown terrapin, American crocodile, 4 ball pythons,  
 Curtis or blood python, 2 Surinam toads, 6 red-bellied newts, giant land snail,  
 smooth-clawed frog, giant salamander, rainbow boa, Cook's tree boa, Barbour's  
 map turtle, green tree snake, boa constrictor, 4 Gila monsters, 2 spiny-tailed  
 iguanas, common iguana, 2 Brahmany kites, douroucouli.  
 Mrs. Hertsch, Cabin John, Md., Javan macaque.  
 W. E. Hopper, Arlington, Va., 2 common rabbits.  
 Mrs. G. T. Hugo, Mount Rainier, Md., yellow-naped parrot.  
 Donald Humphrey, Washington, D. C., yellow chicken snake.  
 J. N. Jacobson, Alexandria, Va., alligator.  
 Walter Johnson, Washington, D. C., 2 toads.  
 William A. Johnson, Washington, D. C., 2 zebra finches.  
 Mrs. Victor Kayne, Washington, D. C., 3 horned lizards.  
 James Kelly, Washington, D. C., common rabbit.  
 James King, Mount Rainier, Md., alligator.  
 W. A. King, Brownsville, Tex., 6 blue honeycreepers.  
 King-Smith Studio School, Washington, D. C., opossum.  
 Rear Admiral Emory S. Land, Washington, D. C., red-shouldered hawk.  
 Otto Martin Locke, New Braunfels, Tex., 3 nine-banded armadillos, 105 horned  
 lizards.  
 Jane Lynch, Washington, D. C., 2 alligators.  
 Sergeant Lynch, Bolling Field, D. C., nine-banded armadillo.  
 J. H. MacElhose, Washington, D. C., 12 black mollies, 3 guppies, 3 snails, 1  
 catfish.

- Mrs. M. K. Macknet, Takoma Park, Md., opossum.  
 Mrs. Gladys Mahler, Silver Spring, Md., alligator.  
 Franklin Mallory, Washington, D. C., 7 common newts.  
 Jacob Manoogian, Washington, D. C., opossum.  
 Brian McDonald, Arlington, Va., collared turtle dove.  
 Mrs. Thomas McVeary, Washington, D. C., yellow-headed parrot.  
 Sgt. Wilson McVey, Maryland State Police, sooty mangabey.  
 Mrs. John Meatale, Washington, D. C., 2 strawberry finches.  
 M. Miller, Washington, D. C., 2 Cooper's hawks.  
 Michael Miller, Washington, D. C., Pekin duck.  
 Mrs. H. M. Mitchell, Washington, D. C., 2 Pekin ducks.  
 Mrs. T. J. Moody, Leesburg, Va., red fox.  
 H. A. Morse, Washington, D. C., 2 guinea pigs.  
 Mrs. J. C. Myers, Chevy Chase, Md., Pekin duck.  
 Señor Dr. Don Francisco Castillo Nájera, Mexican Ambassador, Washington, D. C., capuchin.  
 National Institute of Health, Bethesda, Md., woodchuck.  
 John Nicholas, Berwyn, Md., rhesus monkey.  
 Mrs. R. P. Oliver, Falls Church, Va., weeping capuchin.  
 Mrs. Eleanor Patterson, Washington, D. C., 2 mute swans, 17 mallard ducks.  
 Senator Claude Pepper, Washington, D. C., alligator.  
 Mrs. M. W. Pettigrew, Washington, D. C., white rabbit.  
 Mrs. Polhamus, Chevy Chase, Md., common rabbit.  
 Dr. Hans F. Prausnitz, Washington, D. C., false chameleon, soft-shelled turtle, common snapping turtle, painted turtle, mud turtle.  
 Mrs. A. M. Raeger, Washington, D. C., white-fronted parrot.  
 Wayne Randel, Washington, D. C., 2 Central American boas.  
 H. S. Rawdon, Bethesda, Md., peafowl.  
 Lowry Riggs, Rockville, Md., 2 Nepal kallege, 4 red jungle fowl, 2 cheer pheasant, 3 white ring-necked pheasant, 4 silver pheasant, Swinhoe's pheasant, 2 Japanese long-tailed fowl, American black bear, alligator.  
 Mrs. E. Rogg, Washington, D. C., alligator.  
 Mrs. V. H. Rohwer, Arlington, Va., grass paroquet.  
 Miss D. Roland, Washington, D. C., 2 Pekin ducks.  
 Mrs. E. H. Russell, Washington, D. C., diamond-back terrapin.  
 Mrs. R. Sadler, Chevy Chase, Md., 2 muscovy ducks.  
 Miss Thelma Selle, Washington, D. C., Pekin robin.  
 Judith R. Shearer, Orange, Va., Leadbeater's cockatoo.  
 Mrs. Jenny Shifflette, Washington, D. C., woolly monkey.  
 Donald G. Shook, National Geographic Society, Washington, D. C., copperhead.  
 E. W. Sisks, Washington, D. C., alligator.  
 C. E. Smith, Arlington, Va., common marmoset, titi monkey.  
 Mrs. Homer R. Spence, Washington, D. C., gray capuchin.  
 L. Thomas, McLean, Va., American bittern.  
 Robert Thompson, Washington, D. C., great horned owl.  
 Dr. R. Truitt, College Park, Md., pied-billed grebe.  
 United States Coast Guard, Washington, D. C., 2 red foxes.  
 R. J. Werner, Isaac Walton League, Washington, D. C., mallard duck.  
 Mrs. W. H. Wetmore, Washington, D. C., 2 Pekin ducks.  
 E. T. White, Norfolk, Va., screech owl.  
 Mrs. H. Whitelow, Washington, D. C., alligator.  
 Mrs. J. H. Wilkins, Washington, D. C., canary.  
 Mrs. P. Yahraes, Washington, D. C., grass parakeet.



Tom Yahraes, Washington, D. C., timber rattlesnake, bull snake.  
 Mrs. Gertrude Zeppenfeld, Pittsburgh, Pa., rhesus monkey.  
 C. D. Zimmerman, Chevy Chase, Md., canary.

## NATURAL REPRODUCTION

Although the Zoo does not have ideal conditions for animals to raise their young in captivity, there is generally a fairly satisfactory increase from births and hatchings. During the year 101 mammals were born and 83 birds were hatched. Noteworthy among the former was a litter of five woolless sheep, an unusually large litter; unfortunately, none of the little ones lived. There were also births among the reptiles which, however, are not recorded.

The births and hatchings are listed below :

## MAMMALS

<i>Scientific name</i>	<i>Common name</i>	<i>Number</i>
<i>Ammotragus lervia</i> .....	Aoudad.....	3
<i>Axis axis</i> .....	Axis deer.....	1
<i>Bibos gaurus</i> .....	Gaur.....	1
<i>Bison bison</i> .....	American bison.....	2
<i>Bos taurus</i> .....	British Park cattle.....	1
<i>Canis rufus</i> .....	Texas red wolf.....	7
<i>Cephalophus niger</i> .....	Black duiker.....	1
<i>Cervus canadensis</i> .....	Elk.....	1
<i>Cervus elaphus</i> .....	Red deer.....	3
<i>Choeropsis liberiensis</i> .....	Pygmy hippopotamus.....	2
<i>Choloepus didactylus</i> .....	Two-toed sloth.....	1
<i>Cynomys ludovicianus</i> .....	Prairie dog.....	26
<i>Dama dama</i> .....	Fallow deer.....	2
<i>Dama dama</i> .....	White fallow deer.....	1
<i>Dendrolagus inustus</i> .....	Tree kangaroo.....	1
<i>Dolichotis magellanica</i> .....	Patagonian cavy.....	2
<i>Felis onca</i> .....	Jaguar.....	1
<i>Felis tigris</i> .....	Bengal tiger.....	4
<i>Hemitragus jemlahicus</i> .....	Tahr.....	2
<i>Hippopotamus amphibius</i> .....	Hippopotamus.....	1
<i>Lama glama</i> .....	Llama.....	1
<i>Lama pacos</i> .....	Alpaca.....	1
<i>Magus maurus</i> .....	Moor macaque.....	1
<i>Mephitis nigra</i> .....	Skunk.....	5
<i>Myocastor coypu</i> .....	Coypu.....	6
<i>Nasua narica</i> .....	Coatimundi.....	2
<i>Neotoma floridana</i> .....	Florida wood rat.....	2
<i>Ovis aries</i> .....	Woolless sheep.....	5
<i>Poepagus grunniens</i> .....	Yak.....	3
<i>Pseudois nayaur</i> .....	Blue sheep.....	1
<i>Sika sika</i> .....	Sika deer.....	1
<i>Synceros caffer</i> .....	African buffalo.....	1
<i>Tapirus terrestris</i> .....	South American tapir.....	1
<i>Urocyon cinereoargenteus</i> .....	Gray fox.....	1

## BIRDS

Scientific name	Common name	Number
<i>Anas platyrhynchos</i> .....	Mallard duck.....	23
<i>Anas rubripes</i> .....	Black duck.....	4
<i>Branta canadensis</i> .....	Canada goose.....	8
<i>Branta canadensis minima</i> .....	Cackling goose.....	4
<i>Branta canadensis occidentalis</i> .....	White-cheeked goose.....	12
<i>Cairina moschata</i> .....	Muscovy duck.....	5
<i>Fulica americana</i> .....	Coot.....	7
<i>Gallus gallus</i> .....	Red jungle fowl.....	6
<i>Larus novaehollandiae</i> .....	Silver gull.....	1
<i>Nycticorax nycticorax naevius</i> .....	Black-crowned night heron.....	12
<i>Serinus canarius</i> .....	Canary.....	1

## DEPOSITS

The more outstandingly interesting and desirable animals that were deposited during the year were a spectacled bear, the first ever exhibited in this Zoo, deposited by Louis Ruhe, Inc.; a beautiful West African guenon monkey, which we have so far been unable to identify, deposited by H. Allender; a great gray kangaroo deposited by H. B. Harris; a wallaby and a West African palm civet deposited by H. L. Shaw; a group of four yellow-handed tamarins and seven marmosets deposited by Miss Martha G. Hunter; a West African crowned hawk-eagle deposited by Louis Ruhe, Inc., and another specimen of the same species deposited by C. P. Haskins; an electric eel, Indian python, and several regal pythons, including one unusually large specimen that weighs 320 pounds, all deposited by Clif Wilson.

## EXCHANGES

Among the more desirable animals received by exchange were two cape hyraces obtained from the Philadelphia Zoo, five Dybowsky deer, and one tahr goat.

## PURCHASES

The more outstanding animals obtained by purchase included a pair of woolless domestic or Barbados sheep which are natives of West Africa; a laughing falcon; and a pair of klipspringers, a remarkable little antelope from southern and eastern Africa.

The Hershey Estates Zoo at Hershey, Pa., which depended for its attendance on people coming by automobile, suffered such a sharp curtailment in number of visitors that the management decided to dispose of most of its stock, which permitted us to obtain from that organization a number of interesting and desirable additions.

## REMOVALS

Reductions in the collection are due to deaths, return of animals on deposit, and exchanges. During the year the more noteworthy losses by death were:

## MAMMALS

<i>Atilax paludinosus</i> .....	West African water civet.
<i>Camelus bactrianus</i> .....	Arabian camel.
<i>Cephalophus nigrifrons</i> .....	Black-fronted duiker.
<i>Choeropsis liberiensis</i> .....	Pygmy hippopotamus.
<i>Erythrocebus patas</i> .....	Patas monkey.
<i>Felis tigris</i> .....	Bengal tiger (male).
<i>Hippopotamus amphibius</i> .....	Baby hippopotamus.
<i>Hystrix galeata</i> .....	African porcupine that had been in the collection since October 1926.
<i>Macaca silenus</i> .....	Wanderoo monkey.
<i>Mandrillus leucophaeus</i> .....	Drill baboon, in the collection since 1916.
<i>Muntiacus sinensis</i> .....	Chinese barking deer, in the collection since 1934.
<i>Nycticebus coucang</i> .....	Slow loris, received in 1937 from Smithsonian Institution-National Geographic Society Expedition.
<i>Pongo abelii</i> .....	Sumatran orangutan ("Susie").
<i>Pseudois nayaur</i> .....	Blue sheep.
<i>Tragulus javanicus</i> .....	Javan mouse deer, in the collection since 1937.
<i>Ursus thibetanus</i> .....	Himalayan bear.

## BIRDS

<i>Kakatoe tenuirostris</i> .....	Slender-billed cockatoo.
<i>Sagittarius serpentarius</i> .....	Secretary bird.
<i>Stephanoaetus coronatus</i> .....	Crowned hawk-eagle.
<i>Struthio camelus</i> .....	Ostrich, received October 16, 1921, from U. S. Poultry Experiment Station, Bureau of Animal Industry, Glendale, Ariz.
<i>Vultur gryphus</i> .....	South American condor.

## REPTILES

<i>Testudo vicina</i> .....	Galápagos tortoise.
-----------------------------	---------------------

## FISHES

<i>Electrophorus electricus</i> .....	Electric eel.
---------------------------------------	---------------

## SPECIES NEW TO THE HISTORY OF THE COLLECTION

Despite the few animals purchased and the factors militating against obtaining outstanding additions, the Zoo was fortunate enough to obtain six species never before in the collection. These were a spec-

tacled bear (*Tremarctos ornatus*), which inhabits an indefinitely outlined range in the northern Andes and is very rare in captivity; a pair of klipspringers (*Oreotragus saltator*), a beautiful little cliff-inhabiting antelope that originally ranged from southern Africa to Abyssinia; five Dybowsky deer (*Sika hortulorum*), which inhabit Manchuria; one laughing falcon (*Herpetotheres cachinnans*), a beautifully marked falcon of medium size that inhabits the forested parts of tropical America from Mexico to northern Argentina; two quetzals (*Pharomachrus mocinno*), the state bird of Guatemala, which inhabits the higher mountains from Guatemala to Panama; and a white starling (*Graculipica melanopectera*), which inhabits Java and is rare in captivity.

*Statement of accessions*

How acquired	Mammals	Birds	Reptiles	Amphibians	Fishes	Invertebrates	Total
Presented.....	64	91	228	20	18	5	426
Born or hatched.....	101	83					184
Received in exchange.....	13	7	17				37
Purchased.....	11	116	10		24		161
On deposit.....	31	9	10		3		53
<b>Total.....</b>	<b>220</b>	<b>306</b>	<b>265</b>	<b>20</b>	<b>45</b>	<b>5</b>	<b>861</b>

*Summary*

Animals on hand July 1, 1942.....	2,411
Accessions during the year.....	861
<hr/>	
Total animals in collection during year.....	3,272
Removals from collection by death, exchange, and return of animals on deposit.....	837
<hr/>	
In collection June 30, 1943.....	2,435

*Status of collection*

Class	Species and sub-species	Individuals	Class	Species and sub-species	Individuals
Mammals.....	204	664	Insects.....	1	100
Birds.....	329	912	Mollusks.....	1	1
Reptiles.....	96	380	Crustaceans.....	1	2
Amphibians.....	15	69			
Fishes.....	36	306	<b>Total.....</b>	<b>684</b>	<b>2,435</b>
Arachnids.....	1	1			

Respectfully submitted.

W. M. MANN, *Director.*

DR. C. G. ABBOT,  
*Secretary, Smithsonian Institution.*

## APPENDIX 8

### REPORT ON THE ASTROPHYSICAL OBSERVATORY

SIR: I have the honor to submit the following report on the activities of the Astrophysical Observatory, including the Division of Astrophysical Research and the Division of Radiation and Organisms, for the fiscal year ended June 30, 1943:

#### DIVISION OF ASTROPHYSICAL RESEARCH

The study of the solar-constant values published in March 1942 as table 24, volume 6 of the Annals of the Observatory, confirmed the discovery that the variation of the sun's output, seemingly irregular, is really made up of numerous regular periodicities, all being closely aliquot parts of 273 months. By combining their influences a prediction was made of the march of solar variation from 1939 through the year 1945. This appears in figure 14 of volume 6 of the Annals.

In this way it was shown that the years 1940 to 1947 would probably be the most interesting and important years to study the sun's variation since the early twenties. As the Smithsonian Astrophysical Observatory is the only agency in the world which follows the variation of the sun's output of radiation, it therefore seemed of extreme importance to keep the record unbroken through these critical years. Hence, despite demands of the war manpower situation, every available means has been used to keep the three field observatories at Montezuma, Chile, Table Mountain, Calif., and Tyrone, N. Mex., in operation. Thus far these efforts have been successful, notwithstanding the loss of three experienced observers from a total field staff of six.

Considerable progress has been made at Washington in the study of short-interval changes of the solar radiation in their relation to weather. As first shown in Smithsonian publications Nos. 3392 and 3397 in the year 1936, the sun's short-interval variations, though averaging only 0.7 percent, are important elements, even governing elements, in weather. The weather effects of individual solar changes are found to last at least 2 weeks. These studies of the year 1936 have been repeated this year employing the improved and enlarged "solar constant" data published as table 24, volume 6 of our Annals. The new results are even more convincing than the provisional ones just referred to. They have been extended to deal with the weather of several cities in different parts of the world, for both temperature and barometric pressure. It is expected to publish soon on this subject.

At Washington two computers have continued reductions of solar-constant observations, but have not, of course, been able to keep up to date with the results, inasmuch as these computers were also called

on frequently for work relating to war problems assigned by the Army and the Navy, or requested by outside agencies engaged in war work. It is hoped that with the return to Washington of Mr. Hoover, who has been carrying on measures at Tyrone Observatory for 2 years, the solar-constant computations can be pushed along more rapidly so as to disclose the remarkable changes of solar radiation expected for the years 1940 onward, as referred to above.

Most of the time of Messrs. Abbot, Aldrich, and Kramer has been devoted to problems assigned by the war services on which no report can be made at this time.

*Personnel.*—Mr. and Mrs. A. F. Moore completed their term of service at Montezuma. Mr. F. A. Greeley succeeded Mr. Moore in June 1943 as field director there with Mrs. F. A. Greeley as his assistant. Mr. Stanley C. Warner continued as field director at Table Mountain with Mr. Kenneth G. Bower as assistant. Mr. W. H. Hoover acted as field director at Tyrone Observatory. Mr. Alfred G. Froiland, bolometric assistant there, was inducted into the army in June 1943, after which Mr. Hoover carried on alone. Mr. Moore will take over at Tyrone, and Mr. Hoover will return to Washington. No changes in personnel occurred at Washington.

#### DIVISION OF RADIATION AND ORGANISMS

(Report prepared by Dr. Earl S. Johnston, Assistant Director)

The regular research program of the Division was discontinued early in August. Since that date practically the entire time of the members of the Division has been directed toward solving problems relative to the Nation's war activities. By far the largest percentage of this work has dealt with problems submitted by the Naval Research Laboratory. Because of the nature of some of this work, it is obvious that a detailed report cannot be submitted at this time. The personnel and laboratory equipment of the Division was such that adaptation to this new work in physics, chemistry, and biology was very readily made. However, the efficiency of the Division as a unit has been decreased somewhat through loss of personnel.

At the request of the Annual Review of Biochemistry, a review article on photosynthesis was prepared last summer by Dr. Johnston of the Division and Dr. Jack E. Myers of the University of Texas. This paper has now been published in volume 12 of the Review.

*Personnel.*—On August 1, Mrs. Phyllis W. Prescott, the junior clerk-stenographer for the Division, was transferred to the administrative office as assistant clerk-stenographer.

Respectfully submitted.

C. G. ABBOT, *Director.*

THE SECRETARY,  
*Smithsonian Institution.*

## APPENDIX 9

### REPORT ON THE LIBRARY

SIR: I have the honor to submit the following report on the activities of the Smithsonian library for the fiscal year ended June 30, 1943:

Intensification of the war effort, so evident throughout the whole Institution, has been both reflected in, and shared by, the library during the difficult year just past.

The library has been confronted by two major responsibilities that have motivated its work: How best to adjust policies and adapt procedures to wartime changes and demands, and how to maintain, as far as possible, the basic continuity of the collections.

Urgent as is the first of these, experience during and following the First World War has shown that the second cannot be neglected without serious weakening of the library's service to the Institution. In wartime, normal growth is inevitably diminished, and a certain amount of change of emphasis in acquiring material is necessary and even desirable, but the responsibility that the library has for implementing the deep-rooted and continuing work of a scientific institution cannot be overlooked even in an emergency of the present heroic proportions.

#### WAR WORK

Never before in the history of the library have its collections and its staff been called upon to give aid in so many different kinds of research, virtually all of which were concerned in some way with the war effort. Regular use of the library by the scientific staff of the Institution has been almost entirely in connection with the war, and more than 35 of the war agencies have made many direct inquiries, have borrowed more than 500 books, and have sent research workers, some of them for extended periods of time, to use the collections. Indirectly too, through the use of the library by the staff of the Ethnogeographic Board, still other of the war agencies have been represented. Rich in certain kinds of geographical and related material, and in ethnological works, the branch libraries of the National Museum and the Bureau of American Ethnology especially, have been constantly visited and called upon by war workers.

It has been most gratifying to find that the Institution has not infrequently been able to supply data of urgent importance that could not be found elsewhere.

The index of foreign geographical illustrations begun last year as a special war service and originally planned to cover only the publications of the Institution itself was later enlarged, at the request of the Smithsonian War Committee, to include files of selected journals on special subjects containing incidental geographical illustrations likely to be overlooked in any routine search for pictures. The selection of these journals was made by the scientific staff of the Institution and the indexing was done in their offices, the library serving as the coordinator and keeper of the file, which now contains more than 12,000 entries.

As another aid to the war agencies in making use of the library, the librarian prepared a brief account of its resources, mimeographed copies of which were distributed to key personnel in Washington and elsewhere by the Ethnogeographic Board.

The cordial response of the whole Institution to the library's plea for books in the Nation-wide Victory book drive for men and women in the armed services, is worthy of record. More than 500 fine clean copies of highly readable contemporary books were contributed.

It may be of interest to note here the transfer to the Library of Congress of an uncataloged collection of miscellaneous war pamphlets accumulated by the library during the First World War. This collection, numbering some 3,000 pieces, largely the so-called ephemera of the period, though valuable as historical source material, had no direct bearing on the scientific work of the Institution.

#### ACCESSIONS

Receipt of foreign publications dropped somewhat, but not nearly so sharply as during the preceding year, after shipments from enemy and occupied countries ceased. Through the International Exchange Service, 355 packages, or only 70 fewer than last year, were delivered. Even this decline was more apparent than real, for a good many foreign serials came directly by mail. Fortunately there have been comparatively few actual losses, and not many prolonged delays in the arrival of the most important of those scientific serials that are still being published in the allied and neutral countries, though some of the foreign institutions and societies are postponing shipment of their publications until after the war. The maintenance of both the quantity and quality of scientific publication at a high level among our war-torn allies abroad is worthy of remark.

The publication and receipt of domestic scientific serials continued to be practically normal.

In the Museum library an accession of special importance was a selection of 250 books and 2,300 separates and pamphlets, mostly on the subject of reptiles, from the library of the late Dr. Leonhard Stejneger.



Received in the sectional library of the division of fishes, by transfer from the Fish and Wildlife Service of the Department of the Interior, was the large collection of manuscript records of the dredging and hydrographic stations of the U. S. F. S. S. *Albatross* and other fisheries vessels.

By regular and special exchange, and by purchase, considerable progress has been made in filling gaps in the serial sets, some of them of long standing, and in strengthening certain collections on special subjects, for example, the published results of scientific surveys and travels. The importance of such material, always apparent, especially in connection with the work of the curators in the Museum, has been doubly emphasized by the increased wartime demand for it both within and from outside the Institution.

One of the larger special exchanges of duplicates, with the Marine Biological Laboratory at Woods Hole, yielded a good many parts of periodicals needed in the Museum library, while from Cooper Union came 35 publications on art for the National Collection of Fine Arts library.

Among purchases, wartime deviations from the normal have been the unusually large number of requests for atlases, descriptive geographies, and foreign-language dictionaries.

#### GIFTS

There have been a number of especially notable gifts during the year. One that is invaluable in itself, and noteworthy as well for being the library's first considerable accession of microfilmed material, was the very generous gift of the Linnean Society of London of the records of its Linnean collections and manuscripts, the copying of which was made possible by a grant to the society from the Carnegie Corporation. This is one of two sets deposited in American libraries, the Arnold Arboretum of Harvard University having received the other. We are much indebted to Dr. Elmer D. Merrill, the administrator of botanical collections there, for his good offices in arranging the whole matter. All the actual specimens in the Linnean herbarium are said to be covered in the 60,000 exposures of the set, as well as records of the mollusks, fishes, and insects, of various manuscripts, and those of Linneaus' own publications to which he had added corrections and emendations.

To accompany the very fine collection of arms and armor given by him to the Museum, Ralph G. Packard presented also his collection of 350 books on the subject, many of them rare and beautiful volumes.

The sectional library of the division of marine invertebrates received another special collection of great usefulness in connection with specimens previously received from the donor, by the bequest of the late

Dr. Frank Smith of his working library of oligochaete literature, 1,103 pieces in all.

A unique gift to the sectional library of the division of minerals was a five-volume set of photomicrographs of meteoric irons presented by Dr. Stuart H. Perry.

As always, the Secretary, the Assistant Secretary, and many other members of the Smithsonian staff made generous contributions of books and papers. From the American Association for the Advancement of Science came 578 publications. Among other donors were the American Association of Museums, the American Committee for International Wild Life Protection, the American Wildlife Institute, Barton A. Bean, Mrs. Arthur S. Blum, Hon. Usher L. Burdick, the Detroit News, Haydn T. Giles, Daniel C. Haskell, J. Cramer Hudson, the International Association of Printing House Craftsmen, Mrs. Vera F. Lewis, Fritz Lugt, Dr. John P. Marble, Dr. Salvador Massip, Dr. Riley D. Moore, Olaf Nylander, W. J. Orchard, Hon. Chase S. Osborn and Miss Stella Brunt Osborn, the Pan American Union, the Pennsylvania Academy of Fine Arts, the Philadelphia College of Pharmacy and Science, Dr. A. E. Porsild, Dr. L. A. White.

#### CATALOGING

Cataloging of the regular inflow of current accessions was exceptionally well kept up under the handicap of the understaffing of the catalog division, but there was no time that could be devoted either to the older material so badly in need of attention, or even to some of the larger recent gifts of special collections. There are at least 15,000 uncataloged volumes in special collections scattered throughout the Institution, while in the Museum library many more thousands of volumes have never been cataloged by subject and are represented in the catalog only by antiquated author cards. The difficulty, or actual loss of use of much important material by this lack of adequate cataloging is a serious matter, and one that should receive first consideration in post-war planning of the library's work.

#### PERSONNEL

Changes in personnel were the retirement for disability of Miss Marian W. Seville, senior library assistant, on August 31, 1942, after many years of faithful service; the appointment of Miss Minna Gill as assistant librarian in charge of the catalog, on September 2, 1942; the appointment of Mrs. Daisy F. Bishop as under library assistant on February 17, 1943, and the resignation of Miss Marion Blair, junior clerk-typist, on April 21, 1943. Since January 21, 1943, W. B. Greenwood has been absent from the library of the Bureau of American Ethnology on military duty.

There were a number of promotions and reassignments to duties among the staff. Miss Anna Moore Link was given charge of the National Collection of Fine Arts library and Miss Elizabeth G. Moseley was promoted to Miss Link's former position in charge of the serial collections in the Museum library; Mrs. Hope H. Simmons was promoted to be assistant librarian in charge of accessions and Miss Marjorie R. Kunze was promoted to be chief assistant in the accessions division.

The loss of one position and the time lag in filling other vacancies have been serious obstacles in the way of keeping work up to date. The fine spirit of the whole staff in meeting emergencies, in taking on extra work, and in accepting temporary assignments to new or unaccustomed duties is much to be commended.

## STATISTICS

*Accessions*

	Volumes and pamphlets	Approximate holdings June 30, 1943		Volumes and pamphlets	Approximate holdings June 30, 1943
Astrophysical Observatory	276	10,675	National Museum	3,680	226,967
Bureau of American Ethnology	321	33,811	National Zoological Park	102	4,043
Freer Gallery of Art	165	16,531	Radiation and Organisms	13	619
Langley Aeronautical Library	17	3,592	Smithsonian Deposit	1,051	571,028
National Collection of Fine Arts	1,103	9,097	Smithsonian Office	227	31,282
			Total	6,955	1,907,645

<sup>1</sup> Neither incomplete volumes of periodicals nor separates and reprints from periodicals are included in these figures.

*Exchanges*

New exchanges arranged	159
38 of these were assigned to the Smithsonian Deposit.	
"Wants" received	3,631
549 of these were obtained to fill gaps in the Smithsonian Deposit sets.	

*Cataloging*

Volumes and pamphlets cataloged	5,012
Cards filed in catalogs and shelf lists	30,635

*Periodicals*

Periodical parts entered	11,756
--------------------------	--------

*Circulation*

Loans of books and periodicals	11,236
This figure does not include the very considerable intramural circulation of books and periodicals assigned to sectional libraries for filing, of which no count is kept.	

*Binding*

Volumes sent to the bindery	2,135
Respectfully submitted.	

LEILA F. CLARK, *Librarian.*

DR. C. G. ABBOT,

*Secretary, Smithsonian Institution.*

## APPENDIX 10

### REPORT ON PUBLICATIONS

SIR: I have the honor to submit the following report on the publications of the Smithsonian Institution and the Government branches under its administrative charge during the year ended June 30, 1943:

The Institution published during the year 13 papers in the Smithsonian Miscellaneous Collections, and title page and table of contents of volumes 101 and 103; 10 papers in the War Background Studies series; 1 Annual Report of the Board of Regents and pamphlet copies of 23 articles in the Report appendix, and 1 Annual Report of the Secretary; 2 special publications, and reprints of 2 volumes of the Smithsonian's series of tables.

The United States National Museum issued 1 Annual Report; 25 Proceedings papers; 3 Bulletins; 1 separate paper in the Bulletin series of Contributions from the United States National Herbarium.

The Bureau of American Ethnology issued 1 Annual Report and 3 Bulletins.

Of the publications there were distributed 194,057 copies, which included 21 volumes and separates of the Smithsonian Contributions to Knowledge, 37,732 volumes and separates of the Smithsonian Miscellaneous Collections, 24,986 volumes and separates of the Smithsonian Annual Reports, 60,464 War Background Studies papers, 2,529 Smithsonian special publications, 55,631 volumes and separates of National Museum publications, 10,793 publications of the Bureau of American Ethnology, 28 reports on the Harriman Alaska Expedition, 36 Annals of the Astrophysical Observatory, and 1,810 reports of the American Historical Association.

#### SMITHSONIAN MISCELLANEOUS COLLECTIONS

There were issued 2 papers and title page and table of contents of volume 101, 1 paper comprising volume 102, 10 papers and title page and table of contents of volume 103, as follows:

#### VOLUME 101

No. 16. The snow and ice algae of Alaska, by Erzsébet Kol. 36 pp., 6 pls., 5 figs. (Publ. 3683.) September 19, 1942.

No. 18. A new species of sand bug, *Blepharipoda doelloi*, from Argentina, by Waldo L. Schmitt. 10 pp., 1 pl. (Publ. 3687.) August 10, 1942.

Title page and table of contents. (Publ. 3695.) October 27, 1942.

## VOLUME 102

Compendium and description of the West Indies, by Antonio Vázquez de Espinosa, translated by Charles Upson Clark. 862 pp. (Publ. 3646.) September 1, 1942.

## VOLUME 103

No. 1. Distribution and variation of the Hawaiian tree snail *Achatinella apexfulva* Dixon in the Koolau Range, Oahu, by d'Alté A. Welch. 236 pp., 12 pls., 8 figs. (Publ. 3684.) December 16, 1942.

No. 2. The skeleto-muscular mechanisms of the honey bee, by R. E. Snodgrass. 120 pp., 32 figs. (Publ. 3688.) September 30, 1942.

No. 3. A revision of the Indo-Chinese forms of the avian genus *Prinia*, by H. G. Deignan. 12 pp. (Publ. 3689.) September 1, 1942.

No. 4. Archeological and geological investigations in the San Jon District, eastern New Mexico, by Frank H. H. Roberts, Jr. 30 pp., 9 pls., 3 figs. (Publ. 3692.) October 12, 1942.

No. 5. New Upper Cambrian trilobites, by Charles E. Resser. 136 pp., 21 pls. (Publ. 3693.) October 21, 1942.

No. 6. On the preparation and preservation of insects, with particular reference to Coleoptera, by J. Manson Valentine. 16 pp., 5 figs. (Publ. 3696.) November 21, 1942.

No. 7. The musculature of the labrum, labium, and pharyngeal region of adult and immature Coleoptera, by Carl Kester Dorsey. 42 pp., 24 pls. (Publ. 3697.) January 20, 1943.

No. 8. The 1914 tests of the Langley "aerodrome," by C. G. Abbot. 8 pp., 1 fig. (Publ. 3699.) October 24, 1942.

No. 9. Mystacocarida, a new order of Crustacea from intertidal beaches in Massachusetts and Connecticut, by Robert W. Pennak and Donald J. Zinn. 11 pp., 2 pls. (Publ. 3704.) February 23, 1943.

No. 10. A remarkable reversal in the distribution of storm frequency in the United States in double Hale solar cycles, of interest in long-range forecasting, by C. J. Kullmer. 20 pp., 19 figs., 10 storm-frequency year maps. (Publ. 3729.) April 5, 1943.

Title page and table of contents. (Publ. 3731.) June 9, 1943.

Additional copies of the following volume were printed:

## VOLUME 86

Smithsonian Meteorological Tables. Fifth Revised Edition. First Reprint. lxxxvi+282 pp. (Publ. 3116.)

## WAR BACKGROUND STUDIES

In the new series of Smithsonian publications, War Background Studies, Nos. 3-12, inclusive, were issued during the year. In order to list all the papers in this series, Nos. 1 and 2 are included, although they were issued toward the end of the previous fiscal year. Nos. 13-16 are also listed, although they had not actually been issued at the close of the year.

No. 1. Origin of the Far Eastern civilizations: A brief handbook, by Carl Whiting Bishop. 53 pp., 12 pls., 21 figs. (Publ. 3681.) June 10, 1942.

- No. 2. The evolution of nations, by John R. Swanton. 23 pp. (Publ. 3686.) June 24, 1942.
- No. 3. The peoples of the Soviet Union, by Aleš Hrdlička. 29 pp. (Publ. 3690.) July 15, 1942.
- No. 4. Peoples of the Philippines, by Herbert W. Krieger. 86 pp., 24 pls., 4 figs. (Publ. 3694.) November 13, 1942.
- No. 5. The natural-history background of camouflage, by Herbert Friedmann. 17 pp., 16 pls. (Publ. 3700.) December 11, 1942.
- No. 6. Polynesians—explorers of the Pacific, by J. E. Weckler, Jr. 77 pp., 20 pls., 2 figs. (Publ. 3701.) January 13, 1943.
- No. 7. The Japanese, by John F. Embree. 42 pp., 16 pls., 3 figs. (Publ. 3702.) January 23, 1943.
- No. 8. Siam—land of free men, by H. G. Deignan. 18 pp., 8 pls., 1 fig. (Publ. 3703.) February 5, 1943.
- No. 9. The native peoples of New Guinea, by M. W. Stirling. 25 pp., 28 pls., 1 fig. (Publ. 3726.) February 16, 1943.
- No. 10. Poisonous reptiles of the world: A wartime handbook, by Doris M. Cochran. 37 pp., 17 pls., 2 figs. (Publ. 3727.) March 19, 1943.
- No. 11. Egypt and the Suez Canal, by Frank H. H. Roberts, Jr. 68 pp., 25 pls., 1 fig. (Publ. 3728.) March 31, 1943.
- No. 12. Are wars inevitable? by John R. Swanton. 36 pp. (Publ. 3730.) May 11, 1943.

(Issued after the close of the fiscal year)

- No. 13. Alaska: America's continental frontier outpost, by Ernest P. Walker. 57 pp., 21 pls., 2 figs. (Publ. 3733.) July 8, 1943.
- No. 14. Islands and peoples of the Indies, by Raymond Kennedy. 66 pp., 21 pls., 7 figs. (Publ. 3734.) August 5, 1943.
- No. 15. Iceland and Greenland, by Austin H. Clark. 103 pp., 21 pls., 2 figs. (Publ. 3735.) August 19, 1943.
- No. 16. Island peoples of the western Pacific: Micronesia and Melanesia, by Herbert W. Krieger. 104 pp., 21 pls., 2 figs. (Publ. 3737.) September 15, 1943.

#### SMITHSONIAN ANNUAL REPORTS

*Report for 1941.*—The complete volume of the Annual Report of the Board of Regents for 1941 was received from the Public Printer in September 1942.

Annual Report of the Board of Regents of the Smithsonian Institution showing the operations, expenditures, and condition of the Institution for the year ended June 30, 1941. xiii+596 pp., 121 pls., 17 figs. (Publ. 3651.)

The general appendix contained the following papers:

- What lies between the stars? by Walter S. Adams.
- Artificial converters of solar energy, by H. C. Hottel.
- The new frontiers in the atom, by Ernest O. Lawrence.
- Science shaping American culture, by Arthur H. Compton.
- Mathematics and the sciences, by J. W. Lasley, Jr.
- The role of science in the electrical industry, by M. W. Smith.
- The new synthetic textile fibers, by Herbert R. Mauersberger.
- Plastics, by Gordon M. Kline.
- Vitamins and their occurrence in foods, by Hazel E. Munsell.
- Science and human prospects, by Eliot Blackwelder.
- Iceland, land of frost and fire, by Vigfus Einarsson.

The genes and the hope of mankind, by Bruce Bliven.

Care of captive animals, by Ernest P. Walker.

The influence of insects on the development of forest protection and forest management, by F. C. Craighead.

Growth hormones in plants, by Kenneth V. Thimann.

Useful algae, by Florence Meier Chase.

The excavations of Solomon's seaport: Ezion-geber, by Nelson Glueck.

Decipherment of the linguistic portion of the Maya hieroglyphs, by Benjamin Lee Whorf.

Contacts between Iroquois herbalism and colonial medicine, by William N. Fenton.

The study of Indian music, by Frances Densmore.

Snake bites and the Hopi Snake Dance, by M. W. Stirling.

The Eskimo child, by Aleš Hrdlička.

Wings for transportation (Recent developments in air transportation equipment), by Theodore P. Wright.

*Report for 1942.*—The Report of the Secretary, which included the financial report of the executive committee of the Board of Regents, and which will form part of the Annual Report of the Board of Regents to Congress, was issued in January 1943.

Report of the Secretary of the Smithsonian Institution and financial report of the executive committee of the Board of Regents for the year ended June 30, 1942. iii+112 pp. 2 pls. (Publ. 3698.)

The Report volume, containing the general appendix, was in press at the close of the year.

#### SPECIAL PUBLICATIONS

Songs from the Iroquois Longhouse: Program notes for an album of American Indian music from the eastern woodlands (issued by the Library of Congress), by William N. Fenton. 34 pp., 9 pls. (Publ. 3691.) September 11, 1942.

The Smithsonian Institution and the United States National Museum welcome the members of our armed forces. 4 pp. April 1943.

The following special publication was reprinted:

Smithsonian Mathematical Tables—hyperbolic functions, prepared by George F. Becker and C. E. Van Orstrand. Fifth reprint. lii+321 pp. (Publ. 1871.) August 21, 1942.

#### PUBLICATIONS OF THE UNITED STATES NATIONAL MUSEUM

The editorial work of the National Museum has continued during the year under the immediate direction of the editor, Paul H. Oehser. There were issued 1 Annual Report, 25 Proceedings papers, 3 Bulletins, and 1 separate paper in the Bulletin series of Contributions from the United States National Herbarium, as follows:

#### MUSEUM REPORT

Report on the progress and condition of the United States National Museum for the fiscal year ended June 30, 1942. iii+118 pp. January 1943.

#### PROCEEDINGS: VOLUME 88

Title page, table of contents, and index. Pp. i-viii, 587-615. August 18, 1942.

## VOLUME 89

Title page, table of contents, and index. Pp. i-ix, 583-620. November 28, 1942.

## VOLUME 90

Title page, table of contents, and index. Pp. i-vii, 553-581. December 18, 1942.

## VOLUME 91

No. 3131. Catalog of human crania in the United States National Museum collections: Eskimo in general, by Aleš Hrdlička. Pp. 169-429, fig. 39. August 1, 1942.

No. 3132. The species of *Aegla*, endemic South American fresh-water crustaceans, by Waldo L. Schmitt. Pp. 431-520, figs. 40-64, pls. 25-28. August 18, 1942.

## VOLUME 92

No. 3147. New species of bark beetles (Pityophthorini) from Mexico and tropical America (Coleoptera, Scolytidae), by M. W. Blackman. Pp. 177-228, pls. 20-23. November 25, 1942.

No. 3148. Osteology of *Polyglyphanodon*, an Upper Cretaceous lizard from Utah, by Charles W. Gilmore. Pp. 229-265, figs. 16-36, pls. 24-26. October 13, 1942.

No. 3149. Notes and new species of Microlepidoptera from Washington State, by J. F. Gates Clarke. Pp. 267-276, pls. 27-32. October 13, 1942.

No. 3150. The genotypes of some of Ashmead's genera of ichneumon-flies, by R. A. Cushman. Pp. 277-289. October 8, 1942.

No. 3151. New Neotropical insects of the apterygotan family Japygidae, by H. E. Ewing and Irving Fox. Pp. 291-299, pls. 33, 34. October 1, 1942.

No. 3152. The fresh-water fishes of Liberia, by Leonard P. Schultz. Pp. 301-348, fig. 37, pls. 35, 36. November 13, 1942.

No. 3153. Mexican herpetological miscellany, by Hobart M. Smith. Pp. 349-395, fig. 38, pl. 37. November 5, 1942.

No. 3154. Revision of the genus *Phloeosinus* Chapuis in North America (Coleoptera, Scolytidae), by M. W. Blackman. Pp. 397-474, pls. 38-41. December 21, 1942.

No. 3155. The Late Cenozoic vertebrate faunas from the San Pedro Valley, Ariz., by C. Lewis Gazin. Pp. 475-518, figs. 39-47, pls. 42, 43. December 10, 1942.

No. 3156. The type species of the genera and subgenera of bees, by Grace A. Sandhouse. Pp. 519-619. March 5, 1943.

## VOLUME 93

No. 3157. The Nearctic species of parasitic flies belonging to *Zenillia* and allied genera, by Wendell F. Sellers. Pp. 1-108. January 19, 1943.

No. 3158. A new fossil reptile from the Upper Cretaceous of Utah, by Charles W. Gilmore. Pp. 109-114, figs. 1-5. December 12, 1942.

No. 3159. Some American geometrid moths of the subfamily Ennominae heretofore associated with or closely related to *Ellopiopsis* Treitschke, by Hahn W. Capps. Pp. 115-151, pls. 1-10. February 24, 1943.

No. 3160. Skeletal remains with cultural associations from the Chicama, Moche, and Virú Valleys, Peru, by T. D. Stewart. Pp. 153-185, pls. 11-18. January 23, 1943.

No. 3161. New marine mollusks from the Antillean region, by Harald A. Rehder. Pp. 187-203, pls. 19, 20. January 20, 1943.



No. 3162. A new pest of *Albizia* in the District of Columbia (Lepidoptera: Glyphipterygidae), by J. F. Gates Clarke. Pp. 205-208, pls. 21-25. March 9, 1943.

No. 3163. Osteology of Upper Cretaceous lizards from Utah, with a description of a new species, by Charles W. Gilmore. Pp. 209-214, figs. 6-10. January 19, 1943.

No. 3164. The birds of southern Veracruz, Mexico, by Alexander Wetmore. Pp. 215-340, fig. 11, pls. 26-28. May 25, 1943.

No. 3165. New genera and species of bark beetles of the subfamily Micracinae (Scolytidae, Coleoptera), by M. W. Blackman. Pp. 341-365, pls. 29-30. March 22, 1943.

No. 3166. Notes on some barnacles from the Gulf of California, by Dora Priaulx Henry. Pp. 367-373, pl. 31. May 3, 1943.

#### BULLETINS

No. 180. Fishes of the Phoenix and Samoan Islands collected in 1939 during the expedition of the U. S. S. *Bushnell*, by Leonard P. Schultz. x+316 pp., 27 figs., 9 pls. January 20, 1943.

No. 181. The cyclophorid operculate land mollusks of America, by Carlos de la Torre, Paul Bartsch, and Joseph P. E. Morrison. iv+306 pp., 42 pls. August 21, 1942.

No. 182. Monograph of the West Indian beetles of the family Staphylinidae, by Richard E. Blackwelder. viii+658 pp., 3 figs., 19 maps. January 27, 1943.

#### CONTRIBUTIONS FROM THE UNITED STATES NATIONAL HERBARIUM

##### VOLUME 28

Title page, table of contents, and index. Pp. i-xii, 677-694. December 16, 1942.

#### PUBLICATIONS OF THE BUREAU OF AMERICAN ETHNOLOGY

The editorial work of the Bureau has continued under the immediate direction of the editor, M. Helen Palmer. During the year there were issued 1 Annual Report and 3 Bulletins, as follows:

##### REPORT

Fifty-ninth annual report of the Bureau of American Ethnology, 1941-42. 12 pp. January 30, 1943.

##### BULLETINS

132. Source material on the history and ethnology of the Caddo Indians, by John R. Swanton. 332 pp., 19 pls., 5 figs. January 16, 1943.

134. The native tribes of eastern Bolivia and western Matto Grosso, by Alfred Métraux. 182 pp., 5 pls., 1 fig. November 23, 1942.

135. Origin, myth of Acoma and other records, by Matthew W. Stirling. 123 pp., 17 pls., 8 figs. December 3, 1942.

#### REPORT OF THE AMERICAN HISTORICAL ASSOCIATION

The annual reports of the American Historical Association are transmitted by the Association to the Secretary of the Smithsonian

Institution and are communicated by him to Congress, as provided by the act of incorporation of the Association. The following reports were issued this year:

Annual report of the American Historical Association for the year 1936. Volume 3. Instructions to the British Ministers to the United States, 1791-1812.

Annual report of the American Historical Association for the year 1937. Volume 2. Writings in American History, 1937, 1938.

Annual Report of the American Historical Association for the year 1940. Proceedings.

Annual report of the American Historical Association for the year 1941. Volume 1. Proceedings; private letters from the British Embassy in Washington to the Foreign Secretary, Lord Granville, 1880-85; manuscript accessions. Volume 2. Talleyrand in America as a financial promoter, 1794-96. Volume 3. List of doctoral dissertations in history now in progress at universities in the United States and the Dominion of Canada.

The following were in press at the close of the fiscal year: Annual Report for 1942, volume 1 (Proceedings and list of members); volume 2 (Letters from the Berlin Embassy); volume 3 (The quest for political unity in world history).

#### REPORT OF THE NATIONAL SOCIETY, DAUGHTERS OF THE AMERICAN REVOLUTION

The manuscript of the Forty-fifth Annual Report of the National Society, Daughters of the American Revolution, was transmitted to Congress, in accordance with law, December 1, 1942.

#### ALLOTMENTS FOR PRINTING

The congressional allotments for the printing of the Smithsonian Annual Reports to Congress and the various publications of the Government bureaus under the administration of the Institution were virtually used up at the close of the year. The appropriation for the coming year ending June 30, 1944, totals \$88,500, allotted as follows:

Smithsonian Institution.....	\$16,000
National Museum.....	43,000
Bureau of American Ethnology.....	17,480
National Collection of Fine Arts.....	500
International Exchanges.....	200
National Zoological Park.....	200
Astrophysical Observatory.....	500
American Historical Association.....	10,620
Total .....	88,500

Respectfully submitted.

W. P. TRUE, *Chief, Editorial Division.*

Dr. C. G. ABBOT,

*Secretary, Smithsonian Institution.*

# REPORT OF THE EXECUTIVE COMMITTEE OF THE BOARD OF REGENTS OF THE SMITHSONIAN INSTITUTION

FOR THE YEAR ENDED JUNE 30, 1943

*To the Board of Regents of the Smithsonian Institution:*

Your executive committee respectfully submits the following report in relation to the funds of the Smithsonian Institution, together with a statement of the appropriations by Congress for the Government bureaus in the administrative charge of the Institution.

## SMITHSONIAN ENDOWMENT FUND

The original bequest of James Smithson was £104,960 8s. 6d.—\$508,318.46. Re-funds of money expended in prosecution of the claim, freights, insurance, etc., together with payment into the fund of the sum of £5,015, which had been withheld during the lifetime of Madame de la Batut, brought the fund to the amount of \$550,000.

Since the original bequest the Institution has received gifts from various sources chiefly in the years prior to 1893, the income from which may be used for the general work of the Institution. These are invested and stand on the books of the Institution as follows:

Avery, Robert S. and Lydia T., bequest fund-----	\$50,498.44
Endowment fund, from gifts, income, etc-----	272,549.65
Habel, Dr. S., bequest fund-----	500.00
Hachenberg, George P. and Caroline, bequest fund-----	3,942.03
Hamilton, James, bequest fund-----	2,895.70
Henry, Caroline, bequest fund-----	1,185.46
Hodgkins, Thomas G., fund-----	145,623.83
Parent fund-----	728,836.59
Rhees, William Jones, bequest fund-----	1,053.71
Sanford, George H., memorial fund-----	1,972.56
Witherspoon, Thomas A., memorial fund-----	126,491.58
Special fund-----	1,400.00

Total endowment for general work of the Institution----- 1,336,949.55

The Institution holds also a number of endowment gifts, the income of each being restricted to specific use. These are invested and stand on the books of the Institution as follows:

Abbott, William L., fund, bequest to the Institution-----	\$104,010.11
Arthur, James, fund, income for investigations and study of the sun and lecture on the sun-----	39,200.44

Bacon, Virginia Purdy, fund, for a traveling scholarship to investigate fauna of countries other than the United States.....	\$49,107.53
Baird, Lucy H., fund, for creating a memorial to Secretary Baird...	17,942.00
Barstow, Frederic D., fund, for purchase of animals for the Zoological Park.....	745.61
Canfield Collection fund, for increase and care of the Canfield collection of minerals.....	37,488.80
Casey, Thomas L., fund, for maintenance of the Casey collection and promotion of researches relating to Coleoptera.....	8,990.30
Chamberlain, Francis Lea, fund, for increase and promotion of Isaac Lea collection of gems and mollusks.....	27,602.19
Hillyer, Virgil, fund, for increase and care of Virgil Hillyer collection of lighting objects.....	6,441.94
Hitchcock, Dr. Albert S., Library fund, for care of Hitchcock Agrostological Library.....	1,448.66
Hodgkins fund, specific, for increase and diffusion of more exact knowledge in regard to nature and properties of atmospheric air.....	100,000.00
Hughes, Bruce, fund, to found Hughes alcove.....	18,761.82
Myer, Catherine Walden, fund, for purchase of first-class works of art for the use of, and benefit of, the National Collection of Fine Arts.....	18,580.22
National Collection of Fine Arts, Strong Bequest.....	9,799.76
Pell, Cornelia Livingston, fund, for maintenance of Alfred Duane Pell collection.....	7,265.59
Poore, Lucy T. and George W., fund, for general use of the Institution when principal amounts to the sum of \$250,000.....	88,009.95
Reid, Addison T., fund, for founding chair in biology in memory of Asher Tunis.....	29,764.02
Roebbling fund, for care, improvement, and increase of Roebbling collection of minerals.....	118,295.54
Rollins, Miriam and William, fund, for investigations in physics and chemistry.....	91,565.20
Smithsonian employees retirement fund.....	32,704.36
Springer, Frank, fund, for care, etc., of Springer collection and library.....	17,577.31
Walcott, Charles D. and Mary Vaux, research fund, for development of geological and paleontological studies and publishing results thereof.....	408,867.73
Younger, Helen Walcott, fund, held in trust.....	50,112.50
Zerbee, Frances Brincklé, fund, for endowment of aquaria.....	745.99
Special research fund, gift, in the form of real estate.....	20,946.00
<hr/>	
Total endowment for specific purposes other than Freer endowment.....	1,305,973.57

The above funds amount to a total of \$2,642,923.12, and are carried in the following investment accounts of the Institution:

U. S. Treasury deposit account, drawing 6 percent interest.....	\$1,000,000.00
Consolidated investment fund (income in table below).....	1,316,533.49
Real estate, mortgages, etc.....	274,877.13
Special funds, miscellaneous investments.....	51,512.50
<hr/>	
	2,642,923.12

## CONSOLIDATED FUND

*Statement of principal and income for the last 10 years*

Fiscal year	Capital	Income	Percent- age	Fiscal year	Capital	Income	Percent- age
1934.....	\$754, 570. 84	\$26, 650. 32	3. 66	1939.....	\$902, 801. 27	\$30, 710. 53	3. 40
1935.....	706, 765. 68	26, 808. 86	3. 79	1940.....	1, 081, 249. 25	38, 673. 29	3. 47
1936.....	723, 795. 46	26, 836. 61	3. 71	1941.....	1, 093, 301. 51	41, 167. 38	3. 76
1937.....	738, 858. 54	33, 819. 43	4. 57	1942.....	1, 270, 968. 45	46, 701. 98	3. 67
1938.....	867, 528. 50	34, 679. 64	4. 00	1943.....	1, 316, 533. 49	50, 524. 22	3. 83

## FREER GALLERY OF ART FUND

Early in 1906, by deed of gift, Charles L. Freer, of Detroit, gave to the Institution his collection of Chinese and other Oriental objects of art, as well as paintings, etchings, and other works of art by Whistler, Thayer, Dewing, and other artists. Later he also gave funds for the construction of a building to house the collection, and finally in his will, probated November 6, 1919, he provided stock and securities to the estimated value of \$1,958,591.42 as an endowment fund for the operation of the Gallery. From the above date to the present time these funds have been increased by stock dividends, savings of income, etc., to a total of \$5,836,772.01. In view of the importance and special nature of the gift and the requirements of the testator in respect to it, all Freer funds are kept separate from the other funds of the Institution, and the accounting in respect to them is stated separately.

The invested funds of the Freer bequest are classified as follows:

Court and grounds fund.....	\$653, 866. 10
Court and grounds maintenance fund.....	164, 230. 01
Curator fund.....	665, 412. 78
Residuary legacy.....	4, 353, 263. 12
<b>Total.....</b>	<b>5, 836, 772. 01</b>

## SUMMARY

Invested endowment for general purposes.....	\$1, 336, 949. 55
Invested endowment for specific purposes other than Freer endowment.....	1, 305, 973. 57
<b>Total invested endowment other than Freer endowment.....</b>	<b>2, 642, 923. 12</b>
<b>Freer invested endowment for specific purposes.....</b>	<b>5, 836, 772. 01</b>
<b>Total invested endowment for all purposes.....</b>	<b>8, 479, 695. 13</b>

## CLASSIFICATION OF INVESTMENTS

Deposited in the U. S. Treasury at 6 percent per annum, as authorized in the United States Revised Statutes, sec. 5591.....		\$1,000,000.00
Investments other than Freer endowment (cost or market value at date acquired):		
Bonds (16 different groups).....	\$515,343.75	
Stocks (40 different groups).....	795,761.87	
Real-estate and first-mortgage notes.....	324,989.63	
Uninvested capital.....	6,827.87	
		<u>1,642,923.12</u>
Total investments other than Freer endowment.....		2,642,923.12
Investments of Freer endowment (cost or market value at date acquired):		
Bonds (28 different groups).....	\$2,222,113.26	
Stocks (62 different groups).....	3,600,969.47	
Real estate first-mortgage notes.....	7,500.00	
Uninvested capital.....	6,189.28	
		<u>5,836,772.01</u>
Total investments.....		8,479,695.13

CASH BALANCES, RECEIPTS, AND DISBURSEMENTS DURING THE FISCAL YEAR<sup>1</sup>

Cash balance on hand June 30, 1942.....		\$740,823.73
Receipts:		
Cash income from various sources for general work of the Institution.....	\$82,792.06	
Cash gifts and contributions expendable for special scientific objects (not to be invested).....	25,233.00	
Cash gifts for special scientific work (to be invested).....	500.00	
Cash income from endowments for specific use other than Freer endowment and from miscellaneous sources (including refund of temporary advances).....	131,518.33	
Cash received as royalties from Smithsonian Scientific Series.....	17,766.32	
Cash capital from sale, call of securities, etc. (to be reinvested).....	373,564.26	
		<u>631,373.97</u>
Total receipts other than Freer endowment.....		631,373.97
Cash income from Freer endowment.....	\$216,125.07	
Cash capital from sale, call of securities, etc. (to be reinvested).....	1,440,606.70	
		<u>1,656,731.77</u>
Total receipts from Freer endowment.....		1,656,731.77
Total.....		<u><u>3,028,929.47</u></u>

<sup>1</sup> This statement does not include Government appropriations under the administrative charge of the Institution.

## CASH BALANCES, RECEIPTS, AND DISBURSEMENTS DURING THE FISCAL YEAR—Continued

## Disbursements:

## From funds for general work of the Institution:

Buildings—care, repairs, and alterations	\$2,980.12
Furniture and fixtures	173.43
General administration <sup>2</sup>	33,108.71
Library	2,517.92
Publications (comprising preparation, printing, and distribution)	36,634.70
Researches and explorations	15,372.22

---

 \$90,787.10

## From funds for specific use, other than Freer endowment:

Investments made from gifts and from savings on income	50,752.65
Other expenditures, consisting largely of research work, travel, increase and care of special collections, etc., from income of endowment funds, and from cash gifts for specific use (including temporary advances)	122,872.78
Reinvestment of cash capital from sale, call of securities, etc.	285,264.19
Cost of handling securities, fee of investment counsel, and accrued interest on bonds purchased	3,779.05

---

 462,668.67

## From Freer endowment:

Operating expenses of the gallery, salaries, field expenses, etc.	37,224.00
Purchase of art objects	131,971.87
Reinvestment of cash capital from sale, call of securities, etc.	1,611,775.28
Cost of handling securities, fee of investment counsel, and accrued interest on bonds purchased	22,804.12

---

 1,803,775.27

 Cash balance June 30, 1943 

---

 671,698.43

 Total 

---

 3,028,929.47
<sup>2</sup> This includes salary of the Secretary and certain others.

Included in the foregoing are expenditures for researches in pure science, publications, explorations, care, increase, and study of collections, etc., as follows:

## Expenditures from general funds of the Institution:

Publications	\$36,634.70
Researches and explorations	15,372.22

---

 \$52,006.92

**Expenditures from funds devoted to specific purposes :**

Researches and explorations.....	\$37, 032. 59
Care, increase, and study of special collections.....	7, 062. 42
Publications .....	6, 054. 74
	\$50, 149. 75
<b>Total.....</b>	<b>102, 156. 67</b>

The practice of depositing on time in local trust companies and banks such revenues as may be spared temporarily has been continued during the past year, and interest on these deposits has amounted to \$1,348.28.

The Institution gratefully acknowledges gifts or bequests from the following:

- Funds from sale of certain publications, property of the late E. J. Brown to be used, at his request, for the study of birds.
- Florence Brevoort Eickemeyer, bequest, income of which to be used for exhibition, preservation and care of photographic works and collection of Rudolph Eickemeyer, Jr.
- Friends of Dr. Albert S. Hitchcock for Hitchcock Agrostological Library.
- John A. Roebling, further contributions for research in radiation.

All payments are made by check, signed by the Secretary of the Institution on the Treasurer of the United States, and all revenues are deposited to the credit of the same account. In many instances deposits are placed in bank for convenience of collection and later are withdrawn in round amounts and deposited in the Treasury.

The foregoing report relates only to the private funds of the Institution.

The following annual appropriations were made by Congress for the Government bureaus under the administrative charge of the Smithsonian Institution for the fiscal year 1943:

General expenses.....	\$394, 334
(This combines under one heading the appropriations heretofore made for Salaries and Expenses, International Exchanges, American Ethnology, Astrophysical Observatory, and National Collection of Fine Arts of the Smithsonian Institution, and for Maintenance and Operation of the United States National Museum.)	
Preservation of collections (including supplemental appropriation for overtime salaries).....	699, 246
Printing and binding.....	88, 500
National Zoological Park (including supplemental appropriation for overtime salaries).....	269, 200
Cooperation with the American Republics (transfer to the Smithsonian Institution).....	57, 500
Working fund.....	20, 000
	\$1, 528, 780
<b>Total.....</b>	<b>1, 528, 780</b>



The report of the audit of the Smithsonian private funds is given below:

SEPTEMBER 23, 1943.

EXECUTIVE COMMITTEE, BOARD OF REGENTS,  
*Smithsonian Institution, Washington, D. C.*

SIRS: Pursuant to agreement we have audited the accounts of the Smithsonian Institution for the fiscal year ended June 30, 1943, and certify the balance of cash on hand, including Petty Cash Fund, June 30, 1943, to be \$673,598.43.

We have verified the record of receipts and disbursements maintained by the Institution and the agreement of the book balances with the bank balances.

We have examined all the securities in the custody of the Institution and in the custody of the banks and found them to agree with the book records.

We have compared the stated income of such securities with the receipts of record and found them in agreement therewith.

We have examined all vouchers covering disbursements for account of the Institution during the fiscal year ended June 30, 1943, together with the authority therefor, and have compared them with the Institution's record of expenditures and found them to agree.

We have examined and verified the accounts of the Institution with each trust fund.

We found the books of account and records well and accurately kept and the securities conveniently filed and securely cared for.

All information requested by your auditors was promptly and courteously furnished.

We certify the Balance Sheet, in our opinion, correctly presents the financial condition of the Institution as at June 30, 1943.

Respectfully submitted.

WILLIAM L. YAEGER,  
*Certified Public Accountant.*

Respectfully submitted.

FREDERIC A. DELANO,  
VANNEVAR BUSH,  
CLARENCE CANNON,  
*Executive Committee.*



---

---

GENERAL APPENDIX  
TO THE  
SMITHSONIAN REPORT FOR 1943

---

---

## ADVERTISEMENT

The object of the **GENERAL APPENDIX** to the Annual Report of the Smithsonian Institution is to furnish brief accounts of scientific discovery in particular directions; reports of investigations made by collaborators of the Institution; and memoirs of a general character or on special topics that are of interest or value to the numerous correspondents of the Institution.

It has been a prominent object of the Board of Regents of the Smithsonian Institution from a very early date to enrich the annual report required of them by law with memoirs illustrating the more remarkable and important developments in physical and biological discovery, as well as showing the general character of the operations of the Institution; and, during the greater part of its history, this purpose has been carried out largely by the publication of such papers as would possess an interest to all attracted by scientific progress.

In 1880, induced in part by the discontinuance of an annual summary of progress which for 30 years previously had been issued by well-known private publishing firms, the Secretary had a series of abstracts prepared by competent collaborators, showing concisely the prominent features of recent scientific progress in astronomy, geology, meteorology, physics, chemistry, mineralogy, botany, zoology, and anthropology. This latter plan was continued, though not altogether satisfactorily, down to and including the year 1888.

In the report for 1889 a return was made to the earlier method of presenting a miscellaneous selection of papers (some of them original) embracing a considerable range of scientific investigation and discussion. This method has been continued in the present report for 1943.

# SOLAR RADIATION AS A POWER SOURCE<sup>1</sup>

---

BY C. G. ABBOT

*Secretary, Smithsonian Institution*

---

[With 3 plates]

This major power source of the world is as yet almost unused by engineers. The intensity of solar radiation at mean solar distance outside the earth's atmosphere is about 1.94 calories per square centimeter per minute. Expressed in English measures, this is 7.15 B. t. u. per square foot per minute. Actual supplies of sun heat, however, vary with the season. Owing to the ellipticity of the earth's orbit, we are about 3 million miles nearer the sun in January than in July, and the actual intensity of the sun's rays outside the atmosphere is about 6 percent greater in January than in July. As there is less humidity and clearer air in winter, it follows that the sun's heat at the earth's surface in the Northern Hemisphere is a good deal more intense in winter than in summer for equal solar altitudes above the horizon. The reason winter is cold is because the sun lies so far south that its rays shine very obliquely, so that the average intensity on a horizontal surface is thereby greatly reduced.

Thick clouds reflect away about 75 percent of the sun rays which strike them. Much of the area east of the Mississippi is 50 percent cloudy, so it follows that in these sections a third of the sun's radiation is reflected out to space. Besides this cloud loss there is an actual absorption by the water vapor and other ingredients of the atmosphere. This amounts in humid localities to from 15 to 25 percent. Accordingly, solar power propositions would operate at great disadvantage in most of the States east of the Mississippi, excepting Florida, as compared to the arid and generally high-altitude regions of the Southwest.

Measurements of solar radiation made at the earth's surface upon a receiver at right angles to the beam, and with the sun at 15° or more above the horizon, range from 1.5 calories per square centimeter per minute down to 1.0 calorie, or even less, depending on the clearness of the atmosphere. In favorable localities a value of about 1.35

---

<sup>1</sup> Reprinted by permission from *The Military Engineer*, vol. 35, No. 208, February 1943.

calories may be assumed as the average for the day of solar energy on a surface normal to the beam, except while clouds obscure the sun. This corresponds in ordinary power units to 1.15 horsepower per square yard.

Whether or not it is worth while to employ the solar energy for power depends on the efficiency which can be achieved in converting solar radiation into mechanical energy. On that factor depend the size and cost of the equipment. An efficiency of only 1 to 5 percent would be apt to involve prohibitively cumbersome and costly equipment. But a solar engine with an efficiency of 10 to 15 percent might be commercially competitive with other sources of power, even at present. As times goes on, it is to be supposed that the cost of the major power sources, coal and oil, will rise, though the limited supply of water power may remain relatively unchanged in cost. Hence, in the future, unless some as yet unused source of power becomes important, it is probable that solar power will be extensively employed.

If such a change in the major sources of power should occur, it would tend to alter very much the distribution of population. Such a State as New Mexico would become a great manufacturing center. With machines of the type already devised, that State could furnish from solar radiation more power than is now used for heat, light, transportation, and manufacturing in the United States, and at a cost not perhaps exceeding the present cost of power from coal.

There are two major difficulties in the way of utilizing solar radiation. First, except on overcast days, the sun's rays come from a moon-sized spot, which moves daily through the sky from the eastern to the western horizon, and yearly from  $23^{\circ}$  north to  $23^{\circ}$  south of the celestial equator. Second, from sunset to sunrise the sun's rays are wholly cut off.

#### EARLY EXPERIMENTS

In one interesting series of experiments, reported by Willsie and Boyle in *Engineering News*, May 13, 1909, the first difficulty was avoided by employing a stationary horizontal receiver. This, however, is at great cost in thermodynamic efficiency, owing to the low temperatures of operation, and to losses of radiation by reflection, due to the very oblique incidence of the rays during many hours of the day and year. It would seem fatal to sacrifice so much efficiency.

The work of Shuman at Tacony, Philadelphia, also reported in that same issue of *Engineering News*, led on at length to the very different experiments of Eastern Sun Power, Ltd., described by Ackermann in the *Smithsonian Report* for 1915. These experiments came nearer being a commercial success, I believe, than any others on solar power up to that time. A large plant was erected near Cairo, Egypt, and used for a time for irrigation from the Nile. It appears to have been

abandoned during and since the World War of 1914-18. In these experiments the sun's rays were roughly focused upon boilers, and thus from the thermodynamic viewpoint more eligible temperatures were attained than those of Willis and Boyle's experiments.

Some inventors have attempted to employ thermoelectricity or photoelectricity as means of escaping from the necessity of working through gaseous heat cycles to achieve mechanical motion. It is difficult to conceive that thermoelectric couples could ever be a valuable expedient for this purpose. The electromotive forces available are so

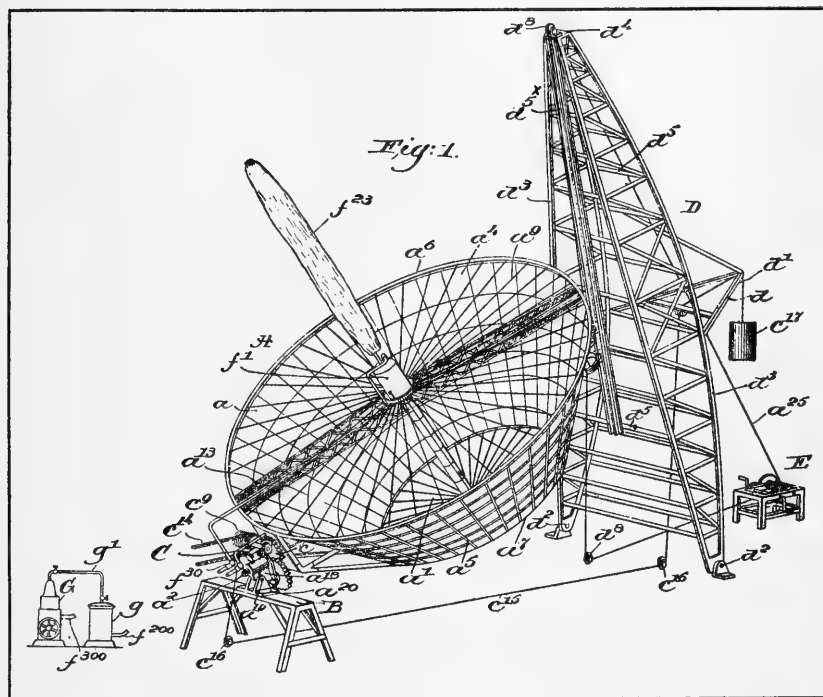

FIGURE 1.—Eneas's solar generator, patented March 26, 1901.

small that the multiplication of couples is necessarily great, and the apparatus required would contain enormous numbers of parts. The wires used would all be metallic conductors of heat, so that a very large fraction of the solar input would be dissipated in useless heat losses. As for photoelectricity, it seems to be limited to comparatively narrow regions of the spectrum, so that large fractions of the solar rays would be wholly useless to these devices. Of the remaining useful rays, no inconsiderable part would be converted into heat, and would also be useless. I cannot think that at present these direct electrical conversions of solar radiation seem promising solutions of the solar-power problem.

## INSTRUMENTS

Within the past quarter century, so much progress has been made in the commercial use of aluminum products, and also of high-vacuum technique, that it is possible for one who is familiar with the astronomers' solution of their problem of following the heavenly bodies with telescopes to design types of apparatus for utilizing solar radiation for power, combining minimum expense with maximum efficiency.

Formerly the choice for solar mirrors lay between mirror glass and metals of rather low reflecting power and short reflecting life. Such materials for mirrors were heavy, costly, inefficient, and quickly deteriorating. We can now purchase commercially the bright reflecting product called Alcoa in thin sheets of large size. It is a special preparation of aluminum, long retaining its reflectivity, and with a coefficient of reflection for solar rays slightly exceeding 80 percent. Frames of suitable curvature being made from duralumin shapes, these may be covered with the thin Alcoa sheets to make up cheap, light, and fairly permanent solar mirrors.

In consideration of best design, we come to the question of waste of heat. It is well known that heat is lost by three processes: conduction, convection, and radiation. Of these, metallic conduction would be very important, as stated before, if one should be using a great number of thermoelectric elements, but it is possible almost entirely to eliminate losses by conduction with boilers of certain forms. With moderate temperature differences, and for objects in the open air, convection is a far greater dissipater of heat than radiation. But direct convection may be eliminated almost altogether if the body to be cooled is enclosed by highly evacuated space as commonly practiced in the thermos bottle. In that case cooling proceeds almost wholly by radiation from the inner to the outer wall of the enclosing evacuated sheath, and thence by convection and radiation to the surroundings. This consideration leads us to see at once that the advantage of employing an evacuated sheath becomes less and less as the temperature of the solar boiler rises higher and higher. For radiation increases as the fourth power of the temperature for the so-called black body or perfect radiator. Since we must use a transparent sheath to admit rays to the boiler, it is not practicable to cut down radiation by fully plating the inner wall of the evacuated sheath, as in the thermos bottle. We must, therefore, regard the inner wall of the sheath as approximately a "black body." Hence the inner wall of the evacuated sheath, when at high temperatures, will radiate strongly to the outer wall, which conducts the heat to its outer surface and there loses it by convection.

On this account it follows that although the sun's temperature is so high that boiler temperatures up to the melting point of materials



could readily be attained, this is not advantageous. For though the thermodynamic efficiency factor  $T_1 - T_2/T_1$  would gain, this would be more than offset by the increased heat losses of the boiler. Furthermore, though quartz glasses like Pyrex enable us to use transparent evacuated sheaths at fairly high temperatures, high vacua lose their excellence with very high temperatures, so that convection becomes serious.

On these accounts it is not desirable in solar-power machines to employ boiler temperatures much above  $200^\circ \text{C}$ . ( $392^\circ \text{F}$ ). If operating to a condenser at  $30^\circ \text{C}$ ., such a temperature of the boiler gives a thermodynamic factor of  $473 - 303/473 = 36$  percent, which, for reasons just explained, may be regarded as the maximum to be expected if due regard is paid to loss of heat from the boiler.

Another fundamental consideration in designing solar-power devices is that the loss of heat from a body through convection or radiation is directly proportional to the external area of the surface of the body. Hence it is of importance for diminishing the waste of heat that the boiler surface should be as small as possible, by using fairly accurate optical mirror forms.

Astronomers have long ago agreed that the simplest mechanical motions that could be devised for following celestial objects are those of the equatorial telescope. This scheme involves mounting the instrument which is to follow the celestial object upon an axis parallel to the earth's axis, and imparting to this "polar axis" a uniform motion of  $15^\circ$  per hour. If the instrument is to be adapted to follow objects at different distances north or south of the celestial equator—that is, of different declinations—there must be a second axis at right angles carried by the polar axis. This second axis, called the declination axis, carries the telescope or other following device and is to be set by hand to the position of any desired celestial object, and clamped there. If the sun remained stationary with regard to the celestial equator, no second axis would be needed in solar-power machines. But the sun travels through  $47^\circ$  north and south during the year.

It is highly desirable to operate with a stationary boiler. The withdrawal of steam from a moving boiler involves costly and unsatisfactory connection. It is clear that a spherical boiler placed in the intersection of the two axes of an equatorial mirror mounting could be stationary. But it would be impossible to enclose thoroughly with an evacuated sheath. The mirror in this case would be circular and preferably of parabolic curvature, which is an awkward shape for fabrication.

It has seemed to me preferable to neglect the north-to-south motion of the sun, using a mirror rotating uniformly at  $15^\circ$  per hour

about a single polar axis. The boiler then becomes a tube of small diameter lying in the axis. The vacuum sheath is an elongated Pyrex thermos bottle, of which about one-third the circumference of the outer surface of the inner wall is gold-plated. The mirror is a rectangular concave cylindric mirror, of parabolic curvature, whose equation, as I prefer it, is  $y^2 = 36x$ . The mirror is long and narrow and rotates about its focus, the polar axis. Being long compared to its width, the deliberate end-loss of light at the solstices, June 20 and December 20, from neglecting the sun's motion in declination, is not serious, and this loss becomes zero at the equinoxes. The metallic

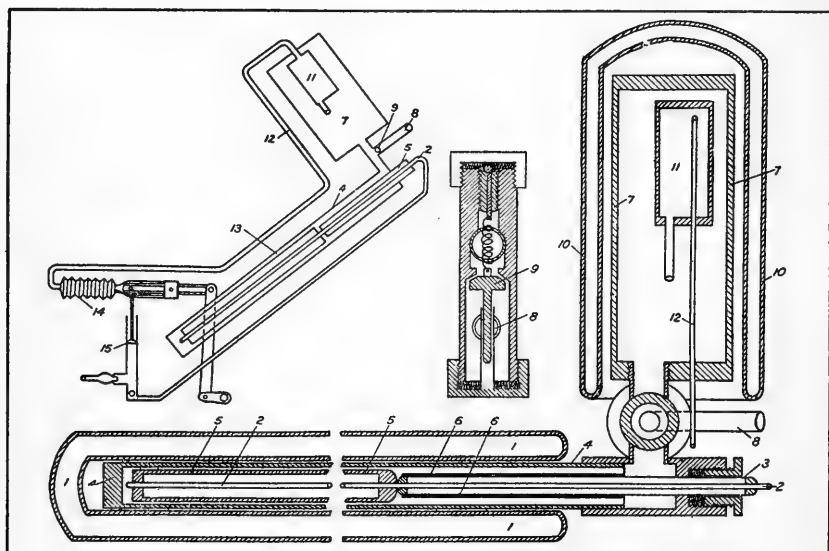

FIGURE 2.—Diagram of flash boiler (4), in vacuum sheath (1), served by water supply (2), governed by air pressure in steam chest (7), operating extensible chamber (14), governing injector (15). First arrangement.

boiler tube is blackened by painting with a suspension of lampblack in alcohol with a slight addition of shellac. At the low temperatures, not exceeding  $200^{\circ}$  C., this paint does not burn. It absorbs about 95 percent of the solar radiation.

The mirror in my small model comprises several castings of aluminum, machined to accurate parabolic curves and joined by L-stringers of duralumin to form a cradle. To this cradle are attached Alcoa sheets not previously bent, and held down by narrow metal straps screwed through the sheets to the parabolic frames. At the ends the mirror frame supports steel hanger bars which carry hollow trunnions, and supports above a counterbalance bar of metal, set edgewise to the beam and extending from end to end of the mirror as a stiff-

fener. Simple stout wooden posts, set in the ground, are adapted to carry rollers on which the trunnions rest with their axis parallel to that of the earth. The elongated Pyrex thermos bottle enclosing the boiler tube rests axial to the hollow trunnions and is closed at the lower end.

To drive the mirror most conveniently, a worm-and-wheel mechanism is attached to one end of the mirror and its support. The worm is driven at the correct speed by a tiny 60-cycle electric motor. Where alternating electric current is difficultly available, a weight drive may be substituted, regulated by an escapement controlled by an ordinary

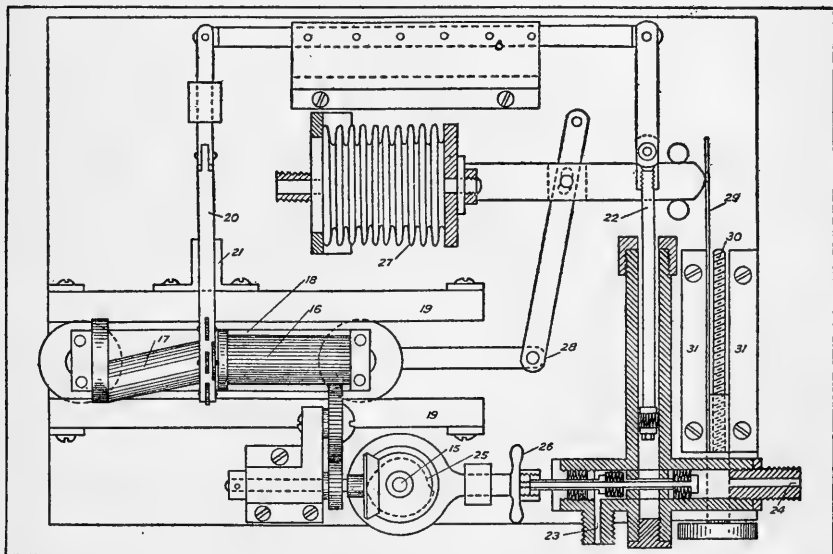

FIGURE 3.—Diagram of variable-delivery injector, with delivery governed by pressure of steam as first used with Dr. Abbot's flash boiler.

alarm clock. I have used such a contrivance successfully for a large mirror on Mount Wilson.

For solar power, I prefer the "flash boiler" principle because of its economy of fair skies.<sup>2</sup> Even in the desert regions, cumulus clouds occasionally hide the sun. If the boiler had a considerable capacity for heat, a series of such clouds might prevent getting full steam pressure at all on a day when the sun shone clearly one-half the time. But when the flash boiler is properly designed, full steam pressure comes on within 5 minutes after the sun emerges from such a cloud. This design involves the automatic regulation of the water supply, to be completely turned to steam as fast as supplied while

<sup>2</sup> I have changed my view recently, as indicated in the concluding paragraph of this paper.

the sun shines and to be completely cut off when the sun is obscured. This requires a pump able to force water in against full steam pressure, and so regulated by the temperature of the boiler that the water flow ceases when the boiler cools, and reaches a maximum when the boiler temperature reaches the point for the desired pressure of steam.

I accomplish these objects by employing a diaphragm pump, whose stroke is governed from zero to maximum displacement by a rotating cam of regularly increasing throw, operating through a pitman upon the pump. The cam is driven from the 60-cycle motor, above-mentioned, and is mounted on a longitudinally displaceable carriage. The position of the carriage, and hence the throw of the cam, is governed by the differential heat expansion between the boiler tube and a tape of the nonexpansible alloy, invar, attached thereto.

The water is forced through a small tube centrally to the lower end of the boiler tube, where it is guided by a spreader tube into a thin sheet bathing the inner wall of the boiler tube. The water bursts immediately into steam, which flows out to the engine through connections from the upper end of the boiler tube. A maze of heat-conducting copper vanes extends throughout the upper part of the boiler tube, so that only dry steam can escape therefrom. In large solar-power installations, no doubt it would be desirable to use auxiliary superheaters.

The efficiency of such a device is a matter of critical interest for the future of solar power. It may be estimated as follows:

	<i>Percent</i>
Mirror reflection -----	82
Sheath transmission -----	85
Boiler absorption -----	95
Heat not wasted -----	90
<hr/>	
Boiler efficiency $0.82 \times 0.85 \times 0.95 \times 0.90 =$ -----	60
Thermodynamic factor (as above) -----	36
Assumed mechanical efficiency of engine -----	75
<hr/>	
Over-all efficiency of conversion : $0.60 \times 0.36 \times 0.75 =$ -----	16.2

Recalling, as stated above, that the average receipt of solar energy throughout cloudless days in a favorable region corresponds to 1.15 horsepower per square yard of surface normal to the beam, we conclude that it will require a mirror of not less than 5.4 square yards, or 48.6 square feet, surface per horsepower under the most favorable of circumstances. Such a mirror might well be 10 by 5 feet in projection. When we consider wind resistance and other limitations, including especially the glass tubing of the evacuated sheath, it seems difficult

to suppose that units of more than 5 horsepower (area of mirror projection  $12\frac{1}{2}$  by 20 feet) would be found desirable.

Such units could be assembled in groups of 30, occupying a ground area 150 feet, east-west, by 250 feet, north-south, without undue mutual shading, so as to give a maximum of 150 horsepower per group. Such a group of machines could be mechanically operated in common as regards rotation of mirrors and pumping of feed water. They could also deliver steam to a common superheater for use.

It is estimated that the United States uses the equivalent of approximately 10 trillion horsepower hours of power annually for light, heat, transportation, and manufacturing. Assuming, as above, 37,500 square feet of space required for 150 horsepower from the solar source, there would be required 30,000 square miles of territory to supply this entire requirement, assuming only 8 hours' sunshine per day of the average solar intensity stated above, namely, 1.35 calories per square centimeter per minute. The State of New Mexico alone has approximately four times this area.

#### COST AND OTHER CONSIDERATIONS

The cost of solar power is difficult to estimate. It depends on the quantity used. With large installations, care and upkeep would become nearly negligible, so that, with a 10-percent return on investment, the cost of power at the plant might be estimated as less than one-third cent per horsepower-hour.

There remains to consider the serious drawback that direct solar power is unavailable at night. For certain purposes, as irrigation, this is not a serious objection.

However, since writing the above I have thought that the means shown in United States Patent No. 2,247,830, of July 1, 1940, could be expanded to include a strong insulated reservoir of water. Solar heating would be conveyed to the water, by gravity circulation through a coil immersed therein, from a black high-boiling liquid filling a vacuum-sheathed glass focus tube. In this way all the expense of the flash boiler would be eliminated, all moments of solar heating would be utilized, the water in the reservoir would be maintained in a superheated state night and day, and superheated steam would issue to the engine on opening a cock.



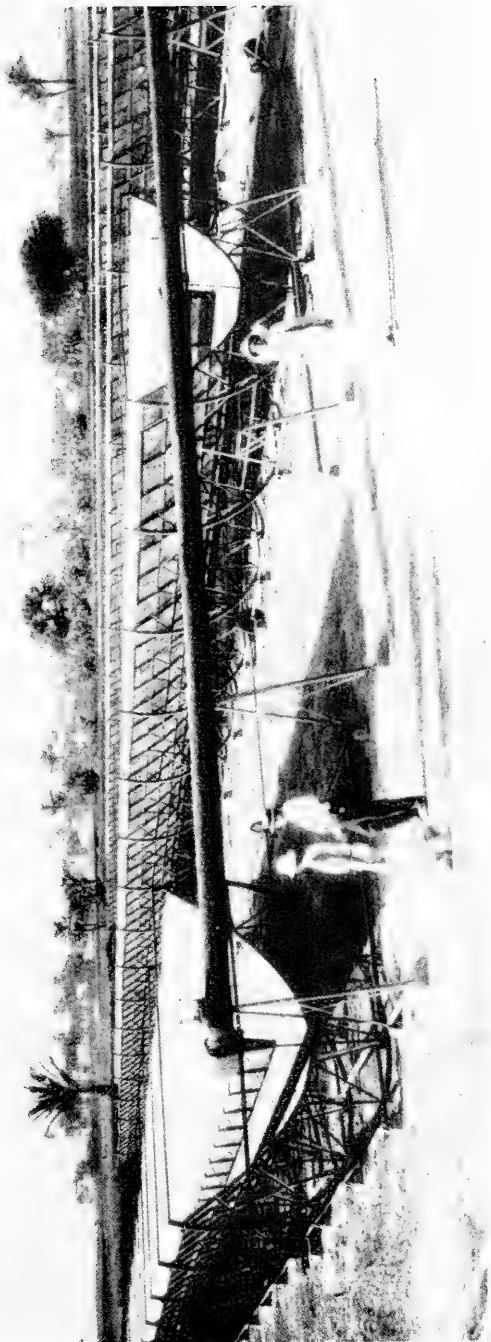

GENERAL VIEW FROM THE SOUTH OF SHUMAN-BOYS ABSORBER, MEADI, 1913.

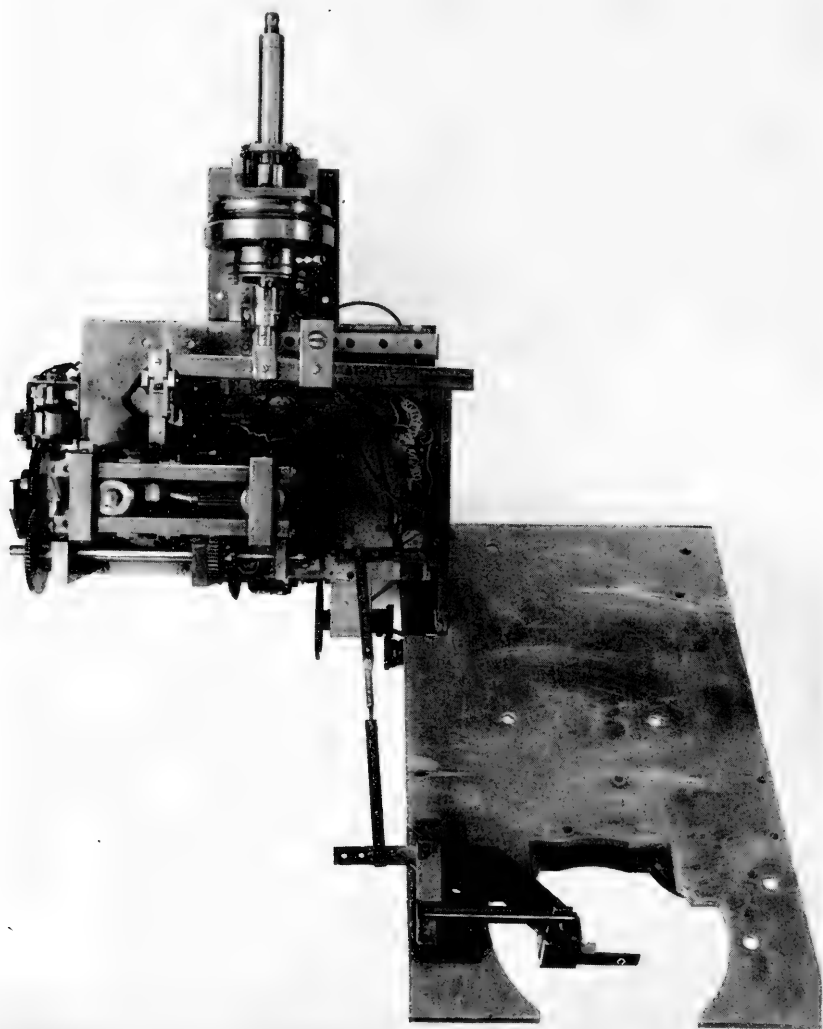

DIAPHRAGM PUMP INJECTOR OF VARIABLE THROW GOVERNED BY DIFFERENTIAL  
HEAT EXPANSION BETWEEN BOILER AND INVAR TAPE.  
Rollers which support the mirror seen behind the aluminum plate.



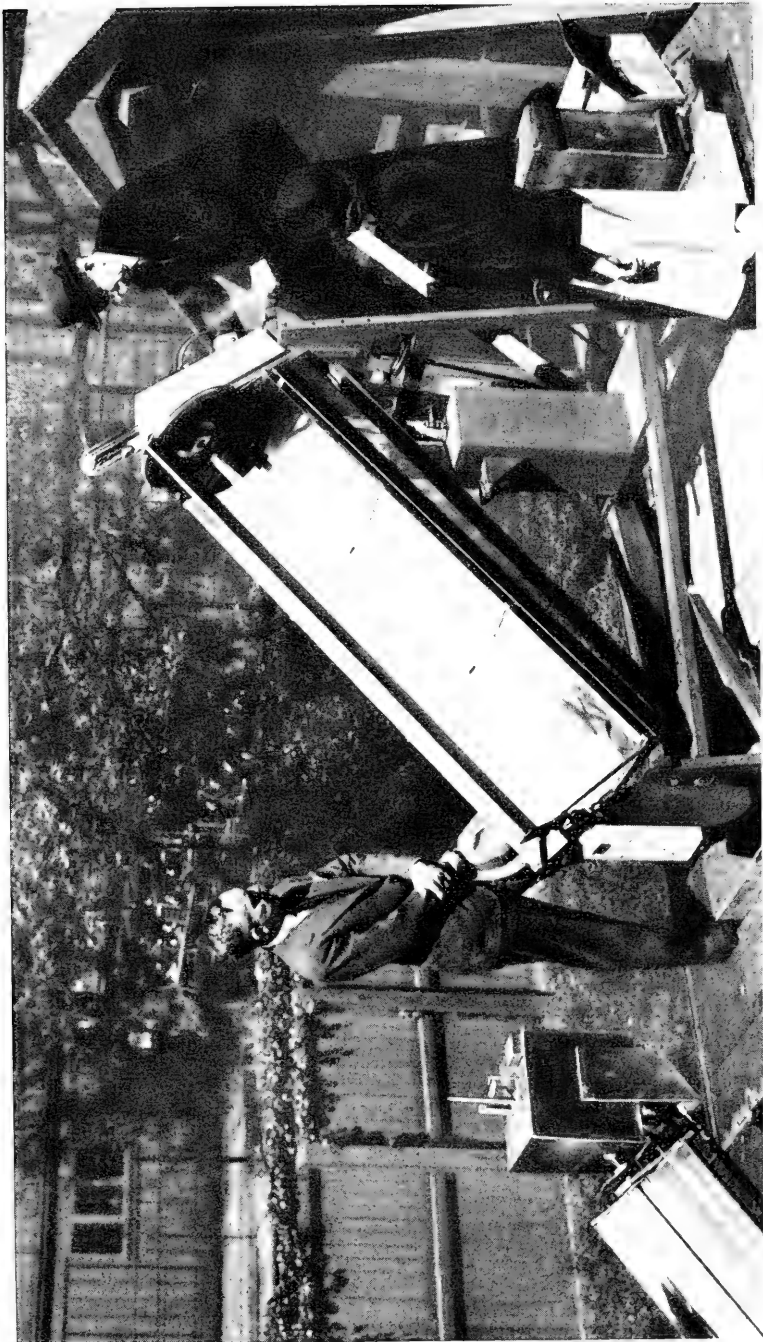

ABBOT'S SOLAR FLASH BOILER.

This apparatus, source of steam generated from the sun's heat, is shown in operation on a low platform behind the Smithsonian building. Steam, capable of running a small engine, may be seen issuing from the pipe near Dr. Abbot's left hand. Dr. Abbot's toy solar cooker is seen at the left. (Photograph by Richard H. Stewart, courtesy National Geographic Society.)



# SOME BIOLOGICAL EFFECTS OF SOLAR RADIATION <sup>1</sup>

---

By BRIAN O'BRIEN  
*Institute of Optics*  
*The University of Rochester*

---

[With 1 plate]

Man and the higher animals depend for their very existence upon sunlight. The temperature of the earth's surface and of the earth's atmosphere is maintained within limits which can support life only by the flood of radiation which comes to us from the sun. The power supply for all air movement, all winds, everything that goes to make up weather, is this same solar radiation. Most of the higher animals and land plants can survive only with a supply of fresh water, a supply which exists simply because of sunlight. Without the constant working of the distillation plant which evaporates water from the sea and condenses it as rain and snow there would be nothing but salt water on the face of the earth. This distillation plant runs purely by solar heat.

But our dependence upon the sun goes far beyond this. Animals cannot by themselves synthesize food and fuel. Even man with all his ingenuity has not yet learned to do this. He can convert food from one kind to another, as he can convert fuel into altered and more convenient forms, but he cannot yet create either. This job is reserved for the green plants. The green coloring matter, chlorophyll, permits a plant to utilize sunlight in converting carbon dioxide and water vapor into sugars, starches, and cellulose. This process, which literally unburns our coal as rapidly as an active human race can burn it, supplies, directly or indirectly, all the food and fuel available on the earth. Here again, through the medium of plant life, man and the higher animals are dependent upon radiation from the sun.

These relations of sunlight to man have been discussed in previous Arthur lectures. Tonight I would like to discuss some less evident effects of sunlight, which, though subtler, are important too. These

---

<sup>1</sup> The tenth Arthur lecture, given under the auspices of the Smithsonian Institution, February 25, 1941.

have to do with biological effects, direct or indirect, of sunlight upon the animal organism. They are specific and depend upon the wave length and character of the light. For this reason we must start by considering something of the nature of the radiant energy which we receive from the sun.

The light from most sources is made up of many different frequencies or wave lengths, and sunlight is no exception to this rule. Such light may be analyzed into a spectrum with a prism and the wave lengths separated from each other, much as a chemist might make a qualitative analysis to determine the elements of which some material or com-

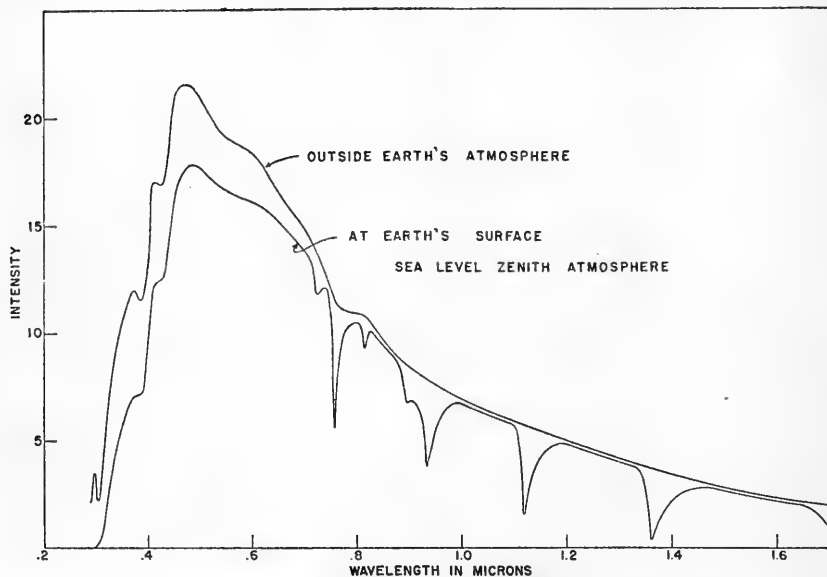

FIGURE 1.—Distribution of energy in the solar spectrum (Abbot) with new extension at ultraviolet end.

pound is composed. If light from a narrow source or slit is allowed to pass through a prism, a series of images will be produced corresponding to the several wave lengths present, and so a spectrum is formed. This spectrum shows the familiar sequence of colors of the rainbow from violet at the short-wave-length end through blue, green, yellow, orange, to red at the longest wave length which can be seen. There are, of course, wave lengths beyond the range to which the eye is sensitive. At longer wave length than the red is the infrared extending for many octaves, and at shorter wave length than the violet is the ultraviolet, a region which will be of particular interest to us here.

It is of interest to know what wave lengths are present, but it is even more important to know how much of each. This can be deter-

mined in a variety of ways. The most fundamental method consists in converting the radiation into heat by absorption in a blackened surface, and measuring the amount of heat produced in each narrow region of the spectrum by the rise of temperature of a delicate electrical thermometer. This is analogous to quantitative analysis by the chemist. The energy in each wave length having been determined, it may be plotted as a graph of energy against wave length, such a plot representing the spectral-energy distribution of the light from the particular source measured.

Fortunately, this has been carried out for solar radiation very completely and with high accuracy by Dr. Abbot and his associates at the Smithsonian Astrophysical Observatory, so that the spectral-energy distribution of sunlight is now well known. Although the measurements are made at the earth's surface and are thus measurements of sunlight after loss by transmission through the earth's atmosphere, there is a perfectly definite procedure by which the amount of this loss is determined, and so the spectral energy outside the earth's atmosphere as well as that at the earth's surface is known. These are plotted in figure 1. It will be seen that in sunlight the greatest energy occurs in the visible region of the spectrum, the intensity falling off rapidly as one passes beyond the violet into the ultraviolet region, and falling off more slowly as one goes beyond the red into the infra-red.

In order to act upon living matter, solar radiation must be absorbed by some part of the living organism. In the case of micro-organisms, this absorption occurs throughout the volume of the whole animal or plant, much of the radiation passing entirely through the organism. In the higher animals and man, practically all the radiation is absorbed in the skin, no significant amount penetrating to an appreciable depth. In animals, even the skin is protected by the hair, which thus becomes the principal absorber of light. Oddly enough, this absorption by hair is utilized by animals in at least one important vitamin reaction. When radiation of wave length in or near the visible spectrum is absorbed by living matter, the energy is either converted into heat or enters directly into a photochemical reaction. Either or both of these effects constitute the first step in the direct action of sunlight upon a living organism. Since this energy transformation must occur when and where the light is absorbed, we may expect a primary action anywhere within a small organism. In larger organisms, and in particular in higher animals and man, the primary action must occur at the surface; that is, in the skin.

Human skin is somewhat different from that of any animal, although the gross structures are roughly comparable. Even unpigmented human skin absorbs ultraviolet light strongly, while at the

red end of the spectrum, unpigmented skin is a relatively poor absorber, reflecting back much of the light energy received. This is shown by two photographs of unpigmented human skin which are reproduced in plate 1. The first photograph was made with ultraviolet radiation, while the second was made with infrared radiation at a wave length just beyond the visible spectrum. For comparison a block of white magnesium carbonate was held in the hand in both photographs. This was a good diffuse reflector (i. e., "white") in the ultraviolet and infrared as well as in the visible spectrum.

Although unpigmented skin reflects much of the visible light near the red end of the spectrum as well as the infrared just beyond, that which is absorbed appears to produce a rather specific thermal reaction. If one examines a cross section of human skin, it will be seen that the overlying layers contain no pigment materials that absorb red or near-infrared radiation strongly. Reflection does take place in these regions, owing to the many discontinuities in refractive index produced by the cell boundaries in the epidermis, but no measurable absorption occurs until the level of the capillaries is reached at 1 millimeter or so beneath the surface. Here the blood pigments absorb strongly, with the result that the temperature of this layer is elevated above the surface temperature of the skin, and even above the depth temperature of the body when the skin is exposed in not-too-cool air to intense radiation. This effect was first observed by Carl Sonne, who measured the temperature at successive depths beneath the skin's surface with a delicate needle thermocouple and found a marked rise in temperature under intense illumination. The conversion of radiation to heat at this level in the skin raises the temperature of the capillaries above adjacent layers, heat being conducted both to the cooler skin surface and the cooler tissues at a depth. Since the more sensitive innervation is above the capillary layer, it should be possible to produce without discomfort a higher temperature in the capillary blood by the direct absorption of radiation in it than by conduction of heat from the skin surface inward, as would occur with a hot object held against the skin. In the latter case, with the temperature gradient inward, the nerve endings would be at a higher temperature than the capillaries. Sonne reports capillary temperatures produced by light absorption comparable to high fever temperatures, yet without discomfort to the patient, and without a corresponding increase of either surface or depth temperature. The significance of this effect is not yet determined. It must occur in only moderate degree when human skin is exposed to sunlight, since several times the intensity of sunlight may be borne without discomfort.

With the exception of this thermal effect in the red and the near-infrared, and excepting also the action of visible light upon the eye,

there appear to be no other specific effects of sunlight upon any portion of the animal organism until the ultraviolet limit of the sun's spectrum is reached. Effects of visible light upon the eye are, of course, most important and profound, but except under destructively intense illumination, the response of the eye appears to be limited to providing us with a sensory contact with the external world. The subject of vision belongs properly in the field of sensory physiology and psychology and is not included in the types of biological reaction I am discussing tonight; so, for lack of time, and with some reluctance, I shall omit it entirely.

Most of you, I am sure, have experienced sunburn, or erythema, produced by light, but have you considered how it comes about? In

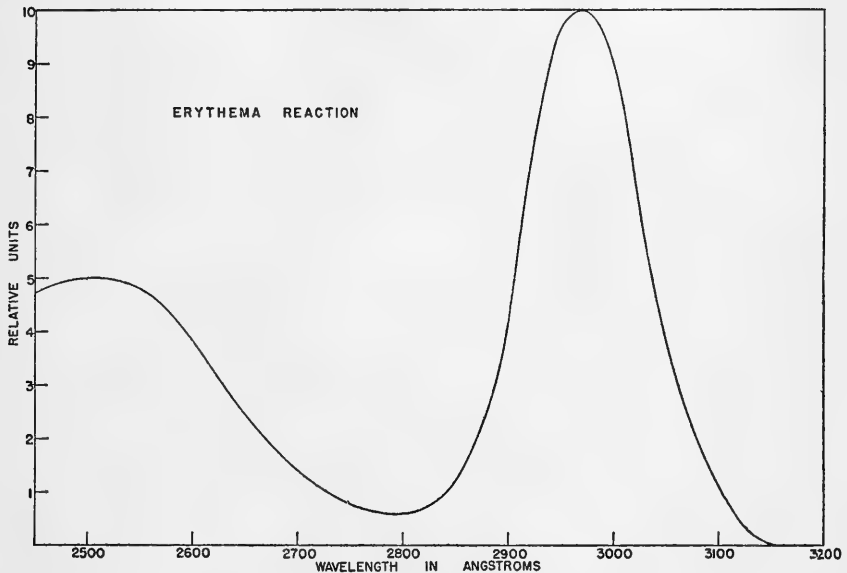

FIGURE 2.—Erythema sensitivity of human skin.

spite of its name, sunburn is not a heat reaction, but a photochemical reaction, produced without heat by ultraviolet light. Moreover, it is not produced by all the ultraviolet spectrum, but only by a very narrow region at the extreme ultraviolet limit of the sun's spectrum confined to wave lengths less than about 3150 angstrom units. This reaction appears to be a type of photo-oxidation, produced with the aid of certain enzymes present in normal skin. Hausser and Vahle, and later Hausser, determined the spectral sensitivity of this reaction, obtaining a reaction curve showing two maxima and approaching zero for wave lengths longer than about 3150 angstroms. This is shown in figure 2. These results have been confirmed by Luckiesh, Holliday, and Taylor. The significance of erythema and

the subsequent pigmentation or tanning of the skin has been a disputed point. The pigment of tanned skin is melanin, which appears physiologically inert, produced by an oxidation reaction following exposure to light. It seems most reasonable to suppose that the primary function of pigment is the protection it affords the underlying portions of the skin and blood stream from further excessive exposure.

It is worth while to examine in more detail the ultraviolet end of the sun's spectrum responsible for this reaction. The area under a spectral-energy distribution curve represents the energy in that spectral region. It will be evident from figure 1 that the area under the solar-energy distribution curve for all wave lengths shorter than

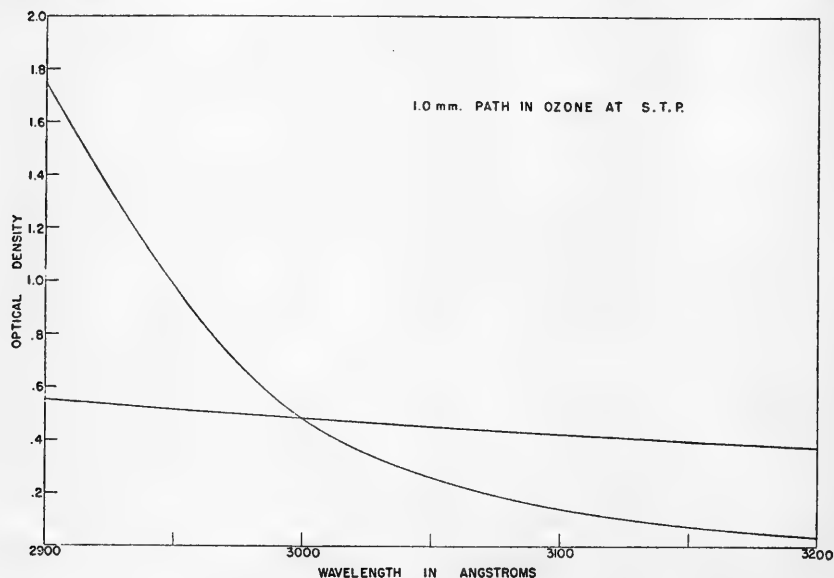

FIGURE 3.—Ultraviolet absorption of ozone.

3150 angstroms represents less than one-thousandth of the area under the total curve. The small energy involved renders the effects produced by this region of the spectrum the more remarkable.

It is noteworthy that at the earth's surface the sun's spectrum terminates very abruptly at about 2900 angstrom units. The spectrum of the stars and all known heavenly bodies terminates at about this same wave length, and long ago the conclusion was inevitable that something in the earth's atmosphere must be absorbing abruptly at this point. It is easy to produce much shorter wave lengths from artificial light sources, and there is no reason to attribute this abrupt termination to anything characteristic of the emission spectrum of the sun and stars. More than 50 years ago Hartley correctly attributed this abrupt termination to absorption by the gas ozone, tria-



tomie oxygen, located somewhere in the earth's atmosphere. Since only traces of ozone could be detected in the atmosphere at the earth's surface, Hartley concluded that the ozone must be at a considerable elevation. In 1920 Fabry and Buisson, at the University of Marseilles, measured the ultraviolet end of the sun's spectrum very carefully, and from these measurements and previous laboratory measurements which they had made upon known amounts of ozone, concluded that the total amount in the earth's atmosphere was equal to a layer of the pure gas about 3 millimeters thick at standard temperature and pressure. Subsequent measurements have confirmed this, and we now know that ozone is distributed in the earth's atmosphere in amounts dependent upon the latitude and the season of the year. This is important to us, since fluctuation in this amount of ozone causes a very large fluctuation in the amount of ultraviolet light reaching the earth's surface at the limit of the sun's spectrum.

The profound effect of ozone is evident from an examination of its absorption spectrum. This is shown in figure 3 in the form of a plot of optical density (logarithm to the base 10 of the reciprocal of the transmission) as a function of wave length. The very rapid increase in absorption at wave lengths below 3200 angstroms is evident from an inspection of this curve.

Recently automatic instruments have been devised for measuring by spectroscopic means the amount of ozone over any given station and recording this amount from hour to hour. As might be expected, fluctuations do occur, although the average amounts for any given week or month appear to follow the general seasonal and latitude distribution. In figure 4 is shown the day-to-day variation of ozone in a zenith atmosphere over Rochester, N. Y. (latitude  $43^{\circ} 7' N.$ ), for 4 weeks in the summer. The two curves labeled "3050 A." and "3110 A." are simply independent determinations of the same quantity and will be seen to be very consistent.

Not only the amount of ozone in a zenith atmosphere but the angle at which the sun's rays pass through the atmosphere is of importance in determining the ozone absorption. This will be evident from considering the path of solar rays through the atmosphere when the sun is, say,  $30^{\circ}$  above the horizon. For this condition (a zenith angle of  $60^{\circ}$ ) the light path will be increased by the secant of  $60^{\circ}$ , or by a factor of 2. This is referred to as air mass 2, air mass 1 being the mass of air through which light must travel in passing through a zenith atmosphere.

A striking example of the influence of sunlight upon man is found in the disease of rickets. Affecting infants and young children, it was long known to be associated with dietary deficiencies and particularly with a deficiency of fats. Cod-liver oil was known to be an

important remedy and to be much superior to other fats for this purpose. In 1890 Palm, observing that rickets was more prevalent in the Temperate Zones than in the Tropics, and that there appeared to be seasonal variations, attributed this to the influence of sunlight. However, for many years thereafter little attention was paid to Palm's work, and the relation of light to rickets was considered incidental. In 1919, however, Huldchinsky, working with undernourished children in Vienna following the war, found that rickets could be cured by exposure of the affected child to ultraviolet light from a mercury arc. This surprising result was soon confirmed by workers in various parts of the world, notably by Hess and his associates. This discovery that exposure of a child to light could com-

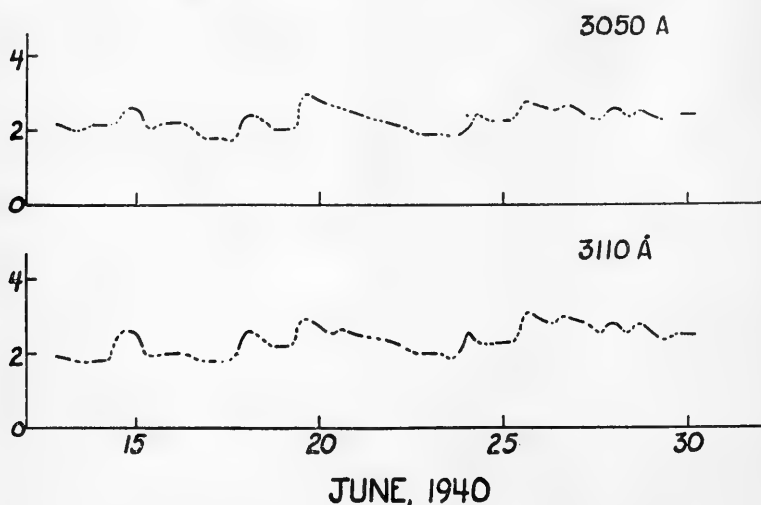

FIGURE 4.—Daily variations in quantity of atmospheric ozone.

pensate for a deficiency in diet was of great significance. Closer attention was directed to the fats, and in 1924 Steenbock and, independently, Hess reported that fats and oils which were not curative in rickets could be rendered potent by exposure to ultraviolet light. It became evident that the active principle, or vitamin D as it was called, was being formed from some provitamin by the action of light. Numerous investigations by Hess and his associates, by Rosenheim and Webster, by Windaus, and by others too numerous to mention here, demonstrated that ergosterol, first isolated by Tanret in 1889, is a parent substance from which vitamin D is produced by ultraviolet radiation.

At first it appeared that only from ergosterol could vitamin D be formed. However, discrepancies were soon noted in the vitamin-D potency of irradiated preparations when tested on birds (usually the

chicken) as compared to tests on mammals (usually the rat). This led to the discovery that at least one other substance, 7-dehydro-cholesterol, could be converted into vitamin D by exposure to light. Ergosterol is a characteristic plant sterol, while 7-dehydro-cholesterol is a sterol found in animal substances. It seems probable therefore that it is 7-dehydro-cholesterol and not ergosterol which is acted upon when human skin is exposed to sunlight, and so converted into vitamin D, which, entering the peripheral blood stream, prevents or cures rickets in the child so exposed. It was first shown by Kon, Daniels, and Steenbock that the quantum efficiency of the photochemical reac-

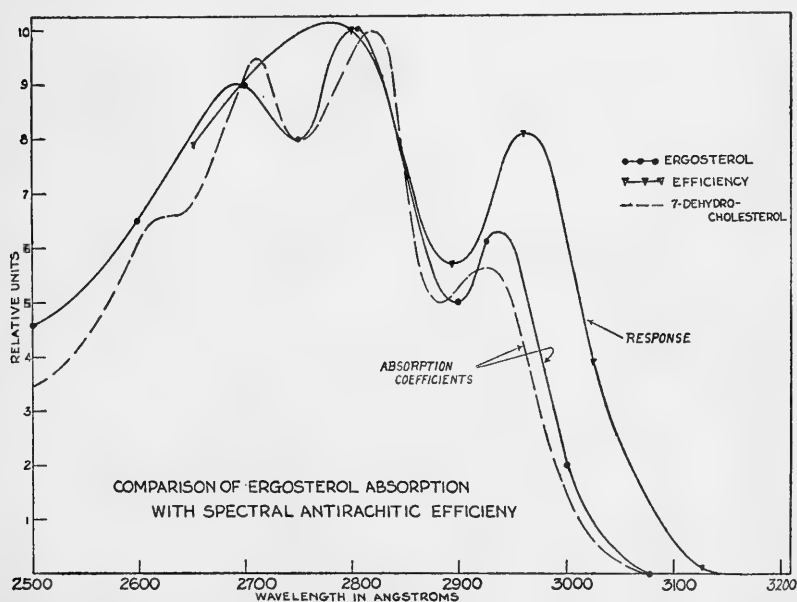

FIGURE 5.—Ultraviolet absorption of provitamin sterols and relative antirachitic reaction.

tion converting the sterol into vitamin D is substantially independent of wave length, and there is reason to expect such a result. This would mean that the energy efficiency of the reaction could be arrived at from the characteristic absorption of the sterols as a function of wave length. These absorption curves are shown in figure 5, and it should be necessary only to divide the ordinates by the energy value of the quantum at each wave length (i. e., multiply the ordinates by the wave lengths) to obtain the spectral-response curve. However, such a spectral-response curve would be correct only when the sterol was irradiated in dilute solution and in the absence of other contaminating substances exhibiting masking absorptions in the same spectral regions. In animal skin the condition of dilution is no doubt

fulfilled, but many other light-absorbing substances are present. It is not surprising, therefore, that the spectral response for the antirachitic effect of ultraviolet radiation directly upon the animal's skin should be modified somewhat from the response of the pure sterol. Knudson and Benford have measured this response in albino rats, their results being shown also in figure 5. The response in human skin may not be identical with that occurring in the albino rat, but may well be very similar, so the results of Knudson and Benford present the best approximation to date.

In order that we may calculate the antirachitic effect of sunlight<sup>2</sup> under a variety of conditions when acting directly upon animal skin, it is necessary that we know more than the spectral response per unit energy shown in figure 5. In addition, it is necessary to have the spectral-energy distribution at the short-wave-length end of the sun's spectrum for the several conditions under which we wish to calculate the effect. Because of the strong selective absorption by ozone in this region of the spectrum, the energy is dropping rapidly as one proceeds to shorter wave lengths. For this reason the usual thermal method for measuring spectral-energy distribution is not as satisfactory as are certain photographic procedures. In these, suitable precautions must be taken as have been described elsewhere, and a double dispersion spectrographic instrument must be used to eliminate the effects of scattered light. The details of these measurements will be published elsewhere. The results are shown in figure 6 for the spectral intensity of solar radiation as received at the earth's surface at sea level through a clear zenith atmosphere (air mass 1) for two ozone quantities. The upper curve is for total ozone in a zenith atmosphere equal to 2.0 millimeters of the pure gas at standard temperature and pressure, while the lower curve is for 2.8 millimeters of ozone under the same condition. These curves have been smoothed to eliminate the Fraunhofer structure while still preserving the correct average ordinates over any small wave-length interval. This is to simplify the graphical integration to be carried out as described below.

In general, sunlight must reach the earth's surface after passing obliquely through the earth's atmosphere at some angle  $Z$  with the zenith. This results in an increase in path through each stratum of the atmosphere in the ratio of the secant of the zenith angle. The resultant increase in absorption by the ozone and increase in scattering by the air molecules can be calculated. The result is shown in the curves of figures 7 and 8 for a series of air masses (i. e., secants of the zenith angle), and for two quantities of ozone, 2.0 and 2.8 millimeters S. T. P. in a zenith atmosphere.

<sup>2</sup>The writer wishes to acknowledge the assistance of Mrs. F. Dana Miller in making calculations on antirachitic effects under a research grant from the Wisconsin Alumni Research Foundation.

The antirachitic effect of sunlight for the several conditions of ozone and air mass can now be calculated at each wave length by multiplying the antirachitic response per unit energy (fig. 5) by the solar energy at that wave length (figs. 7 and 8). This has been done and the product at each wave length plotted to form the family of curves in figures 9 and 10. For each condition of ozone and air mass the solar antirachitic effect is represented by the integral of the

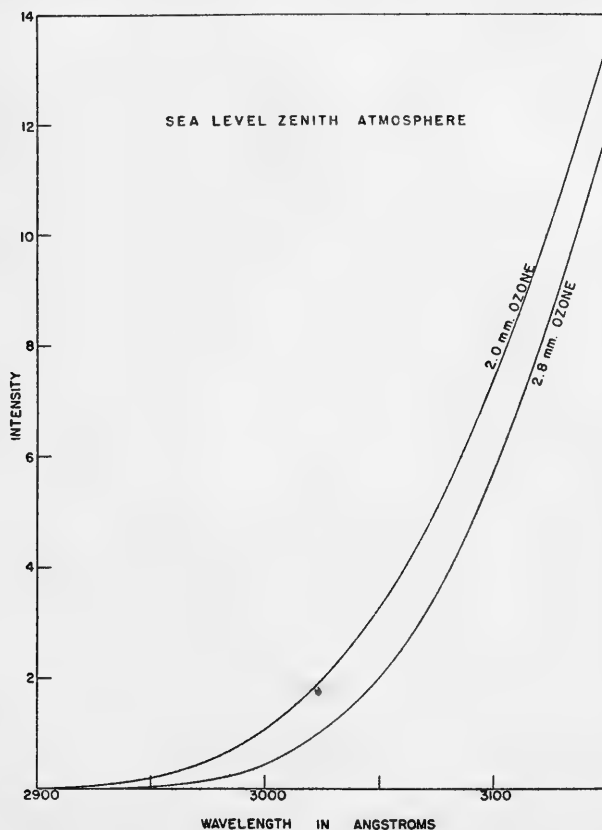

FIGURE 6.—Distribution of energy at the ultraviolet end of the solar spectrum at sea level through zenith atmosphere (air mass=1.0).

relative efficiency as a function of wave length. This is represented by the area under the appropriate curve of figure 9 or figure 10. The functions are not analytic, so the integration must be carried out by graphical or mechanical means, but this is easily done with the aid of a planimeter. The results of this integration are plotted in figure 11 in which the antirachitic efficiency of solar radiation is shown as a function of air mass for 2.0 and 2.8 millimeters of ozone S. T. P. in the atmosphere.

The significant feature of the curves of figure 11 is the rapid falling off of the antirachitic effectiveness of sunlight, with increase in atmospheric ozone and with increase in the air mass resulting from obliquity of the sun's rays. For air mass 2 corresponding to the sun  $30^\circ$  above the horizon it will be noted that the antirachitic effect is less than one-tenth that of the sun in the zenith under otherwise identical con-

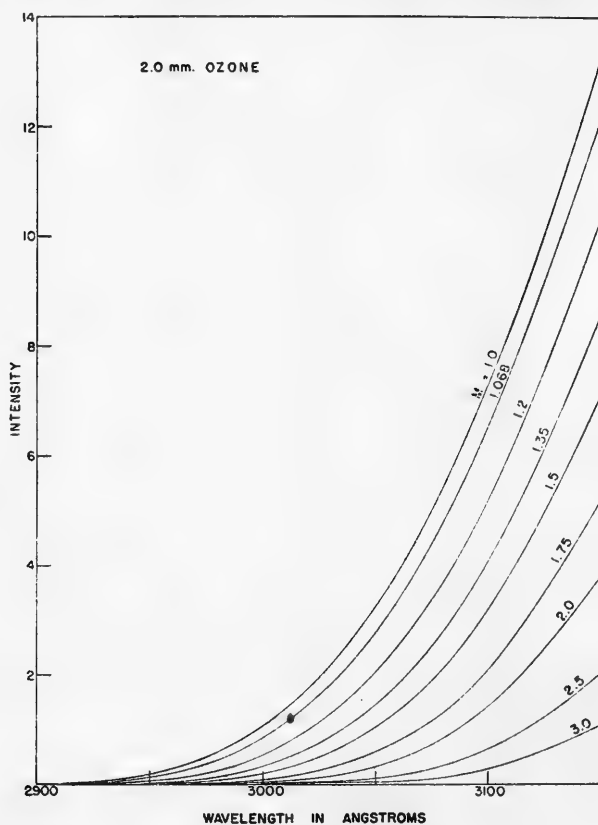

FIGURE 7.—Solar spectral-energy for various air masses. (2.0 mm. ozone in zenith atmosphere.)

ditions. For air mass 3 corresponding to the sun about  $20^\circ$  above the horizon the effect has fallen to about one-eightieth that of the zenith sun.

It now becomes possible to predict the antirachitic effectiveness of sunlight for a clear day at any point on the earth's surface at any season and at any time of day, providing only that the zenith ozone over the station be known. This has been carried out for latitudes  $33^\circ$ ,  $38^\circ$ , and  $43^\circ$ , and for the conditions of 2.0 and 2.8 millimeters of ozone, representing average low and average high ozone quantities

for the Temperate Zones. The results are shown in figures 12 and 13 for clear days at noon as a function of time of year. The scale of months is for north latitudes, but exactly similar curves will apply to south latitudes except that the scale for time of year must be shifted by 6 months from the indicated values. In order to show the effects of hour of the day at the three selected latitudes and for the

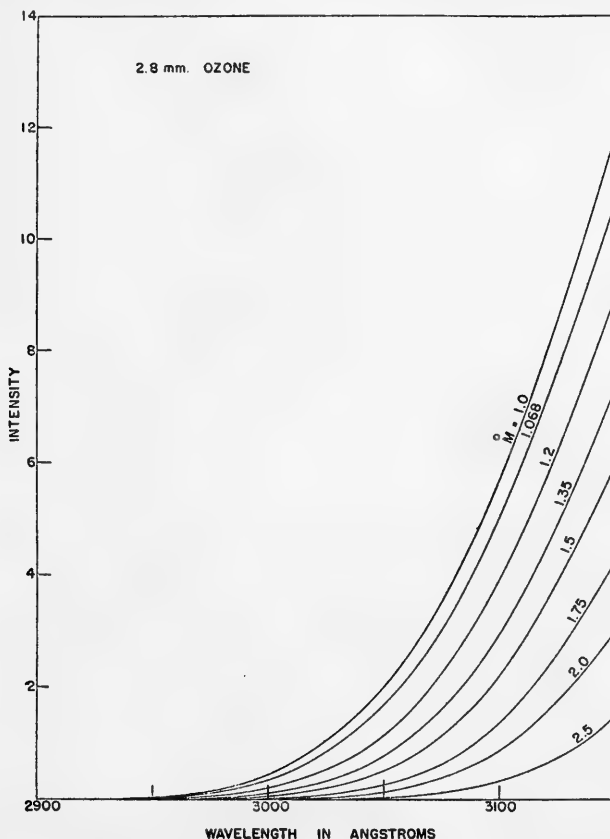

FIGURE 8.—Solar spectral energy for various air masses. (2.8 mm. ozone in zenith atmosphere.)

two selected quantities of ozone, it is necessary to plot six families of curves. These are shown in figures 14 to 19, inclusive. It will be noted that near midsummer the spread in latitude between  $33^\circ$  and  $43^\circ$  results in only a slight drop in the effectiveness of sunlight near noon, providing that the ozone is constant. In midwinter the effective change of latitude is far more important, the  $10^\circ$  difference between  $33^\circ$  and  $43^\circ$  resulting in a change in effectiveness of sunlight of more than fourfold.

The seasonal and geographic differences in antirachitic effect are more impressive when one considers the actual exposure to sunlight necessary to protect a child against rickets. This figure is not easy to arrive at, since it is difficult to control the factors in any single direct experiment with sufficient accuracy. However, there is indirect evidence from which we may arrive at 15 minutes' exposure per day of a nude child to zenith clear-day sunlight under tropical (2.0 millimeters ozone) conditions as entirely adequate to protect against rickets, even in the absence of other vitamin-D intake. A Negro

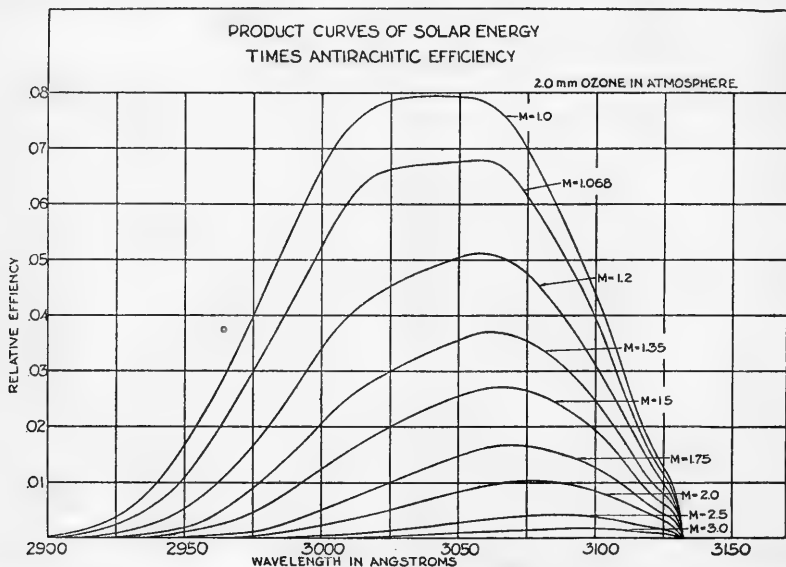

FIGURE 9.—Product curves of solar spectral energy by antirachitic efficiency. (2.0 mm. ozone in zenith atmosphere.)

child may require somewhat greater exposure because of loss of radiation in the skin pigment, although this is by no means demonstrated. If we use the above figure of 15 minutes per day, the scale is immediately set for figures 11 through 19. Thus for sun in the zenith and 2.8 millimeters ozone in the atmosphere, 27 minutes per day (clear sky) would be required. For midwinter conditions at the higher latitudes the exposures become so long as to be entirely out of the question. For example, in midwinter at 43° latitude with 2.8 millimeters ozone in the zenith atmosphere the exposure required even at noon on a clear day would be 66 times 15 minutes, or more than 16 hours, and even with only 2.0 millimeters of ozone in the atmosphere the expo-



sure required would be more than 7 hours! Evidently even in ideal weather one cannot rely upon direct exposure to winter sunlight in the higher latitudes, and it is upon the winter food supply that the population must depend except in tropical or semitropical latitudes. Actually much of the vitamin D in the food may have been sunlight-produced, but this topic lies outside of our present discussion.

The calculations thus far have been limited to the three latitudes  $33^\circ$ ,  $38^\circ$ , and  $43^\circ$ . In figure 20 is shown a reproduction of a United States Geological Survey map upon which these three latitudes have

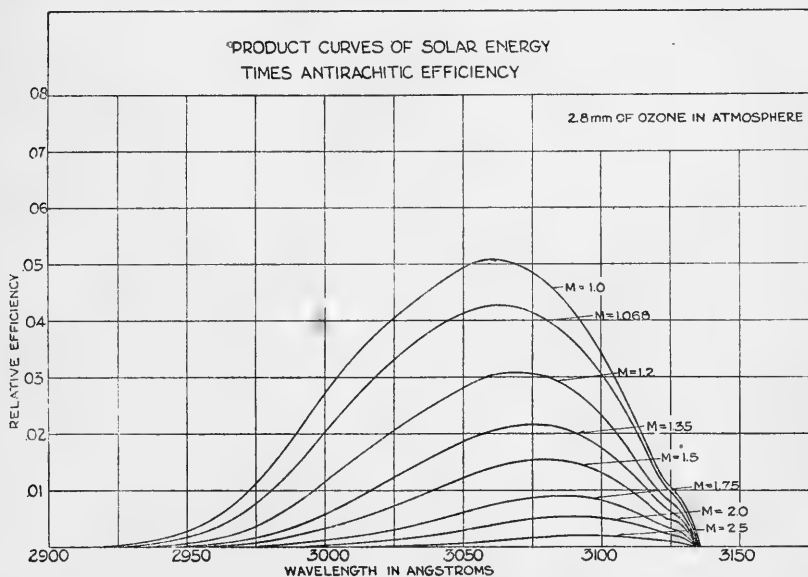

FIGURE 10.—Product curves of solar spectral energy by antirachitic efficiency. (2.8 mm. ozone in zenith atmosphere.)

been drawn. It will be seen that these latitudes are fairly representative of the United States, although significant areas of the country lies above  $43^\circ$  and below  $33^\circ$ . Similarly in figure 21 latitudes  $33^\circ$  and  $43^\circ$  north and south of the Equator have been drawn on a Mercator projection of the earth's surface. It will be seen that a substantial portion of the populated areas is included within these latitude belts. If one desires the antirachitic effect of sunlight outside these belts it is only necessary to determine the zenith angle of the sun for the place, time of year, and time of day with the aid of a nautical almanac. The secant of this zenith angle determines the air mass from which the relative antirachitic effect may be determined by reference to figure 11.

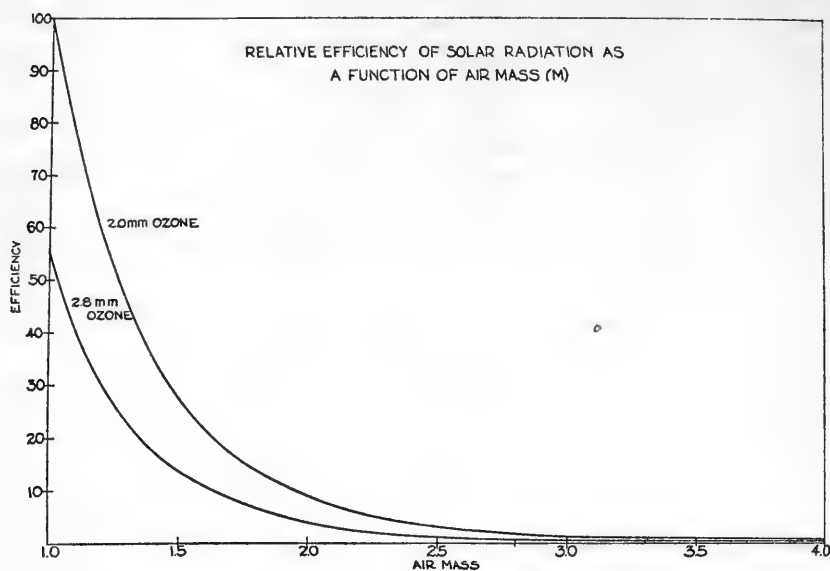

FIGURE 11.—Variation of solar antirachitic effect with air mass.

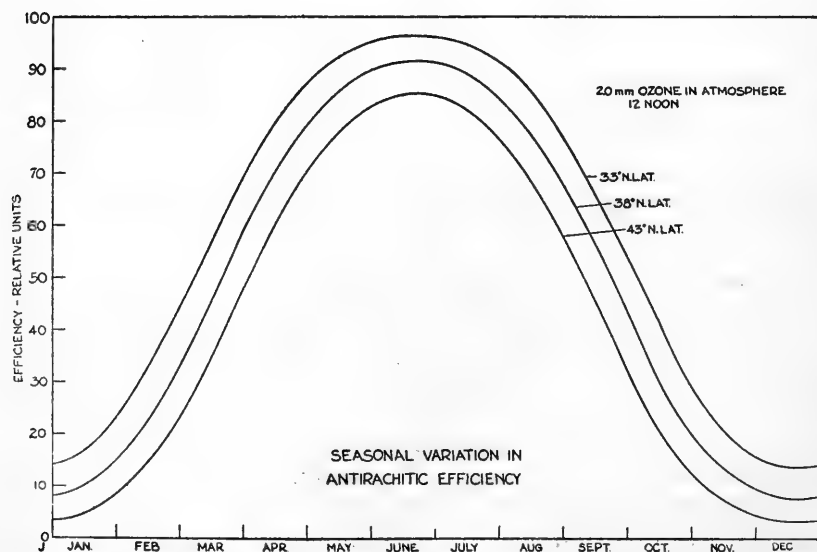

FIGURE 12.—Seasonal variation in solar antirachitic effect for three latitudes. (2.0 mm. ozone in zenith atmosphere.)

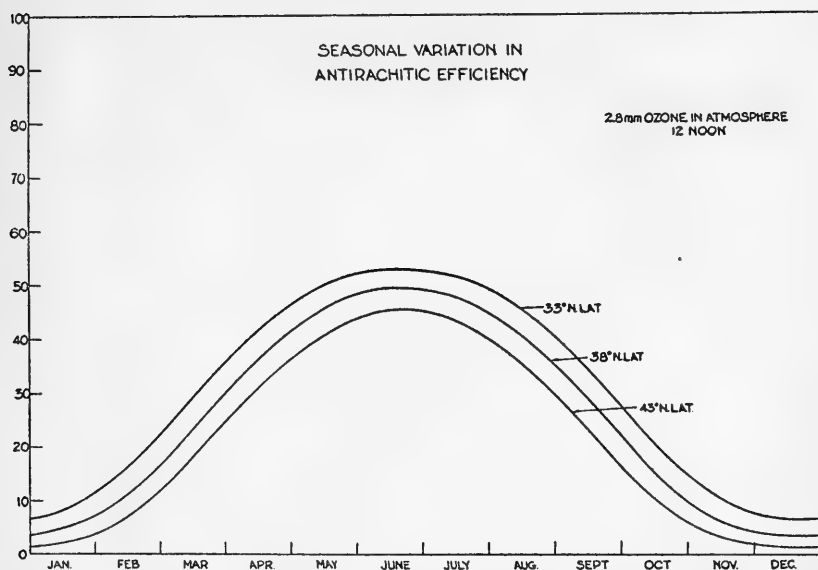

FIGURE 13.—Seasonal variation in solar antirachitic effect for three latitudes. (2.8 mm. ozone in zenith atmosphere.)

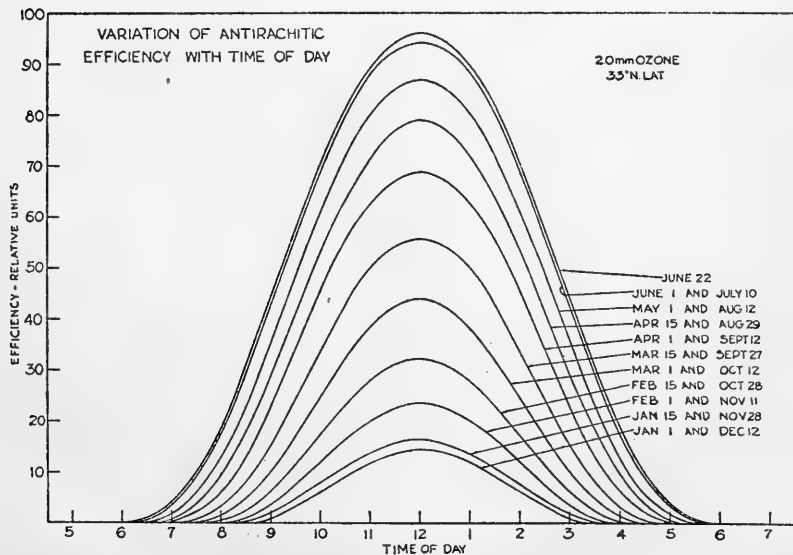

FIGURE 14.—Hourly variation of solar antirachitic effect. (2.0 mm. zenith ozone, 33° N. latitude.)

The phenomenon of sunburn is probably of less physiological importance than the antirachitic effect of sunlight, but it has seemed worth while to calculate the relative erythema production by sunlight for one latitude,  $43^\circ$ , and for one ozone quantity, 3.0 millimeters S. T. P. Using the data for erythema reaction per unit energy as a function of wave length shown in figure 2, the series of product curves shown in figure 22 have been calculated by the same procedure followed in obtaining the curves of figures 9 and 10. The integrals of these curves as represented by the area under each are shown in figure 23 and are analogous to the results plotted in figure 11. Finally, in figure 24 are shown the results for erythema reaction under sun-

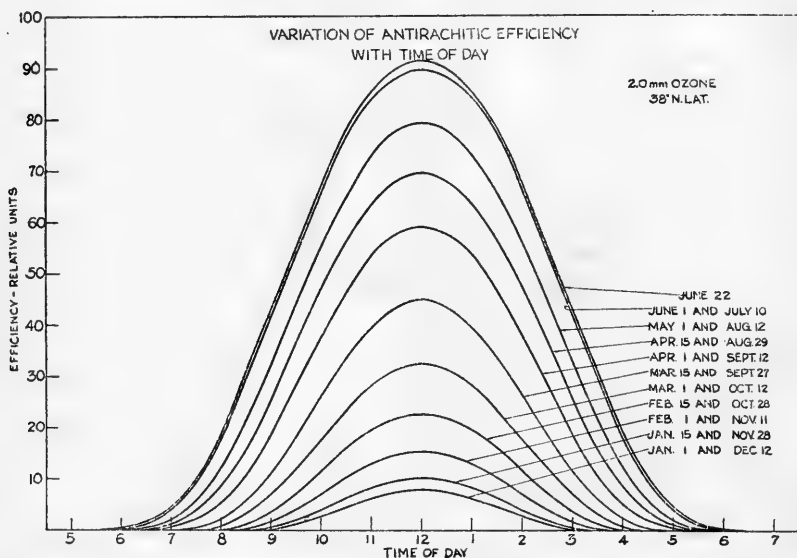

FIGURE 15.—Hourly variation of solar antirachitic effect. (2.0 mm. zenith ozone,  $38^\circ$  N. latitude.)

light at noon on clear days as a function of time of year for latitude  $43^\circ$  and 3.0 millimeters of ozone in the zenith atmosphere. The exposure to sunlight necessary to produce an erythema varies greatly among individuals and is dependent upon the condition of the skin. The skin of a sensitive individual not previously exposed to ultraviolet radiation will show an erythema reaction if exposed for about 15 minutes to zenith sunlight through 3.0 millimeters of ozone.

In contrast with the effects just discussed, the destruction of bacteria by ultraviolet light is a typical example of the influence of radiation upon micro-organisms. Also it is probable that its importance to the human race is as great as any of the reactions mentioned above, for by this means sunlight keeps bacterial growth in check. Because of the small size of the individual bacterium most of the ultraviolet radiation incident upon the bacterial cell passes on through,

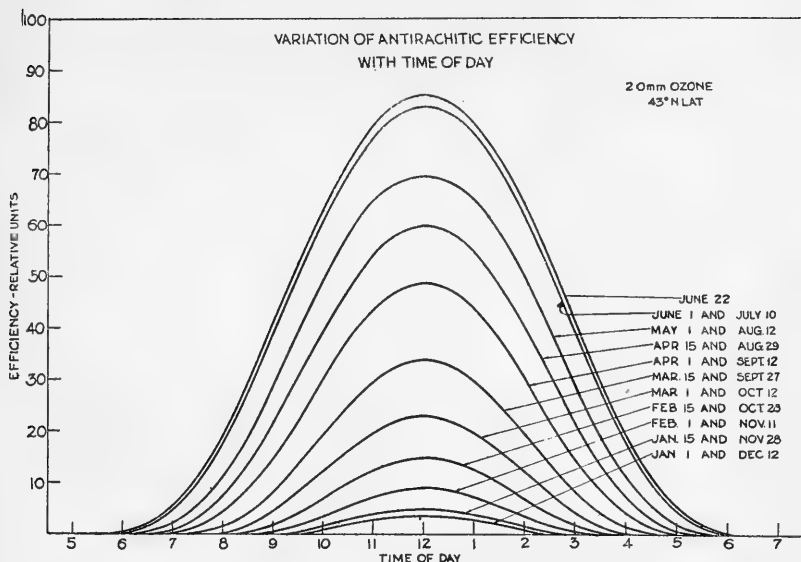

FIGURE 16.—Hourly variation of solar antirachitic effect. (2.0 mm. zenith ozone, 43° N. latitude.)

even in those regions of the spectrum where the specific absorption per unit thickness of bacterial protoplasm is high. Thus the primary photochemical reaction which results in the destruction of the organism may occur anywhere within the bacterial cell, and very possibly within some components of the cell nucleus.

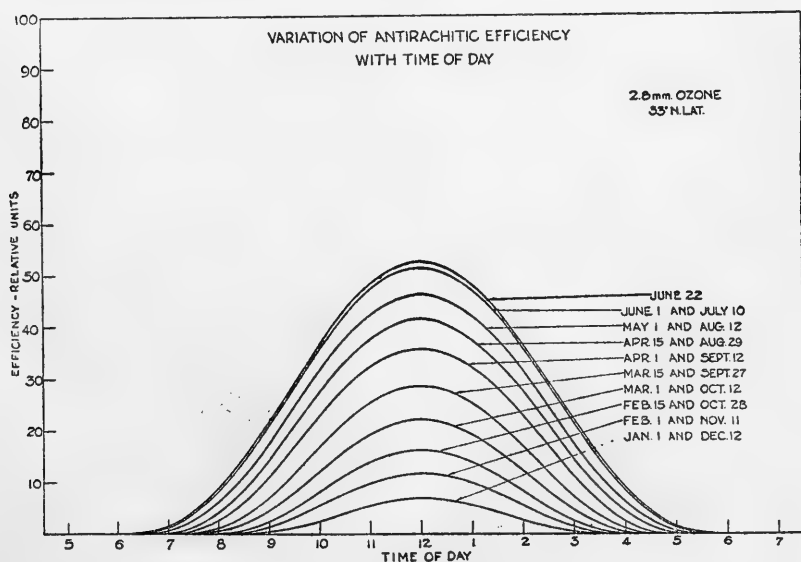

FIGURE 17.—Hourly variation of solar antirachitic effect. (2.8 mm. zenith ozone, 33° N. latitude.)

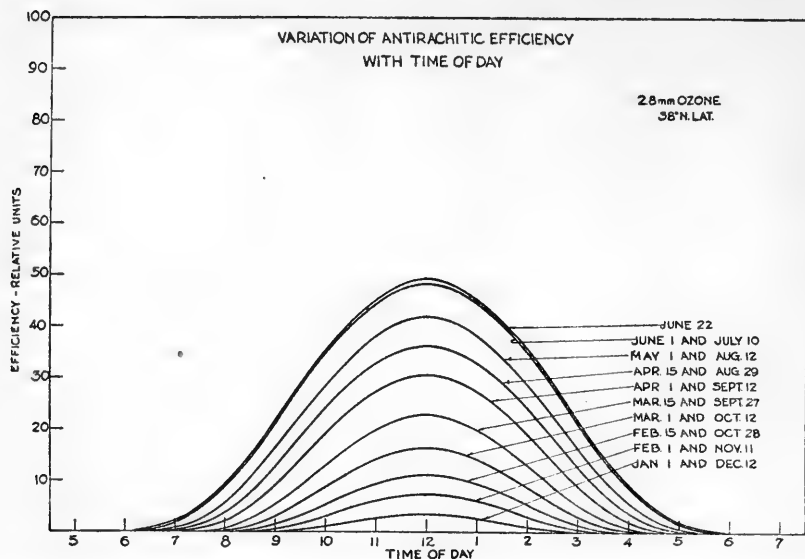

FIGURE 18.—Hourly variation of solar antirachitic effect. (2.8 mm. zenith ozone, 38° N. latitude.)

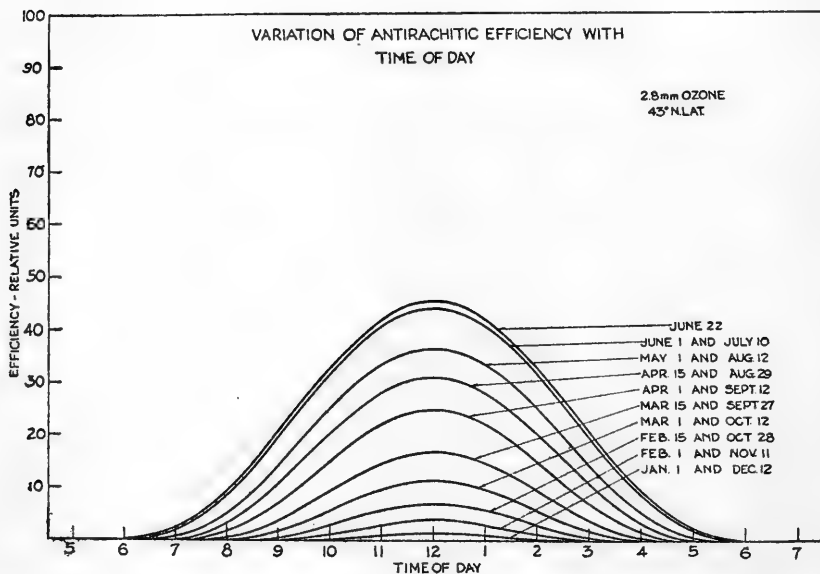

FIGURE 19.—Hourly variation of solar antirachitic effect. (2.8 mm. zenith ozone, 43° N. latitude.)



FIGURE 20.—Latitude belts across the United States for which solar antirachitic effects have been calculated.

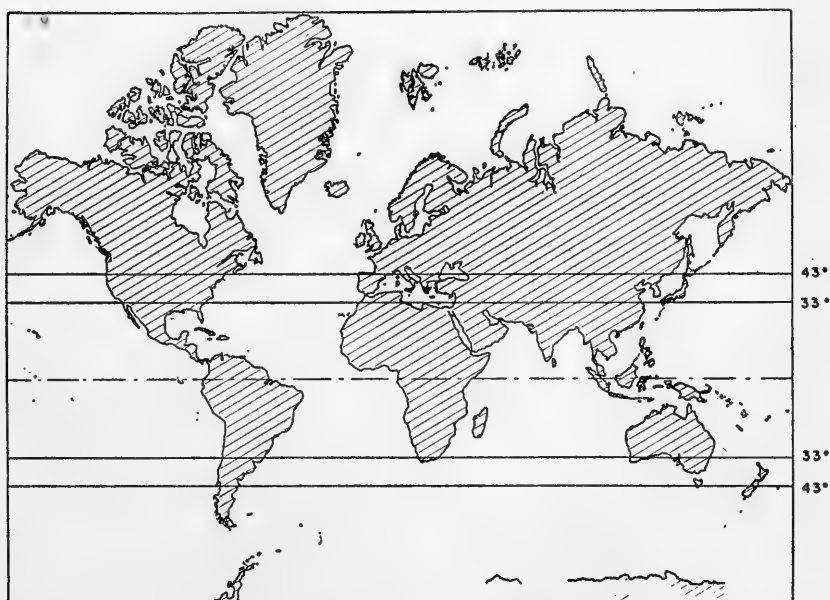

FIGURE 21.—Latitude belts on the earth's surface for which solar antirachitic effects have been calculated.

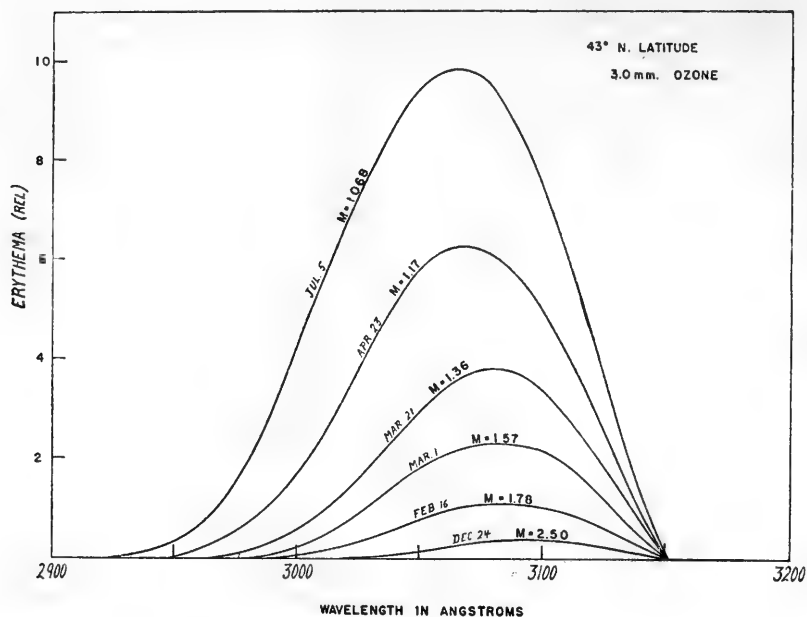

FIGURE 22.—Product curves of solar spectral energy by erythema efficiency. (3.0 mm. ozone in zenith atmosphere.)

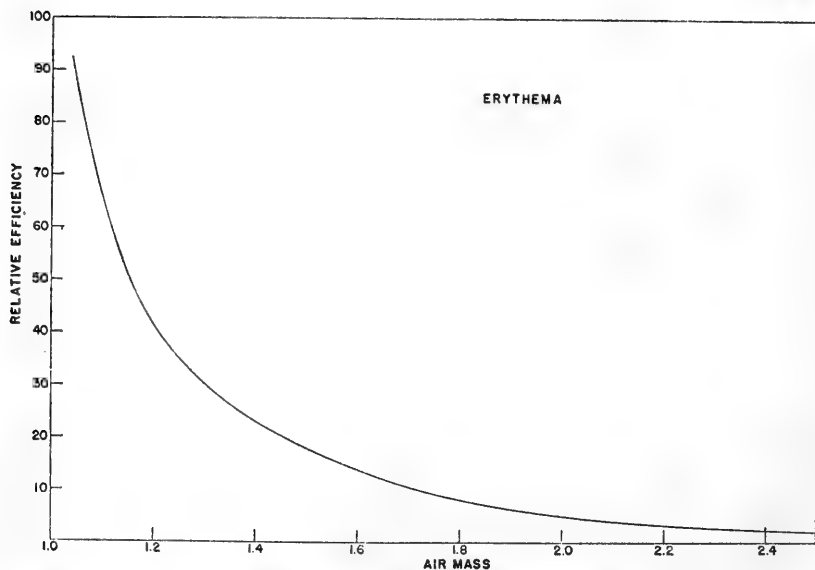

FIGURE 23.—Variation of solar erythema effect with air mass. (3.0 mm. ozone in zenith atmosphere.)



As early as 1877 Downes and Blunt investigated the destruction of putrefactive bacteria by sunlight and made rough measurements of the relative action of different colors. There followed many investigations of the effect of ultraviolet light on bacteria, but the spectral-response curve for this reaction was not determined for more than 50 years. It was measured by H. W. Lyall and myself in 1926 and independently by Sonne in 1927. We had expected the spectral-response curve to be quite different for different bacteria, but to our surprise eight pathogenic and two saprophytic organisms showed surprising similarity in spectral response, although those selected included cocci, Gram-negative bacilli, and two acid-fast strains. Our most complete

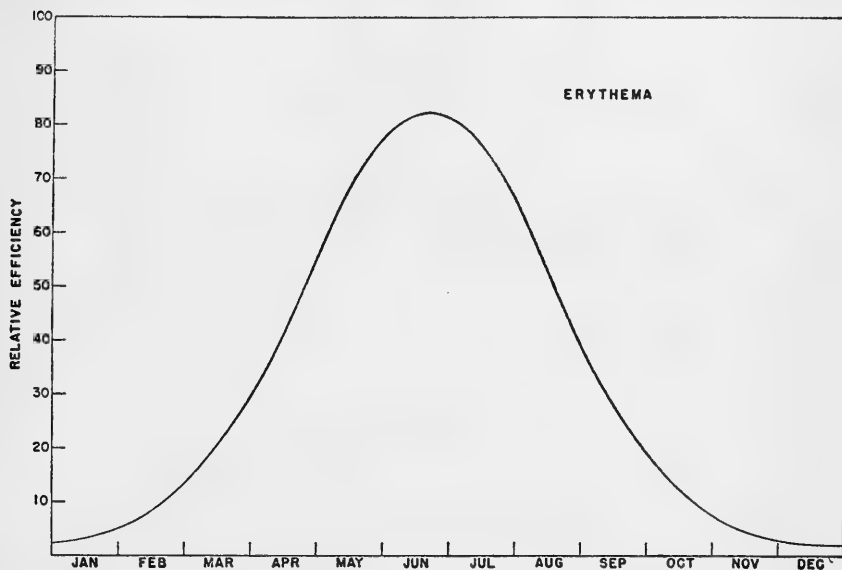

FIGURE 24.—Seasonal variation in solar erythema effect. (3.0 mm. zenith ozone, 43° N. latitude.)

work was done with a strain of *Staphylococcus aureus*. The spectral response of this organism is shown in figure 25. It is interesting to note that Sonne's measurements on the colon bacillus agree almost perfectly with this curve, although the characteristics of the colon bacillus are different in every respect from those of *Staphylococcus aureus*. More recently similar measurements have been made by Gates, with good agreement over part but not all of the spectral range.

We may calculate the seasonal variation in the bactericidal effect of sunlight by following the same procedure already applied to the antirachitic and erythema reactions. This has been carried out to form the product curves of figure 26, for the condition of 3.0 millimeters of ozone in the zenith atmosphere. The integrals of these

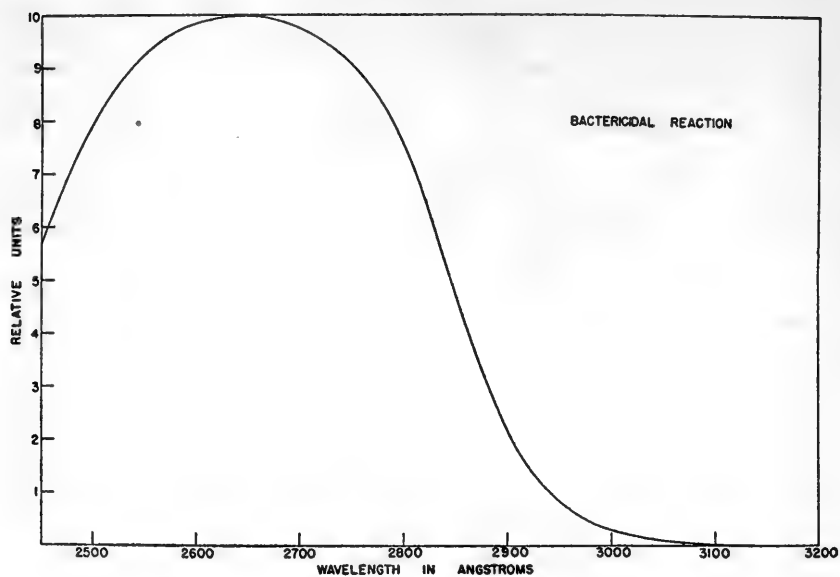

FIGURE 25.—Variation of bactericidal effect with wave length.

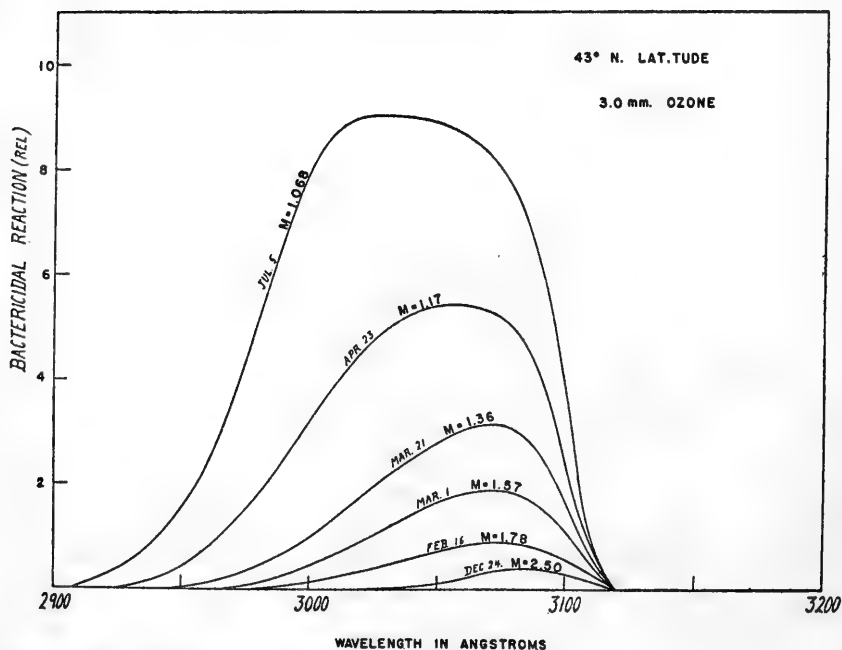

FIGURE 26.—Product curves of solar spectral energy by bactericidal efficiency. (3.0 mm. ozone in zenith atmosphere.)

curves (i. e., the areas under each curve) are plotted in figure 27, showing the bactericidal effect of sunlight as a function of air mass for 3.0 millimeters of ozone in a zenith atmosphere. In figure 28 is plotted the bactericidal effect as a function of time of year for clear days at noon, 43° N. latitude. Although the general trend of this curve with time of year is similar to the curve for antirachitic and erythema effects, it will be noted that the summer-to-winter difference is even greater. Because of this the effective bactericidal action of sunlight is even more dependent upon short air path (sun near

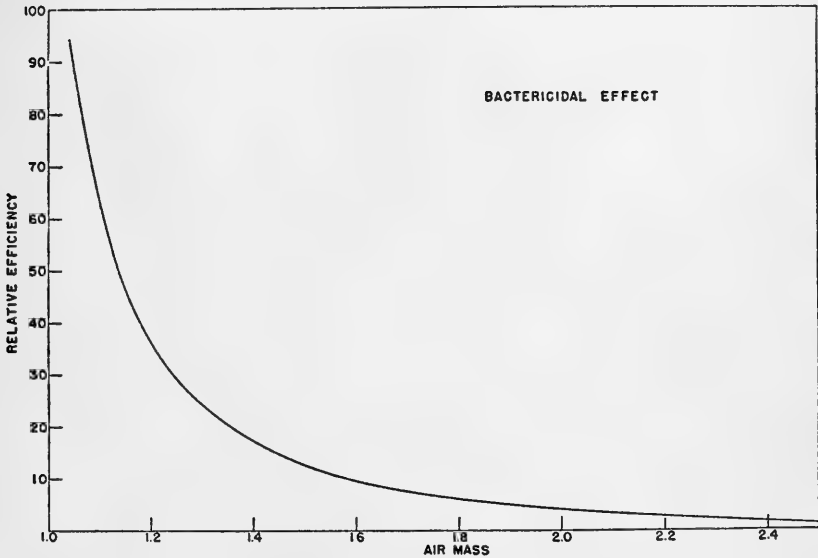

FIGURE 27.—Variation of solar bactericidal effect with air mass. (3.0 mm. ozone in zenith atmosphere.)

zenith) than are the antirachitic and erythematous reactions. Thus the effects of latitude, time of year, and time of day are all more pronounced.

In spite of the similarity in the spectral sensitivity of different bacteria to ultraviolet light, there is a considerable difference in the absolute exposure necessary to destroy different strains. Acid-fast organisms, such as the tubercle bacillus, are relatively resistant to ultraviolet light and require for their destruction an exposure of about 14 minutes to zenith sunlight through 3.0 millimeters of ozone. Certain Gram-negative organisms, such as the colon bacillus and particularly *Bacillus paratyphosus B*, require an exposure of only about 2 minutes to sunlight for complete destruction. Most pathogenic bacteria appear to lie between these two extremes as regard sensitivity to ultraviolet light. From this the scale can be set for figures 27 and 28.

It will be seen that even very resistant bacteria are quickly destroyed by summer sunlight, but that even the more sensitive organisms will not be destroyed by all-day exposure to midwinter sunlight in the higher latitudes.

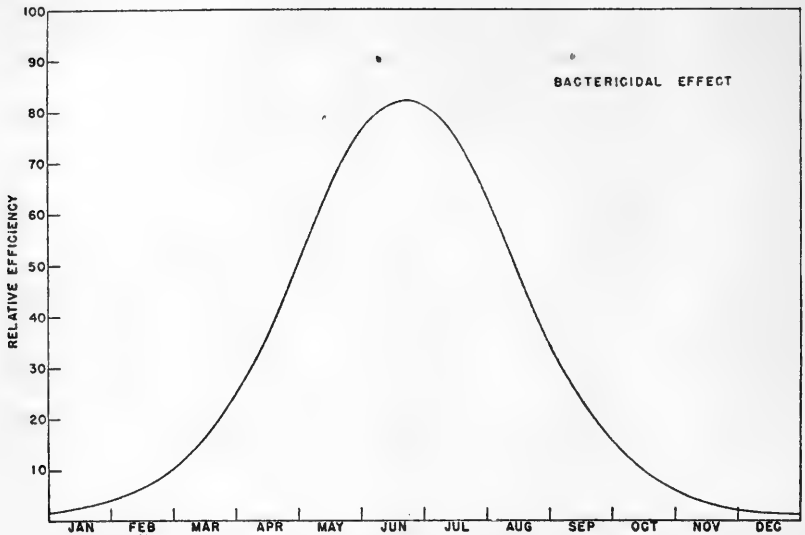

FIGURE 28.—Seasonal variation in solar bactericidal effect. (3.0 mm. zenith ozone, 43° N. latitude.)

It is difficult to evaluate the full significance to the human race of this solar bactericidal action. Ultraviolet radiation from the sun and desiccation are the two great natural agencies for destroying bacterial growth, and of these the former is probably the more important. Here again man's very existence must depend upon ultraviolet radiation, without which bacteria and other micro-organisms would crowd him from his place in the sun.



1. Using only ultraviolet radiation of wave length 3300-3900 A.



2. Using only infrared radiation of wave length 7600-8000 A.

PHOTOGRAPHS ON PANCHROMATIC FILM OF UNPIGMENTED SKIN  
AND MAGNESIUM CARBONATE COMPARISON BLOCK.



## THE SEA AS A STOREHOUSE<sup>1</sup>

---

By E. F. ARMSTRONG, D. Sc., F. R. S.

---

[With 4 plates]

In an island country the quest for relaxation normally brings the great majority of us to the coast for holidays, where we make acquaintance with the sea and perhaps also with some of its wonders and the things which live and grow in it. Many people cross the narrow seas to the continent, in others the urge of discovery takes them across the oceans: all are conscious of the immensity of the sea and the fact that it is salt.

Saltiness is an indication that substances in some quantity are dissolved in the water, largely common salt, which in many lands is won from the sea by solar evaporation. Sea water contains appreciable quantities of other salts besides sodium chloride, in particular of magnesium and potassium sulfates and chlorides. More complete analysis has disclosed the presence of quite minute quantities of other elements present to the extent of 1 part in 1,000 or less, and still others present in even more minute quantity; and a little reflection shows that this must be so, for the oceans are the ultimate receptacle of everything that is washed from the land by the rain and carried by the rivers into the sea. This includes both dissolved and suspended matter.

The wind and the rain and frost—the agencies of destruction and denudation—break down the hills and scour the valleys. Acid waters on the moors, neutral or alkaline waters on the plains, salt water in the sea, all act to bring into solution traces of the most sparingly soluble substances. The quantity of any one of the rarer constituents of the earth's crust in a million parts of sea water is minute and, indeed, many are only detectable by the most refined methods of the analytical chemist. Some, indeed, can only be found in the ashes of plants.

About three-fourths of the earth's surface is water. In bulk this is estimated to amount to 300 million cubic miles.

A cubic mile seems to be a handy unit for statistics regarding the content of minerals. It is, however, a gigantic unit, for in round figures it will contain 6 million tons of magnesia, 4 million tons of potash,

---

<sup>1</sup> Reprinted by permission from *Discovery*, March 1943.

117 million tons of common salt, and some 300,000 tons of bromine, which is present to the extent of less than 70 parts per 1 million of sea water.

Such quantities, if extracted, would satisfy the world for a considerable time, while a cubic mile of sea is not out of range of a single plant located on an ocean seaboard. The sea clearly forms an inexhaustible storehouse of minerals, provided that man can find out how to recover them individually at prices comparable with the cost of winning the same substances from the earth.

#### THE COMPOSITION OF OCEANS

Before describing what has been done in this direction, it is well to devote a few words to the composition of the oceans. One theory is that they have been salt from the beginning rather than the alternative theory that they have become so by washing out of salts from the land and gradual concentration by evaporation of the oceans. This hypothesis is based on the great similarity between the salts of the ocean and the gaseous products of volcanic eruptions rich in chlorides and sulfates of all kinds. The theory explains the main constituents, though it does not necessarily apply to the trace elements where any postulate of constancy of composition is untenable.

Apparently the first quantitative analyses of sea water were made by Lavoisier in 1872.

It transpires that the variations in the proportions of individual salts to the total salts are very small; sea water may be regarded as of constant composition, the individual ingredients being considerably dissociated in the dilute solution. This interdiffusion accounts easily for the uniformity of composition of sea water throughout the whole ocean, so that the only appreciable difference from point to point is the total salinity of the mixed solutions.

In each of the three oceans the salinity is lower in the equatorial regions where the rainfall is high; there are two maxima—one in the north, the other in the south tropical belts where evaporation predominates; at the Poles there are regions of lower salinity. The North Atlantic maximum is the highest at 37.9 parts per 1,000 salinity; as a whole, the Atlantic has the highest salinity of 35.37. The average of the whole surface of the oceans may be taken as 34.5. There is a general increase of salinity with depth.

Common salt is essential to both man and beast; we need more salt as the proportion of meat we eat diminishes. In Britain and elsewhere there are large deposits of pure salt resulting from the drying up of inland seas in past geological ages. This is recovered by mining or more generally by dissolving the salt underground, pumping up the brine, and evaporating it. The export of salt from England has



long been a significant part of our overseas trade: it is the foundation stone of the heavy chemical industry, and salt and the "heavy chemicals" made from it have helped to make Liverpool one of the world's greatest ports.

Less favored countries where, however, evaporation exceeds precipitation of water are driven to making an impure salt from the sea by allowing it to evaporate in basins in the heat of the sun until it crystallizes. This is termed solar salt.

In England the deposits of salt are not capped with beds of magnesium and potash salts, but at Stassfurt in Germany there is a great thickness of these; and it would seem that in geological times a lake approximating closely in composition to sea water had dried up completely here leaving everything behind. Stassfurt in consequence enjoyed a virtual monopoly in the production of potash salts and of bromine.

The Dead Sea, and certain lakes in America, represent inland seas evaporated almost to the point of crystallization in which, however, the salts have a different composition than in sea water. Sulfates, for example, are absent from the Dead Sea, a fact which makes the isolation of the other salts more simple. In such lakes it is possible to assume that the salt is derived from rivers or underground springs, which themselves pass through and leach out earlier deposits.

At Seales Lake in California, where evaporation is nearly complete, the salt crust has the appearance of a frozen waste and is so hard that a motorcar may be safely driven over it. At first potash and borax were made from the deposits; a byproduct is burkeite, a remarkable double salt of sodium carbonate and sodium sulfate. This lake also serves as a source of more than half the world's very tiny production of lithium salts. Lithium is an odd element; it is allied to sodium and is beginning to find commercial applications which will no doubt multiply when it is available in quantity at an attractive price. Sea water contains about 1 part in 10 million lithium.

#### BROMINE

Apart from the quite minor amount of solar salt produced, the mineral reserves of the ocean had not been tapped until a start was made with the recovery of bromine in 1924. There is the same element of romance in tapping the resources of the ocean as in turning to practical use the rare gases of the atmosphere: in both the elements sought are present in minute proportions, both are all around us in unlimited quantities.

Bromine in the past was largely a Stassfurt monopoly and expensive; it was used in photography, drugs, and dyestuffs in quantities measured in pounds rather than tons. The need for it in

quantity arose out of the search for substances which could be added to petrol to prevent the engines of automobiles knocking. Midgley solved this problem with a chemical known as tetraethyl lead dissolved in ethylene bromide—the substance marketed as “Ethyl.” At once very large quantities of bromine were needed, and a new cheap source out of the control of the monopoly had to be found.

Work was begun in 1924 by a process which involved the addition of aniline to chlorinated sea water to form tribromoaniline. After laboratory trials the process was operated on board a boat, the *S. S. Ethyl*, fitted out as a chemical factory.

This sailed off the coast of North Carolina and the voyage was successful though it was not repeated. The experience gained was applied to an alternative method which consists in (a) oxidizing the bromide in brine with chlorine, (b) blowing the free bromine out of solution with air, (c) absorbing the bromine with an alkali carbonate solution from which it can be recovered in a commercially desirable form.

Every stage in this process had to be carefully worked out in the laboratory. Sea water is alkaline, the equivalent of 1 ounce of caustic soda in 1,000 tons of water. Even this small quantity gives conditions unsuitable to the oxidation. Acid must be added, the right quantity being 0.27 pound of 96 percent sulfuric acid per ton of sea water. These figures are quoted to show the layman how sensitive chemical reactions are to small things, in particular to the acid-alkali reaction of the medium. The biochemist has of late years discovered that the reactions in the living body are even more sensitive to these acid-alkali variations.

The conditions of the operations having been settled by the chemist, the next step is for the engineer to design a plant (a) to carry out the chemical changes, (b) to bring the water from the sea in the required large quantity.

It requires 4,000 gallons of sea water to yield 1 pound of bromine, so that a factory making 15,000 pounds a day must be able to pump 60 million gallons. The engineering problem of the intake of such quantities, the freeing of the water from extraneous matter and sediment and its delivery continuously to the plant, all at low cost, has been one of the first magnitude; it required great ingenuity and foresight. It is clear that it would not do to put the extracted water back in the sea. It has to be discharged some way off, for example, on the other side of an isthmus where the set of the currents prevents its mixing with the untreated incoming water. Obviously the choice of location of a sea-water plant is both all-important and limited.

When the operations are all finished the bromine is obtained in liquid form. Its transport requires special bottles and is costly. It is therefore at once converted on the same site into ethylene bromide.

The first bromine recovery plant, started in 1934, worked efficiently from the outset, producing 15,000 pounds of bromine per day; the yields over all were high. Many thousands of tons are now produced per annum, and bromine today belongs to the class of substances of which the cost is reasonable and the supply assured for all time. The chemical engineer and the Dow Chemical Co. have had their first victory over the sea.

Calculations indicate that there are nearly 1 billion tons of bromine in the Dead Sea. As this sea is evaporated to the point of crystallization of the sodium chloride the concentration of bromine is nearly 90 times that in the seven seas, and the ease and cost of its recovery should be less. However, the possibilities of obtaining low costs are superior in industrial America to what they are in Palestine; moreover, any bromine produced here is a long way from the user. It is probable therefore that bromine from the sea will always remain competitive with that produced in Palestine, while users will have the advantage of reasonable prices brought about by such rivalry.

Dr. Ernst Bergmann in his paper before the recent British Association Conference on Mineral Resources, reminds us that the Middle East shows a certain affinity to bromine. He recalls that the antique purple, used in the Imperial toga, manufactured in Sidon and Tyre, is a coloring matter containing bromine. Tyrian purple is one of the few known organic bromine compounds found in a living cell. The purple snail from which it was obtained is one of the several known strange instances, of which more anon, of selective affinity of cells to a special element.

Dr. Bergmann makes the interesting suggestion that in past ages vast numbers of maritime organisms containing bromine have decayed in the soil in Palestine, and that today the hot springs of the Sea of Galilee derive their bromine from this source. It is probable that all the bromine in the Dead Sea is derived from these springs.

#### MAGNESIUM

This success with bromine partly prepared the way for the next problem, the recovery of magnesium. On January 21, 1941, the first commercial ingot made in America from sea water was produced in the plant of the Dow Company at Freeport, Tex. The urge was again economic; the demand for magnesium for aircraft parts suddenly reached vast proportions, for as much as 1,000 pounds may enter into the manufacture of a single plane. Magnesium, the lightest of metals, cost a sovereign a pound in 1915 and barely a shilling last year. The metal was first made around 1869, mainly as a source of high-intensity light for photographic purposes. Later sundry other uses, including fireworks, came along. It awaited war to start its use in airplanes,

incendiary bombs, and military pyrotechnics. Today tens of thousands of tons are required.

Magnesium in combination is one of the most abundant elements on the earth's crust. The most favored source is magnesite, which in particular is used for refractories. Other sources are dolomite, which consists of calcium and magnesium carbonates, and carnallite from Stassfurt, which is a double chloride of magnesium and potassium.

If the metal is to be made by electrolysis—hitherto the favored process—magnesite has to be converted into chloride by briquetting the calcined material with carbon and binding substance and exposing to the action of chlorine in an electric furnace. Since in the course of electrolysis chlorine is evolved, the process becomes in theory cyclic, although in practice there is waste through formation of hydrogen chloride.

Faced with the large new requirements, the sea seemed an obvious source of magnesium chloride. The knowledge about the intake of sea water and the location of a plant was available. In addition, cheap power and plentiful supplies of lime, the other necessary raw material, were requisites. The latter also came from the sea in the form of oyster shells dredged from the bottom of Galveston Bay, which, when washed, go straight to the lime kiln. Some 300,000,000 gallons of sea water per day are drawn into the plant.

Though in practice the recovery of magnesium metal from sea water involved comparatively simple operations chemically, it is far from being an easy task economically to utilize a raw material which contains only about 1 part of magnesium in 800 of water. Quite unusual chemical engineering methods, equipment, and control, had to be invented. Such work involves research on the grand scale by large teams of chemists and engineers. It is Discovery with a capital D, and costs very large sums of money.

The magnesium is precipitated as hydroxide by means of lime. This is collected on special filters and converted into chloride using for this operation a 10 percent aqueous solution of hydrochloric acid which is largely derived from a later stage of the operation. The magnesium chloride is evaporated and dried until anhydrous, when it is electrolyzed in suitable cells to produce metallic magnesium. Natural gas is used as the source of power and heat. The effluent water is discharged 7 miles from the intake, which is almost 30 feet below the surface so as to obtain the highest concentration of salts. The current of sea water is always in the same direction, which prevents mixing. There is a bromine factory on the same site and the two effluents, the one acid and the other alkaline, mingle.

We have been able to describe the work done in the United States on these materials since it has been widely published in the technical

press. Their manufacture has not been neglected in this country and great credit is due to the British Periclase Co. and to Dr. H. H. Chesny, and no doubt to others of whom we shall hear more after the war, for their achievements.

There are no oyster shells on the British beach; it was evidently not the one chosen by the Walrus and the Carpenter for their walk. But there was a convenient source of dolomite which is quarried and calcined in shaft kilns and the resulting mixed lime slaked with sufficient water to give a thin slurry.

This slurry is allowed to react with sea water previously treated and filtered to remove bicarbonate hardness and suspended matter in a special reaction vessel. The calcium hydroxide precipitates the magnesium salts in the sea as magnesium hydroxide while the magnesium oxide from the dolomite remains unchanged and in suspension. The resultant mixture is pumped into large circular tanks, where the magnesia settles out and the spent sea water passes to waste.

The settled magnesia slurry is filtered off by means of rotary vacuum filters, and the paste obtained burned in pulverized-coal-fired rotary kilns. The temperature of firing is varied according to whether it is desired to produce reactive caustic magnesia for the magnesium industry, or dead-burnt magnesium oxide for the manufacture of refractories.

By this ingenious modification magnesium is obtained from dolomite and from the sea by one and the same operation.

#### POTASSIUM SALTS

It would be possible to recover a potassium salt from the sea, but here the economics are not yet favorable. The main use for potash salts is as fertilizers, which command a low price. Moreover, there is a source of potash in the Dead Sea, now under rapid development, which will insure sufficient supply of these to meet world demand at competitive prices and will destroy the Stassfurt monopoly. There are also similar sources of supply in the United States. The quantity of potassium chloride in the Dead Sea is estimated at 2 billion tons.

As the concentration of salts is greater at the bottom of the Dead Sea than at the surface, the solution is pumped from depth and evaporated fractionally in shallow natural pans which have an impervious clay bottom. First, common salt crystallizes, then a somewhat impure double salt of potassium and magnesium chloride termed carnallite, and finally magnesium chloride; the mother liquors go to the bromine plant. The chemists of the Palestine Potash Co. have made a very thorough study of the sequence of events involved in the evaporation and crystallization, and by an ingenious application of the knowledge of the solid equilibria of the salts concerned coupled

with first-class chemical engineering technique are able to produce highly purified potassium chloride.

Over 40 years ago the distinguished Dutch chemist, Van't Hoff, and his pupils, made a profound study of the sequence of events on concentrating sea water at 25° C. The order in which the various salts are deposited was found to be in very fair agreement with the geological succession as observed at Stassfurt, though there are indications that these dried up at a slightly higher temperature. These celebrated deposits consist of an immense thickness of rock salt, interspersed at fairly regular intervals with narrow bands of anhydrous calcium sulfate capped with beds rich in magnesium and potassium salts. The beds are obviously of marine origin, but a constant flowing-in of water containing salts during the period of evaporation must be assumed to account for the magnitude of the deposit. The inland sea ultimately dried up completely.

The extensive salt beds in Cheshire have no potassium or magnesium salts, and it must be assumed that in this locality the remaining waters went elsewhere before final evaporation.

In the Dead Sea the process of salt accumulation and evaporation go on at the same time. The level is roughly constant, though it varies a little from season to season and decade to decade. Evaporation thus keeps pace with the inflow of fresh water. The Jordan and other rivers bring in 40,000 tons of potassium chloride per annum. The ratio of the various salts remains constant. The relative quantities differ from those in the sea and in salt deposits; in particular there is no sulfate.

The magnesium content of the Dead Sea is some eight or nine times that of the oceans, but here again it is the relative costs at the two sites and the cost of transport to and from them that settle the competitive effort. It is quite clear that given a demand for large quantities of magnesium its manufacture from the ocean will continue.

Dr. Bergmann and the Palestine Potash Co. draw an attractive picture of the potentialities of establishing a large chemical industry there from which the markets in the Middle and Far East can be supplied. The factors are there—and who knows what the future may produce?

#### PHOSPHATES

It may well be that the minerals in the sea can be considered in two classes, namely, (*a*) those present in constant proportion to each other and in relatively large amount, i. e., the salts formed from the elements sodium, potassium, magnesium, chlorine, bromine, sulfur in the form of sulfates, and (*b*) those present in traces and though universal are possibly in variable amount locally. Fresh supplies of these are being

received all the time from the land and returned, as we shall see, to the bottom of the ocean.

Analyses of sea water showing the amount of the rarer minerals are so far scanty, and it cannot, for example, be said that a particular compound is present everywhere to the same extent. Evidence is also lacking whether some of them are accumulating or whether they are being deposited either as such or after absorption into the structure of some marine organism. The occurrence of minerals in veins or lodes in sedimentary rocks gives support to the idea of deposition. Moreover, the vast deposits of limestone and chalk so characteristic of southern England are all derived from organisms which have taken up the traces of calcium salts from the sea. Elsewhere calcium has been deposited as sulfate.

At this stage therefore one can state purely as a working hypothesis that while the ocean is constant in composition in regard to its main constituents it is variable and even local in regard to the trace elements.

Quite another problem is the fate of those minerals the world over which are constantly reaching the sea either from sewage or by the leaching out of cultivated lands. While these in the aggregate total far less than what is produced by denudation, they are of importance because they represent the constituents which are of primary value to man.

One of the most interesting of these is phosphate, of which the mineral deposits are limited in amount and may well become exhausted. Many of the agricultural soils of the world are definitely short of phosphates and their crop-bearing qualities impaired in consequence. A new widely distributed source of phosphate would therefore be of great value and importance.

It has been calculated that the sewage from 5 million people is equivalent to 17,000 tons of rock phosphate in a year, and this happens to be the quantity present in the annual export of meat from New Zealand, which Dominion is the loser of the same amount. The population of Great Britain discards as sewage the equivalent of 150,000 tons of rock phosphate, most of which reaches the sea. An estimate of the annual losses of phosphate from all sources to the sea in the United States amounts to the equivalent of 60 million tons of rock. The world's consumption of phosphate rock is said to be 18 million tons; there are of course other sources of phosphatic fertilizers.

The question may well be asked, what is happening to the phosphate; is it being concentrated and removed or deposited? Here is an interesting problem for study. The concentrations of nitrates, phosphates, and silicates in sea water are subject to considerable fluctuation depending on the activity of the marine organisms, and

although the absolute figures may appear insignificant these fluctuations may have a strong effect on the population of the sea. Indeed, this is subject to regular cyclic changes very pronounced in planktonic forms.

The annual crop of plankton depends on the amount of phosphates and nitrates, and there is an apparent relation between the quantity of phosphate available at the beginning of each year and the number of young fish which have had enough food and survived during the ensuing summer months. In temperate seas almost all these salts have been used up during the summer and continued growth depends on new supplies brought up from below by vertical mixing caused by convection currents during the winter, when a rather thorough renewal takes place.

The annual crop of plankton depends on the amount of phosphates and nitrates, and there is an apparent relation between the quantity of phosphate available at the beginning of each year and the number of young fish which have had enough food and survived during the ensuing summer months. In temperate seas almost all these salts have been used up during the summer and continued growth depends on new supplies brought up from below by vertical mixing caused by convection currents during the winter, when a rather thorough renewal takes place.

#### SOFTENING SEA WATER

The chemist is already searching for materials capable of selectively absorbing and retaining substances present in small quantities in large volumes of water. Such base-exchanging materials are widely used in the softening of hard waters, a process which involves the replacement of soap-destroying and scale-forming calcium and magnesium by relatively innocuous sodium. Natural zeolites were first used for this purpose and later supplemented by artificial zeolites and by sulfonated carbonaceous materials. These last offer the additional advantage of replacing the calcium or magnesium with hydrogen instead of sodium if desired. In this way the dissolved salts can be removed altogether instead of merely replaced. Such a process is particularly valuable in water for boilers. They are made by treating coal or lignite with strong reagents such as fuming sulfuric acid, sulfur trioxide, chromic acid, etc. The active group in these zeolites is believed to be a sulfonic acid group.

Much the same principle explains the action of polyhydric phenol formaldehyde resins. These contain hydrogen (in an hydroxyl group) which readily goes into solution to replace calcium or sodium ions and forms acids. Such resins are reported as physically more stable and faster in action than the other softeners mentioned. There is another group of resins described as amine-formaldehyde, which



achieves actual removal of the acids just mentioned. The mechanism is obscure, but it may include both surface absorption and reaction of the acids with the amine group. Resin treatment may convert an ordinary hard water into something approaching distilled water.

Naturally experiments have been made along these lines with sea water with the hope of being able to convert it into drinking water for shipwrecked mariners in apparatus small enough to be carried in lifeboats. The amount of salt in the sea makes this problem a very difficult one and the solution is not yet in sight.

It seems clear that in these base exchangers the chemist has useful tools to effect the concentration of small quantities of dissolved substances. Some technical applications are already known, but we would illustrate what it is hoped to achieve by citing some results obtained with copper by Professor Furnas and R. H. Beaton working at Yale.

#### COPPER

The ideal conditions using carbonaceous zeolites have been determined. The absorption for copper is a function of the ratio of copper ions to hydrogen ion concentrations, or in more simple language there are ideal conditions of acidity favoring the transfer of copper from solution to zeolite. The collection of copper is complete and takes place at a rapid rate of flow of the very dilute solution over the columns of the exchanger. The recovery of the copper when the zeolite is saturated is effected by fairly strong solutions of sulfuric acid. At the same time the zeolite is regenerated for another cycle. There remains as final product a strong solution of copper sulfate.

Putting the results in plain figures rather than in the form favored by the chemist, it appears that a solution which contained 1 pound of copper in 6,300 pounds of water is turned into one of copper sulfate containing 1 pound of copper in 6.87 pounds of water. To do this 1.54 pounds of sulfuric acid (100 percent strength) are necessary, and simple arithmetic indicates that 1 pound of acid performs the same duty as the evaporation of 4,200 pounds of water. This illustrates the tremendous difference in energy requirements between the base exchange process and evaporation for the concentration of very dilute solutions and is evidence of the unique possibilities of the use of zeolites.

The Yale achievement of increasing the concentration of copper in dilute solutions is rivaled by that of the oyster which we must be prepared to treat with greater respect after learning that it gargles a barrel of water per day. Around the British Isles and in certain sections of the Atlantic coast oysters become green due to the formation of a pigment containing copper. The amount of copper which an oyster can accumulate is variable; it varies in the Cape Cod variety

from 0.16 to 0.24 mg. per oyster, and from 1.24 to 5.12 mg. per oyster in Long Island Sound, where the average is 2.5 mg. This last figure has enabled someone to calculate that in Long Island Sound the oysters accumulate about 7.5 tons of copper every year from the sea.

The average content of copper in the sea appears to be of the order of 0.01 part per 1 million. There is more copper in the fresh water coming into Long Island Sound than in the sea; indeed, the amount there fluctuates between 1 part per 1 million at high water and 0.5 part per 1 million at low tide.

Copper salts apparently have a peculiar effect on oyster larvae, inducing their attachment to the substratum and initiating their metamorphosis. The result is that the best settling areas are found on bottoms affected by fresh water, while natural oyster beds occur mainly in the mouths of rivers. It has been estimated in the United States that 200 tons of copper are lost in sewage each year per 1 million people, together with 50 tons each of such metals as magnesium, lead, aluminium, and titanium. The 10 million people of New York City provide on this recovery ample copper for their oysters.

Copper is well known as the metal in the respiratory pigment, haemocyanin, which is present in lobsters, shrimps, crawfish, and other shellfish and plays the same part as iron does in haemoglobin, the respiratory pigment of human red blood corpuscles. It is found in sardines, herrings, salmon, and other sea animals, and is obviously quite an essential element in marine life notwithstanding its lowly proportion in the sea.

A considerable proportion of the trace elements seem to be concerned in the life history of marine organisms. Where there is plenty of an element the organisms flourish, where it is scanty they are absent. When the organisms flourish they live their allotted span and die, their skeletons falling to the depths of the ocean and decomposing into their constituents. Where there are vertical currents the trace elements are brought to the surface once more and there is renewed growth of organism; when there is no upward current a deposit is formed rich in the trace element. New reactions resulting in the formation of sedimentary rocks take place. We pass from the science of biology to geology. Some of these elements enter direct into the structure of the organism, others—in particular the heavy metals—are believed to be largely taken out of solution by absorption on the surface of the protoplasm, a purely physical phenomenon. This applies to gold and silver.

#### GOLD

A matter in which the more credulous portion of the public is interested is the possibility of obtaining gold from the sea. Gold is said to

be present to the extent of 1 part in 1 billion (1 mg. per cubic meter), but the Haber expedition found very much smaller amounts—often none. Gold has actually been extracted from the sea during a month's working at one of the American bromine plants, but the cost of doing so was several times more than the value of the gold and it would appear that it will always be cheaper to mine gold in South Africa and elsewhere even when the present mines are exhausted and the reefs have to be followed deeper into the earth at an increased cost of production.

Gold is probably one of the elements which does not stay in the sea, but is being removed by absorption onto the surface of organisms and taken down to the bottom. In agreement with this the bottom sludges obtained by dredging in certain localities contain very much larger quantities of gold than there is in the sea. Indeed, the amount is most variable; estimates in the literature vary from 23 to 1,200 tons of gold in 1 cubic mile of sea.

One may perhaps answer this interesting question by saying that gold will continue to be mined rather than won from the sea, particularly since it has few uses other than as a financial token.

#### IODINE

An element of universal distribution in air, sea, and land is iodine which is of fundamental importance alike to man, animals, and plants. It is a constituent of the thyroid gland and if we lack it in sufficient quantity we are afflicted by goitre. Many marine plants have the power of concentrating it, thus the dry matter of deep-water seaweed, such as *Laminaria*, contains as much as 0.5 percent. Iodine was in fact first discovered by Courtois in 1811 in the ash of sea kelp. Kelp, or *Varech* as it is called in France, has been used for many years for the commercial extraction of iodine even though this practice cannot compete economically with the production of iodate from the caliche in Chile. Certain coral species are said to contain up to 8 percent of iodine and it is of interest that it is present both here and in the bath sponge in the organic state as di-iodo-tyrosine.

The question of the form of iodine in the sea is still indefinite: it may well be organic. The sea contains 0.001 percent and is much richer in this rarest of the halogens than the land. It is obviously in a continual state of change, being oxidized and reduced, and passing into marine plants and animals. When the seaweed moves lazily to and fro at our feet large quantities of iodine are being withdrawn from circulation. Some of it is constantly being lost through vaporization into the atmosphere, and this is why people living sufficiently near the coast, as the great majority of the population of this island do, do not suffer from goitre in the same way as the population of the great central plains of the United States.

## ARSENIC AND CALCIUM

The arsenic in the sea exists apparently in organic form and, like iodine, is concentrated in animals and plants. The lobster has 40-50 parts per 1 million and *Laminaria* twice as much.

There are many points of interest connected with the calcium in the sea; in fresh water it is the most abundant of the three cations—calcium, magnesium, and sodium; in sea water it is the least abundant as all the time animals and plants are removing it, a fact to which the white cliffs of Dover bear abundant testimony. It is related to the carbon dioxide content of the oceans which is some 15 to 30 times the amount present in the atmosphere, and it may be well that the carbon dioxide content of the air is regulated by the oceans acting as a reservoir. There is a continual exchange between the air and the surface of the sea which, among other things, controls the acidity of the sea water to which much of the life of the ocean is acutely sensitive. Further, in the sea, as on land, plants use carbon dioxide as the basic source of carbon for the building up of organic compounds.

When the carbon dioxide in solution in sea water is reduced, the conditions are favorable for the deposition of calcium carbonate. The building of shells by animals which live on the sea bottom and of the smallest Protozoa is an interesting subject. It accounts for an annual deposition of 1,400 million tons of calcium. Shells are of two classes, those containing calcium carbonate alone or with magnesium carbonate, and those containing calcium phosphate. As yet we have no clue to the reactions involved in building shells. One minor point is that in tropical waters the percentage of magnesium carbonate is higher.

The relative abundance of the alkaline earths in the sea in the order calcium, strontium, barium, is about 4000:100:1. The temperature of the water may also have an effect on the presence of strontium instead of, or together with, calcium in shells. In very cold waters strontium may replace calcium and there is a report of a radiolarian from the Antarctic whose shell is composed almost entirely of strontium carbonate. In other shells both are present in much the same proportion as that in which they occur in sea water.

The sea is the greatest potential source of raw materials. It contains traces of every element ready to hand so that marine plants or animals can adapt them to their purpose. There is true symbiosis between animal, vegetable, and mineral. Our approach to this subject has been from the mineral aspect, to ascertain what minerals can be economically won from the sea in competition with land sources of the same materials deposited in bygone geologic ages. The sea gives us a great quantity of food in fish of all kinds. The study of these is

an important branch of science, for it is certain that in times to come we shall not only require more fish but make better use of the catch. The great medicinal value of the liver oils as a source of vitamins is an example. Less use is so far made of seaweeds, but here also research is beginning to show that novel and perhaps useful and valuable substances are present, and before long there will have been worked out methods of harvesting the weed and fabricating diverse products from it.





THE BROMINE PLANT OF THE ETHYL-DOW CHEMICAL COMPANY OF AMERICA.  
(Re-produced from "Collateral Readings in Inorganic Chemistry," D. Appleton-Century Co., New York.)

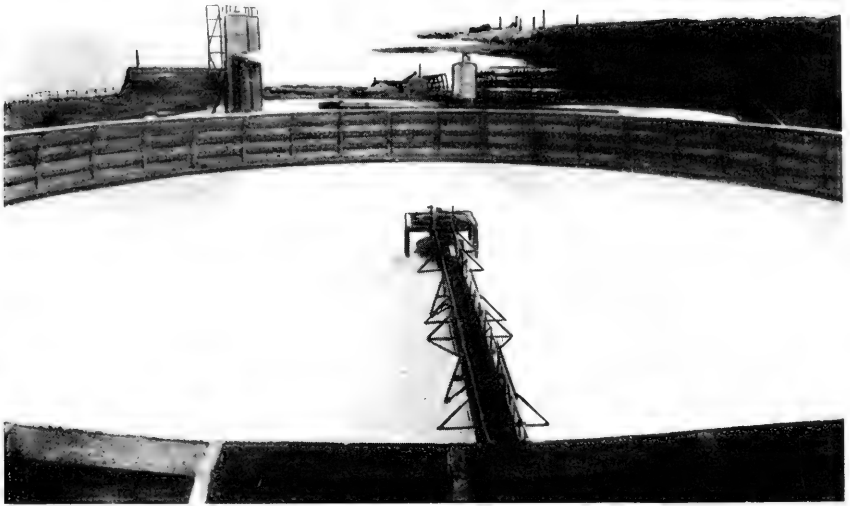

1. SETTLING TANK, WHICH HAS A CAPACITY OF 2,000,000 GALLONS OF WATER AND APPROXIMATELY 1,000 TONS OF MAGNESIUM HYDROXIDE.

(Courtesy of British Periclase Co.)

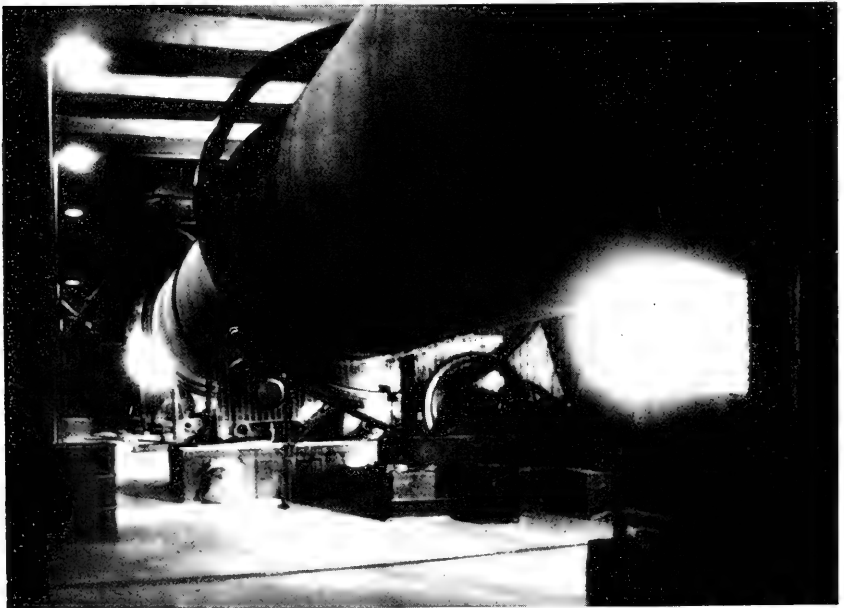

2. THE ROTARY KILNS, WHICH ARE 160 FEET LONG AND 10 FEET IN DIAMETER, EACH BURNS APPROXIMATELY 300 TONS OF MAGNESIA PER WEEK.

(Courtesy of British Periclase Co.)



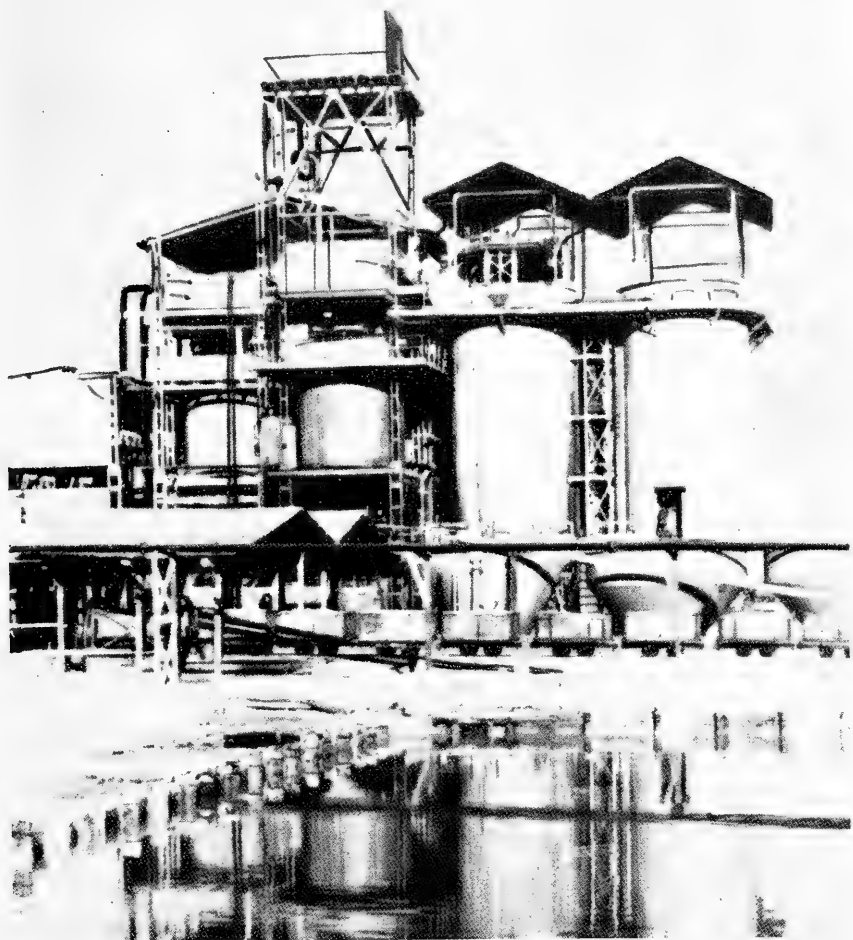

A REFINERY IN SOUTH PALESTINE.  
(Courtesy of Palestine Potash, Ltd.)



EVAPORATION PANS IN THE PALESTINE POTASH PLANT.  
(Courtesy of Palestine Potash, Ltd.)

# PROGRESS IN NEW SYNTHETIC TEXTILE FIBERS<sup>1</sup>

BY HERBERT R. MAUERSBERGER

*Technical Editor, Rayon Textile Monthly*

It is again my privilege to report on the subject of Progress in New Synthetic Textile Fibers. My previous report made on October 17, 1940, has been reproduced in the General Appendix of the 1941 Annual Report of the Smithsonian Institution, showing that our Government takes cognizance of our activities in identification, nomenclature, and technology of our new textile fibers and materials. It also appeared in the American Society for Testing Materials Standards on Textile Materials.<sup>2</sup>

The information in the present paper is an addition to that given in the previous one. Much of the previous information is today quite inadequate, so fast has this industry grown and these developments taken place. My information has been obtained from sources believed to be authentic and reliable. Some of these developments are already well known and are only included for the record; others have taken place quietly and may have escaped notice or attention.

Some of them are gigantic and could be dealt with at great length, which is not permitted here, whereas others are still in the formative stage and data must be withheld owing to the war. No matter what your own experience is with these individual fibers, or what your opinion of them may be, remember at all times that practically all these fibers, yarns, and materials are custom-made to meet any domestic technological demand that may arise. Their versatility of use and flexible properties have been of tremendous value in the war effort and will be after the war.

## IMPORTANCE IN WAR EFFORT

Even in your fondest dreams could you imagine that insect and mosquito screens could be woven actually better with a synthetic monofilament yarn than with copper wire? Again, just imagine for a second where we would be in this war if it had not been for nylon

<sup>1</sup> Presented at the March 1943 meeting of Committee D-13 on Textile Materials. Reprinted by permission from Amer. Soc. for Testing Materials Bull. No. 122, May 1943.

<sup>2</sup> Abstracted in Amer. Soc. for Testing Materials Standards on Textile Materials, p. 351, October 1941.

parachutes and shroud lines, high-tenacity rayon bomb chutes, "Bubblfil" life preservers, Vinyon screen printing cloths, nylon tooth brushes, rayon paint brushes, and Velon or plastic-coated window screens?

These certainly are not laboratory or experimental ghosts or guinea pigs; they are absolute realities and accomplished facts! A fine tribute to American ingenuity and the product of arduous and persistent research by American chemists, chemical engineers, and technologists.

Time and space limitations preclude the inclusion in this paper of many technical details, and only the most important and outstanding advances in new synthetic fibers can be given. Only those fibers that have gone beyond the experimental stage and are in actual production now or will be immediately after the war are dealt with.

Nothing new or of interest can be reported on nylon, fibroin, fibers from corn, chitin, ossein, lichenin, Iceland moss, alginates, or agar-agar. There are, however, developments of great significance in the protein-base fibers such as casein and soybean, which have been developed to a considerable extent in the past 3 years. There has also been a rapid advance in the vinyl resin group and in the thermoplastic resin groups.

#### THERMOPLASTIC RESINS

When Dow Chemical Co. produced saran in 1939 (mentioned only briefly in my 1940 paper), no one believed that it would have any significant possibilities in the textile industry. It has seen many new textile applications since then.

The raw materials for these monofilament yarns are a group of resins from unsymmetrical dichlorethylene, known as vinylidene chloride resins, made from petroleum and brine. Ethylene is made by cracking petroleum, while chlorine comes from the electrolysis of brine. They are combined to form trichlorethane, which is converted with lime into the vinylidene chloride monomer. This product can be readily polymerized to form the long-linear-straight chain polymers. By careful selection of copolymers and control of the polymerization conditions, many different polymers can be formed. These resins range from a flexible, moderately soluble material, having a melting point of about 158° F. to a hard, tough thermoplastic, having a softening point of 350° F. or more. The basic resin is odorless, tasteless, and a nontoxic powder.

One of the several methods of extrusion is the one of crystal orientation, which produces long continuous monofilaments, tapes, bands, and other shapes. The oriented form is produced by extrusion, subsequent plastic deformation as by stretching, and by heat treatment.

The material may be heat treated after or during stretching to affect the desired degree of crystallization. It produces monofilament yarns of considerable toughness and tensile strength, abrasion resistance, and chemical resistance to water, acids, alkalies, and many organic solvents.

Little of textile interest was done with these yarns until Mr. Stedman, of Firestone Tire & Rubber Co., Akron, Ohio, took up the development and gave the name "Velon" to these products and established the Velon Department. A unit for production was set up at the Worldbestos Plant in Paterson, N. J., where monofilament yarns are being made as fine as 0.007 inch in diameter running from 10,000 to 12,000 yards to the pound. Experiments for the extrusion of *multifilament* yarns are under way and it is expected that yarns as fine as 100 denier can be produced eventually.

At first, flat continuous bands were made to imitate rattan in the seat covers of buses and subway cars, and next, shoetop fabrics were woven for evening and sport shoes, using the Velon threads as warp and cotton yarns for filling.

As soon as round, monofilament yarns of sufficient fineness were produced, Mr. Stedman interested August Hafner, president of Hafner Associates, who is a well-known specialty and experimental weaving expert in this country, to work out the textile possibilities. Mr. Hafner could see the potentialities of these yarns at once, and suggested their use for handbag, trimming, and millinery fabrics of unusual color, design, and weave variations.

Then came the war with its restrictions on copper, steel, aluminum, and metals in general. This brought about replacements of metals in making mosquito and fly screens. These fly screens are now made successfully with vinylidene chloride resin yarns in 16 by 16, 12 by 12, and even 20 by 21 mesh. Window screens made from this yarn are supposed to provide better vision due to their greater transparency. At present, it is restricted for civilian use and its application in dress goods and wearing apparel will have to await the end of the war.

#### NEW ELASTIC VINYON E

Late last year, the Vinyon Department of American Viscose Corporation in addition to Vinyon filament yarn, explained in my earlier paper, offered a new vinyl resin yarn with considerable elastic properties known as Vinyon E. It possesses many characteristics of rubber and opens an entirely new field of applications. For some purposes it has been found superior to rubber, because it has exhibited better resistance to sunlight, tropical heat, and humidity and is not affected by body acids. At present it is restricted to military uses, where it replaces rubber. However, after the war we will see many

textile applications such as elastic webbing, tapes, cords, girdles, brassieres, surgical stockings, suspenders, and supporters, and many articles now made of sponge rubber.

#### CASEIN FIBER

The next remarkable development has been in casein fiber. The National Dairy Products Corporation has further developed and made remarkable progress with its trade-named product "Aralac." The company has now formed Aralac, Inc., an entirely new division of the National Dairy Products Corporation, which has increased its production almost eightfold since 1940.

The original 4,000-pound-a-day plant at Bristol, R. I., was moved in July 1941 to Taftville, Conn., with an output of 15,000 pounds per day. The product, originally used by the felt-hat trade, was then investigated by textile manufacturers. The advent of the war with its WPB restrictions on civilian wool use boomed interest in Aralac, so that in 1942 the plant capacity was doubled to 30,000 pounds per day. The felt usage being relatively stable, a much larger percentage of this fiber now goes to the textile trade.

Aralac is offered in finenesses corresponding approximately to 50's, 60's, and 70's wool grades and in staple lengths from  $\frac{1}{2}$  to 6 inches. Specialty uses include stuffing for pillows, comforters, and quilted goods, interlining for cool-weather garments, and protection for milady's hair, when it is given a permanent wave. The last-mentioned is in the form of a highly crimped combed top, and is known under the trade name "Wavecrepe."

Casein, the basic raw material from which Aralac is made, is a by-product of the milk industry. National milk production is upward of 117 billion pounds of milk annually. About 50 percent of this is skimmed for its cream. The skim milk thus formed yields over 1 billion pounds of casein a year or over 3 million pounds of casein a day, a pound of casein making roughly 1 pound of Aralac fiber.

Casein fiber, unlike nylon, Vinyon, and acetate rayon, is made by a wet spinning process, somewhat similar to viscose rayon. Even these two processes are similar only at one point, namely, the extrusion through a spinnerette into a coagulating bath. Before this point, the Aralac process is much simpler than viscose; afterward, it is many times more complicated. The casein is dispersed in water by means of an alkali; the dispersion is clarified, spun, coagulated, and the tow treated to give the filaments flexibility and hot-water resistance. The fiber is then washed, dried, cut to staple length, and baled for shipment to textile mills.

The properties of Aralac are in some instances similar to those of wool and it is being used entirely in mixtures with wool, rayon, and

cotton fibers. It is not affected by organic solvents. It is not thermo-plastic below charring temperatures. It withstands sulfuric-acid carbonization as well as wool. Its alkali resistance at higher temperatures is somewhat lower, so low temperatures and mild alkaline or neutral detergents are recommended for scouring and washing. Considerable research has been done on dyeing this fiber and the dyeing problem is now well in hand.

Uniformity has made rapid strides and is now well under control. Being an animal base, it burns with the same odor and bead formation as wool and silk. Its strength, both dry and wet, is the same as last reported, about 60 and 20 percent, respectively, that of wool. Regain at 70° F. and 65 percent relative humidity is 12.6 percent. Commercial regain is established at 13 percent.

The largest textile use of Aralac at present is in dress goods, but it is expanding into other uses, where a resilient, lofty hand is desired. The hat trade absorbs large quantities and practically every man's felt hat in this country and Canada, which has been made within the past 3 years contains some Aralac fiber.

It looks as if this fiber will go far, especially under present war conditions and with pressing needs for fiber conservation in the textile industry.

#### SOYBEAN FIBER

Ford Motor Co. of Dearborn, Mich., has considerably enlarged the production of this staple fiber which was explained quite fully in my 1940 paper. The company has now given this staple fiber the trade name "Soylon," and I understand is offering it to the cotton and worsted spinning, weaving, and knitting trade in volume. Robert A. Boyer has been in charge of this development at Dearborn and reports that the new plant has now reached 5,000 pounds a day or 1,825,000 pounds annually. All machinery and equipment were designed by Ford engineers and are supposed to incorporate the latest mass-production principles and devices.<sup>3</sup> The fiber has been improved in strength and other physical, chemical, and microscopical properties.

#### PEANUT PROTEIN FIBER

It appears that casein of animal origin and soybean of vegetable base points to the future use of other vegetable proteins for textile fiber manufacture. An instance is a textile staple fiber from peanut protein.

Reports indicate that Imperial Chemical Industries, Ltd., of Glasgow, Scotland, has done considerable research work, and D. K. Baird

<sup>3</sup> Since delivery of this paper Ford Motor Co. has sold this entire equipment to The Drackett Co. of Cincinnati, Ohio, and has discontinued the manufacture of this fiber.

of the above company brought a sample of peanut protein fiber and cloth (made of 50 parts peanut fiber and 50 parts wool) to this country in 1939.

I am informed by the New York office of Imperial Chemical Industries, Ltd., that this work is at present still in the experimental stage. There has been no commercial development of the fiber in England or in any other country, neither could they state when such commercial development is likely to be achieved.

The only public knowledge of this work is in United States patent No. 2,230,624, applied for on February 4, 1939, and granted on February 4, 1941, to Andrew McLean, Saltscoats, Scotland, and assigned to Imperial Chemical Industries, Ltd., England. There are seven claims.

From what I have seen in very small samples the fibers have an excellent appearance, are softer than wool and fine, and take dyes even better than wool. It might be stated also that the above company has produced satisfactory fiber from castor seed and edestin, a crystalline globulin found in many edible seeds such as wheat, rye, maize, etc. This indicates that we may see more of these protein fibers after the war.

#### PLASTIC-COATED TEXTILE YARNS

Another unusual development, which has gone forward quietly and is now assuming considerable proportions and importance in the war effort, is the coating of cotton, rayon, and fiber-glass yarns with infinitely fine coatings of plastic solutions to give them added and almost unlimited strength, brightness or dullness, color, to make them completely waterproof and moisture-resistant, flame-retarding or self-extinguishing, or to make them resistant to mild acids, perspiration, oil, and grease, as desired. This may seem difficult of accomplishment but is now a reality and has found many interesting and technical applications in the textile industry.

It is the invention of two Frenchmen, Roumazeilles and Girard, and was patented in France in 1925 and in the United States in 1930. The American patent rights to the now-called Plexon Process were purchased by Freyberg Bros.-Strauss in 1938. The first Plexon yarns were introduced here in 1939 after making many improvements in the methods and machinery required. At first quite expensive, the speeding up of the process and finding suitable and practical plastic formulations resulted in price reductions, which now brings these yarns within reach of many new applications.

In 1942 the entire procedure was revamped again, both as to machine construction and speed of production, so that today these yarns



are made five times as fast as on the original French machine, a tribute to American engineering practice and genius.

It is possible by this process to apply as few coatings as 6 or as many as 24, depending on the ultimate use of the thread. It is possible, for instance, to make a plastic-coated yarn as fine as 0.008 inch in diameter and up to approximately 0.09 inch in diameter. The dimension of the uncoated yarn could be almost anything within this range. It is possible to get an absolutely round thread by using graduated round disks. It is also possible to obtain different shapes such as elliptical, triangular, or square threads by using dies shaped to these forms. The process also envisions the application of plastic coatings and impregnations to flat tapes, bands, cords, and even wires.

In addition to shaping the coating, the yarns can be made in various finishes. They can be made stiff or soft, or any graduation in between. They can be made transparent, translucent, or opaque, smooth or rough, by changing the plastic coating. Color ranges take in the entire scope of pigments available, the current color line consisting of more than 120 different shades. Such plastic-coated yarns can be made completely waterproof, moisture-resistant, verminproof, weatherproof, rotproof, flameproof, as well as resistant to mild acids, perspiration, oil, grease, gasoline, and even to withstand extremes of temperatures as in tropical or Arctic climates.

Such plastic-coated yarns can be and have been woven, knitted, braided, twisted, plaited, or crocheted into many types of sheer and dress materials, drapery, auto upholstery, slip covers, curtains, handbags, and shoe fabrics. A notable contribution to the war effort was made by developing a special type of coated yarn as a complete substitute for steel and copper wire in the weaving of insect and fly screens. Through intensive research a Plexon wire yarn was perfected, which used noncritical materials both in the support (a cotton yarn) and in the chemical formulation of the coating. A stiff, wirelike coated cotton yarn was introduced to the insect-screen industry, woven on ordinary wire looms without many change-overs or adjustments. The resultant insect screen was tested by the National Bureau of Standards and found completely satisfactory. These screens will not rust, can withstand high tropical temperatures, and require no painting, lacquering, or brushing, and are in actual use now.

While there are several other developments, most of these are in the formative or experimental stages, and they may not bear fruit until sometime after the war. However, they bear watching. It may be pointed out here that America at this rate need never again experience a shortage of textile fibers will have a greater diversification of fibers for every purpose, demand, or use after this war.

## NEW CLASSIFICATION OF MAN-MADE FIBERS

Concurrent with these facts given in this and my previous paper and as a summary thereto, I wish to present a new classification for all man-made fibers, which, I believe, will aid in clarifying this picture and serve to place the fibers in a logical grouping.

In the past few years, it has become more and more apparent that the word "synthetic" is not the best or an all-inclusive word for the fibers I have discussed but has been used for lack of another or more suitable word or words. It has become very clear to me that we have now two distinct types or groups of man-made fibers.

One large group distinctly derives from natural sources such as wood pulp, cotton linters, cow's milk, soybeans, peanuts, and silicate glass. I should like to term these "regenerated natural fibers." (See fig. 1.) They are not really synthetic at all. The dictionary defines synthetic as "of or pertaining to synthesis" and again synthesis "is the art or process of making a compound by combining elementary ingredients."

Furthermore, I suggest that these regenerated natural fibers be broken down into three distinct subdivisions according to the bases from which they originate, namely, (*a*) cellulosic bases, (*b*) protein bases, (*c*) mineral or inorganic bases.

Under the cellulosic bases we have, first, the viscose and cuprate; second, the cellulose esters; and third, the cellulose ethers, all in filamentous and fibrous conditions.

Under the protein bases, we have, first, the animal protein fibers, namely, casein and Aralac; and second, the vegetable protein fibers, where we have soybean and peanut fibers and others.

Under the mineral or inorganic bases, we have fiber glass (filament and staple) and the mineral wools, such as rock wool, glass wool, and slag wool.

None of these products or fibers are made by true synthesis, therefore should not be termed synthetic fibers at all. I should like to recommend that we drop the word "synthetic" entirely for this group at least. I merely suggested the words "regenerated natural fibers" because to regenerate means "to produce anew, to give new life, strength, or vigor to, to reproduce." Is that not exactly what we do with these fibers? If someone can think of a more appropriate word, I should be delighted to substitute it for the above.

In the second main group of man-made fibers belong all filaments and fibers produced by a combination of elementary or complex chemicals through synthesis, polymerization, copolymerization, heat treatments, stretch and setting operations, all of which are complicated, strictly chemical processes. Such materials as nylon, Vinyon, saran,

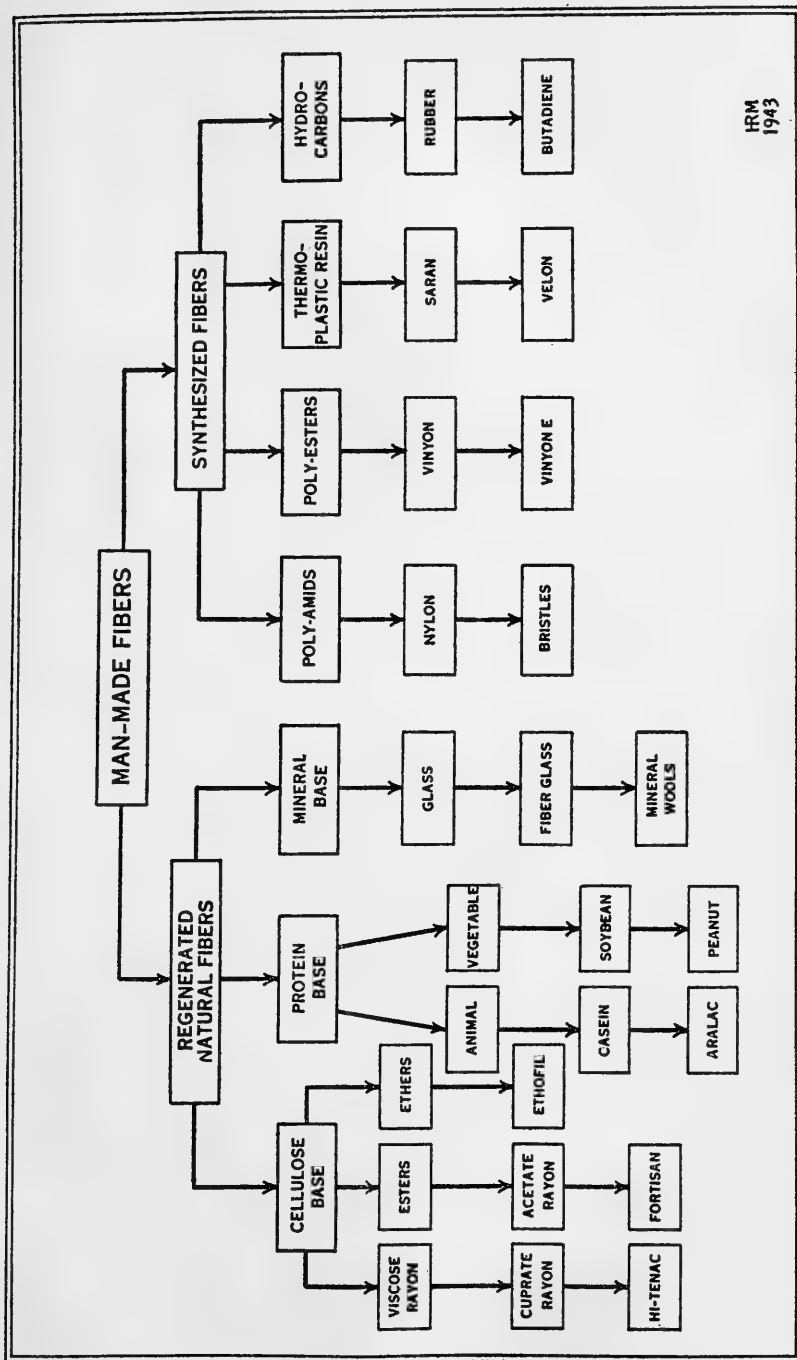

HRM  
1943

FIGURE 1.—New classification of man-made fibers.

Velon, and synthetic rubber yarns belong to this group. I should like to suggest the words "synthesized fibers" for this group, instead of synthetic fibers, although the latter could be used here justifiably.

This second main group I should like to subdivide, for the present at least, first, into the polyamids, which cover Du Pont's nylon filaments, staple fiber and bristles; second into the polyesters, which cover Vinyon filament and Vinyon E, the new elastic yarn; third, into the thermoplastic resins, under which would come saran, Velon, Permalon, and others; fourth and last, the hydrocarbons, which are to include all new synthetic rubber filaments, threads, and cords in full development now.

This classification separates the main products, and subordinates none. I recommend it to you for consideration.

# PETROLEUM GEOLOGY <sup>1</sup>

---

By WILLIAM B. HERBY

*Director of Foreign Production, Petroleum Administration for War*

---

## INTRODUCTION

Among the various substances which are found in the earth's crust, petroleum and natural gas occupy a unique position in that they are combustible fluids. The highly distinctive and interesting properties of petroleum would alone have led to close investigation of its origin and occurrence, but its widespread distribution and great usefulness to mankind have made it the objective of many lines of scientific research and have gained for petroleum geology a leading position in geologic science.

The geology of petroleum may be considered from either of two standpoints. In the field of economic geology it has become one of the most important branches and has attracted to it the largest group of specialists concerned with any mineral resource. Apart from its economic importance and in its proper relation to other divisions of geologic science, petroleum geology may be regarded as a branch of sedimentary petrology, coordinate with hydrology or the geology of coal deposits.

A distinction may be made between the science of petroleum geology and the art of oil finding and development. The latter lies in the field of applied science or engineering. The line between the two is not sharply drawn, and the association between the science and the art is so intimate that the advance of both has been hand in hand. The need for advancing the art has stimulated the progress of the science. New scientific concepts have soon been tried out in practice. As a part of a survey of the advances made in geologic science during the last half century it is fitting that this account of the progress in petroleum geology should emphasize the scientific rather than the engineering aspects, and the writer has approached the subject from that direction. Geographic distribution of petroleum deposits and other matters which are primarily economic in character will not be considered in this paper.

---

<sup>1</sup> Reprinted by permission from Fiftieth Anniversary Volume, Geological Society of America, June 1941.

Petroleum geology is, in point of age, one of the younger divisions of geologic science. It has not attained the senatorial dignity of paleontology nor even the maturity of the geology of ore deposits. It spans but little more than the half century of American geology that this symposium commemorates. Some eminent living petroleum geologists were born before the first oil well was drilled in Pennsylvania in 1859. Petroleum geology is still making the rapid strides of youth.

The writer is faced with difficulties in making proper acknowledgment of his deep indebtedness to his professional fellows. The ideas of others have been incorporated in this paper without hesitation in an endeavor to present as completely as space permits the progress and status of petroleum geology. Where the writer is conscious of having drawn on specific sources he has endeavored, through appropriate reference, to give due credit. If, unconsciously, he has failed to do so, indulgence is asked. Grateful acknowledgment is made to Dr. L. C. Snider for constructive criticism.

## PETROLEUM GEOLOGY IN 1890

### GENERAL CONSIDERATIONS

In the geologic world of 50 years ago two men, Edward Orton and Israel C. White, were the foremost authorities on the geology of petroleum. Both were original Fellows of the Geological Society of America, Orton having served on the committee which drafted the constitution and White on the first committee on publications. The first paper on petroleum geology published by the society was by Orton (1890), and, in the discussion of that paper, Dr. W J McGee (1890), of the United States Geological Survey, paid the following tribute to the work of these two men:

But within the past 3 years the laws governing the origin, distribution, and pressure of rock gas have become as well known as are the laws governing artesian water supply; so that today the geologist prognosticates rock gas nearly if not quite as definitely and certainly as he prognosticates artesian water; and it is not only just to our associates and to American science to say that this great advance in geologic science was due almost wholly to two of our fellows—to Professor Orton, the author of the communication before us, and to Professor White, who has already spoken upon it. To these men we are indebted for this unparalleled stride in American geology. Others, indeed, contributed facts, but they philosophy; and science was immeasurably enriched by their contribution.

To the papers of White and Orton one must therefore turn for the ablest presentation of the geology of petroleum and natural gas of that day.

Peckham (1884) had compiled for the Tenth Census a summary of the previous literature on the origin and accumulation of petroleum,

but it remained for Orton (1888) to publish the first treatise which critically studied and compared the evidence and reached consistent conclusions on this subject. As this report best presents the state of knowledge of petroleum geology as of 50 years ago, its conclusions will be extensively quoted.

#### ORIGIN

After reviewing the various theories that had been advanced by geologists and chemists to account for the origin of petroleum and natural gas, Orton presented the following summary (1888, pp. 82, 83) :

1. Petroleum is derived from organic matter.
2. It is much more largely derived from vegetable than from animal substances.
3. Petroleum of the Pennsylvania type is derived from the organic matter of bituminous shales and is of vegetable origin.
4. Petroleum of the Canada type is derived from limestones, and is probably of animal origin.
5. Petroleum has been produced at normal rock temperatures (in Ohio fields) and is not a product of destructive distillation of bituminous shales.
6. The stock of petroleum in the rocks is already practically complete.

After showing that petroleum is almost universally present in small quantities throughout the limestones and shales of Pennsylvania and Ohio, he concluded :

It is obvious that the total amount of petroleum in the rocks underlying the surface of Ohio is large beyond computation, but in its diffused and distributed state, it is entirely without value. It must be accumulated in rocks that serve as reservoirs before it becomes of economic interest.

#### RESERVOIRS

He then summarized the existing knowledge concerning petroleum reservoirs. As to sandstone reservoirs, he contrasted those of Pennsylvania, as described by Carll, with those of Ohio. The Venango sands of Pennsylvania were sandstones of medium or coarse grain, or even in some cases conglomerates, ranging from a shell to 100 feet in thickness. The productive fields were found to extend in length for a score or more miles in some cases, while their width was confined to 1 or 2 miles. The reservoirs were lenticular in transverse section. The coarser the sand and the more open, the greater the amount of oil; and, in like manner, the thicker the stratum, the larger was its production likely to be, other things being equal. The sandstone reservoir of eastern Ohio was "a stratum of sandstone that rests on and is covered by shales, but the stratum, so far from being lenticular in character, is wonderfully persistent, though varying in thickness and grain from point to point and occasionally nearly disappearing for short spaces." He concluded his remarks on sandstones as reservoirs with the following :

In all of these fields [Pennsylvania, New York, and eastern Ohio], without important exception sandstones buried in shales have proved to be the reservoirs of oil and gas when the latter are found in large quantity. The overlying shale is the cover or roof of the reservoir; the underlying shale appears to be the source from which the bituminous products are derived.

As to limestone reservoirs, Orton was more fully informed than any geologist of his time, in view of his studies of the Trenton. The following is quoted from the same report (p. 86) :

The limestone has been penetrated for about 550 feet without being exhausted. Through most, if not all of its extent, it is petroliferous, as is shown by the drillings, but the accumulated stocks of both oil and gas are always found in the uppermost beds of the stratum, and generally not more than 15 feet below its upper surface. \* \* \* The oil rock carries, at a lower level than that in which the oil is found, but sometimes dangerously near, a brine of unusual character. It has, in fact, the composition of a bittern, or a water left over from the concentration of ordinary brine. \* \* \* The facts as to the occurrence of oil and gas in this stratum seem reconcilable with the theory that they have risen through the limestone rock until they find themselves arrested in their ascent by the overlying shales, and their accumulation therefore takes place at this point.

#### PERMEABILITY

Orton had noted the difference in permeability of these main classes of oil reservoirs and also the variations which occurred in each. It had been early established in Pennsylvania that different portions of the oil sands communicated with some degree of freedom, for adjacent wells were found to affect each other's yields. As an example, he cites the Bradford sand and its division into gas, oil, and salt-water zones, the gas holding the highest and the salt water the lowest levels, and found "the conclusion well-nigh irresistible that the entire rock is permeable and that, in the course of ages, the various contents have been differentiated as we now find them, under the influence of gravitation." In contrast, he found that in other areas "there was no necessary and absolute connection between different portions of an oil sand"; the stratum might be divided into lenticular masses which might be nearly or entirely disconnected. "The rapid changes in thickness of the oil-sand in adjacent wells furnishes conclusive proof upon this point. We can follow the stratum down to a feather edge by these records." In the Berea sand of eastern Ohio he observed that such interruptions occurred frequently. "Communication through a few square miles of the rock can be occasionally inferred, but beyond this we have, thus far, found no warrant for going." It was Orton's observation that in the limestone reservoirs the same freedom of communication did not exist as in the sandstones. He noted, however, that the gas wells at Findlay affected each other noticeably. He recognized that there could not be as free communication through massive limestones as through sandstones. In the case of sandstones, however, he did not apparently



realize that lack of porosity was one of the reasons for lack of communication but rather attributed it to changes in thickness and lensing.

The presence of an approximately impervious roof over the oil reservoir was, to Orton, the primary requisite of oil accumulation. Source beds were plentiful and widely distributed, and various kinds of rocks were suitable as reservoirs, but "more interest centers in the roof shales or cover than in any other part of the system." The Utica and Hudson River shales overlying the Trenton, the Niagara shale overlying the Clinton, and the Cuyahoga shale overlying the Berea were convincing examples. "It is apparent that the composition and order of arrangement of a series of strata have a vitally important relation to the accumulation of oil and gas that may take place within it."

Orton accepted the conclusion of Carll (1880) that the yield of oil wells was fully accounted for by the presence of the oil in the pores of the reservoir and that there was no necessity for resorting to other explanations, such as "crevices" in the rocks, to account for their productivity.

#### STRUCTURE

The principles of petroleum geology which have just been outlined appear to have been quite generally accepted by the geologists who were contemporaries of Orton. But in the field of the relation of structure to the accumulation of petroleum there was dissension of the first order.

I. C. White was connected with the Second Pennsylvania Geological Survey from 1875 to 1883, when he resigned and entered commercial work. Two years later (1885a) he published his epochal statement advocating the anticlinal theory of oil accumulation. The observation that accumulations of oil were associated with anticlinal axes had been made 25 years before by several geologists, including Hunt (1861), Rogers (1860), and Logan, but their opinions had been forcefully opposed by the Director of the Pennsylvania Survey, J. P. Lesley, and probably had little influence on oil discovery or development. So important was White's revival of this theory that Orton (1888, p. 93) proclaimed that his applications of the theory "mark a new period in our study of the geology of oil and gas." The following quotation gives White's (1885a, pp. 521-522) views in his own words.

After visiting all the great gas wells that had been struck in western Pennsylvania and West Virginia, and carefully examining the geological surroundings of each, I found that every one of them was situated either directly on, or near, the crown of an anticlinal axis, while wells that had been bored in the synclines on either side furnished little or no gas, but in many cases large quantities of salt water. Further observation showed that the gas wells were confined to a narrow belt, only one-fourth to 1 mile wide, along the crests of the anticlinal folds. These facts seem to connect gas territory unmistakably with the disturbance in the rocks caused by their upheaval into arches, but the crucial test was yet to be

made in the actual location of good gas territory on this theory. During the last 2 years, I have submitted it to all manner of tests, both in locating and condemning gas territory, and the general result has been to confirm the anticlinal theory beyond a reasonable doubt.

But while we can state with confidence that all great gas wells are found on the anticlinal axis, the converse of this is not true, viz, that great gas wells may be found on all anticlinals. In a theory of this kind, the limitations become quite as important as, or even more so than, the theory itself; and hence I have given considerable thought to this side of the question, having formulated them into three or four general rules (which include practically all of the limitations known to me, up to the present time, that should be placed on the statement that large gas wells may be obtained on anticlinal folds) as follows:

(a) The arch in the rocks must be one of considerable magnitude; (b) A coarse or porous sandstone of considerable thickness, or, if a fine-grained rock, one that would have extensive fissures, and thus, in either case, rendered capable of acting as a reservoir for the gas, must underlie the surface at a depth of several hundred feet (500 to 2,500 feet); (c) Probably very few or none of the grand arches along mountain ranges will be found holding gas in large quantity, since in such cases the disturbance of the stratification has been so profound that all the natural gas generated in the past would long ago have escaped into the air through fissures that traverse all the beds. Another limitation might possibly be added, which would confine the area where great gas flows may be obtained to those underlaid by a considerable thickness of bituminous shale.

Very fair gas wells may also be obtained for a considerable distance down the slope from the crest of the anticlinals, provided the dip be sufficiently rapid, and especially if it be irregular, or interrupted with slight crumples. And even in regions where there are no well-marked anticlinals, if the dip be somewhat rapid and irregular, rather large gas wells may occasionally be found, if all other conditions are favorable.

Ashburner (1885), of the Second Pennsylvania Geological Survey, replied promptly to White's announcement. While conceding that a relation existed between the position of anticlinal axes and the location of gas fields, he regarded the problem as more complex and cited other factors which he considered to be controlling, as follows:

Although it is a fact that many of our largest Pennsylvania gas wells are located near anticlinal axes, yet the position in which gas may be found, and the amount to be obtained, depend upon (a) the porosity and homogeneousness of the sandstone which serves as a reservoir to hold the gas; (b) the extent to which the strata above or below the gas-sand are cracked; (c) the dip of the gas-sand and the position of the anticlines and synclines; (d) the relative proportions of water, oil, and gas contained in the sand; and (e) the pressure under which the gas exists before being tapped by wells.

Lesley, in a paper published the following year (1886, pp. 654-655), strongly opposed White's theory; the following quotation states his views:

Quite recently the location of the anticlinal lines in the Pittsburgh region has become a sort of popular mania, produced by a theory. The whole community interested in the subject of natural gas has been carried away by a theory  
\* \* \* the anticlinal theory of gas.

Stated in a few words, it is a theory that oil, being lighter than water, must rise to higher levels. If the application of this theory was confined to bottles no one would dispute it; the water in a bottle must collect at the bottom, the oil in the middle and the gas on top. But the earth is not a bottle. It has no great caverns in it. More than that, the arrangement takes place naturally under the pressure of only one atmosphere; while any arrangement of water, gas, and oil, made at depths of a thousand or 2,000 feet, must be made under pressures of from 100 to 400 pounds to the square inch. \* \* \* It therefore seems to me irrational to assign any importance whatever to the extremely gentle anticlines of the gas-oil region.

To this I add the important consideration that the movements of oil and water have been shown by actual practice to be governed entirely by the character of the rock in which they take place, and that they are effectually stopped at fixed geographical lines where porous rock changes into sandstones and sandstones into shales. And these changes of character in the rock itself have no fixed relation whatever to the anticlinal waves, which, on the contrary, cross them transversely or diagonally.

White, in replies to these criticisms (1885b; 1886), again emphasized his position that not all anticlines would be gas-bearing, especially such subordinate anticlinal folds as occurred within the synclines. He pointed to the success which had attended development along eight anticlines in the vicinity of Pittsburgh and the failures which had resulted from drilling in the intervening synclines. Thus the importance of structure as a factor in the accumulation of oil and gas came to be recognized by the geological profession and by practical operators.

With the extension of oil and gas production to areas other than western Pennsylvania, it was soon found by the geologists working in them that modifications of White's theory were required to explain all the structural problems that arose. Minshall, by careful surveys along the White Oak anticline in West Virginia, had shown that the axis itself was undulating, with pronounced domes or summits at some points and sags or depressions at others, and that the commercial gas accumulations were confined to the domes. In Ohio, Orton (1888, pp. 93-95) found that anticlinals were of infrequent occurrence but that oil and gas accumulation was controlled by another type of structural deformation, which he termed "arrested anticlinals," or terraces.

#### PRESSURE OF GAS

One other major problem in connection with the occurrence of oil and gas greatly concerned the petroleum geologists of a half century ago—to find a satisfactory explanation for the pressure exerted by the gas upon the reservoir within which it was contained. Closed-in pressures ranging up to 1,000 pounds per square inch had been observed, and the enormous expulsive force of the gas, frequently causing the drilling tools to be violently thrown from wells, was well

known to operators. One explanation was that the gas formed in the earth much as steam is formed in a boiler and that the pressure resulted from the confinement of the gas. The theory most commonly held was that the weight of the overlying rocks caused the compression of the gas, and the resulting pressure was accordingly called "rock pressure." Lesley (1885) exhaustively studied this theory and demonstrated that the pressure of gas did not accord with the weight of the overburden. Orton seems to have been the first geologist clearly to understand the function of artesian pressure in relation to the pressure of oil and gas in the same stratum. He says (1888, p. 99):

In the porous rock that contains them there is always, outside of the productive fields, a body of water, and in almost every instance, salt water. This water occupies the rock as it rises to day in its nearest outcrops. Communicating there with surface water or with rainfall, a head of pressure is given to the gas and oil that are held in the traps formed by the anticlinals or terraces into which the stratum has been thrown. The amount of pressure would thus depend on the height to which the water column is raised, in case continuous porosity of the stratum can be assumed.

Later Orton (1890) published a paper on the origin of the rock pressure of the Trenton limestone which laid the foundation for all later studies in dynamic geology as related to oil and gas.

#### SUMMARY

The preceding review of the status of petroleum geology in 1890, though brief, may, nevertheless, demonstrate that this division of the science had been placed on a sound foundation by the pioneer work of the men whose writings have been cited. The difficulties which they encountered and the differences of opinion which developed among them were in large measure the result of an endeavor to oversimplify their science.

The tracing in detail of the evolution of these various ideas and theories and of their development into those which make up the present content of petroleum geology would unduly extend this paper. The writer accordingly passes to a review of its present status without attempting to follow closely all the changes in thought during the intervening period.

#### GENESIS OF PETROLEUM

##### GENERAL PROBLEM

Starting with an accumulation of factual information concerning the nature and occurrence of petroleum, and following the scientific method of thought, petroleum geologists have sought to discover the sources from which it has come and the manner in which it has originated. Most of them have held the opinion that oil and gas have been

derived from organic matter deposited in sedimentary rocks. Some chemists and, more rarely, geologists have sought to explain the origin of these hydrocarbons as due to inorganic processes. Through the years this smaller group has diminished in numbers, and at the present time the organic origin of petroleum is "generally accepted" (Snider, 1934, p. 51). But agreement on the general principle has proven much simpler than the collection of pertinent and adequate supporting evidence. Like the broader biologic principle of evolution, precise knowledge of its mechanism is attained only by many years of intensive investigation.

The general problem of the conversion of the organic material deposited in sedimentary rocks into oil and gas may be divided into more specialized fields of investigation, such as:

1. The character of the organic material which ultimately becomes petroleum.
2. The characteristics which give to a sedimentary deposit the capacity to produce petroleum.
3. The steps of chemical change whereby the organic matter of animals and plants has been converted into the various hydrocarbons of which petroleum is composed.
4. The nature of the forces which have been instrumental in, or have contributed to, the transformation of organic matter into petroleum.
5. The manner in which widely disseminated and minute quantities of such derivatives have been aggregated into appreciable quantities of fluid.

In attacking these problems most geologists and chemists have considered that the doctrine of uniformity of Lyell (1842, pp. 323-327), which assumes that the geologic processes and conditions of the present are essentially the same as those of the past, was applicable to the formation of petroleum. This is questioned by Woolnough (1937, p. 1106) who considers that petroleum may have been formed under "conditions of accumulation not now exhibited, on a major scale, in any part of the world." Any progress in the solution of problems of origin must, however, rest upon detailed examination of present processes on the assumption that, at least in kind if not in degree, they were operative in past ages.

#### NATURE OF ORGANIC MATERIAL

As to the kind of organic matter that is requisite to the production of petroleum, there is much divergence of view. Trask (1938, p. 384) considers that petroleum is a very special substance and that only certain types of organic material can be changed into petroleum, while Snider (1934, p. 62) holds the opinion that almost any kind of organic matter buried in sediments may, under proper conditions, be changed to petroleum and natural gas. These are wide extremes of thought which have been developed through quite different lines of approach.

Trask (1932), in an intensive study of the organic constituents of recent sediments, found that oils and fats form a very small part of the

organic matter present; that cellulose compounds derived from higher plants are also present in small quantities; and that nitrogenous compounds and complex compounds of lignin and humus form the bulk of the organic matter. He therefore reasons that petroleum must come from these complex organic compounds rather than from the very small quantities of oils, fats, and cellulose. However, no evidence is presented by him which suggests that, to the extent that they were present, these other substances may not also have become constituents of petroleum.

Whereas Trask's work has been primarily concerned with quantitative determinations of the presence in sediments of particular types of organic matter, other investigators have been attempting, through the analysis of individual oils and through the isolation of particular organic constituents, to develop suggestive relations with living organic matter. The presence in crude oils of a wide variety of microscopic objects, such as diatoms, Foraminifera, insect scales, and petrified wood, may be significant (Sanders, 1937). The identification in crude petroleum of chlorophyll porphyrins suggests a direct relation with higher forms of vegetable life (Triebs, 1935). Hlauschek (1936) considers that plants, producing lignin, form the principal source of cyclic hydrocarbons and that the life of the sea has been the source of the straight-chain type of hydrocarbons. Brooks (1936) regards fatty oils as the principal source materials, with other types of organic substances such as cellulose, starches, sugars, proteins, lignins, and waxes as additional sources. He points to the presence of heptane in pine trees and to the close relation between the terpenes and certain petroleum hydrocarbons. Berl (1938) also regards carbohydrates and derivatives thereof as the chief parent material of crude petroleum.

In the evolution of life from the earliest times to the present the dominant types of plants and animals have been different at various periods. It is probable, therefore, that the chemical characteristics of the remains of such life have also varied. Modern plants, for example, doubtless contain more lignin than Paleozoic plants.

Most geologists will probably accept the thesis that petroleum has been formed at all times in the earth's past by the transformation of the then existing organic matter and that the distinguishing characteristics of the petroleum found in deposits of different ages are related to the nature of the particular organic matter present in the area where the petroleum was formed at the time of its origin.

#### SOURCE BEDS

The concept that certain sedimentary deposits had greater capacity than others to originate petroleum is as old as petroleum geology itself. Dana (1871) taught that shales and argillaceous sandstones were the

most common original source and that the oil found in arenaceous sandstones was supposed to have been derived from the shales above or below. Black shales were thought to be rich in oil, probably because "coal oil" had been distilled from them. A relationship was thus early assumed to exist between the amount of organic matter present in sediments and their capacity to originate petroleum. The term "source beds" gradually came into use to distinguish those rocks from whose organic matter petroleum has originated. As the science advanced, however, it became apparent that such generalizations were not completely true, and about 20 years ago the need for experimental investigation of source beds began to be recognized. This took definite form in 1926 when the American Petroleum Institute sponsored a research program which is still continuing.

Investigation of so complex a subject was initially faced with inherent difficulties. The assumption that the source beds were stratigraphically closely associated with the reservoir beds depends for its validity on the premise that oil has accumulated near the zone and area of origin and has not migrated horizontally or vertically for long distances, a premise on which petroleum geologists are by no means in agreement. If organic matter in the form of petroleum has originated in particular strata, then the movement of the petroleum out of these strata will leave them poorer in organic matter than they were originally; hence present organic content may not be conclusive as to whether or not a particular bed has acted as a source of petroleum. On the other hand, if certain strata were originally sufficiently rich in organic matter to originate petroleum they may still, even after giving up some of their organic content, be richer in organic matter than other sedimentary deposits. If the geologic forces to which an area has been subjected subsequent to the deposition of the source beds are an important factor in the genesis of petroleum, then the amount and character of the organic matter originally present in the sediments may not be the major factor; the dynamic history may be controlling. These and other questions complicate the problem of recognizing source beds. Work on details of the problem has led to some specific conclusions, and in the following paragraph the writer has attempted to summarize present prevailing opinion on this subject.

Recent marine sediments contain as high as 7 percent organic matter with the average around 2.5 percent. Some older rocks, such as Monterey shale, may have had a higher organic content than recent sediments at the time of deposition. All ancient sediments have probably lost some of their original organic content, and the loss through aging may be as much as 40 percent. The proportion of the original organic content that may have been converted into petroleum is unknown but has been estimated at from 5 to 10 percent. In recent sediments the

organic matter consists of about 60 percent carbon, 7 percent nitrogen, and the remainder chiefly hydrogen. In ancient sediments the proportion of nitrogen increases, indicating that there has been loss of hydrogen and carbon through geologic change (Trask, 1932, p. 222). Dark sediments generally have a higher organic content than lighter ones, and the blackness of many marine shales is chiefly due to contained organic matter (Twenhofel, 1939, p. 1181). Hence, dark marine shales are generally regarded as good source beds and, when near oil reservoirs, are considered as the most probable source of the petroleum (Snider, 1934, p. 62).

The organic matter in recent sediments consists of a highly complex group of substances (Trask, 1932, p. 198). Oils and fats constitute only 1 percent; waxes, resins, alkaloids, and alcohols comprise about 5 percent; carbohydrates form less than 1 percent; sugars, starches, and other water-soluble substances, chiefly organic acids, form 3 percent. Nitrogenous compounds form the largest group, comprising about 40 percent, about half being proteins and the remainder more resistant nitrogenous compounds. Finally, about 30 percent of the organic matter consists of lignins and humic complexes. It is from such source materials that hydrocarbons must have been derived.

The organic matter of recent sediments is nearly all present in solid form. The proportion soluble in hot water comprises only about 3 percent, and all the material extracted from such sediments by solution in carbon tetrachloride appears to be solid in nature (Trask, 1932, p. 173).

#### CONVERSION OF ORGANIC MATTER TO PETROLEUM

The problem of when, where, and how the organic content of sediments was converted into petroleum is a refinement to which the geologist of half a century ago had not advanced and which received very little attention until 20 years ago. From the time that the problem assumed definite form, geologists have been primarily concerned with the time and place of conversion, while the manner in which the change occurred has been left largely to the chemists and biologists.

The uppermost layers of newly deposited sediments have a dense bacterial population, and such microorganisms are probably an important factor in the generation of hydrocarbons. Bacteria function to remove nitrogen and oxygen from the organic matter contained in the sediments, which is thus changed in composition so as more nearly to resemble petroleum (Hammar, 1934). This transformation probably occurs very early in the history of the sediments, and there is little if any evidence to support the view that bacterial action continues after sediments have been deeply buried and subjected to dynamic action (David White, 1935).



Up to quite recently such evidence as was available to geologists tended to show that petroleum was formed at the time of deposition and buried with the sediments (McCoy, 1926, p. 1022). However, extensive chemical examination of recent marine sediments indicates that petroleum is not present in them and consequently is not formed at the time of deposition or shortly thereafter (Trask and Wu, 1930). Recent sediments, therefore, appear to have reached a stage in their history at which the bacterial action has largely run its course but at which petroleum has not yet been formed. The organic matter, the "mother substance" of petroleum, as it is sometimes called, presumably is present in such sediments in solid form, analogous to the solid bituminous material, called "kerogen," found in oil shales (McCoy and Keyte, 1934, p. 271). Berl (1938, p. 2) considers that, after bacterial action has ceased, carbohydrates, humic acids, and lignin are converted into intermediate substances which he calls "protoproducts" and which he considers the parent materials for petroleum. Other chemists, notably Hackford (1932), have also sought to trace the transformation of vegetable matter into petroleum. Most chemists consider that only moderate temperatures, such as are within the bounds of geologic probability, are required to effect such changes. Time, of which the geologist sees an abundant supply, is also thought to be an important factor in the conversion.

Much work remains to be done before the various steps in the conversion of organic matter into petroleum can be accurately traced. At some stage in the process the solid organic matter laid down with the sediments is converted into fluids, and it is only then that movement from source bed to reservoir becomes possible.

As a result of studies of crude oils in the Gulf Coast, Barton (1934) concluded that petroleum, when first formed, is heavy and viscous and has, as the result of the operation of heat, pressure, and perhaps other forces, evolved into progressively lighter oils. He has, however, also observed that deeper oils have lower specific gravity than those nearer the surface. To what extent this relationship may be explained by loss of volatile constituents through escape to the surface is unknown, but the inference of recent intensive geochemical studies is that there is a definite upward movement of hydrocarbons from the reservoirs to the surface, even though the cover rocks may appear highly impervious to such migration.

#### GEOLOGIC FORCES OPERATING TO PRODUCE PETROLEUM

The chemical reactions required to produce petroleum from the "mother substance" have presumably not occurred spontaneously but have been brought about by competent physical forces, such as heat, pressure, and movement. All these forces are operative in deeply

buried sediments, and geologists, contrasting conditions in such sediments with those occurring at the surface, have naturally sought in some way to relate the origin of petroleum to them.

As a section of sedimentary rocks is deposited, the weight of the overburden progressively increases, and the deeper beds become heavily loaded. The pressure thus created causes compaction of the sediments, which become more dense with increase in depth (Athy, 1930a). Compaction is accompanied by closer spacing of the grains and by the gradual displacement from the sediment of most of the interstitial water. The friction resulting from movement of the grains may produce some heat (Pratt, 1934, p. 242), and chemical reactions, such as the oxidation of pyrite, may be another source, but it is probable that the internal heat of the earth is the chief cause of increase in temperature with depth. Whatever the cause, recent drilling in sedimentary basins to depths approaching 3 miles has revealed the existence of temperatures of nearly 300° F. Such temperatures are greater than those which chemists have usually considered would be available for geochemical reactions leading to the formation of petroleum. The opinion (McCoy and Keyte, 1934, p. 269) that most of the known oil fields were formed at temperatures lower than 140° F. may, therefore, require revision. Even temperatures of around 300° F. are, however, lower than those usually considered to be within the "cracking range," and the reactions by which petroleum has been formed may still, from the chemist's standpoint, be considered low-temperature changes. The reactions by which organic matter is converted to petroleum are essentially endothermic, and the energy present in the form of heat in the sediments where petroleum is being formed accordingly facilitates them.

Pressure may have had an important effect in the formation of petroleum by favoring polymerization (Brooks, 1938, p. 51). Hydrogenation and other types of chemical transformation of hydrocarbons are also facilitated by pressure (Pratt, 1934, p. 241). In addition to the weight of the overburden, pressure in sediments may be due to hydrostatic head, the presence of petroleum gases in porous reservoirs, and possibly other factors such as cementation and chemical metamorphism. As water-free sedimentary rocks have an average specific gravity above 2.5, the weight of the overburden might be expected to result in pressures at depths greatly in excess of the weight of a column of water of equivalent height. Measurements indicate, however, that the hydrostatic pressures existing in underground reservoirs normally correspond to the weight of such a column of water (Versluys, 1932) rather than to the weight of the overlying sediments. This has been found true in wells drilled to depths of over 13,000 feet in which the reservoir pressures exceed

6,000 pounds per square inch. When pressures of that magnitude occur in combination with temperatures of 300° F., their potency to effect chemical changes must be great.

Recent unconsolidated sediments contain large amounts of water. As compaction progresses, fluids in the strata which are being compressed are forced from them. While this movement may be of great importance in connection with the migration of petroleum (Athy, 1930b), it may also be a significant factor in the chemical reactions which produce petroleum by facilitating molecular rearrangement.

#### AGGREGATION

The work of Trask and others has indicated that there is great variation in richness of organic content between types of sediments and between beds in the same geologic section. Vertical variation in organic content is generally greater than horizontal variation. But, after full allowance has been made for such differences, the fact remains that organic matter is quite universally distributed throughout sediments of marine origin. The sediments which are usually richest in organic matter are fine-textured shales, and the organic matter is minutely disseminated through them. The pore spaces of such sediments are of capillary dimensions, and older sediments of this character are highly impervious to the movement of fluids. When first deposited, such sediments were clays and silts with large volumes of interstitial water (Trask, 1932, p. 77; Twenhofel, 1932, p. 258).

It is in such an environment that the solid organic matter laid down with the sediments has been transformed into other compounds which are capable of being transported by water. If the organic matter were water-soluble its movement through capillary spaces would occur more readily than if it were in the form of minute globules of hydrocarbons insoluble in water. It is conceivable that the solid organic matter which is later to become petroleum has at first been converted into water-soluble or water-miscible intermediate compounds and that it was in some such state when it first left the place of original deposition. In that case the further chemical change of such intermediate compounds to petroleum might occur after the organic matter had been removed from the point of original deposition and had, in the course of its movement, come into contact with solutions or forces which had caused further reactions to produce the hydrocarbons which collectively form petroleum and natural gas. No experimental work with which the writer is conversant clarifies this problem.

Whatever the precise process of chemical change may have been, it seems necessary to postulate that somewhere in the very early history of petroleum there must have been an aggregation of finely divided

material into appreciable quantities of hydrocarbons which would be present in the water-saturated sediments either as a solute or in the form of globules physically distinct from the water. While the mechanism of this process is unknown, it appears to be an essential link in the chain of the origin of petroleum.

The available evidence indicates that this aggregation occurs within the source rock. Older sediments of marine origin, both dense and porous, are impregnated with small quantities of petroleum, in contrast with recent sediments in which it is rare or absent. This was well known to Orton (1888, p. 83) who estimated the quantity of petroleum present in this diffused condition in some of the rocks of Ohio. Surprisingly little detailed investigation of the quantity and distribution of petroleum in older rocks has been carried on. Trask has determined the organic content of many samples of older rocks from wells, but the analyses do not disclose the amount of organic matter present in the form of petroleum. Stout (1936, p. 799) studied various Ohio limestones and shales and found that the content of hydrocarbons was about 0.5 percent. Most geologists will probably be in accord with the statement of Illing (1938b, p. 209) that

There can be no doubt that a still larger amount of oil and gas occurs as a more widespread but less concentrated impregnation of the denser rocks, the clays, marls and limestones surrounding the reservoir rocks.

In concluding this discussion of the genesis of petroleum, the statement seems justified that the conversion of the complex organic substances deposited with the sediments into the petroleum found in older rocks takes place within the source bed and results from the various chemical and physical forces to which the organic matter has therein been subjected.

## MIGRATION OF PETROLEUM

### GENERAL STATEMENT

The accumulation of petroleum in immense concentrations in oil pools is in contrast with its wide diffusion through the source beds in which it had its origin. The movement of petroleum from source to reservoir has resulted from the operation of physical forces, and geologists are vitally concerned with the character of these forces and the extent of their effectiveness. This movement is collectively called migration, but the use of such an inclusive term is deceptive, for the process is doubtless highly complex. In its simplest form it may be resolved into a consideration of (1) movement of oil from source bed into carrier bed; and (2) movement through the carrier bed to the reservoir.

## MIGRATION FROM SOURCE BED TO CARRIER BED

The compaction of sediments by the increasing load of younger beds deposited in succession is accompanied by the loss of a large part of the interstitial water they originally contained (Athy, 1930). The connate water remaining in the sediments adheres closely to the individual grains and fills the intervening voids. Because of the presence of this film of closely adhering water, which is present even in well-saturated oil reservoirs, it is probable that petroleum normally does not wet the grains but remains in the interstitial passages in the form of minute globules (Schilthuis, 1937, p. 200). The movement of the interstitial water is regarded as the principal cause of the migration of oil from the source beds. The outward movement of water from such sediments will be in the direction of least resistance, from the clays and marls into the more permeable strata. If at the time this outward movement is in progress petroleum has already formed in the sediments, it may be expected to move with the expressed water into the more porous beds which are competent to act as carriers (Illing, 1933).

With the passage of time and the completion of the cycle of deposition the sediments gradually become lithified and a condition will ultimately be reached in which the compaction of the deeper beds will cease. The more competent members of the series will acquire strength to sustain the load of the overlying sediments, and the fluids which they contain will reach a state of equilibrium.

Capillarity has also been thought competent to cause the movement of petroleum from the source bed to the carrier bed. McCoy (1926, p. 1027) concluded, on the basis of experimental evidence, that there is an interchange of fluids between the source bed and the carrier bed, the oil in the source bed being expelled into the more porous bed and replaced by an equal amount of water. This interchange was thought to occur in the capillary spaces of the source rock and to be caused by the superior surface tension of the water; the water, having a greater adhesive tension for the wall of the capillary than does the oil, and its adhesive tension for the wall of the capillary being greater than the surface tension of the oil, the oil column in the capillary would be broken, and minute globules of oil would be split off and moved through the capillary in the direction of the more permeable bed.

Other forces which have been considered as contributing to the movement of oil from denser to more porous rocks are artesian circulation and diastrophic movements in the sedimentary basin. The effectiveness of the first-mentioned is questionable, for artesian flow is likely to take place through the most porous beds and is unlikely to be effective in the denser sediments. Diastrophism may have been effective in creating compressive forces which may, in turn, have acted on the

denser strata and caused fluid movements in the capillary spaces, but there is little in the way of direct evidence to support this thesis. Diastrophic movements, by producing fractures and faults, have opened new channels for the vertical movement of fluids from one porous bed to another or have brought into contact reservoir beds not previously communicating.

#### MIGRATION THROUGH THE CARRIER BED

The term "carrier bed" was introduced by Rich (1931) to designate porous beds, such as coarse sands or cavernous limestones, which were favorable in texture to the movement of oil. While the term was intended especially to describe beds that would facilitate long-distance migration, it is a convenient designation for any porous stratum through which petroleum may have moved, and it is used here in that broader sense.

It has been postulated that, during the compaction of a series of sedimentary rocks, water carrying globules of petroleum has moved from the source bed into the more porous adjoining carrier beds. Firstly, if a bed were sufficiently extensive to have a surface outcrop along the margin of the basin, the excess water would have an opportunity to follow it toward the outcrop and, perhaps, there to make its escape. But the same outcrop would also permit the entry into the carrier bed of meteoric waters and, depending upon the altitude of the outcrop and other conditions, the meteoric waters might be able to resist the outward movement of the connate waters to such an extent that their escape through the carrier bed might be prevented. In that case, the line of least resistance to the movement of the excess water might be across the bedding, through the less pervious rocks forming its cover. Secondly, if the carrier bed does not have a surface outcrop, the excess waters deposited with the sediments will ordinarily have only one avenue of ultimate escape—across the bedding planes. It seems probable that most of the excess interstitial water must have passed upward through the section, for, at the time when the basin was in formation and compaction was in process, the basin would usually not have been sufficiently deformed and eroded to provide the carrier beds with surface outcrops.

Once having entered the carrier bed, the particles of petroleum which had passed through the capillary pores of the source rock would tend to coalesce into larger globules in the wider interstitial spaces of the carrier bed. These larger globules would be capable of lateral movement through the carrier bed but would not be able to enter the smaller capillary spaces of an overlying clay or shale. If the water in the carrier bed were forced upward as a result of compaction, the globules of oil would be left behind and would be held at the interface.

This concept has been developed by Illing (1933) who called the process "filtration." It was also well described by Versluys (1932) who remarked that "fine grained strata act as screens when water, charged with small globules of oil or minute bubbles of gas, is forced through them."

By some such mechanism petroleum has moved from the source beds into the more porous beds throughout the entire extent of their contact. Information gained over many years by drilling into porous beds has shown that it is exceptional that more than a small part of the entire area of a porous bed is saturated with oil and gas; by far the larger part contains water. It seems evident that in some manner the petroleum must have been collected from the wide areas throughout which it entered the porous beds and concentrated in the relatively much smaller areas which it is now found to occupy.<sup>2</sup> The movement by which this has been accomplished is essentially a lateral movement, one which continues until the petroleum reaches a stratigraphic or structural trap.

An explanation of this movement which is satisfactory to the geologist and which will withstand successfully the criticism of the physicist has been difficult to attain. The earlier geologists had a simple and, to them, complete explanation. Oil and gas, being lighter than water, floated above it and filled the highest portion of the porous rock. Abundant evidence accumulated which was considered to support the principle of flotation, and it became quite generally accepted, along with the corollary that, if the dip of the porous beds were sufficient to overcome friction, the particles of oil and gas would gradually move up the slope to the pool, the gas with its lower specific gravity occupying the higher places (Griswold and Munn, 1907, p. 24).

Munn (1909) was, perhaps, the first to question the adequacy of flotation or buoyancy to account for the accumulation of oil pools, considering that the enormous pressures developed in oil and gas wells were not satisfactorily explained by it. Following him, other investigators down to the present have thought that flotation alone could not produce migration. Illing (1938b) says:

It is therefore not at all certain from first principles that gas, oil, and water will separate out by flotation in the pores of the rock, and it is clear that the separation will depend upon certain limiting conditions, the relative importance of surface tension and buoyancy.

---

<sup>2</sup> Some geologists, on the contrary, consider that the accumulation of oil takes place essentially in situ (McCoy and Keyte, 1934) and is due to the juxtaposition of rich source bed and reservoir. Clark (1934) also favors this view, explaining the absence of oil in some apparently favorable traps by the absence of rich source beds in their immediate vicinity. It would appear to the writer coincidental that zones of unusually rich source material should have been formed in the source rocks in the same localities that later become the loci where traps were formed by structural deformation. The writer thinks that the organic matter has been more uniformly distributed and that wider areas have been drawn upon to fill the traps.

In contrast with the principle of flotation, which requires no lateral movement of the fluids in the reservoir but only displacement of individual particles, other theories which are based on the fundamental principle that the fluids in the porous bed are in motion have been developed to account for oil migration. Munn (1909) announced the "hydraulic theory" that moving water under either hydraulic or capillary pressure has been the direct agent of accumulation of oil and gas pools." It was his view that hydraulic pressure was the result both of compaction and of invasion by water from surface sources. The causes of hydraulic movement were more definitely stated by Rich (1931) to be compaction, generation of gas by regional metamorphism, and artesian pressure.

Cheney (1940, p. 116) has recently suggested a modification of earlier views concerning hydraulic movement. He visualizes

\* \* \* the main controlling movement of fluids (except in reservoirs having intake greatly elevated above sea level) as occurring updip instead of downdip; the time of movement being largely restricted to the early periods when porosity was being reduced actively by sedimentary loading or compressive diastrophic forces instead of later when erosion and unloading progressively reduce pressures; and the source of the migrating water being not meteoric but from the compacting sediments of the basin or geosynclinal areas.

A combination of the principles of flotation and hydraulic movement seems best to explain the movement of oil and gas to areas of accumulation. If globules of oil are put in motion in currents of water which are passing through porous rocks, they will at every opportunity seek a higher position. Because of the difference in specific gravity a definite upward pressure is exerted on each oil globule and, if it is in a condition of flotation and can move freely, it will tend to move upward with reference to the water by which it is surrounded. It will come to rest when it reaches a capillary opening too small to permit its passage, taking into account the pressure exerted against it by the moving water. Ultimately the decrease in the size of the capillary spaces due to compaction will retard and perhaps completely stop hydraulic movement in a sedimentary basin, bringing about at the same time a cessation of oil migration in the carrier bed.

The fundamental cause of the movement of fluids through porous beds is differential pressure, and the amount and direction of pressure are determined by the geologic conditions in the area at the time the movement takes place.

#### EFFECTIVENESS OF CARRIER BEDS

The extent to which movement of oil from source rock to reservoir may occur is largely determined by the effectiveness of the carrier bed as a conductor. The capacity of a porous substance to transmit fluids is termed permeability. Some of the factors which influence the perme-



ability of rocks are congenital; others are the result of subsequent geological processes.

Congenital factors are lithology and areal extent. Sands are initially more permeable than marls and clays; coarse sands more permeable than finer ones. Certain fragmental or oolitic limestones, however, originally had permeability comparable to that of sands. Porous rocks that were deposited over limited areas in the form of lenses or that gradually became less porous laterally as a result of change in composition are obviously less effective as carriers than those which were laid down over wide areas. Even "blanket" sandstones such as the St. Peter, Berea, Dakota, and Woodbine, which are regionally continuous, are, however, by no means uniform in permeability and frequently contain "tight" areas. Limestones show an even greater variation, such as that which accompanies a change from reef to offshore facies.

Factors which have reduced the permeability of rocks subsequent to deposition include compaction, lithification, cementation, and recrystallization. The effect of compaction in reducing the size of pore spaces has already been mentioned. Changes in density, such as from sands to sandstones and from clays to shales, however they may have been accomplished, usually reduce the effectiveness of rocks to conduct fluids by forcing the individual grains into closer contact. The factors just mentioned are usually most effective soon after the sediments are deposited. Cementation, which may occur either during the early or the later history of the sediments, may change a rock which was originally a competent carrier to one which may be highly impervious, as illustrated by the change from sandstone to quartzite (Twenhofel, 1932, p. 229). Recrystallization may in some cases increase porosity but it is quite as likely to decrease permeability by closing capillary passages. Dynamic metamorphism has an influence of the second order by bringing into play some of the factors which have been specified.

Permeability has, on the other hand, been increased by other factors such as solution and fracturing. Solution has functioned chiefly in calcareous and dolomitic rocks. It has resulted from subaerial exposure and weathering and in many limestone fields has unquestionably increased the porosity of the reservoir (Adams, 1934). Such paleogeographic conditions would presumably be local rather than regional and may therefore have influenced migration of oil over limited areas. Solution has in many cases acted to increase the initial porosity, and it then becomes difficult to determine how much of the permeability is primary and how much secondary. The importance of fracturing in increasing permeability also varies greatly among different areas. Such highly permeable limestones as the

Permian of the Yates and Hobbs pools have apparently not been affected by fracturing. In contrast, the movement of oil in the Panuco field in Mexico is largely due to fracturing and faulting (Muir, 1934), and Lees (1933) considers that the permeability of the Asmari limestone in the Iranian fields is primarily due to fault cracks. Limestones such as the Asmari and the El Abra have enormous permeability over wide areas.

#### DISTANCE OF LATERAL MIGRATION

One of the most debated topics in petroleum geology is the extent to which petroleum has migrated from one area to another; some consider that such movement has been restricted to comparatively short distances (Clark, 1934; McCoy and Keyte, 1934), while others contend that it may have traveled for "tens or even hundreds of miles" (Rich, 1931).

The basic factors which determine the distance of lateral migration of oil and gas are the extent, permeability, and continuity of the carrier beds. In the hypothetical case of a carrier bed of high and uniform permeability and of regional extent it is evident that, under conditions of differential pressure, fluids should be able to move through it for long distances. But conditions of sedimentation which even approach such uniformity are exceptional; lateral variation is the normal condition.

The simplest case is that of a lenticular sand enclosed within shales and having an areal extent of a few square miles. In such a carrier bed the movement of fluids is not caused by artesian pressure but by forces of more limited scope; it occurs most readily while the sediments are in process of compaction and while the shales are sufficiently pervious to permit substantial movement across bedding planes. During this interval the sand would have received from the source beds adjacent to or near it its quota of oil and gas. It is difficult to see how, later, after compaction and lithification are essentially completed, much migration beyond the limits of the sand would normally occur. Any further movement of fluids in a carrier bed of such limited extent would result from the deformation of the sedimentary basin, producing tilting, faulting, and folding. Cementation in sands and limestones would limit lateral migration by creating restrictions on movement comparable to lensing.

On the other extreme are carriers such as the Woodbine and the Dakota in which artesian conditions are known to occur over many thousands of square miles. Drilling, both for water and for oil, have demonstrated that through basins such as East Texas, the artesian pressure system is essentially continuous even though there may be local variations in permeability. It is again difficult to explain how such an

immense accumulation of petroleum as is present in the East Texas field has been derived from a highly restricted and local source; it is more reasonable to consider that the Woodbine has been an effective carrier bed across large areas.

Between such extremes the geologist meets an almost complete gradation. The writer considers that each field presents a special problem in migration and that a simple generalization which will explain all cases is not to be expected or even sought.

## ACCUMULATION OF PETROLEUM

### METHOD OF ACCUMULATION

The fundamental force which determines in what part of a carrier bed accumulation of oil and gas will take place is gravity. Having ordinarily a lower specific gravity than water, they have, when present in the same reservoir, greater buoyancy, and gravitational separation results. The mechanism of accumulation has been well stated by Rich (1923):

Accumulation results from the selective segregation of oil and gas, which, on account of their buoyancy, always tend to work their way upward toward the roof of the reservoir as they are carried along by the water, and so are caught in anticlinal or similar structural [and stratigraphic] traps, or in places where differences of porosity cause a "screening" section which permits the passage of water, but holds back oil and gas.

### PLACE OF ACCUMULATION

*General statement.*—A trap is a geologic feature causing the accumulation of fluids in porous rocks; in petroleum geology the use of the term is restricted to an accumulation of oil and gas—the "structure" of the practical oil man. Various classifications which make it possible to visualize more readily the wide range of circumstances under which such accumulation has occurred have been proposed by geologists (Clapp, 1929; Wilson, 1934). The porous zone in which the oil and associated fluids have accumulated within the trap is called the reservoir. Accumulation occurs, in principle, because the upward and lateral movement of the oil and gas is arrested by the presence of a barrier—in other words, a trap or closure.

Traps are formed by conditions which were established at the time the sediments were deposited, by the diagenesis and lithification to which the sediments have later been subjected, and by deformation. Most of those in the first two groups (depositional and diagenetic), described in the following paragraphs, may also be classified as stratigraphic traps, while those in the third (deformational) are structural traps (Levorsen, 1936, p. 524). While some traps are of

simple types, most of them are formed by a combination of factors. Oil fields may be due to only a single trap, but more frequently several traps are present and these may be of more than one type. In the following summary the more important types of each group, and some of the oil fields which are illustrative of each, are mentioned.

*Depositional traps.*—Traps which are the result of conditions established when the sediments were deposited are of two principal types: those in which the reservoir bed wedges out laterally between less permeable strata or in which the character of the reservoir bed changes lithologically; and those in which the porous bed has been truncated and the beveled edge has been overlapped by a less permeable bed.

In order for the wedge to be an effective trap it must point up-dip, and this inclination may be either initial dip or the result of subsequent tilting. Important oil fields of this type are Burbank (Sands, 1927) and Glenn (Wilson, 1927), Oklahoma, and the East Coalinga field, California (Atwill, 1940). These fields occur on the margin of sands which have large regional extent. A similar type of accumulation occurs in lenticular and "shoestring" sands where the areal extent of the trap may be quite small, as in the fields of eastern Kansas and western Pennsylvania (Rich, 1938).

The truncation of a porous bed and the unconformable deposition across its edge of a cover rock forms an excellent trap. An outstanding example is the East Texas field (Minor and Hanna, 1933), in which the oil has accumulated in the truncated edge of the Woodbine sand. The sands of the Simpson group in the Oklahoma City field are overlapped by Pennsylvania strata to form traps of this character (McGee and Clawson, 1932).

*Diagenetic traps.*—In this group are included those traps which have resulted from changes in the petrology of the reservoir rocks subsequent to their deposition—that is, from diagenesis. Accumulation in sandstones may be controlled by cementation, as in some of the Venango sand fields of Pennsylvania (Torrey, 1934, p. 472) and the Clinton sand fields of Ohio (Billingsley, 1934, p. 505). More frequently, however, traps of this group are formed by the solution and recrystallization of limestones (Howard, 1928; Adams, 1934). Long after they were deposited diastrophic movements have frequently exposed limestones to weathering. Subaerial exposure and solution by ground water have then produced secondary porosity in the limestone, and, when the weathered surface was covered by later sediments, a trap suitable for oil accumulation has resulted. The formation of dolomite by the recrystallization of calcite and aragonite is probably responsible for increasing the porosity of limestones, and this alteration seems frequently to be a part of the paleo-

weathering just mentioned. Certainly some of the most prolific limestone reservoirs are in dolomites which seem to be of secondary origin.

In the Lima-Indiana field oil has accumulated in the upper zone of the Trenton limestone, the porosity of which has probably resulted from dolomitization (Carman and Stout, 1934). In the fields of Michigan, where the Dundee formation is the most important reservoir rock, dolomitization is the principal cause of porosity (Hake, 1938). In the Oklahoma City field the Arbuckle limestone, the lowest producing horizon, of lower Ordovician age, has been partly eroded, and the porosity of the reservoir has evidently resulted from weathering (McGee and Clawson, 1932).

*Deformational traps.*—Tilting, folding, faulting, and intrusion have for the most part, resulted from movement which has occurred in sedimentary deposits since their deposition, and each has been responsible for the formation of oil and gas traps.

The tilt which may be imparted to sediments largely controls the direction in which oil and gas move. In some fields the accumulation is due primarily to tilting of the porous bed into a monoclinial position. If, at the same time, erosion has exposed its margin at the surface the oil which moves upward through it will escape. Lighter oils are thus drained from the reservoir, but more viscous oils may, through loss of lighter fractions, form a breccia which gradually seals the reservoir near the surface and becomes a barrier to further movement. Examples of this type of trap are found in the Sunset-Midway field, California, in which some of the sands are filled by tar near the surface (Pack, 1920, p. 87), and in the Lagunillas field, Venezuela, where the oil gradually decreases in Baumé gravity eastward as the sands rise toward the outcrop. More commonly, however, tilting has produced traps through combination with other factors, such as stratigraphic variation.

Folding, causing anticlines and synclines, domes and basins, is in all probability the most important factor in producing traps for oil and gas. The first structural form recognized as controlling accumulation was the anticline, and for many years the petroleum geologist was chiefly concerned with the finding of domes in which the trapping of oil was primarily dependent on structural closure. Fields in which folding of this type is the primary cause of accumulation are numerous, and only a few of the most prominent need be mentioned. Long Beach, Calif., is the most productive dome in the United States, with a total yield of over 630,000,000 barrels. Santa Fe Springs, Elk Hills, and Kettleman Hills are other California fields of this type. Salt Creek, Wyo., the most productive field of the Rocky Mountain area, is a domal structure. Accumulation in the Seminole fields of Oklahoma is primarily on domal folds (Levorsen, 1929). Domal folding has been the controlling factor in forming traps in the Hobbs field, New Mexico, and in the Yates and Big Lake fields in west Texas.

In Iran, the Haft Kel field is situated on a structural high on a long anticline, while the Masjid-i-Sulaiman field is on a more complicated anticlinal structure (Lees, 1938). In the Baku district of the U. S. S. R. such structures as Bibi-Eibat and Surakhany are typical domes, while most of the other fields are apparently anticlinal folds (Hobson, 1938).

Faulting, resulting from both tensional and compressional forces, has been the controlling factor in the formation of another group of traps. The importance of faulting in oil accumulation did not receive recognition until about 20 years ago when the discovery of the Mexia field in East Texas, followed by that of a number of others in the same structural province, directed attention to this form of trap. In the Mexia district the regional dip of the sediments is eastward; the faults nearly parallel the strike and are upthrown to the east, and the accumulation occurs in the upthrown block against the fault plane (Lahee, 1929). Some 20 fields of this type have been found in the district, but elsewhere in the United States such fields are unusual. Whittier and Round Mountain are California examples.

Overthrust faulting, while not the major factor in accumulation, is an important feature of such fields as Turner Valley, Alberta (Link and Moore, 1934), and McKittrick, California. Illing (1938a) states that the Tabaquite field, Trinidad, appears to have accumulated in a thrust block. At Boryslaw, Poland, oil is believed to be trapped by the overturn of a thrust block (Cizancourt, 1931).

The penetration or deformation of sediments by intrusions, either saline or igneous, forms a varied group of traps for oil and gas. Under the weight of the overburden deeply covered salt masses become plastic and, at points of weakness, burst through the strata above them to form intrusive plugs. Depending upon the pressure, the volume of salt available, and the character of the overlying sediments, salt plugs show great variation in size, form, and extent of movement. Those of the piercement type have, in many cases, penetrated many thousands of feet of overlying deposits, often reaching the surface; on the other extreme are deep-seated domes which may have penetrated the beds above them for only a comparatively short distance.

Piercement domes tend to drag upward the edges of the beds penetrated, and the porous beds, sealed against the salt mass, form annular reservoirs. If the salt plug does not reach the surface, overlying strata may be arched upward, forming circular reservoirs above the plug. If the section above the ascending salt mass contains beds of some degree of competency, faulting may result. The stretching of the beds over the plug may be compensated by the formation of a central graben. Tangential faults along the margins of plugs are frequent. In some regions, such as Germany and Rumania, the salt masses have been highly distorted by diastrophic movements, and the accompanying reservoirs have been intricately folded.

The most important area in which petroleum has accumulated in relation to salt plugs is in Louisiana and Texas, near the coast of the Gulf of Mexico. The discovery of the Spindletop field, Texas, in 1901 originated a campaign of exploration which has resulted in the development of over 200 oil-bearing structures, of which over 100 are definitely known to be salt domes, while most of the others, from structural and other evidence, are believed to overlie deep-seated salt plugs (Barton and Sawtelle, 1936). Salt domes are important types of accumulation in Mexico, Germany, Rumania, Arabia, Transcaspia, and Iran.

Igneous intrusions have caused the deformation of sediments and thus produced traps. Well-established examples of this type of accumulation are the Thrall (Udden and Bybee, 1916), Chapman (Sellards, 1932), and Lytton Springs (Collingwood and Rettger, 1926) fields in Texas, the Furbero field in Mexico (DeGolyer, 1932), and, probably, the Motembo field of Cuba (Lewis, 1932).

*Combination traps.*—Many oil fields are more complex in character than those which have been cited. Among larger fields Bradford, Pennsylvania, is an example of a trap formed by a combination of depositional and deformational factors. Structurally the field is anticlinal and has a gas cap and a marginal oil-water contact, but the lensing out of the principal reservoir sand within part of the area of closure has limited commercial production to only part of the structure (Fettke, 1938). In Cushing, Oklahoma, and other mid-continent fields, folding, faulting, and overlap all occur and to some degree have influenced the accumulation of oil and gas. Nienhagen, in Germany, Boryslaw, in Poland, and Bustenari, in Rumania, are European examples of complex structures. Many other fields throughout the world could be mentioned as examples of involved conditions of accumulation but, to the extent that the facts have been ascertained, it has been found that the fundamental principle of buoyancy may be universally applied.

#### TIME OF ACCUMULATION

The sedimentary rocks in which petroleum has originated were deposited in submerged areas in the earlier phase of an orogenic cycle. The volume of sediment which may be deposited in a single cycle in an area undergoing depression may reach enormous proportions. In the Rocky Mountain region over 10,000 feet of Upper Cretaceous sediments were deposited (Spieker, 1931), and in the Gulf Coast geosyncline the maximum thickness may be greater than 30,000 feet (Barton, Ritz, and Hickey, 1933). This earlier phase is one of quiet sinking (Bucher, 1933, p. 126), accompanied by compaction, and the sediments may be undisturbed by major diastrophic movements for many millions of year after deposition (Levorsen, 1935). The later

phase of the orogenic cycle is one of crustal folding, during which ranges are formed that divide the original submergent area into separate basins. Additional materials are removed from the uprising ranges to add to the volume of sediment in these basins. Local folding and progressive overlap will, during this phase, form traps along the margins of the basins and the flanks of the uplifts (Herold, 1938, p. 837).

The generalized history just outlined is typical of some areas which have undergone a single orogenic cycle. Most basins have had more complex histories; breaks in deposition are marked by unconformities, and folding may have occurred at more than one period. The petroleum generated and retained in the sediments, equally with them, has been affected by all the forces exerted during the orogenic cycle. In contrast, petroleum is capable of movement, and its location has shifted as a result of changes in the attitude of the containing sediments. Each successive orogenic cycle, therefore, may influence the accumulation of petroleum and the location of petroleum deposits.

Movement of petroleum during the earlier phase of an orogenic cycle is controlled primarily by the regional dip due to subsidence, and such movement, conceivably, can occur quite early in the history of the sediments. At the close of the first phase, the quiet sinking period, petroleum should have been concentrated toward the more elevated portion of the area of deposition insofar as the continuity of carrier beds would permit. During the second phase, the period of crustal folding, local traps are formed into which the petroleum migrates and accumulates. Levorsen (1935) has pointed out that those local traps which form in the area of primary regional accumulation tend to be more productive than similar traps outside such areas.

In areas which have been affected by more than one period of orogenic movement some traps formed during earlier cycles have survived through later cycles while others have been destroyed. The traps that lie in the deeper parts of the basins have the better chance of survival. In some cases oil has migrated from rocks which were formed during the earlier cycle into those which were formed during a succeeding one; traps in basal sands above an unconformity have been filled with oil which has moved upward from older deposits below the unconformity.

Traps which are formed during earlier cycles of orogeny or during earlier periods of folding have an advantage over those which are formed later in the history of a basin. The Kelsey anticline, Texas, is an illustration of a well-closed but barren trap which is thought to have been formed too late to accumulate oil in the Woodbine sand, which is so productive in other neighboring fields in the East Texas



basin (Denison, Oldham, and Kisling, 1933). The East Texas field, in the same basin, is a trap formed in the Cretaceous cycle, the outline of which has shifted northward as a result of recent diastrophic movement (Levorsen, 1935).

In conclusion, we may accept the generalization of David White (1935, p. 608) that the great migrations of oil and gas were accomplished mainly in periods of orogeny.

#### DISPERSION OF PETROLEUM

It is probable that the oil and gas of every reservoir, however deeply buried and covered by "impervious" rocks, is escaping, either upward through the overburden or laterally along the bedding. Generally the process must be exceedingly slow and almost imperceptible, else most oil fields would, in the course of geologic time, have been destroyed by such leakage. The presence in Oklahoma of large oil fields of Ordovician age at depths of less than a mile illustrates how effective overlying rocks may be in preventing, through many millions of years, the dispersion of petroleum. In contrast, the loss of petroleum from underground reservoirs may be relatively rapid and visible, as is evidenced by the large quantities of petroleum that have reached the surface in many areas. Such asphalt deposits as those at Pitch Lake in Trinidad are proof of how great such wastage may be under suitable conditions.

In most petroliferous regions this reservoir loss is manifested by various surface indications, such as oil and gas seepage, deposits of brea and asphalt, bituminous dikes, tar sands, and mud volcanoes. These may be regarded as incidents of the erosion cycle in such areas. Where uplift and erosion have exposed the margin of an oil reservoir, so that a direct avenue of escape to the surface has been formed, its contents will soon be lost. Light oils and gas may be completely drained, while heavier oils, on reaching the surface, may solidify, seal the exposed reservoir beds, and thus retard the process of dispersion. Faults which in some cases form traps for petroleum may in other cases produce at the same time a channel along which some of the trapped oil may escape to the surface. The deformation which produces folded structures may also develop faults in the flexed strata along which the oil and gas may pass upward to shallower reservoirs or to the surface. An example is the Salt Creek anticline, Wyoming, to which attention was first directed because of the presence of oil seeps near the axis of the structure and the development of which has revealed the presence of numerous faults, some of which extend to the surface (Beck, 1929).

Another possible means for the dissipation of petroleum deposits is the movement of underground water. Students of Rocky Moun-

tain geology (Krampert, 1934; Coffin and DeFord, 1934) have sought to explain the absence of commercial deposits of oil in certain structures otherwise favorable as due to the flushing action of circulating water.

Even though visible evidences of the escape of petroleum from underground reservoirs may not be detected, evidence is accumulating that petroleum and petroleum gases penetrate the overlying strata and eventually reach the surface in minute quantities. Such microseepages may be revealed by precise chemical analysis of soils and subsoils, and the results of such analyses support the belief that in some degree all oil deposits are subject to continuing dispersion (McDermott, 1940.)

#### DYNAMICS OF PETROLEUM

Petroleum and natural gas, as they occur in the earth, are confined under pressure. Their geologic history is one of motion, and in their movement they obey laws of physics related to the flow of liquids and gases (Muskat, 1937). From the beginning of the oil industry it was observed that, when oil and gas sands were penetrated, the fluids which they contain were under pressure, the amount of which increased normally with depth. This was at first attributed to the weight of the overlying rocks and was called "rock pressure." Lesley (1885) showed, however, that the pressure of the oil and gas in the reservoir was approximately equivalent to the artesian head for the corresponding depth, and much less than the pressure which would correspond to the weight of the overburden. Nevertheless, the industry continued to use the term "rock pressure," and it was not until many years later that pressure under which fluids are confined in underground reservoirs was termed "reservoir pressure" (Heroy, 1928). Reservoirs which occur in artesian basins and are controlled by hydrostatic head form one group, while those in which the porous bed does not reach the surface and consequently is not directly influenced by artesian conditions form another group.

The outstanding example of a large oil field under artesian control is East Texas, in which the reservoir bed is the Woodbine sand. This formation outcrops in east-central Texas and, after passing under the East Texas syncline, is truncated along the west side of the Sabine uplift to form a stratigraphic trap. The original reservoir pressure in this field was 1,620 pounds at 3,300 feet below sea level, which closely approximates the calculated hydrostatic pressure. It is probable that the sand is continuously porous from the outcrop to the field and that the fluids in it are governed by a common pressure system (Millikan, 1932, p. 902).

Meinzer (1936) has pointed out that, in coastal plain areas, porous horizons may have a submarine outcrop and that there may be artesian

balance between the portion submerged under salt water in the continental shelf and the portion lying under the land. His reasoning may be extended to coastal plain beds which have no surface outcrops because of overlap or up-dip pinching, but which may have a submarine outcrop at the edge of the shelf. An explanation is thus afforded of the normal reservoir pressures noted in coastal plain oil fields (Cannon and Craze, 1938). Fluid relations in a large coastal plain field, Conroe, Tex., have been well described by Michaux and Buck (1936).

Reservoirs which are essentially sealed by surrounding rocks of low permeability may contain oil and gas under pressures which have no direct relation to the hydrostatic pressures corresponding to their depth. The oil and gas in such reservoirs may have pressures substantially in excess of the equivalent hydrostatic pressure and tending to approach the pressure corresponding to the weight of the overburden (Cannon and Craze, 1938). It has been noted that in some cases shallower reservoirs may have higher reservoir pressures than those in the same area at greater depths (Millikan, 1932). Reservoirs which are essentially lenticular in form and isolated from artesian conditions may be expected to contain oil and gas under a pressure determined primarily by the amount of gas which has migrated into the reservoir and, if the surrounding section were highly impervious, pressures approaching the weight of the overburden may be built up. Excess pressures in shallower strata may, however, in some cases be caused by supercharging from deeper horizons as a result of upward migration of oil and gas along zones of fracture or faulting. Unfortunately geologists, on the whole, have given scant attention to this phase of petroleum geology, leaving this interesting field mostly to petroleum engineers.

#### CONCLUSION

The natural history of petroleum, from genesis to dispersion, is cyclical. In some regions where petroleum deposits occur, only a single cycle is represented, while in others several cycles, either partial or complete, may have occurred. In the preceding pages the writer has described in sequence the phases which form a complete cycle and the character of each. While each phase has been the objective of much scientific investigation, there is great variation in the quality and completeness of the results attained. This is partly inherent in the nature of the problems themselves. Science, however advanced, is as yet not adequately implemented to investigate some of them, and the progress in the solution of others may be ascribed to the immediate importance of the results; economic considerations frequently determine the amount and thoroughness of research.

Although petroleum geologists are conscious of the inadequacy of their present information as to many details of the petroleum cycle,

they have a feeling of pride that so much has been definitely established. The basic principles announced a half century ago have been tested, evaluated, and amplified; the work of the fathers was so well done that little has been discarded. New and more precise laboratory and field methods have made possible many studies which could not have been carried to success even two decades ago. Such a compilation as the present paper would not be possible without the existence of a wealth of data which have resulted from an immense amount of investigation.

This work still flourishes. Each unsolved problem challenges the attention of a new generation of investigators with fresh minds and new techniques. Large industrial and educational units are facilitating research on a scale far beyond the capacity of the individual worker. It may be expected, therefore, that the rate at which our knowledge of petroleum geology has advanced will be accelerated during the coming years. The writer who, 50 years hence, may be called upon to review the progress of a century of petroleum geology will find that many of the baffling uncertainties of our time will have been cleared away; many of the generalities and qualifications that characterize this paper will be replaced by more specific knowledge. Thrice armed though they may be, he and his contemporaries will still find in petroleum geology problems worthy of their steel.

#### WORKS TO WHICH REFERENCE IS MADE

In the following list are included the publications referred to in this paper. While it comprises only a small part of the literature on petroleum geology, reference has been made to the more important publications in which the principles of petroleum geology are discussed. It will therefore to some extent serve as a guide to those who may be interested in more detailed consideration of this subject.

##### ADAMS, JOHN EMEBY.

1934. Origin, migration and accumulation of petroleum in limestone reservoirs in the western United States and Canada, *in* Problems of petroleum geology. Amer. Assoc. Petrol. Geol., Sidney Powers Mem. vol., pp. 347-363.

##### ASHBURNER, CHARLES A.

1885. The geology of natural gas. *Science*, vol. 6, pp. 42-43.

##### ATHY, L. F.

- 1930a. Density, porosity, and compaction of sedimentary rocks. Amer. Assoc. Petrol. Geol., *Bull.*, vol. 14, No. 1, pp. 1-24.  
 1930b. Compaction and oil migration. Amer. Assoc. Petrol. Geol., *Bull.*, vol. 14, No. 1, pp. 25-35.

##### ATWILL, E. R.

1940. Significant developments in California, 1939. Amer. Assoc. Petrol. Geol., *Bull.*, vol. 24, No. 6, pp. 1112-1125, fig. 3.

##### BARTON, DONALD C.

1934. Natural history of the Gulf Coast crude oil, *in* Problems of petroleum geology. Amer. Assoc. Petrol. Geol., Sidney Powers Mem. vol., pp. 109-155.

- BARTON, DONALD C., RITZ, C. H., and HICKEY, MAUDE.  
1933. Gulf Coast geosyncline. Amer. Assoc. Petrol. Geol., Bull., vol. 17, No. 12, pp. 1446-1458.
- BARTON, DONALD C., and SAWTELLE, GEORGE (editors).  
1936. Gulf Coast oil fields. Amer. Assoc. Petrol. Geol.
- BECK, ELFRED.  
1929. Salt Creek oil field, Natrona County, Wyo., in *Structure of typical American oil fields*, vol. 2, pp. 589-603. Amer. Assoc. Petrol. Geol.
- BERL, E.  
1938. The origin of petroleum. Petrol. Techn., vol. 1, No. 2, Techn. Publ. No. 920, pp. 1-18.
- BILLINGSLEY, J. E.  
1934. Occurrence of oil and gas in West Virginia, eastern Ohio, and eastern Kentucky, in *Problems of petroleum geology*. Amer. Assoc. Petrol. Geol., Sidney Powers Mem. vol., pp. 485-514.
- BROOKS, BENJAMIN T.  
1936. Origins of petroleum: chemical and geochemical aspects. Amer. Assoc. Petrol. Geol., Bull., vol. 20, No. 3, pp. 280-301.  
1938. The chemical and geochemical aspects of the origin of petroleum, in *The science of petroleum*, pp. 47-53. Oxford Univ. Press.
- BUCHER, WALTER H.  
1933. The deformation of the earth's crust. 518 pp. Princeton Univ. Press.
- CANNON, G. E., and CRAZE, R. C.  
1938. Excessive pressures and pressure variations with depth of petroleum reservoirs in the Gulf Coast region of Texas and Louisiana. Amer. Inst. Min. Metall. Eng., Trans., vol. 127, pp. 31-38.
- CARL, JOHN F.  
1880. The geology of the oil regions of Warren, Venango, Clarion, and Butler Counties. Second Pennsylvania Geol. Surv., vol. 13, p. 482.
- CARMAN, J. ERNEST, and STOUT, WILBER.  
1934. Relationship of accumulation of oil to structure and porosity in the Lima-Indiana field, in *Problems of petroleum geology*. Amer. Assoc. Petrol. Geol., Sidney Powers Mem. vol., pp. 521-529.
- CHANCE, H. M.  
1887. The anticlinal theory of natural gas. Amer. Inst. Min. Metall. Eng., Trans., vol. 15, pp. 3-13.
- CHENEY, M. G.  
1940. Geology of north-central Texas. Amer. Assoc. Petrol. Geol., Bull., vol. 24, No. 1, pp. 65-118.
- CIZANCOURT, HENRY DE.  
1931. Geology of oil fields of Polish Carpathian Mountains. Amer. Assoc. Petrol. Geol., Bull., vol. 15, No. 1, pp. 1-42.
- CLAPP, FREDERICK G.  
1929. Role of geologic structure in the accumulation of petroleum, in *Structure of typical American oil fields*, vol. 2, pp. 667-716. Amer. Assoc. Petrol. Geol.
- CLARK, FRANK R.  
1934. Origin and accumulation of oil, in *Problems of petroleum geology*. Amer. Assoc. Petrol. Geol., Sidney Powers Mem. vol., pp. 309-335.
- COFFIN, R. CLARE, and DEFORD, RONALD K.  
1934. Waters of the oil- and gas-bearing formations of the Rocky Mountains, in *Problems of petroleum geology*. Amer. Assoc. Petrol. Geol., Sidney Powers Mem. vol., pp. 927-952.

COLLINGWOOD, D. M., and RETTGER, R. E.

1926. Lytton Springs oil field, Caldwell County, Tex. Amer. Assoc. Petrol. Geol., Bull., vol. 10, No. 10, pp. 953-975.

COOMBER, S. E.

1938. Distribution of petroleum: Poland, *in* The science of petroleum, pp. 177-183. Oxford Univ. Press.

DANA, JAMES D.

1871. Manual of geology, rev. ed., appendix L, pp. 756-757.

DEGOLYER, E.

1932. Oil associated with igneous rocks in Mexico. Amer. Assoc. Petrol. Geol., Bull., vol. 16, No. 8, pp. 799-808.

DENISON, A. R., OLDHAM, A. E., and KISLING, J. W., JR.

1933. Structure and stratigraphy of Kelsey anticline, Upshur County, Tex. Amer. Assoc. Petrol. Geol., Bull., vol. 17, No. 6, pp. 656-679.

FETTKE, CHARLES R.

1938. The Bradford oil field, Pennsylvania and New York. Pennsylvania Geol. Surv., ser. 4, Bull. M 21, p. 454.

GRISWOLD, W. T., and MUNN, M. J.

1907. Geology of the oil and gas fields in Steubenville, Burgettstown, and Claysville quadrangles, Ohio, West Virginia, and Pennsylvania. U. S. Geol. Surv. Bull. 318, pp. 1-196.

HACKFORD, J. E.

1932. The chemistry of the conversion of algae into bitumen and petroleum and of the fucosite-petroleum cycle. Journ. Inst. Petrol. Techn., vol. 18, pp. 74-123.

HAKE, B. F.

1938. Geologic occurrence of oil and gas in Michigan. Amer. Assoc. Petrol. Geol., Bull., vol. 22, No. 4, pp. 393-415.

HAMMAR, HAROLD E.

1934. Relation of microorganisms to generation of petroleum, *in* Problems of petroleum geology. Amer. Assoc. Petrol. Geol., Sidney Powers Mem. vol., pp. 35-49.

HEATH, DAISY WINIFRED.

1937. Comprehensive index to the publications of The American Association of Petroleum Geologists. 382 pp. Tulsa.

HEROLD, STANLEY C.

1938. Criteria for determining the time of accumulation under special circumstances. Amer. Assoc. Petrol. Geol., Bull., vol. 22, No. 7, pp. 834-851.

HEROY, WILLIAM B.

1928. Rock pressure. Amer. Assoc. Petrol. Geol., Bull., vol. 12, No. 4, pp. 355-384.

HLAUSCHKE, H.

1936. Naphthen- und Methanöle, ihre geologische Verbreitung und Entstehung. Schrift. Gebiet der Brennstoff-Geologie, vol. 2. Stuttgart.

HOBSON, G. D.

1938. Distribution of petroleum: U. S. S. R., *in* The science of petroleum, pp. 155-166. Oxford Univ. Press.

HOWARD, W. V.

1928. A classification of limestone reservoirs. Amer. Assoc. Petrol. Geol., Bull., vol. 12, No. 12, pp. 1153-1161.

HUNT, T. STERRY.

1861. Notes on the history of petroleum or rock-oil. Canadian Nat., vol. 6, pp. 241-255.

## ILLING, V. C.

1933. The migration of oil and natural gas. *Journ. Inst. Petrol. Techn.*, vol. 19, pp. 229-260.
- 1938a. Distribution of petroleum: Eastern Venezuela and Trinidad, *in* *The science of petroleum*, pp. 106-110. Oxford Univ. Press.
- 1938b. The migration of oil, *in* *The science of petroleum*, pp. 209-215. Oxford Univ. Press.

## KRAMPERT, E. W.

1934. Geological characteristics of producing oil and gas fields in Wyoming, Colorado, and northwestern New Mexico, *in* *Problems of petroleum geology*. Amer. Assoc. Petrol. Geol., Sidney Powers Mem. vol., pp. 719-733.

## LAHEE, FREDERIC H.

1929. Oil and gas fields of the Mexia and Tehuacan fault zones, Texas, *in* *Structure of typical American oil fields*, vol. 1, pp. 304-388. Amer. Assoc. Petrol. Geol.

## LEES, G. M.

1933. Reservoir rocks of Persian oil fields. *Amer. Assoc. Petrol. Geol., Bull.*, vol. 17, No. 3, pp. 229-240.
1938. The geology of the oil field belt of Iran and Iraq, *in* *The science of petroleum*, pp. 140-148. Oxford Univ. Press.

## LESLEY, J. P.

1885. Some general considerations of the pressure, quantity, composition and fuel-value of rock-gas or the natural gas of oil regions of Pennsylvania. *Ann. Rep. Pennsylvania Geol. Surv.* 1885, pp. 657-680.
1886. The geology of the Pittsburgh coal-region. *Amer. Inst. Min. Metall. Eng., Trans.*, vol. 14, pp. 618-674.

## LEVORSEN, A. I.

1929. Greater Seminole district, Seminole and Pottawatomie Counties, Oklahoma, *in* *Structure of typical American oil fields*, vol. 2, pp. 315-361. Amer. Assoc. Petrol. Geol.
1935. Time of oil migration and accumulation (abstract). *Oil Weekly*, vol. 79, No. 10, p. 16.
1936. Stratigraphic versus structural accumulation. *Amer. Assoc. Petrol. Geol., Bull.*, vol. 20, No. 5, pp. 521-530.

## LEWIS, J. WHITNEY.

1932. Occurrence of oil in igneous rocks of Cuba. *Amer. Assoc. Petrol. Geol., Bull.*, vol. 16, No. 8, pp. 809-818.

## LINK, THEODORE, and MOORE, P. D.

1934. Structure of Turner Valley oil and gas field, Alberta. *Amer. Assoc. Petrol. Geol., Bull.*, vol. 18, No. 11, pp. 1417-1453.

## LYELL, SIR CHARLES.

1842. *Principles of geology: or, the modern changes of the earth and its inhabitants, considered as illustrative of geology*. Hilliard, Gray & Co., Boston.

## MCCOY, ALEX W.

1926. A brief outline of some oil accumulation problems. *Amer. Assoc. Petrol. Geol., Bull.*, vol. 10, No. 11, pp. 1015-1034.

## MCCOY, ALEX W., and KEYTE, W. ROSS.

1934. Present interpretations of the structural theory of oil and gas migration and accumulation, *in* *Problems of petroleum geology*. Amer. Assoc. Petrol. Geol., Sidney Powers Mem. vol., pp. 253-307.

## McDERMOTT, EUGENE

1940. Geochemical exploration (soil analysis). Amer. Assoc. Petrol. Geol., Bull., vol. 24, No. 5, pp. 859-881.

## McGEE, D. A., and CLAWSON, W. W., JR.

1932. Geology and development of Oklahoma City field, Oklahoma. Amer. Assoc. Petrol. Geol., Bull., vol. 16, No. 10, pp. 957-1020.

## McGEE, W. J.

1890. Geol. Soc. Amer., Bull., vol. 1, p. 97.

## MEINZER, O. E.

1936. Movements of ground water. Amer. Assoc. Petrol. Geol., Bull., vol. 20, No. 6, pp. 704-725.

## MICHAUX, FRANK W., JR., and BUCK, E. O.

1936. Conroe oil field, Montgomery County, Tex. Amer. Assoc. Petrol. Geol., Bull., vol. 20, No. 6, pp. 736-779.

## MILLIKAN, C. V.

1932. Geological application of bottom hole pressures. Amer. Assoc. Petrol. Geol., Bull., vol. 16, No. 9, pp. 891-906.

## MINOR, H. E., and HANNA, MARCUS A.

1933. East Texas oil field. Amer. Assoc. Petrol. Geol., Bull., vol. 17, No. 7, pp. 757-792.

## MUIR, JOHN M.

1934. Limestone reservoir rocks in the Mexican oil fields, in Problems of petroleum geology. Amer. Assoc. Petrol. Geol., Sidney Powers Mem. vol., pp. 377-398.

## MUNN, MALCOLM J.

1909. The anticlinal and hydraulic theories of oil and gas accumulation. Econ. Geol., vol. 4, pp. 509-529.

## MUSKAT, M.

1937. The flow of homogeneous fluids through porous media. 763 pp. McGraw-Hill Book Co.

## ORTON, EDWARD.

1888. The origin and accumulation of petroleum and natural gas. Rep. Geol. Surv. Ohio, vol. 6, chap. 2, pp. 60-100.

1890. Origin of the rock pressure of natural gas in the Trenton limestone of Ohio and Indiana. Geol. Soc. Amer., Bull., vol. 1, pp. 87-94.

## PACK, R. W.

1920. The Sunset-Midway oil field, California. U. S. Geol. Surv., Prof. Pap. 116, pt. 1, pp. 1-179.

## PECKHAM, STEPHEN F.

1884. Report on the production, technology, and uses of petroleum and its products. U. S. 10th Census Rep., vol. 10, 319 pp.

## PRATT, WALLACE E.

1934. Hydrogenation and the origin of oil, in Problems of petroleum geology. Amer. Assoc. Petrol. Geol., Sidney Powers Mem. vol., pp. 235-245.

## RICH, JOHN L.

1923. Further notes on the hydraulic theory of oil migration and accumulation. Amer. Assoc. Petrol. Geol., Bull., vol. 7, No. 3, pp. 213-225.

1931. Function of carrier beds in long-distance migration of oil. Amer. Assoc. Petrol. Geol., Bull., vol. 15, No. 8, pp. 911-922.

1938. Shorelines and lenticular sands as factors in oil accumulations, in The science of petroleum, pp. 230-239. Oxford Univ. Press.



ROGERS, H. D.

1860. On the distribution and probable origin of the petroleum or rock-oil of western Pennsylvania, New York, and Ohio. *Proc. Philos. Soc. Glasgow*, vol. 4, pp. 335-359.

SANDERS, J. McCONNELL.

1937. The microscopical examination of crude petroleum. *Journ. Inst. Petrol. Techn.*, vol. 23, pp. 525-572.

SANDS, J. MELVILLE.

1927. Burbank field, Osage County, Okla. *Amer. Assoc. Petrol. Geol., Bull.*, vol. 11, No. 11, pp. 1045-1054.

SCHILTHUIS, RALPH J.

1937. Connate water in oil and gas sands. *Amer. Inst. Min. Metall. Eng., Trans.*, vol. 127, pp. 199-225.

SELLARDS, E. H.

1932. Oil fields in igneous rocks in coastal plain of Texas. *Amer. Assoc. Petrol. Geol., Bull.*, vol. 16, No. 8, pp. 741-768.

SNIDER, L. C.

1934. Current ideas regarding source beds, *in* Problems of petroleum geology. *Amer. Assoc. Petrol. Geol., Sidney Powers Mem. vol.*, pp. 51-66.

SPIEKER, E. M.

1931. The Wasatch plateau coal field, Utah. *U. S. Geol. Surv. Bull.* 819, p. 16.

STOUT, WILBER.

1936. Source material for petroleum and natural gas. *Amer. Assoc. Petrol. Geol., Bull.*, vol. 20, No. 6, pp. 797-804.

THOM, W. T., JR., and SPIEKER, EDMUND M.

1931. The significance of geologic conditions in Naval Petroleum Reserve No. 3, Wyoming. *U. S. Geol. Surv. Prof. Pap.* 163.

TORBREY, PAUL D.

1934. Origin, migration, and accumulation of petroleum and natural gas in Pennsylvania, *in* Problems of petroleum geology. *Amer. Assoc. Petrol. Geol., Sidney Powers Mem. vol.*, pp. 447-484.

TRASK, PARKER D.

1932. Origin and environment of source sediments of petroleum. 323 pp. Gulf Publishing Co., Houston.
1938. One way of finding oil more cheaply. *Drilling and Production Practice*, 1937, pp. 382-398. *Amer. Petrol. Inst.*

TRASK, PARKER D., and WU, C. C.

1930. Does petroleum form in sediments at time of deposition? *Amer. Assoc. Petrol. Geol., Bull.*, vol. 14, No. 11, pp. 1451-1463.

TRIEBS, A.

- 1934-1935. Chlorophyll- und Häminderivate in bituminösen Gesteinen, Erdoel, Erdwachsen und Asphalten. *Ann. Chem.*, vol. 510, p. 42; vol. 517, p. 172.

TWENHOFEL, WILLIAM H.

1932. *Treatise on sedimentation*. 2d ed., 926 pp. The Williams and Wilkins Co., Baltimore.
1939. Environments and origin of black shales. *Amer. Assoc. Petrol. Geol., Bull.*, vol. 23, No. 8, pp. 1178-1198.

UDDEN, JOHAN A., and BYBEE, H. P.

1916. The Thrall oil field. *Univ. Texas Bull.* 66.

## VERSLUYS, JAN.

1932. Factors involved in segregation of oil and gas from subterranean water. *Amer. Assoc. Petrol. Geol., Bull.*, vol. 16, No. 9, pp. 924-942.

## WHITE, DAVID.

1935. Metamorphism of organic sediments and derived oils. *Amer. Assoc. Petrol. Geol., Bull.*, vol. 19, No. 5, pp. 589-617.

## WHITE, I. C.

- 1885a. The geology of natural gas. *Science*, vol. 5, pp. 521-522.  
 1885b. Reply to Ashburner. *Science*, vol. 6, pp. 43-44.  
 1886. The geology of natural gas. *Petroleum Age*, vol. 5, pp. 1263-1267, 1464-1465.  
 1892. The Mannington oil field and the history of its development. *Geol. Soc. Amer., Bull.*, vol. 3, pp. 187-216.

## WILSON, W. B.

1927. Geology of Glenn pool of Oklahoma. *Amer. Assoc. Petrol. Geol., Bull.*, vol. 11, No. 10, pp. 1055-1065.  
 1934. Proposed classification of oil and gas reservoirs, *in* Problems of petroleum geology. *Amer. Assoc. Petrol. Geol., Sidney Powers Mem.* vol., pp. 433-445.

## WOOLNOUGH, W. G.

1937. Sedimentation in barred basins and source rocks of oil. *Amer. Assoc. Petrol. Geol., Bull.*, vol. 21, No. 9, pp. 1101-1157.

# THE 1942 ERUPTION OF MAUNA LOA, HAWAII<sup>1</sup>

---

By GORDON A. MACDONALD

*Geological Survey, U. S. Department of the Interior  
Honolulu, T. H.*

---

[With 2 plates]

## INTRODUCTION

Mauna Loa volcano, on the island of Hawaii, is probably the largest and most active volcano in the world. It rises to a height of 13,680 feet above sea level, and some 30,000 feet above the surrounding ocean floor. On the north and northwest its great lava shield abuts against the dormant or extinct volcanoes of Mauna Kea and Hualalai, and on its southeastern slope rests the smaller, younger shield of Kilauea volcano (fig. 1).

Mauna Loa is a broad, basaltic shield volcano transected by three great series of fractures, known as rift zones, which intersect at the summit in the caldera of Mokuaweoweo. Along them have taken place most of the innumerable eruptions which built up the mountain. One rift zone extends from the summit southwestward to the southern point of the island. Another extends northeastward toward the city of Hilo, and a third, less prominent one trends northwestward toward Hualalai volcano. The rift zones are marked on the surface by many cinder cones, spatter cones, pit craters, and open fissures.

Throughout recorded history, Mauna Loa has erupted on an average of once every 3.6 years, but the frequency of eruption may actually be somewhat greater owing to the possibility of small summit eruptions having escaped notice during the earlier part of the period of occupation of the island by white men. During the 110 years since the first recorded eruption, in June 1832, Mauna Loa has been in activity approximately 2,527 days, or 6.3 percent of the time. Flank eruptions occupied about 3.3 percent of the total elapsed time, and eruptions in and near the summit caldera occupied 3 percent of the time.

---

<sup>1</sup> Published by permission of the Director, Geological Survey, U. S. Department of the Interior. Reprinted by permission from the *American Journal of Science*, vol. 241, No. 4, April 1943.

The latest period of activity of Mauna Loa commenced on April 26, 1942. A fissure opened across the caldera and a short way down the northeastern slope, and lava fountains played along it. Two days later the principal eruption began along a fissure in the northeast rift zone, at an altitude of 9,200 feet. Activity continued until May 10, 1942. The last preceding activity had been in 1940, when

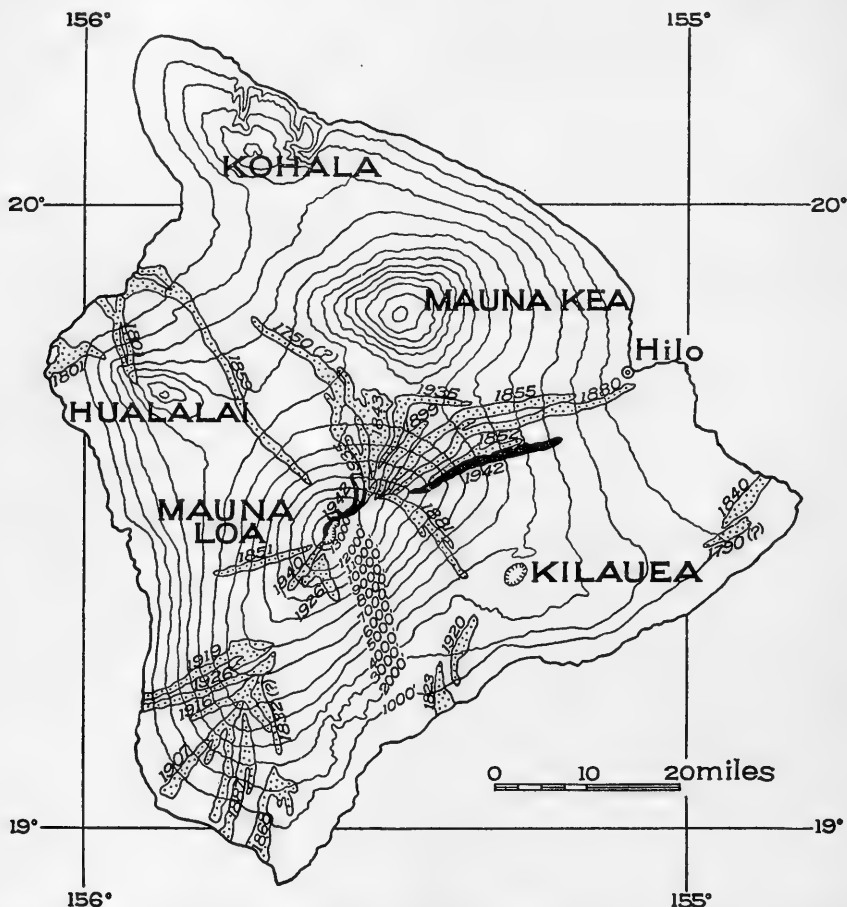

FIGURE 1.—Outline map of the island of Hawaii, showing the location of the 1942 lava flow (solid black), and other historic flows of Mauna Loa and Kilauea.

lava fountains played in the summit caldera with gradually abating strength from April 7 until August.

The following account of the eruption of 1942 is based partly on personal observation and partly on data gathered from other observers. The activity at the vent at 9,200 feet was watched at close range throughout its duration by a succession of witnesses, but the early summit activity was seen only from a distance. Most of the

observations used, other than those of the writer, were made by the personnel of the Hawaiian Volcano Observatory and Hawaii National Park, and the writer wishes to thank all those who contributed information for their generous cooperation. Special thanks are due Lt. P. E. Schulz for his description of the front of the flow. R. H. Finch, Director of the Hawaiian Volcano Observatory, H. T. Stearns of the U. S. Geological Survey, and C. K. Wentworth of the Honolulu Board of Water Supply, have kindly read and criticized the manuscript. James Y. Nitta prepared the illustrations.

#### PREDICTION OF THE ERUPTION

The 1942 eruption of Mauna Loa was predicted by R. H. Finch several months in advance, on the basis of seismic activity, coupled with the known periodicity of the volcano. On February 8, 1942, a strong earthquake occurred on the line of the northeast rift zone near Hilo, at a depth of 27 miles.<sup>2</sup> This was followed by a series of quakes which migrated up the northeast rift, across the summit, and a short way down the southwest rift, then returned across the summit and settled in the northeast rift. The seismic activity will be described in detail by Finch in another paper.

In memoranda for the Superintendent of Hawaii National Park, dated March 1 and 5, 1942, later published in the local newspapers, Finch called attention to the growing uneasiness of Mauna Loa, indicated both by earthquakes and the accumulation of easterly tilt at the Volcano Observatory. Easterly tilt has long been known to indicate tumescence of Mauna Loa accompanying the rise of magma pressure preceding eruption. In a memorandum dated April 10 he wrote, "The progressive splitting of the northeast-southwest rift of Mauna Loa that was pronounced in February continued in March \* \* \* If Mauna Loa erupts within the next several months, as seems probable, the indications point to a flank eruption from the northeast rift."<sup>3</sup> Although military considerations forbade release of the prediction, its value as a contribution to practical volcanology remains unimpaired.

#### DESCRIPTION OF THE ERUPTION

##### EARLY SUMMIT ACTIVITY

The eruption commenced on the evening of April 26, 1942, with activity along a fissure that opened part way up the cliffs on the western side of Mokuaweoweo caldera and across the smaller pit crater,

<sup>2</sup> Finch, R. H., personal communication.

<sup>3</sup> Finch, R. H., Memorandum to the Superintendent of Hawaii National Park, April 10, 1942.

known as North Bay, which adjoins Mokuaweoweo on the north. It was first reported by observers about 6 p. m., but the seismograph record shows that it actually commenced at 5:05 p. m.<sup>4</sup> Lava fountains played along the fissure, building up small ramparts of spatter, and streams of molten pahoehoe<sup>5</sup> cascaded down the caldera walls forming a lava flow along the base of the western wall and around the west and north edges of North Bay. Shortly afterward the fissure was extended on down the northeastern flank of the mountain for a distance of 2½ miles, passing close to the south edge of the main cone of the 1935 eruption. Highly fluid lava issued from the fissure along its entire length. Small spatter ramparts were built in places, but in general there was little accumulation of spatter along the fissure. Much of the early lava was covered with a pumiceous top, half an inch to over an inch thick, owing to the extreme vesiculation of the gas-rich magma. The lava flow streamed northward down the mountain slope toward Mauna Kea for several miles, dividing into two major lobes. Pahoehoe near the source gave place to aa<sup>6</sup> at the lower ends of the flow. On the night of April 26 the fume column, illuminated by glow from the fountains beneath, was clearly visible from Kilauea, rising nearly vertically to an altitude of about 15,000 feet and then drifting southwestward.

At 2 a. m., April 27, G. O. Fagerlund and B. J. Loucks, of Hawaii National Park, began the ascent of the mountain. The ground was quaking continually, averaging three or four distinct shocks a minute. On reaching the rest house at Puu Ulaula, at an altitude of 10,000 feet, the shocks appeared to originate directly beneath their feet, and a crude heavy pendulum set up by Loucks showed almost no horizontal displacement. They therefore decided to remain at Puu Ulaula instead of continuing to the summit, as had been planned, and as a result they had the rare privilege of witnessing at close range the opening phases of the flank eruption.

#### FLANK ERUPTION

*Opening phase.*—At 4:40 a. m., April 28, molten lava broke out along a fissure in the northeast rift zone about 1½ miles east-northeast of Puu Ulaula (fig. 1). Fagerlund and Loucks reached the site of the eruption at 7:30 a. m. At that time a nearly continuous sheet of lava fountains was issuing from a fissure over half a mile in length, forming the "curtain of fire" frequently observed during the opening stages of Mauna Loa eruptions. The fissure extended from an altitude of about 9,500 to 9,200 feet, with a trend of N. 85° E. The fountains played to heights of 200 to 300 feet above the ground.

<sup>4</sup> Finch, R. H., personal communication.

<sup>5</sup> Pahoehoe=lava that congeals in smooth, sometimes ropy forms.

<sup>6</sup> Aa=lava with a rough, clinkery top.

During the day the fissure gradually lengthened down slope, its course changing to N. 70° E., and by 3 p. m. the total length of the erupting fissure was about a mile. Fountains were active along both its upper and lower ends. Along its middle part lava welled forth copiously, forming a lava river which followed the course of the fissure. Along this portion of the fissure fountaining was much less prominent than elsewhere, but occasional bursts of fountain activity through the river suggested that the paucity of fountain activity resulted from drowning of the fountains by the lava river. Thin flows of very gas-rich pahoehoe were poured out on both sides of the rift and flowed downhill alongside it, changing to aa half a mile below the bend in the fissure. Fountain activity reached a maximum at 8 p. m. on April 28, the fountains attaining a height of 500 feet, or a little more.

The fissure along which the lava broke out extended up the mountain probably to the summit, and although no lava issued in the zone between 10,000 and 12,000 feet, fume was observed at several localities. Fume was also noted at the source cone of the 1935 eruption. Lava extrusion at the summit decreased greatly on the 27th and appeared to have stopped when the flank eruption began. Fissuring was later found by R. H. Finch also to extend well down slope from the locus of the eruption. Several observers reported seeing new lava fountains on the northeast rift near the summit late in the afternoon of May 1, but this reported eruption was probably merely the effect of sunset colors on a fume cloud, as it was not visible after dark. Moreover, it appears unlikely that once the activity had broken out at 9,200 feet altitude, it would migrate back up the fissure and break out anew at or above 12,000 feet.

Shortly after the outbreak at 9,200 feet altitude, lava issued at another locality 3 miles farther down slope, at an altitude of 7,800 feet. This lower locality had none of the characteristics habitually exhibited by true vents on Mauna Loa. The lava issued relatively quietly from beneath the toe of an older aa flow which overlies a still older brown pahoehoe. Fume was liberated in much less volume than at the vent at 9,200 feet, and no lava fountains appear to have been present. Only a very small amount of dense spatter was formed, and the lava was denser and much poorer in gas than that at the higher sources. Steam issued from arcuate fissures which lay at approximately right angles to the flow and to the rift zone just above the point at which the lava issued.<sup>7</sup> No traces of fracturing parallel to the rift zone could be found. This lower outbreak probably represents lava draining through an older pahoehoe tube which intersected the eruption fissure at some point higher up the mountain.

---

<sup>7</sup> An excellent aerial photograph of the lower source, showing these features, has been published in *Life*, vol. 12, No. 22, p. 36, June 1, 1942.

After attaining its maximum length and strength on the evening of April 28, the fountain activity at the vent at 9,200 feet gradually became restricted to the central part of the fissure, building up a chain of cinder and spatter cones 1,000 feet long. The restriction of the fountains marked the end of the opening phase of the flank eruption. This opening phase was characterized by the "curtain of fire" extending nearly uninterrupted along a fissure over a mile in length, and by the copious outwelling of lava along the fissure with the building of low ramparts of spatter but no true cones.

*Middle phase.*—The middle phase of the flank eruption was characterized by lava fountains restricted to the central part of the fissure. It was a phase of cone building.

H. T. Stearns and the writer reached the lava fountains late in the afternoon of May 2. For 1,500 feet at its western end activity along the fissure was confined to the liberation of fume, although the walls in places were still red hot. At night pale blue flames, having the color of hydrogen flames, were seen at two places rising 6 or 8 feet above the ground. The lava fountains during the early phase of the eruption had built a rampart of spatter cones 10 to 20 feet high. In many places the spatter cones had bridged the fissure, and it was possible to cross to the other side. Several of the cones were partly coated with thin deposits of sulfur. The fume along the upper part of the fissure was largely steam, but the odor of boric acid was detected in several places.

Lava fountains were still vigorously active for a distance of 1,000 feet along the fissure, and had built up a chain of spatter and cinder cones to an average height of 75 feet (fig. 2). The westernmost of these cones had exceptionally steep sides, and enclosed a vent from which there was no true fountaining, but which liberated great rolling clouds of fume (pl. 1, fig. 1). Occasional violent gas explosions at this vent hurled blocks of pumice high in the air. At other times periods of strombolian activity of a few minutes duration occurred, during which there were ejected ribbon- and spindle-shaped bombs which cooled during flight and struck the cone in a solid condition, to roll clattering down its sides. The most copious ejections of pumice were of several minutes duration, and were accompanied by a roaring sound of escaping gas. Blocks of pumice, of a pale tan color, some of them as much as 8 or 10 inches across, were projected to heights estimated at 1,000 to 2,000 feet. The larger blocks shattered on striking the ground. Smaller pumice fragments pattered down like rain on the hat brims of the observers.

The rest of the cone chain was in typical Hawaiian activity. Lava fountains played to heights of 100 to 400 feet above the cones. At night the color of the molten lava in the fountains varied from



orange to pale yellow, indicating temperatures in the vicinity of  $900^{\circ}$  to  $1050^{\circ}$  C. Irregular shreds of molten lava, many of them several feet across, were hurled into the air (pl. 1, fig. 2), accompanied by the constant evolution of large volumes of fume. The magma shreds gradually cooled during flight, and changed in color to red and then to purple, and many of them to black before they struck the ground. Most fell back into the vents, but occasionally showers of ejecta struck the outer slopes of the cones in splashes of fiery red liquid. The fume cloud ranged in color from white to bluish-gray and pale reddish-brown, the latter color being predominant. The cloud smelled strongly of sulfur dioxide. The ground in the vicinity of the vents

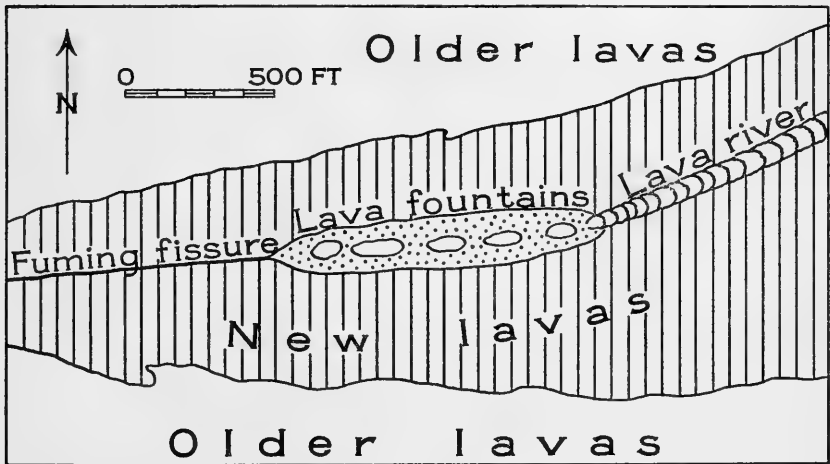

FIGURE 2.—Geologic sketch map of the vent area at 9,200 feet altitude during the eruption of Mauna Loa, on May 2, 1942.

was constantly agitated, the tremor resembling that caused by the close passing of a heavy railroad train.

The pahoehoe flows extruded at the beginning of the eruption were cool enough to walk over, but too hot to sit on for more than a few minutes. Food was easily cooked over hot cracks in the lava, and glowing rock could be seen at depths of a few inches. The odor of boric acid was detected at several cracks in the lava, and the so-called foundry odor, resembling the smell of hot iron in a blacksmith shop, was constantly present. The lava was exceedingly frothy. Thin shells 2 or 3 inches thick covered cavities a few inches to 2 or 3 feet deep and several feet across. Many of these cavities were pahoehoe tubes, but others ended in lobes against the adjacent older lava with no possible means of escape for any enclosed liquid. The latter cavities are probably the result of inflation by expanding gases in the highly gas-rich, fluid pahoehoe.

At the lower end of the cone chain there issued a lava river 50 feet wide which flowed seaward through an open channel along the course of the eruption fissure. The speed of the fastest-moving central part was estimated to be 15 to 20 miles an hour. This speed is comparable to that of 25 miles per hour determined by stop-watch observations by M. H. Carson during the 1926 eruption,<sup>8</sup> and 7 to 19 miles per hour by C. K. Wentworth during the 1935 eruption.<sup>9</sup> Near the cones small fountains occasionally erupted through the lava river. It was impossible to approach close to the river on May 2, but on the 4th the writer crossed the eruption fissure and obtained an excellent view of the river from the north side near the lower end of the cone chain. Its surface undulated and bounded like that of a large river of water in flood. Broad standing waves, 3 or 4 feet in height, extended entirely across the river. Where it left the cone, its entire surface was one of orange-red molten lava, but crusts of gray, ropy pahoehoe started to form within 100 feet from the cone, and 200 yards downstream the river was completely crusted over. The crusts were repeatedly broken up and swept away, many fragments slowly tilting, elevating one edge above the river before sinking out of sight.

On the morning of May 4 the fountain activity had become largely restricted to a single central fountain, which played to an average height of 150 feet above the cone, with occasional bursts going as high as 500 feet. The cone had increased in height to about 100 feet. The vent at the western end of the cone chain, which had been in strombolian activity on May 2, had become a roaring gas vent with occasional violent explosions hurling ejecta 500 feet in the air with a noise like artillery fire. The fume at the fountains had greatly increased in volume, and smelled strongly of sulfur dioxide.

An epoch of frequent small lava flows which broke laterally from the cones probably commenced on May 2. Two such small flows of pahoehoe had already occurred, one on each side of the cone chain, previous to the afternoon of May 2. Both spilled over low places in the cone rim, and flowed only 100 feet or so beyond the foot of the cone. The one on the south side was probably erupted early on May 2, for it still showed many glowing apertures on the afternoon of that day. In the early morning of May 4, E. G. Wingate saw the southern wall of the western cone partly collapse, liberating a short flow of viscous, slow-moving pahoehoe. At about 8:45 p. m. of the same day F. B. Herman witnessed the break-down of part of the cone, which liberated very hot fluid flows that carried away a small section of the cone wall. These lava streams broke out on both sides of the cone chain. That on the northern side soon rejoined the main

<sup>8</sup> Carson, M. H., personal communication.

<sup>9</sup> Wentworth, C. K., unpublished memorandum, 1935.

lava river, but that on the southern side formed a new flow which advanced down the mountain for a distance of about 6 miles, and continued flowing until May 7.<sup>10</sup> The lowering of the lava level in the cone was accompanied by a temporary increase to about 600 feet in the height of the fountains, probably owing to the removal of part of the damping effect of the ponded lava on the gases rising through it. This new flow diverted a large volume of lava from the older flow, and was probably largely responsible for the cessation of movement at the front of the older flow which occurred on May 5 or 6.<sup>11</sup>

R. H. Finch visited the fountains on May 5 and 6, and reported that two flows were moving eastward from the cones. Both were pahoehoe for over half a mile from the source but changed to aa in less than a mile. At 7,000 feet altitude the new lava was in places 40 feet thick.

On the morning of May 7, Paul and Sarah Baldwin, of Hawaii National Park, witnessed the outbreak of two more small flows from the western cone, which had become the site of the principal fountain activity. The first flow broke from the south side of the cone at 6:30 a. m., and continued for less than half an hour, forming a short stream of aa. At 7 a. m. the second flow escaped through a wall of the cone on its southwestern side, and formed a short pahoehoe stream along the south base of the cone chain. This flow did not escape over the edge of the cone, but forced its way through the cone wall, appearing first as a slightly glowing bulge which slowly distended and developed into a stream of pahoehoe. These repeated short outflows heaped up a small lava dome about the edges of the cinder and spatter cone, burying the base of the cone to a depth of 30 feet.

*Declining phase.*—The cones were again visited by the writer on May 9. Activity had greatly decreased, and was restricted to two small fountains. The ejected lava was a deeper red than during the previous visit, indicating a decrease in temperature. The larger fountain occupied the western vent of the cone chain, and was in explosive activity, throwing lava clots 50 to 70 feet above the cone, but with no true jet of liquid lava visible. The smaller fountain occupied the next pit to the east, and was a true fountain 15 to 20 feet high, with frequent explosive bursts reaching a height of 50 feet. During the intervals between bursts, a jet of magma could be seen curving obliquely upward from one side of the pit and splashing down against the other side. A lava river 15 feet wide cascaded rapidly from this pit and flowed sluggishly off (pl. 2, fig. 1), at a rate of about half a mile an hour, forming a ropy crust in which the glowing lava beneath could be seen through the cracks. The lava

<sup>10</sup> Finch, R. H., press release, National Park Service, U. S. Dep. Interior, May 23, 1942.

<sup>11</sup> Finch, R. H., *op. cit.*

river flowed at the top of a long embankment 30 feet high, enclosed between levees built by its overflow. The lava repeatedly broke through the levees and sent short streams down the side of the embankment.

Several times fragments of the river bank crumbled away, tumbling large blocks of lava, as much as 10 feet across, into the river. These were rolled along, and wrapped up into ball-shaped masses by the moving lava.

About 200 yards below the vent the lava was mostly aa. The walls of the aa channel were 10 to 15 feet high, and composed of loose blocks of clinker. Between them the aa stream was moving very slowly, blocks occasionally tumbling down and revealing the glowing, pasty interior. Along the axis of the aa stream flowed a river of pahoehoe, and across the jagged top of the aa blocks borne on the lava river could be seen moving slowly by. Small flows of pahoehoe occasionally broke from the lower portions of the aa. In one of these, when stirred with a stick, the molten lava had the consistency of very viscous taffy.

On the morning of May 10, activity at the fountains was nearly at an end. The western vent showed moderate fuming and weak lava-ejection activity, throwing scattered shreds of red-hot lava 10 to 25 feet above the rim of the cone. The other fountain and the lava river no longer existed. The channel occupied by the river was empty, and about 12 feet deep. In places its walls had collapsed. The cones were still very hot. It was impossible to stand still on them for more than a few moments, and sticks thrust into glowing cracks were quickly ignited. On the morning of May 11 the cone area was completely dead, except for minor amounts of fume. On May 31, small amounts of white fume, probably largely steam, were still rising along the fissure.

#### LOWER PORTION OF THE LAVA FLOW

The lava river that escaped from the lower end of the cone chain flowed seaward, dividing and reuniting like a braided stream, and finally being joined by that from the lower source to form a single flow. The earlier lateral outpourings formed broad fields of aa along the edges of the flow, but the actively moving central portion remained pahoehoe for about 6 miles, finally changing to aa at an altitude of about 6,500 feet. During the first few days the advance of the flow front was rapid. At noon on May 1 it was reported to have reached a point 15 miles from the 9,200-foot source, and only 11 miles from the city of Hilo. If the advance continued at the same rate, it appeared likely that there might result serious damage to the Waiakea section of the city and possibly to Hilo harbor.

The front of the lava advanced into a region of dense jungle. The only trained scientific observer to reach the flow terminus while it was still in motion was Lt. P. E. Schulz, formerly assistant at the Hawaiian Volcano Observatory, who has kindly supplied the writer with an excellent description of the advancing lava. Mr. Schulz reached the lava flow on May 1. The jungle was extremely wet and swampy, and much rain water was standing or flowing on the surface of the ground. The flow was 20 to 25 feet thick, and was typical aa, with an exceedingly active front. Trees in the path of the flow were rapidly bowled over and burned. Contact of the lava with the water and wet vegetation resulted in large volumes of dense smoke and violent explosions which made impossible a close approach to the flow.

The explosions were frequent, and caused great billowing black clouds to rise 500 to 1,000 feet in the air, the color of the cloud changing after a minute or so to gray and then to white. Some of the explosions were probably caused by rapidly generated steam, but others were probably the result of combustion of hydrocarbon gases distilled from the inundated vegetation. The smell of marsh gas was distinct in the hollows near the lava. Explosion craters 10 feet or so across and a couple of feet deep were observed up to several hundred feet beyond the margin of the flow. These contained no new lava, nor any evidence of heating or alteration, and must have resulted from the migration of steam or explosive gases through lava tubes and other openings in the underlying older lava.

The lava advanced at a speed estimated as 300 to 500 feet an hour, and the flow was also spreading laterally, but at a much slower rate. The movement of the edges of the flow could be observed at much closer quarters than could that of the flow front. "The lateral advance was made by yellow-hot lava in small amount which oozed from the loose steep wall in a highly fluid condition. It was apparently of such low viscosity solely on the strength of its great heat. I was unable to detect any effervescence or other indication of escaping gas \* \* \*. After 2 or 3 seconds the fluid material very abruptly lost its high mobility and became friable, forming fragments that rolled down the steep, rough flank. During the next 4 or 5 seconds \* \* \* the fragments still remained soft enough so as not to make any appreciable sound, yet of such a consistency that the descending pieces fragmented as they bumped down the slope. Then the fragments cooled and hardened to the point that the characteristic clinking sound was made, and at this point the yellow-orange glow was gone, the fragments being quite red in color with grayed and darkened edges and projections."<sup>12</sup>

<sup>12</sup> Schulz, P. E., letter of June 11, 1942.

The advance of the flow toward Hilo probably stopped on May 5 or 6, as a result of the diversion of part of the lava by the new flow that started on the 4th. The first definite confirmation of this fact came when H. T. Stearns and the writer crossed the flow on the morning of May 7, at an altitude of 6,100 feet. All movement had then ceased, although parts of the flow were still very hot. Red glowing lava could be seen in many places. The lava was nearly all aa, but a few small tongues of pahoehoe were observed. Accretionary lava balls, formed by the rolling up of viscous lava about some solidified center, were abundant.<sup>13</sup> Some had diameters of as much as 12 feet. One secondary fumarole was observed, consisting of a hot glowing area liberating a small amount of sulfurous fume, and encrusted with a thin deposit of sulfur. This secondary fumarole was located at the edge of one of the dead aa rivers, at the foot of the levee, and the edges of the lava rivers were generally found to be the hottest areas. Organic gases such as methane or ammonia, resulting from the partial volatilization of vegetation overflowed by the lava, were not observed, but were probably present at least in small amounts during earlier stages.

The final termination of the lava is at an altitude of approximately 2,750 feet, about 10 miles from the center of Hilo. The total length of the flow below the principal lateral vent at 9,200 feet altitude is approximately 16 miles.

#### BOMBING OF THE LAVA

On May 1, there appeared to be imminent danger that the lava flow might successively cut the Olaa flume which supplies water to the town of Mountain View, block the road around the island, and destroy part of the city of Hilo and the Waiakea plantation. Consequently, the United States Army decided to try to divert the flow by aerial bombing. It was proposed to break down the levees and allow the lava river to escape laterally, thus reducing or eliminating the supply of lava to the main front of the flow. R. H. Finch made a reconnaissance flight and selected the most favorable sites for bombing, but before the bombers could reach the area, it was covered by clouds. Therefore, the bombs were dropped higher up the flow at less favorable localities.

Altogether, about 16 demolition bombs were dropped, some weighing 300 and others 600 pounds. Most struck directly on the target. Some bombs were dropped on the lower source, but without appreciable effect. The others were dropped at a place where the open lava river swung against the outside of a long loop in its course,

<sup>13</sup> These have been termed *bombes à roulement*, but the name is inappropriate. Their origin is not at all like that of true volcanic bombs.

and where the levee was unusually narrow. The levee was broken, and a small lava stream escaped to one side of the main flow, but the topographic depression that had guided the original flow also guided the new branch. It flowed parallel to the main river for a short distance, and then rejoined it.

Although the bombing had no effect in stopping the flow, it did demonstrate that under favorable circumstances it might, by breaking down the levees, be possible to create new branches of a flow and thus retard the advance of the main front. Total diversion of the flow would, however, depend on a combination of favorable circumstances, including a lava river flowing in a channel higher than the surrounding territory, narrow levees that could be broken down by bombing, and topography that would direct the new flow away from the old one rather than back into it. The necessity for further bombing was removed by the stagnation of the principal flow a few days later.

There appear to be three manners in which bombing may cause the formation of new branch flows, and thus lessen or terminate the advance of the previous lava front. One of these involves the breaking down of a narrow levee along an open lava river, as was done in the 1942 eruption. Another and similar method is the breaking down of part of the cone wall, allowing lava to escape laterally and form a new flow, as it did naturally during the 1942 eruption, on May 4. The third method involves the breaking in of the roof of a lava tube through which the lava river is flowing. This may, if the roof of the tube is thick enough, block the tube with solid fragments, or it may cause local congealment of the lava, perhaps partly or entirely through violent stirring by the explosions resulting in local change of the flowing lava from pahoehoe to aa. The local congealment may plug the tube, resulting in the development of a new lava river. This appears to have happened as a result of the bombing of the 1935 lava flow,<sup>14</sup> but was not to be expected in the 1942 eruption, where the lava river was open, not enclosed in a tube.

It appears to the writer very doubtful if bombing would ever cause the termination of an eruption. Its value probably lies only in the possibility of delaying the advance of the main flow front, by causing the formation of new lateral flows, or with very favorable topography by deflecting the flow into new channels.

#### CONCLUSIONS

The 1942 eruption of Mauna Loa opened, like most others, with activity in and near the summit caldera. The principal activity, a

<sup>14</sup> Jaggar, T. A., *The Volcano Letter*, No. 431, January 1936, and No. 465, July-September 1939.

flank eruption on the northeast rift, began 2 days later. The flank eruption may be arbitrarily divided into three phases, which are characteristic of most flank eruptions of Mauna Loa. They may be summarized as follows:

1. A period of a few hours during which very hot fluid lava is squirted from a narrow fissure, forming a nearly continuous wall of lava jets thousands of feet in length. Lava extrusion forms extensive thin flows. Low ramparts of agglutinate are built by spatter along the fissure, but no large cones are formed.

2. Restriction of the lava fountains to a relatively short medial portion of the fissure, and the building of cinder and spatter cones. One or more major flows issue continuously from the cones, and numerous minor flows may occur.

3. Decline of the fountains, with cooling of the liquid lava in the vent, and decrease in the amount of liberated gas. The flow of lava may die out with the fountains, or may continue for weeks or even months after the cessation of fountain activity.





1. LAVA FOUNTAINS AT 9,200 FEET ALTITUDE. SEEN FROM THE SOUTHWEST, MAY 2, 1942.

The fountains are about 200 feet high. In the foreground new pahoehoe lava has overflowed older aa.



2. CENTRAL LAVA FOUNTAIN OF THE ACTIVE CONE CHAIN, MAY 3, 1942.

The large lava shred is about 100 feet above the rim of the cone. The light-colored ejecta are ascending and the darker, cooler ejecta are falling back.



1. LAVA RIVER 15 FEET WIDE. ISSUING NEAR EAST END OF  
CONE CHAIN ON MAY 9, 1942.

The lava in the foreground was still hot enough to scorch shoe leather.



2. LAVA FOUNTAINS AND FLOWS AT 9,200 FEET ALTITUDE,  
SEEN FROM THE NORTH, MAY 5, 1942.

The flow in the foreground is the result of the partial breakdown of the cone on May 4. Aerial photograph by Allan Campbell for Acme Newspictures, Inc.

## NEW METALS AND NEW METHODS <sup>1</sup>

By C. H. DESCH, F. R. S.

There has been an enormous increase in the production of the most important metals, the output doubling itself in quite a short period: 12 years for copper, 17 for pig iron, 18 for tin, and so on. Along with this quantitative growth, the development of modern industry has brought with it remarkable qualitative changes, elements which until lately were curiosities of the laboratory rising into industrial importance. Aluminum, which 75 years ago had only been obtained in quantities of a few pounds, had a world production at the beginning of the War approaching a million tons, while its later development on both sides of the Atlantic has been on a very large scale. Aluminum is not one of the rare metals; it is, in fact, the most abundant of all metals in the earth's crust, but at present bauxite, a rich mineral of very local distribution, is alone used for its extraction. But elements of rare occurrence, such as tungsten, molybdenum, and vanadium, now occupy, in consequence of the ever-increasing demands of the engineering industries for materials of higher strength or other special properties, a key position out of all proportion to their abundance. This is largely due to the discovery that the properties of a metal may be profoundly altered by very small additions of another element, metal or nonmetal. Pure iron is even softer than copper, but less than 1 percent of carbon converts it into steel which may be made so hard as to scratch glass. This fact had been discovered empirically many centuries ago, but now that the process is better understood there are many other instances of the same kind. Copper can be made hard enough to serve as springs and even as nonsparking mining tools by adding 2.5 percent of beryllium, while the soft metal lead may be strengthened, so as to offer a greater resistance to frost when used for water pipes, by alloying with so little as 0.05 percent of tellurium.

These and similar observations have led to important developments in metallurgy depending on the use of comparatively rare metals which are mostly found only in local concentrations in various parts of the earth. In a statistical table, the production of some of the minerals

<sup>1</sup> Paper read at the Conference on Mineral Resources and the Atlantic Charter arranged by the Division for the Social and International Relations of Science of the British Association on July 25. Reprinted by permission from *Nature*, vol. 150, No. 3806, October 10, 1942.

from which these rare elements are obtained may not seem impressive, but the access to them may be an important factor in the capacity of a country to produce machinery and other constructions into which metals enter.

The usefulness of the less common metals is, of course, not confined to small additions. The possible combinations of metals with one another are virtually infinite, and in spite of the vast amount of research and practical experience in this field, there must be many valuable combinations as yet undiscovered. The first recognition, partly accidental, that steel could be made to resist corrosion by incorporating 14 percent or so of chromium, led to the development of the important class of stainless steels, while the new magnet steels, containing aluminum and nickel, and in their later forms also cobalt and copper, have brought about a revolution in the construction of electrical instruments and loudspeakers, the very high magnetic concentration which is possible with them enabling very small permanent magnets to be used. For other purposes, such as the clutches used for holding work in milling and grinding machines, they replace electromagnets. With these steels it is possible to realize the image of Mahomet's coffin—heavy bars floating in the air in consequence of their strong magnetic repulsion.

A few of the rare metals find applications depending on their own peculiar properties. Thus tungsten, with its very high melting point of  $3650^{\circ}$  C., has superseded all other materials for the filaments of electric lamps. The invention of the fountain pen called for an exceedingly hard and incorrodible substance for the tips of the gold nibs, and this was found in a native alloy of osmium and iridium. Tantalum has proved specially suitable for the spinnerets used in making artificial silk, rhodium and indium for depositing in thin layers on other metals for protection against corrosion, and so on. The non-metal selenium is used in photoelectric cells. Further uses of this kind will present themselves as the properties of the less common elements are studied more completely.

The high melting point of some of the metals has led to research in two main directions. On one hand, it has been necessary to devise means of making metals compact and strong without melting them; and on the other, to develop new materials and new techniques for operations at temperatures higher than those in ordinary metallurgical furnaces. Tungsten cannot be melted in a container of any known refractory material. The powder obtained by reducing its oxide is therefore packed into the form of bars under pressure and heated electrically until the particles cohere, and is then hammered in a special way until its strength is sufficient to allow of its being forged or drawn into wire. The same process has been applied to other metals, and a

new branch of technology, known as powder metallurgy, has grown up. Not only the metals of high melting point, but also copper, bronze, and even the low-melting alloys of tin, are prepared in the form of small particles and made to cohere by heat and pressure.

The method has several advantages. Small objects may be produced of accurate shape, requiring no machining, by pressing in dies, while the mass may be made completely solid or given any required degree of porosity. Such porous masses are particularly useful for bearing metals, the spongy metal holding the lubricant better than by any arrangement of grooves. The method of consolidating a powder is also used in the making of carbide tools. Certain very hard compounds, especially the carbides of tungsten and titanium, which for many purposes can replace diamonds, are brittle in the mass, but if crushed and mixed with a metallic powder, mainly cobalt, and then heated until perfect union with the binding material is brought about, yield a composite mass which is excellent for tools and dies.

The chief obstacle to chemical operations at very high temperatures, 1600° C. or above, lies in the difficulty of finding materials for furnace construction and for containing vessels which are both strong and resistant to chemical attack at such temperatures. The ordinary fire clays become soft and are attacked by slags. A few oxides, especially alumina, magnesia, thoria, and beryllia, meet severe requirements in this field, but their refractory qualities are lessened by quite small proportions of impurity, and their preparation calls for special technique, which has been developed as a result of long research in the laboratory, but has as yet been little applied on a large scale. When such materials become available in quantity—and there is no difficulty in principle, although the procedure may be costly—we shall see important developments in chemistry and metallurgy at high temperatures. It is interesting to note that it is the oxides of some of the rare elements—thorium, beryllium, and zirconium—which have the highest softening points among the refractory materials, so that their importance will grow with the extension of high-temperature processes.

In the heating of metals or other conductors, it is not necessary that the heat should pass through the walls of the containing vessel, as it does when a metal is melted in a crucible furnace. Modern heating by induced currents of high frequency allows the heat to be generated where it is required, that is, within the mass to be heated. This involves a less severe tax on the refractory materials, and also makes it possible to enclose the charge in an outer closed vessel which remains cold, so that the operation can be carried out in a high vacuum or in an atmosphere of some inert gas. This is not merely a laboratory device, but is used on a large scale in a number of manufacturing operations, which will become more numerous in the future.

Melting in a vacuum, out of contact with furnace gases, gives a means of preparing many substances in a state of great purity and soundness, unobtainable in other ways, and is already applied to certain alloys in amounts of several tons at a time.

Many chemical reactions are made possible or are accelerated by high pressures. The autoclave has long been a familiar piece of chemical plant, but some of the processes for the production of ammonia from the air or for the hydrogenation of coal to form oils and petrol called for higher pressures than those of the usual autoclave, and recent work, especially in the United States, has shown the remarkable results which may be obtained under pressures of many thousands of atmospheres. To construct vessels to be operated at such pressures, sometimes combined with high temperatures, naturally involves entirely new engineering methods. The materials used are mainly steels, although hard carbides may have to be used for certain parts; but for the highest pressures counterbalancing stresses have to be applied by shrinking one cylinder over another or in various ways producing an internal stress opposite to that which will arise in operation. Here is another new branch of engineering of great scientific interest, extending the range of usefulness of known materials.

The substitution of one metal for another for particular purposes is not always due to inherent advantages, but is often a consequence of a policy of self-sufficiency adopted by an industrial country. This motive has been very prominent in recent years. It is natural that Germany, producing much aluminum but very little copper, should adopt the lighter metal for overhead electric power cables, but a similar replacement in the windings of motors and dynamos was purely due to conditions of blockade and could not be defended on other grounds. During the period of armament and of hostilities such substitutions have been very numerous, but the subject is too big to be entered on here. A few instances of substitution under normal conditions may be mentioned. The saving of weight by using light alloys of aluminum or magnesium in place of steel has mainly been utilized in aircraft and rolling-stock construction, but it has occasionally been applied in ordinary structural work. A bridge in Pittsburgh, having been condemned as insufficiently strong for the increased traffic, was lightened by replacing the wrought-iron road girders and floor by aluminum alloy. The main girders were still in good condition, and the lightening of the dead load gave the bridge a new lease of life.

The substitution of one material for another is not, as a rule, a simple matter. Metals differ not only in strength but also in elastic properties, and this difference has to be allowed for. The new Quebec

Bridge was designed to take advantage of the high tensile strength of nickel steel, the designers considering that the Forth Bridge, a very stable structure, was unnecessarily heavy. The disaster of 1907, when the unfinished bridge collapsed, was due to the crumpling of the lower members, although calculation had shown that the direct load-carrying capacity was ample. It has been proposed to use alloys of aluminum on a large scale in shipbuilding, their use in small vessels having proved successful, while the particular alloys used—those with magnesium—are highly resistant to corrosion by sea water. In changing from steel to light alloy, however, it would not be enough to calculate the dimensions of each member to give a strength equal to that in a steel ship. The hull would float too high in the water, and problems of stiffness would arise from the very different elastic properties; to build a successful vessel the design would have to be new from the beginning.

So, when the hard carbide steels were introduced to take the place of tool steels for very heavy work or large output, allowing cuts to be made on a lathe at much higher speeds than before, advantage of the improved properties could not be taken until the machines themselves had been completely redesigned to allow of such high speeds without undue vibration; and in fact the introduction of carbide tools has meant a revolution in the machine-tool industry, much plant intended for large outputs being rendered obsolete.

Three examples may be given of the substitution of an entirely new material for one of which the supplies have been found to be inadequate or too costly. Platinum, a metal of very local occurrence, has been largely replaced for chemical purposes, fused silica taking its place in the concentration of sulfuric acid, and iron oxide in various catalytic processes. On a larger scale, Chile nitrate, a product formed under quite exceptional climatic conditions and almost unique, is no longer indispensable as a fertilizer, the nitrogen compounds required for agriculture and explosives being obtained synthetically from the air. The third example is the introduction of plastics, resinlike substances which may be given the most varied properties. For many purposes they replace metals, and when reinforced by textile material or paper have a strength comparable with that of a metal. Transparent varieties replace glass and are far less brittle; other types take the place of porcelain and earthenware. The manufacture of plastics is one of the rapidly growing industries, and the uses of these new materials are continually being multiplied.

It must be realized that even such substitutions as these do not necessarily lessen our dependence on mineral resources, although the relative importance of different deposits may be altered. Nitrogen compounds are obtained by the use of electric power, which in some

countries is derived from water, but in some of the most highly industrialized countries has to come from the combustion of coal. Many of the plastics are also derived from coal or petroleum, but being organic compounds, there is always the possibility of producing them from vegetable matter, as for example through the production of alcohol by fermentation and its conversion into more complex compounds. Such a procedure would be in line with the policy of depending on current revenue, derived from plants, rather than drawing unnecessarily on mineral capital, which, once exhausted, is not replaced.

Much might be said of means of economizing metals: the use of structures built up by welding, in place of heavy castings; the combination of concrete with steel in buildings and bridges; the saving of valuable metals by employing them as thin coatings on mild steel in chemical plant, and so on; but space does not permit. As new materials come into use and new techniques are developed, while at the same time the known reserves of some indispensable metals are being depleted, it becomes clear that the efficient use of the world's mineral resources demands systematic planning. First of all, a far more thorough world survey is needed, gathering together the information collected by prospectors in the interest of large industrial corporations as well as by the various national surveys. Such a survey would be the essential basis of any system of international control of mineral resources.



# OCEANOGRAPHY<sup>1</sup>

By HENRY C. STETSON

*Museum of Comparative Zoology, Harvard University*

## INTRODUCTION

Oceanography is a young science and in the modern meaning of the term includes not only the study of the physics and chemistry of the sea water itself but the animals and plants that live in it, the sediments that have settled out of it, together with conditions governing their transportation and deposition, and the topography and geologic structures of the various basins that contain it. Inclusiveness, however, is not solely the result of youth, for by its very nature the different branches will always be closely interwoven. For instance, the problems of the chemist also concern the biologist studying the ecology of animals in the sea, and they will also be of importance to the geologist if an adequate attack is ever to be started on the diagenesis of sediments. The forces governing the different types of currents are of interest to physicist and geologist alike, and it has recently been demonstrated that some of the principles of oceanic circulation are equally applicable to the atmosphere.

The different divisions are further tied together by the purely practical necessities which the study of the ocean imposes. A seagoing vessel is expensive to acquire and to maintain, and in addition there is the cost of the special equipment which a research ship must have. An investigator whose field work is carried out by such costly and time-consuming methods has little choice but to work in conjunction with others whose data likewise must be gathered by the same means.

Surveying, sounding, and charting have always played a part in oceanographic expeditions, but, until recently, geological work has been secondary. Small bottom samples were taken in the course of routine sounding, and a generalized knowledge of the areal distribution of the oceanic sediments was early acquired, but here the matter rested. However, before tracing the growth and development of the geological branches of this science, it is necessary to review the beginnings of the subject as a whole.

<sup>1</sup> Reprinted by permission from Fiftieth Anniversary Volume, Geological Society of America, June 1941.

## HISTORICAL BACKGROUND

## BIRTH OF THE SCIENCE

On December 21, 1872, H. M. S. *Challenger* sailed from Portsmouth, England, on what proved to be one of the memorable voyages of history. It lasted 3½ years, circumnavigated the globe, and investigations were carried on in every ocean except the Arctic. It was the first combined assault on the ocean with all the techniques which were then available. Nothing approaching this undertaking in detail and completeness had been attempted heretofore or even contemplated. At each station the following observations were made insofar as practicable: The depth was determined and a bottom sample taken; serial samples of water were obtained from the surface to the bottom for chemical and physical examination; serial temperatures were taken from the surface to the bottom; a fair sample of the bottom fauna was dredged, and samples from intermediate depths and from the surface were taken in townets; atmospheric and meteorological conditions were noted; and the direction and rate of the surface currents were observed, and at some stations attempts were made to ascertain the movement of the water at various depths.

The initiative for this undertaking was furnished by the interest and enthusiasm of two British naturalists, Dr. W. B. Carpenter and Prof. C. Wyville Thomson. A few years before, through the influence of the Royal Society, the Admiralty was persuaded to fit out an old gunboat, the *Lightning*, for a dredging and sounding trip in the vicinity of the Faroe Islands. Biological dredging was carried out in a little more than 600 fathoms, which was a record for that time. This voyage proved so successful, in spite of bad weather, limited equipment, and a poorly found ship, that in 1869 the Admiralty was again persuaded through the same channels to fit out another ship for similar purposes. The *Porcupine* was a better vessel, and more extended cruises were taken around the British Isles, into the Bay of Biscay, and the Mediterranean. Successful dredging was carried on to over 2,400 fathoms, and it was all done with hemp rope. On these cruises temperatures were taken at various depths on the dredging stations. Having demonstrated the feasibility and the scientific importance of this type of research at a time when attempts to lay transoceanic telegraph cables were drawing attention to the ocean basins because of the need for more accurate knowledge of their topography, the moment was opportune for projecting a major expedition.

Wyville Thomson, who was knighted for his leadership of the expedition, died a few years after its return, and the task of preparing the reports fell to John Murray. The 50 quarto volumes, with many specialists contributing, are evidence of the huge quantity of data

collected. Although the publications in biology bulk by far the largest, nevertheless considerable geological information was also obtained. The depths and main contours of the ocean basins were determined for the first time, and the general distribution of the bottom deposits was mapped. Many out-of-the-way corners of the world were charted, and something was added to our knowledge of ocean currents both on the surface and at various depths. Pioneer work was also accomplished in the field of hydrography and on the chemistry of the ocean. Today it is, of course, easy to pick the flaws. Methods in every field have become more precise; improved gear has been developed as well as more exact procedure. Nevertheless, theirs was the pioneer attempt, and with that voyage the broad framework of the science as a whole was laid down to remain scarcely altered until modern times. Others have profited by their experiences and improved on their results, but, taken by itself, no other subsequent expedition has left so deep an impress.

Interest was so stimulated in other countries that a succession of deep-water expeditions to various parts of the world followed. By 1900 the United States had sent out *Blake*, *Albatross*, and *Tuscarora*; the French, *Travailleur* and *Talisman*; the Germans, *Valdivia* and *Gauss*; the Italians, *Vettor Pisani*; the Danes, *Ingolf*; and the Dutch, *Siboga*, and this by no means completes the list. None of these cruises was so extended as that of the *Challenger*, and although the gear was constantly being improved the work was laid out along essentially the same lines. Although the expedition sailed more than 50 years ago, the voyage marks the birth of oceanography as a science. Consequently some description of the vessel and her gear is pertinent as a background against which to view modern developments.

#### EARLY EQUIPMENT AND METHODS

Selected by the British Admiralty for this voyage, the *Challenger* was a corvette of some 2,000 tons with auxiliary steam. The guns were removed, and she was refitted in various other ways for her new purpose. She still remained a navy vessel, however, and Capt. George S. Nares, an officer of much experience in surveying, was given command. Prof. C. Wyville Thomson was in charge of the civilian scientists, and the work of the naval and civilian staffs was kept separate. Thomson (1877, p. 11) writes of the voyage:

the chart room \* \* \* is a commodious compartment on the starboard side, with ranges of shelves stocked with charts and hydrographic, magnetic, and meteorological instruments. All work in these departments, as well as the whole of the practical operations in dredging, sounding, and taking bottom and serial temperatures, is conducted by the naval officers.

The natural-history workroom corresponded with this on the port side, and a chemical laboratory was also fitted up. These were both in charge of the civilians.

All soundings were taken with a specially made hemp line wound on reels. The sounding instrument was a tube around which detachable weights were fitted. On striking the bottom the weights were released, and the tube was hauled to the surface with its plug of sediment or perhaps a short core. The line was marked off every 25 fathoms, and, in deep water, contact with the bottom was ascertained by the slackening in the rate at which the line ran out. All hydrographic work—that is, the taking of temperatures and water samples—was done with this same line. Hemp rope 2, 2½, and 3 inches in circumference, and spliced in 3,000–4,000 fathom lengths, was used for trawling and dredging. Steam winches were used for hoisting; but, even so, the labor of handling and coiling the miles of rope required for the deep tows must have been very great. However, as warships always carry proportionately larger crews than other vessels, plenty of manpower was available. It is interesting to note that with present-day equipment exactly the same work can be, and is, done by three men in a watch.

In 1872 Sir William Thomson, later Lord Kelvin, seeking an improvement in the laborious and not too accurate method of sounding with rope, developed a machine for using piano wire. The great disadvantage of rope for sounding is the frictional resistance it presents to water. Not only does it take longer to run out than does wire, but the currents encountered often throw it into large bights, making the sounding inaccurate. Kelvin's method with various modifications gradually came into general use and, up to the invention of echo-sounding wire, was used in all surveying. At the start, however, difficulties were encountered in securing wire of sufficient tensile strength and in making strong splices, and although the *Challenger* had one of these machines on board, it was never used. It is interesting to note, however, that only 2 years later Lieutenant Commanders Howell and Sigsbee (1880), of the United States Navy, adopted wire and used it successfully on the United States Coast and Geodetic Survey steamer *Blake*, which they successively commanded. Sigsbee modified Kelvin's machine and invented another which bears his name, but the principle remained the same.

#### LOUIS AND ALEXANDER AGASSIZ, MONACO, AND NANSEN

Four individuals deserve special mention in this historical review for their unique accomplishments: Louis and Alexander Agassiz, who were responsible for the inception and growth of oceanography in the United States, the Prince of Monaco, and Fridtjof Nansen.

Louis Agassiz' interests in the field of natural history were exceedingly catholic, and oceanography was but one of the many matters which came in for a share of his attention. Throughout his lifetime his relations with A. D. Bache and Benjamin Pierce, the superintendents of the United States Coast Survey, were most cordial, and his suggestions for projects which could be carried out from Government vessels, in addition to their regular surveying duties, were always welcome. The man who was responsible for the actual dredging was L. F. Pourtalés, one of Agassiz' associates who had followed him from Switzerland to America in 1848 and who 2 years later became an assistant on the Survey. Today he is comparatively obscure, although he was the pioneer of deep-water dredging in this country and antedated the first English cruises. In 1869 he published a short account of the sediments of our east coast continental shelf, which is believed to be the first paper on modern marine sediments to appear in this country (U. S. Coast and Geodetic Survey, 1869, appendix No. 11, pp. 220-225). Although Agassiz was primarily a zoologist, his interest in geological matters was always keen, and in a report to Pierce on the work of the *Bibb* in the Gulf Stream and off Florida and Cuba appear the following observations (1869, pp. 368-370), which are of interest considering the date:

From what I have seen of the deep sea bottom, I am already led to infer that among the rocks forming the bulk of the stratified crust of our globe, from the oldest to the youngest formation, there are probably none which have been formed in very deep waters. If this be so, we shall have to admit that the areas now respectively occupied by our continents, as circumscribed by the 200-fathom curve or thereabout, and the oceans at greater depth, have from the beginning retained their relative outline and position; \* \* \* Moreover, the position of the cretaceous and tertiary formations along the low ground east of the Alleghany range is another indication of the permanence of the ocean trough, on the margin of which these more recent beds have been formed. \* \* \* Geologists, and especially those of the school of Lyell, have again and again assumed the slow rising of extensive tracts of land from beneath the water and taken all sorts of loose materials \* \* \* as evidence of its former submersion. But since the dredge has been applied to exploration of the deep, and a great variety of animals, in a profusion rivaling that of shoal water, have been brought up, \* \* \* no observer is justified in considering extensive deposits of loose materials as marine in which no trace of marine organic remains are found.

He made his last cruise in the Coast Survey steamer *Hassler* around the Horn from Boston to San Francisco in 1872 shortly before his death.

Oceanography is such an extensive field of research that few individuals have been able to finance their own investigations. Alexander Agassiz was one outstanding example; the Prince of Monaco was another. Agassiz' early cruises were made from 1877 to 1880 in the United States Coast Survey steamer *Blake*. It was on the first of these,

only 1 year after the return of the *Challenger*, that Agassiz, with his background of practical mining experience, first introduced wire rope for dredging. The tremendous advantages over hemp rope—greater tensile strength for a given diameter, ease of handling, and ease of storage—are, of course, obvious, and its value for use at sea was quickly demonstrated. Nevertheless, considerable time elapsed before it was generally adopted in Europe. To Lieutenant Commander Sigsbee (1880), the man who first successfully proved the entire practicability of sounding with piano wire by a modification of Lord Kelvin's machine, should go the credit for the proper installation of the winches and all the details for the practical handling of the dredging wire aboard the *Blake*. Sigsbee, it will be remembered, later was in command of the U. S. S. *Maine* when she blew up in Havana Harbor.

The *Blake* worked off the east coast of the United States, in the Gulf of Mexico, and in the Caribbean, in shallow water and deep, and these cruises marked the most serious attempt in the United States, up to that time, to solve oceanographic problems. They were but the forerunners of Agassiz' many expeditions, as he remained active up to the time of his death in 1910. He chartered many vessels privately, and even when using the *Albatross*, belonging to the United States Bureau of Fisheries, he bore a large part of the expense of operation. His voyages took him into the Pacific and Indian Oceans as well as into the Atlantic and throughout the West Indies. Although biology was his chosen field, he took a lively interest in the coral-reef problem and probably investigated more reefs than has any geologist. He added hundreds of deep-water soundings to the charts, and in certain parts of the Pacific they remain to this day the only ones that have been taken. It does not often happen that a single individual is able to further the development of his particular field to such an extent or to exert so much influence on it.

The Prince of Monaco became interested in oceanography as early as 1885 and used his own private fortune to finance his researches. He successively equipped several yachts for this type of work, frequently commanding them himself, and built a laboratory and museum at Monaco where the results of his investigations could be worked up and published. A long series of important reports and monographs have come from his institution, and oceanography has been greatly advanced by the efforts of this one man, particularly in the field of biology.

Nansen began his career as an oceanographer by planning and successfully carrying out one of the most remarkable voyages that has ever been undertaken. His idea was to freeze a vessel in the ice and drift across the Polar Sea, possibly reaching the Pole itself.

He was confident from the slight evidence available about the currents that this could be accomplished, although many predicted that he would never return. *Fram* was a heavily constructed, wooden vessel and of such design that when squeezed in the ice she would tend to lift and not have to take the full crushing force of the shifting floes, which no ship has ever been able to withstand. She was frozen in off the New Siberian Islands in 1893 and emerged from the ice 3 years later off Spitzbergen. The Pole was missed by less than 5°, but many valuable hydrographic data were obtained through holes cut in the ice during the drift across the then unknown Arctic Basin, and the first bottom samples were secured. *Fram*, after several subsequent trips, is now preserved as a national monument at Oslo, like Nelson's flagship *Victory* at Portsmouth, England, and the *Constitution* in the United States, an honor which but few of the vessels that have made history have attained.

## PROGRESS IN SUBMARINE GEOLOGY UP TO 1900

### GENERAL STATEMENT

The turn of the century roughly divides the older from the modern phases of the science as a whole; consequently it is pertinent to give a brief summary of progress up to this point, before the advent of various new techniques which have put submarine geology on a par with the other subdivisions of oceanography.

### MURRAY'S CLASSIFICATION OF SEDIMENTS

Up to this time most geologists had taken little interest in oceanography. They accepted Murray's broad and rather inclusive classification (*Challenger Expedition*, 1891) of marine sediments without critical comment, as though sediments in the sea and sedimentary rocks on land were unrelated phenomena. The interest of the oceanographers, where sediments were concerned, largely centered in the oozes of the deep sea; and though plenty of shallow-water samples had been collected, nobody paid much attention to them. Murray's classification became standard the world over, and for that reason it will be restated here.

He lumped all marine sediments in two main categories—terrigenous and pelagic. The former group includes all sediments consisting of waste derived from the land. Once outside the zone of littoral and shallow-water deposits, which are supposed to cease at 100 fathoms, the terrigenous sediments covering the continental slopes and parts of the ocean basins nearest the land are pigeon-holed in five divisions. Blue mud is characteristically found in the neighborhood of continental land masses. Green mud is a variety containing glauconite

and, according to Murray's description (1912, p. 162), usually occurs "off high and bold coasts where currents from different sources alternate with the season, as off the Cape of Good Hope, off the east coast of Australia, off Japan, and off the Atlantic coasts of the United States." It may grade into greensands. Red mud is still another variety "found in the Yellow Sea and off the coast of Brazil, where the great rivers bring down a large amount of ochreous matter" \* \* \* (1912, p. 162). Volcanic mud and coral mud are self-explanatory.

Pelagic deposits begin to make their appearance in the ocean basins proper, at sufficient distances from the continental margins to prevent their being masked by detritus from the land. Of these, *Globigerina* ooze is the most widely distributed. Diatom ooze is characteristic of the colder waters, particularly the great circumpolar seas of the Southern Hemisphere; pteropod ooze is found in the warm waters of the Tropics; and radiolarian ooze occurs in the deeper parts of the Pacific and Indian Oceans. The last and most interesting of the deep-sea oozes is red clay, which floors vast areas of the Pacific far from the continents. It is supposed, according to Murray, to be a hydrated silicate of alumina derived from the disintegration of pumice and volcanic ash. Its rate of deposition is extremely slow, and consequently it is found only in the more remote parts of the ocean where the deposition of other debris and planktonic material is practically zero.

Such, in general, is the horizontal distribution of the various types of marine sediments as determined from the *Challenger's* data. Subsequent expeditions merely defined the areas more exactly. It was worked out, in a sense, merely as a byproduct of sounding. The samples, as we have seen, consisted of small plugs of mud brought up sticking in the end of the sounding tube, and they were so short that to all intents and purposes they were surface samples. During this period no one seems to have made any serious attempt to secure cores.

#### IMPROVEMENTS IN SOUNDING TECHNIQUE

The gear for deep-water sounding had been greatly improved as time went on, and with this development in technique came a corresponding increase in our knowledge of the true configuration of the ocean basins. When deep soundings were first undertaken, an attempt was made to haul up the whole sounding lead. Consequently a heavy line was necessary and, when any considerable length was out, its weight bore so close a ratio to that of the sinker that in deep water it was impossible to tell when bottom had been reached. Furthermore, the line kept running out endlessly of its own momentum even after the sinker had touched. On the early charts, for instance, some



fantastic figures appear for mid-Atlantic soundings which can be attributed to this cause.

The first attempts that can claim even approximate accuracy at depths exceeding 1,000–1,500 fathoms were made in the United States Navy by using a light line and a heavy weight. It was easy to tell when bottom had been reached by the sharp check in the rate at which the line ran out. The line was then cut, and no attempt was made to retrieve it or the sinker. The depth was ascertained by the simple method of measuring the remainder. The next important advance, made by a midshipman named Brooke, eliminated the obvious drawbacks of the former method. Still using a light line, the weight—a cannon ball with a hole through it—was released when it landed on bottom, and the sounding tube—a metal cylinder which passed through the ball—alone was hauled to the surface. Simple as this seems from the vantage point of today, this scheme of detaching the weight made the difference between accurate and inaccurate soundings in deep water. Piano wire soon replaced hemp, again with an increase in the accuracy of the results and a great reduction in the time required for sounding, as the frictional effect of the water on rope was thereby eliminated. The machines for handling the wire have been greatly improved since Sir William Thomson's first attempt, so that it became possible to take a sounding in a small fraction of the time formerly required. This method remained in general use until the perfection of echo sounding within the last decade. In the literature perhaps too much stress has been laid on the soundings made by various oceanographic expeditions. An enormous amount has been done in deep water by government vessels, and, of course, all near-shore and shallow-water surveying is a government undertaking. Nor should the cable ships be forgotten. They, likewise, have played an important part in charting the oceans—a fact not generally appreciated—for it was the need for a better knowledge of the ocean bottoms in connection with laying cables that first stimulated systematic deep-water sounding.

#### RISE OF MODERN TRENDS

By 1900 the broad configuration of the ocean basins had been mapped and all the major deeps had been discovered and charted. This, plus a very general knowledge of the distribution of the sediments, particularly the pelagic oozes, comprised the chief contributions to geology before the advent of what we shall call the modern period. The other sciences, especially biology, had advanced much farther in the same interval. This lag is largely due to the fact that few geologists paid any attention to the sea, except around its margins. They seemed to regard oceanography as lying outside the boundaries of their particular do-

main and having little to offer. Men whose chief interest lay along other lines were mainly responsible for what geological information there was.

Up to this point the study of oceanography had proceeded more or less along the same lines which the *Challenger* expedition had laid down. The same general problems were attacked in the same general way and from the same point of view. The biological sciences, particularly systematic zoology, had long been the mainspring which motivated oceanography as a whole, but even here diminishing returns were beginning to be felt toward the end of the century, as each subsequent expedition merely added data which tended to confirm what was already known. "And", as Dr. H. B. Bigelow (1931, pp. 8-9) says:

a period of general oceanographic stagnation might then have succeeded to the preceding peak of activity (this did, in fact, happen in America), had there not arisen new schools, centering their attention on the biologic economy of the inhabitants of the ocean as related to their physical-chemical environment, on mathematical analysis of the internal dynamics of the sea water, and on the geologic bearing of submarine topography and sedimentation, rather than on areal surveys of one or another feature of the sea.

This conscious alteration of viewpoint, from the descriptive to the analytic, is one of two chief factors that gives to oceanography its present tone; the other is the growth of an economic demand that oceanography afford practical assistance to the sea fisheries.

In Europe the Conseil International pour l'Exploration de la Mer was formed as a cooperative effort to handle this latter problem of such vital importance to the nations engaged in the North Sea and neighboring fisheries, and attention was perforce directed to the shallower waters. Interest in the mathematical study of the dynamics of the circulation of the sea centered in the Scandinavian countries. This school developed rapidly, until today perhaps more attention is focused on physical and dynamical oceanography than on any other single subdivision of the science.

Lest it be thought that too much space has been devoted up to this point to nongeological matters, it is once again pointed out that oceanography is, of necessity, a cooperative affair, and not to consider the development of the science as a whole is to lose perspective. Interest and impetus generated in one field may be used to advantage in another. Indeed, if this were not the case, submarine geology in its present state would not exist. Although the recent advances in surveying methods, in the application of geology techniques, and in sedimentation and stratigraphy have been marked, and in some cases spectacular, the geologist must remember that the main emphasis in oceanographic research is still on physics and the internal dynamics of sea water and on biology.

## RECENT ADVANCES IN SUBMARINE GEOLOGY

## INTRODUCTION

The student of submarine geology, except in the field of sedimentation, tries to attain the same objectives that are pursued ashore. The difficulties arise in adapting the various land techniques to marine conditions, and in handling the necessary gear on shipboard. Whatever the objective, it is subject to the limitations that a ship imposes, and the first thing which an oceanographer must realize, no matter what his field of endeavor, is that it is impossible to work with the same precision that is attainable ashore. This is a perfectly valid objection, but, if it were heeded, no oceanographic work of any kind would ever be undertaken.

## MODERN MARINE SURVEYING

The prime requisite for most geological undertakings is a good map; therefore, let us first take up modern developments in charting the ocean bottom. As we have seen, until comparatively recently deep-water soundings were taken with small-diameter wire and a sinker, and, although the machines for handling the wire had been improved to a point where the operation was vastly less time-consuming than during the early period when hemp was used, nevertheless, accurate soundings could be obtained only during good weather, and in any event the ship had to be stopped. Modern echo sounding has come into general use only since World War I. Although prior to this date attempts had been made to locate icebergs by this method, its value in the detection of submarines led to more intensive experiments. The term "echo sounding" is practically self-explanatory. The recording instrument measures the travel time of the sound wave through the water from the ship to the bottom and back again, translated into terms of distance. As the velocity of sound through water varies somewhat with the density, it is necessary to make temperature and salinity observations in the different water masses for accurate soundings. Many types of instruments have been developed, and it is not necessary to go into the details of their construction here. With the earlier models it was necessary to read off each individual sounding, but recently they have been made self-recording. The tremendous advantages of this machine are that the surveying vessel can sound continuously while steaming at full speed, accurately, and in comparative independence of the weather. To quote Capt. G. T. Rude (Geophysical Exploration of the Ocean Bottom, 1937, pp. 10-11) :

\* \* \* in 15 working days in the month of July 1937, the party on the Coast and Geodetic Survey Ship *Lydonia* recorded 12,489 soundings of the continental  
566766-44—16

slope and covered an area of 1764 square statute miles extending more than 150 miles offshore, all of which was precisely controlled by radio acoustic ranging and taut wire traverses tied in to the shore triangulation net on North American 1927-datum.

As a contrast, he cites the 504 deep-sea soundings made by the *Challenger* and the then remarkable number of 3,195 made between 1874 and 1879 by the *Blake*. Similar work is constantly being carried out on the Pacific coast and in the Gulf of Mexico as well as on the Atlantic.

Almost as important as the development of the fathometer is the new method of determining positions accurately at long distances from shore (Geophysical Exploration of the Ocean Bottom, 1937, pp. 9-25). Formerly only the inshore waters within sight of the triangulation stations were accurately surveyed. Once out of sight of these fixed marks the position of the surveying ship becomes more and more doubtful as she proceeds offshore, until at some distance from land the positions of individual soundings on the older charts are not much more accurate than an ordinary sextant fix. As an illustration, on all charts prior to 1938 the steep, outer part of the Hudson Gorge makes a pronounced S-curve. The recent surveys have shown that this S-curve is fictitious, and that the head of the Hudson Gorge had been connected with the mouth of a smaller neighbor, and its own mouth had been missed entirely. When vessels were slow a very generalized representation of the continental shelf and slope was considered sufficient for all practical navigational purposes; but now, when many liners have cruising speeds of over 20 and even 30 knots and all are equipped with echo-sounding apparatus, the Survey decided that more accurate detail of the offshore bottoms would be of considerable assistance to shipping. In thick weather a topographic profile could be constructed by taking continuous soundings and the ship located by comparison with the topography on the chart. This decision on the part of the Survey was more far-reaching than was at first realized, for in carrying out this work the true configurations of the now famous submarine canyons were revealed for the first time, far greater numbers of them were discovered than had hitherto been dreamed of, and a major geological discussion was precipitated which is still far from settled.

To solve this difficulty of accurate positions offshore, the United States Coast and Geodetic Survey developed a method which they call radio-acoustic ranging (Geophysical Exploration of the Ocean Bottom, 1937, pp. 9-25). Briefly, the system is this: Two or more radio stations are equipped with hydrophones, and their positions are determined with reference to the triangulation on shore. The surveying vessel, out of sight of land, steams along her course, sounding continuously with her fathometer. When a position is

necessary, a small bomb loaded with TNT is dropped overboard, and the time of the explosion is recorded on a tape. The sound waves, traveling through the water, are picked up by the shore stations and radioed back to the ship, and the time of reception is recorded on the same tape. The travel times of the sound waves, after the necessary corrections have been applied, give the distance of the ship from each hydrophone. As the surveying vessel works farther and farther offshore it eventually becomes necessary to move the hydrophones farther seaward as well. Originally they were operated from anchored vessels, but recently buoys, equipped with radio apparatus, have taken their place. Both, of course, are tied in with the shore triangulation stations.

One more device is used in offshore surveying—the taut-wire apparatus which was originally developed by the British. It consists of a large drum of fine wire which is used as a steel tape in lengths of over 140 miles. One end is anchored to the bottom, and, as the ship proceeds on her course, the wire is paid out over a sheave which registers the distance run. When a large area is surveyed, this method is used to measure the distances between anchored buoys over the shoreward portions of the regions to be covered, as it can be employed successfully only in relatively shallow water. As the work progresses offshore it is replaced by radio-acoustic ranging.

All the maritime nations have charted their own coastal waters, and various naval vessels have done valuable work in the deeper ocean basins. The recently published bathymetric charts of the East Indian seas from soundings taken by the *Snellius* expedition are outstanding examples (1934; 1935). Not only do they clearly depict the morphology of the basins, fore deeps, and fault scarps, but the topography is sufficiently detailed to serve as the basis for general geological discussion by Dr. Ph. H. Kuenen of such fundamental problems as the theories concerning the structure and origin of island arcs and fore deeps, so well exemplified in this interesting region.

Surveying on an equally large scale has been carried out in the South Atlantic by the *Meteor*. As a result, Stock and Wüst have been able to draw a greatly improved bathymetric chart of that ocean (*Meteor* Expedition, 1935–39). The true configuration of the southern extension of the mid-Atlantic ridge has been depicted for the first time, as well as the longitudinal basins on either side of it which are separated from each other by smaller transverse ridges.

The United States Coast and Geodetic Survey deserves great credit and the gratitude of geologists everywhere for the introduction of precise methods into offshore surveying. The production of topographic maps such as the series for the Atlantic continental shelf and slopes, drawn from their soundings by A. C. Veatch and P. A. Smith

(1939), under a grant from the Penrose Bequest of the Geological Society of America, the detailed work in some of the California submarine canyons both by the Survey and by the Scripps Institution, and the chart of the submarine contours around Bogoslof Island (Smith, 1937) are but forerunners of a type of work which we may expect in the future to become universal.

#### TERRESTRIAL MAGNETISM

Magnetic surveys at sea, according to Dr. J. A. Fleming (Vaughan et al., 1937, pp. 50-56), were first attempted over 200 years ago on Halley's expedition. From that time until the construction in 1908 of a nonmagnetic ship by the Department of Terrestrial Magnetism of the Carnegie Institution of Washington, other surveys of varying accuracy were made, depending on the instruments used and the amount of magnetic disturbance set up by the hulls of the different vessels. The commissioning of the *Carnegie*, however, marks the awakening of a full appreciation of the value of magnetic measurements at sea and a concerted effort to make them as accurate as possible by the optimum equipment and by long cruises devoted exclusively to this aim. Seven cruises totaling nearly 300,000 miles were made before this ship was destroyed by fire in 1929.

Any investigation that holds the possibility of making more complete our knowledge of the earth's structure is worth pursuing for its own sake; furthermore, data accumulated in this field can also be used to advantage in other branches of geophysics, particularly gravimetric studies. This being the case, the need for additional observations at sea are self-evident, considering the large portion of the earth's crust that is covered with water, and entirely aside from the practical values of these studies as an aid to navigation at sea and in the air.

Fleming (Vaughan et al., 1937, p. 53) lists a few theoretical investigations which should be continued in the further survey of the oceans:

Determination of secular-variation of progressive changes of the Earth's magnetic field involving particularly their accelerations \* \* \*. The study of regions of local disturbance and particularly of those indicated \* \* \* over "deep-sea" areas \* \* \*. The determination of additional distribution-data in a few large areas not already covered.

Simultaneously with these investigations work should be continued in the field of terrestrial electricity along the following lines:

Additional determinations to establish changes in the values of the atmospheric-electric elements with geographic position. \* \* \* More and widely distributed determinations of the diurnal variations in atmospheric electricity \* \* \*. Determinations and investigations in the field of earth-currents—a field not yet touched at sea.

Although the Carnegie Institution did not build another ship, the British Admiralty, in view of the importance of these investigations,

decided to continue them and ordered the construction of another nonmagnetic vessel, the *Research*, to be placed in commission with equipment similar to that formerly used on the *Carnegie*.

#### GRAVIMETRIC MEASUREMENTS

Attempts to measure gravity at sea by static methods have never proved particularly accurate, although many different instruments of this type have been devised. The pendulum has always been the standard instrument on land; but, because the difficulties of using it on board surface ships seemed insurmountable, it was disregarded by the earlier workers. In 1923 the Gravity Survey of Holland began to consider the possibilities of using a submarine for this work, and, after preliminary tests, the first really accurate measurements were made, on board a vessel of this type, by Dr. F. A. Vening Meinesz, on a cruise to the Dutch East Indies. Two pendulums were employed instead of one to eliminate the effects of horizontal acceleration. So successful was this cruise that, following the lead of the Dutch, similar expeditions were sent out by other countries. Since 1928 the United States Navy on three separate occasions, in cooperation with Princeton University, has dispatched a submarine for surveys in the West Indies, and the French, Italians, Russians, and Japanese one or more each to the Mediterranean, Black Sea, and the Far East. The Netherlands, in the meantime, has completed seven additional surveys and is about to send out an eighth. The original apparatus has, of course, been considerably modified and refined since the first model was constructed, but the Meinesz method has been followed in all this work.

As in the case of terrestrial magnetism, not only is it desirable to extend the measurement of gravity to the oceans so that the areal survey of the earth may be as extensive as possible, but in this particular case fundamental data can be gathered at sea that cannot be obtained on land. The discovery of the large negative anomalies in the vicinity of island arcs and fore deeps has greatly influenced our ideas on the processes involved in mountain building and gives another clue as to what may have happened in depth during deformation. Solving the problem of measuring gravity at sea may be ranked as one of the major contributions of geophysics to geology in recent years (Vening Meinesz, 1930; 1934).

#### SEISMIC TECHNIQUE

The importance of seismic techniques as an aid to structural geology has long been recognized, but the practical difficulties which stood in the way of the adaptation of this well-known procedure to marine conditions long delayed its use at sea. It is the most recent of the three geophysical methods to be applied to oceanic problems. The first

experiments were carried out in the shallow water of our east coast continental shelf by Dr. Maurice Ewing (1937) 5 years ago. The technique for shallow water can be regarded as nearly perfected, while that for deep water is still in the experimental stage. A new development in the technique for deep-water work is the use of floats filled with an oil of low density for bringing the instruments to the surface, thereby dispensing with a long wire rope which has many disadvantages. The first plans, as described by Ewing (1938), have since been greatly modified, though the principle remains the same.

A profile consisting of four sea stations has been run from Cape Henry, Va., across the shelf to the continental margin, and while, of course, one profile is far from being a complete picture, it has demonstrated that the method is a usable one and that a new tool has been acquired. A thickness of the order of 12,000 feet of unconsolidated and semiconsolidated sediments is found at the continental margin over rocks which registered much higher velocities. This presumably represents the thickened seaward extension of the Coastal Plane monocline lying above the relatively flat basement complex, which itself has a seaward dip. The same relationships which have been observed in the subaerial portion of the Coastal Plain are apparently continued beneath the sea. The east coast shelf, with its relatively simple structure and the presence of numerous deep artesian wells close to the shore line, is a particularly favorable place for the development of this new technique.

Recently Drs. E. C. Bullard and T. F. Gaskell have used the same method in the approaches to the English Channel out to a point 175 miles west-southwest of the Lizard. At the station nearest shore it is thought that an extension of the Triassic is picked up. Farther out unconsolidated sediments were encountered over an igneous basement, but they are relatively thin in comparison with the same type of deposit found off the east coast of the United States.

It is at present impossible to predict how far offshore the work can be carried and still retain its significance from a structural point of view, because with increasing distance from the known stratigraphic column, which must be constantly used as a check, the results are more uncertain. This will be even more of a limiting factor in regions where the structure is complicated. Deep water enormously increased the difficulties. This of course is true of any operation carried out on shipboard. However, even though it will never be possible to work at sea with the same precision that can be attained ashore, or to make as close a network of stations, or get in as many shot points, this should be no deterrent to future activity in this particular field, for the same criticism can be leveled at any kind of oceanographic endeavor.



## BOTTOM SAMPLING

In the beginning, as we have seen, sampling was merely an adjunct of sounding. A sample was taken merely to inform the navigator, by notations placed on the printed chart, over what general type of bottom he was sailing. For this purpose a small bit of sediment plugged in the sounding tube or a smear stuck to the grease on the end of the lead was sufficient. Later, scraper dredges were developed by the biologists, and various kinds of scoops and bucket dredges, capable of taking measured portions of the bottom, were designed for ecological studies. However, these men were mainly interested in obtaining samples for the animals which they contained, and the sediment itself was broadly classified as sand or mud and usually discarded.

The coring tube can be considered as a sampler primarily for geological purposes. Until the invention of the Piggot gun, those used in anything but the shallowest water were merely weighted tubes, which penetrated the bottom by their own kinetic energy. They attained varying degrees of success, depending on their weight and the speed at which they could be dropped. Some had a thin, inner tube of glass or metal which could be slipped out, thus giving the core a permanent container. The length of such cores rarely exceeded 3 or 4 feet, though recently Dr. F. P. Shepard reported taking one of 11 feet.

Coring has played a prominent part in the work of two recent expeditions; the *Meteor* in her traverses across the South Atlantic has taken numerous cores with a modified Ekman type of sampler, and an important series of papers on the sediments and their faunas by Pratzje, Correns, and G. and W. Schott has resulted (*Meteor Expedition*, 1935-39). Besides showing the areal distribution of the different types of material, the tube penetrated deeper layers in which evidence of climatic changes are recorded. The *Snellius*, in the Dutch East Indies, also took many cores, particularly in and around the deeps and on the slopes of submarine volcanoes. These have been discussed by Kuenen (*Snellius Expedition*, 1935) in connection with the question of the sliding of sediment down the sides of the deeps as a process which might tend eventually to fill up these downwarps, and also with regard to the structures which submarine landslides might be expected to produce.

The Piggot gun has been fully described by its inventor (Piggot, 1936), and the details of its construction need not be discussed here. Support for the original design and experimentation was furnished by a grant from the Penrose Bequest of the Geological Society of America. The driving force for the tube, or bit, is produced by a powder charge, contained in a watertight cartridge, which is detonated when

the instrument hits the bottom. More uniform performance has been secured with this coring tube in deep water than with any other yet devised, and cores up to 10 feet in length are frequently taken, although occasionally greater lengths have been attained by tubes which are dropped at high velocity. The extra 6 or 7 feet of core obtained by these newer instruments may not seem to be of much significance as compared to the probable total thickness of the deposit, but it must be remembered that the rate of deposition decreases as one goes beyond the continental slopes into the ocean basins. Accordingly, 10 feet of sediment may represent a considerable interval of time. Indeed, in a series of cores taken by Piggott across the Atlantic basin, and worked up by the United States Geological Survey, four warm and four cold alterations of climate are represented (Geophysical Exploration, 1937, Bradley et al., pp. 41-46).

Using this same instrument, numerous cores have been taken by the *Atlantis* in and around the east coast submarine canyons, along the continental slope, and for some distance out into the Atlantic basin. In these, one or more climatic cycles are usually found. The present-day warm-water fauna from the tops of the cores occurs in a green silt which is being deposited under modern marine conditions. The cold-water fauna from the bottom sections is found in a compact, varicolored clay. Such fine-grained, terrigenous material is not being deposited on the surface of the present-day bottom in this area, on the shelf, slope, or even in the westerly part of the Atlantic basin, as practically all river-borne sediment is now effectively trapped in the bays and estuaries which today border the entire eastern seaboard. The clay in question evidently dates from the last glacial stage of the Wisconsin when, because of the lowered sea level, the rivers were able to cross the shelf and dump their loads directly on the steep continental slope.

The possibilities, therefore, of being able to trace the history of Pleistocene sedimentation in the Atlantic basin and on the continental slope by the continued use of the coring tube are very good. It is even possible that from this source some light may be thrown on the far from settled problem of the origin of submarine canyons. This investigation is already under way at the Woods Hole Oceanographic Institution, and similar work is in progress at the Scripps Institution of Oceanography at La Jolla. At the latter institution an extensive program for submarine geology is being carried out under the direction of Dr. F. P. Shepard, which is, in part, financed by a grant from the Penrose Bequest of the Geological Society of America.

Cores have one limitation which is only just beginning to be recognized. The deeper the tube penetrates the sediment the greater becomes the friction on the inside walls of the tube. Dr. M. Juul

Hvorslev, of the Harvard Engineering School, has recently completed extensive sampling experiments for the Committee on Sampling and Testing, American Society of Civil Engineers, in varved clays with different types of coring tubes. He finds (personal communication)—

that the layers in the upper parts of the cores are often subjected to an increase in thickness due to plastic flow of additional soil into the tube caused by the pressure of the cutting edge. With increasing depth of penetration, and thereby increasing friction between the sample and the tube, the general load on the soil becomes so great that it now becomes squeezed out from under the sampler and the thickness of any given layer is thereby reduced. Finally, at a certain critical depth, internal wall friction becomes so great that no more soil can enter, and the core and tube are driven as a solid pile, pushing a cone of sediment ahead of them. There is, therefore, for each particular type of sampler, and for each type of soil, a maximum length of sample that can be obtained in a single drive. When the soil consists of alternating layers of firm and soft material a further complication, originally observed by Pratje, arises in that the soft layers may be squeezed out partly or completely while the firm layers still enter the tube without any change in thickness.

This behavior of the material introduces a serious factor of error into all attempts to determine rates of sedimentation from linear measurements.

#### SHALLOW-WATER SEDIMENTS

Like organisms, sediments are the resultants of the long sequence of factors to which they have been exposed: current action, wave-generated and otherwise, distance from shore and depth of water, the type of material supplied and its availability, plus their combined effect in the past. These environmental forces have acted on the sediments at their source, during the period of transportation, and at their place of deposition. Many inferences have been drawn in regard to the conditions of marine deposition from the study of sedimentary rocks, but insofar as present-day marine sediments are concerned very few observational data have been accumulated. Of the sediments in the geologic column those laid down in the neritic zone bulk the largest, but our knowledge of them is still very elementary. The earlier oceanographers were, as we have seen, more interested in the deposits of the deep sea, and they added but little information concerning those sediments which to the geologist are the most important. Chiefly by increasing our knowledge of present-day marine sediments and the environments under which they are being deposited will we be able to reconstruct with any degree of certainty the conditions which governed the formation of ancient sediments. With this purpose in view, detailed regional studies are now being carried out off the Atlantic and Pacific coasts, by the Woods Hole and Scripps Institutions, based on traverses of closely spaced surface samples as well as long cores. In addition, some ap-

proach has been made to an understanding of the factors controlling the transportation and deposition of sediments by means of traps placed on the bottom, although this work is still in its early stages.

Additional regional studies have been carried out in the Baltic and neighboring waters by the Thalassological Institute at Helsinki and by the marine laboratory of the University of Kiel; these studies have added much to our knowledge of the conditions of sedimentation found in inland seas. Princeton University has sponsored expeditions to the Bahamas for the investigation of shallow-water, calcareous sediments, a relatively unexplored field. It is hoped that data obtained from studies of this type, to cite but a few examples, will help solve some of the problems of the stratigrapher and lead to a better interpretation and understanding of the environments which produced the different sedimentary rocks.

#### SUBMARINE CANYONS AND ROCK DREDGING

Within the last few years the submarine-canyon problem has provoked so much discussion that the subject has become familiar to all geologists. Although their existence has been known since J. D. Dana's day, they had attracted but little attention until the United States Coast and Geodetic Survey completed the first surveys of Georges Bank by radio-acoustic ranging. For the first time an adequate picture of their true configuration was available, and Dr. F. P. Shepard (1933; 1934) was quick to grasp the significance of the new evidence. As more of these gorges were discovered, and particularly as the continental slope between the major valleys was shown to be deeply scoured and channeled, geologists realized that they were faced with a problem, world-wide in its scope, for which they had no ready explanation. The multiplicity of the theories that have been put forward is an index of the general perplexity. Some consider that the erosion is due to stream cutting and would alter the relationships of land and sea to a hitherto undreamt of extent (Veatch and Smith, 1939); another conceives of a great lowering of sea level by postulating a vastly thickened and extended Pleistocene ice cap (Shepard, 1936); still others consider that the erosion took place beneath the sea. One hypothesis calls for turbidity currents made heavy by their load of mud acquired from the Continental Shelf by wave action during the lowered sea level of the Pleistocene. These currents ran down the slope and scoured it as they sought the depths of the ocean, as well as "triggering off" mud slides by the friction of their passage (Daly, 1936). The latest hypothesis in the case of the east coast of the United States invokes artesian springs flowing out from the Coastal Plain formations along the continental slope, possibly at a time when this wedge of sediments had a greater westward extent than it has today, and by their long-

continued action producing the present topography largely by solution. Before introducing his new theory, Johnson (1939) gives an excellent account of the whole canyon problem to date.<sup>2</sup>

Whatever their origin, these submerged canyons offer the only available opportunities for getting at the older formations beneath the mantle of Recent veneer, for in places their walls stand as cliffs, steeper than the angle of repose of unconsolidated sediment. The fossiliferous fragments broken from the outcropping ledges indicate that these valleys are comparatively young. This adds to the complexity of the problem, because we cannot retreat into the security of the distant past when called upon for an explanation of their origin. Heavy iron scraper dredges have been successfully employed, in comparatively deep water, both by Woods Hole and Scripps, off the east and west coasts, for obtaining samples from these outcrops. Where the beds are nearly horizontal it is even possible to work out roughly the stratigraphic succession. This serves the double purpose of not only giving some information as to the rocks constituting the continental shelves but also of fixing at least the maximum age of the canyons. On the east coast the formations are all sedimentary, ranging from Upper Cretaceous through the late Pliocene. In texture the different beds vary from indurated sandstones to friable green-sands and compacted silts and clays (Stetson et al., 1936). Cores taken from the bottom of the canyons show a clay, with Arctic Foraminifera, presumably deposited during the last stage of the Wisconsin. The time of canyon excavation can thus be bracketed with fair exactness, and further work will doubtless narrow this span. Mollusks and echinoderms have proved useful in some cases as guide fossils, but Foraminifera have been by far the most valuable. Although the shelf is the submerged extension of the Coastal Plain, the fauna of the sediments at the continental margin differs from that of the emerged portion, and the formations evidently belong to different facies. In some cases there is a curious parallelism with the warm-water fauna of the Mississippi Embayment. The walls of the west coast canyons likewise consist, for the most part, of sedimentary formations, the youngest of which are Pliocene, although in the upper part of Monterey Canyon Shepard has reported granite. Any theory which is put forward to explain the much-disputed question of origin of these extraordinary topographic features must take into account the data which this dredging has afforded, namely, their age and the type of rock into which they are cut. Similar work in the canyons of other continents is much to be desired, in order that

---

<sup>2</sup> Since the manuscript has been completed yet another theory has been added to the list. Bucher (1940) considers that the erosive effect of tsunamis spending their energy against the continental slope may be the most important single factor in producing this maturely dissected submarine topography.

all possible information may be brought to bear on this perplexing and still unsolved problem.

#### PRESENT STATUS AND FUTURE DEVELOPMENT OF SUBMARINE GEOLOGY

As a result of a newly awakened interest, stimulated by the introduction of new techniques, the geological branch of the science is, at present, in a position to make a rapid advance. The foreword to the reports of the *Snellius* Expedition (1938, p. vii) reflects this change of attitude which has taken place both here and abroad.

While in the *Siboga* expedition of 1900, biology stood in the foreground, physical oceanography came only in second place and geology was not included in the program at all; in the *Snellius* expedition the parts were reversed and moreover a prominent place was given to geology.

The application of the geophysical methods has placed within our grasp the means of dispelling much of our ignorance concerning the suboceanic lithosphere, a subject of primary importance to our thinking concerning the structure of the earth. The procedure for measuring terrestrial magnetism and gravity can be regarded as perfected, while that for securing seismological data is rapidly approaching that stage.

The recent advances in offshore surveying methods have so far been applied only to charting comparatively small areas of the ocean floor, but these preliminary results, if they may be so called, have been sufficiently startling to unsettle, in many minds, deep-rooted ideas concerning the relative stability of land and sea, and possibly even the permanency of the ocean basins. For others they have stimulated thought concerning submarine currents and rivers of liquid mud of a type which had never before been considered among the processes of erosion. The study of submarine morphology has thus taken on a new significance.

In the field of sedimentation the emphasis is shifting from a purely areal study of a region to investigations of the sediments in relation to the marine environments which have produced them. The forces governing transportation and deposition are all too imperfectly known, and a clear understanding of conditions of sedimentation in the sea today will go far toward helping the stratigrapher in the interpretation of sedimentary rocks on land. Modern methods of mechanical analysis, largely developed in connection with studies in soil mechanics and foundation engineering, and the statistical treatment of data have been of great assistance in this work. The ability to take long cores is playing an increasingly important part in the study of sediments, and it is possible in many instances to penetrate the mantle of present-day deposition and reach the older formations. It is hoped that in this way at least something of the Pleistocene history of the ocean

basins may be unraveled. When long cores have been obtained from the red clay of the Pacific, where the rate of deposition is extremely slow, it is expected that valuable data will be obtained on the rate of decay of radioactive minerals, which are exceedingly abundant in these clays.

Little enough is known of the clastic sediments—black shales, for instance—but even less is known about the origin of limestone and its corollary, dolomite. Chemistry in relation to marine sediments, both organic and inorganic, and its connection with the processes of diagenesis is a field which has scarcely been scratched. Even the composition of the water contained in the bottom sediments and the part it plays is an unknown quantity. Along these lines the possibilities for future development are practically limitless.

No longer does oceanography have to depend on the outfitting of special expeditions for its continued advancement. As a science it has become firmly established, and the study of the sea in all its phases is now carried out both here and abroad. Not only are numerous laboratories devoted exclusively to this purpose, but many government departments have also made it an integral part of their programs. Using this country as an illustration, the Coast and Geodetic Survey has engaged in charting operations which have proved particularly significant in the field of submarine morphology. The Navy has furnished submarines on several occasions for the measurement of gravity at sea, and the Hydrographic Office is constantly accumulating and publishing deep-sea soundings. The Coast Guard has incorporated the study of the internal dynamics of sea water as part of its work on the ice patrol off the Grand Banks of Newfoundland. The Bureau of Fisheries investigates for the most part ecologic problems which concern the various inhabitants of the ocean but has also taken much hydrographic data. Similar work is being carried out by the governments of all the important maritime nations.

If the greater part of the initiative and impetus for the development of the biological and physical oceanography has been furnished by European countries, America may lay claim to this role in the field of submarine geology. The support which has been, and continues to be, furnished by institutions, learned societies, and government agencies in this country in the form of money, ships, and equipment is a measure of the importance of the problems and of the success which has been achieved. However, after the original impetus has been given, international cooperation is essential if the study is to reach its fullest development. There is every indication that such will continue.

To attempt a list of institutions and bureaus engaged in oceanographic work or to make a complete catalog of present activity in submarine geology is not the purpose of this chapter. The student

desiring such information should turn to a recent publication of the National Academy of Sciences edited by Dr. T. Wayland Vaughan (1937) where these data have been fully compiled, and which also give a bibliography of the serials which are published by the various institutions. The bibliography appended here is only intended to give a person unacquainted with the subject a working knowledge of the literature and to provide a starting point. The purpose of a short sketch of this sort is to trace the rise and development of present-day trends and lines of endeavor in submarine geology and to present a summary of progress, as seen against the background of oceanography as a whole, so that the general perspective does not become distorted.

## BIBLIOGRAPHY

## AGASSIZ, ALEXANDER.

1888. Three cruises of the *Blake*. Mus. Comp. Zool., Bull., vols. 14 and 15.

## AGASSIZ, LOUIS.

1869. Report on deep sea dredgings during the cruise of the U. S. C. steamer *Bibb*. Mus. Comp. Zool., Bull., vol. 1, No. 13, pp. 368-369.

## BIGELOW, H. B.

1931. *Oceanography*. Houghton Mifflin Co., Boston.

## BUCHER, W. H.

1940. Submarine valleys and related geologic problems of the North Atlantic. Geol. Soc. Amer., Bull., vol. 51, pp. 489-512.

## BULLARD, E. C., and GASKELL, T. F.

1938. Seismic methods in submarine geology. *Nature*, vol. 142, pp. 916-917.

*Challenger* EXPEDITION.

Report on the scientific results of the voyage of H. M. S. *Challenger*, 1873-1876.

1885. Narrative of the cruise.

1891. Deep sea deposits.

## DALY, R. A.

1936. Origin of submarine canyons. *Amer. Journ. Sci.*, vol. 31, pp. 401-420.

## DEUTSCHE SUDPOLAR-EXPEDITION, 1901-1903.

1905-1931. Vols. 1-20. Berlin.

*Discovery* REPORTS.

1929-date. Results of investigations made by the *Discovery* and the *William Scoresby* . . . Univ. Press, Cambridge.

## EWING, MAURICE, CRARY, A. P., and RUTHERFORD, H. M.

1937. Geophysical investigations in the emerged and submerged Atlantic Coastal Plain. Geol. Soc. Amer., Bull., vol. 48, pp. 753-802.

## EWING, MAURICE, and VINE, ALLYN.

1938. Deep sea measurements without cables or wires. *Trans. Amer. Geophys. Union*, pt. 1, pp. 248-251.

## GEOPHYSICAL EXPLORATION OF THE OCEAN BOTTOM.

1937. Symposium arranged by the American Geophysical Union. *Proc. Amer. Philos. Soc.*, vol. 79, No. 1, pp. 1-166.

## HERDMAN, W.

1923. *Founders of oceanography*. Longmans, Green, New York.



**JOHNSON, DOUGLAS.**

1939. Origin of submarine canyons. Columbia Univ. Press, New York.

**JOHNSTONE, J.**

1928. An introduction to oceanography. Univ. Press, Liverpool.

**KRÜMMEL, O.**

1907. Handbuch der Ozeanographie, Bd. 1. Engelhorn, Stuttgart.

1911. Idem, Bd. 2.

**MABMER, H. A.**

1926. The tide. D. Appleton and Co., New York.

**Meteor EXPEDITION.**

1932-date. Wissenschaftliche Ergebnisse der deutschen Atlantischen Exped. auf dem . . . *Meteor*, 1925-1927.

**MONACO.**

1889-date. Results des campagnes scientifiques.

1904-date. Bulletin Inst. Oceanographie.

1909-date. Annales, Inst. Oceanographie.

**MURRAY, J., and HJORT, J.**

1912. The depths of the ocean. Macmillan and Co., London.

**NANSEN, FRIDTJOF (editor).**

1900-1905. Norwegian North Polar Expedition, 1893-1896. Scientific results, vols. 1-6.

**NATIONAL RESEARCH COUNCIL, COMMITTEE ON PHYSICS OF THE EARTH.**

1932. Physics of the earth. Vol. 5, Oceanography. Nat. Res. Council. Bull. 85.

**PIGGOT, C. S.**

1936. Apparatus to secure core samples from the ocean bottom. Geol. Soc. Amer., Bull., vol. 47, No. 5, pp. 675-684.

**SCHOTT, G.**

1926. Geographie des Atlantischen Ozeans. Boysen, Hamburg.

1935. Geographie des Indischen und Stillen Ozeans. Boysen, Hamburg.

**SHEPARD, F. P.**

1933. Submarine valleys. Geogr. Rev., vol. 23, No. 1, pp. 77-89.

1934. Canyons off the New England coast. Amer. Journ. Sci., vol. 27, pp. 24-36.

1936. The underlying causes of submarine canyons. Proc. Nat. Acad. Sci., vol. 22, No. 8, pp. 496-502.

**Siboga-EXPEDITION.**

1901-date. Results des Explorations . . . Leyden.

**SIGSBEE, C. D.**

1880. Deep sea sounding and dredging. U. S. Coast and Geod. Surv.

**SMITH, P. A.**

1937. The submarine topography of Bogoslof. Geogr. Rev., vol. 27, No. 4, pp. 630-636.

**Snellius EXPEDITION IN THE EASTERN PART OF THE NETHERLANDS EAST-INDIES 1929-1930.**

1933. Vol. 5, pt. 2, Geology of coral reefs.

1934. Vol. 2, Oceanographic results; pt. 2, Soundings and bathymetric charts.

1935. Vol. 5, Geological results; pt. 1, Geological interpretation of the bathymetric results.

1938. Vol. 1, Voyage.

**STETSON, H. C., STEPHENSON, W. L., BASSLER, R. S., and CUSHMAN, J. A.**

1936. The geology and paleontology of the Georges Bank canyons. Geol. Soc. Amer., Bull., vol. 47, pts. 1-4, pp. 339-440.

## THOMSON, C. WYVILLE.

1873. The depths of the sea. An account of the dredging cruises of *Porcupine* and *Lightning* during the summers of 1868, 1869, and 1870. Macmillan and Co., New York and London.

1877. The voyage of the *Challenger*. Macmillan and Co., London.

## TRASK, PARKER D. (editor).

1939. Recent marine sediments: A symposium. Amer. Assoc. Petrol. Geol., Tulsa.

## UNITED STATES COAST AND GEODETIC SURVEY.

1844-date. Reports of the Superintendent (now Director).

## VAUGHAN, T. WAYLAND, ET AL.

1937. International aspects of oceanography. Nat. Acad. Sci., Washington.

## VEATCH, A. C., and SMITH, P. A.

1939. Atlantic submarine valleys of the United States and the Congo submarine valley. Geol. Soc. Amer., Spec. Pap. No. 7.

## VENING MEINESZ, F. A.

1930. Gravity expeditions at sea 1923-1930. Vol. 1, The expeditions, the computations and the results.

## VENING MEINESZ, F. A., UMBGROVE, J. H. F., and KUENEN, PH. H.

1934. Gravity expeditions at sea 1923-1932. Vol. 2, Report of the gravity expedition in the Atlantic of 1932 and the interpretation of the results.

## THE OCEAN CURRENT CALLED "THE CHILD"

---

By ELIOT G. MEARS  
*Stanford University, California*

---

[With 2 plates]

Every year about Christmas time, a hot current swings inshore along southern Ecuador and northern Peru. Because this is the season of the Christ Child, the devout inhabitants of the region have named it "The Child" (El Niño). Its location, and that of the great Humboldt (Peru) Current, are shown on the accompanying maps.

Ordinarily the coasts of southern Ecuador, Peru, and northern Chile are dry; they even lack sufficient quantities of drinking water. This aridity is due to the usual dominance the year round of the cool Humboldt Current. The Humboldt is cool because of the almost continuous upwelling near shore. The California Current is cool for the same reason in summer, the season when California is also dry. Except when a warm stream or wedge invades or pushes its waters away from the shore, the area affected by the Humboldt Current is arid throughout the year.

To inhabitants of both land and sea, the unforeseen intrusion of hot sea water is a phenomenon with extremely disastrous consequences, for people and property located on this section of Pacific South America are habitually protected from dry but not from wet weather. Their houses are built largely of adobe bricks made from native clay and grasses. Their water supply comes chiefly from the melting snows in the high Andes, or from the fog and mists of the coast ranges. Their farms are situated in the river valleys and on the sides of slopes laid out in numerous terraces. Their railroads are placed along or across these elevations. In short, here is a desert economy in a region of pronounced land relief.

So long as the northward-flowing Humboldt Current with its upwelling remains continuous and strong, kept so by south and southeast winds, and while the equatorial low-pressure area keeps its accustomed place along the Equator, difficult weather problems in Peru and northern Chile do not exist. There are no storms. In-

deed, more than a century ago the storm-free character of the region so impressed Alexander von Humboldt, for whom the current was named, that he advised ships proceeding in this general region to sail along this coast whenever possible.

The absence of thunderstorms is exceedingly noteworthy. For the Humboldt Current flows into the Tropical Zone in northern Peru, and to the Equator itself in the Galápagos Islands. Equatorial latitudes are supposed to be the worst in the world for thunderstorms. Indeed, directly across the Pacific in Java is found actually the most thundery portion of the earth. So the contrast is striking.

The explanation is that along this eastern South Pacific coast the Humboldt Current acts as a water- and air-conditioner. Except for the aridity, the climate has no extremes. It is always cool, but never cold. It is like coastal California in summer. It is foggy and often misty in the hills, yet rain occurs seldom. The climate varies scarcely at all from the inward seaward edge of the Humboldt Current to the crest of the coast ranges. It is more or less the same, also, from where the current starts near Valparaiso, Chile ( $33^{\circ}$  S.,  $73^{\circ}$  W.), to approximately Talara, Peru ( $4^{\circ}$  S.,  $81^{\circ}$  W.).

Flowing from south to north, the Humboldt Current is the feature which makes the weather approximately the same for a distance of 2,500 miles. This vast marine river extends some 100 miles in width in Chile to 250 miles off Peru, where it turns from the continental border seaward. West of southern Ecuador it continues its normal character to the Galápagos Islands, 600 miles away. The numerous bare and rocky islands within this vast stretch afford ideal nesting sites for uncounted millions of cormorants, penguins, and other similar fowl.

The wise people along shore protect this oceanic life, and have done so from prehistoric times, except for a half century when foreigners interfered. The birds repay their human benefactors with huge deposits of the richest fertilizer on earth—guano. The ancient beds provided many fortunes in the latter half of the nineteenth century. Recent and accumulating stores, the result of highly constructive conservation practices, will insure permanent fertility to the soil in the neighboring fields. Indeed, it is because of guano that the nearby land areas have maintained a high productivity for more than 1,000 years of intensive cultivation.

The fertilizer manufactured by the birds is the result of the gormandizing on the enormous fish population in the surface waters of the Humboldt Current. Although fishing is a profitable industry to the fishermen of the countries adjoining, no systematic exploitation of the valuable aquatic resources of Peru has ever been made, except by the birds.

The Humboldt Current carries to the Equator a cool temperate climate, and the region is noteworthy for the absence of tropical diseases as well as tropical storms. Consequently the inhabitants of this part of the Tropics are unaccustomed to the features usually associated with such regions and are unprepared to cope with them; they regulate their lives largely upon the course and force of the Humboldt Current. Their faith is usually justified. But occasionally a violent year like

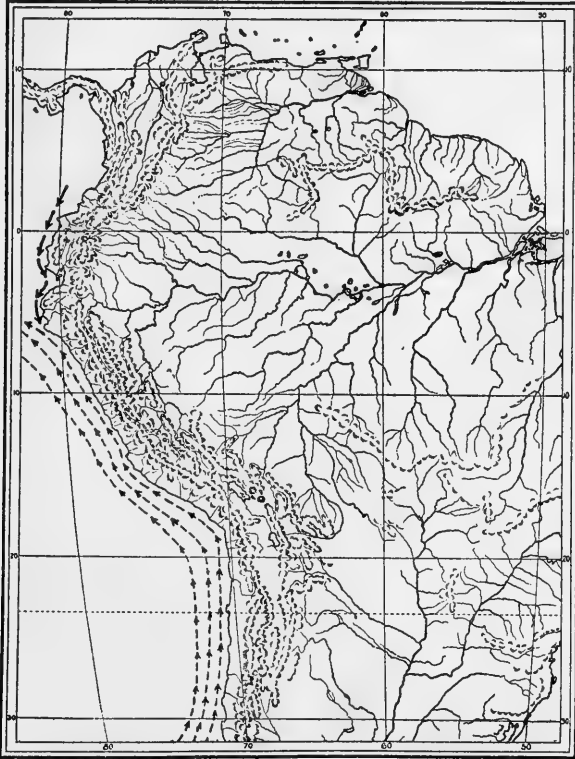

FIGURE 1.—Invasion of warm waters from the north (commonly called El Niño) during average year (southern summer).

Warm waters of El Niño ———→ ———→ ———→ ———→  
 Cool waters of the Humboldt — - - - -> - - - - -> - - - - -> - - - - ->

1891 or 1925 appears on the calendar. Then the northward-flowing Humboldt Current is abruptly either pushed aside or covered up temporarily by the southward-rushing El Niño. In 1925 disturbances were reported as far south as Valparaiso; in 1941, as far as Pisco ( $12^{\circ}$  S.,  $76^{\circ}$  W.); or thereabouts.

Wherever El Niño goes, both air and sea water become tepid. The cool-water life in the Humboldt Current, consisting of birds as well as fishes, migrates or dies. In 1925 the entire coast line was strewn

with the dead from the sea. On land, swarms of mosquitoes, flies, and other insects infested the country. All living creatures suffered from the intense heat. Furthermore, tropical diseases afflicted the population.

Worse still, the normally storm-free region was visited by violent thunderstorms, cloudbursts, and other torrential rains throughout the entire length of El Niño's extension. The Chanchan River is said to

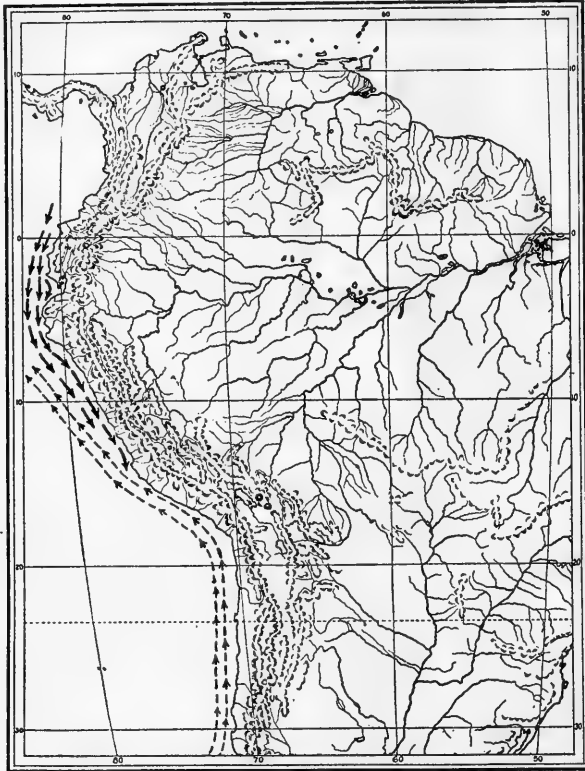

FIGURE 2.—Invasion of El Niño into the Humboldt Current area in 1941 (southern summer).

Warm waters of El Niño ———→ ———→ ———→ ———→  
 Cool waters of the Humboldt - - - - -> - - - - -> - - - - -> - - - - ->

have risen 18 feet in 1 day. The famous inscriptions at Chan Chan, which had remained little changed for more than four centuries, were almost obliterated. Railway lines were washed away.

In 1939 even a part of the foundation of the international highway bridge in northern Peru was swept off with the flood. A creek that usually could be waded had to be crossed in a basket attached to a cable. The adobes crumbled. Streams drowned entire valleys or overflowed their banks. Crops in the lowlands, where most of the

agricultural production takes place, were ruined. The rich soil was carried out of its place, and rocks, boulders, and debris left in its stead. This meant that when the weather conditions became stable, the farmers had to clear away the wreckage, replace the soil, and provide seed beds for next year's crops.

Strangers, unfamiliar with these unique conditions, ventured the belief that the inhabitants would have bumper crops on the usual desert lands, for the unusual abundance of moisture had produced a record rank growth in an astonishingly short time. This prophecy was borne out, for in recent deluges the inhabitants have taken advantage of the excessive precipitation by erecting temporary fences to protect their excellent harvests. However, it is apparent that these farms on the open desert are of sporadic value only. Lands that yield once in many years naturally do not have the same importance as those that produce unflinching year after year during the season, or, in some localities, all the year around.

Permanent benefits of the visitations from the Child Current are decidedly minor in any attempt to balance the enormous disasters that accompany it. One favor it leaves in its wake is drinking water in the ancient reservoirs of southern Ecuador and part of northern Peru, although, it should be added, in Peru much safer water is obtained from the melting snows of the eastern mountains. Furthermore, the rich sea pastures of the Humboldt Current benefit by the action of the rains in washing down these occasional huge additions of fertilizing material.

Also, although El Niño drives away swarms of cool-water fish, it transports numerous warm-water species to take their places, at least in part. In 1939 and again in 1941 the tuna, which rarely are seen beyond the border of the cold current, were observed near Callao ( $12^{\circ}\text{S.}, 77^{\circ}\text{W.}$ ). Indeed, in 1941 they were caught among the rocks of the port and were plentiful.

Every year, in the southern summer, El Niño approaches Capo Blanco ( $4^{\circ}\text{S.}, 11^{\circ}\text{W.}$ ) or Punta Aguja ( $5^{\circ}\text{S.}, 11^{\circ}\text{W.}$ ) with storms and their accompanying features. Between 1925 and 1941 only twice did the hot current go beyond these two bulging, westernmost points of the South American continent. Farther southward, invasions occurred in 1932 and 1939. It seemed that the old tradition of a 7-year cycle was being substantiated. The local inhabitants were well pleased to be able to anticipate the disasters at certain definite periods.

Then came the invasion of 1941 in northern Peru, only 2 years after the heavy downpours during 1939. The floods of 1941 were much more generally extended than those of 1939; likewise the heated waters of El Niño from shore seaward were more widely spread out. In 1939 its waters were kept away from the shore line south of about

Punta Aguja by a narrow band of cooler water. In 1941 such a band did not exist. Not only did the rains of 1941 prove disastrous to crops, buildings, birds, fish, and local industries, but, even more important, they upset the sense of security associated with the reputed 7-year cycle. For the Child Current in 1941 was not observing the rules; it was cheating with an unexpected, off-schedule call which spelled uncertainty regarding the forecasting of future invasions.

Many attempts have been made to explain the vagaries of El Niño. Both the sun and the moon have been named as Nature's accomplices. Sun-spottedness or lunar tides in the Antarctic have been blamed for the behavior of this turgid, hot current. Other explanations offered center nearer home, notably the southward shift of the low-pressure area along the Equator and its subsequent retreat southward of the South Pacific High off the coast of Chile. During unusual extensions of the Child Current, declining strength of winds from the south and southeast have been noticed, and northerly winds across Panama may have some effect at this season. It is noteworthy that northerly winds often precede or accompany El Niño's abnormal movements.

The current has been identified definitely as a branch of the Equatorial Counter Current, which normally either turns northward or recurves westward before reaching Panama. It joins up with the broad streams of the North or the South Equatorial currents. The Equatorial Counter Current, it is well known, enjoys an abnormally high marine temperature because it flows directly under the heat equator across the entire width of the Pacific Ocean, approximately at its most widely separated points.

Why the branch El Niño is sometimes hotter and stronger at some places than at others has not been satisfactorily explained. In 1939, for instance, the heated current, appearing in the form of bands or strips, was marked by a considerable range of temperature over a relatively small area. Some of these bands were hotter away from land than close inshore; and vice versa. At the same time it was observed that upwelling along shore in the Humboldt Current became weak or tended to cease altogether. Since the Humboldt and California Currents are "mirror images" of each other during the season of upwelling within the California Current (as already stated, normally there is upwelling within the Humboldt Current throughout the year), the most plausible explanations may be gleaned from further research applied to the northern stream.

It is known, for instance, that there is a relatively warm subsurface coastal current flowing in the opposite direction from the Humboldt, and a similar counter subsurface current continually runs under the California Current. When upwelling ceases off the California coast, this subsurface current rises and flows inshore at the surface as



well as underneath. The writer continues to surmise that when winds, atmospheric pressure belts, and other phenomena cause a ceasing or a tendency to cease in the Humboldt Current upwelling, perhaps the subsurface counter current underneath tends to rise to the surface in a similar manner. When its rise occurs near or at the boundary line of the Humboldt, the subsurface current carries with it the hot surface water of the equatorial region.

In other words, it appears likely that El Niño is the counterpart of the Davidson Current along the California shore, except that the Davidson is never a hot current. The Davidson Current originates within the cooler Temperate Zone.

We know that "The Child" comes every year to Pacific South America shortly after Christmas. We know where it comes from and the general direction of its travel. How vigorous and active it may be cannot be foretold with any certainty. The traditional and still popularly accepted 7-year cycle no longer constitutes a sure basis of reckoning. The southernmost extension of its migration is another uncertainty. Someday we shall be better informed about the ranges and vicissitudes of this oceanic mystery. Until then, we can at least recognize the overshadowing importance of one of Nature's most powerful forces in dominating a relatively unknown part of the Western Hemisphere.

1914

Department of the Interior  
Bureau of Land Management  
Washington, D. C.

Department of the Interior  
Bureau of Land Management  
Washington, D. C.

Department of the Interior  
Bureau of Land Management  
Washington, D. C.



1. A GENERAL VIEW OF GUANO-GATHERING OPERATIONS, PERU.  
Photograph from Pan American Union.



2. RUINS OF CHAN CHAN, NEAR TRUJILLO, PERU.  
Photograph from Pan American Union. Courtesy W. R. Grace and Co.

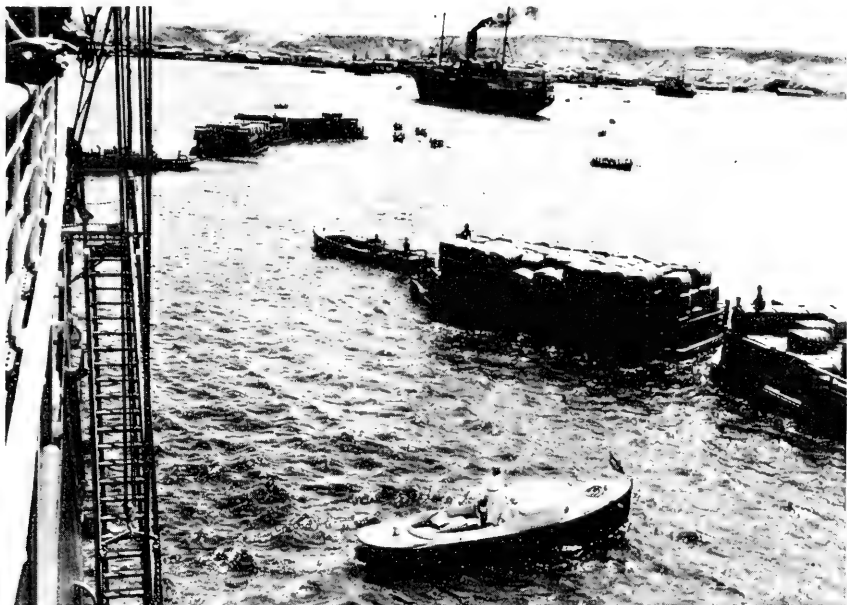

1. LOADING COTTON AT PAITA, PERU.

Photograph from Pan American Union. Courtesy Grace Line.



2. PORT WORKS, CALLAO, PERU.

Photograph from Pan American Union. Courtesy Frederick Snare Company.

# MAPS, STRATEGY, AND WORLD POLITICS<sup>1</sup>

---

By RICHARD EDES HARRISON

*Cartographer*

and

ROBERT STRAUZS-HUPÉ

*University of Pennsylvania*

---

[With 5 plates]

Geography is the study of the earth, its regions, and, more particularly, the relationship of one region to another. Maps are tools for the study of geography.

If the earth were flat as a table top, there would be few problems in map making. Each item of geographical interest could be shown in true relationship to any other item since the map, like a table top, is a plane and, hence, two-dimensional. The earth, unfortunately, is a round solid. Map making is mainly concerned with the problem of representing three dimensions on a two-dimensional piece of paper. Consider a globe—it represents the world in all respects, distances, areas, directions, shapes; this it does because it is a three-dimensional scale model. If a globe had a skin, it would be impossible to peel it off and flatten it into any single shape without splitting or stretching it. How to perform this operation is the dilemma of map making. The greater the extent of the sphere's surface depicted by the map the greater is the distortion, and the smaller the extent of the surface the smaller the distortion. In large-scale tactical maps it shrinks almost to the vanishing point but it is present, nevertheless. In an area large enough to show a perceptible curvature of the earth, the distortion becomes an appreciable factor. It reaches a maximum when we attempt to depict the whole earth on one map.

This difficult art of trying to represent the impossible is called cartography, and the devices by which cartographers attempt to show a round surface on a flat and generally rectangular piece of paper are called projections. Map making through the ages has necessarily limited itself to controlling distortion, so that one of the four properties—distance, direction, shape, or area—is shown correctly at the

---

<sup>1</sup> Reprinted by permission from the *Infantry Journal*, November 1942.

expense of the others, or to achieve the best compromise among them without any one being mathematically true. For example, a map on which all areas are shown in true relative size (called equal area) is bound to have distortions in shape, distance, and direction. In some, two properties can be satisfactorily combined, as for example in the azimuthal equidistant map. This is so constructed that from its central point direction and distance are true to any other point, but a nonradial distance is more or less seriously out of scale. (The term "azimuthal" is typical of the obscure terminology of cartography. In the case of maps it simply means radial, or as the spoke of a wheel.) The well-known Mercator map has the remarkable property of showing both true compass directions (but not the great circle directions) and true shape. The size of areas and distances, however, are highly misleading.

Perhaps the question most frequently asked of cartographers is, "What is the best world map?" The question goes to the heart of the cartographer's problem for the answer is "There is no such thing as the perfect map." One can pick out a "best" map for a given purpose, but that map will not satisfy other requirements. For example, the density of population is measured by the number of people inhabiting a specific area and should be shown on an equal area map, for to show it on a map where unit areas differ would introduce another variable making the study of relative density valueless. Where true compass direction between points is required (as in navigation), we must use Mercator; where great circles (the shortest distance between two points on the globe) is the object of study, we must use the gnomonic projection which is unfortunately limited in scope to less than a hemisphere. To measure distances accurately we must have recourse to the globe or use cumbersome methods for translating these distances from different projections. In fact, all these questions can best be studied on a scale model of the earth. Only a scale model is proportionately accurate in all respects—provided it is accurately made. Unfortunately the globe has disadvantages too. One can see less than half of it at a given moment; it is bulky; it is expensive. A fine collection of good detailed maps or a first-class atlas can be purchased for the price of an 18-inch globe. But a globe is the one and only corrective for the distortion present in all maps.

Selecting a world map on which to study strategy or the geography of war is practically an insuperable problem. For strategy demands geographical truth—distances, directions, and areas must be pretty close to scale because when they are true it follows that geographical relationships in general are true. This is, however, impossible in any kind of world map.

The search for a compromise solution has led to many ingenious projections, but for strategy we still have to revert to the globe. One way of approximating true geographic relationship is to decide what part of the global area is of least interest and select a projection which tends to lump the distortion in that area. Thus the "center of remoteness" from the war and its connecting lines is at or very near the South Pole. In fact, from the South Pole to the thirtieth parallel south of the Equator is an enormous area, nearly one-third the earth's surface, in which no engagement of importance has been fought and which supply lines touch only peripherally. To banish the distortion into the "inactive" area, we center the map on the opposite, or North Pole, and make linear scale true along radii from its pole along the meridians. This is called—in the semantics of cartography—the North Polar azimuthal equidistant projection and is, in spite of its name, a pretty good map for global strategy. At least it has the prime advantage of showing continuity of the main land areas involved in the war.

From the Pole to within  $20^\circ$  of the Equator there is remarkably little distortion on this map. This area contains all the major world powers, all the major fighting fronts, except the Southwest Pacific islands, and most of the supply lines. The Mercator projection which for centuries has had an iron grip on the naval, military, and teaching professions, divides its distortions equally between the North and South Polar regions and is true on the Equator only. Owing to the construction of the Mercator projection, the regions immediately adjacent to the Poles cannot be shown at all, since they fade into infinity. Yet, because of the Mercator's usefulness in navigation, most seafaring men have come to think of intercontinental relations mainly in terms of Mercator. Mercator's world is the world of sea power.

Politically ours is a Northern Hemisphere world. For 93 percent of the world's population and about 75 percent of the world's habitable land lie in northern latitudes. Modern history has been made in the northern latitudes. The power centers of the world are situated  $40^\circ$  or more north of the Equator. London, Berlin, Tokyo, and Moscow lie from 900 to 1,500 miles closer to the North Pole than to the Equator. Obviously a map whose maximum accuracy is at the Equator (like Mercator) cannot be expected to show the interrelation of the centers of power in North America, Europe, and Asia. This relationship can be rendered most successfully on one of the polar projections.

The map reader need not be misled by the distortions of a particular map; it is only necessary to note the specific distortion and make the proper visual correction. The main pitfall to avoid is the continual

use of one map, for the mind is inexorably conditioned to its shapes. It begins to look "right" and all others "wrong." There are some examples of how this conditioning has produced false notions of geography. Example number one is provided by the Pacific war area. The Pacific is so large that any map of the entire ocean must have considerable distortion, but for generations we have depended almost exclusively on the Mercator projection. Similarly, the interrupted homolosine projection, devised by the late Chicago Prof. Paul Goode, sacrifices the polar regions to distortion. Its greatest accuracy lies in the zones of the world's great shipping lanes and, hence, in the areas of naval strategy as conceived in the nineteenth century. Now both the United States and Japan lie on the fringe of Mercator's and Goode's area of reasonable accuracy, and the shortest line between them goes far above this area from Seattle across the Alaska Peninsula and curves above  $55^{\circ}$  N. before swinging southwestward along the Kurile Islands to metropolitan Japan. A few miles south of this line lies that too-long neglected bastion of North American defense, Dutch Harbor, while 2,300 miles south of that is Pearl Harbor.

Pearl Harbor, in fact, lies on a line between San Francisco and Australia, and could only be called a flank defense by one familiar with the globe. Alaska, on the other hand, offers a jumping-off place for all the shortest routes from the United States to Asia, Japan, Siberia, China, India. For example, from the midwestern industrial center of the United States to Chungking, as flown by our ferry command across the South Atlantic to Lagos to Khartoum to Karachi, and so on, is more than 12,000 miles; by way of Fairbanks and Siberia about 8,000 miles. On Mercator the 12,000-mile jaunt looks reasonable enough. But the direct air route New York-Chungking (which passes close to the North Pole) is difficult to trace on the Mercator projection, as on this map it would go vertically off the top of the map near western Greenland, reappear above the central coast of Siberia and drop directly south to Chungking.

Example number two is provided by the Atlantic theater of war. Both New York and London lie in the area of sharply increasing distortion on Mercator. The great circle route between them reaches the fifty-third parallel. Hence the earlier perplexities of Anglo-American relations. Hence also the widely held misconceptions of the Arctic, which is not a stagnant, impassable waste, but a fluid, practicable pathway of the Atlantic. In fact, the Mercator mind blankly abandons the Arctic to infinity while it faithfully records the true proportions of the jungles of equatorial Africa, Amazonian rain forests, and the deserts of the Arabian peninsula. The Arctic is not only a branch of the Atlantic but provides a back-alley access to the Pacific. To be sure, ice blocks it for half of the year, but the savings in time



and distance mark it still as a potential traffic lane. For example, the distance from North Atlantic naval bases to the Bering Sea by way of the Northwest Passage is less than half what it is by way of the Panama Canal.

The importance of Iceland has been long recognized by the British and American commands. A glance at an Arctic map reveals the Norwegian coast as the only Axis frontage on the Arctic basin. The importance of a northern all-year route is shown by the figures: New York-Moscow via Murmansk, 5,300 miles; New York-Moscow via the Persian Gulf, 14,400 miles. This is not to suggest that the southern route be abandoned, for this route has the great advantage that supplies delivered at the head of the Persian Gulf can be distributed on comparatively short notice to several different fronts, the Russian, Egyptian, Syrian, and Indian.

Example number three of thought conditioning by maps we can find on our home continent. Our eastern and western seaboard are far more conscious of danger from Axis bombing, yet Todelo, Detroit, Duluth, and Winnipeg are as close to Nazi-held Norway as Norfolk, Va.

Salt Lake City, all of Montana and Idaho, part of North Dakota and Winnipeg are as close to Japanese air bases as Los Angeles. If either Axis partner were to establish advance bases in Greenland or Alaska, most of the Middle West would be in as great danger as the seaboard. Here again are facts not revealed on most of the maps in common use.

We have pointed out that all maps must be misleading in themselves, but use of a map even with knowledge of its limitations can also produce misleading conceptions of geography. Continual use of a given map in a fixed position results in dulling of perception. For example, the Mercator projection shows us with perfect accuracy the north-south geographical relation, yet most people are skeptical when told that all of South America lies to the east of Savannah, Ga. By looking at a Mercator wall map with the aid of a mirror, the true relation is made plain. The shapes on the map, of course, have not changed, they are merely reversed, and in the reflected image the immense eastward sweep of the coast from Brownsville to Natal is startlingly revealed. It is useful to turn maps upside down, or point them in a direction which might represent the point of view of an individual or a nation, as for example a Briton's view of the continent, or Hitler's view of the Middle East. This practice is recommended in defiance of the rooted conviction of the cartographer that north must always be at the top of the page. The globe has no "top."

The assault on map traditionalism has been led mainly by American magazines and newspapers in their search for visual aids to

reports from the theater of war. The North Polar equidistant projection, for example, had hardly ever been used as a world map since Cassini (1696). After its reappearance in a leading national monthly, it has become increasingly popular with magazines and newspapers. Another case is the even older orthographic projection. This map has remarkable visual properties and its neglect is one of the major mysteries of cartography. A series of orthographics recently published provides in four maps a good and inexpensive substitute for a 20-inch globe. In the increasingly popular conic projection—the cone having been laid tangent to the forty-fifth parallel of latitude north—the battlefields of south Russia are very nearly true to scale.

Many college geographers now realize that the United States has been lagging far behind other nations—the British and notably the Germans—who not only produce large quantities of maps but pound away at geography and all its lessons, political, economic, and military, throughout all grades of schooling. American cartography is now meeting this challenge with boldness and ingenuity—particularly as regards the representation of large areas. German map making—profuse in detail and meticulous in execution—has largely stuck to conventional projections, and Mercator's hold on German cartography may account for some German misconceptions as regards the strategic position of the United States and the Soviet Union. By contrast, American cartography now leads in the imaginative use of those projections which show large areas and true distances, and thus are best suited for teaching the new geography of international air communications.

The psychological isolationism of the United States, be it said in conclusion, can be in large measure traced to our failures in map making and the teaching of geography—the prerequisites of education in international relations. The world is round. By the skillful presentation of its "roundness" strategic realities are made clear.

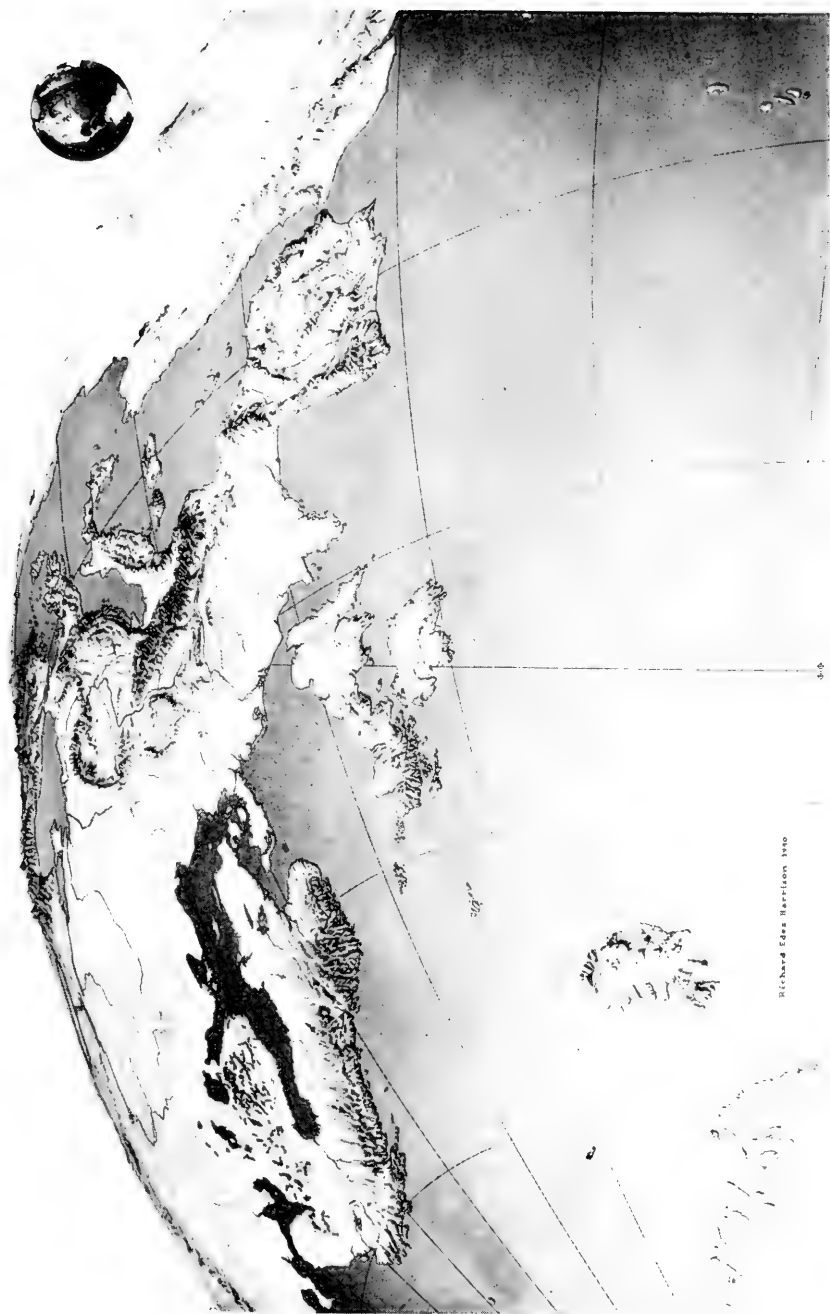

EUROPE SEEN FROM A POINT IN THE STRATOSPHERE ABOVE THE MOUTH OF THE ST. LAWRENCE RIVER.



MERCATOR PROJECTION.

The cylinder is wrapped around the globe tangent to the Equator. Distortions which increase as polar latitudes are approached result from straightening out the curved meridians.

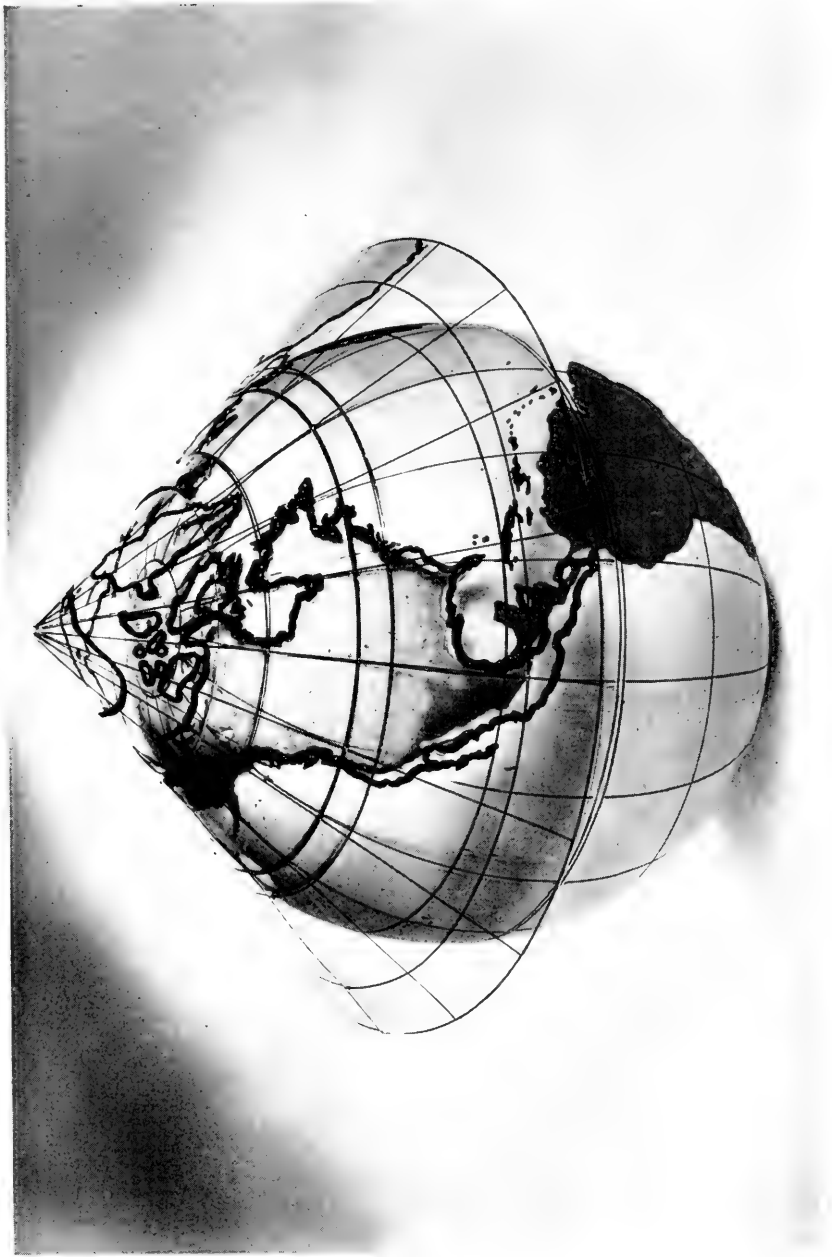

## CONIC PROJECTION.

The cone is wrapped around the globe tangent to the  $O$ , tangent of latitude, with the vertex of the cone on the extension of the polar axis. The meridians become radiating straight lines on the map, and the parallels become circles. The radial scale is then adjusted to make equidistant parallels on the globe turn into equidistant circles on the plane map. Thereby the pole itself is represented by an arc of circle instead of a point. There is, in consequence, no simple center of projection, but rather a center for each parallel of latitude.

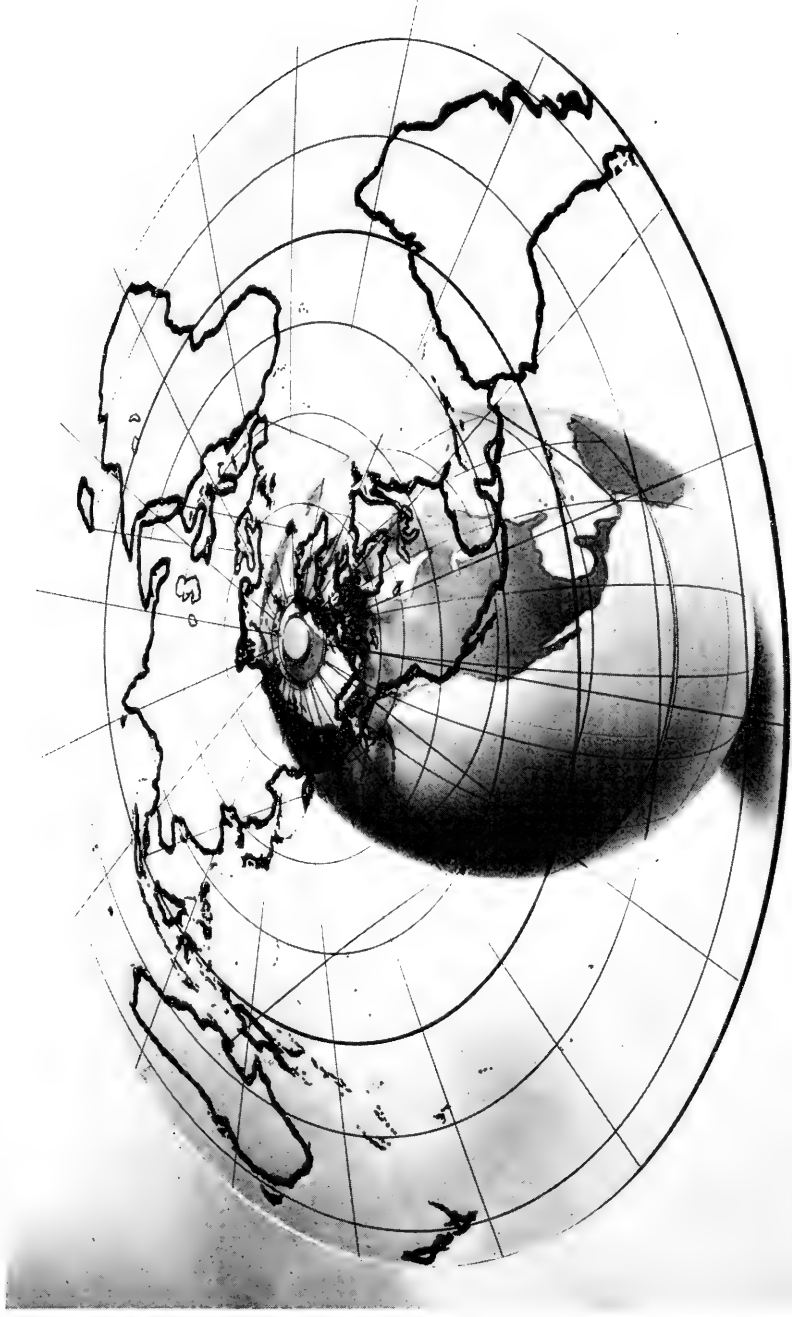

NORTH POLAR AZIMUTHAL EQUIDISTANT PROJECTION.

As in the case of the Mercator projection, there is no single center of projection for all latitudes, but a different center corresponding to each different latitude. The scale of the parallels of latitude is enormously stretched as the South Pole of the map is approached.



ORTHOGRAPHIC PROJECTION.

In this case the center of projection is at infinity, and the projecting lines all fall perpendicular to the plane of projection. The oblique case is like a picture of the globe and recommended for its visual qualities. Yet the scale is true at the center and along any concentric circle. Distortion increases toward the peripheries





# THE NATURAL-HISTORY BACKGROUND OF CAMOUFLAGE<sup>1</sup>

---

By HERBERT FRIEDMANN

*Curator, Division of Birds, U. S. National Museum*

---

[With 16 plates]

## INTRODUCTION

If we look up the word "camouflage" in a standard dictionary, we find it defined as concealment by disguise. The disguise may be of such a nature as actually to simulate the immediate background or merely to break up the outline or reduce the visible solidity of the object camouflaged. When man tries to camouflage an object, he is literally disguising it; in nature on the other hand, the "disguise" is the normal coloration and is so termed because it has the effect, without effort, that man consciously aims for in his attempts. Although the word "camouflage" did not come into common usage until the time of the last war, the application by man of the ideas involved dates far back into antiquity. Based originally upon his observation of its occurrence in nature and its relative effectiveness under varying circumstances, it has been adapted by man to his own purposes. So far, these purposes have been chiefly related to warfare, although, to a lesser extent in civilized societies and to a somewhat greater one in primitive peoples, camouflage has been applied to such activities as hunting and fishing as well.

The essential elements involved in camouflage are those of concealment and surprise. Concealment, to use military adjectives, may be either defensive or offensive (i. e., the value may be to render a prospective victim safe by its invisibility to a predaceous enemy, or it may render the marauder invisible from, and thereby help it to capture, its intended quarry). Most wild creatures live in constant danger from enemies or are themselves ever on the alert for prospective prey. They do not know the comparative peace and security of our peacetime civilized lives. It is, therefore, not surprising to find animals of all sorts exhibiting countless types and degrees and variations of such

---

<sup>1</sup> Reprinted from Smithsonian War Background Studies, No. 5, Publ. 3700, December 11, 1942.

concealing adaptations as are implied by the term "camouflage." One of the fundamental factors in the lives of wild creatures is the combat between species (for food primarily, one feeding on the other or competing with it for a common food supply), generally referred to as the struggle for existence. The problem of self-preservation in nature is very real, ever present, and often so difficult to cope with that some species appear to be numerically limited by it to a very marked degree. As has been emphasized recently by Cott (the *Royal Engineer's Journal*, vol. 52, p. 502, 1938), the vital—

\* \* \* urgent nature of this \* \* \* problem of self-preservation is reflected in the variety and specialization of Nature's adaptive experiments in offence and defence. For instance, we see evidence for this in \* \* \* speed, on land, in the air, and under water, by pursuer and pursued; in the use of stealth and surprise, of deception and ambush; in the display of warning signals, or of alluring baits; in the elaboration of smoke screens, traps, nets, and parachutes; in retreat obtained by burrowing underground, or by the adoption of nocturnal habits; in the development of poison, and of deadly apparatus in the form of fangs or stings for its injection into the bodies of enemies or prey; in protection afforded by plated or spiny armor; and in the use of chemical warfare which is practised, for instance, by certain insects; and of poison gas, by creatures like the skunk.

Of all these various adaptations—which it will be noted each have their parallel in the paraphernalia of modern warfare—perhaps none is so important, so widely distributed, or so perfect as that which renders animals inconspicuous, and often well-nigh invisible, in their natural surroundings.

He even goes so far as to say that—

\* \* \* concealment appears to have been one of the main ends attained in the evolution of animals. And although in most spheres of modern warfare man has now (though in some cases only recently) advanced far ahead of the animal creation in his equipment for protection and aggression—in regard, for instance, to the development of armor and mobility, to the use of projectiles and of devices such as the balloon barrage (which in principle is "a gigantic spider's web"), smoke screens (which are used with effect by cuttle-fishes who dart for safety behind a dense cloud of sepia), and of instruments such as range-finders and sound-detectors and the like—the case of camouflage is an exceptional one.

During the last war camouflage was developed extensively along such lines as dazzle-painting of ships to break up their mass and render their outlines less definite and less recognizable, of splotch-painting of field artillery pieces to simulate their surroundings, and of lightening those parts of objects that were usually in shadow to reduce the visual solidity of the objects involved. On the whole, it may be said that the bulk of the camouflage work done was to create concealment from ground level or at least from fairly low levels. Concealment from high above was relatively less important then than now. However, with the present enormous development in aerial warfare and the ever-increasing use of the air arm in both military and naval operations of all

kinds, the problem of effective concealment has come to resolve itself more into concealment at a distance or from a height than from nearby. It is probably no exaggeration to say that military camouflage has a greater and more vital importance now than it did in previous wars. Coincident with this increase in its use in warfare, there has been a growth of interest in the subject on the part of the public in general. Military camouflage, particularly with respect to its new developments and discoveries and applications, is necessarily a secret of the armed forces. But the natural-history basis of all this work may be here outlined for the interested reader.

The modern study of concealment and disguise in nature may be said to date from the work of the American artist-naturalist, Abbott H. Thayer. His first paper, originally published in an ornithological journal, *The Auk*, in 1896, was given wide distribution to scientific circles generally in the following year in the annual report of the Smithsonian Institution. First among our scientific institutions to recognize the theoretical and potential significance of this work, the Smithsonian has ever since followed with critical interest the unfolding of the subject. In 1909 Thayer brought together in definitive form his discoveries, ideas, and observations in a stimulating book entitled, "Concealing Coloration in the Animal Kingdom," which has served as a basis for all subsequent work and which is still useful and interesting in spite of subsequent data. Parts of it have been modified or even negated by more recent studies, but on the whole it still serves as a good introduction to the subject. The most recent comprehensive book on the topic is Cott's "Adaptive Coloration in Animals," published in 1940. This book has very extensive literature references and may be consulted by the reader interested in details beyond the scope of a general paper such as the present one.

As Thayer first pointed out, in order to discuss intelligently the importance of distinguishability (i. e., the degree of possibility of being seen) in the lives of animals, we must remember that it is at the crucial moments, when they are on the verge of catching or of being caught, that sight is commonly the indispensable sense. Smell and hearing may lead an animal toward its prey or away from its enemy, but in the last all-important seconds, sight is relied on almost entirely in many animals. It is for these moments that animals have most need of concealing coloration, and for which, on the whole, their coloration is often best adapted, and when looked at from the point of view of the potential victim or the potential enemy, as the case may be, often proves to be what Thayer terms "obliterative." It should be stressed at the outset that not all animals are concealingly colored, but this does not affect the interest in, and suggestive value of, those cases where they are. Overzealous students of animal coloration, especially the pioneers, have

at times overstated their exposition of the subject by applying their ideas too widely and by insisting too much on one general explanation to cover all cases. The fact that the camouflaging of animals is not successful at times is not entirely a negation of the camouflaging effect of their coloration but may be due to the fact that other senses, such as smell, are not affected by the visual results of concealing coloration, and offset or render futile the best that camouflage can do.

#### OBLITERATIVE SHADING

The immediate surroundings in which animals are found are naturally very variable in such matters as vegetation, amount of light, type of earth (whether rocks, gravel, sand, or bare earth are visible, or if everything is covered by leafage), and consequently the patterns needed for effective concealment are equally diverse. There is, however, one underlying factor common to animals in all of these backgrounds to a greater or lesser extent. It is this: regardless of its particular color pattern, to become relatively invisible an animal must lose its appearance of solidity, or, to put it in other words, must not apparently cast a shadow on itself. The light falling on an animal usually comes from one direction, generally from above, so that some parts of the animal (usually its back) are in stronger light and the opposite parts (usually the underside) are in dimmer light or even in the shadow of the illuminated parts and tend to look darker. This is easily seen by placing a white ball on a table with the light coming from above—the under surface of the ball is shaded and at once reveals the spherical solidity of the ball, even though it be placed on a white table. In most animals the light and dark tones are so arranged that they somewhat counteract the effect of self-shadowing. This is brought about by having the darker tones where the light strikes (usually from above) and the paler tones on the parts in shadow (usually the lower parts). In other words, darker tones plus more light on one side tends to equalize paler tones plus shadow on the other. The result is a greater or lesser degree of reduction of the visible solidity of the animal. This distribution of light and dark tones on the animal, tending to counterbalance the unequal lighting the parts receive, is known as obliterative shading or countershading.

Countershading is, therefore, a basic principle of animal coloration and is of wide occurrence in nature. Many and quite unrelated groups of animals—mammals, birds, reptiles, fishes, etc.—in all parts of the world show it. Countershading may be described in relation to body form, to environment, and to habits. In some fishes with deep-bodied, laterally compressed forms having nearly vertical sides with but very slight convex curvature, strong countershading would defeat its own end, and it is noteworthy that such species are only

slightly countershaded. In them, the degree of countershading shows a relation to the body form. (Examples are some of the ilarchid, scatophagid, and cichlid fishes, which, unfortunately, have no common names.) Other animals living in dim light, where shading would be less extreme, reveal in the slightness of their countershading a relation to this environmental factor. Likewise, animals living on open plains in bright sunlight, such as many antelopes, deer, larks, etc., are strongly countershaded. In the case of the shark sucker, a fish that has the habit of attaching itself by a sucker on its head to different parts of sharks, no countershading is present. However, since it may have any side uppermost, the lack of countershading may be considered in relation to this habit, as the fish maintains no constant position with reference to the source of light. In some caterpillars, the normal resting position is inverted; i. e., the back is down and belly up (example, the larva of the eyed hawk-moth, *Smerinthus ocellatus*), and it is indeed suggestive that in these creatures the countershading is reversed being darker on the underparts and paler on the back.

The simplest form of countershading is merely an even, gradual transition from darkest on the parts receiving the most light to lightest on the parts most in shade. However, the same effect may be, and in nature often is, effected by patterns which blend at rather short distance. For example, the spots in many spotted animals are larger on the back and become smaller on the sides and disappear on the underparts. If these spots are fairly close together, at a distance they tend to blend, forming a graded countershading. The body stripes of zebras, for example, are very broad on the back and taper very appreciably on the sides, giving again something of the effect of countershading. Mottram (Proc. Zool. Soc. London, 1915, pp. 679-692) expounded this idea that certain patterns found on animals become blended with distance and result in oblitative shading. This depends on the fact that if a pattern composed of alternating dark and pale markings, regardless of shape (they may be bars, stripes, spots, etc.), is looked at from successively increasing distances, a point will be reached from which the separate markings are lost in a blended effect, producing a tone depending on the relative amounts of dark and pale. It may be pointed out that this type of countershading is effective only at a distance and would be of little value to an animal in the last crucial seconds when it is about to catch or to be caught, but it might help prevent the situation from arising. However, the picture is not as simple as it has been presented so far in this paper. In the majority of cases, the immediate background against which even the most perfectly countershaded animal is to become invisible is not an even tone of one color without breaks of any kind. If there is a background of

grass, for example, each blade (when close up) has a shadow, or at least an outline; fallen twigs or leaves present even more shapes and irregularities of light and dark. The combination of countershading and pattern resemblance does result, however, in something similar to blended patterns, but, however, functions also, and in many instances chiefly, at close range. Having now grasped the role played by obliterative shading, we may proceed to examine the varieties of patterns and color arrangements found in animals which are concealingly colored.

#### COLOR RESEMBLANCE

Most of us have at one time or another become aware of a general similarity in appearance between certain animals and their surroundings. We have come to expect creatures living in deserts or sandy places to have pale or sandy hues and not to startle us with the brilliant greens and reds of some of the denizens of dense tropical forests. Without asking ourselves why or even consciously wondering, we connect the white of the polar bear and of the snowy owl with the snow and ice of their Arctic habitat. Again it must be emphasized that not all animals are colored to resemble part of their environment; but the fact that exceptions are easy to find should not minimize the other fact that a very great many animals of all groups and living in all parts of the world and in all kinds of surroundings do bear on their coats a resemblance to their immediate environment.

General color resemblance, of necessarily only moderate value in effecting concealment, is shown by the preponderance of green birds, green tree toads, tree snakes, arboreal insects, etc., in the forested parts of the world, with a similarly large number of brownish forms dwelling on or in the forest floor. The common salt-and-pepper mottling or grayish-brown washes of shore birds show a general resemblance to their sandy or pebbly habitat. The whole question of color resemblance is still unfortunately largely couched in terms of human color vision. This will have to be altered with increasing knowledge of the color vision of the enemies of each animal showing color resemblance to its background. An example may help clarify this point. It is known that modern developments in infrared photography have revealed that different green animals differ greatly in their absorption of infrared light, and consequently those with great absorptive properties photograph as dark objects and those that reflect (and do not absorb) the infrared come out as light objects in the photographs. It is suspected that some predaceous animals, such as certain owls, have a visual range beyond the human one on the infrared end of the spectrum. It would follow from this that some green animals might be seen readily by the owls while others would

not, although to our eyes both would seem equally well concealed by their color. This problem is well known to the military camouflage experts in their experiments in concealing buildings, etc., with green paint or with leafy branches, the paint absorbing the infrared light and the chlorophyll in the leaves reflecting it.

Just as we may consider the general applicability of color resemblance in animals by virtue of the impressively large numbers of species that show some general color similarity to their surroundings, we may also sense its importance by considering the diversity of coloration in related species with diverse habits and habitats. Not only may we say that many forest denizens are greenish, many terrestrial dwellers brownish, many beach forms sandy in color, but also that within single groups of animals with diverse habitats we find all types of coloration in greater or lesser harmony with their backgrounds. In spiders, for example, the bark-dwelling species are usually brownish, those that live on stones are frequently grayish or with a broken pattern of dark and light; grass spiders are often green, while flower-inhabiting forms are whitish, yellow, pink, etc., in keeping with the flowers in each case.

Going still further, we find that color resemblance to particular local backgrounds varies geographically within single species. For example, in northern Africa crested larks of the genus *Ammomanes*, birds that dwell on the ground in open arid places, match surprisingly the color of the earth and sand. In one spot the ground color may be pale and tawny, so are the larks in that place. In another area, the terrain may be dark brown—so are the larks; in still another where blackish lava is a prominent feature of the substrate, the larks are similarly blackish. Yet all are one species, and intergrading specimens may be obtained between all their various extremes of color. A similar condition has been demonstrated in numbers of small mammals, such as deer mice, pocket mice, etc., by Benson (Concealing Coloration among Some Desert Rodents of the Southwestern United States, Univ. California Publ. Zool., vol. 40, p. 1-70, 1933). The cases of this kind could be greatly multiplied, and practically every group of animals would be found to contain instances of the sort.

In some animals we find a seasonal change in coloration which appears to be directly correlated with seasonal changes in the background. Well-known examples of this type are many of the ptarmigan, a group of northern grouse which are mottled gray, brown, and black in the summer, blending remarkably well with the pebbly and grassy habitat, and pure white in winter when their environment is covered with snow. The arctic fox shows a similar seasonal change in color. This type of color resemblance is, however, not very fre-

quent in nature. In many cases the seasonal changes in coloration are not such as make for greater concealment.

All the examples of color resemblance hitherto mentioned are fixed for their durations, whether they be for life or for a season only. There are a number of types of color resemblance in animals which are variable and depend on changing environmental conditions. Some are built up gradually over a considerable period of time, while others are very rapidly brought about. In a sense, the seasonal changes already alluded to are a connecting type of color resemblance between definitely fixed and purely variable resemblances, but their period of effectiveness is long enough to warrant our considering them with the fixed types. In the lives of many kinds of animals, especially the more active ones—that is, not sessile or parasitic forms—individuals are constantly coming into contact with differing variations of their immediate surroundings. In many cases when danger is sensed these creatures tend to get back as rapidly as they can to their optimum backgrounds, but others have the ability to meet the changed conditions with variable coloration. Probably the best-known case of rapid change in color is that of the chameleon, a small lizard which in the course of a few minutes can change its color through a surprising range of browns, reds, and greens, and darks and lights. Other lizards, such as some iguanas and geckos, are also known to possess the ability to alter their color rapidly. All are essentially arboreal dwellers and rely on concealment more than on speed for their safety. Terrestrial forms rely, in many cases, on speed first, and then on concealment.

Fishes also possess amazing ability to change their color in keeping with changes in the background against which they find themselves. A notable series of experiments on the flounder was conducted by Mast (Changes in Shape, Color, and Pattern in Fishes and Their Bearing on the Problems of Adaption and Behavior, with Special Reference to the Flounders, *Paralichthys* and *Ancylosetta*. Bull. U. S. Bureau Fisheries, vol. 34, pp. 173-238, 1916). The flounders, ordinarily grayish brown or grayish olive in color, speckled with darker brown, not only can and do respond to altered backgrounds by changing from pale sandy yellow to dark blackish brown, but even alter the fineness or coarseness of their pattern in keeping with that of the background, simulating to an astonishing degree the texture and pattern of the bottom on which they are resting. When lying on a uniform muddy background, they tend to be uniformly colored, the speckling being much reduced in size and number of specks and in any difference in color from that of the rest of the fish; when placed on coarse gravel they become coarsely flecked and speckled. The mechanism by which the chromatophores in the skin are caused to effectuate the resulting changes is only partly understood and is out of our province in this



short review, our interest in the present paper being in what happens rather than in how it is caused. Longley found that reef fishes effect rapid color adjustment following vertical movements—some species change from the decidedly patterned colors that they wear when on the bottom (and can be seen only from above) to a uniform coloration when rising upward through deep water (where a bottom-approximating pattern would be revealing rather than concealing). Another important result on Longley's work is the demonstration that particular phases of color pattern are frequently correlated with definite types of activity in a manner which is in keeping with what seems to result in optical illusion (Year Book Carnegie Institution of Washington, vol. 27, pp. 158-163, 1918). For example, different fishes which have—

\* \* \* alternate costumes of longitudinal stripes or uniform color, and of transverse bars, wear the former when in motion (an arrangement which makes for concealment in that it tends to mask forward movement) and the latter when at rest (when bars better serve to break up the contour and surface form against a broken background). Moreover, precisely similar adjustments are found in certain squids, which wear stripes for swimming and bands for resting [ex. Cott, Adaptive Coloration in Animals, p. 28, 1940].

Other examples of rapid color change have been recorded for other groups of animals—crustaceans, cephalopods, etc., but the important fact in the present connection is that beneath all the diversity of anatomical and physiological mechanisms involved in these different animals there is usually a common type of external stimulus (change in immediate environment as far as color, texture, etc., is concerned) and a common type of response.

Slower responses of similar type are known in certain insects and spiders. Poulton (Philos. Trans. Roy. Soc. London, vol. 178, pp. 311-441, 1887) showed by experimental studies that the larvae and pupae of certain butterflies possess the power of acquiring the coloration of their immediate surroundings and showed that in species of *Vanessa* and *Pieris* the pupal adjustment was due to extreme sensibility of the larvae to reflected light during the final resting position prior to pupation.

Aside from obliterative shading and color resemblance many animals are still further concealed by the fact that the patterns of their coloration tend to break up their outlines, so that at a distance they seem to be bits of the general surroundings rather than a recognizable shape which would tend to reveal them. This type of marking is known as—

#### DISRUPTIVE COLORATION

Even with better than average color resemblance and with some countershading, an animal is recognizable frequently by the fact that it presents a continuity of surface enclosed by an easily identified contour

with which we (or its enemies) are ordinarily familiar. Thus, as Cott rightly insists—

\* \* \* for effective concealment, it is essential that the telltale appearance of form should be destroyed. The difficulty of doing this is met, often with extraordinary success, by the application of optical principles involving the use of pattern.

The function of disruptive coloration (which is a combination of color and pattern tending to break up or to reduce the visible outline of the animal) is to prevent or to delay the quick recognition of the object by sight.

Its success depends not only upon optical principles, but upon a psychological factor. When the surface of a fish \* \* \* is covered with irregular patches of contrasted colours and tones, these patches tend to catch the eye of the observer and to draw his attention away from the shape which bears them. The patterns themselves may be conspicuous enough, but since they contradict the form on which they are superimposed, they concentrate attention upon themselves, and pass for part of the general environment.

In a general way it may be said that the concealing effect of a disruptive pattern is greater if parts of its included pattern bear a good color resemblance to the background while other elements are strikingly distinct. The result is that the background seems to be seen through the animal in places, thus breaking up its visual form. Thus, a butterfly with a brown and green pattern would stand out as a butterfly against a background not containing either of these colors, but against a brown ground it would look like an aggregate of green spots, or, against a green ground, like a bunch of brown marks. This partial matching of the background is spoken of as differential blending. The effectiveness of this disruptive coloration is greatly increased if the adjacent contrastingly colored markings are also contrasting in tone (lightness or darkness). Cases such as the black collar bands on white or pale sandy plovers, of dark lateral longitudinal stripes on some pale-colored antelopes, come readily to mind in this connection. Everyone who has watched ring-necked plovers on the beach is aware of the disruptive effect of the collar at a significantly short distance.

#### CONSTRUCTIVE SHADING

The amount of difference in tone and color of immediately adjacent parts of the pattern has an important bearing not only on the degree of success in its disruptive illusion, but also on the illusory pictorial relief it may create on the animal's surface. For example, if between the darkest and the lightest elements in a color pattern there is a gradual change from one to the other, the optical effect is that of a rounded surface (from shade to light); if, however, the darkest and the lightest elements are in immediate juxtaposition the effect produced is one of

sharp ridges. Convexities may be made to appear concave, flat surfaces to assume undulations, and curved areas to flatten out, by the relation of adjacent pattern elements. The consequent distortion of the true shape of the creature into the resulting optical shape helps to conceal it just as well as the actual disruptive marks tend to reduce it to a mass of unconnected pieces. It is a curious fact, and one which demonstrates the enormous range of form, color, and pattern to be observed in animal coloration, that the general result of camouflaged appearance can be arrived at by such diametrically opposed methods as obliterative shading (which reduces or dissolves solid form) and constructive shading (which builds up the appearance of form that is not there—such as ridges, convexities, etc.). It may be well to state again, in different words, this matter of constructive shading and disruptive marks. In a very general way it may be said that the illusion of discontinuity (the result of disruptive marks in their simplest form) is a matter of color contrast on a fairly even surface, while constructive shading produces the illusion of surface modeling. A combination of the two not only fragments a whole into optically distinct and apparently unrelated parts, but also by its sculptural illusion renders it more difficult for the eye to conceive these pieces as being in the same plane and therefore connectable. In some instances, constructive shading brings about an astonishing similarity to other objects such as the appearance of leaf vein ridges in some caterpillars.

Somewhat akin to constructive shading in its power of optical distortion is another type of disruptive pattern which has the effect of seeming to connect wholly distinct and not even adjacent parts of the body, thus further confusing the eye of the beholder and to that extent helping to hinder or delay recognition of the animal. A good example is the banded pattern in many frogs. When the frog is at rest (and in most cases no camouflage is of use when the creature is moving) the legs are folded close against the body and the bands of the body appear to be continuous with those of both the upper and the lower portions of the leg, optically merging into one mass. If the bands went in different directions on the legs they would stand out distinctly from the body and attract attention.

In many fishes there is a dark diagonal disruptive band on the body which often extends on to the pectoral or the pelvic fins, which, if not so connected by pattern with the body would be much more noticeable. Many insects show similar patterns involving legs or antennae as well as portions of the body. This type of color pattern has been termed coincident disruptive pattern by Cott, who was the first to emphasize the continuity of patterns of the head across the eye in order to hide the eye itself, ordinarily the most difficult part of an animal to conceal.

Many fishes, frogs, snakes, birds, and mammals have large rounded black pupils which conform to this very shape most likely to catch an observer's eye. However

effectively such animals may be camouflaged in other respects, unless the eye receives special treatment, it will prejudice the success of the whole color-scheme. It is therefore very interesting, though not surprising, to find that nature—the supreme camouflage artist—has dealt in great detail with this problem, which is evidently one of urgent importance. \* \* \*

In its essentials, the method \* \* \* invokes the optical principle of coincident disruptive coloration. \* \* \* If an eye, and particularly its staring black pupil, can be made to appear another shape, then it will cease to resemble an eye. In theory, such an illusion could be created by covering the eye, or its pupil, with a black mask of irregular shape—so designed as to blend with and seem part of the pattern which surrounds it. Now that is essentially the system devised in nature. \* \* \* Animals belonging to many widely separate families and orders have the eyes camouflaged in precise detail. Although the underlying principle is everywhere the same, the incidents of the picture vary widely in different cases. Sometimes an irregular dark disruptive area includes the whole orbit. Sometimes the upper margin of an elongated patch of dark pigment crosses the iris exactly on a level with the top of the pupil. Or conversely it may extend beneath to the pupil's lower limit. Or again the eye may be crossed by a stripe exactly the width of the pupil itself. In other cases similar effects are produced in vertical bars instead of horizontal stripes; or in diagonal markings or irregular shapes varying greatly in size and distribution. The one consistent feature in all this diversity is the significant relation between that unmitigated black spot—the pupil—and the dark element which serves to absorb it.

Given an animal with any or all of the types of concealing color pattern already discussed, it may yet be concealed in vain in some cases, if its contour or bounding margin be unaffected by the camouflage. Actually, in most cases of disruptive pattern the outlines of the animal are affected by it, and further marginal disruption is unnecessary, but in some instances the peripheral parts—tail, limbs, head and neck, or even the lateral contour margin are disruptively marked.

#### CONCEALMENT OF THE SHADOW

We have already seen, in the case of the white ptarmigan against a snowy background, that aside from the bird's lack of obliterative shading and its consequent visual solidity, its presence is revealed by the shadow it casts on the snow at its feet. In case of danger the shadow would be largely done away with, as the bird would squat low on the snow and actually cover a good part of its shadow. It is actually no exaggeration to say that in many cases of animals with a color pattern more or less concealing in nature, the shadow is more noticeable than the animal casting it. In creatures of laterally compressed form such as butterflies that rest with wings closely over the back, we find two definitely established orientation habits which appear to be related to the matter of shadow concealment or reduction. A number of species, notable among which is the green hairstreak butterfly (*Thecla rubi*), tilt the wings away from the median vertical plane toward the shadow, thereby hiding a large part of it. The degree of tilting is said to be constant for each species, and numerous independent observers

have testified to the fact that the wing tilting is not a casual or accidental reaction, but is definitely correlated with the direction of sunlight and also to the approach of enemies. Another group, without the wing-tilting habit, always seem to orient the body with respect to the direction of sunlight when alighting on any object so that the shadow cast by the wings (which are the largest part of the creature) is reduced to a thin, inconspicuous line instead of a sizable dark area. In animals with dorsoventrally flattened or depressed body form, shadows are often reduced by the animal's squatting closely against the ground or branch or whatever the creature is resting on, but in many cases there are structural features which, whatever their other functions may or may not be, do serve to reduce shadow by covering it from sight. Many reptiles and amphibians, such as the horned toad, have lateral finlike flanges on the tail which not only help to cover the shadow that would otherwise be visible, but by their gradual slope from the top of the tail to the substratum throw little if any shadow beyond themselves. These flanges make for unbroken continuity between the more substantial part of the animal and its immediate surroundings. The sides of the body are flattened out into longitudinal flanges. As we have already noted in discussing constructive shading, the effect of false shadows, such as those of the leaf vein ridges, may be brought about by pattern in some creatures, such as certain caterpillars.

#### DISAPPEARING COLORATION

All the items examined so far have to do with animals that are more or less stationary. There are also a great many animals that show bright patches or patterns when in motion but suddenly conceal them when alighting. From the standpoint of the pursuer it is very confusing to be chasing something with a bright, vivid telltale mark and then find it suddenly vanishing. It often results in the pursuer racing on beyond the hiding prey and thereby losing all chance of obtaining it. Color patterns of this disappearing type are of two main kinds, the one depending on the distinctive pattern being actually covered when at rest, the other depending on differential orientation to light. In the first type the cases may be very simple, involving merely the disappearance of the bright color area, or they may involve elaborate protective color resemblance to the substratum on the part of the covering portions of the body. As may be expected, the second is far more effective as concealment than the first, but in both the element of confusing surprise is equally present. An example of simple disappearing coloration is the common North American woodpecker, the flicker (*Colaptes auratus*). In flight this bird shows a large conspicuous white patch on the rump, and bright golden yellow undersides on the wings and tail. On alighting these parts are immediately

concealed, and an enemy following these beacons might well be confused by their sudden extinction. An example of the more elaborate type is the leaf butterfly (*Kallima paralekta*). This insect has a bright orange, brown, and whitish pattern of bold markings on the upper surface of its wings, which make it a conspicuous sight when the creature is flying. On alighting on a twig, however, the wings immediately close together over the back, leaving only their undersides visible. Both in color and in form the closed wings look amazingly like a dried leaf and the insect is suddenly completely concealed, to the bewilderment of its possible pursuer.

The other type of disappearing color is that found in animals with iridescent scales, feathers, etc. A gleaming ruby light, as on the throat of the male ruby-throated hummingbird (*Archilochus colubris*), is suddenly extinguished as the bird, in its darting about, alters its orientation to the sunlight. This is, in effect, disappearing coloration in motion, as opposed to concealment of color when at rest, and it may be argued that when in motion the creature is less in need of camouflage than when still, but within this lesser sphere of necessity, it may have a protective effect.

#### THE EFFECTIVENESS OF CONCEALING COLORATION IN NATURE

There has been much difference of opinion among naturalists as to the real effectiveness of concealing coloration in animals, some estimating its success as almost unbelievably complete, while others contend that it has no value whatever and is a reflection of a purely human approach to the subject. This paper is hardly the place to evaluate the arguments and the evidence pro and con, but it may be pointed out that the great majority of opinion does grant it some effectiveness, and, what is even more important, animals that are what we call concealingly colored seem, by their habits, to rely on their coloration to save them from attack. It may be further mentioned that the application to man's war efforts of the principles involved in concealing coloration in nature have been generally conceded to be of sufficient effectiveness to warrant their continued and even increased use. We are not concerned in this brief review so much with the various details of the functions of concealing coloration as with a survey of the methods by which it is attained.

#### CONCEALING BODY FORM

Not only are many animals rendered less conspicuous by reason of their coloration, but also in many (and some of the most startling) cases by their form as well. We have already had a suggestion of this in the body and tail flanges that tend to eliminate or conceal shadow, but may now briefly consider some of the main types of dis-

guise brought about by the shape and contours of the animals involved.

As might be expected, morphological (i. e., form) resemblances are to be found chiefly among smaller creatures whose whole lives are spent against unchanging backgrounds, i. e., creatures that are environmentally more rigidly fixed. Also, inasmuch as morphological resemblances are generally more specifically related to definite items in the surroundings than are many color resemblances (that are often of a general similarity to a background complex) it is to be expected that these special resemblances are chiefly to such things as leaves, bark, stems, seaweed, etc. On the whole, it may be said that the value of the various types of camouflaging coloration depends upon principles of visual concealment or confusion, while the morphological resemblances partake more of the nature of definite, specific, particulate disguises. For purposes of simplification, it may be said that we have to do here with the actual modeling of the body and not with constructive shading.

We have already seen an instance of leaf resemblance in the case of *Kallima*, the leaf butterfly. The ends of the wings are actually shaped like the stems of leaves and the outlines of the closed wings are duplicates of the periphery of leaves. Even more elaborately worked out is the leaf resemblance of not only the whole, but even the parts of such leaf insects as *Chitomiscus* and *Cycloptera*. Aside from the all-important details which make or mar the effectiveness of the disguise, the basic common element in all leaf-resembling creatures is thinness. Whether the thinness is produced by a dorsoventral flattening or depression of the body or by a lateral compression, the creature orients itself accordingly with respect to its background, just as we found in the types of shadow elimination in butterflies. Leaf resemblance is found not only in insects, but also in some fishes, chameleons, and other forms of animals.

Resemblance to bark is one of the commonest types of morphological disguise. The reason for this is that all barks (in spite of definite specific differences) show a smaller range of variation than do all leaves, for example, and at the same time the bark fauna is very extensive. Bark-resembling creatures include many moths, beetles, spiders, tree frogs, climbing lizards, and a few birds. In the moths alone, many distinct families have produced instance after instance of bark resemblance.

Closely connected with bark resemblance is resemblance to lichen, as lichen is so frequently found on places analogous to tree trunks (from the standpoint of their inhabitants). Not only do we find the same range of animals in all parts of the world with lichenlike appearances or with strong bark resemblances, but we even find animals using lichens apparently for their concealing properties. For example,

the ruby-throated hummingbird (*Archilochus colubris*), the woodpecker (*Myiochanes virens*) and the blue-gray gnatcatcher (*Poliophtila caerulea*) cover the outsides of their nests with lichens, with the result that they are very well concealed.

Also associated with bark resemblance are those cases of twig resemblance, well illustrated by the familiar walking-stick insect. All parts of the body are here modified into slender twiglike pieces, and the joints between them have much of the appearance of plant nodes. Furthermore, the postures struck by the insects are in keeping with the illusion of small twigs. As a matter of fact, the harmony between usual posture (which is not rigidly fixed in most cases) and the illusory form or color resemblance in many of these concealingly colored animals is one of the strongest lines of evidence for the reality of the camouflage. Otherwise, it might well be a purely man-made interpretation, but when creatures seem to act according to this color or form, or to be colored and shaped according to their normal activities, it is difficult not to grant the reality of this correlation.

In the sea we find crustaceans and fishes that have many irregular filamentous appendages, which bring about an astonishing resemblance to the seaweed in which these particular species live. The fauna of the Sargasso Sea, an area in the Atlantic Ocean filled with the Sargassum weed, are perhaps the best-known examples of this kind, although others occur in all the oceans wherever seaweeds are common. There are numbers of species of small fishes, of crabs, etc., that spend their lives in the floating masses of Sargassum weed, and of this ecologically closely limited fauna, the percentage of seaweed form resemblance is high indeed. Specimens taken out of their natural environment seem merely bizarre curios of the naturalists' cabinet, but in their native haunts they merge completely into their surroundings.

#### CONCLUSION

Camouflage in nature, is, then, widespread, both in all parts of the world, and within all groups of animals. It may be brought about by coloration alone, by form alone, or by any possible degree and type of combination of color or morphological characters. It may be rigidly fixed or remarkably plastic. Its degree of success in different forms is highly variable, and, as might be expected, the opinions of investigators as to its merits have been equally diverse. In this brief review we have merely pointed out some of the types of camouflage, have given some idea of its complexity, of its multiplicity of methods and approaches, and of the astonishing heights of deceptive efficiency it attains in many cases. Such controversial outgrowths of the subjects as mimicry and the theoretical difficulties it entails have been deliberately left out of the present discussion.



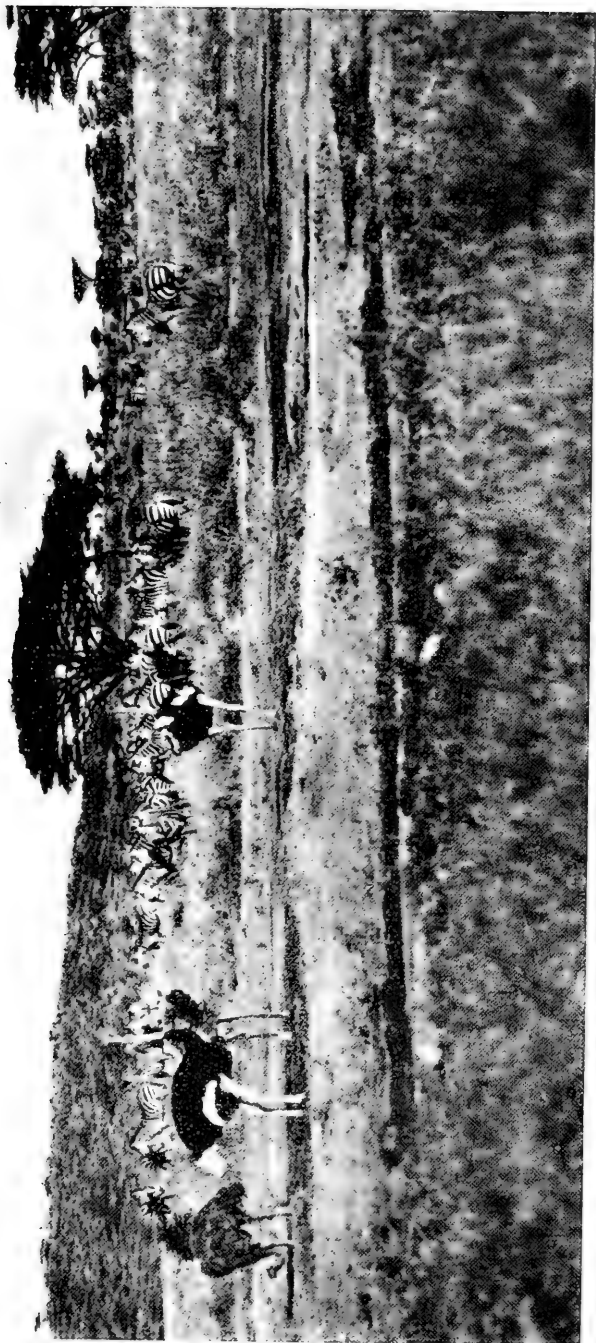

ZEBRAS AND OSTRICHES IN THE EAST AFRICAN PLAINS.

Note how the more distant zebras tend to blend into the background, the stripes becoming less and less distinct. (Photograph by C. E. Akeley, courtesy American Museum of Natural History.)



ROCK PTARMIGAN AT MOUNT MCKINLEY NATIONAL PARK, ALASKA, SHOWING HOW WELL THE COLOR PATTERN OF THE BIRDS BLENDS WITH THAT OF THE BACKGROUND.

(From Bull. 162, U. S. National Museum.)



1. COUNTERSHADING AND COLOR RESEMBLANCE IN THE SANDERLING (*CROCETHIA ALBA*).

(Drawn by W. A. Weber.)



2. COLOR RESEMBLANCE WITHOUT COUNTERSHADING IS NOT ENOUGH.

The white-tailed ptarmigan is revealed by its visual solidity and by its shadow. (Drawn by W. A. Weber.)

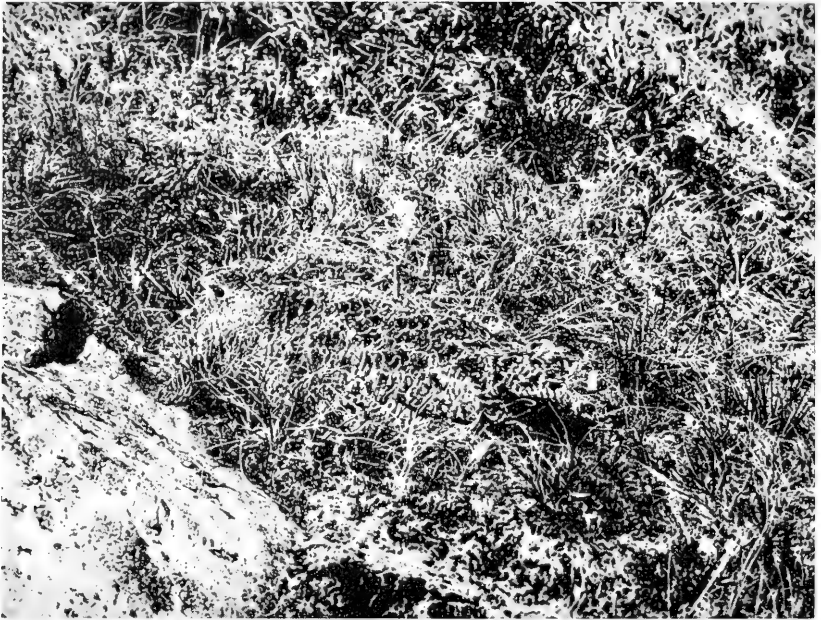

1. Photograph from life.



2. Bird retouched to remove color pattern.

THE OBLITERATING EFFECT OF COLOR RESEMBLANCE IN THE  
WHITE-TAILED PTARMIGAN (*LAGOPUS LEUCURUS*).



1. Nighthawk, adult, young, and eggs.

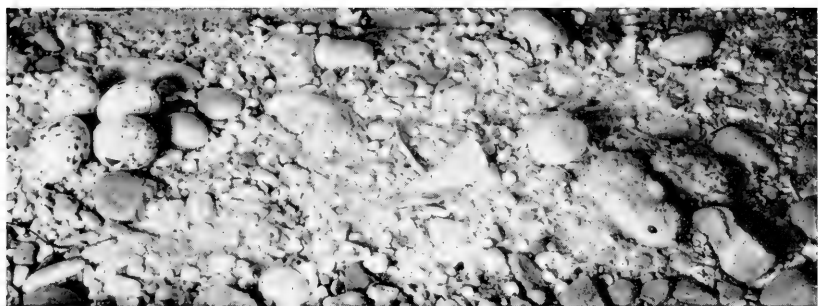

2. Spotted sandpiper, young, and eggs.

CONCEALMENT AFFORDED BY COLOR RESEMBLANCE AND LOW  
SQUATTING POSITION.

(From exhibits in the U. S. National Museum.)

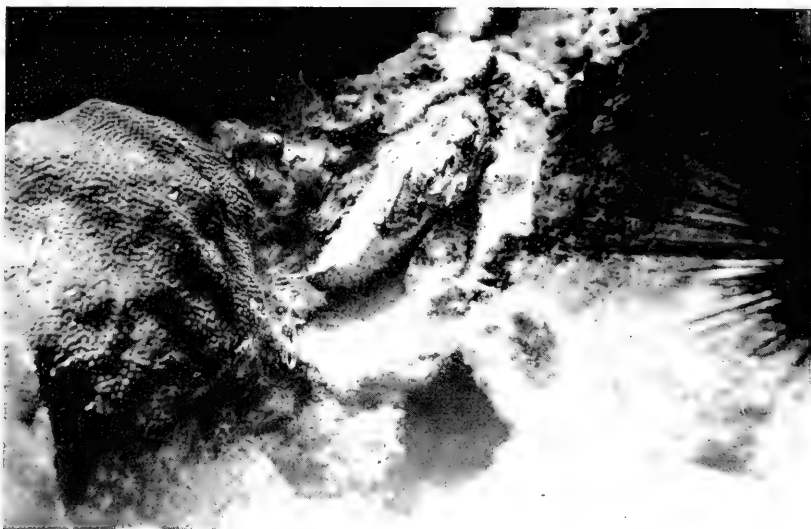

1. SCORPION FISH (*SCORPAENA PLUMIERI*).

A good example of background resemblance both in color and in pattern. (From Longley and Hildebrand, Carnegie Inst. Publ. 535, 1941.)



2. PARROTFISH (*SPARISOMA PACHYCEPHALUM*) IN FOREGROUND AT RIGHT

An example of blending with the background. (From Longley and Hildebrand, Carnegie Inst. Publ. 535, 1941.)

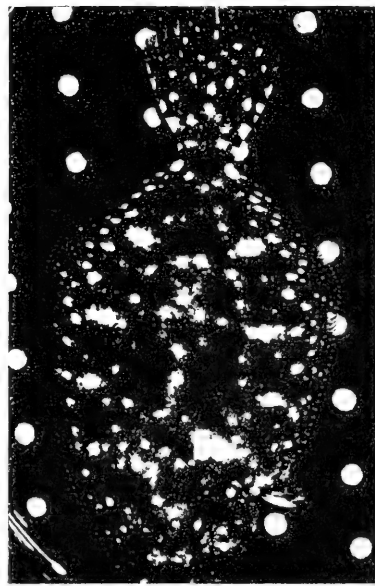
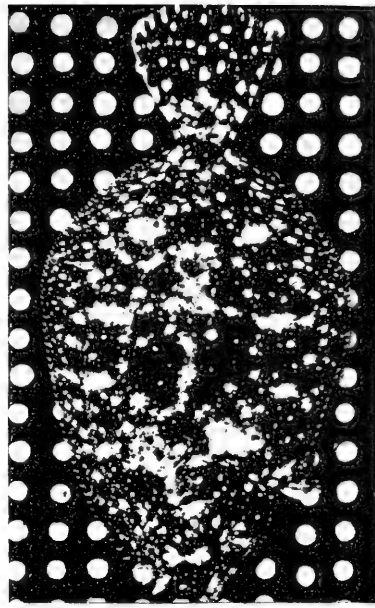
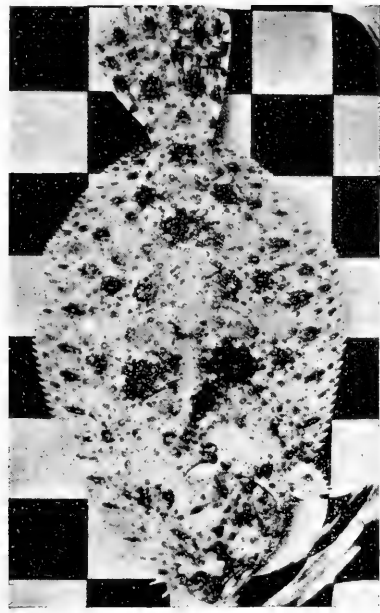

CHANGE IN COLOR AND PATTERN IN FLOUNDERS.

These photographs are all of the same individual fish in an aquarium tank under which different card bottoms were placed. (From Mast, Bull. U. S. Bur. Fisheries, 1941)



1. Swimming fish with "normal" coloration.



2. Resting fish changing its pattern to simulate surroundings.

NASSAU GROUPE (EPINEPHELUS STRIATUS), A FISH THAT ALTERS ITS COLORATION IN KEEPING WITH ITS BACKGROUND WHEN AT REST.

(Photographs by Longley and Hildebrand.)





**A**



**B**

THE EFFECT OF DISRUPTIVE MARKINGS IN THE RING-NECKED PLOVER (*CHARADRIUS SEMIPALMATUS*).  
A, against its normal background; B, without its background. (Drawn by W. A. Weber.)



COINCIDENT DISRUPTIVE MARKINGS IN THE BRAZILIAN TREE FROG (*HYLA NIGROMACULATA*).

(Drawn by W. A. Weber.)

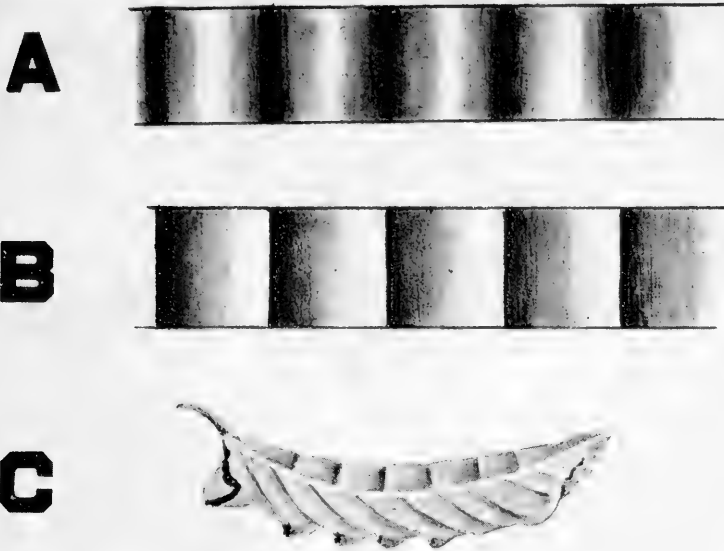

1. CONSTRUCTIVE SHADING.

A, extreme dark and light tones connected by intermediate shading, giving a smoothly rounded appearance; B, extreme dark and light tones in contrasting juxtaposition, giving the effect of ridges; C, a leaf caterpillar (*Epistor gorgon*) with constructive shading giving the appearance of leaf vein ridges. (Drawn by W. A. Weber, after H. B. Cott.)

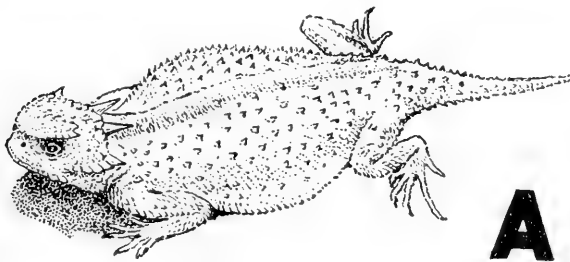

2. SHADOW ELIMINATION IN THE HORNED TOAD (*PHRYNOSOMA CORNUTUM*).

A, the animal as it appears; B, a diagrammatic cross section to show the lateral flanges covering the shadow; C, a diagrammatic cross section of what the animal would look like if it did not have the lateral flanges; note the revealing shadow. (Drawn by W. A. Weber.)



1. NEST OF WOOD PEWEE (*MYIOCHANES VIRENS*) SHOWING USE OF LICHEN FOR NEST CONCEALMENT.  
(From exhibit in the U. S. National Museum.)



2. TRUMPET FISH (*AULOSTOMUS MACULATUS*) CONCEALED BY FORM AND COLOR-PATTERN RESEMBLANCE IN A SEA FEATHER.  
(Photograph from Longley and Hildebrand, Carnegie Inst. Publ. 535, 1941.)

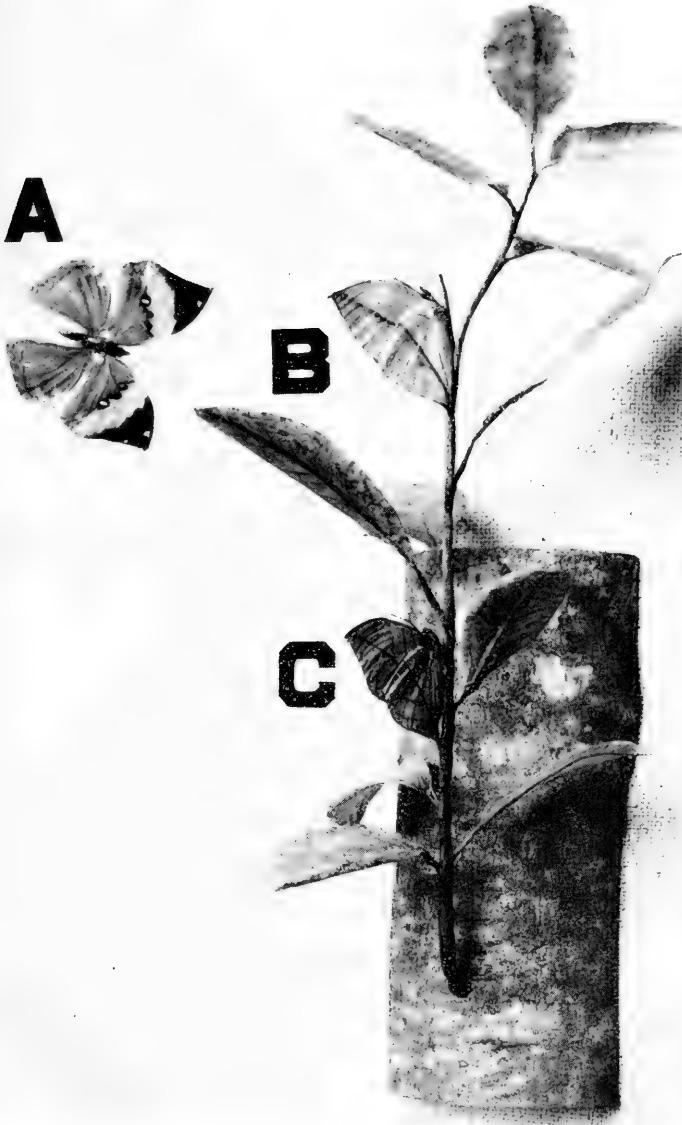

LEAF BUTTERFLY (*KALLIMA PARALEKTA*).

A, the butterfly in flight, showing the conspicuously marked upper surface of the wings; B and C, butterflies at rest, looking like the leaves around them. (From exhibit in the U. S. National Museum.)

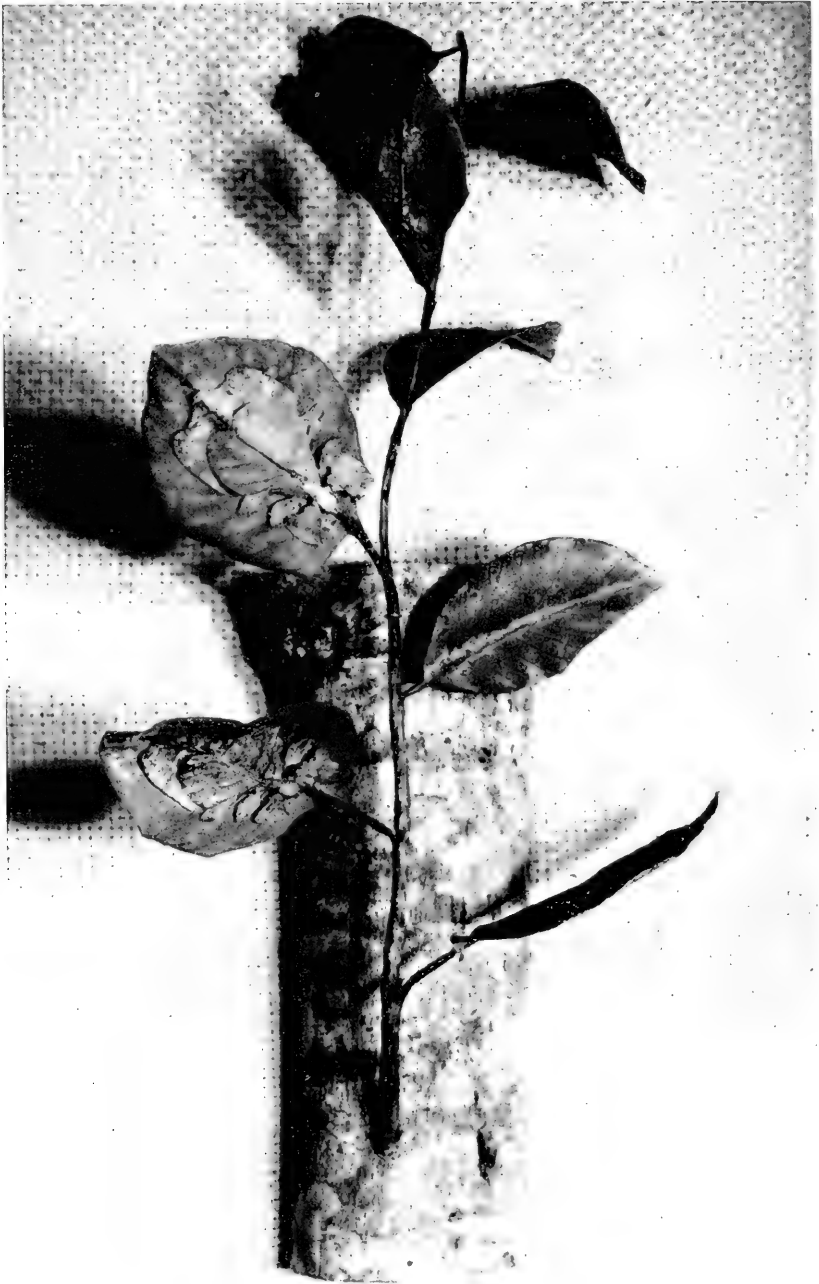

LEAF INSECT, CHITONISCUS, SHOWING MORPHOLOGICAL AS WELL AS COLOR RESEMBLANCE TO THE LEAVES UPON WHICH IT FEEDS.

(From exhibit in the U. S. National Museum.)



BARK-RESEMBLING INSECTS.

(From exhibit in the U. S. National Museum.)



1. Walking-stick insects on twigs. (Photograph by H. S. Barber.)

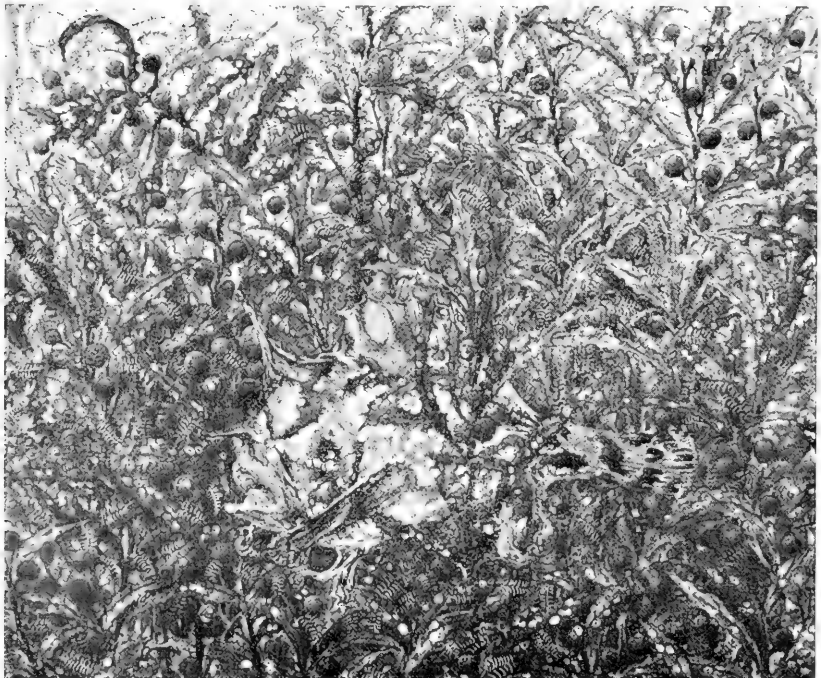

2. Sargassum fish (*Pterophryne histrio*) in Sargassum weed.  
FINE EXAMPLES OF CONCEALMENT BY BODY FORM.



# DANGEROUS REPTILES <sup>1</sup>

By DORIS M. COCHRAN  
*Associate Curator, Division of Reptiles and Batrachians*  
*U. S. National Museum*

[With 23 plates]

## CONTENTS

	Page
Introduction.....	278
Poisonous reptiles.....	279
The New World.....	279
The United States of America.....	279
The coral snakes.....	280
The pit vipers.....	281
The timber rattler.....	284
The diamondback rattler.....	284
The pigmy rattlesnakes.....	285
The water moccasin.....	285
The copperhead.....	285
Distribution of our poisonous snakes.....	286
The Gila monster.....	287
Latin America.....	287
The coral snakes.....	288
The pit vipers.....	288
The rattlesnakes.....	288
The cantil.....	289
The bushmaster.....	289
The fer-de-lance or barba amarilla.....	290
The palm vipers.....	290
The jumping viper.....	291
The hog-nosed vipers.....	291
Other pit vipers.....	291
The rear-fanged snakes.....	292
The yellow-bellied sea snake.....	292
The Mexican beaded lizard.....	293
The Old World.....	293
Europe and northern Asia.....	294
The common viper and its allies.....	294
Orsini's and Renard's vipers.....	295
The asp, Lataste's, and the long-nosed vipers.....	295
The blunt-nosed viper and its allies.....	296

<sup>1</sup> Reprinted, with extensive revision and additional plates, from Smithsonian War Background Studies, No. 10, entitled "Poisonous Reptiles of the world: A wartime handbook."

Poisonous reptiles—Continued.	Page
The Old World—Continued.	
India, China, Japan, and Malaya.....	296
The vipers.....	296
The daboia, tic-polonga, or Russell's viper.....	296
The carpet or saw-scaled viper.....	297
The pit vipers.....	297
The mamushi and its relatives.....	297
Bamboo snakes and their allies.....	297
Cobras and kraits.....	298
Indian or spectacled cobra.....	298
The king cobra or hamadryad.....	299
The kraits.....	299
The sea snakes.....	300
Africa.....	300
The vipers.....	301
The night adder or Cape viper.....	301
The puff adder.....	301
The rhinoceros viper.....	301
The Gaboon viper.....	302
The horned adders.....	302
The sand vipers.....	303
The cobras and their allies.....	303
The ringhals or spitting snake.....	303
The spitting or black-necked cobra.....	304
The black cobra.....	304
The Egyptian cobra or asp.....	304
The Cape cobra.....	305
The water cobras.....	305
The mambas.....	305
The rear-fanged snakes.....	306
The boomslang.....	306
Australia, New Guinea, and the South Pacific islands.....	306
The black snake.....	307
The copperhead snake.....	307
The brown snake.....	308
The tiger snake.....	308
The death adder.....	308
The sea snakes.....	309
Dangerous nonpoisonous reptiles.....	309
North America.....	309
The American crocodile.....	310
The American alligator.....	310
The alligator-snapper.....	310
The common snapping turtle.....	311
Latin America.....	311
The anaconda.....	311
The boa.....	312
The Belize crocodile.....	312
The Orinoco crocodile.....	312
The caymans.....	312
Iguanas and other large lizards.....	313
Europe and northern Asia.....	313

Dangerous nonpoisonous reptiles—Continued.	Page
India, China, Japan, and Malaya.....	313
The reticulated python.....	313
The Indian python.....	314
The Komodo dragon lizard.....	314
Other monitor lizards.....	314
The soft-shelled turtles.....	315
The salt-water or estuarine crocodile.....	315
The Siamese crocodile.....	316
The mugger.....	316
The gavial.....	316
Africa.....	316
The rock python.....	316
The waral and other monitors.....	317
The Nile crocodile.....	317
The long-snouted crocodile.....	317
The African soft-shelled turtle.....	318
Australia.....	318
The diamond python.....	318
Other large snakes.....	318
The goanna.....	318
Gould's monitor.....	319
The salt-water crocodile.....	319
Appendix.....	319
First-aid treatment.....	319
Antivenin and its preparation.....	320
Directions for making scientific collections.....	321
Selected bibliography.....	322

## ILLUSTRATIONS

## PLATES

[All except pl. 1, frontispiece, follow p. 324]

- |                                   |                                    |
|-----------------------------------|------------------------------------|
| 1. Copperhead and coral snake.    | 11. 1, Night adder, or Cape viper. |
| 2. 1, Coral snake.                | 2, Puff adder.                     |
| 2, Timber rattler.                | 12. 1, Rhinoceros viper.           |
| 3. 1, Pigmy rattler.              | 2, Gaboon viper.                   |
| 2, Copperhead.                    | 13. 1, African sand viper.         |
| 4. 1, Tropical rattlesnake.       | 2, Ringhals, or spitting snake.    |
| 2, Bushmaster.                    | 14. 1, Egyptian cobra.             |
| 5. 1, Fer-de-lance.               | 2, Water cobra.                    |
| 2, Palm viper.                    | 15. 1, Mamba.                      |
| 6. 1, Hog-nosed viper.            | 2, Black snake.                    |
| 2, Mussurana.                     | 16. 1, Australian copperhead.      |
| 7. Mexican beaded lizard.         | 2, Brown snake.                    |
| 8. 1, Common viper.               | 17. 1, Tiger snake.                |
| 2, Orsini's viper.                | 2, Death adder.                    |
| 9. 1, Daboia, or Russell's viper. | 18. 1, American crocodile.         |
| 2, Indian, or spectacled cobra.   | 2, American alligator.             |
| 10. 1, King cobra.                | 19. 1, Alligator-snapper.          |
| 2, Banded krait.                  | 2, Common snapping turtle.         |

- |  |   |
|--|---|
| 20. 1, Anaconda.<br>2, Boa.<br>21. 1, Galápagos land iguana.<br>2, Komodo dragon lizard. | 22. 1, Salt-water crocodile.<br>2, Indian python.<br>23. 1, Rock python.<br>2, Gould's monitor. |
|--|---|

## TEXT FIGURES

	Page
1. Venom apparatus of rattlesnake-----	283
2. Yellow-bellied sea snake-----	293

## INTRODUCTION

Among a world population of some 2,400 different kinds of living snakes, less than 200 are poisonous to man. These poisonous snakes belong to the following families: The Elapidae, represented by coral snakes and cobras; the Viperidae or true vipers; the Crotalidae or pit vipers; the Hydrophidae or sea snakes; and the Colubridae. To this last-named family most of the harmless snakes also belong, the only dangerous ones being those having poison fangs in the back part of the upper jaw. Some poisonous snakes are extremely useful in destroying rats and mice, but this desirable trait is offset near inhabited districts by their occasional biting of human beings or domestic animals.

The chances of being bitten by poisonous snakes are exceedingly small. Only about one-sixth of our native snakes are poisonous. One person out of every fifteen bitten receives the bite while handling or "playing" with a poisonous snake. "In the United States alone automobiles kill more than 30,000 people annually, snakes probably 160; for every person killed by a snake, 200 die in automobile accidents."<sup>2</sup> This does not mean that vigilance should be relaxed in traveling through snake country. On the contrary, it is well to recognize the presence of a very real danger as the best means of avoiding it.

The distribution of poisonous snakes throughout the world is now fairly well known. They do not live in the extremely cold regions of any country; thus in North America they are known only as far north as the southern borders of Canada. Since the continents to the south of the Equator lie much farther from the Poles than do those to the north, we find poisonous snakes over the whole of Africa and in most of South America, except on the high mountains and in southern Patagonia. An extremely hardy viper occurs in Scandinavia to within the Arctic Circle; this is the record for cold endurance among the venomous snakes. The Polynesian islands are free of land-dwelling poisonous snakes. So are Madagascar and New Zealand, although both of them are relatively close to areas

<sup>2</sup> Pope, Clifford, *Snakes alive and how they live*, p. 171, 1937.

where many very dangerous kinds prevail. The Azores, and the Canary and Cape Verde Islands near Africa, have none. The large and small islands of the West Indies lack poisonous snakes, except Trinidad, Tobago, Martinique, and St. Lucia. In the Temperate Zone their absence from Ireland has often been noted. They are also missing from Iceland, the Shetlands, and the Orkneys.

The true vipers (family Viperidae) are found only in the Old World, and the one dangerous rear-fanged colubrid (the boomslang) is confined to Africa. The crotalids are found in the New World and in Asia, while the elapids occur in all the continents except Europe.

Snakes and lizards are both members of the same order—Squamata—in the class of reptiles.

Only 2 kinds of lizards out of nearly 3,000 now known to science have proved to be poisonous, with 1 other very rare species suspected to be so. The 2 poisonous lizards live in the southwestern United States and Mexico. The 1 suspected of being poisonous occurs in Borneo.

The other living members of this class—turtles, tuatara, and crocodilians—are not equipped with venom glands.

Some of the larger nonvenomous reptiles are potentially dangerous to man because of their lacerating bite or their muscular strength. The crocodile in particular has a bad reputation, while the crushing power of anacondas and pythons is traditional. Less spectacular because less widely known is the alligator snapping turtle found in the Mississippi River and other water systems of some of the southern States. The soft-shelled turtles, one genus of which is found in North America, and others in Asia, while usually very shy, have exceedingly strong, sharp jaws, which can administer a severe bite to anyone rash enough to get near the darting head.

Not all giants among the reptiles are savage, however. The Galápagos turtles, some of which easily tip the scales at 300 pounds, are noted for their docile temperament.

Many reptiles are of great economic value to man, either because their hides, flesh, or eggs are useful, or because their food consists of rats, mice, and other pests which annually destroy vast quantities of agricultural and other products. A great many of the smaller kinds of snakes are rodent eaters. Through lack of space, only a few of the larger snakes are mentioned in this paper.

## POISONOUS REPTILES OF THE NEW WORLD

### THE UNITED STATES OF AMERICA

Every one of our 48 States has at least one kind of poisonous snake living within its boundaries. All except the most northerly have several kinds. The Gila monster, our only poisonous lizard, brings to

nearly 40 the total number of kinds of poisonous reptiles in our country.

The poisonous snakes of the United States belong to two major groups: the Elapidae, represented by coral snakes, which are related to the cobras of Asia and Africa, and the Crotalidae or pit vipers, represented by the true rattlesnakes, the pigmy rattlers, the massasauga, the copperhead, and the cottonmouth.

The venoms of the different species of poisonous snakes differ to a greater or less degree.

All venoms are complex mixtures containing several toxic elements. In general these may be divided into two main groups—the neurotoxins and the haemotoxins. Apparently all snake venoms include the neurotoxic factors, and it is these which usually bring about the death of the snakes' victims. They have several different actions against nerve tissues, most important of which is their effect against the nerve centers controlling respiration. Death following snake bite most often results directly from respiratory failure. The venoms of the cobras, coral snakes, and their allies are almost purely neurotoxic, but viper and pit viper venoms usually attack the circulatory system as well. The common effects of the haemotoxins in such venoms are destruction of red blood cells and weakening of the walls of the smaller blood vessels, particularly the capillaries. (Nigel Wolff.)

#### THE CORAL SNAKES

The first group, family Elapidae, is very similar in build to most harmless snakes. The poison apparatus consists of short, vertical fangs requiring a full bite for the injection of the poison. There is no very conspicuous enlargement at the base of the jaws to give a triangular shape to the head supposedly characteristic of poisonous species.

It has been repeatedly asserted that the mouth [of the coral snake] is so small that it cannot bite as well as the other poisonous snakes. This, however, is somewhat of a mistake. Externally and superficially the head \* \* \* appears very short and narrow, and the opening of the gape but of slight capacity. An examination of the skeleton, however, shows the skull to be comparatively large and rather elongate, especially the cranial part, which occupies fully two-thirds of the total length of the head. The articulation of the lower jaw, which is correspondingly lengthened, is consequently far enough back to permit, by means of the elasticity of the ligaments, the opening of the mouth quite out of proportion to the external aspect of the snake.<sup>3</sup>

Since the coral snake is often sluggish and "gentle" when handled, some persons have said that it can hardly be induced to bite. It sometimes will bite very suddenly and unexpectedly, however, but as the wound appears small and unimportant, the necessary treatment is often neglected, with serious results to the victim because of the highly toxic character of its poison.

<sup>3</sup> Stejneger, L., Poisonous snakes of North America. Ann. Rep. U. S. Nat. Mus. for 1893, p. 355, 1895.

The coral snake is attractively colored with bright red, yellow, and black transverse rings on its body (pl. 1, frontispiece, and pl. 2, fig. 1). The snout from the eyes forward is black. If in killing the snake the pattern of the head is lost, the coral snake may be identified by its black rings being bordered on each side by a yellow ring, while in the harmless species it is the yellowish ring which is bordered on each side by a black ring. There are three subspecies of *Micrurus fulvius* in the United States, the typical form occurring from southeastern North Carolina south throughout Florida and the Gulf States to the Rio Grande, north in the Mississippi Valley to Arkansas; the subspecies *barbouri* in extreme southern Florida, and the subspecies *tenere* from Mississippi to northern Tamaulipas, Mexico. Another kind of coral snake, now called *Micruroides euryxanthus* but for many years considered a full species of the genus *Micrurus*, is said to occur in New Mexico, Arizona, and northern Mexico.

Our North American kinds seldom exceed 3 feet in length, but numerous larger relatives are found in South and Central America, where they are a recognized menace. Our species feed upon other snakes and small lizards. They burrow in soft ground or under logs and are hence seen more infrequently than their actual numbers warrant. They come out of their burrows at night or after a rain to search for food. Their eggs are deposited in decaying bark or damp soil, about seven in a clutch. The time of incubation, in this as in all other egg-laying snake species, depends upon the heat and moisture; it is usually about 3 months.

#### THE PIT VIPERS

The pit vipers, so called because of the small pit between the nostril and the eye, representing the Crotalidae, are much more numerous than the Elapidae since about 35 different species and subspecies are recognized within the United States. The rattlesnakes need no introduction, for they are known by reputation, if not by actual contact, to everyone in this country. The presence of a whirring rattle on the tail tip is their spectacular and distinguishing characteristic. The rattlesnakes are divided between two genera, *Crotalus* and *Sistrurus*, the first having many small scales on top of the head, the second with several large regular shields in that region. To the genus *Sistrurus* belong the massasauga and the pigmy rattlesnakes, whose venoms are less to be feared because of the small size of these snakes.

*Venom and bite.*—While we usually speak of the “bite” of a pit viper, it is much more accurate to refer to it as a strike. The snake strikes usually from an S-shaped position, the posterior third of the body remaining on the ground to give necessary leverage for the blow. Hence two-thirds of the body length is the maximum

striking distance. None of our North American pit vipers actually jumps off the ground in making an attack. As the head is thrown forward for the blow, the mouth is opened, and the fangs, which are attached solidly to the movable maxilla, are brought into striking position as shown in figure 1. The venom is contained in a large specialized salivary gland near the angle of the jaw (its presence is the cause of the conspicuous triangular widening of the snake's head posteriorly), and this venom runs forward through a tube connecting with the hollow fang in the upper jaw. The comparison to a hypodermic needle is very appropriate. When the snake's fangs strike the victim's flesh, the weight of its body drives them deep, and they leave their load of venom or are sometimes broken off and stay in the wound. The loss of its functional fangs does not long inconvenience the pit viper, however. There is a series of developing teeth at the base of each fang, and whenever a fang is shed or breaks off, a new one comes forward to take its place in a few days. To render a pit viper "harmless" by removing all these fangs thoroughly would necessitate cutting into the upper jaw so deeply that the snake would probably die. Every pit viper has also some solid teeth with which to hold the prey and prevent it from wriggling away while the snake is attempting to swallow it. The amount of venom delivered at one strike varies greatly even in the same individual. If the snake is in poor condition, if it has already struck recently, or if the fangs have to penetrate layers of hide, fur, and fat—or in the case of human beings, clothing or shoes—the amount of poison that may be injected is correspondingly less than normal. The diamondback rattler of the southeastern United States is our largest species and hence has probably the longest fangs—about three-quarters of an inch in a 6-foot snake. The fangs at rest are covered by whitish folds of skin, very apparent when the snake opens its mouth.

*Additional facts about pit vipers.*—It is a popular but erroneous belief that a rattler's age is told by counting the "rings" in its rattle. The fact is that a segment is formed every time the growing snake sheds its skin; hence a young snake acquires three or four during its first year of life, and about as many more each year during its later years. By the time it has reached nearly maximum growth, it often accidentally breaks off most of its rattle—which is composed merely of segments of a dried, horny substance—so that a very large snake presumably several years old may have only one or two segments. Circus men overcome that difficulty by fitting several rattles onto a big snake's tail to make it more imposing to the trusting audience.

The colors of most pit vipers are much duller than those of the brilliant coral snake previously discussed. Rattlers especially are inclined to dull, dark tones as they reach adulthood, and this effect is increased by the keels of the lusterless scales which further roughen



their skins. A diamond or chevron in brown or gray on a light tan ground is often the basis of the color pattern. The diamondback has an unusually distinct diamond design; hence its name.

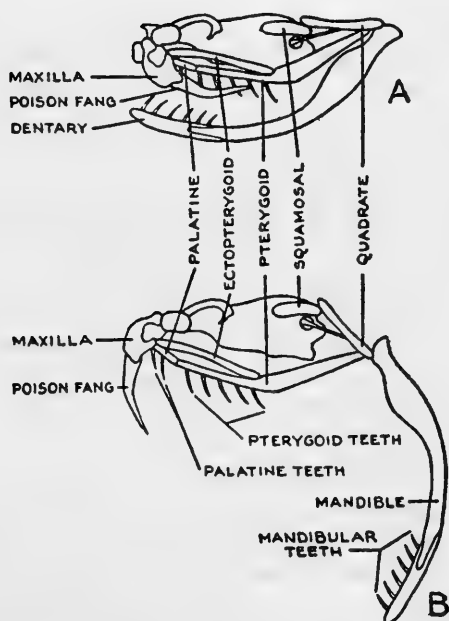
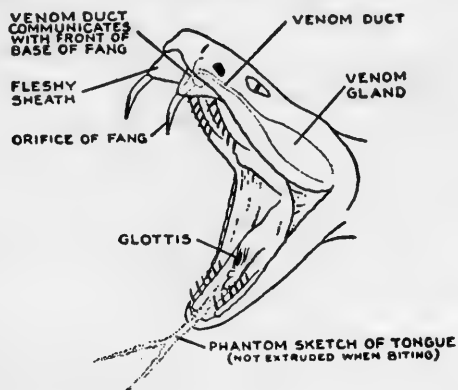

FIGURE 1.—Upper, diagram of venom apparatus of rattlesnake. Lower, diagram of bones involved in biting mechanism of rattlesnake. A, jaws closed, fang folded back against roof of mouth; B, jaws open and fang erected for biting. (From *The reptiles of Ontario*, by E. B. S. Logier, 1939.)

The pit vipers are so named from the presence of a small pit in the side of the head between the eye and nostril. This pit is filled with sensory cells the function of which is still somewhat in doubt. It is

believed from experiment that the cells in the pit enable the snake to distinguish between cold and warm air currents and hence to know when some warm-blooded animal approaches it in the dark—a useful function since most pit vipers are nocturnal and do their hunting at night. Their food consists of anything small enough to be swallowed—birds, mammals, sometimes fish, frogs, snakes, lizards, or small turtles—each species showing a “preference” for some of the food items that it normally can obtain in its own particular environment.

Most pit vipers are viviparous—that is, their young are born (having developed in the eggs retained within the mother’s body) instead of being hatched from eggs as is the case with the coral snakes. Young snakes begin to look for food very soon after birth. Their skin is usually shed within a few days for the first time.

#### **The timber rattler.**

First of the more common species on the list for easterners is the timber rattlesnake (*Crotalus horridus*, pl. 2, fig. 2), also called the banded or black rattler.

Distribution of this rattlesnake in the Northeastern States is associated with hills and mountains of moderate height, on which there are broken ledges with large, loose fragments on the slopes and top. These flat fragments may be a foot or more in thickness and from a yard to 6 or 8 feet in length, sloping back into a fissure, the bottom of which may be covered with soil or leaves, and which provides a position of security during storms. It is the common habit of rattlesnakes to coil under the edge of these rock masses, protected from the too hot summer sun, and ready to quickly retreat if disturbed. If the intruder goes on his way, the snake may lie in its motionless coil, without sounding the rattle, thus seeking to escape notice. Near these natural homes are specific crevices or “dens,” where rattlers that have roamed over a considerable area during the summer congregate each fall preparatory to deep penetration and hibernation, beyond the frost line. During the late summer the females return to such places and here the young are born, with a natural instinct to return to this specific area each year for winter shelter \* \* \*.<sup>4</sup>

#### **The diamondback rattler.**

The diamondback rattlesnake (*Crotalus adamanteus*), already mentioned, lives in wooded areas of the Southeast, especially among the scrub palmetto of the sea beaches in Florida. “It is not a swamp species, although it may frequent woods close to water and does not hesitate to swim across small bodies of water. In the coastal strips it crosses fair-sized tide pools and has been noted several miles from shore, where it has been accidentally carried by the currents. It is also found among the keys. When adult, its food consists largely of rabbits,”<sup>5</sup> and sometimes of quails. There is a western diamondback which is said to cause twice as many deaths as the eastern species. The

<sup>4</sup> Ditmars, R. L., *Snakes of the world*, pp. 114–115, 1934.

<sup>5</sup> *Idem*, p. 113.

prairie rattlesnake and the water moccasin constitute the other species which together with the diamondbacks are responsible for about 95 percent of deaths by snake bite in this country.

#### The pigmy rattlesnakes.

“The bites of pigmy rattlers and massasaugas (genus *Sistrurus*) are practically never fatal to adults, except possibly through septic combinations. These rattlers are our least poisonous snakes, for of 20 cases on record, none ended fatally.”<sup>6</sup> They frequently feed upon frogs. The massasauga is about 3½ feet long. It frequents swampy places, although it shuns the actually wet places. It is brownish or grayish, with chestnut-brown blotches on the back and a similar row on each side. The ground rattler (pl. 3, fig. 1) is seldom more than 20 inches long, with a very minute rattle. It prefers dry areas with low vegetation. Its venom is particularly powerful, but the small amount of it injected at a bite is not known to have been lethal to man.

#### The water moccasin.

While the rattling of the rattlesnake is said to be a warning device, there are many pit vipers which have no rattle and hence cannot give the warning, unless the vibrating tail should strike against dry leaves or rushes, in which case a rattling sound is produced. By far the most dangerous of these in the confines of the United States is the water moccasin (*Agkistrodon piscivorus*), or cottonmouth. Adults are dull olive or brownish above and paler on the sides, on which are indistinct blackish bands. Young specimens are brilliantly colored, usually of a pale reddish brown with bands of dark brown narrowly edged with white. The snake is one of the largest of the poisonous ones in this country, attaining a length of 6 feet, and it is also one of the most pugnacious in its wild state. Over most of its distribution it lives along streams and lakes or in swamps and is particularly abundant along abandoned rice ditches of the southeasterly and Gulf States. In captivity it feeds upon small rabbits, rats, birds, fishes, and frogs.

#### The copperhead.

Another rattleless pit viper is the copperhead (*Agkistrodon mokeson*, pl. 1, frontispiece, and pl. 3, fig. 2). It can be recognized by its reddish-brown hour-glass-shaped marks crossing the back, set off by the light buff or reddish-tan ground color. It feeds upon small rodents, birds, and frogs. In the northern States it frequents rocky places, usually in the vicinity of moderately thick timber, marshy glades or hollows. In the South it is found on higher and drier ground

<sup>6</sup> [Kellogg, R.], Poisonous snakes of the United States. Mimeographed circular Bi-571, U. S. Dep. Agr., Bur. Biol. Surv., February 1925.

than are the timber rattler and water moccasin, which seem to prefer the swamps. A very large copperhead may be as much as 4 feet long. Baby copperheads, as well as the young of all other poisonous snakes, are venomous from the moment of birth. Although an adult copperhead secretes a relatively small amount of venom, a great many persons are bitten owing to the snake's concealing coloration, which blends perfectly with the ground covered with fallen leaves. A number of harmless snakes are similar in appearance to the copperhead and are often confused with it. Several species of watersnakes (*Natrix*) are characterized by brown markings on the back somewhat like the pattern of the copperhead. They are savage in disposition and the lacerating bite from the many short, solid teeth may lead to an infection if not thoroughly disinfected.

#### DISTRIBUTION OF OUR POISONOUS SNAKES

The matter of distribution cannot be explained in a few words. Sometimes no poisonous snakes occur in what seem to be the most favorable localities. Again they will be found in some special habitat perhaps near a town or city where repeated attempts to exterminate them have been made. The more northerly the locality, the fewer the species as a rule. New England, for instance, has but two species, the copperhead and the timber rattler, and the former does not go north of central Massachusetts. The massasauga is added in the upper Mississippi Valley. The canebrake rattler, the diamondback, and the pigmy (two subspecies) complete the number of rattlesnakes in the Southeast.

Crossing the Mississippi, we find a much more numerous assemblage. The western diamond, the red diamond, the Pacific, and the prairie are among the most formidable. The western massasauga and the western pigmy rattler, the Texas rock rattler, the tiger and the black-tailed rattler, the speckled and faded and Great Basin rattlers, and the Willard's, Price's, and green rock rattler, each with its own particular distribution, occur through the west between Canada and the Mexican border. One of the most peculiar, though not particularly dangerous, is the little sidewinder, so called from its method of progressing through the sand. It has "horns" on its head, as the scale above its eye is enlarged and bluntly pointed, although it is not stiff enough to cause any damage, nor is it known to be used in self-defense. To this list must be added two forms of the copperhead, and the water moccasin. Each of these snakes thus briefly mentioned deserves a much fuller discussion than can be accorded in a paper of this size. The best advice in dealing with supposedly poisonous reptiles is to leave them alone if possible. It is not at all a wise policy to exterminate every snake in sight, since many harmless snakes are of actual

economic value. The depredations of rats, mice, moles, and gophers are certainly controlled by the rodent-eating snakes, and such snakes even if poisonous should definitely be protected in any agricultural area.

#### THE GILA MONSTER

The final poisonous reptile under consideration is the Gila monster (*Heloderma suspectum*) or beaded lizard, occurring from the southern part of Utah and Nevada through Arizona into Sonora, Mexico. This and a related species in Mexico are the only known poisonous lizards. The Gila monster is heavily built and may grow to 2 feet in length, of which over one-third consists of the rounded tail. The entire animal is covered with coarse beadlike scales, salmon-red and black in color and forming a very beautiful blotched pattern. The head is blunt and massive, and the rather small legs seem inadequate to support it. In the warm sun the lizard can become very active, however, and can move about with surprising agility. The clublike tail is a storage place for fat. When the lizard has been getting an abundance of food, the tail becomes swollen and heavy. In time of starvation, the tail shrinks decidedly, as the body of the lizard is nourished by the stored-up fat. The food consists of eggs of birds and reptiles and also probably any small animal that it can pick up. For a long while its ability to poison was doubted.

The first confirmation of its poisonous nature seemed to be established by the discovery of grooved teeth, about 3-4 mm. long, four on either branch of both maxilla and mandibular. \* \* \* The mandibular appears somewhat swollen, owing to the projection of its disproportionately large, elongated submaxillary glands, whose four separate ducts lead to the base of the above-described grooved teeth. \* \* \* The arrangement of the teeth and of the glands makes us understand why opinions as to the poisonous nature of heloderma have differed so widely. When an animal seizes its victim only with the front teeth, or does not lie on its back while biting, none or very little of the buccal secretion may enter the wound. \* \* \*

The Gila monster is known to turn over on its back when it is biting, and after it has once taken hold it chews on the wound.

#### LATIN AMERICA

While most tropical countries are abundantly supplied with poisonous snakes, it is a surprising fact that they are totally absent on nearly all the large and small islands that make up the West Indies. On Trinidad and Tobago, allied faunistically as well as geographically to the mainland of South America, we find the bushmaster, a typically South American species, and the coral snake. On Martinique and St. Lucia as well as in Trinidad the fer-de-lance, a close relative of the

<sup>1</sup> Ditmars, R. L., *The reptile book*, p. 170, 1907.

bushmaster, occurs. The mongoose was brought from India and introduced upon Martinique and Trinidad to kill snakes but has proved to be a pest in many instances where it turned to the destruction of fowl and other useful birds instead.

Since many of the tropical poisonous snakes of this hemisphere range over both Central and South America, these species will be considered first, with the more important of the localized forms which are confined to a smaller area considered at the end of this section.

#### THE CORAL SNAKES

Like their relatives of the United States, the tropical coral snakes (genus *Micrurus*) are burrowing and secretive in their habits. Their brilliant coloring of red and black bands makes them easy to detect among the vegetation. Some nonvenomous snakes mimic their coloring closely. Their bright pattern, much alike in all the species, has given them the common name of coralilla in Mexico, and of gargantilla (necklace) in Central America. While they are not aggressive if undisturbed, they will bite when stepped on or handled roughly. The larger kinds can inject a lethal dose of poison; the wearing of canvas leggings and leather shoes provides adequate protection against coral snake bite when traveling in "snake country," as their fangs are not long.

Two of the commonest South American coral snakes are *Micrurus frontalis*, found in southern Brazil to the Argentine, and *Micrurus lemniscatus*, occurring in the Guianas and Brazil. While these may appear "gentle," they will treacherously turn and bite if they are carelessly handled. A length of 4 feet is fairly common.

#### THE PIT VIPERS

##### The rattlesnakes.

The rattlesnakes (genus *Crotalus*) with which we have become so familiar in the United States have many close relatives in the lands to the south. The habits of these tropical rattlers are much like those of the rattlesnakes of our own country. Some of the species are very rare, only three or four ever having been found by naturalists even after the most assiduous collecting. Some are very small, and unable because of their short fangs to inject a lethal amount of poison. One of the larger kinds, *Crotalus durissus terrificus* (pl. 4, fig. 1), is the only member of the genus in South America, ranging from northern Venezuela to southern Brazil except for the wet valley of the Amazon. Its length is up to 7 feet. The venom has a largely neurotoxic action, in this respect being different from that of the northern rattlesnakes. It is more aggressive than most reptiles,

since it deliberately glides forward toward the intruder. It carries its neck in an S-shaped lateral loop, in readiness to strike. It does not always use its rattle to give warning. While it sometimes coils, with its rattle buzzing steadily, more often it gives no more warning than a few quick side flings of the rattle, producing single harsh clicks. This is a sound well worthy of recognition in the higher ground of the Tropics, as it may be immediately followed by the serpent's stroke with no further warning. This serpent has many common names, the most frequently used being cascabel, although in different parts of Brazil it is called boicingina, maracaboia, and boiquira. It is not found south of southern Brazil and the Chaco region of the Argentine.

#### The cantil.

The cantil (*Agkistrodon bilineatus*) takes the place of our water moccasin from central Mexico to Central America. The adult is black, with white or yellow markings. The head is dark, with a vivid yellow stripe along the snout and another on the upper lip. It is semiaquatic in habit and attains about the same size as the related copperhead—less than 4 feet. Its poison is highly toxic; fortunately it does not seem to be abundant.

#### The bushmaster.

The most feared of tropical American snakes is the bushmaster (*Lachesis mutus*, pl. 4, fig. 2), the giant among the pit vipers, which attains a length of about 11 feet, although such large individuals are very rare. It is also exceptional among the pit vipers because it lays eggs, all the others bearing the young alive. It is aggressive in character, and while the vibrating of its tail on the ground when the snake is uneasy makes a loud buzzing sound somewhat like that produced by the warning rattle of the rattlesnake, the bushmaster holds its ground and usually comes near to the intruder. Its teeth inject a large quantity of venom, and by their length ( $1\frac{3}{8}$  inches in a snake 11 feet 4 inches long) they can penetrate very deeply through coverings that would render the striking of an ordinary-sized snake practically harmless. The body is yellowish or reddish brown with a series of dark blotches, wide on the back and narrow on the sides—a pattern that blends in very well with the surrounding vegetation. Its skin is very rough. It is long and slender, hence well able to travel through underbrush, and its lance-shaped head gives it an extremely sinister appearance. It is found from Nicaragua through southern Central America and South America, also in Trinidad. It is called sirocucu and mapepire in some places where it occurs. It lives in damp forests in holes made by other animals.

### The fer-de-lance or barba amarilla.

The fer-de-lance (*Bothrops atrox*, pl. 5, fig. 1) is another tropical snake which it is well to avoid, as the effects of the poison are said to be dramatically sinister and rapid, the action being largely haemolytic, destroying the red blood cells, breaking down the walls of the carrying vessels, and producing great extravasation. \* \* \* The tissue about the wound is practically dissolved by rapid necrosis. These effects are, however, effectively neutralized by serum produced by the several research laboratories in the tropics.<sup>8</sup>

Its length may be over 8 feet. The ground color is variable, from gray to brown or reddish, with a row of dark, light-edged triangles down each side, the tips of the triangles reaching the center of the back. Its body is relatively slender, setting off the lance-shaped head. Since it is not uncommon for a female fer-de-lance to produce 60 to 70 young ones in a litter, the abundance of this species is readily understood. The range extends from southern Mexico through Central America and northern South America, including the islands of Martinique and St. Lucia in the West Indies. Some of its other native names are jararaca, terciopelo (=velvet snake, Costa Rica), and tomigoff (Panama). It is especially dangerous to laborers on sugar plantations, as it is attracted there in numbers by the rats which make their homes in such places.

### The palm vipers.

These small snakes (genus *Bothrops*<sup>9</sup>) are arboreal in habit, being found in the low trees or bushes (pl. 5, fig. 2), sometimes coiled up where the base of a palm stem joins the trunk. Their prehensile tail helps them to cross from tree to tree when the branches nearly touch. Men pushing their way through thick underbrush should be careful to avoid being bitten in the face by these vipers. The green palm viper (*B. bicolor*) is leaf green above and below, and hence is nearly invisible among green foliage. Other species have green, brown, and yellow in the coloring, suited to concealment among branches and leaves. A few of the species have "eyelashes"—hornlike projections of the scales above the eye, of no known use to the snake. They are found in Mexico and Central and South America. Because of their often greenish or yellowish coloration and their habit of living in banana trees, these snakes, especially Schlegel's palm viper (*B. schlegelii*), are extremely dangerous to laborers on banana plantations. Although these snakes are only 2 feet in length, their proportionately large head and long fangs enable them to do more harm than their size would indicate, and fatalities have resulted from their bites.

<sup>8</sup> Ditmars, R. L., Snakes of the world, p. 134, 1934.

<sup>9</sup> Some scientists now use the generic name *Trimeresurus* instead of *Bothrops* for the bulk of the Latin American pit vipers.



**The jumping viper.**

Most poisonous snakes in striking keep the tail and posterior part of the body on the ground for leverage, but the jumping viper (*Bothrops nummifer*) is able to slide and strike in a way that carries its body 2 feet forward. From a slight elevation it is able to jump for a yard. Since its length is somewhat less than a yard, it has several times the striking range of most pit vipers. Its body is stout, its head proportionately large, and its skin so rough that one is reminded of that of the bushmaster. The fangs are short, and the venom is of lower toxicity than in other species of *Bothrops*, so that this snake is not so greatly to be feared as are most of its relatives. It ranges through most of Central America into Mexico. Its native names are timba and mano de piedra, the latter coming from its supposed resemblance to the native implement used for grinding corn.

**The hog-nosed vipers.**

These three small terrestrial vipers (*Bothrops nasuta*, *B. lansbergii*, *B. ophryomegas*) may be recognized by their upturned snouts (pl. 6, fig. 1). They live in Central America and southern Mexico, with two species extending into northern South America. Their native names are chatilla or tamagá. Some of these savage little vipers strike with such force that they slide a few inches on smooth level ground and sometimes jump forward several inches, although this habit is not so characteristic of them as it is of the true jumping viper (*Bothrops nummifer*) mentioned above. They grow to about 2 feet in length.

**Other pit vipers.**

Maximilian's viper (*Bothrops newwiedii*) of Brazil is of the fer-dance type and might be mistaken for that species. But it is usually smaller, and details of the triangular brown markings are different. Its native names are jararaca and urutu. It ranges into northern Argentina and Paraguay. The name jararaca is also applied to other closely related kinds of poisonous snakes.

One of the most poisonous of all the pit vipers is the island viper (*B. insularis*), which is confined to a small rocky island barely three-quarters of a mile in extent lying 40 miles southwest of the Bay of Santos, Brazil. Since there is little else on the rock for snakes to eat except the small birds that nest there, this snake's highly toxic bite evidently insures the death of the bird before it has been able to flutter far enough to fall into the sea and so be lost.

While most people do not associate beauty with a poisonous serpent, *B. alternatus*, commonly called urutu, has one of the handsomest patterns of all the pit vipers—a series of dark brown crescentic marks on

each side, on a pale cream ground color. It grows to 5 feet in length, with a thick, heavy body. It occurs in southern Brazil, Paraguay, Uruguay, and the Argentine.

The value of using scientific rather than common names for species is well illustrated by my attempt to give the Indian names for some of the foregoing snakes. The word jararaca is used for several different kinds of pit vipers. The same is true of urutu. Likewise it will be seen that the name copperhead is used for an Australian snake of a different family from that of the copperhead found in the United States.

#### THE REAR-FANGED SNAKES

Some of the opisthoglyph (=back-fanged) snakes (*Oxybelis*, *Pseudoboa*) have taken to an arboreal existence. These are less dangerous to man because of the small amount of poison, its relative mildness, and the fact that the teeth placed in the rear of the mouth do not always make good contact with a victim's flesh. Most of these snakes are slender and whiplike in body, with elongate heads and large eyes. Some are green, others grayish or brown in color. The green whip snake, *Oxybelis fulgidus*, is light green with a lemon-yellow stripe on the sides. When frightened, it stiffens its neck and slowly waves its head from side to side to imitate a stem blown by a breeze. Its food consists of lizards, which are very susceptible to its poison.

The mussurana (*Clelia clelia*, pl. 6, fig. 2) is a large, heavy-bodied, terrestrial serpent which uses its constricting powers as well as its poison to subdue its prey. Its chief food consists of other snakes, among them being the deadly fer-de-lance—not deadly at all to the mussurana, which is unaffected by the poison or the injuries of the fangs. Unfortunately, the mussurana is rather rare throughout its rather wide range—Guatemala through Brazil. Most of the natives know of its snake-eating habits, and so it is seldom killed. Brazilian specimens are blue-black all over, while Central American ones are white beneath. Young ones are said to be coral red.

#### THE YELLOW-BELLIED SEA SNAKE

Only one species of sea snake (*Pelamydrus platurus*, fig. 2) has crossed the Pacific Ocean from its native home off the coast of Asia. This snake is compressed, with very small scales and no enlarged plates across the ventral region. Its back and upper sides are rich brown to black, sharply set off from the bright yellow ventral coloration. Its tail is compressed and rounded at the tip like a paddle and acts as a rudder. While this species seldom exceeds 3 feet in length, some of the other species (to be discussed in the section on Asia) are more than twice as long. Fatalities from its bite have been re-

ported, but as a rule sea snakes are disinclined to bite, although some are equipped with very deadly poison, and are said never to attack bathers. Their food consists of fish and other small marine organisms. They are now established along the west coast of Central America, especially in the Gulf of Panama.

#### THE MEXICAN BEADED LIZARD

The Mexican beaded lizard (*Heloderma horridum*, pl. 7) is the only other known species of poisonous lizard in the world, besides its relative, the Gila monster. It occurs from the central part of Mexico to the northern part of Central America. Its habits are very similar,

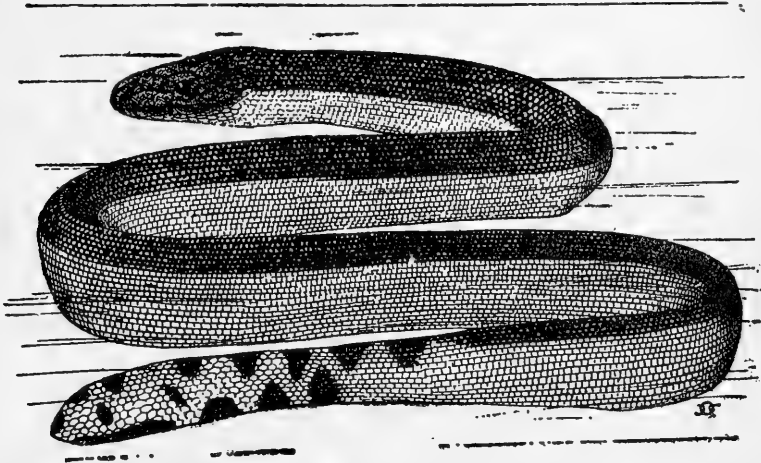

FIGURE 2.—The yellow-bellied sea snake (*Pelamys platurus*), entirely aquatic, and having a compressed, rudderlike tail.

to those of its northern relative, but it is a little larger, being known to reach 30 inches in length, and its tail is proportionately longer. Its head is usually black, and its beadlike scales are colored with irregular patches of black and yellow. The very young lizard has vivid yellow stripes with bands of yellow on the tail. With age this regular pattern disappears, and some specimens turn nearly black or dark brown. The bite results in the same poisoning symptoms as that of the Gila monster.

#### POISONOUS REPTILES OF THE OLD WORLD

The family Viperidae (true vipers) is as characteristic of the Old World fauna as are the rattlesnakes of the New World. Some representatives of the Crotalidae, the family to which the rattlesnake be-

longs, are found in southeastern Asia and the East Indies, however.<sup>10</sup> These are pit vipers, and differ from the true vipers which are likewise found in those regions by the possession of a complex pit on the side of the head between eye and nostril. Both these families differ from the following ones in having a head distinctly set off from the body by the swelling at the base of the jaws due to the poison glands, which are much smaller in the Elapidae and Hydrophidae.

The family Elapidae, represented in the New World by the coral snakes, contains some of the most widespread and dangerous of Old World snakes—the cobras. Australia has about 80 kinds, while Africa and southern Asia boast of numerous species also. Elapidae have the head and body nearly continuous in outline, with no distinctly marked “neck” in most cases, in this respect resembling the harmless colubrine snakes.

The Hydrophidae (sea snakes) are found near the coasts of southern Asia and northern Australia. Most of them hug the shore and dislike to swim far away from land. One kind has successfully crossed the Pacific and established itself on the west coast of Central America, as stated above, and this same species has likewise crossed the Indian Ocean to the eastern shores of Africa.

Some rear-fanged snakes of the family Colubridae occur in Asia, but as their bites are not deadly to human beings, they will not be discussed here. Some of the African species are potentially very dangerous to man, however.

While no poisonous lizards are positively known from the Old World, an exceedingly rare lizard from Borneo possibly related to the Gila monster has been assumed to be poisonous. As yet no proof of this has been put forward.

#### EUROPE AND NORTHERN ASIA

The true vipers (family Viperidae) are the only poisonous snakes to be found in Europe and northern Asia.<sup>11</sup> Some of their characteristics are a vertical pupil, relatively small size, and a zigzag dark stripe down the middle of the back more or less pronounced in European species. These vipers fall naturally in groups of closely allied species which have much in common.

##### The common viper and its allies.

This snake (*Vipera berus*, pl. 8, fig. 1), called northern viper or adder in part of its range, is the only poisonous species inhabiting the British Isles, where it is found in Scotland, Wales, and England, but not in Ireland. It likewise ranges over northern Europe at least to the 67th

<sup>10</sup> One species, *Agkistrodon halys*, just reaches into eastern Europe near the Caspian Sea.

<sup>11</sup> Except the pit viper *Agkistrodon halys*, a predominantly Asiatic species which extends westward to the Saltan Murat Desert and the Induski hills near the Caspian Sea.

degree in Scandinavia and across northern Asia to the Amur River and Sakhalin Island. Southward it extends to the Pyrenees, Apennines, and the Balkans. Two distinct forms occur in different parts of Yugoslavia, while another lives in northwestern Spain and Portugal. It prefers a cool climate, but in the north selects hills well exposed to the sun on which to bask, although it is partially nocturnal also. It eats any small living creatures of suitable size—mice, birds, lizards, frogs, salamanders, and slugs, while the very young ones feed on insects and worms. The young are born alive in August or September, and number from 5 to 20 in a litter. Many fatalities from bites have been recorded, especially in France and Germany. Exceptional specimens are nearly 3 feet long, although 2 feet is the more usual length.

#### **Orsini's and Renard's vipers.**

Orsini's viper (*V. ursinii*, pl. 8, fig. 2), rather similar to the common viper in appearance, is found in southern France, northern Italy, Hungary, and parts of Yugoslavia. It is not found with the common viper in any part of its habitat. It grows to a maximum size of 2 feet. Its disposition is much less aggressive than that of the common viper, and in some places it is said not to make use of its poison apparatus since it feeds entirely on grasshoppers. Renard's viper (*V. renardi*) is closely related, except that its snout is much more pointed. Its length does not exceed 2 feet. It is found in the Crimea and parts of eastern Russia, extending far into Central Asia. Its food consists of small mammals and lizards.

#### **The asp, Lataste's, and the long-nosed vipers.**

These three European vipers can be recognized by their "turned-up noses," that is, the tip of the snout is distinctly above the level of the top of the head. The asp viper (*V. aspis*) is found in southern France, the Pyrenees and Apennines, and Yugoslavia. It likes hot, dry localities, and lives in holes in rocks or in the earth. It is both nocturnal and diurnal, with food habits similar to those of the common asp. Its disposition is savage, and many accidents, some of them fatal, are caused yearly in southern France where it is very abundant. A subspecies occurs in Sicily and Calabria (southern Italy). Lataste's viper (*V. latasti*) prefers stony, arid, and forested regions in Spain and Portugal, also in Morocco and Algeria. It is not known to exceed a length of 2 feet. It climbs low trees in search of young birds. Its bite is supposed to be less dangerous than that of the asp viper and rarely causes the death of human beings or domestic animals. Its nose is likewise somewhat "turned up." In the sand viper or long-nosed viper (*V. ammodytes*) the snout appendage is particularly evident, giving it one of its common names. It occasionally grows to a length of 3 feet. It has numerous geographical varieties. The typi-

cal form is found in Austria and the Balkan states. It likes dry, stony hills with low bushes, which it frequently climbs. Its poison is stated to be more active than that of other European vipers, so that fatal accidents to man are frequent. It is extremely abundant in some parts of Austria and is said to be the commonest of all snakes in Bosnia and Herzegovina. A closely related form (*Vipera ammodytes meridionalis*) takes the place of the typical form in Greece and European Turkey.

#### The blunt-nosed viper and its allies.

The blunt-nosed viper (*V. lebetina lebetina*), also called kufi, is found on the island of Cyprus and in Europe on Melos (one of the Cyclades Islands), and has an extensive range in Asia and Africa. Some poorly defined varieties occur, among them a form called *wanthina* from Asia Minor and others named *mauritanica* and *deserti* from Morocco, Algeria, and Libya. Large examples are 4½ or 5 feet long. They live in rocky regions and are nocturnal in habit.

#### INDIA, CHINA, JAPAN, AND MALAYA

This region is very well provided with poisonous snakes. Representatives of the Viperidae (true vipers), Crotalidae (pit vipers), Elapidae (cobras and kraits), Hydrophidae (sea snakes) and Colubridae (colubrine snakes) are found here, comprising examples of all existing families containing dangerous poisonous snakes. The most spectacular are the cobras, although the daboia (or Russell's viper) is one of the commonest and deadliest snakes of India.

#### THE VIPERS

Although the total number of species known from Asia is not large, this family (Viperidae) represents some of the most dangerous of all poisonous snakes.

#### The daboia, tic-polonga, or Russell's viper.

This beautiful serpent (*V. russellii*, pl. 9, fig. 1), more than 5 feet in length at its maximum, is pale brown with 3 longitudinal series of yellow-bordered black rings enclosing spots of chocolate brown. A very loud warning hiss is given when the snake is disturbed. It will not strike until considerably irritated. The venom is secreted in large quantities. The snake is found nearly everywhere except in dense jungle, preferring open, sunny regions. It is nocturnal in habit and feeds by choice upon rats and other small mammals. It is found in India, Ceylon, Burma, Siam, the Malay Peninsula, and southern Yunnan in China. The period of gestation is more than 6 months, the litter of about 30 young being born usually in June and July; they are less than a foot long.

**The carpet or saw-scaled viper.**

This little snake (*Echis carinatus*) burrows in the sand to hide, hence prefers sandy places throughout its range through Syria and Persia into India. Its common name, "saw-scaled," is given by reason of the fine, sawlike "teeth" down the center of the lateral scales. It reaches a length of 2 feet, but in spite of its small size it is very fierce and aggressive.

A related species, *E. coloratus*, is known from Arabia and Palestine.

Another small viper of a different genus (*Azemiops feae*) grows to a length of 2 feet. It is extremely rare, only about four specimens ever having been collected in Upper Burma and in southern China (Szechwan and Kiangsi). It resembles a harmless colubrine snake in appearance, being blackish above with 15 narrow transverse white bands. Nothing is known about its venom.

**THE PIT VIPERS**

Asiatic members of this family (Crotalidae) used to be considered as part of the family Viperidae. A more correct estimate of their distinctness is obtained by putting them into the family of which the New World rattlesnake is the representative. The Old World crotalids, however, do not have any rattle. The following belongs to the same genus as do the copperhead and moccasin described under North American poisonous snakes.

**The mamushi and its relatives.**

This snake (*Agkistrodon blomhoffii*) is restricted to the Japanese islands, although close allies are found on the Asiatic mainland. Average specimens are about 20 inches long. The pattern consists of a series of dark brown rhomboid blotches on each side near the center of the back, separated by a pale grayish band which lightens nearly to white next to the dark blotches. Some specimens are much darker.

One of the most poisonous species of the genus is *A. rhodostoma*, found in Malaya. Its pattern is very striking—angular, dark brown, black-edged markings on a reddish-brown background. The snout is pointed, and as the posterior part of the head is widened, the serpent has a very sinister "lance head."

Some of the other species are very abundant. *Agkistrodon halys* and its relatives are the commonest poisonous snakes in China and the Himalayan region west almost to southeastern Europe.

**Bamboo snakes and their allies.**

Some of the Asiatic members of the genus *Trimeresurus* closely correspond to the palm vipers of tropical America. They are the arboreal species with prehensile tails and green coloration, such as *Trimeresurus gramineus*, the bamboo viper, and its relatives. Some

species of *Trimeresurus* are terrestrial, and these are also like *Bothrops* of the American Tropics. The head is always broad and distinct from the neck, while the body is not very stout in this genus. The arboreal species are particularly slender. The fangs are proportionately very long, and the bites are dangerous, although the venom is not quite so toxic as that of some of the true vipers. The habu (*Trimeresurus flavoviridis*) grows to a length of 5 feet in the Riu Kiu Islands, and its bite is considered to be very serious.

#### COBRAS AND KRAITS

These snakes (family Elapidae) are slender in build, with the head scarcely enlarged. Some species of cobras have more or less expansible "hoods" behind the head, produced by moving the ribs forward inside the loose skin.

##### Indian or spectacled cobra.

This snake (*Naja naja*, pl. 9, fig. 2) is probably the best known of any of the poisonous snakes of Asia, as it takes more lives and is more feared than the others. It grows to be about 6 feet long, and is yellowish or dark brown in color, with a more or less spectacle-shaped black and white marking on the raised hood. Occasionally the hood has no pattern, sometimes there is a single spot. The cobra is nervous and excitable, spreading the hood and arching the neck when disturbed. It strikes with a forward sweep of its raised body, accompanied by a sharp hiss. This striking is not nearly so quick as the darting of a viper's head, which strikes laterally from the bent neck. The cobra becomes irritable, sometimes gliding forward to attack its enemy, but there is no deliberate rush, and the snake can be held off with a light stick. When it bites, it retains its hold just as the coral snake does, since the fangs are relatively short, and a larger amount of poison can enter the wound with the longer contact. The cobra feeds on rats, mice, and frogs by choice, and often takes up its residence in the dark corners of a native hut in order to prey upon the rodents attracted to human habitations. This snake is accountable for more deaths from snake bite than any other species. It is impossible to state accurately just how many people in India die each year from its bite. Owing to the natives' habit of going bare-legged, especially at night, fatal accidents from cobra bite are unnecessarily numerous. On plantations where the natives are made to take precautions, and where serum is available, fatalities have greatly decreased. The Indian cobra and its very closely allied subspecies occur from the eastern shores of the Caspian Sea through Asia into China and Formosa, the Malay Archipelago, and the Philippines.

Some cobras of this species have the habit of spitting venom at an intruder. One from Java was observed to eject poison in a spray



from the partly opened mouth for a distance of 2 feet. Cobras that spit have likewise been reported from the Philippines, the Malay Peninsula, Burma, and Ceylon. There seems to be no report from China or mainland India west of Bengal of a cobra spitting.

#### The king cobra or hamadryad.

The king cobra (*Naja hannah*, pl. 10, fig. 1), largest of all poisonous snakes, has been authentically reported as reaching a length of 18 feet 4 inches. While its anterior ribs are elongated, it cannot spread a hood nearly so wide proportionately as that of its smaller relative. It feeds almost exclusively upon other snakes and probably ranks first as a wholesale destroyer of snakes, taking kraits and smaller cobras along with the harmless species. It occurs in eastern India, China, and the Philippines, as well as the Malay Archipelago. It is diurnal and lives in dense jungles near streams, sometimes climbing trees. It is said to be fearless and may attack human beings when disturbed. It lays from 21 to 33 eggs on a pile of leaves, and these eggs are guarded by the female. In captivity it displays an intelligence very unusual in snakes by learning, after a very few days, not to strike its head against the glass of its cage. The color is olive or yellowish brown, often with black rings on the body.

#### The kraits.

The common krait (*Bungarus candidus*) grows to a maximum length of 4 feet. It is lustrous black or brown above, with narrow white bands across the back; below it is pearly white. It is one of the most numerous snakes where it occurs and likes to live near human dwellings, also in fields or low scrubby jungle near water. Its food consists almost entirely of other snakes, occasionally frogs, lizards, and small mammals. It is one of the most inoffensive of snakes, hiding its head beneath the coils of its body and refusing to move when teased. Like the cobra, it lays eggs, 6 to 10 in a clutch, usually in soft earth. Experiments show that its poison is four to five times as virulent as that of the cobra. It has a wide distribution throughout India and the Malay Archipelago to Formosa and southeastern China. Members of this genus can be recognized by their ridged backbone, on which there is a row of widened, enlarged scales. They are nocturnal in habit.

The banded krait (*Bungarus fasciatus*, pl. 10, fig. 2) prefers jungle districts. It is ringed with yellow and black bands. It is even more sluggish than the common krait. In India the banded krait is restricted to the northeast, occurring no farther south than the state of Hyderabad. The common krait is found throughout peninsular India and is the only one south of the Ganges Basin. Their ranges overlap in Siam, Burma, the Malay Peninsula, Java and Sumatra.

## THE SEA SNAKES

The sea snakes (family Hydrophidae) live in the tropical parts of the Pacific and Indian Oceans. They occur along the coast of Asia from the Gulf of Persia to southern Japan, among the islands of Oceania, and to the coast of tropical Australia. All the species but one stay close to the shallow waters near the coast, especially near river mouths. They feed entirely upon fish. Those sea snakes with the smallest heads and slenderest bodies limit their diet to eels. Sometimes on a calm day they are to be seen, often in hundreds, basking upon the surface of the water. Their structure is well adapted to an aquatic existence, since the tail has become compressed and rudder-like, while the ventral plates are much reduced in most of the species, appearing like the rest of the small scales covering the body. The poison of at least one of the species is known to be more deadly than that of the Indian cobra, while some are said to be only slightly poisonous. They are not inclined to bite except when forcibly restrained and are said never to attack bathers in the water. Fishermen are sometimes bitten when they haul in a sea snake along with their net of fish, and sometimes fatalities result, because these fishermen do not think of seeking trained medical assistance. All sea snakes bear their young alive, 2 to 18 at a time, in tide pools and shallow flats of deserted shores. Few sea snakes exceed 4 feet in length, although examples of two species have been found measuring nearly 9 feet.

## AFRICA

The Dark Continent has nearly as great an array of poisonous serpents as is found in Asia. While the king cobra of southern Asia claims the record of being the world's largest poisonous snake, Africa has the distinction of having produced 2 kinds of spitting snakes—both cobras—which blow their venom into the face of the attacker from a distance up to 12 feet. Africa is the home of about 30 kinds of true vipers also, some of them very peculiar.

Since sea snakes do not occur in Atlantic waters, it is only on the east coast of Africa that we find an occasional example of the same far-traveling species that occurs on the western coast of Central America.

No pit vipers occur in Africa. The remaining family containing dangerous poisonous snakes is the Colubridae, of which one section, the rear-fanged snakes, is represented in Africa by the boomslang and a number of other snakes having poisons of varying degrees of toxicity.

No poisonous snakes are found on the island of Madagascar.

## THE VIPERS

**The night adder or Cape viper.**

As its name indicates, this snake (*Causus rhombeatus*, pl. 11, fig. 1) emerges at night to hunt for rats, mice, and toads. It is rather inoffensive, and unless hurt or frightened, it does not attempt to bite. It grows to be about 3 feet long. It is yellowish or gray in color, with a chain of dark, light-edged spots along the back, and smaller ones on each side. There is a dark chevron at the back of the head. The snake hides in rubbish heaps, rock piles, or shallow holes when not hunting. It frequently enters farm houses in its search for rodents. It is very common around Nairobi and extends from the Nile over the greater part of South Africa. The poison is not so highly toxic as in many of the other vipers. A peculiar anatomical feature is the extension of the poison glands into the neck to several inches behind the head. Another interesting peculiarity is that this snake and others of this genus lay eggs, while most of the other vipers are viviparous.

**The puff adder.**

This snake (*Bitis arietans*, pl. 11, fig. 2) is one of the most widely distributed in Africa, being found all the way from southern Morocco and the southern Sahara to the Cape of Good Hope, as well as in Arabia. It likes grassland, rocky regions, or light forests, especially near streams, but is not found in heavy forests or at very high altitudes. It grows to a length of 5 feet and is massive and bloated in appearance. The head is flat, and the nostrils are on top of the snout. The skin is deep golden yellow to orange brown, with regular chevron-shaped brown or black bars pointing backward, with a large dark blotch edged with light yellow on the crown of the head. It often lives around houses in order to feed on the rats and mice. When disturbed, it suddenly hisses by exhaling its breath. It is not aggressive, but when danger threatens it can strike with lightning speed. It is extremely prolific, a female laying up to 72 eggs at a time. Sometimes the young are born before the egg is laid; more usually hatching occurs immediately after the fully developed egg is deposited. The bite is extremely dangerous, as the great length of the fangs causes the venom to be injected deeply into the tissue. This venom is highly active neurotoxically as well as haemotoxically, and because of the snake's size a very large quantity can be injected at a bite. Cattle when grazing often get struck, and in the absence of an injection of the proper serum rapidly succumb. Another closely related snake, the Cape puff adder (*B. inornata*), is restricted to South Africa.

**The rhinoceros viper.**

With a pair of horns jutting from its nose, its swollen, wicked-looking head, and its stout, ponderous body covered with rosy, purple,

blue, yellow, or brown colors—brightest after the skin is shed—the rhinoceros viper (*Bitis nasicornis*, pl. 12, fig. 1) is a most astonishing creature. One would expect that these bright hues would make the snake very conspicuous, but on the contrary they render the serpent almost invisible in the swampy regions near streams, especially when its rough scales are caked with mud. Another common name, the river jack, is derived from its partially aquatic habits. It does not seem to grow longer than 4 feet. It is peculiarly placid and inoffensive in disposition and is said to be most reluctant to bite, although the venom may be even more toxic than that of the following species. Its food habits are not known, although presumably from its aquatic habits it may add frogs, toads, and even fishes to the usual viperine diet of rodents. It is practically confined to the rain forest, including Liberia, the Gold Coast, Togo, Nigeria, Cameroon, Portuguese Guinea, Belgian Congo, Uganda, and part of Kenya Colony.

#### The Gaboon viper.

This malevolent-looking serpent (*Bitis gabonica*, pl. 12, fig. 2) is very highly poisonous, and its prey is killed almost instantly by injections driven deeply with the long fangs. Its venom is particularly deadly as far as mankind is concerned, for it contains both the normal viperine haemotoxic elements and powerful neurotoxic properties. It lives in heavy forests in West Africa. It is known to reach a length of 5 feet 8 inches, the fangs of such a monster measuring nearly 2 inches, and the body nearly 15 inches around. It is not usually aggressive and has the habit of deflating its body in a loud hiss. It feeds upon small mammals and birds, toads and frogs. There is a series of oblong buff markings on the back, surrounded by rich brown and purplish spots; the sides have irregular brown or purple spots, the points directed upward. The ground color of the skin is pinkish brown. The eyes are silvery. Sometimes there is a blunt or forked horn on the nose.

#### The horned adders.

Two of these small snakes (*Bitis cornuta* and *B. caudalis*) have one or more hornlike scales over the eye, hence their common name. They are no more than 1½ feet in length but are extremely dangerous in spite of their small size, owing to their habit of burying themselves in the sand with only the head above, where they lie for hours watching for lizards and other small creatures on which they feed. They bite instantly at the bare feet of any native who may come near them, for they are practically invisible as they lie hidden. They occur only in the sandy areas of the southern part of Africa.

The berg adder (*B. atropos*) as its name indicates, lives upon the mountain ranges throughout the whole of South Africa. It devours

lizards and the young of ground-nesting birds, as well as insect larvae, and mice and rats. It is highly venomous.

#### The sand vipers.

The Sahara Desert harbors two species of sand vipers (*Aspis cornuta*, *A. vipera*, pl. 13, fig. 1) admirably adapted for life in dry desert sand. The ribs are capable of flattening the body, and there is a muscular arrangement that permits the snake to use the sharp edges of its flattened body to shovel sand over its back by a sort of wavy motion that permits the body of the snake to sink quickly below the surface, where it lies with the top of its head protruding. The eyes are above the general level of the top of the head, and are the same color as the sand, so the snake cannot readily be seen. *Aspis cornuta* has a small, sharp spine over each eye, which is lacking in *A. vipera*. While these two species resemble the horned adders of South Africa in habits, their ranges are widely separated, and there are several structural features to distinguish them.

The carpet viper (*Echis carinatus*), living in sandy regions of Africa north of the Equator likewise occurs in Arabia, Persia, and India, as mentioned above (see p. 297), unlike most other poisonous snakes of Africa, which are confined to their own continent. It sometimes burrows to hide but is not confined to arid plains, since it is found on grassy, sandy plains or even in sandy forest land. It is less than a yard in length, marked with square brown spots on a cream or reddish ground color. It is nocturnal by habit and largely insectivorous.

#### THE COBRAS AND THEIR ALLIES

Except for Australia, there are more different members of this family (Elapidae) in Africa than in any other part of the world. They are terrestrial, aquatic, or arboreal, and some kind is found in almost every region of Africa except the snow-clad mountain tops and sterile deserts. The traveler has to fear not only the biting at close range but the "spitting" of venom from a short distance by some species. These will be considered first.

#### The ringhals or spitting snake.

This snake (*Haemachates haemachatus*, pl. 13, fig. 2) differs from other cobras in having keeled scales, so that the skin is not so shiny and sleek as that of its relatives. It is the smallest of the cobras, averaging about 4 feet in length. It is black with irregular cross bars of brown above, and the throat often has one or two white or yellowish bands, hence its Dutch name of ringhals (ring neck). The ringhals is aggressive when disturbed and will advance on a man or even pursue him for a considerable distance. The danger from this snake comes when people stoop toward the ground or rock pile where

an alert ringhals may be lying, as the venom is ejected in two streams from the fangs, accompanied by the expulsion of air from the lungs, so that it is sprayed in a fine shower for several feet. The entry of venom into the eyes causes intense pain, followed by inflammation and partial or total blindness. The eyes should be promptly and efficiently treated by washing at once with water and boric acid. The poison is not harmful when it falls on the unbroken skin. Eye-glasses or goggles afford adequate protection to the eyes against the spray of venom. Owing to its small size, the ringhals can throw its venom only about 6 feet. The bite of the ringhals is as deadly in proportion to its small size as that of any other cobra. Unlike most cobras, this snake produces its young alive, in litters of from 24 to 60. It is common throughout South Africa.

#### **The spitting or black-necked cobra.**

The black-necked cobra (*Naja nigricollis*) also sprays its venom. Larger in size, it is even more formidable than the ringhals. It has a much wider range than the ringhals, being found from upper Egypt to Angola and the Transvaal, and is very common in some regions. It rears and "spits" upon slight provocation, and the venom is effective at distances up to 12 feet. The snake is 7 feet long when fully grown, and since it rears its head to a height of 3 feet from the ground, its attack is unexpected and overpowering. The effect of the venom on the eyes of the victim is as disastrous as that of the ringhals. It is probable that if nothing were done to dilute or wash away the poison from the absorbent membranes of the eyes, blindness would result. Not enough of the poison seems to be absorbed to cause death, however. This snake may be lustrous black, olive, brown, or salmon pink in color. The black variety may show a pair of large crimson blotches under the hood when this is spread. The lighter-colored specimens have a black band across the throat, giving the snake its common name.

#### **The black cobra.**

This serpent (*Naja melanoleuca*) is slightly larger and heavier than the spitting cobra and looks somewhat like it. It does not spit venom but is quick to become angered and will rush to attack whoever comes near. It is confined to tropical Africa. The shiny texture of its skin distinguishes it from the dark variety of the spitting cobra.

#### **The Egyptian cobra or asp.**

This snake (*Naja haje*, pl. 14, fig. 1) is the most widely distributed of the African cobras, being found in the whole of North Africa except in the coastal area of Algeria. It is especially numerous in countries bordering the Sahara and extends through East Africa all the way to Natal. Its color is dull brown, blending well with the

hot, dry sand through which it prowls in search of rats and mice. It takes freely to water, where it devours frogs and toads. It grows to 6 feet in length. By disposition it is very irritable, hissing and striking repeatedly at the slightest disturbance.

#### The Cape cobra.

The bad temper and ferocity of this snake (*Naja flava*) is well recognized in the south of Africa, where it occurs from Cape Colony to southern Tanganyika. It is found with several different colorations, individuals being yellowish, reddish, brown, or black. It frequently climbs trees in search of young birds and eggs.

Several other species of cobras inhabit rather restricted areas in West Africa or Angola, some of them nearly "hoodless" but otherwise unmistakably cobras.

#### The water cobras.

These aquatic cobras (*Boulengerina*, pl. 14, fig. 2) live in Cameroon, the French and Belgian Congos, and in Lake Tanganyika. In the last-named place they stay around rocks, on top of which they bask in the early morning sun before taking to the lake. They grow to around 8 feet in length. Their degree of toxicity is not definitely known, but out of the water they are apparently not nearly so aggressive as the true cobras. Most of them have a black bar behind the head, followed by a number of black, usually light-centered spots. They probably seldom go far from water.

#### The mambas.

These deadly snakes (*Dendraspis*, pl. 15, fig. 1) are set apart from the other poisonous snakes of Africa by their extreme slenderness. This makes them admirably adapted for an arboreal existence, and their green or blackish coloration makes them almost indistinguishable among the stems of climbing vines. The head is narrow and the eyes large. The mamba looks rather like the harmless tree snakes of similar build found in the Tropics of both hemispheres. When it opens its mouth, however, there is no mistaking its poisonous character, for the large fangs are situated at the very front of the mouth. One species may be as long as 12 feet, a length unmatched anywhere among elapine snakes except by the king cobra of southern Asia. In striking, it takes advantage of its length by doubling back its neck laterally and then lunging forward nearly half of the body length. Birds and small rodents comprise its food; in searching for the latter it often takes to the ground and even enters native huts. There are several species of mambas now recognized, and in distribution they pretty well cover the southern part of Africa north to Abyssinia and the Niger. Mambas are said to be very sociable, several males and females being frequently found inhabiting the same hollow in the trunk

of a tree, a crevice among boulders, or a hole in a bank, and often sharing their retreat with a black-necked cobra. The eggs are laid in dense vegetation, and the young snakes take to the trees as soon as they are hatched.

#### THE REAR-FANGED SNAKES

##### The boomslang.

The boomslang (*Dispholidus typus*) belongs to the rear-fanged group of the family Colubridae and in build is like one of our racers. The color varies greatly, from green through all shades of brown to black, the scales of the lighter-colored individuals often being edged with black. An adult may measure over 6 feet in length. Its name in Dutch means "tree snake," and the trees are its natural environment. In sparsely wooded country it takes to the ground to hunt frogs, lizards, ground birds, caterpillars, and various insect larvae. The eggs are laid in decaying vegetation on the ground. When biting, the boomslang does not readily let go when once it has seized its prey. Unless its grip is complete, the fangs do not penetrate the flesh, since they are set halfway back in the upper jaw under the eyes. Fortunately this snake is very timid and will make off into the bushes at the slightest alarm. When it bites, however, its venom is very active, and the results may be fatal to human beings, as they undoubtedly have been fatal to dogs, oxen, and other farm animals.

#### AUSTRALIA, NEW GUINEA, AND THE SOUTH PACIFIC ISLANDS

Aside from the sea snakes of the family Hydrophidae which live in the waters of the northern coasts, Australia has but one family of poisonous snakes, the Elapidae.<sup>12</sup> This family has an extremely large representation there, however, as 14 genera and 80 species are known. While a number of these are not considered dangerous to man owing to their small size, short fangs, and timid dispositions, the larger kinds are outstanding for their abundance, insolence, and high toxicity. There is a great range in the toxic power among the really dangerous species. While the action of the poison is more largely neurotoxic—as in other members of the Elapidae throughout the world—there are some haemolytic effects as well. Most of the cases of snake bite in Australia could be avoided by the use of boots and leggings, as the snakes do not rear very far from the ground in attacking, and few are aboreal, hence the feet and legs of a pedestrian are in most danger of being struck by the fangs.

New Guinea has, in addition to a liberal population of sea snakes, several representatives of some of the deadly kinds found in Australia.

<sup>12</sup> Australia is the only part of the world where a majority of the snakes are venomous.



There are no snakes in New Zealand, poisonous or nonpoisonous. The Hawaiian Islands are likewise devoid of them, as well as most of the scattered islands of the South Pacific. One genus of the family Elapidae, *Ogmodon*, is found in the Fiji Islands. Several of the same family occur in the Solomon Islands, while some of the sea snakes live in the surrounding waters.

#### The black snake.

This snake (*Pseudechis porphyriacus*, pl. 15, fig. 2), most abundant of the larger poisonous kinds of Australia, grows to a length of 6 to 7 feet. The smooth scales are satiny blue black above, while below they are brilliant scarlet edged with black. The neck is slightly extensible so that a "hood" about half as broad as that of a cobra can be formed. When about to attack, it does not rear like the cobra, but instead raises the head only a few inches from the ground. It will not attack man unless trodden upon or cut off from means of escape. It prefers marshy places or streams and dives and swims well. It can stay under water for a long time, and from its habit of lying still at the bottom of lakes and streams it is dangerous to bathers. Its food consists of frogs, lizards, and small mammals and birds. The young are born alive in March, up to two dozen to a litter. During the winter the black snake hibernates in holes in the ground. It is found throughout Australia, except in the north, but does not occur in Tasmania. Its bite is said to be less dangerous than that of the other large Australian snakes, owing to the lower toxicity of its venom.

Several other snakes of the genus *Pseudechis* live in Australia. One of these, inhabiting central Queensland, grows to be 9 feet long, with proportionately large fangs and poison glands.

A still larger snake, the giant brown snake (*Oxyurannus scutellatus*), belongs to a closely related genus. It is restricted to Cape York Peninsula. It is known to reach a length of over 9 feet.

#### The copperhead snake.

While a reddish-brown or dark-brown color usually characterizes this snake (*Denisonia superba*, pl. 16, fig. 1), occasionally a bright red or black individual is found. The head is usually of a coppery tone, especially so in the young ones. It is a stouter-bodied creature than the black snake and does not grow quite so large, as 6-foot specimens are considered uncommonly large. When angry, it is said to rear a few inches from the ground, with the neck slightly curved, as the cobra does. Like the black snake, it frequents swamps and feeds on lizards and frogs. It is found in southeastern Australia and in Tasmania.

There are about two dozen other closely related species belonging to this genus in Australia, some of them being no more than 15 inches long and with relatively weak venom.

**The brown snake.**

The larger members of the genus *Demansia* are considered highly dangerous, especially the brown snake (*D. textilis*, pl. 16, fig. 2), which is usually 5 to 6 feet long, and widely distributed all over Australia. It is light yellow to brown or gray above and white below. The young, hatched from eggs, are ringed during the first year. This snake has a small head, but its bite is extremely serious, owing to its highly toxic venom. The snake is all the more dangerous as there is nothing in its appearance or behavior to excite fear, since it resembles one of our whipsnakes. There are about a dozen species of this genus, and several of them are called whipsnakes, owing to their slender build.

Related forms of this dangerous snake occur in New Guinea as well.

**The tiger snake.**

The dark bands on a tawny ground suggest the name of this, the most savage and dangerous of Australian reptiles (pl. 17, fig. 1). Sometimes the ground color is so dark that the bands are indistinct. The venom is of such extremely high toxicity that it is not equaled by that of any other known snake. It seems to cause more fatalities in Australia than all the other poisonous snakes of that country put together. The tiger snake (*Notechis scutatus*), when disturbed, becomes furious, spreads out the neck to twice its usual width, and rushes toward its enemy. It resents being interfered with by other snakes and is said to be more than a match for the black snake. A man bitten by this snake may die within an hour if no treatment is given, and a dog in less than 20 minutes. The tiger snake is between 5 and 6 feet in length when full-grown, and its body is rather stout. It is extremely prolific, producing 50 or more young in a litter. Its food consists mainly of lizards. It likes dry country, hence its range is extensive both in Australia and Tasmania.

**The death adder.**

A short, thick, clumsy body not more than 3 feet long, and resembling that of a viperine snake far more than its own relatives just enumerated, characterizes the death adder (*Acanthophis antarcticus*, pl. 17, fig. 2). In color it resembles the ground it lies on, so that it may be gray, brown, pink, or brick red, depending on the sandstone of the region in which a particular individual may live. In younger specimens, bands of darker shade cross the body; these may disappear with age. It is found in sandy localities over most of Australia except in southern Victoria, as well as in New Guinea and the Moluccas, thus having the widest range of any Australian poisonous snake. The young are born alive, about a dozen at a time. It has very rough scales, even on the head, and there is a spine on the tail. Its large head bears fangs that are no longer than those of the tiger snake, and

its venom is so active that it is reckoned as highly dangerous. It is not so quick to strike as the tiger snake, but as it is likely to be stepped on, it is a constant menace.

The broad-headed snake (genus *Hoplosephalus*), the black and white ringed snake (genus *Furina*), the red-bellied snake (genus *Pseudelaps*), and their allies are not considered very dangerous to man, either because of their small size, their relatively weak venom, or their short fangs, and therefore will not be considered here. The status of the poison of some snakes, such as *Micropechis ikahekae* of New Guinea and the Solomons, is not yet established.

#### THE SEA SNAKES

This family (Hydrophidae) is the only other family of poisonous snakes found in Australia besides the Elapidae just discussed. It would be more proper to say "in the waters off the coasts," for these snakes are never found inland. Twenty-seven species have been listed from the waters bathing the northern shores of Australia; these belong to 12 different genera. Since this group has been discussed under the section on "India, China, Japan, and Malaya," it will not be further touched upon here.

#### DANGEROUS NONPOISONOUS REPTILES

Certain of the nonpoisonous reptiles may be important to man for one or more of three reasons: First, because their large size and great strength may allow them to bite, scratch, or crush whoever is unwary enough to approach them too closely; second, because their natural food may comprise rats, mice, and other pests which, if unchecked, would destroy the results of man's industry; third, because their skins, flesh, or eggs may be economically useful. While the following comments are by no means complete, they will nevertheless bring to mind some of the more dangerous nonpoisonous reptiles to be encountered in the various geographic regions, with a brief mention of their positive economic importance.

#### NORTH AMERICA

The three large nonpoisonous reptiles on this continent which may do considerable bodily harm if they are interfered with are the American crocodile, the alligator, and the alligator-snapper (a turtle); a smaller but very vicious turtle, the common snapping turtle, is also considered. The several species of soft-shelled turtles (family Trionychidae) occurring in the United States are vicious biters like their relatives in Asia and Africa, but their smaller size—not exceeding a shell length of 18 inches—does not warrant their inclusion among the more dangerous reptiles of this area.

## THE AMERICAN CROCODILE

In the United States the American crocodile (*Crocodylus acutus*, pl. 18, fig. 1) is found in southeastern Florida and in the Florida Keys, while beyond our borders it is known from the Greater Antilles (except Puerto Rico), and on both coasts of Central America from Mexico to Ecuador and Colombia. It attains a length of more than 14 feet, and for so bulky a creature it is surprisingly agile on land, being able to run with its body raised clear of the ground. It usually rushes for cover if startled while basking on the shore, but if brought to bay before it reaches the water, it can turn on its pursuer quickly with snapping jaws, at the same time dealing a heavy blow with its tail. In the water it appears to be inoffensive; nevertheless, a large one might be tempted to attack a person bathing near its haunts. Its narrow snout serves to distinguish it from its broad-nosed relative, the alligator. Its jaws are very powerful in closing, so that its bite could easily sever an arm or a leg. In Cuba, as elsewhere, it is actively pursued for its valuable hide. The flesh of the tail of all crocodilians is greatly prized as food by the natives wherever these reptiles are found.

## THE AMERICAN ALLIGATOR

The American alligator (*Alligator mississippiensis*, pl. 18, fig. 2) is found in rivers and swamps of the lowlands of the Carolinas, Georgia, and Florida, west to Louisiana, Mississippi, and the Rio Grande in Texas. Because of the industrial demand for the hides, large ones are hard to find nowadays, a 12-foot specimen being a rarity, although some as long as 15 feet probably once existed. It is timid by nature and will try to escape into deep water when surprised. Like its relative, the crocodile, it can defend itself with heavy jaws and threshing tail when the need arises. It feeds largely upon crustaceans, taking as many fish, turtles, birds, or small mammals as it can get, however. Very young alligators likewise devour insects.

## THE ALLIGATOR-SNAPPER

The savage alligator-snapper (*Macrochelys temminckii*, pl. 19, fig. 1) is a relative of the common snapping turtle, and because of its large size would be a serious menace to bathers except for its shy and secretive disposition. It is seldom found around heavily populated areas. It could defend itself very effectively against molestation by using its powerful jaws, but, as a matter of fact, accidents to human beings from its bite are very few. It attains a weight of about 140 pounds and a shell length of about 28 inches. It lies on the muddy bottom waiting for fish that may swim within its reach, enticing the fish to come near by opening its mouth, on the inside of which is a white filament of flesh, which looks like a large worm to a fish and acts as a very efficient bait.

The flesh of this turtle was greatly esteemed by the Indians, for its bones can be found on many ancient camp sites. It occurs from Texas east to southern Georgia and northwestern Florida, as far south as the Suwannee River drainage system, north in the Mississippi Basin to central Illinois.

#### THE COMMON SNAPPING TURTLE

Found practically everywhere east of the Rockies south of Nova Scotia (excepting peninsular Florida), the common snapping turtle (*Chelydra serpentina serpentina*, pl. 19, fig. 2) is one of our commonest and most aggressive reptiles. It strikes with its head as a snake does and the sharp-edged jaws, although without teeth, can cause very serious injury. A large one may weigh about 40 pounds, with a shell length of 14 inches. It is much less shy than its large relative, the alligator-snapper, and its fondness for shallow, muddy barnyard streams results in the loss of many young ducks and geese, which it catches by the foot and pulls under water to drown. It also feeds largely upon fish. Its flesh is sold in the markets, and the soup made from it ranks high on the menu of most sea-food restaurants. A subspecies occupies the peninsula of Florida, similar in habits and disposition to the common snapping turtle.

#### LATIN AMERICA

There are several kinds of large turtles found in Latin America, but none of these shows much inclination to bite even in self-defense, while their flesh and eggs are of decided value. Though snapping turtles related to those discussed above occur also in Mexico and Central America, they are rarely encountered. Several kinds of caymans and crocodiles, the anaconda, the boa, and some of the lizards large enough to scratch and bite complete the list of potentially dangerous nonpoisonous reptiles from this region.

#### THE ANACONDA

The anaconda (*Eunectes murinus*, pl. 20, fig. 1) is aquatic, often being found submerged close to the banks of rivers in the Guianas, Brazil, and Amazonian Peru. It eats birds, mammals, crocodiles, fish, or anything that it can swallow. Its tremendous muscular power could be immediately fatal to a human being who was constricted within its coils, and undoubtedly there have been some fatalities, especially among Indians who go to the river to bathe. There is a difference of opinion as to the maximum size attained by this snake, some authorities maintaining that specimens over 30 feet long have been killed. It breeds when less than half that length, however, the young being born alive. A litter from a 19-foot female weighing 236 pounds

contained 72 young snakes, each about a yard long. The leather made from anaconda hide is strong and of high quality, while its flesh can be used as food, since all snakes are edible. In Brazil its native names are *sucuri* or *sucurijuba*. Several varieties mostly based on color have been described.

#### THE BOA

The boa (*Constrictor constrictor*, pl. 20, fig. 2) has a much wider range than its relative, the anaconda, its several varieties being found from Mexico to the Argentine. Its maximum length seems to be about 13 feet. Some individuals can be quickly tamed in captivity, but others remain bad-tempered, striking and hissing with a great show of ferocity. Its sharp, recurved teeth can inflict a very severe and lacerating bite. It seldom stays long in water, but is an excellent climber and is frequently found in trees, where it goes to hunt for nesting or sleeping birds and small mammals. Its hide is much sought after, being very beautiful in color and pattern.

#### THE BELIZE CROCODILE

Found in great numbers in the Sibun swamp west of Belize, British Honduras, the Belize crocodile (*Crocodylus moreletii*) has been doubtfully recorded as far north as Tampico, Mexico. It grows to about 10 feet in length. Water beetles and insects comprise the food of the younger individuals. It is too shy to be of much danger to bathers. Its hide is valuable to commerce.

#### THE ORINOCO CROCODILE

Noted for its ferocity, the Orinoco crocodile (*Crocodylus intermedius*) is greatly dreaded by the Indians who live in the Orinoco Delta where it occurs. Early writers insisted that it was 25 feet long when full-grown, but few over 10 feet long are to be found nowadays.

#### THE CAYMANS

In Central and South America occur seven species of caymans, two species belonging to the smooth-fronted genus *Paleosuchus*, the others to the "spectacled" *Caiman*, the "spectacles" in the latter consisting of a heavy ridge of bone between the eyes, lacking in the former genus.

Very little is known about the habits and life histories of the smooth-fronted caymans. Both species are small (about 5 feet). They are found in the Paraguay, Amazon, and Orinoco Rivers. As far as is known, they are not vicious toward man.

The spectacled caymans live in streams of Central and South America. The only one that reaches a considerable length is the black cayman, *Caiman niger*, found in the Amazon, and known to reach a length of more than 16 feet. It is feared by the natives, who tell

many tales of its voracity. The Paraguayan cayman (*C. yacare*) is less than 10 feet in length, while the broad-snouted cayman (*C. latirostris*) from the Rio São Francisco and Alto Paraná is about 7 feet. The flesh, especially that of the tail, is reported to be excellent eating.

#### IGUANAS AND OTHER LARGE LIZARDS

Several kinds of large lizards (genera *Iguana*, *Conolophus*, pl. 21, fig. 1, etc.) can bite and scratch fiercely when captured. The true iguanas belonging to the genus *Iguana* are extremely plentiful over most of tropical America including the southernmost of the West Indies. The value of their flesh as food, and of their skins for leather, makes them important to man wherever they are found. Most lizards are largely insectivorous, and in the insect-plagued Tropics every natural check on the increase of insect pests is to be encouraged.

#### EUROPE AND NORTHERN ASIA

There are no nonpoisonous reptiles of sufficient size to be dangerous to man in this region. Some snakes here, as elsewhere, will defend themselves if molested by attempting to bite. As these snakes can do little more than break the skin with their short teeth, they will not be further discussed.

#### INDIA, CHINA, JAPAN, AND MALAYA

This region is particularly rich in large and dangerous, though non-venomous, reptiles. The pythons come first to mind, then the Komodo "dragon," the largest of all lizards living today. There are several kinds of smaller monitor lizards, close relatives of the Komodo dragon, able to battle fiercely with tooth and claw when their safety is at stake. The salt-water crocodile is known to be a man eater at times, and the Siamese crocodile is not blameless in this respect. The mugger and the gavial are less dangerous to man. The several kinds of soft-shelled turtles, while shy and retiring in habit, have knifelike jaws similar to those of their North American relatives and resent being disturbed in the same manner.

#### THE RETICULATED PYTHON

The snakes most frequently seen by the American public in side shows at circuses are the reticulated python (*Python reticulatus*) and the Indian python. The former is known to reach a length of 32 feet, but whether this snake or the anaconda of South America can truly claim the title of "largest snake in the world" is still somewhat in dispute. A 28-foot python weighs 250 to 300 pounds, so that it is far less bulky in proportion to its length than the heavy-bodied

anaconda. Its coils possess great constricting power, and a large python has no trouble in crushing a pig or goat, which it then proceeds to swallow whole. The tales of pythons being able to swallow an ox are utterly false, but there is an apparently authentic story of a 14-year-old boy being eaten by a python in the East Indies. Leather made from python hide is very beautiful and is much desired by the trade, and before the war a great number of skins were exported each year from Asiatic ports.

#### THE INDIAN PYTHON

Snakes of this species are welcomed by snake charmers because of their sluggish and "gentle" dispositions. Even in a wild state, the Indian python (*Python molurus*, pl. 22, fig. 2) is known to make little effort to escape, and when attacked often makes no attempt to avenge offense or injury. It is fond of lying partially submerged near the bank of a river and can remain under water entirely for several minutes. It possesses great muscular strength and, in spite of its lack of aggressiveness, can overpower a leopard with ease. It is active by day as well as by night, feeding on mammals, birds, and reptiles. Two color phases of this species are known, the individuals of one phase being light in color, the others dark. The extreme length is about 25 feet.

#### THE KOMODO DRAGON LIZARD

The Komodo dragon lizard (*Varanus komodoensis*, pl. 21, fig. 2), the largest existing lizard, was unknown to science until 1912. It occurs on Komodo, Flores, Rindja, and Padar Islands, all lying close together east of Java and south of Celebes. Small deer and wild pigs form its staple diet, with turtle eggs which it digs up on the shore where other food is scarce. It is extremely voracious, falling savagely upon a wounded member of its own species if it has the opportunity. It is naturally wary toward man, but fights desperately when cornered, using the tail as a means of defense, as the crocodilians do. Its maximum size appears to be about 10 feet, and such an individual may weigh 250 pounds if in good condition. In walking, it swings its head from side to side close to the ground, usually dragging the tip of the tail. The young lizards before they are strong enough to pull down larger game climb trees to hunt for birds' eggs. The old ones make burrows between tree roots and sometimes under rocks.

#### OTHER MONITOR LIZARDS

Nearly 20 species of monitors (genus *Varanus*) live in southern Asia and Malaya. After the dragon lizard, the largest of these, measuring 8 feet in total length, is the kabara goya (*Varanus salvator*), also called water monitor by the English because it is more



aquatic than the other Asiatic species. It climbs trees in search of food, but when frightened, it takes to the water for safety and has been seen swimming far out at sea. It can run at good speed when pursuing its prey on land. The soft-shelled eggs, from 15 to 30 in a clutch, are laid at the beginning of the rainy season in holes on the bank of a river or in trees beside the water. The desert monitor (*Varanus griseus*) lives in arid regions of northwestern India westward throughout southern Asia to the Caspian Sea and North Africa. It retires to its own burrow or the disused hole of some other animal during the heat of the day. The other species of monitors are more or less intermediate in habits between the two mentioned. Monitors can be destructive to poultry and their eggs, but this is offset by the number of rats and mice that they destroy. They can all bite and claw with great vigor when hunted down, and the tail is often used as a lash. Other monitors occurring in Africa will be mentioned below.

#### THE SOFT-SHELLED TURTLES

Several genera of soft-shelled turtles (family Trionychidae), all very similar in appearance, occupy the region under discussion. They are fond of burying themselves in mud, with only the head and part of the back exposed, where they remain nearly invisible waiting for their food to pass, when they seize it with a quick movement of the long neck. They eat fish, mollusks, and frogs, but will take carrion also. Much of their food is found by hunting, for they are extremely voracious, and very active when swimming, although clumsy on land. The adults are vicious and powerful creatures, some species with the upper shell nearly a yard long. They are dangerous to handle, for they can give severe bites. Their long flexible necks enable them to reach most parts of their body, and when catching them the only place to hold them with safety is the margin of the soft disk or "shell" just in front of the hind limbs. Their flesh is said to be delicious, and they are for sale in many markets of the Orient.

#### THE SALT-WATER OR ESTUARINE CROCODILE

The salt-water or estuarine crocodile (*Crocodylus porosus*, pl. 22, fig. 1) can without any doubt be called the giant among living reptiles, because authentic specimens measuring more than 20 feet are known from the Philippines. The species ranges also to the east coast of India, Ceylon, Malaya, the north coast of Australia, the Solomon and Fiji Islands. It lives in the mouths of muddy rivers and canals near the sea, seldom ascending a river above tidal limits, and has been found several miles out to sea. Its huge size enables it to overcome large and powerful animals. It is the species that causes most of the annual loss of human lives in Asia which is attributed to crocodiles. When an individual

has once acquired man-eating habits, it appears to have a preference for human beings as food, probably because they are more easily obtained than wild beasts. It is only the adult crocodile that is able to attack man and large animals. Fish, birds, and turtles are likewise relished. Young ones eat crustaceans and even insects. The female makes a nest of reeds and rushes, the heat of decomposition of which incubates her eggs. The Burmese and some other Asiatic races are fond of the flesh of this crocodile, while the Siamese trap it for its gall bladder, believed by them to have remarkable medicinal powers.

#### THE SIAMESE CROCODILE

While the Siamese crocodile (*Crocodylus siamensis*) grows to a length of nearly 12 feet, it is not as a rule aggressive toward adult human beings, although small children are said to be seized sometimes. In the rivers it prefers to stay above the tidal limits. It feeds chiefly upon fish. Its flesh is sometimes eaten but is no longer a regular article of commerce.

#### THE MUGGER

Two other popular names of the mugger (*Crocodylus palustris*) are the marsh and the broad-snouted crocodile. Its range extends throughout the whole Indian Peninsula and Ceylon, west almost to the Persian frontier in Baluchistan, north to Nepal and east to Assam. It lives in swamps and rivers, usually above the tide line. During the dry season it buries itself in the mud and aestivates until the rains come. It feeds chiefly on birds and fish, and only occasionally attacks man. The mugger is hunted by the natives of Sind, but only as a defensive measure in order to protect their fish.

#### THE GAVIAL

Living in rivers of India and Burma, the gavial (also spelled gharial) (*Gavialis gangeticus*) reaches a length of over 21 feet. Its food consists mostly of fish, with some birds, and it has been known to seize goats and dogs. It rarely attacks man and hence is little feared.

#### AFRICA

The dangerous nonvenomous reptiles found in Africa belong to the same groups as those found in Asia—in fact, one or two are of identical species on both continents.

#### THE ROCK PYTHON

Reliable records indicate that the rock python (*Python sebae*, pl. 23, fig. 1) grows to a length of at least 25 feet. It is found all over Africa except in Egypt and the Mediterranean and desert regions of the north. It is common in some localities and remains so even in the vicinity of

some native villages, for it is often reputed to be supernatural, hence is avoided by the people of the region. Wart hogs are said to kill pythons sometimes, and crocodiles may occasionally become involved in a struggle when the snake drinks at a river. In Natal the rock python is a valuable ally of the sugarcane growers, for it devours considerable numbers of rats and is the chief enemy of the destructive cane-eating rat. Pythons are in consequence encouraged, and semitamé specimens frequent most of the sugar factories. There are very few authentic cases of human casualties due to the rock python's embrace, although there are plenty of instances of fully adult persons being caught who were strong enough to get away.

#### THE WARAL AND OTHER MONITORS

The waral (*Varanus niloticus*), sometimes called the Nile monitor, is found all over Africa except in the northwestern part, being especially conspicuous along the banks of the Nile. It is more or less aquatic in habit and lives largely on fish, but eats rats and mice with avidity also. Its habit of digging up and eating the eggs and young of the crocodile is sufficient reason to ensure its respectful regard by the natives. Its total length when full-grown is slightly over 5 feet.

Several other monitors occur in Africa, though ranging over a less extensive area than does the waral. Some live in desert regions, one of these, *Varanus griseus*, being found in southern Asia. All can bite and scratch fiercely, and the tail-lashing habit is more or less prevalent.

#### THE NILE CROCODILE

The Nile crocodile (*Crocodylus niloticus*) attains a length of 17 feet, and is generally abundant from the Nile to the Senegal, and south to the Cape of Good Hope, as well as in Madagascar. It is extremely vicious and dangerous, taking many lives each year. Its food consists chiefly of fish, with birds and mammals unwary enough to come near it. The eggs are laid in dry sand, 40 to 60 in number, and are about the size of goose eggs. The young are nearly 6 inches long when hatched. They make for water at once, although many of them become the prey of the Nile monitor (*Varanus niloticus*) as already mentioned. The ancient Egyptians worshiped the crocodile, and its mummified remains have been found in tombs dating back thousands of years.

#### THE LONG-SNOUDED CROCODILE

The long-snouted crocodile (*Crocodylus cataphractus*) is definitely a West African species, being confined to the Congo basin. It attains a length of 12 feet. Like that of the gavia of India, its elongated snout is ideally adapted for fishing. Young individuals feed on anything they can find, including shrimps, crabs, frogs, snakes, fish, and even

grasshoppers. Not many accidents from the bite of this crocodile are reported; this may be due to the fact that palisades are erected in the river near villages where crocodiles occur, providing places of safety for bathing and obtaining water.

Two other crocodiles, *Osteolaemus tetraspis* and *Osteoblepharon osborni*, are characteristically West African in distribution. The former has a very short, turned-up snout but otherwise looks much like the latter. Both are rather small, not exceeding 5 feet, and probably are not at all dangerous to man.

#### THE AFRICAN SOFT-SHELLED TURTLE

The African soft-shelled turtle (*Trionyx triunguis*) frequents the Nile, the Congo, and the Senegal Rivers and their tributaries, as well as rivers in Syria. When fully grown its shell is over a yard in length, and its body weight 200 pounds. It has all the biting ability of its relatives in Asia and in North America. In all parts of its range this turtle is hunted and eaten by the natives.

#### AUSTRALIA

Except for the large pythons and some monitor lizards and the salt-water crocodile, this region has few nonpoisonous dangerous reptiles.

#### THE DIAMOND PYTHON

The diamond python (*Python spilotes*) grows to a length of 20 feet, hence ranking with the half-dozen or more largest living serpents. In addition to eating rats, mice, and rabbits, it destroys some of the rarer and more valuable Australian mammals. Its skin is much sought after, and python farming for commercial purposes may some day be a reality.

#### OTHER LARGE SNAKES

It is necessary to give only a brief mention of the six or seven other large members of the python family (genera *Python*, *Liasis*, *Aspidites*) found in Australia, some of which are said to grow to 16 feet in length. They are mostly arboreal in habit and have great muscular power in constricting.

It is well to emphasize again the fact that a great many Australian snakes not of the python family are dangerously poisonous.

#### THE GOANNA

The goanna (*Varanus varius*) is also known as lace monitor or (erroneously) as the iguana. It climbs trees habitually for birds' eggs and young birds. It is equally fond of poultry and makes itself a nuisance in the henyards of populated areas. It bites severely with its sharp teeth if handled incautiously.

The skin of the goanna is in even greater demand for shoes than snake skin, as it is tougher, and is very attractive when properly prepared.

#### GOULD'S MONITOR

Unlike the preceding species, Gould's monitor (*Varanus gouldii*, pl. 23, fig. 2) does not take to trees, but lives on the ground in holes and is usually found in waterless districts. It is much less vicious than the goanna, although it hisses loudly if vexed and inflates the loose skin of the body. It grows to a little over 4 feet in length.

Other Australian monitors are more or less intermediate in habits between these two.

#### THE SALT-WATER CROCODILE

The salt-water crocodile (*Crocodylus porosus*), a dangerous man eater, has already been discussed under the section on Asia, since it ranges there as well as in northern Australia. It infests the tidal mouths of streams especially in North Queensland, and when surprised it actively resents any intruder's presence. It has excellent hearing and is very difficult to approach for this reason, as it slides into the water at the slightest sound. It ascends water courses, so that the clear pools of fresh water in the upper reaches are by no means safe for bathers.

### APPENDIX

#### FIRST-AID TREATMENT

While it is not within the scope of this paper to give any medical advice as to the treatment of cases of snake bite, it is desirable to republish the first-aid directions contained in a leaflet issued by the makers of standard antivenin serum. They say:

#### IN CASE OF BITE

Snake bites should be treated immediately. The following first-aid measures should be employed:

#### FIRST AID

Apply constricting band above bite just tight enough to prevent absorption and not interfere entirely with flow of blood. A cold, numb limb means constriction is too tight and should be loosened.

Make deep X-shaped cuts  $\frac{1}{2}$  inch long through skin at points where fangs entered skin. Let the blood flow from these cuts. Make additional cuts at edge of swollen area. Help flow of blood from these cuts by suction. Make suction for 15 or 20 minutes every hour for several hours. In interval between suction treatment, cover with cloths wet with strong solution of table salt or epsom salts in water.

Don't cauterize the wounds or apply potassium permanganate.

Don't run or exercise. Don't take any alcoholic stimulants.

## ASSOCIATED TREATMENT

Of general measures apart from antivenin, sedatives such as morphine or aspirin, or small doses of a barbiturate may be given to relieve pain and nervousness. For collapse, strychnine, aromatic spirits of ammonia or other general stimulants are of some value. In all severely poisoned persons, great relief is likely to be experienced from the infusion of a large amount of physiological saline, or still better, transfusion of blood, the effects of which may be life saving in borderline cases.

## ANTIVENIN AND ITS PREPARATION

Antivenomous serums used to combat the deadly effects of the bites of poisonous snakes are prepared by medical institutions in many countries. In the United States the Sharp and Dohme Laboratories at Glen Olden, Pa., furnish a serum effective against the bites of all the important poisonous snakes to be found in this country, as well as serums for use in tropical America.

"The first step in preparing an antivenomous serum, or 'antivenin,' is the extraction of the venom from the snakes by manually forcing it into a suitable container. It is then partially purified by centrifugation, dried, and stored for use. As it is needed it is dissolved, sterilized, and injected into horses, starting with very small doses which are repeated in gradually increasing amounts every week or every 2 weeks. Eventually the horses become so highly immune that they can withstand amounts several hundred times as great as would kill a normal horse. Their blood is tested periodically to determine its antivenomous potency. When it is up to a set standard, the horses are bled at regular intervals. The serum is separated from the cells and is concentrated in such a manner as to remove much of the inactive substances, leaving a highly active material that is the antivenin of commerce.

In general, it may be said that an antivenin is satisfactorily effective only against bites from snakes of the same type that supplied the venom used in its preparation. It may be useful in treating bites from closely related species, but usually it is worthless, or nearly so, in accidents from unallied types. Thus, an antivenin prepared against the venom of a rattlesnake is useless, or nearly so, in treating bites of cobras, and vice versa. Fortunately, however, it is possible to prepare one antivenin that will counteract several different venoms, merely by using a mixture of venoms in immunizing the horses. This method is used in the United States and results in a product that is effective in treating bites of all native poisonous snakes except the coral snake, bites from which are rare. Such polyvalent serums are prepared in other countries as well, and they greatly simplify the treatment of bites. When the snake responsible for the bite can be

identified beyond any doubt, it is best to use the specific antivenin, if one is available." (Nigel Wolff, personal communication.)

A famous laboratory for making antivenin for the bites of neotropical poisonous snakes is the Instituto Butantan at São Paulo, Brazil. In exchange for live snakes from which to obtain fresh venom, which are sent in by planters and farmers all over Brazil, the institute furnishes fresh antivenin to use in the many cases of snake bite occurring among the laborers clearing ground for new plantations. The death rate from snake bite in Brazil was estimated to be about 3,000 a year before the establishment of the institute. In 1930, however, after careful tabulation, the total appeared to be well under 100.

In Australia, the Commonwealth Serum Laboratories at Melbourne manufacture antivenin for the bites of the tiger snake and death adder, the two most deadly snakes of that region.

In the French colonies, various branches of the Pasteur Institute provide serums for different kinds of local poisonous snakes. The Burroughs-Wellcome products, of English manufacture, are available in India and Egypt and other areas of British influence, while the South African Institute for Medical Research, Johannesburg, supplies serum for the bite of many African species.

#### DIRECTIONS FOR MAKING SCIENTIFIC COLLECTIONS

In little-explored regions there is always the incentive of discovering unknown species, which would be of great scientific value if they could be collected and preserved for the United States National Museum in Washington, D. C. It is relatively easy to preserve snakes, lizards, frogs, and toads. All that is necessary after killing them is to make a short incision with a penknife on the ventral surface into the stomach and intestines, then they can be dropped into a solution of 1 part formaldehyde and 10 parts water and left for 2 or 3 days. They should then be changed into a fresh solution of the same strength. When they are to be packed for shipment, an empty gasoline tin should be lined with paper or straw to prevent the rust from discoloring the skins of the preserved specimens. The specimens themselves should be loosely wrapped in cheesecloth dampened with formaldehyde, with the place of collection, the date collected, and the name of the collector very plainly written with soft black pencil on heavy paper. This information is absolutely necessary, for without it the specimens are valueless. The gasoline tin may then be soldered shut, and the specimens will keep for several months without more attention. Those interested in natural history will find it a pleasant occupation for spare time to make such collections, and the collections will be assured of prompt study and identification upon their arrival at the United States National Museum.

## SELECTED BIBLIOGRAPHY

ANTIVENIN INSTITUTE OF AMERICA (NOW SHARP AND DOHME).

1927-1931. Bull., vols. 1-5. Glen Olden, Pa.

BOULENGER, E. G.

1914. Reptiles and batrachians. London and New York.

BOULENGER, GEORGE A.

1890. The fauna of British India including Ceylon and Burma. Taylor and Francis, London.

1912. A vertebrate fauna of the Malay Peninsula. Reptilia and Batrachia. Taylor and Francis, London.

1913. The snakes of Europe. Methuen and Co., London.

BURDEN, W. DOUGLAS.

1927. The dragon lizards of Komodo. G. P. Putnam's Sons, New York and London.

CONANT, ROGER, and BRIDGES, WILLIAM.

1939. What snake is that? D. Appleton-Century Co., New York and London.

CURRAN, C. H., and KAUFFELD, CARL.

1937. Snakes and their ways. Harper and Brothers, New York and London.

DE ROOIJ, NELLY.

1917. Reptiles of the Indo-Australian Archipelago. II. Ophidia. E. J. Brill, Leiden.

DE SOLA, C. RALPH.

1933. The crocodilians of the world. Bull. New York Zool. Soc., vol. 26, No. 1, pp. 2-24 (photographs), Jan.-Feb.

DITMARS, RAYMOND L.

1907. The reptile book. Doubleday, Page and Co.

1930. The poisonous serpents of the New World. Bull. New York Zool. Soc., vol. 33, No. 3, May-June.

1934. Snakes of the world. Macmillan Co.

FITZSIMONS, F. W.

1912. The snakes of South Africa. Longman, Green and Co., London.

GADOW, HANS.

1901. Amphibia and reptiles, in The Cambridge Natural History. Macmillan Co., New York and London.

GLOYD, HOWARD K.

1940. The rattlesnakes, genera *Sistrurus* and *Crotalus*. Chicago Acad. Sci., Spec. Publ. 4.

KINGHORN, J. R.

1929. The snakes of Australia. Angus and Robertson, Ltd., Sydney, New South Wales.

LUCAS, A. H. S., and LE SOUEF, W. H. D.

1901. The animals of Australia. Mammals, reptiles and amphibians. Whitcomb and Tombs, Melbourne, New Zealand, and London.

PITMAN, CHARLES R. S.

1938. A guide to the snakes of Uganda. Kampala.

POPE, CLIFFORD H.

1937. Snakes alive and how they live. Viking Press, New York.

1939. Turtles of the United States and Canada. Knopf, New York and London.

SCHMIDT, KARL P.

1919. Contributions to the herpetology of the Belgian Congo based on the collection of the American Congo Expeditions, 1909-1915. Bull. Amer. Mus. Nat. Hist., vol. 39, art. 2, pp. 385-624.



SCHMIDT, KARL P., and DAVIS, D. DWIGHT.

1941. Field book of snakes of the United States and Canada. G. P. Putnam's Sons, New York.

SMITH, MALCOLM A.

1926. Monograph of the sea-snakes (Hydrophiidae). British Museum, London.

1931. The fauna of British India. Reptilia and Amphibia, vol. 1, Loricata, Testudines. Taylor and Francis, London.

1935. Idem, vol. 2, Sauria.

STEJNEGER, LEONHARD.

1895. The poisonous snakes of North America. Ann. Rep. U. S. Nat. Mus. for 1893, pp. 337-487.

VON IHERING, RODOLPHO.

1934. Da vida dos nossos animais. Fauna do Brasil. Rotermund, São Leopoldo.

WALL, FRANK.

1907. The poisonous terrestrial snakes of our British Dominions and how to recognize them. Higginbotham, Madras.

1921. The snakes of Ceylon. H. R. Cottle, Ceylon.





The copperhead (*Lachistrodon mckezoni*) coiled on the rock and the coral snake (*Macrurus tuberosus*) crawling among the leaves represent the two most important groups of poisonous snakes. While the copperhead's relatives, the pit vipers, are found only in the New World and in parts of Asia, the coral snake's relatives, including the cobras and other elapine snakes, occur in every continent except Europe. (Courtesy Smithsonian Scientific Series.)





1. Coral snake (*Micrurus fulvius*), also called harlequin or bead snake. Color: wide rings of crimson and black, the latter narrowly bordered with yellow (see plate 1). Length: 3 feet. Range: North Carolina to Florida; the Gulf States and Mississippi Valley States north to Ohio and Indiana. Poisonous. (Courtesy Philadelphia Zoological Society.)

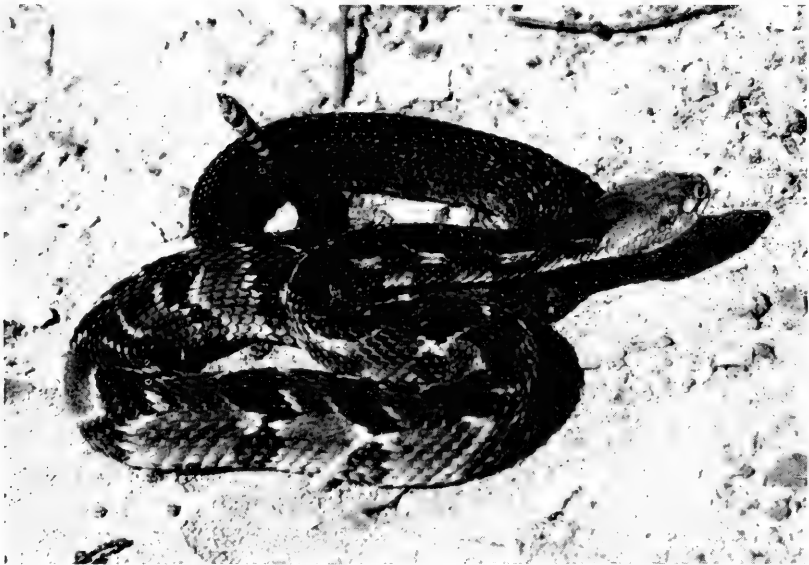

2. Timber rattlesnake (*Crotalus horridus*), also called black or banded rattler. Color: yellow or tan with wavy cross bands of dark brown or black, sometimes almost entirely black. Length: 5½ feet. Range: Maine to Georgia, west through Louisiana to Texas; the Mississippi Valley States into Wisconsin. Extremely poisonous; aggressive if disturbed. (Courtesy Philadelphia Zoological Society.)



1. Carolina pigmy rattler (*Sistrurus miliarius*), also called ground rattler. Color: grayish with a series of darker rounded blotches and a reddish band along the back. Length: 2 feet. Range: North Carolina to Georgia and Alabama. Poisonous. (Courtesy Dr. W. Gardner Lynn.)



2. Copperhead (*Agkistrodon mokisson*), also called rattlesnake pilot, chunk-head, and highland moresin. Color: pale brown, pinkish or light reddish brown, with a series of chestnut-brown hour-glass-shaped markings (see pl. 1). Length: 4 feet. Range: Massachusetts to Georgia and the Carolinas, exclusive of peninsular Florida. Not aggressive unless disturbed. Poisonous. (Courtesy Philadelphia Zoological Society.)

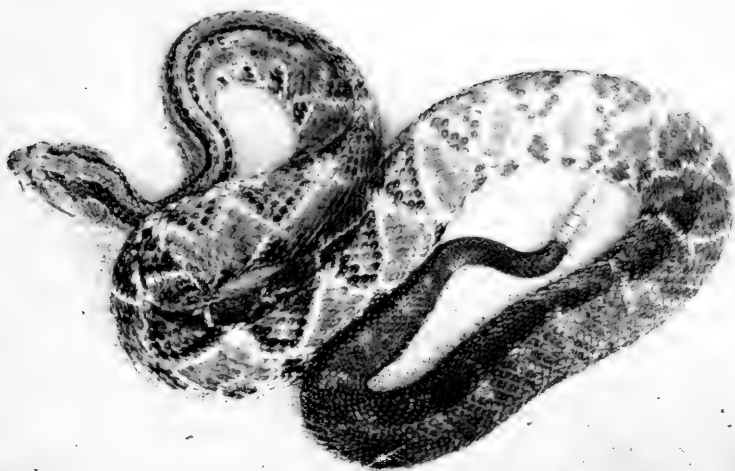

1. Tropical rattlesnake (*Crotalus durissus terrificus*), also called cascabel. Color: yellowish gray with large dark brown "diamonds" on the body, and a pair of dark longitudinal stripes on the neck. Length: 6 to 7 feet. Range: drier parts of the Guianas, Venezuela and Colombia to northern Argentina, Paraguay, and southern Brazil. Most poisonous of all the rattlers; very aggressive. (Courtesy Bulletin of the Antivenin Institute.)

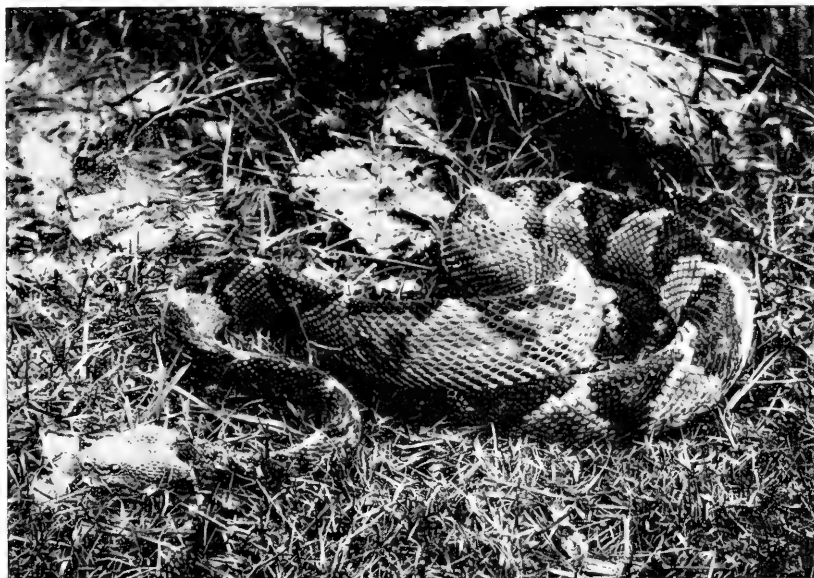

2. Bushmaster (*Lachesis mutus*), also called la cascabela muda in Central America, sirocucu in Brazil, and mapepire zananna in Trinidad. Color: pale brown, often pinkish, with a series of large brown blotches wider on the back and abruptly narrower on the sides. Length: over 11 feet. Range: southern Central America through tropical South America, including Trinidad. Exceedingly poisonous; aggressive. (Courtesy New York Zoological Society.)



1. Fer-de-lance (*Bothrops atrox*), also called barba amarilla, jararaca, terciopelo, or tomigoff. Color: gray to olive, brown or reddish, with dark, light-edged cross bands or triangles, the apex of these extending to the center of the back. Length: 8 feet. Range: southern Mexico to central Brazil, also Trinidad and Tobago; Martinique and St. Lucia in the West Indies. Exceedingly poisonous. (Courtesy New York Zoological Society.)

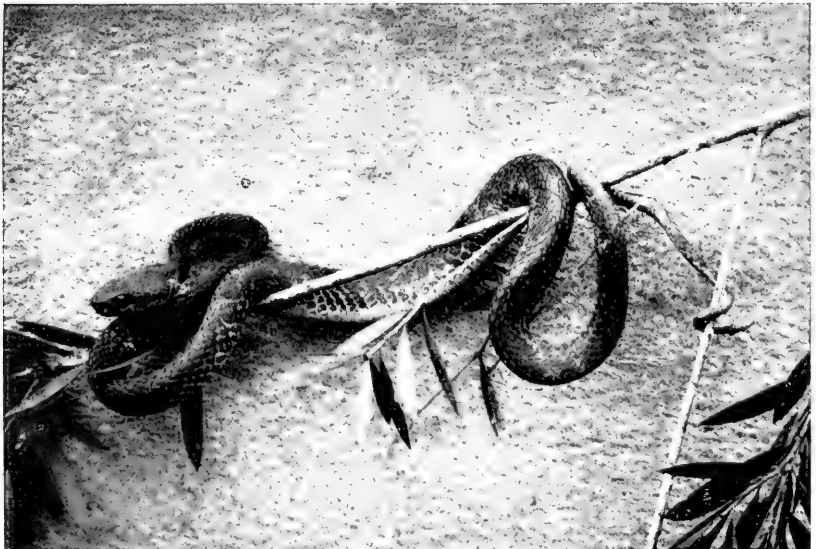

2. March's palm viper (*Bothrops nigroiridis marchi*). Color: uniformly brilliant green above, merging into yellowish green on the sides. Length: not quite 2 feet. Range: Honduras. Dangerously poisonous. (Courtesy Nature Magazine.)





1. Hog-nosed viper (*Bothrops nasuta*), also called nose-horned viper. Color: brown with alternating small black spots along the back separated by a pale line. Length: 2 feet. Range: eastern Central America to Colombia and Ecuador. Poisonous. (Courtesy Nature Magazine.)

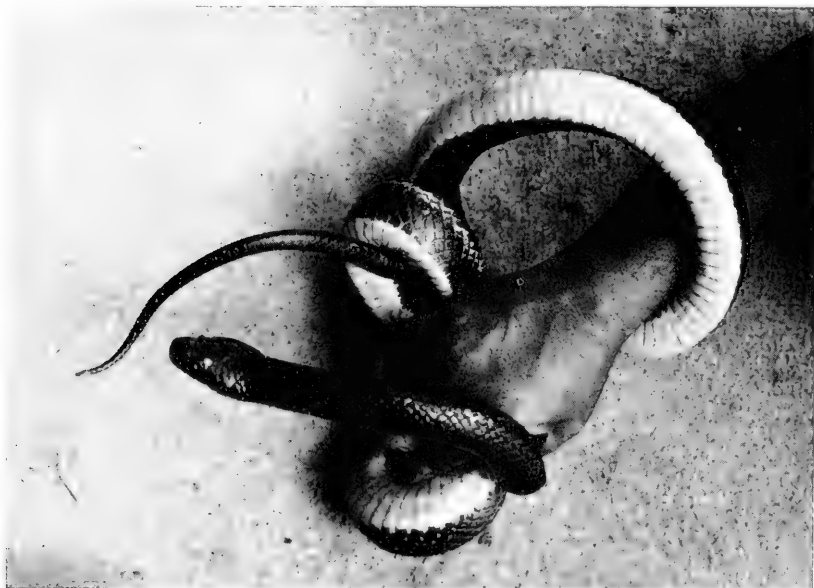

2. Mussurana (*Clelia clelia*), a beneficial snake because of its habit of eating other snakes, especially the fer-de-lance. Color: blue black above, white below (Central American specimens). Length: 8 feet. Range: Guatemala through Brazil. Back-fanged, but the bite not fatal to man. (Courtesy Nature Magazine.)

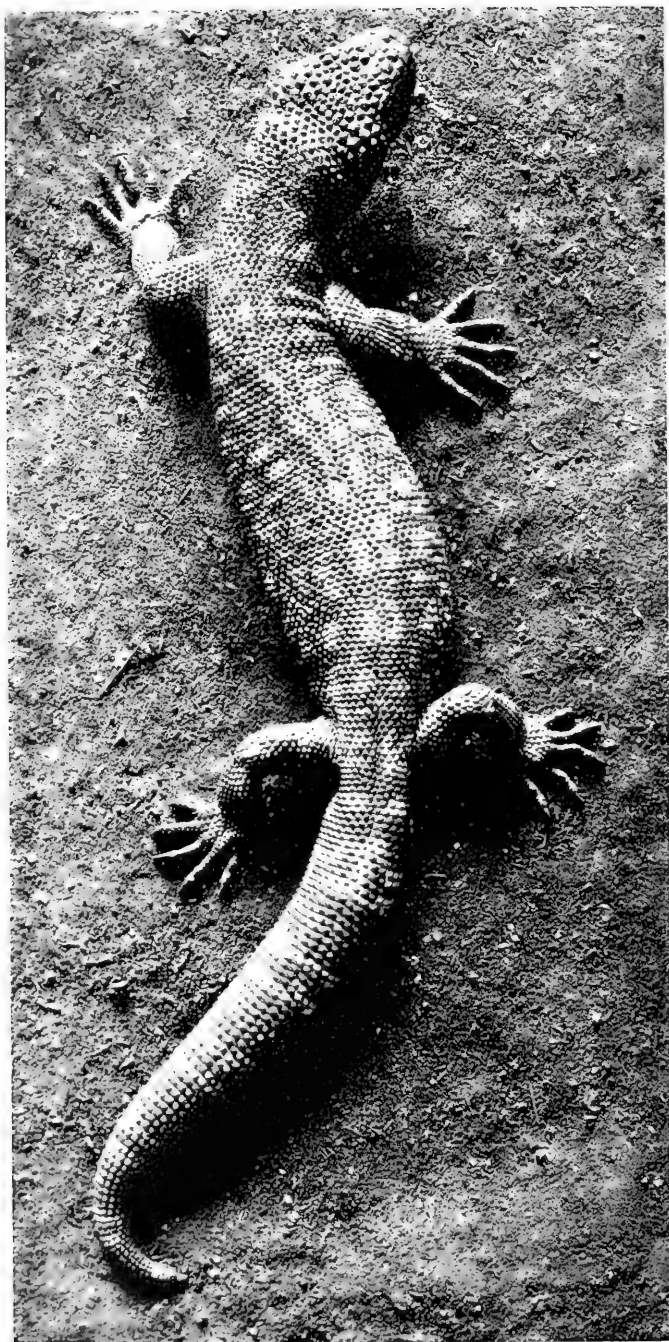

Mexican beaded lizard (*Heloderma horridum*). Color: yellow with dull brown or black irregular markings. Length: 2½ feet. Range: Central Mexico to northern Central America. Not aggressive unless disturbed.

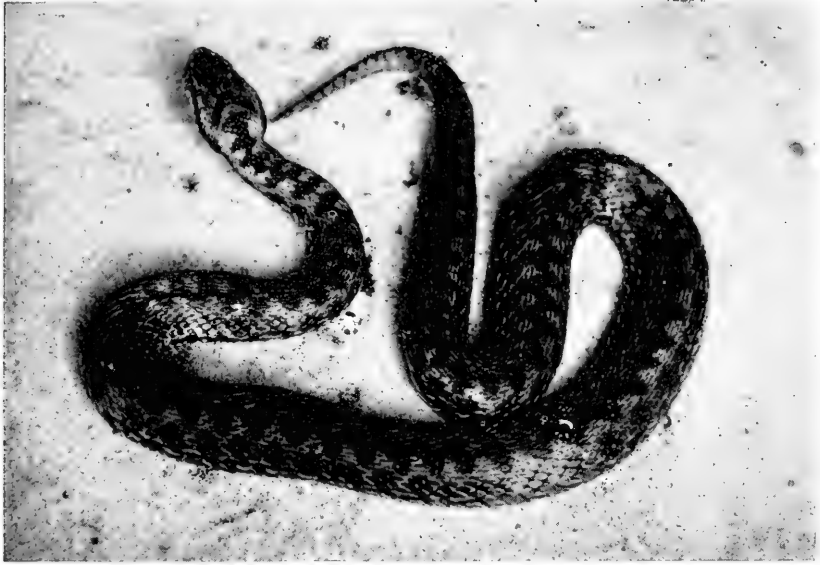

1. Common viper (*Vipera berus*), also called adder or kreuzotter (in Germany). Color: gray, olive, brown, or reddish, uniform or with small dark lateral spots; a dark zigzag pattern along the back. Length: over 2 feet. Range: Great Britain; northern Europe, and Asia to the Amur River and Sakhalin Island; southward in Europe to the Pyrenees, the Apennines, and the Balkans. Dangerously poisonous, savage, and quick. (Courtesy New York Zoological Society.)



2. Orsini's viper (*Vipera ursinii*), also called marasso alpino in Italy. Color: yellowish or pale brown with a series of dark brown spots which may run together in a wavy or zigzag band; sides dark gray or brown. Length: 2 feet. Range: southern France, northern Italy, Hungary, and parts of Jugoslavia. Slightly poisonous; not aggressive. (Courtesy Bulletin of the Antivenim Institute.)



1. Daboia (*Vipera russellii*), also called Russell's viper or tie-polonga. Color: pale brown, with 3 rows of large black rings bordered with white or yellow, having red or brown centers. Length: 5 feet. Range: India, Ceylon, China, the Malay Peninsula, and some of the East Indian islands. Extremely poisonous; not aggressive unless disturbed. (Courtesy New York Zoological Society.)



2. Indian cobra (*Naja naja*), also called spectacled or Asiatic cobra. Color: yellowish to dark brown, with a black and white, usually spectacle-shaped mark on the hood when spread. Length: 6 feet. Range: eastern shores of Caspian Sea through Asia into China and Formosa, the Malay Archipelago, and the Philippines. Exceedingly poisonous; aggressive when disturbed. (Courtesy New York Zoological Society.)



1. King cobra (*Naja hannah*), also called hamadryad. Color: olive or yellowish brown, often with black cross bands. Length: over 18 feet. Range: eastern India, China, the Malay Archipelago, and the Philippines. Extremely dangerous; very aggressive. (Courtesy New York Zoological Society.)



2. Banded krait (*Bungarus fasciatus*), also called ular welang in Malay. Color: yellow above, with broad black rings. Length: nearly 5 feet. Range: southern India and China, the Malay Peninsula, Sumatra, and Borneo. Extremely poisonous; not aggressive unless disturbed. (Courtesy New York Zoological Society.)



1. Night adder (*Causus rhombeatus*), also called Cape viper. Color: gray, with a chain of dark, light-edged spots along the back. Length: 3 feet. Range: the greater part of South Africa to the Nile. Extremely poisonous; aggressive when disturbed. (Courtesy New York Zoological Society.)



2. Puff adder (*Bitis aridans*). Color: a series of black chevrons separated by yellow crescents down the back. Length: 5 feet. Range: southern Morocco and the southern Sahara to the Cape of Good Hope, also Arabia. Extremely poisonous; hisses loudly when disturbed. (Courtesy New York Zoological Society.)

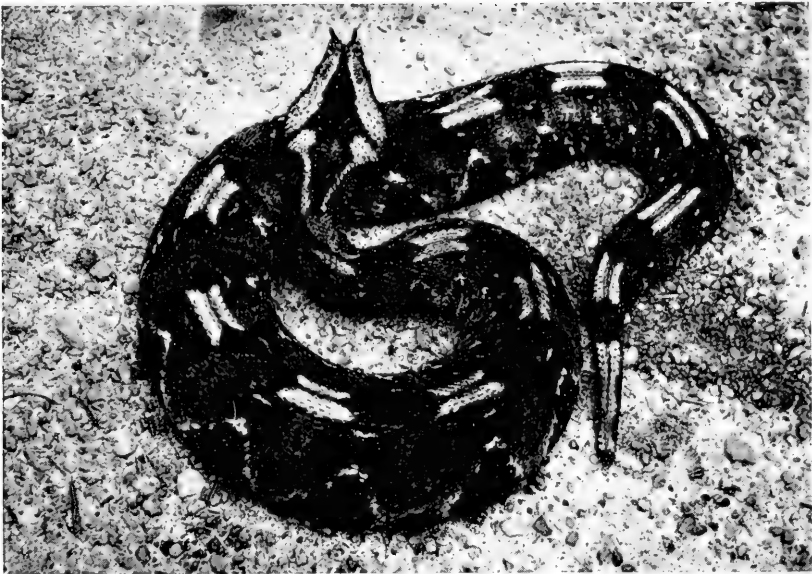

1. Rhinoceros viper (*Bitis nasicornis*), also called river jack. Color: a row of large blue oblong marks down the back, with a yellow line in the center and black borders; a series of dark crimson triangles bordered with blue on the sides; top of head blue with a black arrow-shaped mark pointing forward. Length: 4 feet. Range: tropical West Africa. Extremely poisonous, but not aggressive. (Courtesy New York Zoological Society.)



2. Gaboon viper (*Bitis gabonica*). Color: a series of oblong buff marks enclosed in brown ovals along the back, with a chain of purplish marks outside of these; sides with triangular purplish blotches; eyes silvery. Length: nearly 6 feet. Range: forests of West Africa, also Uganda, Tanganyika, Northern Rhodesia, Angola, and the island of Zanzibar. Extremely poisonous. (Courtesy New York Zoological Society.)

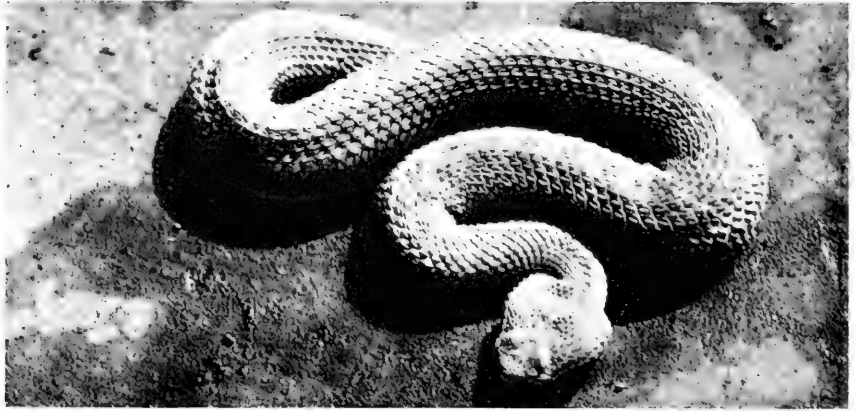

1. Common sand viper (*Aspis viper*). Color: pale yellowish or pinkish with faint darker blotches. Length: 2 feet. Range: northern Africa from Algeria to Egypt. Poisonous. (Courtesy New York Zoological Society.)



2. Ringhals (*Hemochates hu machatus*), also called keel-sealed spitting cobra. Color: brown or dull black above, sometimes with cross bars of brown; underside blackish, except for a pale band or two on the neck. Length: about 4 feet. Range: Cape of Good Hope and Namaqualand. Dangerously poisonous not only from the bite, but from its habit of spraying poison in the eyes of its victim, and very aggressive. (Courtesy New York Zoological Society.)



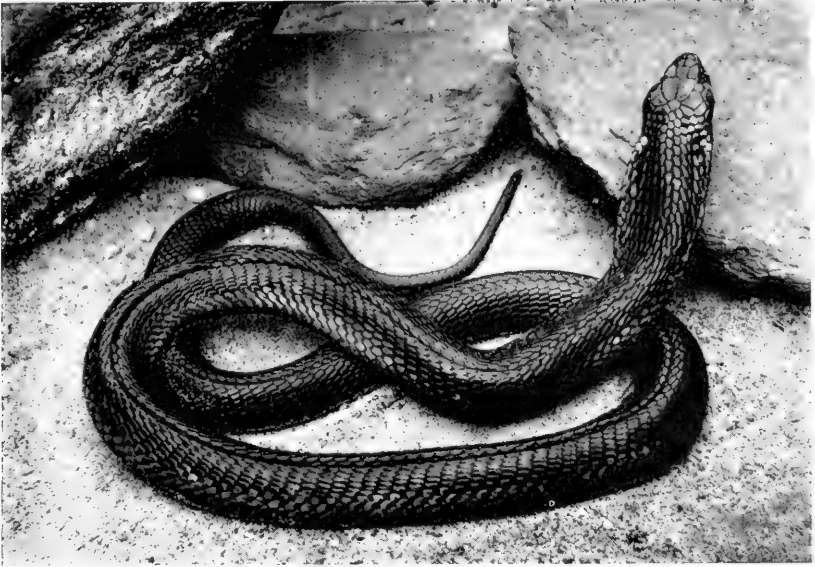

1. Egyptian cobra (*Naja haje*), also called asp. Color: brown, sometimes with faint darker markings. Length: 6 feet. Range: northern and eastern Africa from Morocco to Natal. Extremely poisonous; irritable and aggressive. (Courtesy New York Zoological Society.)



2. Water cobra (*Boulengerina stormsi*). Color: light brown with a series of black, light-centered bands or spots on the body. Length: 8 feet. Range: lakes and rivers in Cameroon, the French and Belgian Congos, and Lake Tanganyika. Degree of toxicity unknown; aquatic; not aggressive out of water. (Courtesy New York Zoological Society.)

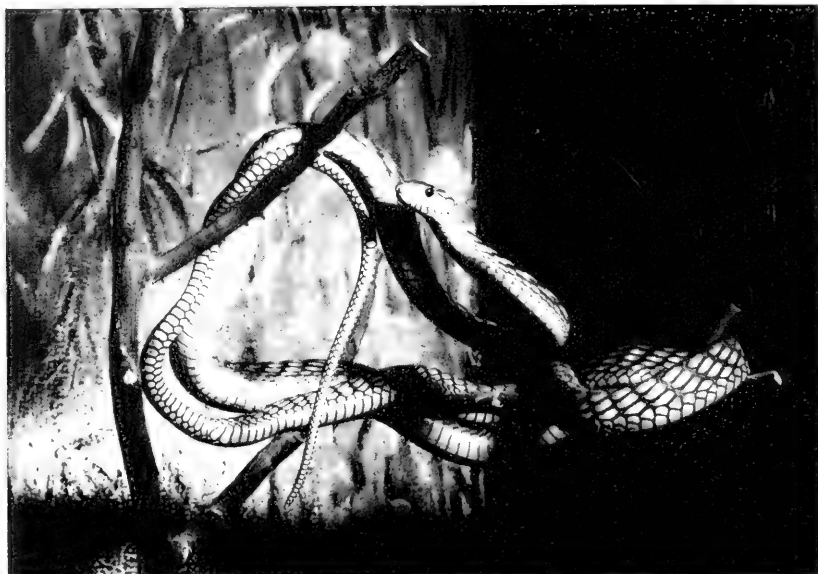

1. Green mamba (*Dendraspis viridis*). Color: green or dark olive, uniform or each scale brown at the end; lips yellowish, outlined with black. Length: 7½ feet. Range: West Africa from the Senegal to the Niger. Poisonous. (Courtesy New York Zoological Society.)



2. Australian black snake (*Pseudochis porphyriaeus*). Color: above blue black; beneath scarlet, the scales often edged with black. Length: 6 to 7 feet. Range: Australia, except the northern part. Poisonous. (Courtesy Bulletin of the Antivenin Institute.)

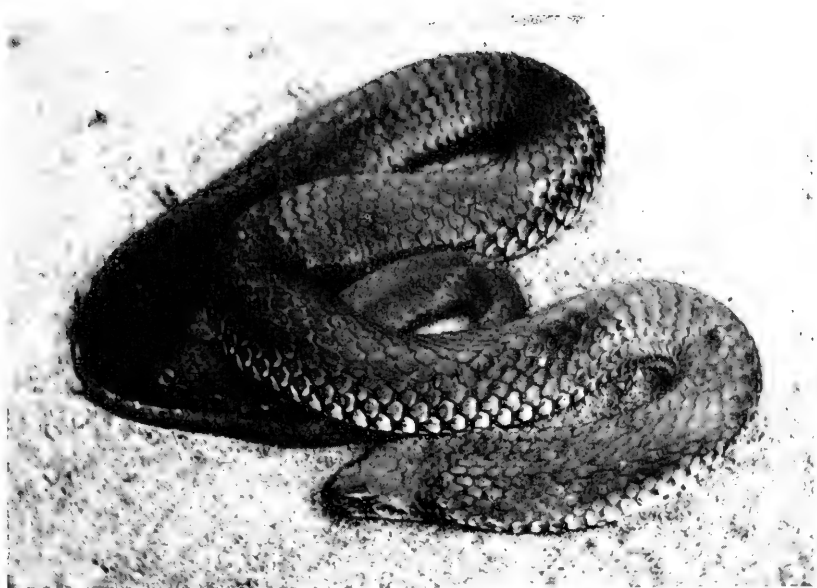

1. Australian copperhead (*Denisonia superba*). Color: brown to black above, the head usually coppery. Length: 6 feet. Range: southeastern Australia and Tasmania. Dangerously poisonous; not aggressive. (Courtesy Bulletin of the Antivenin Institute.)



2. Brown snake (*Demansia textilis*). Color: light brown or gray above, white below; young specimens ringed with black. Length: 5 feet. Range: widely distributed throughout Australia. Extremely poisonous; not aggressive. (Courtesy Bulletin of the Antivenin Institute.)



1. Tiger snake (*Notechis scutatus*). Color: green, gray, orange or brown, with dark bands. Length: over 5 feet. Range: southern half of Australia. Extremely poisonous; very aggressive. (Courtesy Bulletin of the Antivenin Institute.)

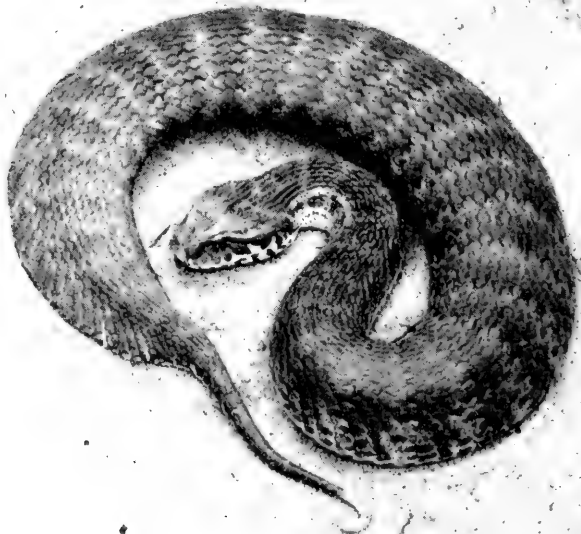

2. Death adder (*Acanthophis antarcticus*). Color: brownish or gray, with dark bands which are most apparent in the young. Length: 3 feet. Range: dry parts of Australia, except Victoria. Extremely poisonous. (Courtesy Bulletin of the Antivenin Institute.)



1. American crocodile (*Crocodylus acutus*). Color: adults olive to dull gray; young, greenish with black markings. Length: over 14 feet. Range: southeastern Florida and Florida Keys; the Greater Antilles except Puerto Rico; both coasts of Central America from Mexico to Ecuador and Colombia. Usually not aggressive but dangerous because of powerful tail and jaws. (Courtesy National Zoological Park.)

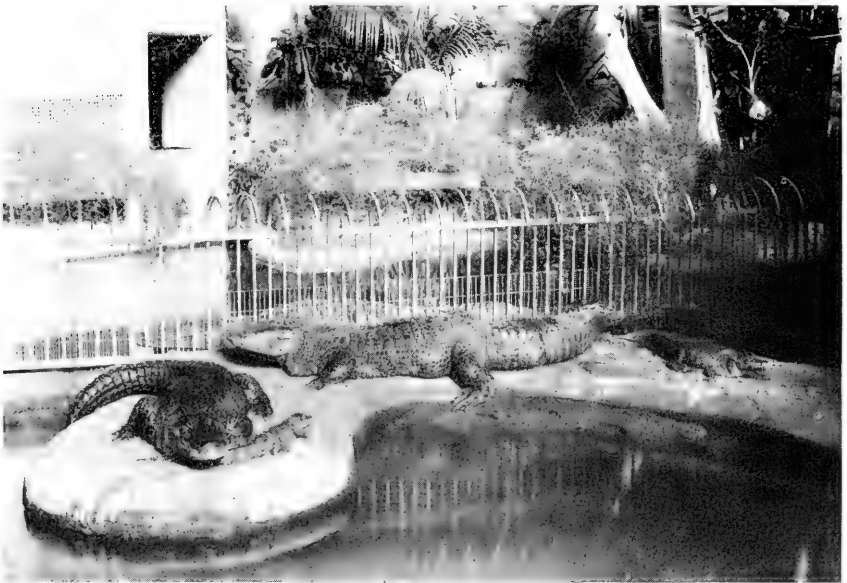

2. American alligator (*Alligator mississippiensis*). Color: Adults uniformly black or dull gray; young, black or dark brown with bright yellow cross bands. Length: about 12 feet. Range: from the Carolinas to Florida, west through the Gulf States to the Rio Grande in Texas. Usually timid, but able to defend itself by lashing its tail and biting savagely. (Courtesy National Zoological Park.)

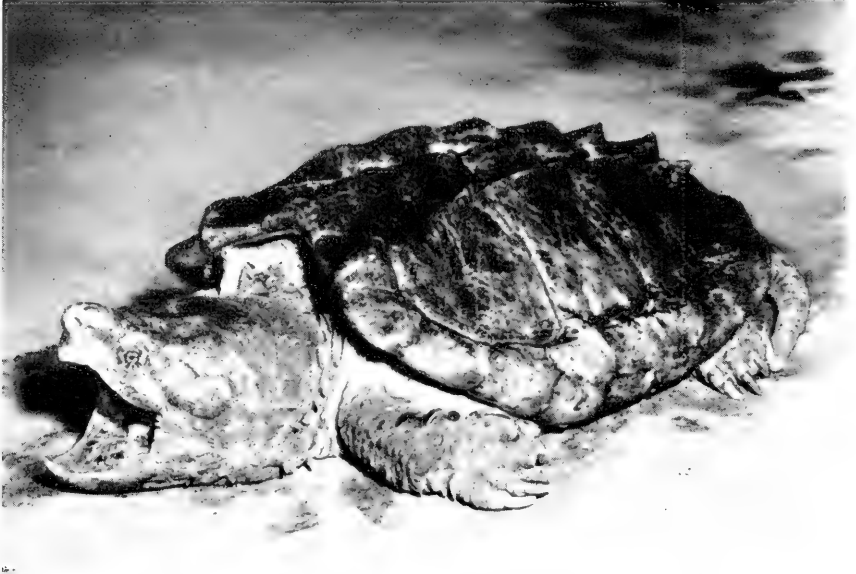

1. Alligator-snapper (*Macrochelys temminckii*). Color: light brown or yellowish. Shell length: about 28 inches. Range: from Texas to southern Georgia and northwestern Florida, as far south as the Suwanee River drainage system, north in the Mississippi basin to central Illinois. Shy and retiring in the wild state, but able to bite viciously when disturbed. (Courtesy Philadelphia Zoological Society.)

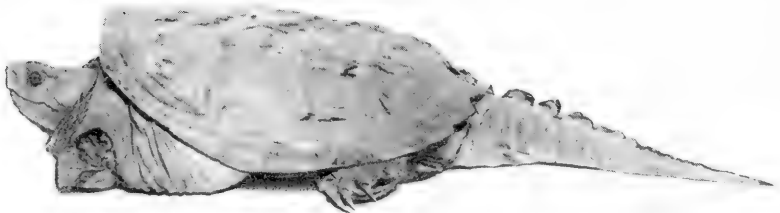

2. Common snapping turtle (*Chelydra serpentina serpentina*). Color: upper shell dull olive or dark brown; lower shell yellowish; head and limbs very dark above, light beneath. Shell length: about 14 inches. Range: eastern North America from southern Canada to the Gulf of Mexico, except peninsular Florida, where it is replaced by a related subspecies. Able to inflict a severe bite with its sharp-edged jaws. (Courtesy A. I. Ortenburger.)

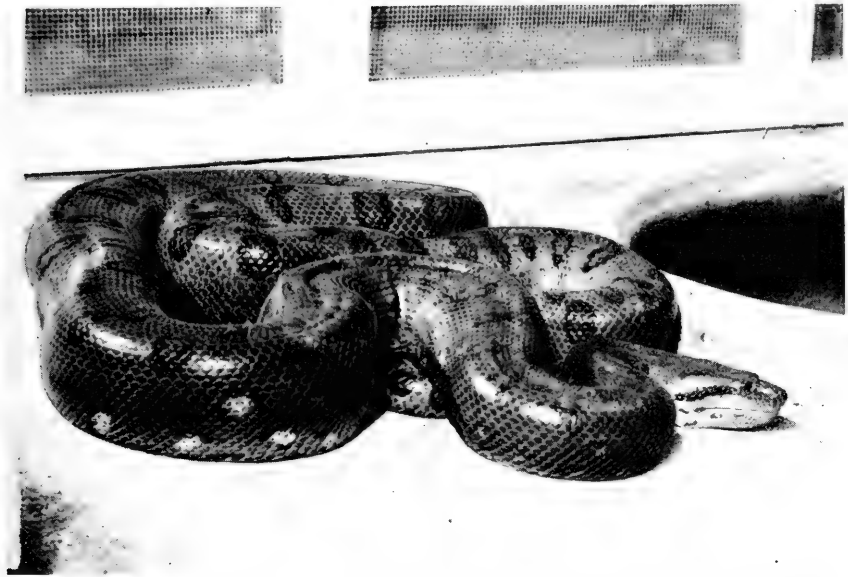

1. Anaconda (*Eunectes* sp.). Color: olive with two rows of large black spots on back, and smaller ones, often with yellowish or orange centers, toward the belly; orange dark-bordered streak on side of head. Length: possibly over 30 feet. Range: Guianas, Brazil, and Peru. Constricts and crushes its victim; jaws with long, backward-slanting teeth to hold prey. (Courtesy Philadelphia Zoological Society.)



2. Boa (*Constrictor constrictor* subsp.). Color: pale tan or yellow to reddish brown, with dark brown saddles often enclosing lighter markings; scales highly iridescent. Length: about 13 feet. Range: Mexico to the Argentine (in several varieties). Constricting and biting. (Courtesy Philadelphia Zoological Society.)



1. Galápagos land iguana (*Coulrophus* sp.). Color: head and neck dull orange to yellow; body, tail, and limbs dark brown. Length: about 4 feet. Range: the Galápagos Islands. While these and other large iguanas of other genera are not at all aggressive, they can bite and scratch with great vigor when captured. (Courtesy National Zoological Park.)



2. Komodo dragon lizard (*Varanus komodoensis*). Color: dull brown or black; tongue yellow. Length: about 10 feet. Range: restricted to four small islands (Komodo, Flores, Rindja, and Padar) lying east of Java and south of Celebes. Wary toward man, but very strong and a vicious fighter with teeth, claws, and lashing tail. (Courtesy Philadelphia Zoological Society.)





1. Salt-water crocodile (*Crocodylus porosus*). Color: dark olive brown to black. Length: up to 33 feet. Range: India, Ceylon, southern China, the Malay Archipelago, the Solomon and Fiji Islands, and northern Australia. Extremely vicious and aggressive, being accountable for many deaths each year in the Malay region and India. (Courtesy New York Zoological Society.)



2. Indian python (*Python molurus*). Two color phases: dark olivaceous with almost black markings, and bright tan with olive-brown blotches, with usually a pinkish band on each side of head. Length: up to 25 feet. Range: India, the Malay Peninsula, Ceylon, and Java. Sluggish and "gentle," but because of its great size able to constrict, crush, and bite. (Courtesy National Zoological Park.)

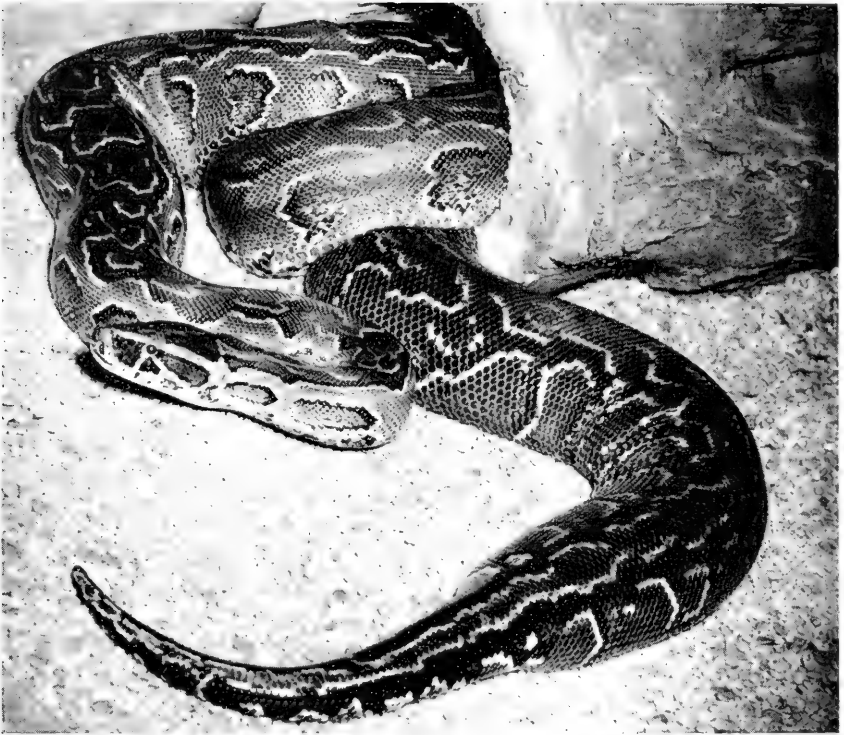

1. Rock python (*Python sebae*). Color: pale brown above, with dark brown sinuous cross bars; sides with large and small dark spots. Length: 25 to 30 feet. Range: Central and South Africa. Able to crush and constrict because of its great strength, as well as to bite savagely if disturbed. (Courtesy Philadelphia Zoological Society.)



2. Gould's monitor (*Varanus gouldii*). Color: blackish with yellow dots in rosettes on the back. Length: about 5 feet. Range: Australia and New Guinea. Like others of this genus, it fights with teeth and claws and thrashing tail when threatened. (Courtesy National Zoological Park.)

# THE PLANTS OF CHINA AND THEIR USEFULNESS TO MAN

---

By **EGBERT H. WALKER**

*Assistant Curator, Division of Plants, U. S. National Museum*

---

[With 12 plates]

Foreigners traveling in China are struck by the contrast between the barren, treeless mountains and hills, with here and there small patches of dense forest hiding the picturesque temples, and the intensively cultivated fertile valleys or strikingly terraced hillsides. Scholars delving into the history of the people or the causes for the locations of the present centers of population find that the plants and their distribution, past and present, lie at the base of many problems. Foreign residents meet curiosity-arousing plants on their rambles or strange plant foods on their tables. The great majority of the Chinese people are farmers, a much larger proportion than in America. Likewise most merchants are constantly dealing with plants or plant products in their business transactions. These and many other considerations stress the importance to China of her plants and vegetation.

The flora of China is the richest of any temperate region in the world and is one of the most, if not the most, important and useful to man. Although it has long been explored and studied, no one has yet prepared a manual of the flora of this vast area or of any major part of it comparable to our well-known Gray's Manual of Botany or Britton and Brown's Illustrated Flora of the Northern States and Canada.

## HISTORY AND PRESENT STATUS OF BOTANY IN CHINA

How we have come to know about this plant wealth is important in understanding what we know about it and where to find the recorded knowledge. Recently a student came to the Smithsonian Institution to find a detailed map showing the distribution of the vegetation in China and its character in every locality. Had he understood the stage of development of our knowledge of the botany of China, he would have known that no such map existed and that the

materials from which one could be prepared are widely scattered, very incomplete, greatly generalized, and often very unreliable. It is therefore of advantage to trace the history of the botany of China before viewing the vegetation as a whole and examining some of its principal component parts; that is, the individual species, of which there are over 15,000 now known, with hundreds of new species being described every year.

This history has three branches: the first, the accumulation of knowledge now represented in the rich Chinese literature prepared before the advent of modern science; the second, the development of scientific knowledge by westerners; and the third, as yet only a vigorous shoot scarcely 25 years old, the development of Chinese scientific botanists and institutions.

#### PRESCIENTIFIC STUDY BY CHINESE

Chinese nonscientific knowledge can be traced back to the mythological emperor and scholar, Shen Nung, who is supposed to have lived some 2,000 years B. C. In the third century B. C. a dictionary of terms, including botanical names, which were used in the ancient Chinese classics, was compiled by Chou Kung under the title "Ehr yah." In 1590 appeared the most important of all Chinese botanical works, the herbal called "Pên ts'ao kang mu," by Li Shih-chen, a record of all knowledge of Chinese medicinal plants. Since that time many editions of this famous work have been prepared, as well as other herbals. Most of the data recorded in these numerous Chinese works are agricultural, medicinal, or economic. Valuable information on plants is inscribed in the huge Chinese encyclopedias, which are often so large as to dwarf our familiar reference works of this type. More information is buried in the numerous provincial and regional gazeteers. A few western scholars of the Chinese language, or Sinologues, have delved into these storehouses of literature and have made translations of scattered portions, but the bulk of this material is still hidden from modern scientists in the intricacies of the Chinese language. It is of relatively little value to us from the purely scientific point of view but is of use in the field of economic botany.

#### STUDY BY WESTERNERS

The growth of our western scientific knowledge of the plants of China shows a steadily increasing seriousness in its scientific objectives, progressive changes in the nationality and qualifications of its workers, expansion of the areas where they worked, and changes in the location of the centers in which they labored. The earliest westerners who came to China were much interested in the strange new fruits

and economic plants which were used by the Chinese people and which happened to come to their attention. Later westerners made more serious search for plants grown in Chinese gardens and shipped cuttings and seeds home so that their own gardens and greenhouses might be enriched. Later still definite exploration for useful plants was undertaken, from which developed scientific botanical exploration and the collecting of herbarium specimens of all species. The first westerners who concerned themselves with the plants of China were traders whose primary interest was business. These were followed by specially employed plant explorers, the earliest of whom were not highly trained as botanists. Later came better-qualified men to gather and interpret the wealth of botanical material so much desired by horticulturists, agriculturists, and scientists in the west. It is specially significant that almost all the European countries and the United States were interested in exploring for China's botanical treasures, for the open-door policy in China prevented any one nation from excluding the others. In the beginning, of course, all material collected was sent back home, so that today the important scientific collections are scattered throughout Europe and the United States. Later, when stable centers were established in or near China, botanical work was carried on from places nearer the collecting grounds, and at least part of the material was retained in the country. Soon after Hong Kong was ceded to Great Britain in 1841, the Hong Kong Botanical Garden and herbarium were established, and similar institutions in various places were started as opportunities opened up. In the earlier part of the present century western missionary schools, colleges, and universities were founded and, together with various native Chinese schools and institutions, undertook botanical work. Until recently most of the basic or purely technical study has been done in Europe or America, largely because the institutions in China lacked the basic scientific collections so essential to such studies, but now much is being done by Chinese in China.

This story of Chinese botany is closely bound up with the progressive opening up of China to western penetration. At first only the prized plants of Chinese gardens in the few coastal cities open to foreign trade were known. Later the foreigners were permitted under special restrictions to explore the nearby hills. Still later, when the great diplomatic missions were allowed to travel overland between Peiping and the southern ports, glimpses were obtained of the botanical wealth of the interior. Following the opium wars, 1840 to 1861, permission was wrested from the reluctant Chinese rulers to penetrate farther inland and to establish consulates, customs stations, mission compounds, and other centers from which botanical work could be conducted. Eventually botanical explorers began to enter the back

door of China from Burma and to scour the far distant borderland and even the still largely forbidden land of Tibet. Now the eastern part of China is closed to all outsiders except the Japanese, and the westerners can enter only by the back door.

Of course the first westerner to observe the plants of China was the Italian merchant Marco Polo. His written accounts of what he saw contain many references to the plants and vegetation and are of some use in reconstructing a picture of the vegetation in the thirteenth century, so different in many places from that found today. But to scientific knowledge Marco Polo made almost no contribution.

From the rediscovery of China by the Portuguese in 1516 to the exclusion of the western botanists from eastern China after "Pearl Harbor," there has been a steady accumulation of knowledge of Chinese botany by the west. Following on the heels of the Portuguese traders came Jesuit missionaries, who, unlike the merchants, penetrated far into the interior. In 1601 the Dutch arrived but their predecessors, the Portuguese, were too well established to permit these newcomers to do much in China, so the Dutch concentrated their efforts on Japan and were more important in the botanical history of that country. They introduced tea into Europe soon after their first arrival. The English came in 1637 and the French at a somewhat later date. When the Swedish botanist Linnaeus wrote his epoch-making *Species Plantarum*, published in 1753, he had access to a surprising number of Chinese plants brought by the Swedish sea captains or sent by various traders established in the few coastal ports then available, especially by the enterprising chaplain Peter Osbeck at Canton. As these treasures from the east and other parts of the world reached Europe, gardens were established for their cultivation and herbaria were built for their preservation. Scientific societies were formed to promote world exploration and to study the accumulated specimens. Thus grew the famous Chelsea Physic Garden in London and the Royal Gardens, the latter now the world-famous Royal Botanic Gardens at Kew, almost universally known simply as Kew. Likewise there were established the Jardin des Plantes in Paris, and botanical gardens in Leiden, Geneva, Vienna, St. Petersburg, and elsewhere. After 1800 there was developed the Royal Botanic Garden in Calcutta with its eminent botanists, especially Wallich and Roxburgh. The Royal Horticultural Society, the Linnaean Society of London, and other scientific organizations were founded, and botany thrived throughout Europe. Governments became interested in the subject, and botanists accompanied many of the world exploring expeditions that were so popular during the eighteenth century and the first half of the nineteenth. All these foreigners except the Russians began their activities in China at coastal cities. The Russians, however, pushed overland and

entered China from the north as part of their exploration of Siberia and adjacent lands, and today the basic botanical collections from northern and northwestern China are to be found in Leningrad.

The first real American botanical interest in China came with the famous Perry expedition, which forced Japan to open her doors to foreign trade in 1854. Charles Wright, the botanist of the expedition, collected in China only about Hong Kong and Canton. His collections were studied by our own famous Asa Gray, working closely with European botanists. Sets of duplicates were sent to London, St. Petersburg, and probably Paris or Berlin. The famous Russian botanist, C. J. Maximowicz, founded several new species on Wright's collections.

Numerous famous botanists were associated with various aspects of this increasing interest in botanical exploration. Robert Fortune explored the coastal regions of eastern China from 1843 to 1861, largely for the Royal Horticultural Society of London, and practically exhausted the possibilities of Chinese gardens as sources of material for cultivation in Europe. He wrote several very readable books on his explorations, and from Chekiang and Fukien he obtained tea plants from which were developed the now extensive and important tea plantations in northern India. He was unable, however, because of restrictions on travel, to penetrate very far into the back country.

The most learned botanical scholar in China in the nineteenth century was probably H. F. Hance, a consular officer established in Hong Kong and Whampoa below Canton. He accumulated there a fine herbarium, wrote scholarly botanical papers, and corresponded extensively with other botanists and collectors in the east. His herbarium eventually reached the British Museum. Charles Ford and various others were in charge of the Hong Kong Botanical Garden and enriched these collections by exploring southern and southeastern China. Augustine Henry was a medical officer and assistant in the Chinese Maritime Customs, who was stationed at various times in Formosa and Hainan, and at Ichang in Hupeh, and Mengtze and Szemao in Yunnan. He was much interested in studying the economic botany of the country and collected, with the aid of Chinese assistants, thousands of herbarium specimens, which were sent to Kew, whence duplicates were distributed to various herbaria throughout the world. They are now considered among the best and most important of all botanical collections from China. Besides collecting herbarium material, Henry observed the uses made of these plants and wrote an important account of the economic plants of the country.

Among prosperous businessmen in Shanghai around 1870 was an energetic American, F. B. Forbes, who delighted in collecting plants on his week-end houseboat trips in the vicinity. Having need for a

list of the known plants of China, he persuaded the famous British botanist, W. B. Hemsley, who named his collections, to prepare a list of all the known plants of China. This project developed into the only comprehensive enumeration of all the plants of China ever written, namely, *An Enumeration of All the Plants Known from China Proper, Formosa, Hainan, Corea, the Luchu Archipelago and the Island of Hongkong*, published between 1886 and 1905. Forbes' name appears as first author, but, although he made some contributions, the work is largely the result of Hemsley's effort. It was never intended to be a manual for ready identification of the plants mentioned and is now greatly out of date. It is important, however, as it brings together the scattered material published up to that time.

In 1899 the search in China for ornamental and other useful plants was renewed with great vigor. In that year E. H. Wilson, trained as a gardener at Kew, was sent to China by the famous horticultural concern, Veitch & Sons, of England, with the encouragement of C. S. Sargent, founder of the Arnold Arboretum of Harvard University. Wilson subsequently made several trips for this American scientific institution, the first in this country to interest itself seriously in the Asiatic treasures. Following Wilson there came three Britishers: George Forrest, who died in Yunnan; Reginald Farrer, famous for his additions to English garden plants; and Francis Kingdon Ward, who is still exploring in Asia. Austria was represented by Camillo Schneider and H. Handel-Mazzetti, the latter marooned in China by the First World War. American workers included Frank N. Meyer, pioneer plant explorer for the United States Department of Agriculture, who was drowned in the Yangtze River (pl. 11, fig. 1); P. H. Dorsett, another Government explorer of North China in the 1920's, now deceased; and J. F. Rock, an enthusiastic collector in western China for our Government and other organizations, recently returned from Yunnan. Most of these men and others were employed primarily to bring back seeds and cuttings of economically useful plants and more or less incidentally to make scientific herbarium collections. However, their dried specimens and technical publications have contributed greatly to the knowledge we have today of the rich flora of China. Because they were especially interested in plants for cultivation in temperate Europe and America, they confined their endeavors largely to the rich hunting grounds of western China, first explored about 1870 by the French missionary-explorer, Armand David. Frank N. Meyer and P. H. Dorsett, however, made especially valuable discoveries of little-known cultivated plants in northern, central, and eastern China. Meyer, furthermore, penetrated into Chinese Turkestan and beyond.



## THE BEGINNINGS OF SCIENTIFIC STUDY BY THE CHINESE

Until about 1918 practically all the scientific botanical work in China was done by foreigners from Europe and America, who took back to their home countries all their valuable collections. But following the Chinese Revolution in 1911, the idea was developed of initiating similar work by Chinese as part of the modernization of China. In 1916 the staff of Canton Christian College, now called Lingnan University, started accumulating a herbarium with the encouragement of W. T. Swingle, of the United States Department of Agriculture, and of E. D. Merrill, then director of the Bureau of Science in Manila, and established a department of botany where students were trained to do research work. F. A. McClure, a member of the staff, a plant explorer of many parts of South China, especially of Hainan, and collaborator with the United States Department of Agriculture, undertook the investigation of the bamboos for the purpose of training Chinese students in scientific research. About the same time Nanking University, another mission school, and National Southeastern University, a government institution, now called National Central University, started herbaria and undertook similar work. Gradually other schools, especially those under the Government, inspired by the examples of the earlier ones and staffed by their graduates or by botanists trained abroad, instituted botanical research. In the beginning various foreign foundations fostered these developments by direct or indirect means, and later, Chinese scientific societies and other organizations aided their growth. Soon the initiative in botanical work was taken by trained Chinese botanists, most of them with degrees from American or European universities. At first these herbaria were dependent on foreign specialists for most of the naming of their collection, because the basic collections needed for comparison were in Europe and America, and library facilities in China were inadequate. But gradually these obstacles have been overcome by obtaining photographs or duplicates of important collections or by making new collections which were carefully compared with the older ones, and by buying books or getting photostats or other reproductions. Now many parts of China have been explored by Chinese botanists and large collections of valuable material have been accumulated. These workers have been able to penetrate areas either not accessible to foreigners or not worth their exploring because of their primary interest in horticulturally useful material from temperate regions.

There has thus been a steadily increasing interest in Chinese botany from the time of the first Portuguese trader to the establishing of modern herbaria and scientific research by Chinese institutions. Much has already been learned, but there still remains extensive work to be done.

## THE PRESENT STATUS OF CHINESE BOTANY

The principal botanical centers in China before the war were Canton, the Nanking-Shanghai area, and Peiping, with some activity in Szechwan. In Canton were Lingnan University and Sunyatsen University. In Nanking were Nanking University and National Central University, the Academia Sinica, and the Botanical Laboratory of the Science Society of China. In Peiping the principal institutions were the Fan Memorial Institute of Biology and the National Academy of Peiping, the former especially interested in southwestern China, the latter centering its activities largely in Mongolia and Sinkiang, or Chinese Turkestan. On Lu Shan near Kiu Kiang, in Kiangsi Province was the Lu Shan Arboretum under the Fan Memorial Institute of Biology. This arboretum is now established in Likiang, Yunnan. Besides these major centers many other colleges, universities, and societies were engaged in botanical work, such as Amoy University, which was especially interested in marine algae, Hong Kong University, National Wuhan University, Kwangsi University, Science Institute of West China, and others.

It is of considerable interest and of no little importance in the light of Chinese-American relations to note that most of this work by Chinese botanists has its roots in American activity in China. Thus their methods and points of view are primarily American rather than European, and a far larger proportion have degrees from American than from European universities. In Japan the reverse is true.

Of the many fine Chinese botanists, one of the most outstanding is Dr. H. H. Hu, head of the Fan Memorial Institute of Biology, a graduate of Harvard University, now president of Chung Cheng University (Chiang Kai-shek University) at Taiho, southwestern Kiangsi Province. Prof. W. Y. Chun, of Sunyatsen University, also a Harvard student, whose present location is unknown, is especially versed in the flora of southeastern China and Hainan, where he has collected extensively. On the fall of Canton to the Japanese forces he established the university's herbarium temporarily in Kowloon in British territory opposite Hong Kong Island and saved most of the collections. The collections he could not remove from Canton are reported to have been taken by the Japanese to Formosa. We have no knowledge of what happened on the fall of Hong Kong. R. C. Ching (pl. 11, fig. 2), head of the Lu Shan Arboretum in Likiang, Yunnan Province, is the foremost authority on ferns, and Dr. Y. L. Keng, of National Central University in Chungking, is a thorough scholar who has specialized on the grasses of China. Prof. W. P. Fang, of National Szechwan University, Omei Hsien in Szechwan Province, is working on the flora of that region and has made extensive collections. Dr. Tseng Cheng-kwei, who is still in America, is a specialist on marine algae,

and Li Liang-ching, last heard from at the Fan Memorial Institute of Biology in Peiping, is an authority on fresh-water algae. Dr. Tai Fang-lan, a student of fungi, was at least formerly with National Tsinghua University, now joined in exile with the National Southwest Union University in Kunming, Yunnan. At this same Union University is C. Y. Chang, a plant morphologist. Many others, equally worthy of mention, are in various places unknown to us because of the wartime disruption of communication. Whereas in former years inquiries about Chinese plants were usually directed to some foreign institution, now they can be directed to Chinese botanists at home.

Even at the present time botanical work is going forward in China. Research and even exploration is being carried out, although on a small scale and under tremendous handicaps, and scientific papers are occasionally printed. Exchange of publications with western nations is impossible, except as many scientific periodicals in America are being microfilmed and sent by mail through cooperation with the Cultural Relations Division of the United States Department of State.

It should not be forgotten, however, that much botanical work on Chinese plants is still being done by westerners in America and Europe. Dr. E. D. Merrill, director of the Arnold Arboretum of Harvard University, is the foremost authority in America, and that institution, along with the Gray Herbarium of Harvard University, has the finest collection of Chinese herbarium specimens in the United States. The United States National Herbarium in Washington has many thousands of specimens in the care of the present writer, who is especially interested in the plants of China. The New York Botanical Garden, the University of California, and the Missouri Botanical Garden also have large Chinese herbaria. In Europe the largest collection is probably at the Royal Botanic Gardens, Kew, but very large and important deposits are at the British Museum in London and the Royal Botanic Garden in Edinburgh. In Berlin there was developed a large and very important herbarium, which is reported to have been almost completely destroyed in March 1943 in a bombing raid. Other important collections are in Paris, Vienna, Stockholm, Copenhagen, and Leningrad.

#### THE LITERATURE ON CHINESE PLANTS

Ever since the time of Marco Polo and the earliest Portuguese explorations, people have been writing about the plants of China. There is now a tremendous literature written in almost every European and Far Eastern language and in the books and periodicals of almost every country. It deals with these plants from almost every point of view, taxonomic, economic, agricultural, geographical, and

others. Because these plants from China have found their way into cultivation in all parts of the world, horticultural and agricultural literature is full of valuable accounts of interest to students of Chinese botany. Much of the literature is highly technical and would be of little interest to the general reader. Very little of a popular nature has been written on the plants as a whole; indeed the subject is so vast and there is so much even yet unknown that it is a difficult task to treat the flora as a whole. Everyone in China who is interested in plants longs for a manual by which he can learn the scientific, Chinese, and sometimes the common English names of the trees, shrubs, and herbs about him, but no one has yet undertaken to write such a comprehensive work. For a few restricted areas there are such books, but they are of little use outside their boundaries. A few years ago Dr. E. D. Merrill and the writer compiled *A Bibliography of Eastern Asiatic Botany*, listing over 21,000 titles of books and papers on the plants of China proper, Manchuria, Mongolia, Tibet, Japan, Formosa, Korea, and eastern Siberia. It is the most extensive regional plant bibliography ever published. By means of its extensive indexes one can find a great mass of information on many subjects. For further details on the principal works on Chinese plants, see pp. 360-361.

#### FLORAL REGIONS OF CHINA

The great number of species of plants in China, numbering over 15,000 seed plants and ferns alone, along with the great diversity in the vegetation, ranging from the steaming Tropics of Hainan Island to the cold, wind-swept Mongolian deserts and from the China Sea to the eternally snow-capped peaks of Tibet, makes the task of gaining a general concept of China's flora a difficult one. The average person in most parts of China sees, besides the well-tended plants in cultivated and usually irrigated fields, a limited amount of wild vegetation. This consists largely of scattered trees among the cultivated fields (pl. 1, fig. 2) or along roadsides and paths or an occasional grove in or near a village (pl. 4, fig. 1). Striking oases of luxuriant vegetation hide the temples and monasteries scattered about the countryside or nestled in mountain valleys. One will notice also that most of these mountains and hills are covered with grass or small shrubs (pl. 1, fig. 1), or bear scattered pine trees of no great size (pl. 2). But if one travels into the interior on the divides between the major rivers and away from tillable lands, he may find genuine forests, even dense primeval jungles.

The most outstanding feature of the Chinese landscape to a newcomer from the west is the barren and treeless appearance of the hillsides throughout most of the country. Reforestation is the most

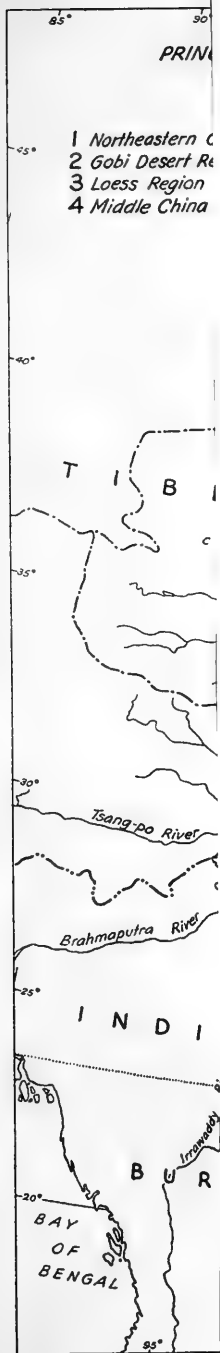



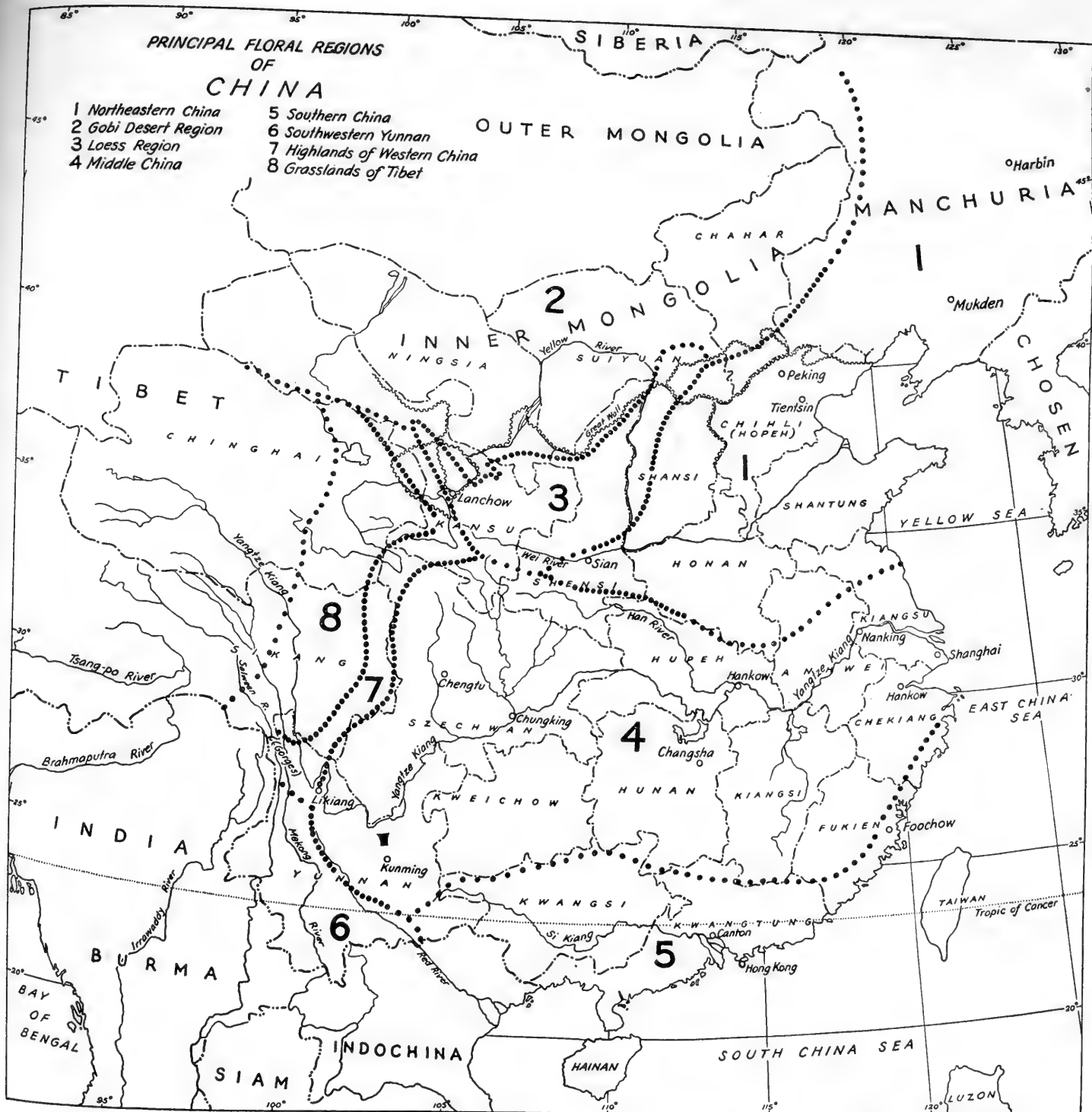

FIGURE 1.—Principal floral regions of China.





urgent economic problem in China next to that of raising enough food for its millions of people.

The vegetation of China varies with respect to the rainfall and humidity, which are in turn governed largely by the direction of the winds, the seasons, and the location and altitude of the mountains, which rise in the west to peaks over 22,000 feet. The distribution of the rainfall throughout the year, the average temperature, the extremes of temperature, the character of the soil, and various other factors also determine the type of vegetation found in any given area. As these factors differ widely throughout the country, so there is great variation in the vegetation.

Geographically China can be divided into at least eight floral regions as follows (see also map, fig. 1, where approximate boundaries are shown) :

1. Northeastern China, including most of Korea and extending from northern Manchuria to the great plains of China, marked off from the lower Yangtze Valley by the extension of the Tsinling Mountains, and reaching westward to the Gobi and Ordos Deserts and the loess regions of Shansi.

2. The Gobi Desert region of Mongolia, especially the southern part, including the Ordos.

3. The loess region covering eastern Kansu, most of Shensi, and part of Shansi.

4. Middle China, comprising the main part of the country from the Tsinling Mountains on the north to the Nan Shan on the South (that broad range which separates the watersheds of the Si Kiang from the Yangtze Kiang) and extending westward across the plateau of Yunnan and the basins and lesser mountains of Szechwan to the foot of the snow-capped peaks in the west.

5. Tropical and subtropical southern China, including most of Kwangsi, all of Kwangtung except the most northern part, coastal Fukien and southern Chekiang, and of course Hong Kong and Hainan.

6. Southwestern Yunnan, which has the same type of luxuriant tropical vegetation as adjacent Burma.

7. The highlands of western China with their deep river gorges and snow-capped peaks and corresponding parts of western Szechwan and Kansu.

8. The grasslands of eastern Tibet, covering parts of Sikang, Tsinghai, and Kansu.

If Tibet as a whole be included in this greater China area, two more floristic regions would be added, namely: (1) the northern plain or Chung Tang along with the Tsaidam, the part with internal drainage; and (2) the outer plateau, the part of Tibet drained by several rivers which flow through great gorges across the Himalayan Range.

These divisions are not clearly marked off from each other, but gradually intergrade. Of course it must not be supposed that the vegetation is uniform within these divisions; it actually varies considerably according to soil, altitude, and climate. Also in general aspect the vegetation in most parts has been enormously changed by man from that which unhindered Nature has developed. In fact, to a very large extent we can only determine what is the normal vegetation by careful study of the few remnants which man has not yet altered.

The plants that compose the vegetation of these regions can be divided according to their geographic affinities. For example, the banyan trees of southern China occur elsewhere only in southern Asia, and the species of pines found in Manchuria occur elsewhere only in Siberia and northeastern Asia. Thus the plants of China can be divided into the following eight groups based on their geographic affinities, with the addition of a ninth group, if the strictly cultivated plants be considered as part of the flora of the country.

1. Palaeartic, consisting of plants which occur in northern Asia, often also in Europe and northern North America.

2. Central Asiatic, occurring in Turkestan and vicinity, usually also in Asia Minor and often even in northern Africa.

3. Himalayan, consisting of plants found in the temperate and alpine parts of this vast range south of Tibet.

4. Indo-Malayan, the plants which are found exclusively or nearly so in Indo-China, the Malay Peninsula, and the East Indies.

5. Insular or Japanese, including plants extending over Hokkaido, Japan proper, the Liu Kiu Islands, and Formosa.

6. North American, consisting of that group of plants found in eastern Asia and eastern North America, which has been of so much interest to plant geographers.

7. Cosmopolitan, those which occur so widely distributed over the world that they cannot be considered as indigenous of any one part.

8. Endemics, or those plants, either species, genera, or even families, which occur nowhere else.

The following discussion is mainly concerned with the floral regions, because considerable knowledge of the distribution of plants is needed in order to understand floral affinities. However, these relationships will be considered in connection with each region.

#### NORTHEASTERN CHINA

This floral region includes Manchuria, most of Korea, the great plain of China in Shantung, Shansi, Chihli or Hopei, and most of Honan, and extends south over northern Anhwei and Kiangsu. It is bounded on the west by the loess deposits of Shansi and Shensi and

the desert and grasslands of Mongolia, including the Ordos Desert in the great bend of the Yellow River. This is a region of rather severe winters and adequate, but not extremely abundant, rainfall. The climate is greatly influenced by the monsoon winds, although less so than in the regions farther south, and is not extremely continental, as is that of Mongolia and of central and northern Asia.

The characteristic plants are broadleaved deciduous Temperate Zone trees and shrubs, the genera of which are mostly familiar to people of eastern North America, such as oak, maple, birch, beech, ash, walnut, elm, willow, etc. There are many conifers, such as larch, spruce, fir, and pine, but they are found in less abundance or on the higher mountains. Bamboos are found in northern Korea. In Manchuria and northeastern Asia occurs that gorgeous phenomenon of autumn leaf coloration, so familiar to us in the northeastern United States and Canada, but occurring nowhere else in the world to such a degree.

Throughout most of this region in China proper the trees now occur singly or in small groves. Originally great forests extended almost unbroken, though changing in constitution, from Manchuria and even farther north, all the way down through eastern China to the tropical jungles. There remain today large forests in northern Korea and in some of the mountainous parts of Manchuria. These forests furnish much valuable timber for use in northern China and even for export to Japan and elsewhere. Until about 30 years ago there were some magnificent forests east, west, and north of Peiping, which were saved by the emperors for hunting preserves; but, with the passing of the last imperial dynasty and the uncontrolled pressure of the population for forest resources, these have rapidly dwindled to almost nothing. In Shansi has occurred the same phenomenon; the once great forests on Wu Tai Shan described in early Chinese literature have steadily dwindled till now there is almost nothing left. The tragic story of this mountain has been ably told by W. C. Lowdermilk and Dean R. Wickes under the title "History of Soil Use in the Wu T'ai Shan Area."<sup>1</sup> This account, prepared in connection with our own Government's soil conservation efforts, was traced largely from the records found in various Chinese works.

In north-central Shensi, north of the loess-filled valley of the Wei Ho and south of the loess area of the northern part of the province, are some forests of pine, birch, and poplar, which might be considered as belonging to this floristic region. It has been reported that in this wild area, partly denuded in earlier years, the forests returned to some extent after the destruction of the population in the great Moham-

<sup>1</sup> Published as a monograph issued under the auspices of the North China Branch of the Royal Asiatic Society, 31 pp., illustrated, 1938.

medan rebellion of 1867 to 1878. In the mountainous or hilly Shantung Peninsula the original forests have disappeared and been replaced in small part through scientific reforestation, in some cases with foreign trees such as American black locust, Scotch pine, and others. This work was started when the area was partially under German control.

The ranges of many of the dominant plants of this northeastern region extend northward into Siberia. These species are thus considered as Palaearctic. There are, however, a number of endemic species of considerable importance. Here occur also a number of plants belonging to the eastern Asiatic-eastern North American group, as for example the popular oriental medicinal plant ginseng.

#### THE GOBI DESERT REGION

The Gobi Desert region covers most of Inner and Outer Mongolia and includes the Ordos Desert within the great bend of the Yellow River. It is really the eastern end of the great desert region that extends from northern Africa across Arabia, Iran, central Asia, northern Tibet, and Sinkiang or Chinese Turkestan. The flora of all these regions is closely related, the ranges of many species found in the Gobi Desert extending far to the west, some even to Africa. The driest and most desertlike part is in the south, roughly along the line of the Yellow River, where are found in places, especially in the Ordos and in eastern Kansu, large wind-blown sand dunes with no vegetation to hold them in check. Elsewhere are rock-strewn plains or hills with an occasional, usually dry, watercourse, along which occurs some vegetation consisting largely of drought-resistant, dull green shrubs, trees, and grasses. Just north of the Yellow River lie paralleling mountain ranges, the Alashan and In Shan, which are high enough to intercept in summer the remnants of the monsoon winds from the southeast and to drain from the clouds sufficient moisture to maintain forests of spruce, pine, and poplar. Toward the southeast, east, and north the desert becomes more moist and merges into grasslands, which in turn merge on the north into the forests or steppes of Siberia and on the east into the Manchurian forests.

There are of course very few trees and shrubs in the true desert. Those which can survive the extremes of this severe continental climate and the scant moisture are mostly willows, elms, poplars, tamarisks, saxauls, and a few others. The saxaul (*Haloxylon ammodendron*) is the most characteristic plant of this desert as of all central Asia. It is a leafless tree, rarely reaching 30 feet in height, with green branches, and is a member of the goosefoot family (Chenopodiaceae), which is largely composed of herbs and semiwoody shrubs. The garden beet and the common lamb's-quarters or pigweed of our gardens and

waste places belong in this family. A favorite food of the camels and other browsing desert animals is the nitre bush (*Nitraria schoberi*) of the caltrop family (Zygophyllaceae), which grows in the saline soil so common in deserts. It is also an emergency food for man. The characteristic central Asiatic desert vegetation is largely composed of other members of these same families and of the orpine and tamarisk families (Crassulaceae and Tamaricaceae, respectively), and certain genera and species of the mustard (Cruciferae), pea (Leguminosae, especially the spiny caraganas), pink (Caryophyllaceae), and other families as well as euphorbs, sedges, and grasses. The interesting drug plant *Ephedra*, rather new in western medicine, but long used by the Chinese, is found in the desert.

There are no endemics in this flora, a fact of considerable importance in considerations of the extent to which the deserts of Asia may be man-made and how much they are the result of natural conditions. Whatever may be the answer to the question of the origin of the Gobi Desert, we are very sure that it is gradually extending itself eastward and southward and encroaching on the more habitable lands which man needs. Besides the unmistakable historical evidence for this progressive desiccation, which is to be found in ancient written records, in the reports by people still living, telling of present desolation where once they saw green fields, and in the ruins of once prosperous cities now buried in sand, we have botanical evidence in the buried and fossilized remains of trees of species which can grow only under more moist conditions than now exist. Other evidence is seen in the remains of Chinese agricultural activity north of the Great Wall, where now it is impossible, and in the increasing occurrence of dust storms spreading down over China, even as far as Canton. Probably, this progressive desiccation is a result of a progressive change in climate, and nothing will stop it except a reversal of the trend. In this advance of the desert the conifers succumb first, and then the maples, oaks, walnuts, and other hardwood trees. The poplars, elms, and willows survive the longest, and these constitute the principal trees found today in the towns and cities along the Yellow River and the edge of the Gobi Desert. In some places one finds the fruitful jujubes or Chinese dates cultivated or wild. For people who are accustomed to seeing the best of woods used in ship construction it is rather hard to imagine boats made of willow planks, but, having no better material available, boat-builders on parts of the Yellow River or Hoangho must of necessity use this material.

#### THE LOESS REGION

The dust blown out of the Gobi Desert has throughout the ages settled down on regions to the south, building up great deposits of the distinctive material called loess. This deposit varies in thickness

from a few inches to several hundred feet and covers a large area in Kansu, Shensi, and Shansi. (For approximate location, see map, fig. 1.) The climate of this area is essentially continental, and the vegetation is scarcely better off for quantity of moisture than is that in the Gobi and Ordos Deserts. Most of the rain comes in July and August. However, the fine loess soil holds by capillarity the water which it does receive and raises it from the water table to heights where deep-rooted plants can reach and use it. The loess itself is highly fertile, and good crops of shallow-rooted plants can be grown where sufficient water can be brought to the fields. Thus, the loess region is better provided with vegetation than is the desert, but yet, as compared with the rest of China, the plant cover is woefully thin. In composition this vegetation is closely related to that of central Asia and the desert regions. Jujubes, poplars, elms, and willows constitute the principal woody plants. There are no endemics. In all probability forests grew here in former times, but scarcely any remnants are left today. As wood is lacking there is little fuel and practically no timber for building, but the happy circumstance that the loess deposits can be tunneled into without caving in enables whole villages to be carved out of the cliffs, and wood need be used only for doors, window frames, furniture, and farm implements. As the walls of these cave dwellings conduct little heat, the houses are cool in summer and warm in winter.

The great problem in the loess region is that of erosion by water and by wind, aided by violent earthquakes. With such unstable conditions prevailing and with the inhabitants scraping the hillsides for every possible bit of fuel, a thriving native vegetation could hardly be expected.

#### MIDDLE CHINA

The bulk of the flora which is commonly thought of as characteristically Chinese is found in the great basin or basins of the Yangtze River and its tributaries. This is the largest floral province in China and extends from the Tsinling Mountains, southern Honan, and north-central Anhwei and Kiangsu on the north to the northern border of Kwangsi, the northern portion of Kwangtung, and southern Fukien, and from the coast of the China Sea, except parts of Fukien and Chekiang, westward to the lower parts of the high snow-clad mountains in the west. The plateau of Yunnan lies within this floral area. The Tsinling Range on the north effectively cuts off the cold winds of central Asia and permits the vegetation toward the south to thrive under the more benign influence of the summer monsoon from the southeast. Hence, in contrast with the cool-temperate flora of north-eastern China and the desert vegetation of the Gobi and loess regions, we find in middle China a warm-temperate or even, in places, a sub-tropical vegetation. It varies, of course, with the distance from the

sea and the consequent intensity of the rainfall and its distribution through the growing season. The monsoon reaches the Yangtze River in April and Kansu in late summer. Furthermore, the regularity of the monsoon winds decreases toward the north, where, because of the caprices of these winds, occur most of the well-known periodic famines of China. For instance, that of 1877 and 1879 in Shansi was the result of a continuous current of air flowing down the Yangtze Valley which prevented the monsoon winds from the south or southeast from reaching northern China as they usually do.

As in most of the northeastern floristic region and in the semi-tropical part to the south one of the most significant features of the vegetation in middle China is its alteration by man. Wherever agriculture is at all possible, we find the native wild vegetation entirely replaced. The demands of the dense population for fuel and other plant products are so great that the original vegetation on the neighboring hills, which cannot be cultivated, has been largely destroyed. Only the hardiest native plants remain, unless protected by temples or monasteries or sometimes by enterprising villages in communal forests or woods. True forests remain only where they cannot be exploited profitably because of their distance from rivers on which logs can be floated to market. In consequence of the almost complete alteration of the native vegetation in the various large basins and valleys which comprise this area, we can learn of the original vegetation of middle China only by studying the forests still remaining on the major divides.

The northernmost forested area is the Tsinling Range lying south of the loess area and dividing the Wei and Han Rivers in southern Shensi. It extends eastward into Honan where it is much less prominent. The eastern part of this range reaches up to 12,000 feet in places, high enough to have subalpine rhododendron thickets above a zone of firs (*Abies*), pines, birches, and willows. Somewhat lower down, especially on the southern side of the range, occur forests of deciduous broadleaved trees, as in northeastern China, but containing species less tolerant of the severe winters of that area, such as ash, liquidamber, *Fortunea*, *Paulownia*, *Catalpa*, *Ailanthus* or tree-of-heaven, and even bamboo.

South of the upper part of the Han River, forming the northern and eastern border of Szechwan, lies the Ta Pan Shan, which, together with the Tsinling Shan, is the eastward extension of the Kuenlun Range separating Turkestan from the Tibetan Plateau. Forests of great commercial importance are found in the Ta Pan Shan in Szechwan, southern Shensi and western Hupeh. From them much timber and many other products, such as various gums, resins, nut galls, edible fungi, and medicinal plants, are exported to adjacent

populated areas. These forests contain many of the same species of trees as are found in the Tsingling Shan, with the addition of some more southern species such as *Dalbergia hupeana*, valued for its heavy, close-grained wood used for farm implements, oil presses, and similar objects. The boats built on the Han River are better than are those built on the Yellow River, for here are found many more suitable woods, among them being *Paulownia* and *Catalpa*.

South of the Ta Pan Shan in eastern Szechwan is a hilly area where many trees are grown for their commercial products, especially wood oil (pl. 8, fig. 2), varnish (pl. 8, fig. 1), and wax, and mulberries for their leaves to feed silkworms, and bamboo for its multitude of uses. These trees are also grown throughout most of the Red Basin of Szechwan. This province is so well protected from the severe continental climate of central Asia by mountains on the north and west that it has in places an almost subtropical vegetation. Much fog occurs here in summer; indeed, the name of the next province toward the south or southwest, Yunnan, means "south of the clouds." The high humidity is especially favorable for plant growth.

South of the Yangtze, in southern Szechwan, Kweichow, southwestern Hupeh and western and northwestern Hunan, are more mountains whose forests have been saved from exploitation by their inaccessibility. In general, these forests have the same composition as those on the Ta Pan Shan, but there are in addition many species with more southern affinities. The important southern fir, *Cunninghamia lanceolata*, which also is found north of the Yangtze River, but not north of the Han Ho, is found here. Western Hunan and the adjacent parts of eastern Kweichow have been very important centers of timber supply to central China for many centuries. Here are found pines of species different from those of northeastern China, also *Cedrela sinensis*, a northward-extending member of the mahogany family (Meliaceae), the camphor tree, and nanmu (*Phoebe nanmu*), a tree of the laurel family (Lauraceae) with exceptionally valuable wood, various oaks and chestnuts, and many others. It has been reported that there are in Hunan many forests or woods planted, protected, and managed in a very satisfactory manner by clan effort. These are located away from the main traveled routes and are not commonly seen by people just passing through.

Another important forest-bearing area is the Nan Shan Range, a broad, irregular mountainous tract extending east from the Yunnan plateau and separating the Yangtze valley from that of the Si Kiang or West River in Kwangsi and Kwangtung. In its inaccessible parts are forests, primarily of the oak-chestnut formation. These are, however, mere remnants of the vast, rich forests which once grew here and include, of course, many other species than oak and chestnut.



Along with those species which form the forest canopy are found also members of the tea family (Theaceae), essentially a subtropical group of trees and shrubs. Characteristic of the lower woody plants are members of the laurel family (Lauraceae). Indeed, the members of this group in middle China are so prominent that the vegetation of central China and Japan is sometimes referred to as of the "laurel type." Conifers are not abundant, but the south China fir, *Cunninghamia lanceolata*, thrives here and is the most promising tree for reforestation. The more primitive people dwelling here use this species in maintaining forests in northern Kwangtung and elsewhere. It is encouraging to read that where Chinese are in close contact with these earlier inhabitants of the land, they are using this same species in reforestation work. This fir is very easily grown, because it sprouts readily from the cut stumps and may be grown from cuttings. The only other conifer with the natural ability to propagate vegetatively is the *Sequoia* or giant redwood of our west coast.

The only other major forested watershed of middle China is formed by the mountains of southeastern Anhwei, Chekiang, Fukien, northeastern Kwangtung, and the adjacent border of Kiangsi. In this area are still found some fine and even fairly extensive coniferous and broadleaved forests, the former of several valuable species, the most important being red pine (*Pinus massoniana*, pl. 2), the funeral cypress (*Cupressus funebris*), *Cryptomeria japonica*, and the southern fir (*Cunninghamia lanceolata*). The principal broadleaved trees are camphor, oak, chestnut, and *Ormosia henryi* of the pea family. Many of the species found here occur also in western China. Although we commonly think of the flora of eastern China as distinct from that of western China, because of the different flora of the intervening area, yet on careful comparison the east and west are found to be too much alike to be properly considered as distinct. This is good evidence that originally the flora of the central region was the same, but that its character has been materially altered by man. These forests of southeastern China also have definite southern affinities. In the southern part are many species occurring in Kwangtung, Hainan, and even Indo-China, but in the northern part there is a much smaller proportion of southern species.

These forests are, of course, being extensively exploited, but Dr. H. H. Hu, of the Fan Memorial Institute of Biology, who explored the region about 1925, reports that conditions are not so serious as they are usually depicted by western writers and that in many regions the forests are properly cared for. With proper governmental protection others can be restored.

The plants occurring in the larger part of Yunnan belong to the middle China vegetation. East of the high mountains of this province

lies a large highly dissected plateau ranging downward from about 4,000 feet altitude. It has a warm-temperate climate with more tropical conditions in the lower parts of the valley, as along the Yangtze. The vegetation of this part of Yunnan is, therefore, subtropical with warm-temperate elements. In general, the hills are less denuded than in the eastern mountains of China, owing in part to the lesser Chinese population and the greater abundance of Thai, Shan, and other non-Chinese peoples. These latter inhabitants are less agricultural than the Chinese, hence the wild vegetation is less disturbed. They do, however, affect the vegetation adversely to some extent by clearing the hillsides and cultivating them without terracing or using other means to reduce erosion. In 2 or 3 years, when the fertile soil is washed away, these areas are abandoned and new fields are cleared. The abandoned fields may eventually revert to the original forested condition, but only after a succession of stages, some of which are very undesirable.

Taken as a whole the flora of middle China is warm temperate with admixtures of subtropical families, genera, and species. It is rich in endemics and includes most of the eastern Asiatic-eastern North American species and genera (pl. 4, fig. 2). The Japanese flora, except for that of the more tropical parts, is essentially of the same type as that of middle China.

#### TROPICAL AND SUBTROPICAL SOUTHERN CHINA

In this area is found the extension into China of the tropical or subtropical jungle vegetation of Indo-China and the Malayan region. The area comprises all or most of Kwangsi, most of Kwangtung, the coastal region of Fukien and part of Chekiang and, of course, of the islands of Hong Kong and Hainan. The lowland vegetation of Formosa and that of tropical Japan are of this type. Climatically the region is dominated almost wholly by monsoon winds, which bring an abundance of rain from March or April through October, with relatively little rain from then till March again. The Nan Shan Range on the north cuts off most of the coldest winter winds from that direction, so the winters are milder than in middle China. Freezing temperatures are very rare near the coast. Judging by the jungles still found in Hainan and by the oases of tropical vegetation still found in a few remote mountain ravines and around temples, and in comparing this area with places in other parts of the world which have a similar climate and formations, but which are as yet undevastated, it is rather clear that large broadleaved evergreen rain forests formerly occurred where we now find only grass-covered hills. The amount of cultivated land in this area is relatively small, consisting mostly of the rich delta of the West, North, and East Rivers

and their rather narrow valleys, and of similar delta areas along the coast. Here the luxuriant vegetation is under complete control, and the hills that protrude through the delta plains are given over to the graves of past generations on which the cattle graze. There is little room for native forests and no incentive to develop them. Hainan Island, being more thinly populated with Chinese around the edges and with more primitive peoples in the interior, still has tropical jungles, which vary in character at different altitudes. On the higher parts are oak-chestnut forests with broadleaved evergreen rain forests below.

Hong Kong Island and Kwangtung are botanically the best-explored parts of China, the flora of Hong Kong published in 1861 being the first real plant manual of any part of the country. The flora is rich in species but poor in numbers of plants. In Hong Kong much reforestation has been carried on by the British, and the appearance of that island contrasts sharply with that of adjacent islands and the mainland. The red pine (*Pinus massoniana*) occurs widely throughout south China, usually planted more or less widely spaced on the mountains, but sometimes as groves, and occurs spontaneously as a forest tree in the mountains of Fukien and Chekiang. The wide spacing of the planted trees encourages the development of side branches, which are eventually cut off (pl. 2) and used as fuel in brick and lime kilns. The groves are needed for geomantic or "fung-shui" purposes, to propitiate the evil spirits which are popularly supposed to infest the country (pl. 4, fig. 1).

Another common tree in the region is the banyan, of which there are several species (pl. 5, fig. 2). These trees have little use as fuel or timber. Hence they grow unmolested, spreading wide over the villages and temples their huge branches from thick, gnarled and furrowed trunks, which rise from a broad, often exposed base of tangled roots. Palm trees, mostly cultivated, can be seen in places, and clumps, groves, and even small planted forests of bamboo add much to the picturesqueness of the landscape. Planted or possibly spontaneous along the muddy tidal canals and channels of the delta occurs the water pine (*Glyptostrobus pensilis*), a close relative of the bald cypress of our southern swamps. Strangely enough this species has been found in abundance growing spontaneously on hilltops in Kiangsi Province in middle China. Our own cypress will also grow in much drier situations than in its characteristic swamp habitat, especially with human encouragement.

The vegetation of Kwangsi Province is very similar to that of Kwangtung but has more forests and perhaps a few more Indo-Chinese species, at least in the south. (See pl. 3). Extensive botanical collections have only rather recently been made, and as yet little has been written of the vegetation of the province as a whole.

## SOUTHWESTERN TROPICAL YUNNAN

The southwestern part of Yunnan adjacent to Burma is under the influence of the monsoon winds which in summer flow from the Bay of Bengal laden with moisture. The lower portions of the great parallel gorges, which are such a prominent feature of western Yunnan, lie under the influence of these winds and are filled with luxuriant rain-forest vegetation. Here most of the trees are evergreen, and the jungles are filled with lianas, palms, tropical nettles, and other characteristic plants of the dense rain forests. This floristic region of China is only an extension of that of Burma and Siam. Many of the very numerous species of plants occurring here are Indo-Malayan or are characteristic of tropical India. As in other tropical rain forests, malaria is common and conditions are unfavorable for human habitation. This difficulty is overcome in some of the gorges by building the villages high up on the sides, whence the people descend to the fertile river bottoms to till their crops.

Southern Yunnan also has a highly tropical vegetation with many species of plants which likewise occur in Hainan and elsewhere in southeastern China, but with a gap between. There is, however, in the valley of the Red River and adjacent streams a dry area of limited extent due to local variations in climate.

## THE HIGHLANDS OF WESTERN CHINA

The western and northwestern portion of Yunnan is botanically more or less distinct from the great dissected plateau to the east and the monsoon-drenched mountains and lower ends of the gorges to the south. In these deep gorges flow the great rivers which arise on the Tibetan plateau and cut across the eastward and northeastward extension of the highest mountains of the world, the Himalayan Range. Originally these mountains extended in an east-west direction, but their deep intersection by southward-flowing streams has left the intervening ridges stretching north and south. The original mountain peaks tower up to over 20,000 feet, well up into the regions of perpetual snow. It is obvious that this tremendous range in altitude and the extremely rugged character of the land would greatly affect the type of vegetation found in the region.

When the moisture-laden monsoon winds from the southwest are forced to rise up the slopes of these mountains they lose their load and are dissipated. Hence the vegetation in this region is less luxuriant than that farther south. Another meteorological phenomenon that occurs in the gorges results in very arid conditions. During the day the sun heats the air in these closed-in canyons to a temperature much above that in the side canyons and on the surrounding moun-

tains. About the middle of the afternoon this heated air suddenly starts to rise and creates such a current that any attempts of moisture-laden monsoon winds from the southwest to penetrate the area are completely thwarted. This dry area occurs in the valleys of the Salween, Mekong (pl. 7, fig. 1), and Yangtze Rivers. On the Salween it begins at about the 28th parallel but farther south on the other rivers. On the Yangtze it includes the gorges around the great bend north of Likiang.

Thus only drought-resistant stunted shrubs and moisture-holding herbs can survive here and the vegetation in part is related to that of Central Asia. A strange exotic is an American cactus (*Opuntia*) which somehow reached this out-of-the-way land and found conditions favorable to its growth and survival. Its seeds and fruits are eaten by men, beasts, and birds. How it arrived is quite unknown. Possibly it was brought by some missionary long ago or possibly it came with some caravan from the Near East where it was introduced soon after the discovery of America.

Higher up on the mountains occur great forests of deciduous trees of various kinds, then conifers in zones (pl. 6), then rhododendron thickets, and finally alpine formations of various kinds, especially the gorgeous alpine meadows. Here is found the rich vegetation so eagerly sought for by plant explorers in search of ornamentals for western gardens, especially rock gardens (pl. 5, fig. 1). This is the plant-lover's paradise, for from this varied region have come many of our most exquisite rhododendrons, primulas, poppies, larkspurs, and other garden favorites. Here occur vast forests, mostly as yet unexploited, a future storehouse safe from the ax until railroads and roads have opened it up.

The area extends northward from Yunnan through eastern Sikang and Tsinghai to western Kansu. It is peopled largely by Tibetans and has been called Tibetan China. On the east it merges with the more temperate or even subtropical vegetation of Szechwan and on the west with the grasslands of Tibet.

In respect to affinities this rich flora contains many elements of the Himalayan flora of northern India, in contrast with that of tropical Yunnan, which is largely Indo-Malayan. It contains also a large number of endemics as well as elements of the flora of middle China. Yunnan as a whole has the richest flora of any of the 18 provinces of China, having over 6,300 species. This is not surprising in view of the great diversity of climatic and physiographic conditions, the proximity of a great variety of floras of different composition and origin, and the long uninterrupted geological history of the larger part of the province.

Far back in geological history, in the Oligocene period, Eurasia was divided by the Tethys Sea, which occupied about the present location of Burma, Assam, and Tibet and separated China from India. Asia was a continent of undulating wooded lowlands without high mountains. The flora was probably fairly uniform. Later mountains were formed which upset the climate and brought about a diversified flora. Finally the Himalayan uplift occurred, which eliminated the Tethys Sea and replaced it with the world's highest mountains, through which the rivers from the uplifted Tibetan plateau cut transverse courses. In the succeeding Pleistocene period huge glaciers developed in these mountains and spread out northward over the southern half of Tibet and east and south over western Yunnan. Thus the plants of these ice-covered parts were wiped out, but, because of the limited spread of the glaciers eastward, the vegetation of central and eastern Yunnan remained. It may have been altered and forced southward but was not destroyed. When the glaciers receded, this altered vegetation spread back into the released western part of the province, and the plants of Indo-Malaya spread northward again. At the same time conditions were favorable for the flora developed in northern India to invade this territory. Hence, the Yunnan flora today contains elements from the diverse floral regions round about, as well as remnants of the early flora developed in the province in earlier geological times. The lack of extensive glaciation in north China, such as occurred in Europe and northern North America, accounts in part for the richness of the flora of China as a whole in comparison with that of the heavily glaciated continents.

#### THE GRASSLANDS OF EASTERN TIBET

The grasslands of eastern Tibet lie in the new provinces of Sikang and Tsinghai west of the great mountain ranges of western China and extend somewhat into western Kansu Province (pl. 7, fig. 2). These lands are the home of the Tibetan nomads where flocks of yak are herded and the people live in yerts or felt tents. The vegetation is almost entirely composed of grasses and grasslike plants, with many herbs remarkable for their ability to burst forth early in the short growing season, cover the landscape with a riot of gorgeous color, and quickly ripen and shed their seeds before the early winter forces them into dormancy again. Shrubs and trees are few or wanting on the uplands, but exist in the sheltered valleys and in belts on the mountains, where the clouds are forced to drop more moisture.

The vegetation of these grasslands is essentially central Asiatic and alpine, and the few woody plants and trees are largely of northern affinities.

## TIBET

Besides the floristic provinces already discussed as extending into Tibet, namely, the arid valleys of the great rivers draining southeastern Tibet, the high mountain vegetation of the Tibet-China borderland, and the grasslands, Tibet has two other areas. These are (1) the northern and northeastern parts, called by F. Kingdon Ward<sup>2</sup> the Chang Tang or Great Plain, including the Tsaidam in Tsinghai Province, the whole draining entirely into salt lakes and swamps, and (2) the outer plateau part north of the Himalaya Mountains drained by five great rivers, the Indus, Tsang Po, Salween, Mekong, and Yangtze. The divide between these areas is generally low and rather imperceptible.

The Great Plain and Tsaidam on the north at an altitude of over 8,000 feet have a rainfall ranging from almost nothing at all to only 10 inches per year. The flora, according to Ward, is extremely meager and consists of about 53 species of plants, with only 3 woody genera and no endemics, nearly all being central Asiatics. A richer vegetation could not exist in such an extremely dry and severe climate.

The outer plateau toward the south has a better climate, with rainfall ranging from 10 to 20 inches per year. Its altitude of around 12,000 feet, with its exposure to the cold winds of the north, permits only a limited and rather xerophytic flora to develop. However, there is sufficient moisture and protection, at least in the river valleys, for the development of an alpine and semidesert flora, the dominant woody plants being willows, poplars, junipers, and certain elms. At the head of the gorge country toward the east are found some forests. In the gravel portion of this plateau, in the vicinity of Lhasa, Ward reports that 541 species of plants are known. It is in this part of Tibet that the bulk of the population is found.

## THE ECONOMIC BOTANY OF CHINA

## CONCERNING DEFORESTATION

The most outstanding economic problem of China is raising food for her more than 400 million people. So intense has become the struggle for food in China that little energy has been left for the consideration of other problems. The need for more and more food has been met by increasing the amount of food grown on an acre of land and by increasing the acreage. This has been accompanied by a steady increase in the human labor expended and in the taking of land away from other uses, notably the taking of forested land. In the wake of these changes have come numerous other problems which

<sup>2</sup> See his A sketch of the geography and botany of Tibet \* \* \*, Journ. Linnean Soc., Botany, vol. 50, pp. 239-265, illustr., 1935.

have demanded adjustment, such as the loss of timber and plant cover, the exposure of the hills to erosion (pl. 1, fig. 1), the destruction of agricultural lands through washing away and silting, and a host of other consequences. As in other countries, the demand for increased crops and more tillable land has fallen on individuals and small groups, who in many, if not most, cases have been unable to meet the resulting larger problems and who have in time been reduced to the direst poverty or been driven away from the lands they so urgently need to areas where they can only eke out a bare subsistence and repeat the destructive processes. Thus, next to agriculture, reforestation is the most urgent economic botanical problem in China. Many references have already been made to this subject, but its importance justifies separate consideration.

The major cause of forest destruction in most areas, at least in the past when there were extensive forests, was the need for agricultural land rather than for the products of the forests. The same is true in some regions today, as is shown by the wanton abandoning of thousands of board feet of merchantable timber, as was observed by W. C. Lowermilk in his studies in Shansi. After the lowlands were cleared, this demand for more land could be met only by terracing the hillsides (pl. 1, fig. 1), progressing gradually higher and higher until the slopes became too steep for cultivation even by these means. Even on the still steeper and higher slopes agriculture is often possible for a few years without terracing by growing, at least in north China, special crops such as maize or Indian corn and potatoes, both originally from America. Soon, however, the soil washes away and the fields must be abandoned.

The second most important cause for the forest removal is the need for forest products, especially timber. With the gradual removal of the timber near centers of population the quality of the lumber decreased and the price went up, so that the standard of living fell lower and lower. Much of the timber now seen rafted to market in China would not be transported in America even for fuel or pulpwood. When the huge wooden pillars of the Temple of Heaven in Peiping, originally brought down from Manchuria, were destroyed by fire, they could only be replaced from the fir forests of the northwestern United States. But the common man cannot rebuild with imported lumber; he must use sun-dried bricks or mud plastered over kaoliang stalks.<sup>3</sup> Every stick of available wood must be used for the best purpose to which it can be put. The ever-increasing demand, as the population has grown, has led to more and more cutting of the forests, then to scratching the treeless hillsides for whatever would serve as

<sup>3</sup> Kaoliang is a variety of *Sorghum nervosum* resembling kafir corn which is sparingly grown in America. Kaoliang fields in Shantung remind one of the vast cornfields of Illinois and Iowa.



fuel. It is little wonder, then, that the hills near the great cities are denuded.

A factor favoring destruction in some areas has been the fear of wild animals, such as tigers, leopards, and wolves, and of wild men or bandits, who, indeed, may be the very people who in the first instance lost their land through erosion and then turned to banditry in order to maintain life. Thus forests have been cut down and the new growth kept under control by repeated burning, till grasses were thoroughly established which can now be replaced by forests only with the greatest of difficulty. It has been reported that hillsides have been burned over so that the ashes will wash down and fertilize the cultivated lowlands.

It might be supposed that the obvious value of the forests to the country as a whole would have led to governmental control of cutting and to replanting on an extensive scale. Such has indeed occurred in certain ancient times and has been resumed in the modern period of China's awakening. But governmental control in China has long been weak, and the intense preoccupation of the people with the struggle for existence has prevented any general demand for improved conditions. It has been observed that in the Ming and Ching Dynasties the officials were drawn largely from the "literati" or scholars of the country, who, though they appreciated the forests around the villages and temples, were little inclined to protect, maintain, and develop forested areas. They left the problem to the lower classes, who had little or no vision beyond their narrow fields nor means to carry out what little they did have. Furthermore, the rulers, unlike many of the feudal governors of Europe, were not given to sports requiring hunting preserves. Hence, no wild areas were protected for their immediate owners and for posterity, as happened in Europe. An exception is found in certain imperial hunting preserves in north China, most of which, after the fall of the Empire in 1911, were sold by the abandoned and impoverished Manchus for commercial exploitation, so that they themselves might still subsist. This lack of interest in forests on the part of the "literati" rulers has prevented the Government from protecting any private investment in maintained forests, so that the common people have been unimpeded in their seizing of whatever they could. Even safe titles to nonagricultural lands could not be had, so that there was little incentive to private initiative in forest development, and lumber companies could profit only by quick and complete exploitation of whatever concessions they could obtain.

Even the little protection which the Government could give in peace times has been impossible in times of war. During these crises, especially following the revolution in 1911, forest destruction has gone

on unhindered. Records of the Taiping Rebellion are full of accounts of destruction of trees and forests. In 1911 there were large forests on Loh Fau Shan about 50 miles east of Canton, but Prof. R. Mell reports that by 1921 only a sixth of them were left and by now they are probably all gone. Loh Fau Shan was, for at least 10 years following 1922, a bandit land where no government official dared intrude.

Along with the weakening and modernizing of the Government following the revolution has occurred the steady decline in the influence of the Buddhist temples and monasteries, which have long protected their encircling forests and jungles as part of their reverence for wildlife. But as their official state support dwindled they, like the abandoned Manchu officials, sold their assets for commercial exploitation.

The factors making for preservation of forests in China are far weaker than those making for destruction, but are, nevertheless, worthy of some consideration. Foremost among these is the difficulty of transporting the forest products in areas distant from rivers and streams. Where trees must be carried for long distances on the backs of coolies over simple mountain trails, forests can remain (pl. 9, fig. 1). Until the motor or railroad age reaches western China its vast forests are safe. Likewise the Buddhist philosophy of the preservation of all life and the demands of that religion for isolated seclusion have preserved throughout the ages many remnants of the primeval forest and even aided new forests to grow up. These preserved oases are of great scientific value in showing what the original native vegetation was and thus enabling modern reforestation to proceed on a sound biological foundation.

The emphasis that western writers have put on the destruction of Chinese forests has often blinded people to the practice of forestry that has existed in the country even for many centuries. In places there are clan or community forest projects, a few of which have already been referred to. W. C. Lowdermilk has mentioned seeing well-managed communal forests that exceed any similar enterprises, even those of Germany. Foresters who have visited some of the more inaccessible parts of Kwangtung and Kwangsi have been surprised to find thriving reforestation projects using the southern fir (*Cunninghamia lanceolata*), grown when young under the shade of manihot or cassava bushes. They report that this is largely the result of a greater appreciation by the aborigines of the value of trees and that the Chinese near them are favorably influenced to adopt their methods. These efforts at reforestation probably result largely from the need for forest products. Indeed throughout much of Kwangtung the growing of the red pine (*Pinus massoniana*) for fuel, including the

branches for brick- and lime-kiln fuel, may be considered in this same light, though the scattered way the trees are grown hardly leads to real forests.

Scientific reforestation has made a beginning in China. Its first attempts were in Hong Kong under British supervision and in Shantung when it was under German control. In the former colony there has long been a forestry department, and much replanting of the hillsides with native pine has occurred. In Tsingtao foreign trees, including American black locust, Scotch pine, and many others, have been successfully used. Nanking University and Lingnan University have contributed much to the program, and Sunyatsen University has had an active forestry department and careful studies have been made leading to a thorough program of reforestation. Experimental plots have been tried with various trees, some of which are encouraging, others not so promising. *Cunninghamia* is the most promising for the higher parts in northern Kwangtung, but it proves to be unsuited to the lower lands. Here must eventually be established evergreen tropical forests on the now grass-covered hillsides. This transformation cannot be made in one step. Instead intermediate growth must be established using carefully tested trees, capable of growing well on these open hillsides, such as possibly *Eucalyptus* of selected species, *Dalbergia sisoo*, a leguminous tree from a similar formation and climate in Assam, the native *Pinus massoniana*, the chinaberry tree (*Melia azedarach*), wood oil (*Aleurites* spp.), *Leucaena glauca*, and others. An enlightened insight has come to the leading scientific men of China, but as yet it has not come to the masses.

#### THE USES OF CHINESE PLANTS

Almost all the Chinese prescientific interest in plants from the mythical scholar Shen Nung of 2000 B. C. to the beginning of the scientific period in China in the present century related to their usefulness to man. The same was true in western countries, for the earliest European botanical books, like those of the Chinese, were herbals or books on the medicinal and food-yielding properties of plants. Even today most people are economic-minded. Ask any person not trained in science about a plant and his reply will be either that it is a weed or a useless plant, or that it is "of some good"—that is, useful. So we find a vast storehouse of information on useful plants in Chinese literature, but little if anything concerning noneconomic plants.

The first great use of plants to man is of course for food, and in this field the Chinese excel. Whether it be their greater control of prejudices against certain food plants as lowly, unpalatable, or harmful, or whether the constant recurrence of disasters which have taken away their normal foods and thrust them back against the evil choice of

starving or of eating whatever can be consumed regardless of prejudice, it is hard to say. But the fact is that in China more kinds of plants are eaten than in the west. Famines have occurred in the west, but never was there written outside of China a book telling what to eat in times of famine, or a "famine herbal," such as that written by Chu Hsiao in the fifteenth century under the title "Chiu huang pên ts'ao." This book has been issued in many editions, several in Japan, and large parts have been translated into western languages.

Intensive agriculture is probably more highly developed in China than in any other part of the world. Throughout its thousands of years of growth methods have been found that derive from the soil almost the last possible ounce of food, but at the same time leave the land capable of growing more crops indefinitely. Of course modern scientific agricultural methods can make and are making valuable contributions to Chinese farming and furnish explanation for many of the empirical methods used in China, but at the same time the west is learning much from the east. Certain food plants have long been grown in China which the west is only beginning to appreciate (pl. 9, fig. 2), and we are discovering there methods of storing and marketing which we can well consider. For example, in 1924 P. H. Dorsett, agricultural explorer for the United States Department of Agriculture, studied for the first time the methods used near Peiping in handling the large persimmon crop. The fruits mature throughout the fall. When fresh, these large tomato-sized orchard fruits are too full of tannin to be eaten. Hence, the first of the crop is carefully treated in a hot-water bath for about 12 hours, which process removes the tannin and renders the fruits readily marketable. The bulk of the crop, however, matures late in the fall. Most of us in the southern and south-central United States have learned that persimmons picked before the frosts of early winter will pucker one's mouth, but that those gathered later are good. This fact has never been used for commercial exploitation of the American persimmon, but the Chinese have applied the principle on a large scale and millions of persimmons are stored in special outdoor beds where they quickly freeze (pl. 10, fig. 1). Not only are they thus rendered delicious by the removal of the tannin, but they are also preserved, so that they can be marketed throughout the long winter, being thawed out only as needed. Frozen or frosted foods in the west are of very recent development and require complicated artificial refrigeration. The Chinese industry resulted from the careful development of the right varieties or forms of persimmons, grafted on the proper stock, and grown in a country where natural freezing is possible. Also the size of the crop must not be so great as to

flood the facilities for early treatment by hot water, or to flood the early market, nor too great to be consumed before the heat of spring and summer finds unsold stocks in the storage beds.

So it is with many other food plants and methods. We in the west, handicapped by our prejudices of taste, have only probed the surface of Chinese agriculture for new food plants, or new forms of old ones, or methods of handling them. Of course the major difficulty lies in the fact that labor is cheap in China and agricultural methods give scant consideration to the human efforts expended, whereas in western agriculture labor must be saved at every turn.

Next to their use as foods, plants are sought by man the world over for their medicinal virtues. In China food and medicine are closely linked, and a skillful housewife of the wealthier classes keeps her family in health by the right selection of foods from the great range available, rather than by the administration of drugs. A Chinese pharmacopoeia is full of food plants. It contains likewise a far larger number of drug plants than do our western medicinal handbooks, which, indeed, with each new issue list fewer and fewer plants as sources of useful drugs. Many of these Chinese drugs and their plant origins have been examined by modern scientific methods and some have proved of real value, as the ma-huang, the desert plant *Ephedra sinica*, which has long been used in China as a haemostatic and for the treatment of asthma, and only relatively recently adopted into western medicine. Other Chinese drugs have proved of little or no value, such as ginseng, long valued highly in China as a giver of fertility. As far as western science can determine, its virtues are purely psychological, and the plant is not included in our pharmacopoeias. However, only the surface of Chinese medicine has as yet been scratched by modern science.

Plants as givers of building material probably rank in importance ahead of their use for medicine. The supply of wood exerts a profound influence on Chinese life, for in western China, where the population is thinner and wood more abundant, we find it much used in house construction, but in most parts of China, mud or bricks, either kiln-burned or sun-dried, are used, the mud plastered over kaoliang stalks in the north or over bamboo or other materials in the south. In the latter region bamboo frames covered with palm-leaf thatch are often erected for temporary buildings. Few who have seen the construction work in any of the large cities, especially in the central and southern parts, have failed to marvel at the strength, magnitude, and skillful fabrication of the scaffolding erected by lashing together bamboo or pine or fir poles with seemingly frail strips of bamboo and with no use of nails. The lack of wood for ties or sleepers is a great handicap in the building of railroads in China.

Although coal, oil, and natural gas are used in China as sources of heat, their limited distribution and the high cost of transportation of such bulky materials prevent their general use throughout the country. Instead wood and charcoal are burned, except where their lack forces people to comb the countryside for whatever will give off heat. Quantities of rice straw and kaoliang stalks are likewise used for fuel, and the leaves, grass, pine needles, and weeds garnered from the hillsides find their way into the stoves in quantities just sufficient to maintain the minimum of warmth. This combing of the hillsides removes the potential humus and protection needed for seedling trees and shrubs and prevents the restoration of the woody cover (pl. 4, fig. 1). The ashes go to the fields for fertilizer. Charcoal is a favorite fuel because its light weight enables a coolie to carry on his shoulders more potential heat than if he were carrying wood. Nothing is wasted in China. Of course much of the heat problem is solved by the wearing of more clothes, which in turn is related to another plant, cotton.

Besides food, medicine, building material, and fuel, plants also furnish fiber for clothing and other textiles. Cotton is by far the most important, as it is the most economical. Wool is less economical because land is required to feed the sheep or goats, but cotton grows directly, thus producing more "warmth" per acre in spite of its lesser insulating properties. Silk is a luxury, yet probably a greater return per acre of land can be obtained from silk than would be possible from wool, because of its greater value and the export demand. Although the silk comes from an insect, the industry is essentially based on the culture of the mulberry, which grows well in all the warmer parts of China, but especially in the delta of the West River in Kwangtung. Here the long growing season permits the development of sufficient leaves to feed three and sometimes four or five generations of silkworms per year. In some places in north-central China, where the mulberry will not grow, silkworms are fed on certain oak leaves. Many other fibers are grown in China. An important crop in parts of Chihli Province is the ching ma or American jute (*Abutilon theophrasti*), a member of the mallow family (Malvaceae). This is grown as a substitute crop when others have failed for a season. From it is produced a fiber, which, when mixed with other fibers, is used in the manufacture of brocades and silk substitutes.

Many kinds of plants find uses in the manufacture of the numerous articles used in China. Much thought has been given throughout the ages to their cultivation, selection, and adaptation to special uses. Although many plant sources have been scientifically determined, many others remain as yet unknown. It has often been difficult to determine what plants furnish the materials from which even well-known manufactured articles are made, and even today many may not be rightly

named. Indeed, some of the plants may not yet be known to science, for only about 3 years ago it was found that the lo han kwoh, a long-known Chinese fruit of the melon family (Cucurbitaceae), represented a new species, and the same may well be true of some industrial plants. Often a manufactured product or food comes from a special variety or form of a well-known plant, which has been developed in a limited isolated region never visited by anyone with an inquiring scientific mind. Likewise many processes of manufacture have not been adequately described, for few observers give attention to the many minute and apparently trivial details of the intricate processes of turning raw materials into manufactured products or of preparing plants for food.

It is impossible within the scope of a paper dealing in a broad way with the botany of China to do more than suggest the existence of the fascinating field of economic botany. To discuss the plants from which are manufactured paper and textiles other than those already mentioned, or from which oils, resins, gums, varnishes, dyes, drugs, and a host of other products are extracted, would require far too much space. The subject of the uses of the many kinds of bamboo alone is itself one for a separate book. One of the great fascinations of China is the finding of the different ways in which things are done. A factor which makes for the ready observation of such things is the home-and-shop method of manufacture of numerous articles, in contrast with the closed-factory method used in this country. Generally, too, the people are responsive to an interest in their occupations and the methods used.

#### THE EXCHANGE OF USEFUL PLANTS WITH OTHER COUNTRIES

Most of the important crops of Europe and North America originated in Asia. Likewise the most important crops of China are introductions, wheat being a native of southwestern Asia, kaoliang<sup>4</sup> probably of India, and rice of southern or southeastern Asia, as far as known. Many plants were exchanged between Europe and China in early days along the caravan routes across central Asia and Persia, as has been told by B. Laufer, of the Field Museum in Chicago, in his scholarly study under the title "Sino-Iranica: Chinese Contributions to the History of Civilization in Ancient Iran, with Special Reference to the History of Cultivated Plants and Products." The taking of useful Chinese plants to Europe has already been mentioned as the major objective of most western botanists in China. In recent years the methods of search have been much perfected, and the results attained have considerably affected our economic life.

<sup>4</sup> See footnote 3, p. 350.

Of all the parts of the world from which plants may be introduced into Europe and America, China is the most promising because of the great number and diversity of the plants occurring there and because most of them are Temperate Zone plants, hence suitable for cultivation in other temperate regions. Another factor is that during the long development of Chinese agriculture many new varieties and forms have been selected and developed which are also suitable for our use.

Many kinds of introductions have been made from China. Some are ornamentals for adorning our gardens, others are new food plants or new varieties or forms of old ones, or disease-resistant forms, and still others are plants needed in industry, such as wood or tung oil. Furthermore, some plants have been introduced for special protective plantings, such as the Chinese elm (*Ulmus pumila*) from dry north China, much used in our well-known Prairie States shelter-belt project.

The methods used by plant explorers vary according to their objectives, their own individual peculiarities and abilities, and the regions in which they work. Most of them have been sent by some scientific society or government to collect living plants, seeds, or cuttings. Others have been foreign residents in China, teachers, missionaries, or consular officers, who have obtained material in their spare time, or as part-time collaborators with their home governments. Some explorers have traveled far and fast with little baggage, picking up the most promising plants from here and there for mailing home. Still others have traveled in large parties with full equipment and many helpers (pl. 6), usually with official military escorts. Sometimes they have gone unobtrusively about their work, speaking the language and mingling with the people as one of them, or perhaps working with or through a trained native assistant. Some of our explorers have established themselves with full equipment in some large city near the region to be explored, from which they have sallied forth on frequent journeys into the country. This enables them to return as often as necessary to the same place to see the different stages of development of plants they were gathering, or the local process of harvesting and preserving them. Frequently in working in this manner they first visit the markets to discover what fruits and vegetables are being offered for sale (pl. 12, figs. 1 and 2). Then they find whence they came and finally visit the farmers who raised them. One of the plant explorer's greatest problems is packing and shipping the seeds, cuttings, and full plants to their new homes, so that they will arrive safely and in viable condition. They must also be disease-free, so that they may pass the rigid quarantine established to keep foreign diseases from reaching plants in this country not immune to their ravages. Often these collectors have endured great hardships, and a number have died in the field as a result of privations. Many, too,



have lived to see fruitful fields in their homeland bearing valuable crops as a result of their hard labors in distant China.

The plant-disease aspects of plant introduction are very important and interesting. In 1913 after the chestnut-bark disease, then of unknown origin, had begun its devastating attack on this highly important forest tree in America, Frank N. Meyer, well-known United States Department of Agriculture explorer (pl. 11, fig. 1), discovered the same disease in China. He also found that the Chinese chestnut trees were able to survive the attacks of this disease, suffering only wounds from which they could recover (pl. 10, fig. 2). The evidence is strong that by some unknown means this disease of the inner bark, caused by a fungus called *Endothia parasitica*, found its way into this country where our trees were not immune. To replace our doomed chestnuts the United States Department of Agriculture has obtained large quantities of seed from selected Chinese trees which have survived the disease and are therefore known to be immune. Hence, in the course of time, we will have new chestnut trees for shade and chestnut bark for tannin.

Another aspect of the plant-disease problem is the introduction from China of insecticide plants. A few years ago the casual discovery of an article published in Chinese in a current entomological periodical from Chekiang Province revealed the use there of an insecticide powder prepared from the roots of *Tripterygium wilfordii*, a shrub of the staff-tree family (Celastraceae). This organic poison, long known in China, is far superior to mineral poisons, such as those prepared with arsenic, because it disintegrates and becomes harmless by the time vegetables and fruits sprayed with it are ready to be eaten. Plants of this species were obtained by the United States Department of Agriculture through consular officers and Chinese plantmen for experimental cultivation and investigation in this country. Great benefits are likely to result from this introduction when the details of its growth and preparation have been perfected.

Many other examples might be given of various benefits to this country resulting from plant introduction. In like manner China is destined to benefit from importations from the United States and other temperate regions. As yet little attention has been given in China to this method of helping to solve her food problems, but beginnings have been made in extending the work on a scientific basis. In certain parts of China, as for example the higher parts of Kansu Province, it would be possible to grow more nutritive plants than are now commonly cultivated, if the right varieties adapted to their particular climates and soils could be found. Reference has previously been made to the introduction of foreign trees for planting in inter-

mediate stages in the reforestation of denuded mountains. A number of foreign trees have already been planted for this and for various other purposes in China, especially black locust from America, which is being grown to furnish much-needed railroad ties. The possibilities for more profitable introductions are almost endless, and with the cessation of the present war, rapid progress will undoubtedly be made in introducing plants, as well as in using more effectively and scientifically the rich Chinese flora for the benefit of mankind in China and elsewhere.

#### SELECTED BIBLIOGRAPHY OF GENERAL WORKS ON CHINESE PLANTS

The following list contains the major general works on Chinese plants, especially those which might be useful in identifying plants. Some other references are given concerning the vegetation or phytogeography of the country and the history of botany in China, and a few works are listed by which Chinese names of plants may be identified with their Latin or English equivalents. For other notes on the literature of Chinese botany see pp. 333-334.

BRETSCHNEIDER, E. V.

1898. History of European botanical discoveries in China. 2 vols. London.

A facsimile reproduction was issued in Leipzig in 1935.

CH'EN, YUNG.

1937. *Chung hua shu fen lei hsueh*. 1,544 pp., illustr. Nanking.

An illustrated manual of Chinese trees and shrubs. In Chinese with Latin names.

CHOW, HANG-FAN.

1934. The familiar trees of Hopei. English ed., 370 pp., illustr.; Chinese ed., 269 pp., illustr.

CHUN, WOON-YOUNG.

1922. Chinese economic trees. 309 pp., illustr. Shanghai.

CHUNG, H. H.

1924. A catalogue of the trees and shrubs of China. Mem. Sci. Soc. China, vol. 1, No. 1, pp. 1-271.

This is a check list of Latin names only.

DIELS, LUDWIG.

1900-1901. Die Flora von Central China. Bot. Jahrb., vol. 29, Hefte 2-5, pp. 169-659. Leipzig.

A systematic treatment in German without keys or descriptions, except of new species.

DUNN, STEPHEN T., and TUTCHER, WILLIAM J.

1912. Flora of Kwangtung and Hongkong. Kew Bull. Misc. Inf., Add. Ser., No. 10, 370 pp.

A systematic work with keys but without descriptions.

FORBES, FRANCIS BLACKWELL, and HEMSLEY, W. BOTTING.

1886-1905. An enumeration of all the plants known from China proper, Formosa, Hainan, Corea, the Luchu Archipelago, and the Island of Hongkong . . . Journ. Linnean Soc. London, Botany, vols. 23, 26, and 36.

The most complete enumeration ever published. See p. 330 for further data.

**HANDEL-MAZZETTI, HEINRICH.**

1931. Die pflanzengeographische Gliederung und Stellung Chinas. Bot. Jahrb., vol. 64, Heft 4, pp. 309-323. Leipzig.

Abstracted in English in Abstracts of Communications, Fifth International Botanical Congress, Cambridge (England), pp. 315-319, 1930.

**HU, HSIEN-HSU.**

1936. The characteristics and affinities of Chinese flora. Bull. Chinese Bot. Soc., vol. 2, pp. 67-84. Peiping.

**KUNG, CHING-LAI, et al.**

1918. Chih wu hsueh ta t'zu tien, or Botanical nomenclature. 1,726 pp., illustr. Shanghai.

This illustrated botanical dictionary containing Latin, Chinese, Japanese, German, and English names is largely translated from Japanese. Probably it is mostly correct.

**LEE, SHUN-CH'ING.**

1935. Forest botany of China. 991 pp., illustr.

A systematic treatment with descriptions of all species, but often botanically inaccurate.

**LIU, JU-CH'ANG.**

1931. Systematic botany of the flowering families in North China. 212 pp., illustr. Peiping. 2d ed., 1934.

This is not a general manual.

**MATSUMURA, JINZŌ.**

1915. Shokubutsu mei-i. (Revised and enlarged.) Pt. 1, Chinese names of plants. 405 pp.

By means of this work the Latin equivalents of Chinese names of plants may be found, especially those mentioned in the Chinese classics.

**MERRILL, ELMER D., and WALKER, EGBERT H.**

1938. A bibliography of eastern Asiatic botany. 719 pp., 2 maps. Arnold Arboretum, Jamaica Plain, Mass.

A source for finding much literature on numerous subjects.

**SHAW, NORMAN.**

1914. Chinese forest trees and timber supply. 351 pp., illustr. London.

A description of forests and trees from the commercial foresters' point of view.

**WILSON, ERNEST H.**

1914. A naturalist in western China. 2 vols. New York.

A very readable account of the author's explorations.





1. BARREN, ERODING, PARTIALLY TERRACED MOUNTAINS IN NORTH CHINA.

Orchards grow on the terraces, but only *Vitex incisa* shrubs, small wild jujube trees, and grasses clothe the mountain slopes. Note the stone walls supporting the terraces. (Photograph by P. H. Dorsett, courtesy U. S. Department of Agriculture.)



2. A TYPICAL FARM SCENE IN MIDDLE CHINA.

The trees mark the farm houses or temples, all the remaining land being used for growing rice. (Photograph by P. H. Dorsett, courtesy U. S. Department of Agriculture.)



UPPER FOCHOW ON THE MIN RIVER, FUKIEN PROVINCE.

The trees are root pines (*Pinus massoniana*); the tuft in the foreground is an American asave, quite at home on such denuded hills. The log rafts at left and right indicate forests far beyond the distant hills. (Photograph by W. Robert Moore, © National Geographic Society.)



DENSELY CLOTHED LIMESTONE KNOBS IN KWANGSI PROVINCE.

The rich vegetation contrasts with the cultivated fields below. Chinese landscape artists love to depict such towering peaks, which, however, are limited to this province.  
(C) National Geographic Society.)

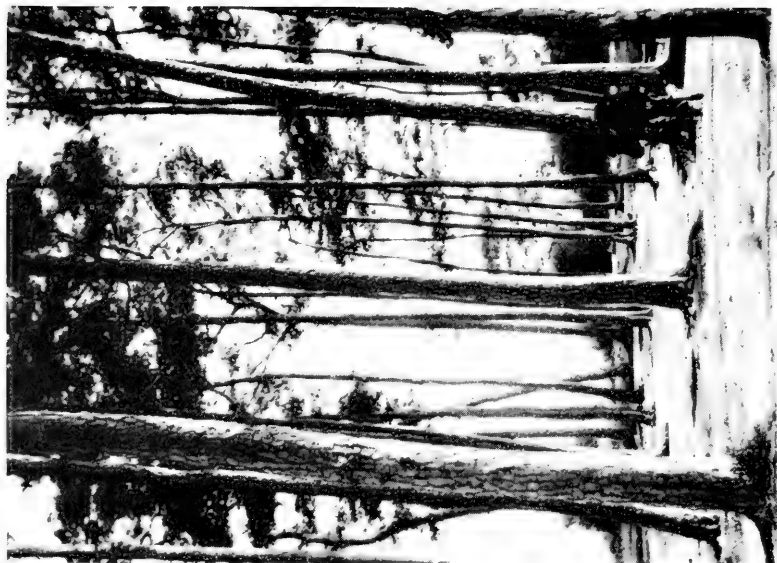

1. A GROVE OF RED PINES (*PINUS MASSONIANA*) NEAR A SOUTH CHINA VILLAGE.

The people claim such groves restrain the evil spirits of the land. Note the soil raked bare of all burnable pine needles, leaving no humus to help the sprouting seeds. (Photograph by the author.)

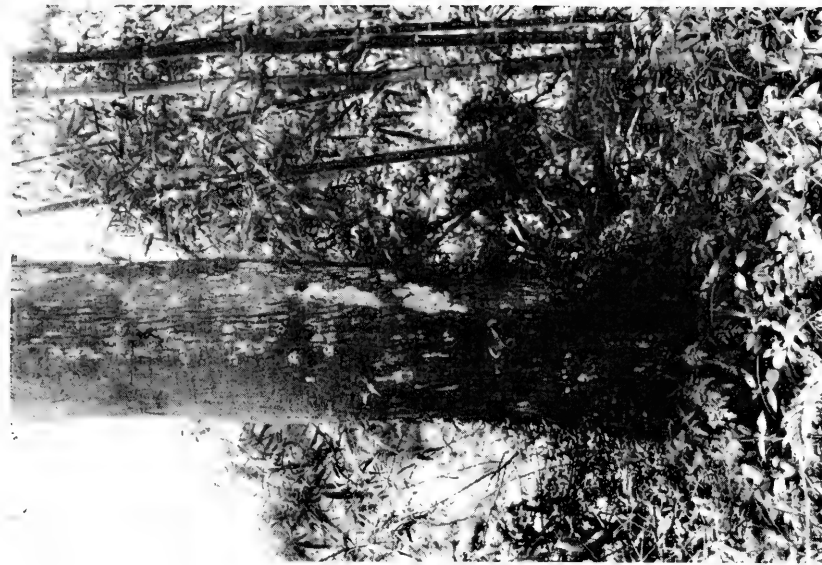

2. A CHINESE HICKORY TREE (*CARYA CATHAYENSIS*) IN A CHEKIANG BAMBOO JUNGLE (*PHYLLOSTACHYS* SP.) This trunk is 2 feet through. Hickories grow only in eastern Asia and eastern North America. (Photograph by F. N. Meyer, courtesy U. S. Department of Agriculture.)



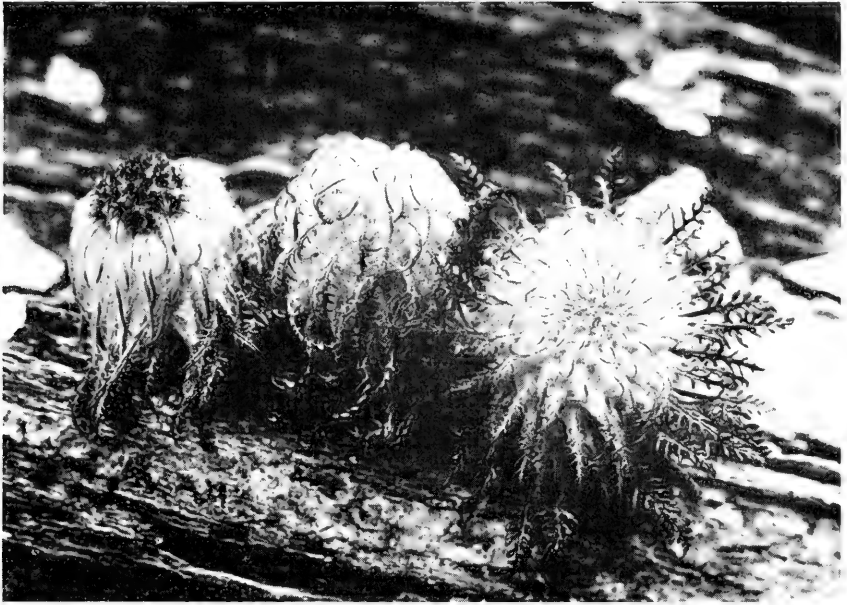

1. HIGH ALPINE PLANTS IN THE LIKIANG SNOW RANGE, WESTERN SZECHWAN.

These medusa-headed composites (*Saussurea leucoma*) were found at 16,500 feet altitude, about the upper limit of plant growth. Such alpine treasures are among the goals of plant explorers. (Photograph by J. F. Rock, © National Geographic Society.)

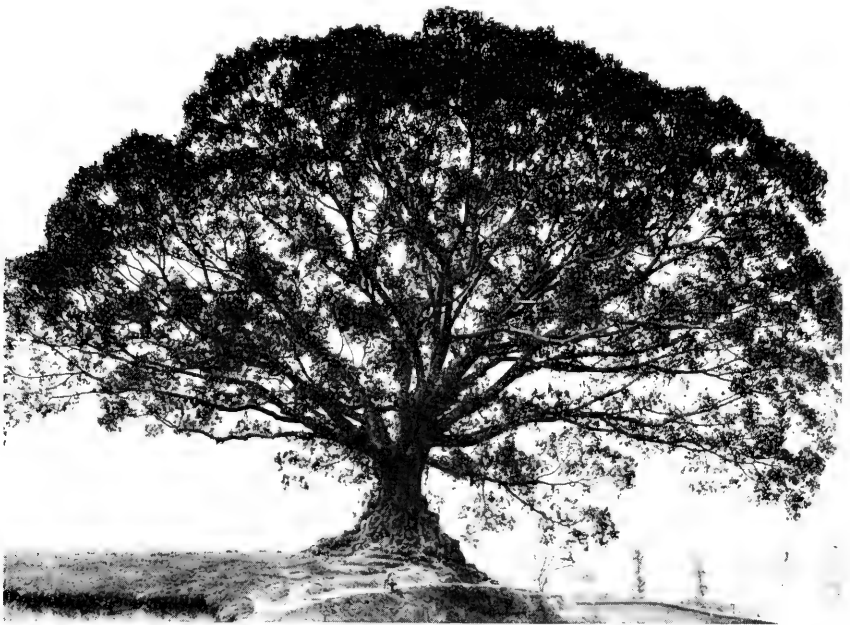

2. A BANYAN TREE (*FICUS LACOR*) IN SZECHWAN PROVINCE.

These venerable trees spread wide their huge branches from short, gnarled trunks. Among the twisted roots one may find a simple shrine with glowing incense sticks. (Photograph by E. H. Wilson, courtesy Arnold Arboretum.)

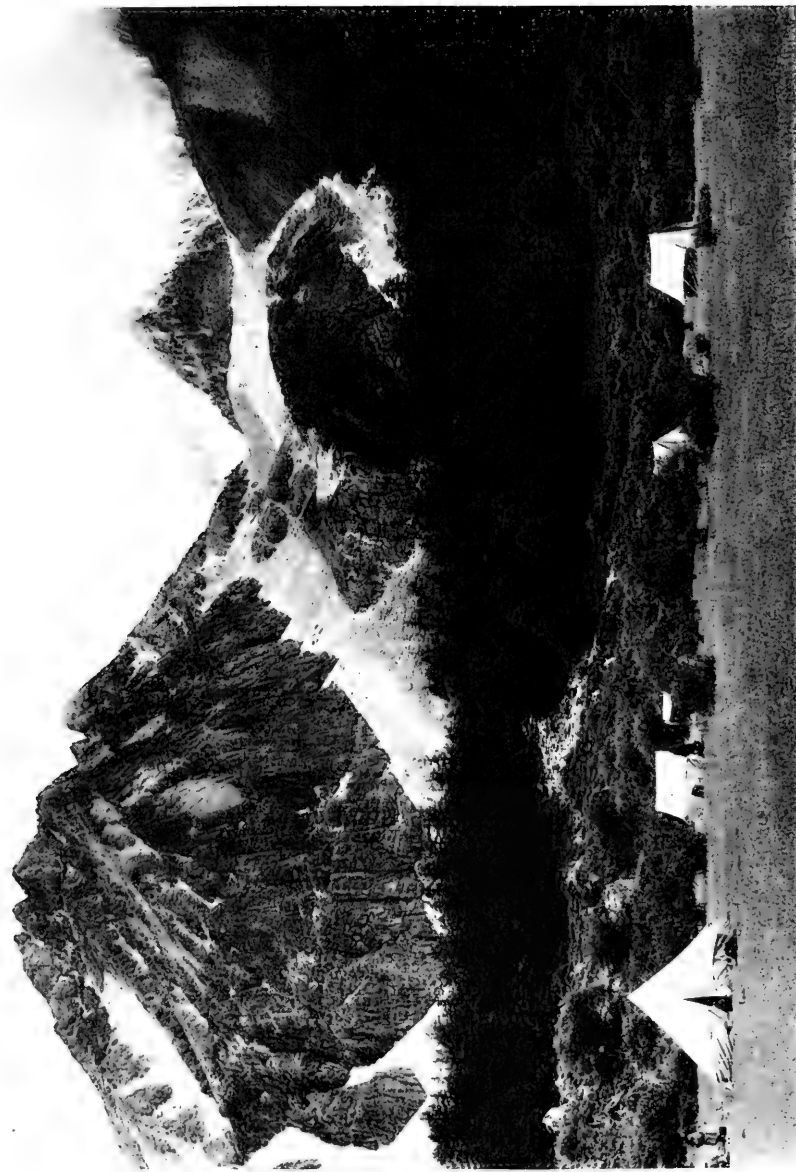

ENCAMPED AMONG FIRS AND LARCHES BELOW SNOW-CAPPED PEAKS.

J. F. Rock's expedition at Mount Chamdorjio in western China. The summits are hidden in the clouds. Rare rock-garden plants come from heights like these. (Photograph by J. F. Rock, © National Geographic Society.)



1. ANCIENT MUD WATCHTOWERS IN THE ARID MEKONG VALLEY IN YUNNAN.

Corn has been harvested in the foreground and compost piled for the next crop. Scattered trees, probably pines, cover the distant heights. (Photograph by J. F. Rock, © National Geographic Society.)



2. GRASSLANDS OF NORTHEASTERN TIBET.

An explorer's party resting for lunch. Note the almost complete lack of woody plants. When the spring frosts disappear the alpine flowers clothe the hills in a riot of color. (Photograph by F. R. Wulsin, © National Geographic Society.)



1. A CHINESE VARNISH OR LACQUER TREE  
(*RHUS VERNICIFERA*) IN SZECHWAN.

The cross pieces tied to the tree enable workers to tap the trunk for the exuding poisonous sap without touching it. (Photograph by E. H. Wilson, courtesy Arnold Arboretum.)



2. A SMALL WOOD- OR TUNG-OIL TREE IN FULL BLOOM.

A typical farmer with sandaled feet enjoys its fragrance. Beyond him and to the right is a patch of poppies with capsules, perhaps yielding opium, or only poppy seeds. (Photograph by E. H. Wilson, courtesy Arnold Arboretum.)

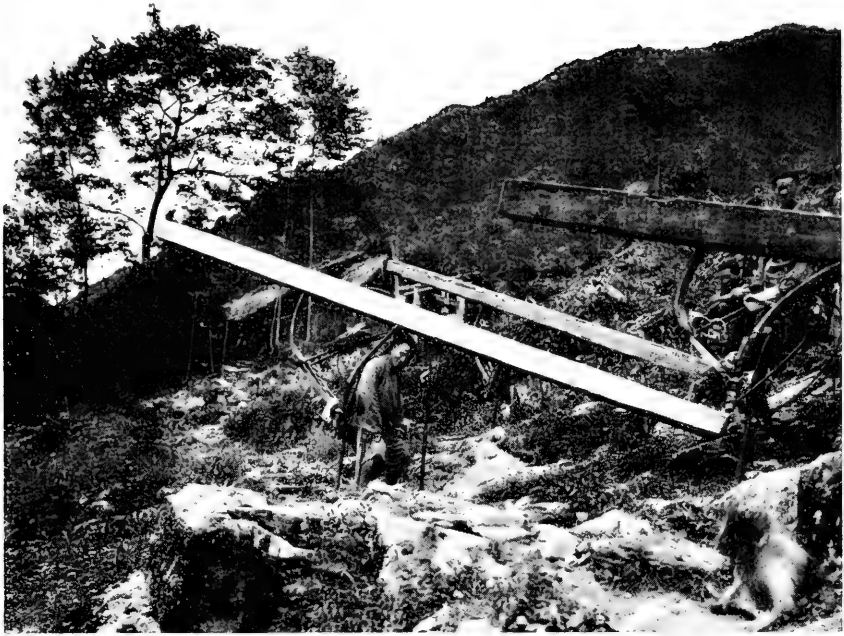

1. HAND-HEWN HEMLOCK TIMBERS EN ROUTE TO MARKET.

These measure 7 by 9 inches and are  $18\frac{1}{2}$  feet long and weigh nearly 400 pounds. When such means of transport are replaced by trucks and trains, the remaining forests may be doomed. (Photograph by E. H. Wilson, courtesy Arnold Arboretum.)



2. AN OLD ORCHARD OF JUJUBES OR CHINESE DATES NEAR PEIPING.

Winter wheat is planted in rows in this orchard. It makes a good growth before the leaves of the trees in spring cast too much shade. Jujube orchards are now established in California. (Photograph by P. H. Dorsett, courtesy U. S. Department of Agriculture.)

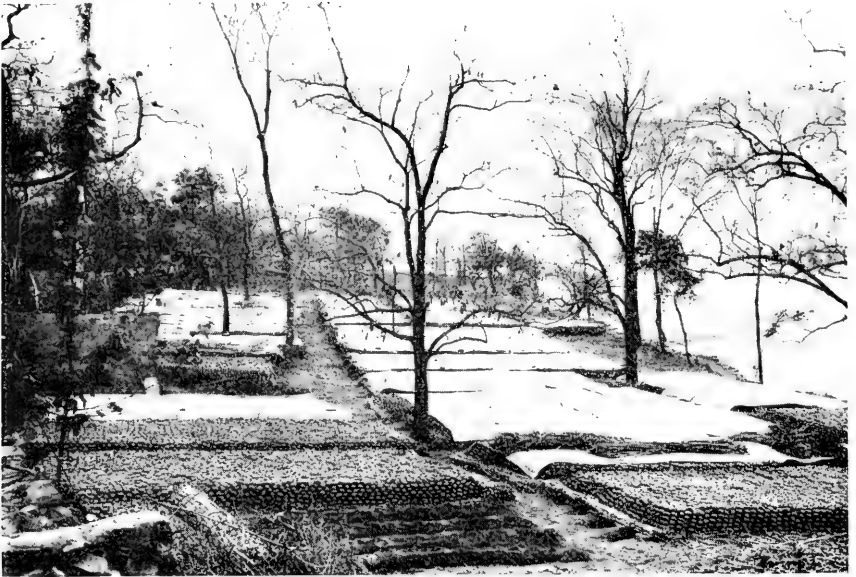

1. MILLIONS OF PERSIMMONS FROZEN SOLID IN NATURAL COLD-STORAGE BEDS NEAR PEIPING.

Note the bundles of kaoliang stalks placed across mounds of earth, thus enabling the cold air to penetrate under the fruit. Thin mats are spread over the top. (Photograph by P. H. Dorsett, courtesy U. S. Department of Agriculture.)



2. BLIGHT-RESISTANT CHINESE CHESTNUT TREES (*CASTANEA MOLLISSIMA*) IN A CHIHLI PROVINCE ORCHARD.

Note the healing scars of branches killed by the blight and the crop planted beneath the trees. American chestnut trees would have died. (Photograph by F. N. Meyer, courtesy U. S. Department of Agriculture.)

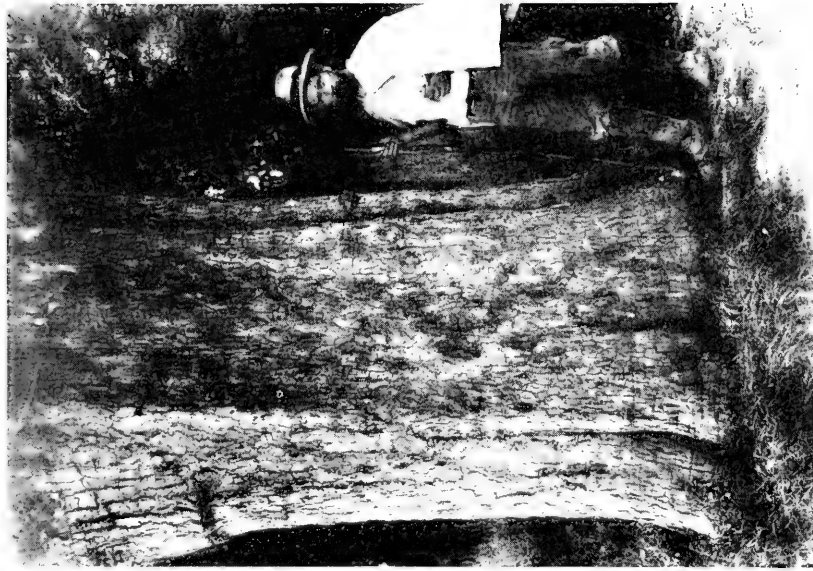

1. F. N. MEYER, PIONEER AGRICULTURAL PLANT EXPLORER, BY A CHINESE PISTACHE TREE (*PISTACIA CHINENSIS*) IN SHANSI.

The trunk is about 5 feet through. (Photograph courtesy U. S. Department of Agriculture.)

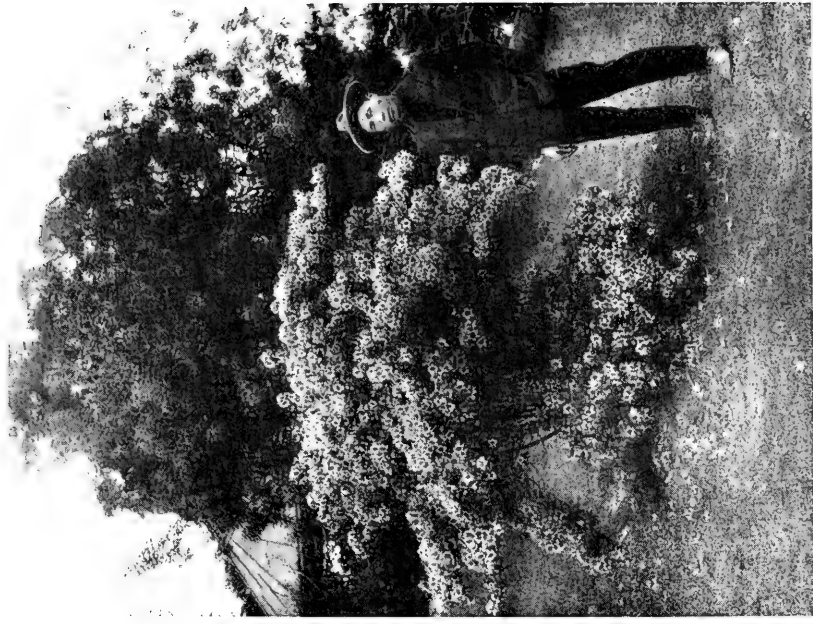

2. R. C. CHING, CHINESE PLANT EXPLORER, BESIDE AN AZALEA BUSH (*AZALEA INDICA*) IN HONG KONG IN 1928.

This is in the Hong Kong Botanical Garden. He is now director of the Lu Shan Arboretum in Yunnan. (Photograph by R. Kent Beattie.)



Smithsonian Report, 1943.—Walker

1. PETER LIU, DORSETT'S ABLE INTERPRETER, BRINGS PRODUCTS FROM MARKET.

The best of these fruits and vegetables will be traced to the orchards and gardens whence they came, and seeds and cuttings gathered for mailing to America. (Photograph by P. H. Dorsett, courtesy U. S. Department of Agriculture.)

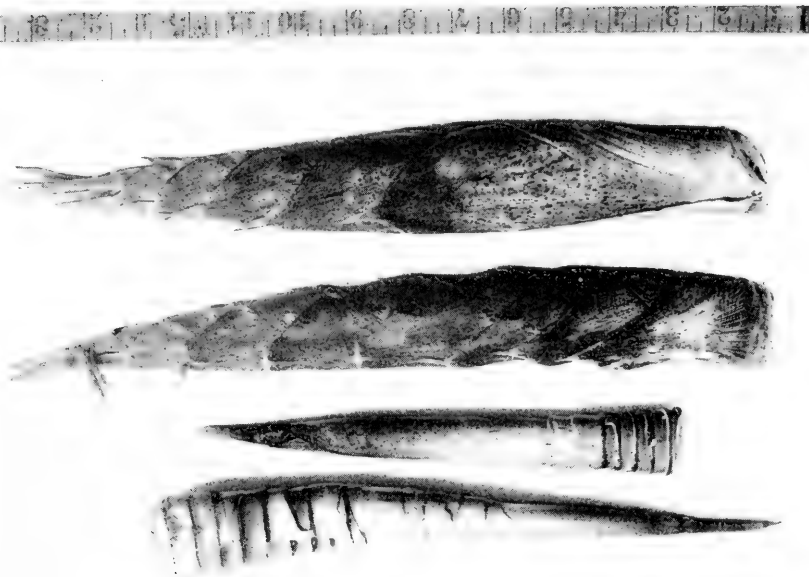

2. EDIBLE BAMBOO SHOOTS (PHYLLOSTACHYS EDULIS) FROM CENTRAL CHINA.

The two on the right are just harvested; the others partly prepared for cooking. Young stems grown from such shoots provide paper pulp. (Photograph by P. H. Dorsett, courtesy U. S. Department of Agriculture.)



# NATURAL RUBBER<sup>1</sup>

By O. F. COOK

[With 20 plates]

## CONTENTS

	Page
Why the two principal rubber trees are confused.....	365
Coming of the rubber age.....	367
A new realm of human attainment.....	368
Service of rubber to science.....	369
Rubber discoveries accidental.....	370
The first European to appreciate rubber.....	371
La Condamine in Brazil and Guiana.....	372
A basic discovery in extracting Para rubber latex.....	373
Scope of Ridley's discovery.....	374
Explaining the wound response.....	375
Commercial surveys of wild rubber.....	375
Genera related to Castilla.....	377
Genera related to Para rubber.....	377
Evaluation of rubber trees.....	377
Reasons for preferring tree crops.....	378
Rubber as a garden crop.....	379
Problems of rubber latex.....	380
Rubber by rule of thumb.....	380
Rubber and near-rubber.....	382
Rubber without latex.....	382
Rubber-forming cells in Castilla latex.....	384
Castilla handicapped by an enzyme.....	384
Latex separate from sap.....	386
Specialized branches and leaves in Castilla.....	387
Two forms of branches in Castilla.....	388
Specialized leaves of dimorphic branches.....	389
Two preliminary leaf forms in Castilla.....	390
Propagation of Castilla from permanent branches.....	391
Forest adaptations of the Para rubber tree.....	391
Branching habits of Para rubber tree.....	393
Intermittent growth of trunk.....	393
Leaves arranged in rosettes.....	394
Many leafless metamers.....	394
Spongy, perishable seeds.....	395
Leaves of seedlings delicate.....	395

<sup>1</sup> Much of this material is recast from previous papers and reports by the same writer in publications of the U. S. Department of Agriculture. A bibliography is appended. Titles of some of the papers are mentioned in the text, with other references by date only.

	Page
A growth disorder in seedlings of Para rubber.....	396
Diversity in abnormal plants.....	397
Recovery of normal leaf forms.....	397
A mature tree with narrow leaves.....	398
The Para rubber tree as a hybrid stock.....	398
Rubber in a desert shrub.....	398
Developing a guayule industry.....	400
Effect of Ridley's discovery on guayule and Castilla.....	400
Possibility of applying guayule extraction methods to Castilla.....	401
Rubber in desert milkweeds.....	402
<i>Cryptostegia</i> as a soil cover.....	403
The African rubber tree in shelter belts.....	404
A hardy gutta-percha tree.....	404
<i>Eucommia</i> , a tree that never blossoms.....	405
<i>Eucommia</i> suppresses all terminal buds.....	406
The balata tree.....	407
The sapodilla, or chewing-gum tree.....	408
Our household "rubber plant".....	409
Two rubbers in one tree.....	409

Taking account of natural sources of rubber is a scientific task of enormous proportions, which as yet has received only casual and intermittent attention. Only a few species have been studied and evaluated, while thousands are known to contain rubber, and other thousands doubtless remain to be discovered. Rubber and rubberlike substances are not restricted to plants that have latex, the milky juice that is carried in minute tubes apart from the other tissues. Latex may have functions in the plant economy other than the storage or transfer of the rubber-forming material, but nothing has been found to indicate that the rubber material itself is more than a waste product, like the resins, tannins, or lignins that are formed in the various groups of higher plants. Thus no biological limit can be set to the need of a general survey of the plant kingdom.

A beginning of the search for rubber resources may be reckoned from a century ago, when the Para rubber tree in the forest of the Amazon valley began to be exploited on a large scale, after the Castilla or Central American rubber tree, the original source of commercial rubber, was largely exhausted. To the middle of the last century most of the rubber had been obtained from the Castilla tree, and Brazil has continued to furnish Castilla rubber from the more remote or less accessible districts. The Castilla rubber is handled in Brazil under the name *caucho*, while the Para rubber is known as *borracha*. The commercial preponderance of the Para rubber in recent decades has left the Castilla rubber in such obscurity—or even oblivion—that popular writers were led to suppose that the history of rubber began in the Amazon valley. In reality the Castilla rubber had been known in Mexico and elsewhere in tropical America for more than three centuries before the Para rubber became prominent.

The Para rubber tree was not widely utilized in the early days because much more labor was required to get the rubber from it than to gather the rubber of Castilla. A Castilla tree was exploited in Brazil in a single complete operation—felling the tree and ringing the trunk in many places, thus obtaining several pounds of rubber, often 10 to 20 pounds—while a Para rubber tree had to be punctured repeatedly through weeks and months, and the latex collected in daily dribbles. But with the greater demand for rubber and the rapid advance in prices after the middle of the last century, following Goodyear's improvements of manufacturing processes, the gathering of Para rubber was greatly stimulated. The discovery of vulcanization is dated from 1839, and Goodyear obtained his patent in 1844.

When Richard Spruce, a first-rank botanical explorer, landed at Para in 1849, he found that the tapping of the Para rubber tree was "limited to the immediate environs" of the city, but in a few years of rising prices thousands of people turned to gathering the Para rubber.

The extraordinary price reached by rubber in Pará in 1853 at length woke up the people from their lethargy, and when once set in motion, so wide was the impulse extended that throughout the Amazon and its principal tributaries the mass of the population put itself in motion to search out and fabricate rubber. In the small province of Pará alone (which includes a very small portion of the Amazon) it was computed that 25,000 persons were employed in that branch of industry. Mechanics threw aside their tools, sugar-makers deserted their mills, and Indians their roças, so that sugar, rum, and even farinha were not produced in sufficient quantity for the consumption of the province.

Spruce was told of an earlier period when the rubber trees had been felled for tapping, and he inferred from this that the method of harvesting had been changed in the interest of obtaining more rubber "by successive tappings of the same tree." Since felling and ringing the trees was the usual procedure with Castilla in South America, a transition from Castilla to Para rubber is indicated. Some of the up-river tribes that Spruce visited did not know that rubber was being gathered from the Para rubber tree.

#### WHY THE TWO PRINCIPAL RUBBER TREES ARE CONFUSED

The generic name *Siphonia*, dating from 1791, was used by Spruce for the Para rubber tree, and for several related species that he discovered in Brazil, such as *Siphonia lutea*, *S. pauciflora*, and *S. discolor*. The use of *Hevea* instead of *Siphonia* by Mueller von Aargau in 1865 was a mistake, and has led to much confusion in the histories, habits, and uses of the two principal rubber trees. The native name, *heve*, the original of *Hevea*, did not belong to the Para rubber tree or even to the Amazon valley, but to the Castilla tree and to the district of Esmeraldas on the Pacific coast of Ecuador, visited by La Condamine in 1736. The Para rubber tree and the related species of *Sipho-*

*nia* do not extend beyond the Andes, but only to the eastern foothills of the mountain barrier. The natural distribution of Castilla includes most of tropical America from Brazil and Peru to Mexico, but not the West Indies.

Writers who traced the origin of the name *Hevea* to the district of Esmeraldas naturally inferred that the Para rubber tree was first discovered on the Pacific coast of Ecuador, though some have assumed that Esmeraldas was a locality in Brazil. As late as 1876 James Collins, the most competent author on rubber of that period, contributing to a book on "British Manufacturing Industries," represents La Condamine as finding Para rubber trees, "siphonias or seringas in great abundance," along the Pacific coast, "adjacent to the sea."

The usual supposition that rubber history began in Brazil arises largely from the fact that rubber was coming from Brazil in the days of Goodyear, but the preceding centuries of rubber history should not be disregarded—three centuries in Mexico and at least one century in Brazil. The first rubber industry in Brazil was the gathering of Castilla rubber on the eastern slopes of the Andes, as witnessed by La Condamine when he descended the Amazon in 1743. This industry entered Brazil from the Spanish settlements on the Pacific coast, and spread eastward through the Amazon valley, until it was replaced or at least overshadowed at the middle of the next century by the exploitation of the Para rubber tree, beginning around Para and spreading westward, as witnessed by Spruce. The word *caucho* came from the west with the Castilla industry, the word *borracha* from the east, with the Para rubber.

The primary error was made by Aublet in 1775 in associating the vernacular name *heve* from Esmeraldas with a native rubber tree of French Guiana. But Aublet's *Hevea* had been discarded as a homonym in Lamarck's encyclopedia, and replaced by *Siphonia*. To overlook this fact was a technical error, violating one of the basic rules of nomenclature, that names abandoned as homonyms are not to be resumed. The name *Hevea* doubtless will continue in popular use for many years and will only gradually be replaced by *Siphonia*. An alternative is to treat *Hevea* as a popular name, like petunia, aster, or chrysanthemum. The name Para rubber tree is familiar and not equivocal.

It seems remarkable that Spruce should have botanized in so many places along the Amazon without encountering a single Castilla tree, from which it may be inferred that a nearly complete extermination had taken place. Many other botanists, before and after Spruce, obtained no specimens. The Castilla of the lower Amazon had no botanical status until it was described by Warburg in 1905 as a new species, *Castilla ulei*, named for Ule, the collector. This tree may be less strik-

ing than the other species of *Castilla* in Mexico and Central America, since the leaves are smaller, but the trees grow large and yields of 30 to 50 pounds of rubber are reported.

The confusion of the names might be supposed to have little relation to the study of practical problems, since the two types of trees are entirely unlike in appearance, habits, and cultural requirements. *Castilla* is a striking, large-leaved tree like a magnolia, while the Para rubber has the appearance of an ordinary tree—an ash or a boxelder. Although nobody who knows the two trees would be expected to confuse them, yet much confusion regarding their characters and behavior has existed and still continues, even among those concerned with rubber experiments and projects. The commercial, industrial, mechanical, and chemical aspects of the rubber problems have been intensively elaborated, but not the plant-life aspects. Not many tree crops have been domesticated, and people rarely have experience of a kind to make them familiar with such differences as those of the rubber trees.

Outside of the Amazon valley, popular knowledge of rubber trees in tropical America has related almost entirely to *Castilla*, with the Para rubber tree coming forward only in recent years. The unconscious carry-over of ideas from the *Castilla* to the Para rubber has occasioned many destructive errors and interferences, even to the extent of Para rubber trees being cut down as complete failures because they did not yield latex freely like *Castilla*. This reason was given for cutting down several Para rubber trees in an experimental planting in Haiti. One of the stumps survived for many years, as shown in plate 11.

On account of confusion of the trees, a certain indifference appears when the planting of Para rubber is advocated by speakers or writers not familiar with the *Castilla* tree. Separate recognition of the two trees in the minds of interested people is the first step toward effective understanding and utilization of either of the trees in tropical America, or of both together. *Castilla* may serve under some conditions as a nurse crop for the Para rubber, but the extraction of the latex will need to be done in a different way.

#### COMING OF THE RUBBER AGE

Enormous resources of Para rubber were discovered in the forests covering the valleys of the Amazon and its principal tributaries, and yet in a few years all the accessible areas were being exploited, more wild rubber was being sought in other continents, and the question of planting rubber trees was being raised. In 1876 Wickham made his famous shipment of Para rubber seeds to the Kew Gardens near London, for planting in India, and 20 years later the first commercial planting of Para rubber was made in Malaya. The search for other

sources lapsed when the planting project came through at the beginning of this century, and now is largely forgotten. From Goodyear to plantation rubber was only 50 years, and 50 more to the present time.

The rapid advance of industrial civilization in the United States during this short period is viewed with complacency as the "Rubber Age," usually without reflecting that in most of the other countries the utilization of rubber is only at the stage of beginning. The eventual need of rubber must be, in many parts of the world, hundreds or thousands of times the merely "token" requirements as yet recognized. Not only the populous countries need rubber, but the waste places have even greater needs, the vast areas of denuded lands, scarcely populated now, but to be made accessible and habitable by means of rubber. Every nation will need rubber. Developing adequate supplies of rubber is a basic provision for the general advance in human welfare that now is contemplated.

Rubber has come to be a normal need of civilized people, hardly less than food, clothing, and shelter. The power of motion is an enlargement of our lives that we purchase at any price. The wider attainments and satisfactions of this rubber-brought freedom still are beyond the range of constructive imagination, but there is no thought of turning back to our previous immobile state. We have tried our new legs and wings, but have scarcely learned to use them. Even with us the Rubber Age lies mostly in the future. The futility of all the world depending on the production of a single rubber tree in a single region is amply demonstrated in the present emergency. The production of Para rubber is being decentralized as rapidly as possible, and many other trees, shrubs, and herbaceous rubber-bearing plants are being studied, with special attention to those that can live outside the Tropics. The hardy *Eucommia* tree from China, if it produced rubber instead of gutta-percha, undoubtedly would be hailed as one of the most valuable introductions. The rubber crops of different countries eventually may be as diversified as the sugar crops or the starch crops, after the cultural qualifications of the various rubber bearers have been determined. Only a beginning could be made in this scientific project with the intermittent interest and support that could be obtained while it appeared that ample supplies of rubber were assured from the plantations in Malaya.

#### A NEW REALM OF HUMAN ATTAINMENT

From a scientific viewpoint the course of human progress is entering a new realm in adopting and developing the uses of rubber. Profound changes are involved, comparable to those encountered by our primitive predecessors in adopting fire, contriving tools, weapons,

hunting gear, and fishing tackle, discovering fish poisons, building houses and boats, domesticating food plants and animals, developing textiles, ceramics, and graphic arts. All these activities and attainments, superposed and interacting with each other, were modified in many ways when metal tools replaced wood and stone, and again when iron and steel could be substituted for copper and bronze. Rubber is a material with new and different properties, not a food or a textile or a metal, but not inferior to any of these in its powers of modifying and transforming the activities and conditions of living in our civilization. Rubber had only a few uses among primitive peoples, but with us the uses are so many that no limit can be imagined, if our civilization is to continue.

Rubber is a new realm not only in the sense of being only recently entered, but also as causing many abrupt changes in the lives of millions of people. Little analogy is found with the gradual developments of other natural resources that have altered conditions of life in the course of centuries. Rubber already has brought many profound transformations to vast numbers of people, leaving very little of their former lives unaffected. In view of the extent and rapidity of this transformation it doubtless will be reckoned in the future as one of the major events of history, and yet the botanical basis and background of the change attained no public recognition during the first quarter-century of intensive utilization.

#### SERVICE OF RUBBER TO SCIENCE

Rubber is serving civilization in so many ways that efforts to enumerate them become tiresome, but services to science often are omitted from such reckonings. Not only are airplanes, automobiles, trucks, speedboats, and countless other machines dependent on rubber, but also a world of scientific apparatus, the veritable tools of investigation. What would chemical laboratories be without the equipment made possible by rubber tubes and gaskets, or electric research without insulation? That chemistry should have achieved at this juncture the knowledge and skill to make synthetic rubber will doubtless feature with future historians as a "decisive battle" in the scientific field, another escape of civilization from a major disaster. The development of synthetic rubber lends a new interest and significance to natural rubber.<sup>2</sup>

Another service to science is seen in the special studies of the rubber-bearing plants, many of which would otherwise have remained but little known, as most of the forms of plant life still are, especially in

---

<sup>2</sup> A discussion of synthetic rubber and of chemical research connected with rubber will be found in a paper entitled "The Rubber Industry, 1839-1939," by W. A. Gibbons, *Ann. Rep. Smithsonian Inst. for 1940*, p. 193, 1941.

tropical countries. Only a few of the species that are known to contain rubber have as yet been accessible to comparative study, but even these preliminary surveys have opened new chapters in botany. That many unknown and unexpected features should be found among the rubber-bearing plants need not be taken to mean that such plants as a class are peculiar, but only that our knowledge of and interest in the plant world still are strangely limited.

#### RUBBER DISCOVERIES ACCIDENTAL

Many writers have stressed the fact that Goodyear's discovery was made accidentally, and this is true, to an even greater extent, of other contributions not less significant than Goodyear's to the development of the rubber industry. Goodyear's contribution is in no way diminished by recognizing that the services of other men were likewise indispensable. Wickham's exploit of 1876 in sending rubber seeds from Brazil to England for planting in India is frequently recounted, but two other names should be as widely recognized: La Condamine, who was concerned with rubber a century before Goodyear, and Ridley, who came half a century after Goodyear.

Wickham's exportation of rubber seeds from Brazil and Ridley's discovery of a tapping method at Singapore were both voluntary contributions due solely to the interest and initiative of the two men involved. Neither had gone to the Tropics to study rubber, and the services that they rendered had not been planned or expected. Cross was being sent to Brazil at the time that Wickham was obtaining his shipment of 70,000 seeds by persuading the captain of a tramp steamer to take a chance of being rewarded. Previous seed shipments had failed, and that method of introduction was being abandoned. Cross, a few months later, took home a thousand young seedling plants, but only a few survived. Without Wickham's seeds the experiments of that period could not have reached a practical scale.

Ridley's solution of the tapping problem also came, so to speak, from the side lines. Specialists in plant physiology had been sent to Ceylon and a station established for experiments with rubber trees, but under a policy of tapping the trees by methods carried over from Brazil, such discouraging results were obtained that Ridley had difficulty in getting his facts considered. Without the spontaneous interest of these two men, the history of rubber culture must have been completely different.

Even with these contributions, the outlook for rubber planting remained doubtful until actual production was demonstrated. As late as 1900 unfavorable opinions of Para rubber were reported in Java, where experimental studies of this and other rubber plants were supposed to have received more attention than in the British



colonies. Further planting of Para rubber as a regular crop was no longer considered advisable on the basis of careful studies by agricultural specialists. For Java it appeared that *Ficus elastica* was more promising, and even on the general question of rubber plantations the Dutch investigators were said to have reached an adverse conclusion, on account of the small prospect of meeting the expense of competent and honest administration of the estates.

#### THE FIRST EUROPEAN TO APPRECIATE RUBBER

The statements of many books that rubber was "discovered" by La Condamine in 1736, are misleading, since rubber undoubtedly had been known and used by native peoples over most of tropical America through many generations. Many travelers and explorers had visited America before La Condamine, and several had reported the existence of rubber, but none had considered rubber as more than a curiosity, one of the many marvels of the New World, but with no impression of practical value. La Condamine was the first European to become constructively interested in rubber—the first to see that this tough, elastic substance might become valuable material in France and other civilized countries.

Alexander von Humboldt and many other European travelers visited tropical America before and after La Condamine without receiving, or at least without reporting, any such impression of the potential importance of rubber. Thousands of Europeans—soldiers, sailors, missionaries, travelers, and settlers in America—had seen and handled rubber, as shown by casual references in several early books on America. Many incidental uses were noted by Sahagun, who reached Mexico in 1528, and by Hernandez, who came in 1570. Sahagun also described many religious ceremonies among the Aztecs in which Castilla rubber, or *ulli*, was used with *copal* as a burnt offering, or made into sacred images of the gods. The resemblance of rubber to a living animal or to human tissues may be reflected in some of the native names. The Aztec name, *ule*, was adopted into Spanish in North America; in South America another native name, *caucho*, rendered in French as *caoutchouc*. Many languages of Central and South America have distinctive names for rubber or for the rubber tree.

La Condamine was not a botanist or even a naturalist, but is usually described as an astronomer or mathematician, and also as a geographer or engineer. His errand in South America was to determine more definitely the figure of the earth by making astronomical measurements of sections of the meridian of Quito, close to the Equator. The expedition was sponsored by the Academy of Sciences of Paris, under the auspices of the King of France, Louis XV. Since the astronomical

project was responsible for La Condamine's visiting South America and seeing rubber in its natural state, rubber may be reckoned historically as a byproduct of astronomy.

La Condamine went to South America by way of Panama and landed in "Peru" at the small port of Manta, actually on the coast of Ecuador north of Guayaquil. The Andes were ascended by way of Esmeraldas, another coast locality north of Manta. Heavy rains in the mountains made the trails impassable, and the few weeks of enforced delay in the coast district doubtless were responsible for his contacts with rubber. Thus a mere incident of travel appears to have had a much more important relation to human progress than anything else that La Condamine was able to contribute. No time would appear to have been lost by La Condamine in sending his first report on rubber to the Royal Academy of Sciences at Paris, in 1736. A further account was published in 1745, soon after La Condamine returned to France.

#### LA CONDAMINE IN BRAZIL AND GUIANA

The fact that La Condamine descended the Amazon and visited French Guiana before returning to Europe is responsible for the strange confusion of the principal rubber trees already noted. The chief purpose for which rubber was being collected at the time of La Condamine's visit was for making torches and candles, which are said to have burned very well. The evil smell of burning rubber comes largely from the sulfur that is added. At the time of La Condamine's visit, supplies of rubber were being obtained from the eastern slopes of the Andes in the Maynas district of the upper Amazon, as well as from the forests along the Pacific coast. No rubber gathering on the lower Amazon was mentioned by La Condamine, but at Para small objects modeled from rubber were seen, and some of these were carried to French Guiana, where a search for rubber trees was started. Fresneau, an engineer who spent 14 years in this colony, found several latex-bearing trees, as reported through La Condamine to the Paris Academy in 1751.

One of the Guiana trees was supposed from native information to be the kind that furnished rubber in Brazil, and this was described by Aublet in 1775 as *Hevea guianensis*. Several localities were noted, and the nuts were said to be gathered and eaten by the natives, the "almond" having a pleasant taste. La Condamine and Fresneau are not mentioned, but a reference is given to the "poor figure of the Guiana tree in the memoir of 1751." The name "*Hevea peruviana*" engraved on Aublet's plate 335 leaves no doubt that the Guiana tree was supposed to be the same that La Condamine had found on the coast of Esmeraldas, "northwest of Quito," where Castilla grows, and the native name *heve* was encountered.

Thus it came about that the name *heve*, used by the natives of Esmeraldas for the Castilla tree, was employed by Aublet as a generic designation for the Guiana rubber tree, and later was extended to the Para rubber tree. The writers who placed Esmeraldas in Brazil or in Venezuela, rather than in Ecuador, show the extent of confusion that a misleading name may generate. Ducke says in a footnote of his "Revision of the Genus *Hevea*," in 1935: "I do not know why Aublet attributed the origin of the name *heve* to Esmeraldas on the Pacific coast of Ecuador, where the genus *Hevea* is unknown." The reason is that the trees were assumed to be the same, since both produced rubber.

#### A BASIC DISCOVERY IN EXTRACTING PARA RUBBER LATEX

The rapid extension of the use of rubber during the present century was made possible by the discovery at Singapore about 1890 of a new method of tapping the Para rubber tree. The discovery was made by Henry N. Ridley, then in charge of the Singapore Botanic Gardens. A definite date is difficult to assign because the tapping experiments were made incidentally and not published by Ridley until 1897. Even then the report was fragmentary and not explicit, so that little account has been taken of what in reality was a basic discovery that made plantation rubber feasible on a large scale. The idea that latex could be drawn repeatedly and at short intervals from the same wound, by paring the margin, doubtless seemed too absurd to be credited by reasonable people and was therefore difficult to disseminate. No effective record might have been made if Ridley had not been visited at Singapore in 1896 by David Fairchild, as described in an article in the *Journal of Heredity* for May 1928, "Dr. Ridley of Singapore and the Beginnings of the Rubber Industry."

Fairchild appears to have appreciated more clearly than Ridley that a definite and indispensable step had been taken in Ridley's experiments. To Fairchild it seemed that Ridley had worked out "the most important single point of technique connected with the very vital problem of how to get the rubber out of the *Hevea* trees." Fairchild's evaluation of Ridley's work is as follows:

It is to Dr. Ridley that we owe the discovery that you can open a wound in the bark of the rubber tree, let it "bleed" and collect the latex as long as it will run, and when the wound dries cut it open again the next day and get not only another run of latex but a larger run than from the original incision. It is this discovery which led to the development of the modern methods of rubber tapping and, it may be fairly said, solved the planter's difficulties; turned the trick so to say, in a critical period of the rubber industry. Every well informed manufacturer in America will see that such a trick, such a discovery, had it been in the field of patentable inventions would have resulted in royalties sufficient to have enriched the discoverer and placed him in the class of the great inventors of the twentieth century. But it did not do this. Dr. Ridley today is a man of

small means whose chief pleasure is in studying the herbarium material which he had collected years ago in that part of the world which he chose as a young man for his special field of study—the Malayan Region; and in the preparation of a Flora of that remarkable area of the tropics.

The introduction of a new plant into a new region is an "event." The first exploitation and adaptation of that plant to the conditions of life which surround the new plant immigrant is another "event." And we must indeed be lacking in imagination if we fail to raise on a pinnacle the pioneers whose vision and ingenuity and scientific curiosity guided the developments of these vast and indispensable industries during their formative days.

#### SCOPE OF RIDLEY'S DISCOVERY

A more fateful discovery than Ridley's method of harvesting the rubber of the *Siphonia* tree would be difficult to adduce from the pages of history. Many "epoch-making inventions" are recounted, but none that so promptly affected so many millions of people. In all civilized countries living conditions and social relations were profoundly changed in a few years. Even among primitive tribes in remote and backward regions of the Tropics, rubber cultivation had almost immediate effects. Thousands of Malays, Hindus, and Chinese soon were engaged as contract laborers on the rubber plantations, while other thousands of even more primitive people were released from the gathering of wild rubber in forest regions of both hemispheres, and in effect were reprieved from extinction through Ridley's discovery.

A parallel may be seen in Eli Whitney's invention of the saw gin for short-staple cotton, which had social and political significance in the rapid expansion of Negro slavery in the southern States, eventuating in the Civil War, but these effects were relatively local, while the rubber reactions were world-wide. The ascendancy of the northern nations of Europe may be ascribed to the introduction of the potato, but centuries were required for the potato sequence to work out, while less than half a century has elapsed since the first commercial planting of the *Siphonia* tree in 1896.

Rubber production offered at once such definite advantages that only a few years were required for a new agricultural industry to be created in the East Indies, and new manufacturing industries in Europe and America, providing new systems of communication and transportation in all civilized countries. Rubber and gutta-percha as insulating materials made it possible for electricity to be utilized. Riding on rubber has become our "standard of living." A vast extension of the human environment has taken place.

Hundreds of chemical and physical discoveries have contributed to "modern scientific progress," but rubber in thousands of tons was necessary for the endless new applications to be developed. Ridley's biological observation was the critical point in quantity production,

making it possible for our industrial and cultural transformations to go forward with such amazing speed. It might be said that Ridley turned on the rubber, and caused an industrial deluge.

#### EXPLAINING THE WOUND RESPONSE

Studies of the tapping problems of the Para rubber tree in the early period were confused by a special theory of wound response, devised to explain the gradually increasing flows of latex after the first tapping, which usually yields very little. The theory assumed a greater intensity of physiological action to account for more latex being formed in the bark adjacent to a tapping wound, but such a reaction is not indicated. The underlying causes, determined by later investigators, are the branching latex tubes, which form a continuous network throughout the bark, and the fact that the latex becomes more liquid with a lower content of rubber. Subsequent tappings produce a freer flow because the tubes adjacent to the wound are gradually freed of the thicker, more creamy latex shown in its original state at the first tapping; other changes, of a nature to form more latex in the tissues around the wound, are not indicated.

Instead of an effect of the tapping upon the adjacent tissues, the lack of such an effect is the remarkable fact that needs to be appreciated in order to understand that in the Para rubber tree renewal of the same wound may be repeated frequently and continued indefinitely. Because the latex tubes are united into a network, the supply of latex is always sufficient to replenish the tubes near the wound, and thus to restore the bark pressure. The entire system of the tree contributes to the drainage from the tapping wound. The prompt replacement of the latex and renewal of the bark may be viewed as a remarkable provision of the tree against the wound reactions that otherwise might occur if the tissues remained depleted or became infected by fungi or bacteria, which rarely happens.<sup>3</sup>

#### COMMERCIAL SURVEYS OF WILD RUBBER

From the commercial standpoint it appeared that the search for resources of wild rubber had been carried to a practical conclusion in the later decades of the last century. With supplies of wild rubber from Brazil becoming inadequate, large expenditures were made by commercial agencies in exploring the tropical forest regions of both hemispheres. In Africa, Madagascar, and Malaya, many new rubber-bearing trees, vines, and "root-rubbers" were found and rapidly exhausted, though several were exploited extensively during

<sup>3</sup> A lack of wound response in an experiment with repeated tapping was recognized by Karling in a latex-bearing tree (*Couma guatemalensis*), studied in eastern Guatemala as a possible substitute for chicle. See Amer. Journ. Bot., vol. 22, p. 580, 1933.

periods of years. Such efforts continued until the plantations of Para rubber trees in the Malay Peninsula began to supply the market, and the need of searching further for wild rubber seemed to have passed.

In reality the commercial surveys had taken only a partial view of the general problem of natural rubber. The rubber-producing plants were not studied or evaluated from the standpoint of agricultural production possibilities, but only with reference to their existence in large numbers over wide areas, in sufficient abundance to be exploited in commercial quantities. No commercial interest would be taken in trees or plants limited to small areas or occurring as rare, widely scattered individuals.

With a plant that is brought into cultivation, it obviously makes little difference whether the wild stock is scattered widely in nature or limited to a single district, or even to a single locality. Many species are localized, especially in tropical regions, to an extent that is seldom appreciated. The apparent uniformity of tropical forests allows us to suppose that the same species are widely distributed, but even where forests are continuous the species may prove to vary. Richard Spruce, after several years of intensive exploration in the Amazon valley, estimated that with every degree of latitude half of the species were changed.

Alfred Russell Wallace, who visited Brazil during the same period that Spruce did, also failed to distinguish between the two types of trees that were being exploited in the Amazon valley. Even in 1908, in publishing Spruce's Journals, Wallace writes of cutting the trees down as a method of utilization that had been applied to the Para rubber in the early days. Wallace held that the latex served for the growth of the trees and that tapping should be suspended during the flowering and fruiting season.

Several species of *Siphonia*, or *Hevea*, have been described from the Amazon valley, but only one species of *Castilla*. The number of perceptibly different local forms of *Castilla* doubtless would run into scores or hundreds, if a thorough study could be made. Ten species were distinguished in a monograph by Pittier published in 1910, and others may be described, but the number that can be separated and classified by definite differences may not be much larger. The species of *Castilla* are less localized than in many tropical genera, the fleshy fruits being eaten by birds and monkeys, and the seed scattered. Variations of structure or habits within the species, such as thicker bark or greater tolerance of drought or other unfavorable conditions, may have cultural importance far beyond the characters formulated in describing species in the usual manner, that is, from differences in leaves, flowers, or fruits.

## GENERA RELATED TO CASTILLA

Several genera related to *Castilla* are worthy of being canvassed as rubber trees, in view of reports by botanical collectors that the latex was abundant and formed an elastic substance. Thus *Olmedia aspera* and *O. laevis* were noted by Ruiz in 1784 at Pozuzo on the eastern slope of Peru as "trees that on incision give an abundance of very white milk, which, exposed to the air, turns into a very elastic resin of a reddish-chestnut color; it can be shaped into any form desired." The presence of rubber may explain a statement by Sandeman in "A Forgotten River," that a waterproof bark cloth is obtained from this *Olmedia*, which the Indians call *llanchama*. A species of *Perebea* in Panama was described by James Collins as *Castilla markamiana*, and shares the native name *ule* with *Castilla panamensis*. Some of the Brazilian trees referred to *Helicostylis* have a notable similarity to *Castilla ulei*.

## GENERA RELATED TO PARA RUBBER

Another rubber-bearing genus in South America, closely related to the Para rubber tree, was described by Bentham under the name *Micrandra*. It seems to be widely distributed in South America, but apparently has not been found in sufficient abundance for commercial exploitation. Spruce used the name *Muranda* for this genus, of which he saw two species on a tributary of the Rio Negro, differing notably from the Para rubber tree in their simple leaves and clustered trunks, "often as many as ten from a root." They were said to yield "pure rubber."

Several South American rubber trees belong to the genus *Sapium*, also a member of the spurge family. Some of the sapiums grow at rather high altitudes in the Andes, 6,000 to 8,000 feet, and produce what has long been known as "virgin rubber," some of it reputed to be of excellent quality. Other species grow in the Amazon valley and are reported to share the habits of the Para rubber tree and to yield latex in the same manner, by the native method of making many wounds with small hatchets. This may mean that the latex tubes of *Sapium* form a continuous network as in the Para rubber. A plantation of 70,000 *Sapium* trees was reported from Colombia in 1888 as "growing with great rapidity, and averaging about five feet a year," according to a letter published in the Kew Bulletin of 1906.

## EVALUATION OF RUBBER TREES

The rubber planter encounters the problems of choosing favorable natural conditions, devising suitable cultural methods, and selecting

the plants best adapted to the conditions under which he must operate. That American planters in the early days gave their attention so exclusively to Castilla, and planters in the East Indies to the Para rubber, was not the result of any demonstration of the cultural superiority of one tree or the other, but of becoming interested in the possibilities of the tree they had at hand. The desirability of many other species that have been reported as promising remains to be determined.

It is not to be expected that any one species will be found to have a sufficiently superior value under all conditions to warrant its being planted to the exclusion of all others. Rubber, like starch, is produced in nature in many different environments ranging from deserts to swamps. The number of cultivated rubber plants will probably never equal that of the starchy cereals and root crops; but there is the same practical reason why the cultural requirements, hardiness, vigor, and productiveness of the different rubber plants should be considered—not merely those of the distinct genera and species, but also those of the varieties of races into which each species will be found divisible by cultural selection. The cultural characters or adaptive differences of behavior under varied conditions are as important as differences in percentage of rubber, or even in quality of rubber, in determining whether production is practically feasible in competition with other crops. The adaptive ability of a tree or plant to grow readily on an extensive scale and produce abundantly under conditions that can be provided, is a basic requirement.

#### REASONS FOR PREFERRING TREE CROPS

Among the factors to be recognized in rubber production are the general advantages of tree crops over field crops, especially in tropical countries, in requiring less labor and affording greater protection of the soil against erosion. Rubber plants that can be grown as annuals or biennials in northern countries may be valued as insurance against emergencies without being expected to compete in normal production with rubber produced from tropical tree crops. The costs of clearing the land and weeding the crops are among the principal items of expense in tropical undertakings, although it is now recognized that these cultural activities often lead to rapid decline of soil fertility through surface erosion. The only permanent agricultures are those that do not involve the working of the soil. Denudation of the land through continued cultivation is now being recognized as a limiting factor of agriculture in many tropical regions.

Vast areas in the Tropics have the status of waste lands, more or less denuded by previous cultivation and burning, and lacking the surface layer of fertile soil, which may be formed again if forest con-



ditions are restored through the use of tree crops. Many areas of miscellaneous second-growth forests in tropical America, representing various stages of reforestation, are formed mostly of worthless trees, which might be replaced by rubber forests to great advantage. Guatemala, for example, would be considered as a rather populous country, compared with many other regions, yet is estimated recently to have only 10 percent of the land in cultivation. Complete clearing and cultivation would not be necessary for replacing the present mixed growth of waste areas with rubber trees, such as *Castilla* or *Funtumia*, which are somewhat tolerant of thin soils and drought conditions. Such trees may furnish wood, fiber, or other useful materials as byproducts, and also may shelter the early stages of Para rubber trees.

#### RUBBER AS A GARDEN CROP

Rubber trees need to be appreciated and popularized in all the tropical countries. Although the tendency to think in terms of large plantations is difficult to escape, careful consideration will make it apparent that the Para rubber tree is remarkably well adapted to production on a small scale. Large plantations operated by contract labor as in the East Indies may be very difficult to establish in tropical America, but other systems of production may be practicable. Millions of people in tropical America are landowners only to the extent of small "gardens," as they are called, where root crops, green vegetables, potherbs, and fruit trees are grown, often with poultry or other farm animals, to meet some of the family needs or to provide a small surplus for sale or exchange.

Replacing the native gardens with rubber plantations, or removing the garden people to rubber estates, may be practicable to a limited extent, but enlisting the interest of the people to add rubber trees to their gardens may supplement other lines of production, or even exceed them, once the advantages of small-scale production are worked out and understood.

With a small planting, as a dozen or a hundred rubber trees, collecting the latex is relatively light and pleasant work, to be done in the cool of the morning, and shared without detriment by women and children. No other labor is likely to be more remunerative to the small landowner than tapping rubber trees for an hour or two a day. The rubber harvest does not spoil if other work is more pressing. The requirements of tools and equipment for extracting the latex and preparing the rubber are extremely simple and cheap. The Para rubber tree is extremely well suited to the purposes of the small producer, and is the only tree that will yield rubber by regular tapping.

Castilla trees are often planted or allowed to grow in dooryards in Mexico and Central America, and tapped occasionally, but the latex

can be stolen by thieves and the trees mutilated by severe tapping, whereas the Para trees have little interest for rubber thieves. Castilla is considered beneficial to the soil, a claim also made for several of the tropical fig trees. Coffee and cacao grow well under the shade of Castilla and Para rubber trees. Both trees have an annual leaf fall, allowing subcultures a few weeks of sunlight.

People who live in these tropical gardens have an initial advantage in raising their rubber trees at no expense, if seeds or seedlings are available. Little room is required for the young rubber trees, which are very slender at first, and interfere very little with other uses of such gardens. In addition to familiar fruits and medicinal trees, many useless "wild" trees are often allowed to grow in and around the tropical gardens and small farms, for protection from sun and wind. If only the useless trees in native gardens of tropical America were replaced by Para rubber trees, an extensive production would be assured, possibly more than from plantations in tropical America, where plantation labor is difficult to obtain.

Local supplies of seeds or seedlings are the first requirement for allowing the Para rubber to spread widely as a garden crop in tropical America. The seeds have hard shells, but the kernels are soft and perishable, so that prompt planting is necessary unless special packing and handling are provided. The seeds may be planted "at the stake," or budded seedlings might be planted, if proper care is used.

#### PROBLEMS OF RUBBER LATEX

Many theories of the function of rubber in plants have been advanced, but none has had general acceptance. A flow of latex may cover a wound, but many plants that contain rubber do not form latex. Other functions, as storage or transportation of water or food materials, may be performed by systems of latex tubes, apart from the rubber particles that the latex may carry. Rubber is not, like sugar, starch, or cellulose, to be viewed as a convertible storage product of further use in growth or tissue building, but is rather to be segregated in one part or another, the bark, the leaves, the fruits, or the roots in the various cases that are known, with or without the assistance of latex tubes. To consider rubber as a waste product makes more understandable its occurrence in so many unrelated plants, and in so many different tissues of the plants—principally the bark, leaves, and fruits. The tissues that are discarded are likely to contain more rubber than those that remain as permanent parts of the plant structure.

#### RUBBER BY RULE OF THUMB

In any latex-bearing tree or plant the presence or absence of good rubber can be determined by an extremely simple test made with the

thumb and first finger. Only a small drop of latex is needed—not enough to spread beyond the opposable surfaces of thumb and finger that come in contact, where the skin is thick and resistant. In handling latex from any unknown plant, caution is advised not to permit the latex to touch any thin skin, as between the fingers, where juices of poisonous plants may cause painful injuries. The eyes, of course, as well as mucous membranes, are to be especially guarded. Many latex plants, especially in the dogbane and spurge families, have poisonous properties. Some of the fleshy euphorbias of Africa and Madagascar, in appearance much like cacti, contain acrid poisons. The rubber reactions can be learned without harm, however, if the latex is handled carefully and all traces of it are removed by dry rubbing after the test. Native information regarding any plants that are considered caustic or poisonous should be sought, although many plants that are feared by natives are in reality harmless. Poisonous plants are relatively few in the Tropics, compared with our poison ivy and poison sumac so widely encountered in the United States, or with manchineel in southern Florida. Not only our woodlands are infested with poison ivy, but villages and cities. Precautions against poison ivy are likely to be effective with other poisonous plants.

To make the rubber assay, the little drop of latex is pressed between the thumb and finger, which then are separated, exposing the surface films of latex to the air. After a few exposures, fine threads of elastic rubber may be seen stretching between the moist surfaces, and minute curds of coagulated rubber are formed. The quality of the rubber may be judged from the length, toughness, and elasticity of the threads that appear, and by the formation of a minute roll or spindle of rubber that separates cleanly from the skin when the thumb and finger are rubbed together. If of good quality, the minute sample is not adhesive and shows its elasticity and toughness on being pulled. Samples that are not tough are also less elastic and soon become sticky on the surface, while samples of good rubber remain unchanged. Samples of poor quality, even though they show favorable reactions at first, soon deteriorate, sometimes within a few minutes.

When a flow of latex is encountered in an unknown plant the question naturally arises whether it contains rubber that would be of value if commercial quantities were obtainable. On this question, "Is it rubber?" the thumb and finger may give in a few minutes a fair judgment. After a tree or plant is seen to contain rubber, the finder may be interested to learn its native name and bring home samples of the leaves, flowers, and fruits, so that the species may be identified and studied further. Although the finding of large resources of wild rubber in latex trees or plants that are abundant in

nature is no longer to be expected, it is in order to take account of any rubber bearers that may be encountered in regions that have not received careful explorations.

#### RUBBER AND NEAR-RUBBER

Two very different meanings are carried by the word rubber—the more common physical meaning of a highly elastic substance, and a more general chemical meaning, admitting as rubber all the substances sufficiently related to rubber to show the same reactions with solvents and precipitants, with little regard to the factor of elasticity which seems so all-important from physical and mechanical viewpoints. The trees or plants that produce fully elastic, high-grade rubbers are relatively few, the best known being the Para rubber tree, the Castilla tree, and the Assam rubber tree. Several others, the African rubber tree (*Funtumia*), the African rubber vines (*Landolphia*), the intisi rubber of Madagascar (*Euphorbia intisi*), the *Sapium*, or virgin rubbers of South America, and the *Cryptostegia* vine may also qualify as producers of real rubbers. To be reckoned as near-rubbers are gutta-percha, balata, chicle, guayule, goldenrods, milkweeds, and many other rubberlike gums, some of them of distinct industrial and commercial value.

Some of the near-rubbers, like some of the synthetic rubbers, have special uses which they may serve even better than the best elastic rubber. Gutta-percha, for example, had developed many special uses for which rubber became serviceable after being vulcanized. Making rubber more like gutta-percha was one of the immediate advantages of vulcanization, rubber being much cheaper. Gutta-percha was indispensable to the early discoveries and applications of electricity. Insulating the first Atlantic cables was the epoch-making contribution of gutta-percha. If rubber had not arrived, gutta-percha doubtless would have been the great wonder-working material, and all the other nonelastic or slightly elastic gums doubtless would have had relatively greater values than they can attain in competition with rubber. Yet each of these substitute substances is worthy of being considered from the standpoint of possible use and potential improvement. The advance of rubber chemistry may make it possible to improve the quality of the rubber material in any plant by simple treatment in connection with the processes of extraction or of manufacture.

#### RUBBER WITHOUT LATEX

Even if rubber were confined to plants with latex, to make a complete canvass of the rubber bearers would be a large undertaking, but no such limit can be set to the plants that need to be examined to

determine the presence of rubber. With rubber viewed as a waste product, it might be formed in any group of plants, and indeed is found in many plants that have no specialized latex system or other indication of rubber. The *Eucommia* tree of China, though not provided with latex, has the rubber material sufficiently segregated to show many fine elastic threads when the leaves or the bark are broken and pulled apart. The guayule shrub is the typical example of a rubber producer with no latex or other external sign, the presence of the gum being learned from the Indians who obtained it by chewing the bark.

The tendency to think of rubber only in terms of latex plants still is dominant. The only investigator to face the question of finding rubber among the plants without latex was the great inventor, Thomas A. Edison, who was inclined to believe that the storehouse of nature, if sufficiently searched, would meet any special requirements. In the hope of finding rubber in a plant that could be grown in the United States, preferably as a field crop, large numbers of weeds and other common plants were assayed for rubber, leading to the discovery of rubber among the goldenrods. Many members of this group were subjected to intensive study and selection, to find a type of plant adapted to general cultivation. Because they were so common and so widely distributed in the United States, the goldenrods appeared promising, but cultural limitations were encountered. The rubber is formed mostly in the leaves, and these are difficult to harvest, many falling off before the plants mature.

While the goldenrods were being investigated, thousands of other plants, mostly natives of our southern States or of adjacent districts of Mexico, were examined, and rubber was found, at least in small traces, in hundreds of species where none had been known. Some of the plants were propagated for preliminary tests, but the goldenrods remained the chief interest. Records of Edison's work were placed with the United States Department of Agriculture, and the rubber assays were continued on many other plants. Such assays no doubt are being made in many other countries in view of the present scarcity of rubber. An eventual completion of the Edison project may be hoped for—a world-wide extension of the survey he undertook. Edison, like La Condamine, contributed a new element of interest in the science of rubber, the project of determining all the potential sources of production.

Although Edison's search was projected for herbs or shrubs to be used for field crops, it should, of course, extend to trees—not only to those of temperate regions, but to the tropical trees as well. Rubber trees or lianas without latex are as likely as shrubs or herbs. *Eucommia* is an example of such a tree. Even if important rubber discoveries were not made, such a survey could be expected to yield valuable ex-

perience and information, for, doubtless, many other materials as important as rubber remain to be discovered.

#### RUBBER-FORMING CELLS IN CASTILLA LATEX

Much has been written about rubber latex as a chemically balanced emulsion or suspension of small particles of rubber, without considering biological facts discovered at the beginning of the present century. The bulletin on Castilla rubber published in 1903, in a chapter entitled "The Structure of Latex," referred to a paper by Molisch describing a rubber globule as surrounded by a thin coating of protoplasm, with a small nucleus on one side. This observation was confirmed in a study of fresh Castilla latex in eastern Guatemala in June 1907. The globule of rubber material is clearly distinct from the protoplasmic envelope, which often shows in profile a somewhat thickened area, interpreted as a nucleus, of a standard width and thickness, but with the peripheral margin somewhat uneven. The globules of the fresh latex are in rapid Brownian movement, but gradually come to rest, when it can be seen that the peripheries of contiguous globules are not at first in optical contact, although the thin separating layer eventually disappears, so that the circles of rubber appear to fuse where contacts occur. At the same time the rubber material becomes distinctly more transparent than when the latex is in fresh condition. An oxidizing process is suggested by the gradual change, showing first a narrow hyaline rim around the margin of a cover glass, while the central area is still opalescent like the fresh latex.

#### CASTILLA HANDICAPPED BY AN ENZYME

The presence of a natural ferment or oxidizing enzyme in the Castilla tree has complicated several problems of utilization of the rubber, and of the tree as well. The latex as it oozes from the margins of a cut is creamy white, but in a few minutes shows a brownish tinge, and drops of watery brownish liquid soon appear to separate from the creamy latex and run down the bark of the tree. Some of the creamy latex may run down, or all may remain in the cut, to form the "scrap rubber," which gradually darkens on the surface to nearly black. The shreds or strands of rubber, usually pulled from the cuts in 2 or 3 days, are white or light color inside, but eventually blacken throughout.

More serious than these color changes is the slow, persistent digestive or corrosive action of the enzyme on the rubber. After a few weeks or months the surface of a rubber sample becomes soft and sticky, and the change continues gradually through months and years, so that even a large mass of rubber eventually is reduced to paste. Washing the latex was tried in the early years, to prevent discoloration and softening of the rubber, but this proved to be entirely ineffective. Such

disintegration naturally gave the impression that Castilla rubber is inferior to Para rubber, though in reality no difference has been established by comparison of material not affected by the enzyme.

Since most of the rubber that reached Europe and the United States in the time of Goodyear came from the Castilla tree, the tendency to become sticky was often supposed to be a general quality of rubber. Thus Goodyear's efforts to develop a treatment of rubber that would keep it from becoming sticky, the efforts that led to the accidental discovery of vulcanization, hark back to the enzyme. When Para rubber from Brazil proved not to be sticky, it was naturally considered a superior kind.

That some of the Castilla rubber, even in the early days, was not sticky, may be inferred from the extent to which rubber was being used in England and America before Goodyear's discovery was made. Even the uses of rubber among the Indians of Mexico and Central America would not have developed with a sticky material. The Indians knew how to treat the rubber to keep it from becoming sticky, by spreading the latex in thin layers on large leaves and exposing it on open ground to the heat of the sun, thus destroying the enzyme. The native procedure in coagulating the Castilla rubber, witnessed and photographed in the Soconusco district of southwestern Guatemala in 1902, was described and illustrated in the bulletin of 1903. The samples of Castilla rubber prepared by the native "uleros" remained in good condition for more than 20 years, as little affected by age as samples of Para rubber, showing that the treatment had been completely effective in destroying the enzyme. Samples from washed latex seemed to deteriorate even more rapidly than others, perhaps because the enzyme was more thoroughly distributed among the rubber particles. It was known already that an enzyme was responsible for the deterioration of the Castilla rubber, and that the enzyme could be destroyed simply by heating the latex, as published by Parkin in 1900, in the *Annals of Botany*.

Although the demand for rubber increased more rapidly after Goodyear's discovery was made, the previous century, between La Condamine and Goodyear, had witnessed a gradual advance. The properties and uses of rubber, largely in waterproofing, furnished the last chapter on "Vegetable Substances" in the "Library of Entertaining Knowledge," published at London in 1833, concluding with a statement of imports and prices.

More than fifty-two thousand pounds of caoutchouc were imported into England in 1830, being nearly double the quantity brought during the preceding year. The consumption for the year ending April 5, 1833, is stated at 178,676 lbs. Its price is from 1s. 6d. to 2s. 3d. per lb.; the duty upon it being 5d. per lb. The increase in the demand is to be ascribed to the application of the substance as an article of general utility.

The sources of the raw rubber were not stated, but even Brazilian rubber of that period came mostly from Castilla. Methods of treating rubber in England may have involved heating it enough to destroy the enzyme. Nothing was said of rubber being sticky.

A discovery made in Haiti in 1930 in relation to the enzyme of Castilla showed that the enzyme may be destroyed while the latex is still in the bark. Abundant threads of elastic rubber were found that separated readily from the decaying bark of Castilla logs, known to have been felled nearly 3 years before. The usual failure of proper coagulation to take place in the bark may be ascribed to the oxidizing enzyme, and the exceptional occurrence of good rubber was ascribed to the fact that the logs had not been shaded but lay in an open place where the trees had stood.

The pertinence of the expression "oxidizing enzyme" is appreciated when it is known that the Castilla latex as it flows from the tree will retain its creamy color and show no separation of the rubber material if kept from the air by being corked in a glass bottle. Faraday had a bottle of rubber latex from southern Mexico which is said to have reached England very nearly in the same state in which it came from the tree; a slight film of solid caoutchouc had formed on the surface of the cork which closed the bottle. Efforts have been made in the present century to ship Castilla latex to the United States in tin cans, but the latex blackened and spoiled, or the rubber coagulated, as it does in bottles when not corked.

#### LATEX SEPARATE FROM SAP

Another fact relating to the enzyme was discovered in June 1907 in experimental tapping of Castilla trees in eastern Guatemala, on the Trece Aguas estate near Senahú between Panzos and Cahabón. It was noted that occasional drops of latex exuded from the surfaces of the tapping wounds after removal of the scrap rubber, and that these drops did not show the usual separation of a brown liquid, nor the usual staining of the rubber.

These creamy white drops were observed repeatedly during the day, but no discoloration took place, and the latex eventually coagulated without darkening. The drops resulted, obviously, from the loss by the latex tubes of their plugs of coagulated rubber when the "scrap" was pulled from the cuts. Considering these drops as samples of the latex as it exists in the tubes, the failure to show any of the discoloring fluid that gradually separates from latex in the tapping cuts of Castilla was specially noted. Thus the behavior of these nonstaining drops of latex brought into question the general assumption that the enzyme is a normal constituent of the latex of the Castilla tree. It is known, of course, that the latex tubes are separate from the other



tissues of the bark, but it appears that sap as well as latex exudes in the tapping cuts and that the two are mixed, to the detriment of the rubber.

#### SPECIALIZED BRANCHES AND LEAVES IN CASTILLA

Botanical textbooks do not prepare us to appreciate the vegetative specializations of plants. The floral organs in many families are highly specialized and have been studied in great detail, while little account has been taken of different forms of branches and leaves, even among agricultural plants where peculiarities of the vegetative organs often determine methods of culture or pruning. Several examples of two distinct kinds of branches were described in a publication of the United States Department of Agriculture in 1911, Bulletin 198, "Dimorphic Branches of Tropical Crop Plants; Cotton, Coffee, Cacao, the Central American Rubber Tree, and the Banana." Specialized branching habits in the Para rubber tree were also reported in 1930.

The vegetative parts of plants, like the flowers themselves, are formed as a succession of equivalent structural units, known to morphologists as metamers or phytomers. Each unit consists theoretically of two structural elements, a stem section or caulomer, and a leaf section or phyllomer. Either of these elements may be suppressed, but both are present in normal vegetative metamers. It is usual to think of the vegetative metamers as all alike, and of floral metamers as of many forms. In reality the vegetative metamers are capable of being as definitely specialized as the floral metamers, some as preceding the flowers, others as forming specialized branches.

Not only the structures and functions of two kinds of branches are different in Castilla, but also the forms of the leaves, showing that the vegetative specializations are deep-seated and long-standing. No other tree has afforded more outstanding examples of vegetative specialization than Castilla. The sexes are on separate trees, the inflorescences are of three kinds, the branches of two kinds, and the leaves of four kinds. An adaptive advantage of the specialized branching habits is seen in the fact that Castilla outgrows the Para rubber tree in the early stage of development, before fruiting begins. Instead of the early growth being limited to the production of a very slender trunk as in the Para rubber tree, the young Castilla trees develop specialized lateral branches and soon form a thicker trunk and a thicker layer of latex-bearing bark, so that in a few years the total content of rubber in a Castilla tree may be several times larger than in a Para rubber tree. Illustrations of Castilla trees, showing their rapid growth and peculiar branching habits, were published in 1903.

## TWO FORMS OF BRANCHES IN CASTILLA

The habits of growth of *Castilla* under forest conditions, where the trees have tall, cylindrical trunks are shown in plate 1. In open places branches are produced only a few feet from the ground, as in plates 2, 3, and 4. The upper figure in plate 4 shows a young plantation of *Castilla* with all the trees producing the slender horizontal branches that mark the juvenile stage of this tree, preceding the production of the stout ascending branches that form the permanent framework of the tree, as shown in the mature tree in plate 2. Two young trees also are shown in plate 2, and the mature tree has a new shoot with large leaves on long horizontal branches, like the young trees.

The horizontal lateral branches, slender and simple, are the outstanding feature of the *Castilla* tree, since they bear most of the leaves and all the flowers and fruits. Yet all the branches of this type are temporary and deciduous, being released after two or three seasons by a basal socket of abscission. The leaves of the lateral branches are oblong, large, and pendent, inserted in two ranks. Lateral branches are produced only on new growth, one branch from each stem section of the trunk, rising from an axillary bud. The lateral branches remain simple because no leaf buds are produced, only flower buds.

The lower lateral branches often grow several feet long, and are to be considered as the most specialized, since even the flower buds are suppressed. The basal joint of a lateral branch is notably shorter than the others, and the leaf is suppressed. The leaves near the base of a lateral branch are not as large as those farther out, and in a few weeks may turn yellow and fall off. Leaves of lateral branches are often found with one of the auricles distinctly lobed, always on the lower side, toward the base of the branch. The upper auricle may be larger than the lower, but is never lobed.

The branches of the trunk, those that provide the permanent framework of the tree, usually develop much later than the lateral branches. They do not project horizontally like the lateral branches, but are upright or ascending, and are not self-pruning at the base. They are not produced consecutively at each joint of the trunk, as the lateral branches are, but are relatively few, and do not arise from the axil of a leaf but from an extra-axillary bud at the right or left of a lateral branch. The location of the extra-axillary buds is consistent in each tree, so that the trees can be distinguished readily as right-handed or left-handed with respect to the buds that give rise to the permanent branches. The leaves of the trunk are not distichous like those of the lateral branches, but in several ranks, probably representing a spiral of five-thirteenths. Two or three short, leafless joints are formed at the base of a permanent branch, instead of the single short joint on a

lateral branch. The leaves of the branches are like those that subtend the lateral branches on the original trunk.

From a morphological viewpoint the lateral branches of Castilla may be interpreted as inflorescences that have developed a special form of leaves and assumed a major proportion of the vegetative functions. This appears strikingly in the young trees, the lower lateral branches growing to the greatest length, often 10 or 12 feet, and yet not bearing any flowers or fruits. The shorter laterals, farther up the trunk, most of them only 3 to 4 feet long, produce flowers or fruits in a continuous series, except on a few of the basal joints.

The long laterals of the lower part of the trunk may be compared to the spreading rosette leaves of many herbaceous plants. A wide expanse of foliage is formed on young trees standing in open places where the branches have full sunlight and develop symmetrically so that the ground underneath is well shaded. An adaptive function of the specialized branching is seen in the rapid and continuous development of further new sections of the trunk, each with its lateral branch, and these in turn soon replacing those lower down. The young trees are of striking appearance, regular in form and vivid in color. Apart from the interest in rubber, Castilla trees might well be planted around schools in southern Florida, and in other tropical countries, to facilitate the study of the vegetative specializations.

#### SPECIALIZED LEAVES OF DIMORPHIC BRANCHES

As previously indicated, the leaves of lateral branches of Castilla are different from those of the main trunk and the permanent branches. The oblong form, the pinnate venation, and the short petioles are the outstanding features of the lateral-branch leaves. Compared with the leaves of the lateral branches, those of the trunk and the permanent branches are relatively short and broad, and the petioles notably longer. The venation of the trunk leaves is markedly different, being palmate rather than pinnate, with a basal vein on each side more oblique and longer than the others. The secondary veins along the lower side of these long primaries are much stronger than other secondary veins, sometimes attaining a length of more than 2 inches. The leaves of the trunk and its permanent branches often appear as reduced or rudimentary. Some of them are only 4 or 5 inches long and less than 3 inches broad. Such leaves may be seen only on new growth, since they usually turn yellow and fall off in a few weeks. On other trees the trunk leaves may be nearly as wide as the branch leaves but only half the length, broadly shouldered or angled at the side, with less than half the number of primary veins, and the large basal vein on each side strongly developed.

## TWO PRELIMINARY LEAF FORMS IN CASTILLA

In addition to the leaves of the trunk and those of the lateral branches, two other forms of leaves precede those found on mature trees. A seedling stage of development may be recognized, and also a juvenile stage, between the small seedlings and the stage of forming lateral branches. A young *Castilla* tree just beginning to develop lateral branches is shown in plate 5, with two of the large juvenile leaves still in place; above these large leaves is a much smaller, heart-shaped leaf subtending one of the lateral branches. Preceding the formation of branches, several joints of the axis produce what may be considered as juvenile leaves, with large blades and long petioles as their outstanding features.

Usually the petioles of the juvenile leaves are 3 to 5 inches long, sometimes 6 to 8 inches, while leaf blades may be more than 20 inches long and 8 to 10 inches wide. Leaves of the juvenile form occur also on sprouts from stumps or wounded trees and may be even larger than those of seedling trees. Juvenile leaves a foot wide and nearly 2 feet long were found on stump shoots in Panama June 1923, much exceeding the largest leaves on lateral branches of *Castilla panamensis*, even where growth is luxuriant.

The transition from the large, long-stalked juvenile leaves to the leaves that subtend the lower branches may be gradual, but often is remarkably abrupt, with leaf blades smaller and petioles shorter. The normal leaves of the trunk and permanent branches in *Castilla elastica* have petioles about 2 inches long, with the blades 6 to 7 inches long and 5 to 6 inches wide. The leaves of the lateral branches in vigorous young trees may attain a length of 15 to 20 inches and a breadth of 6 to 7 inches, but with petioles only 1 inch long, often equaled or exceeded by the broadly rounded basal auricles.

Preceding the large juvenile leaves are the small, short-petioled leaves of the seedling stage, only 2 or 3 inches long, as shown in plate 6. The first two leaves of the seedling, shorter and broader than the others, and nearly opposite, may be mistaken for cotyledons. They are borne on a long stem section or epicotyl, while the true cotyledons remain in the ground, no hypocotyl being formed. The paired basal leaves, borne on a long stem section or epicotyl, are broadly cordate and open-veined, in contrast with the alternate, oblong, close-veined leaves that follow, between the epicotyl leaves and the enlarged juvenile leaves. Thus the foliage of the *Castilla* tree may be considered as a series of specialized leaf forms: cotyledons, basal leaves or epicotyledons, seedling leaves, juvenile leaves, trunk leaves, and branch leaves. *Castilla* thrives in southern Florida and is worthy of study from the standpoint of structural specialization, apart from its economic interest.

## PROPAGATION OF CASTILLA FROM PERMANENT BRANCHES

The specialized branching habits must be recognized in order to appreciate the fact that Castilla is readily propagated from cuttings of the permanent branches. Cuttings of lateral branches would not serve, even if roots were formed, since lateral branches have no vegetative buds. Many cases were encountered in southern Mexico in 1902 where roadside Castilla trees had been planted as fence stakes, and had grown into large trees.

Propagation from cuttings is a cultural expedient that may be applied to Castilla in the event that suitable methods of mechanical extraction are developed and a rapid extension of production from Castilla is attempted. Abundant material would be available in districts where abandoned plantations still exist, and such cuttings could be shipped readily if needed in other localities.

With Castilla grown in forest formation and the trees lumbered out for mechanical extraction of the rubber, the smaller limbs of the more productive trees might be utilized in new plantings. Time and labor might be saved in thus avoiding the need of seed beds, transplanting, and caring for young seedlings. Sprouts that grew from the stumps of productive trees also might be used for propagation with no loss of time in obtaining the advantages of selection.

Although Castilla grows generally as a forest tree, it is rarely found in deep forests, but is like the related trumpet tree or *Cecropia* in being better adapted to relatively open "second-growth" forests, on lands previously cleared and planted for a season or two, under the native system of agriculture.

## FOREST ADAPTATIONS OF THE PARA RUBBER TREE

The natural adaptations of a plant are clues to its cultural requirements. The seedling and sapling stages of the Para rubber tree show several peculiar characters that render them specially adapted to undergrowth conditions in tropical forests. Many types of plants are definitely specialized to live as undergrowth, and the development of undergrowth vegetation in the forests of the Amazon valley is probably greater than in any other region. The seedlings of forest trees live at first as undergrowth plants, and have their share of specially adapted characters. Unless these adaptations are recognized, several features in the behavior of the young Para rubber plants may not be understood.

Some of the specialized shade plants require protection and do not thrive in the open, while others can grow in open places but with certain changes of accommodation, such as shortening the joints of the stems, branching closer to the ground, reducing the leaf surfaces,

and thickening the tissues of the leaves. Such adjustments to conditions are shown in the Para rubber tree, but to a rather slight extent. Although the seedling foliage is delicate, exposure to the sun is not injurious as long as the soil and the air conditions do not reach a state of stress or injurious shortage of moisture. With other conditions sufficiently favorable, more growth may be made in the sun than in the shade, but the manner of growing is the same.

The adaptive specializations of the Para rubber tree offer several complete contrasts with those of the Castilla tree. The number of specialized features is nearly as great, but they are not along parallel lines, or even analogous. Instead of developing branches 3 or 4 feet from the ground, where the Castilla tree produces its longest lateral branches, the Para rubber tree normally produces no branches at all to a height of 12 to 20 feet. The suppression of all branch-forming buds on the many joints or sections of the trunk is a specialized feature, since it is possible for branches to be formed at any height if the trunk is cut back. Even in the axils of the cotyledons are buds that develop if the plumule is removed. This makes it possible for the seedlings to be split, by methods described and illustrated by Loomis in 1942, and two plants raised from the same seed.

The habit of branching in the Para rubber tree is consistent with the habit of forming the leaves in clusters or "flushes." Branching begins abruptly, with several vegetative buds developing at the same time from the axils of several leaves of the same whorl or cluster, at nearly the same level. The formation of such a cluster of branches normally makes an end of the main trunk of the tree. In exceptional cases only two or three branches are formed in the first whorl, and the trunk may continue its upward growth until more branches are developed, but after a normal whorl of 6 to 12 branches has developed, a spreading or ascending treetop is usually formed, with no indication of a central trunk. A brief account of "Branching Habits of the Hevea Rubber Tree," explaining their cultural significance, was published in 1930.

The earlier fruiting of the Castilla tree is determined by the habits of branching. Although the lowest branches of Castilla usually have no flowers or fruits, they are of the fruiting type, and the functional fruiting stage is soon reached, as in plate 2, often within 5 or 6 feet from the ground. At the corresponding stage of growth the Para rubber tree has only half completed the development of its primary upright as a simple, straight rod, normally without the few branches shown at the right in plate 11. The uniform suppression of branches on the many trunk sections that form the primary upright of the Para rubber tree is therefore to be considered as a specialized feature of adaptation to forest conditions. The numerous differ-

ences in adaptive characters between the Castilla and the Para rubber tree emphasize the need for critical comparison of the cultural requirements of the two trees.

#### BRANCHING HABITS OF PARA RUBBER TREE

As a consequence of the habits of branching in the Para rubber tree, two distinct phases of growth may be recognized: a juvenile phase that includes the development of a simple primary upright, and an adult phase that comprises the subsequent growth of the tree, after the formation of branches. The pattern of growth in the young tree is characterized by the suppression of lateral buds in all the joints of the trunk, which results in the formation of a tall, simple trunk as rapidly as possible; in the adult phase many diverging branches are formed, and the upward growth of the trunk to form a central axis of the tree is discontinued.

Although the branching of individual Para rubber trees is extremely variable, there is a notable tendency to form a cluster or whorl of branches at the end of the primary upright, so that many of the trees have the form of a brush or candelabrum. In exposed places, where the trees are checked or stunted, the branching pattern is often disturbed, and a few branches are formed along the trunks, usually as singles or pairs, before a normal whorl of branches is produced; or the branching pattern may remain irregular.

#### INTERMITTENT GROWTH OF TRUNK

The pattern of branching undoubtedly has a relation to the mode of development of the trunk, by flushes or spurts of growth. Each period of activity results in the formation of a new section of the trunk, composed of numerous joints of different lengths. The terminal leaf-bearing members of a growth section are much shorter than the basal metamers, which often are without leaves, or have the leaves reduced to minute hooklike rudiments.

The development of a new growth section is very rapid, so that the entire whorl of leaves is produced practically simultaneously, following a period of rest when the terminal bud remains completely dormant. Under forest conditions, with the rubber seedlings receiving little light and competing with other vegetation, long intervals may elapse, perhaps entire seasons, between the development of successive growth sections.

It is not difficult to see that the habit of intermittent growth may have advantages under forest conditions where light is deficient. The only seedlings that can be expected to develop on the floor of the deep forest are those that live with very little light. The chance of reach-

ing maturity may depend very acutely upon the ability of the plant to take full advantage of the light that reaches it. The danger of the young plant losing any light by shading its own leaves is avoided by the arrangement of the leaves in rosettes, forming a circular cluster at the end of the shoot, like a small umbrella.

#### LEAVES ARRANGED IN ROSETTES

The leaves that form a rosette are of different sizes and have petioles of different lengths, so that the rosette arrangement gives them full exposure to the light. The complete suppression of the leaves on the lower joints of each of the growth sections—the leaves that would be shaded by the terminal rosette—is another feature of the arrangement. The leafless lower joints add notably to the length of the section and contribute to the height of the young tree. With every section that is added the light conditions are improved and the tree's chances are increased of emerging eventually through the roof of the forest and finding a place in the sun.

The number of leaves in a rosette is increased rapidly in the successive sections that are formed, from the 2 leaves of the first stage of the seedlings to 12 or 15 leaves. Vigorous plants in the second and third seasons may have from 20 to 30 leaves in a rosette, while 5 or 6 of the lower joints of the growth section are without leaves.

#### MANY LEAFLESS METAMERS

A further specialization for forest conditions is seen in the suppression of the leaves on many of the metamers, the structural units that make up the trunk of the Para rubber tree. The first stage of the seedling is highly specialized in this respect, with basal joint or epicotyl, the first trunk section above the cotyledons, not bearing leaves, although remarkably elongate. Epicotyls measuring 9 to 14 inches in length were noted in Haiti. The Castilla epicotyl ends with a pair of leaves, as shown in plate 6, while that of the Para rubber tree has the leaves suppressed, and two or three shorter leafless metamers may be formed above the epicotyl, below the first pair of leaves.

The long epicotyl and adjacent leafless metamers of the Para rubber seedlings, shown in plates 7 and 8, carry the first leaves often a foot or more above the ground, much higher than the short epicotyl of Castilla, shown in natural size in plate 6. Thus it may be said that the seedlings of the Para rubber tree have all the leaves suppressed in the lower stem sections corresponding to those of Castilla shown in plate 6, where all the metamers bear leaves.

As seen in plates 7 and 8, the first two leaves of the Para rubber seedlings are borne at nearly the same level, while the next leaf above this first pair usually stands alone at the end, above an intervening



series of leafless metamers, usually three to five, corresponding to the leafless metamers below the first leaves. Thus the alternation of groups of leafless and leaf-bearing metamers in the subsequent development of the trunk may be homologized with the specializations of the seedling.

In the later development of the tree the specialized basal metamer of the seedling appears somewhat distinct. Often this section is rather abruptly thickened in advance of the others, and the enlargement continues in many trees to the formation of salient angles or buttresses around the base of the trunk. The production of adventitious roots from the surface of the enlarged basal section also occurs rather frequently, especially on young trees that stand in depressions or where the soil is deepened by top dressing.

#### SPONGY, PERISHABLE SEEDS

The seeds of the Para rubber tree are very similar to the seeds of some of the palms that are specialized for forest conditions. There is a thin outer shell of very hard columnar tissue, filled with the rather succulent, loose-textured cotyledons, like the endosperm of some of the forest palms, as *Oenocarpus* and *Astrocaryum*. The soft texture of the seeds may not be an advantage in itself, but is doubtless due to the fact that water is carried in the tissue, so that the preliminaries of germination can go forward without waiting for moisture to be absorbed from the outside. Thus it is possible for the seeds of the Para rubber tree to germinate without being covered, but merely lying among the dead leaves or on the surface of the ground under the forest shade. Germination may be deferred to some extent if the seeds are kept a little dry, but they die very soon if drying is carried too far.

The hard shell is not ruptured in the germination of the seed, the plumule, carried by the growth of the petioles of the cotyledons, emerging through a small round hole, a method of germination that is followed in many palms. As soon as the roots are exposed, the seedlings can absorb moisture from wet surfaces, though the soft-textured cotyledons, protected by the shell of the seed, may continue to function for storing and equalizing the supply of water until the roots have penetrated to permanent moisture. Having made its contacts with the soil, the Para rubber seedling wastes no time forming leaves near the ground, but sends up a smooth, slender, green stem, sometimes a foot long before producing any leaves.

#### LEAVES OF SEEDLINGS DELICATE

The delicate texture of the leaves of the seedlings is another forest adaptation that seems to be definitely established in the Para rubber

tree. The seedling leaves are much thinner than those of adult trees, and apparently much more susceptible to injury from exposure to adverse conditions. The change in texture from the thin seedling leaves to the thicker and firmer adult leaves occurs much earlier in some trees than in others, a difference that may be of value in developing resistant varieties.

Where soil conditions are perfect, seedling plants may tolerate full exposure, but in heavier soils the seedlings are more susceptible to injury from direct sunlight. Under the equable forest conditions the seedlings have a persistent vitality that probably allows them to survive for many years in places that are too dark or too unfavorable in other ways to permit normal growth. Plants abandoned in old seed beds, after being stunted for 2 or 3 years, have been able to recover the vigor of normal plants. The tolerance of shade conditions shows the extent of forest adaptation, which also may be inferred from the absence of surface protection by hairs or bud scales as in Castilla, and from the presence of special openings or water pores in the lower surface of the leaves, as described by Bobiloeff.

#### A GROWTH DISORDER IN SEEDLINGS OF PARA RUBBER

A growth disorder often affecting large proportions of the seedlings of the Para rubber tree is worthy of careful study and comparison with analogous disorders of other plants, in the interest of better understanding of habits of growth and cultural requirements during the seedling and juvenile stages. Since the disorder is most severe and striking in the young seedlings, much of the injury has been avoided by the simple expedient of discarding all the stunted or distorted individuals in the nursery stocks, under the usual precaution that only normal, vigorous trees are to be set in the plantations. Even among normal rubber trees, those that pass muster in transplanting and make satisfactory growth in the plantations, an enormous diversity is found—greater than in other tree crops.

The trees in the rubber plantations are found to differ not only in the stature and proportions of the trunks, leaves, floral characters, and seeds, but also in the bark texture and in the latex tubes, which more definitely affect the yields of rubber. The surface of the bark may be smooth or finely wrinkled like a beech tree, or rough and remose like an elm or an oak, while the structure may be uniform, soft and cheesy, or brittle and gritty with stone cells. In experiments where records of individual trees are carried through long periods some trees are found to be yielding scarcely any rubber, and others only small amounts, while a few individuals are far above the general average, so that 75 percent of the rubber is produced by 15 to 25 percent of the trees. Budding from high-yielding trees raises the average, although

the individual yields still vary widely on account of diversity of the stocks.

The multifarious individual diversities shown in these disorders are of potential interest and significance in relation to heredity and evolution, in showing that great numbers of different patterns of divergence from normal heredity are set up and consistently followed for weeks, months, or years in the development of the individual plants. These individual patterns are often so completely different in closely contiguous plants as to forbid any assumption that different conditions of growth explain the variations. The effects of local conditions or injuries may be seen as inducing the general instability in the expression of the hereditary characters that seems also to occur in some of the deficiency diseases, giving rise to extremely varied symptoms.

#### DIVERSITY IN ABNORMAL PLANTS

In addition to the variants that grow with nearly normal vigor, there are great numbers of seedlings that must be reckoned as definitely abnormal. Many are practically leafless, or with leaves so pale, dwarfed, and distorted that the plants are able to survive only while protected in the seed beds.

Many illustrations would be required to show the range of diversities in the various characters, but the three given in plates 9 and 10 illustrate abnormally narrow leaves of different forms. A rather extreme form is shown at the right of plate 9, with the primary veins much closer and more numerous than those of normal pinnae shown at the left in plate 10. The narrow, tapering, erect pinnae at the right of plate 10 have little resemblance to the long, drooping pinnae of plate 9. Many variants have still narrower pinnae, with the margins notched to the midrib, while others have curved or twisted pinnae, or funnel-shaped "ascidia." The series of foliar aberrations is comparable to that of the familiar "crotons" or codiaeums, which also belong to the spurge family. Pinnae of normal form are only 2 or 3 times as long as wide, while some of the abnormal pinnae are 10 to 20 times as long as wide. Some abnormal plants have the stalks of the pinnae longer than usual, or the stalks may be very short and grown together, so that the pinnae do not separate. Some leaves exhibit super-numerary pinnae.

#### RECOVERY OF NORMAL LEAF FORMS

A notable feature of these abnormal rubber seedlings is that sudden and striking changes toward more normal leaf patterns and growth behavior are possible, as shown in plate 9. A plant with only narrow, slender leaves develops a new cluster with its leaves of normal, or nearly normal, proportions. This ability to recover shows that the

pattern of normal growth has not been lost, but only suppressed during the stage of abnormality, as in growth disorders that are caused by feeding punctures of plant lice, mealybugs, or leafhoppers, presumably as effects of salivary secretions of the insects, without virus infection, so that normal growth is resumed upon removal of the insects. Such disorders are known in cotton and many other plants, but these malformations are relatively uniform in each disorder, with no such individual diversity as in the disordered rubber seedlings. Marked diversity with potential recovery is a distinctive feature of the growth disorder of the Para rubber seedlings, and the interest of this combination is not lessened by ascribing the abnormalities of the rubber seedlings to mites or "red spiders," as reported from the Dutch Indies.

#### A MATURE TREE WITH NARROW LEAVES

That some of the marked variations might survive and reach maturity is suggested by the discovery of a mature, narrow-leaved tree in a neglected planting of Para rubber at Bayeux, Haiti in 1925. Leaves and flowers of this tree are shown in natural size in plate 10, in comparison with those of a normal broadleaf tree in the same planting. The entire tree was narrow-leaved like the branches that were photographed. One branch had a fully developed fruit. Such an aberrant tree in ordinary practice would be left in a seed bed instead of being set in a field planting, but may have grown in this instance from a volunteer seedling. Taken by itself such a tree might be recorded as an outstanding mutation, but doubtless should be considered against the background of wide diversity appearing as a growth disorder.

#### THE PARA RUBBER TREE AS A HYBRID STOCK

This variability of the cultivated rubber tree may be connected with the biological status of the wild stock in South America. Because of the geographic position of the species in the lower Amazon valley and the adaptation of the seeds for floating, unusual conditions for hybridization are afforded, not as a rare contingency, but as a frequent occurrence. Swollen currents from the upper river often reverse the flow of the lower tributaries, so that floating seeds may be stranded far from the main stream. Thus the stock of *Siphonia* over a wide area of the lower valley must have remained continually accessible to crossing with the several up-river species. Hybridizing as a preliminary to selection has been accomplished in nature.

#### RUBBER IN A DESERT SHRUB

The third place in rubber history must be accorded to the guayule shrub, *Parthenium argentatum*, a native of windswept desert table-

lands in northeastern Mexico and the adjacent Big Bend area of western Texas. Greater contrasts than actually exist between this rubber shrub of the open deserts and the rubber trees of the tropical forests would be difficult to imagine. The only resemblance lies in the presence of rubber, and even in this feature there is no similarity, since guayule does not have latex, but forms its rubber in separate cells of the bark.

Guayule is one of many low, compact, woody shrubs with small grayish leaves, forming one of the principal types of desert vegetation, as appropriate under the desert conditions as are the tall, spreading trees to the conditions of tropical forests. Hundreds of similar grayish shrubs have developed in desert areas in different parts of the world, alike in general form and appearance, but showing unlimited diversities in structural features and derived from many different families of plants. Guayule stands apart from other rubber plants in its relationships as a member of the thistle family, not of the lettuce or chicory family, which also have rubber but in the form of latex. The discovery of rubber in guayule doubtless was made long ago, since the natives of northern Mexico relied on guayule rubber for making the rubber balls used in traditional games and ceremonies. The natives extracted the rubber by chewing the guayule bark. The presence of guayule in Texas was learned from finding balls of rubber as obstructions in the stomachs of range cattle that had died suddenly.

Little has come to light regarding the early development of a guayule industry, first as an export trade that had reached a practical scale before 1902 preceding the development and use of machinery for extracting guayule rubber in Mexico, and later in western Texas, at Marathon. The photograph reproduced in plate 13 shows a quantity of baled guayule in a storage yard at San Luis Potosi, in June 1902.

No other experimental undertaking by private interests in the field of applied botany has been carried so far. With the specialized methods and machinery it appeared that costs of production might be brought down to 20 cents or less per pound, in the period before the price of plantation rubber declined to that level. Even with Para rubber at 15 cents or less, the demand for guayule as a compounding ingredient provided a market for the limited quantity that was obtainable. A limiting factor in California was the advance of land values to a point too high for the development of a large guayule industry. In Texas, where large areas of low-priced land were available, guayule proved to be susceptible to the root-rot disease, caused by a fungus that lives in the soil and is often destructive to cotton and other crops. The factory at Marathon closed in 1926, but was reported in November 1943 as opened for emergency production, using the wild guayule in the Big Bend district.

## DEVELOPING A GUAYULE INDUSTRY

In a few years it was plain that the natural supplies of guayule were becoming inadequate, and measures for maintaining the industry began to be considered. Large areas of desert land were acquired by some of the rubber companies, and various expedients tested, such as protecting young plants and scattering seeds in places that seemed most favorable, but with little result. Cultural experiments also were undertaken in Mexico and later transferred to southern California, near San Diego, in the period of unrest following the revolution of 1906. The results appeared promising, and in the course of about 30 years the work was carried through the stages of selecting and testing many superior varieties, and of developing highly mechanized equipment for large-scale production and extraction. The proportion of rubber in the better strains of guayule is higher than has been determined in any other plant, approaching 20 percent.

Plantings of guayule in the vicinity of Escondido, northeast of San Diego, were increased to about 400 acres, and later, near Tucson, Ariz., plantings were expanded to a scale of thousands of acres. There, however, conditions proved less favorable for the growth of the plants than had been expected, and the undertaking was transferred to the Salinas Valley, Calif., in the vicinity of Monterey. There a factory large enough to extract the rubber from several thousand acres of guayule was built and operated. Grinding, retting, and vacuum treatments are necessary, the last to waterlog the wood particles and allow all the rubber to float, which completes the separation. The expenditures for land, research, and equipment of the three large-scale experiments with guayule were credibly reported as approaching \$2,000,000.

## EFFECT OF RIDLEY'S DISCOVERY ON GUAYULE AND CASTILLA

To infer from the history of guayule that the undertaking was defective or ill-advised would be unfair. The planting of guayule in northern Mexico was projected in the same period as the planting of Castilla in southern Mexico, and either or both of these undertakings might have returned good profits if rubber had not declined below a dollar or even 50 cents a pound. Ridley's discovery in the Orient of a continuous method of extracting rubber from the Para rubber trees remained, as we have seen, practically unknown and unexplained for many years, even after it was being utilized on an extensive scale. The Ridley method was possible because the Para rubber tree was equipped with a system of connected latex tubes, and because large supplies of cheap and skillful labor were available in the East Indies.

Nobody could know beforehand how soon the Para rubber of the East Indian plantations would come, like the cotton of our Southern States, into speculative markets where prices would be forced down far below the costs of production by a normal farming population, to 12 cents, 10 cents, or 5 cents. The rapid advance to large-scale production of rubber in Malaya had the effect in a few years of preempting the field and placing commercial handicaps on any alternative developments. Every invention or improvement runs the risk of being blanketed or outrun by some competing improvement, more effective or more attractive. The chance of such a discovery and development as took place with the Para rubber in the East Indies must be considered very small, but it did actually occur, with the effect of reducing the Castilla and guayule projects to the status of nearly complete failures, as long as rubber could be had in unlimited quantities from the East Indies.

#### POSSIBILITY OF APPLYING GUAYULE EXTRACTION METHODS TO CASTILLA

A possibility recognized in recent years is that the mechanical methods of extraction developed through the long experience with guayule may be adapted to the extraction of rubber from the bark of the Castilla tree. An observation was made in Haiti in 1930, reported in 1937 and in 1943, of the finding of good-quality rubber in decaying Castilla bark, instead of merely a black pasty residue left by the latex in the dead bark, as previously observed and ascribed to the action of the oxidizing enzyme. This internal coagulation of the latex means that the rubber of Castilla is brought within the possibility of mechanical extraction by grinding the bark and separating the rubber, as practiced with guayule. Such an approach to mechanical extraction is entirely different from attempting to draw out or to squeeze out the latex, or to extract the rubber by solvents. The means of coagulating the rubber in the Castilla latex is a simple heat treatment to destroy the oxidizing enzyme, only moderate temperatures below the boiling point being required.

Mechanical extraction of Castilla rubber, if a feasible process were worked out, would open the way to a system of rubber production requiring much less labor than for tapping and collecting the latex in plantations of the Para rubber tree. The reason why a mechanical system is less applicable to the Para rubber tree is that the latex layer of the bark is only a few millimeters thick, while that of Castilla attains a centimeter or more in thickness. Only a small proportion of the rubber material in the latex tubes of Castilla trees has been extracted by any of the methods of tapping used in the past.

A popular impression that the latex of Castilla "pours like water from a pipe," and that "the entire content of rubber runs out quickly,"

is without foundation. The latex tubes are only slightly compressed by the release of the bark pressure and are still full of latex, which remains in the bark and is lost. The proportion of rubber to bark tissue in Castilla is doubtless much lower than in guayule, since the Castilla bark is woody and fibrous, but with the rubber coagulated in tough elastic strands, the extraction process may be much simpler. Guayule must be ground very fine, to the point of breaking down individual cells, in order to release the rubber material.

Several cultural advantages of Castilla are obvious. The seedlings and young plants are hardier than those of the Para rubber tree, in the sense of being adapted to a much wider range of adverse conditions. The young trees develop and reproduce more rapidly, and also propagate readily from large cuttings of the vegetative branches. Thus it may be hoped that the renewal of interest in Castilla and guayule during the present wartime emergency will carry through to an effective determination of production possibilities.

Not only the Castilla rubber tree, but other latex trees with similar tapping problems, such as *Ficus elastica*, chicle, and balata, are of interest from the standpoint of mechanical extraction. It is not unthinkable that trees adapted to mechanical extraction eventually might replace the Para rubber and lend a wider significance to the work done on guayule. A man of great energy, acute intelligence, and constructive engineering ability, the late George H. Carnahan, president for many years of the Inter-Continental Rubber Company, was largely responsible for the remarkably persistent and effective investigation of the cultural and mechanical problems. Unlike many private undertakings in the scientific field, detailed accounts of various stages of progress in the guayule undertaking were published. Carnahan undoubtedly should rank with Edison, Ridley, Wickham, Goodyear, Faraday, and La Condamine among eminent names in rubber.

#### RUBBER IN DESERT MILKWEEDS

A specialized milkweed, *Asclepias subulata*, adapted to extreme conditions in the open deserts of southern California and Arizona, was studied for several years from the standpoint of utilization as a field crop, and a report was published in 1935. The rubber-bearing stems are simple and straight like grass stalks, forming upright tufts 3 or 4 feet tall. The leaves are only rudimentary, hardly wider than pine needles, and soon fall off. The upper figure of plate 14 shows the habit of the wild plants growing in a cactus desert near Superior, Ariz. The plants grow readily from seeds and form abundant shoots from rootstocks creeping below the surface of the soil, as shown in natural size in the left-hand lower figure of plate 14. The right-hand



lower figure shows a planted field with the milkweed behaving like a grass crop, from which successive cuttings could be made.

The rubber content ranged usually from 2 to 5 percent in the wild plants, in exceptional cases reaching 6 percent. The stems have a rather heavy coating of wax and a layer of rather strong bast fibers, to be considered as byproducts; also, the floss from the seeds of milkweeds is reported as being of industrial value. A general difficulty is that the leaves are difficult to harvest, as in the case of the goldenrods already mentioned. Another desert milkweed, *Asclepias erosa*, with very large leaves, was also investigated, as reported in 1938. The leaves were found to contain about 90 percent of the rubber, and the rubber content of the leaves was definitely higher than that of the stems of *A. subulata*, with a mean of 50 determinations showing more than 8 percent and a maximum of 13 percent. Recent observations by Dr. Walter T. Swingle indicate that this species may be adapted to a wider range of conditions than *S. subulata*, and may be better suited to regular cultivation.

#### CRYPTOSTEGIA AS A SOIL COVER

An incident that occurred during rubber experiments in Haiti showed an unexpected cultural relation between two types of rubber-bearing plants, the Para rubber tree and *Cryptostegia grandiflora*, a woody trailing vine of the dogbane family, native in Madagascar. The latex of *Cryptostegia* yields rubber of good quality that was formerly exported from Madagascar. It is one of the plants that was tested by Edison in Florida and is now being tested on a large scale in Haiti and in Mexico as an emergency rubber resource.

A casual planting of *Cryptostegia* near Port-au-Prince was made in a small seed bed previously used for Para rubber, but from which all the Para seedlings had been removed except a few stunted, leafless, and moribund survivors, overlooked or disregarded when the *Cryptostegia* seeds were planted. A vigorous growth of *Cryptostegia* soon covered the ground, so that the stunted Para rubber seedlings were concealed and forgotten. It was a surprise to find a few months later that two plants of the Para rubber, instead of being finally smothered and suppressed by the *Cryptostegia*, were making vigorous growth, with normal, full-sized leaves. It was plain that the *Cryptostegia*, instead of competing with the Para rubber, had served to advantage as a soil cover or nurse crop for the seedlings of the Para rubber.

As the planting was done in a heavy but very shallow soil, a condition definitely unfavorable for open planting of young Para rubber trees, it would have been impossible for these depauperate seedlings to have recovered and grown vigorously if the *Cryptostegia* had not been planted. This favorable reaction seems worthy of further study

to determine the extent of the advantage and the range of conditions under which *Cryptostegia* might contribute in establishing plantations of the Para rubber or other useful trees. The *Cryptostegia* rubber might become a byproduct if suitable methods of extraction could be developed. *Cryptostegia* is not a shade plant and would not be expected to form a continuous canopy of foliage. The use of cover crops in the East Indian rubber plantations had become a general practice in recent years, showing that a very dense shade is not formed.

#### THE AFRICAN RUBBER TREE IN SHELTER BELTS

Another member of the dogbane family, the African rubber tree *Funtumia elastica*, may serve cultural purposes quite distinct from those served by *Cryptostegia*. Shelter belts are often needed in tropical cultures, not only as soil covers and windbreaks, but also for excluding other vegetation. Barriers against grass or other weeds may be very important for fire protection or for other reasons. The behavior of *Funtumia* in Haiti and in Florida shows several adaptive characters that may make it useful for planting with other trees. One of these characters is the formation of a close, continuous leaf crown or canopy of foliage which does not admit enough sunlight to enable plants to grow beneath it, so that grass and weeds are excluded. Projects for reforestation with rubber trees or establishing rubber reserves may be assisted by using borders or barriers of *Funtumia*. Mechanical extraction of the rubber from the bark is likely to prove practicable, as with Castilla, if *Funtumia* should be grown in sufficient quantities for such a process to be developed.

#### A HARDY GUTTA-PERCHA TREE

A hardy tree from central China, *Eucommia ulmoides*, has been studied in several European countries as a potential source of rubber and has been found to thrive in numerous localities in the United States from Massachusetts to California. No lack of hardiness is indicated, but the sexes are on separate trees and relatively few cases of seed production have been reported. At Lanham, Md., seeds are produced in normal seasons, but all the flowers may be killed by late frosts. The seeds are winged and are widely disseminated, but only a few self-sown plants have appeared. Only one volunteer tree has grown well—this in an open place. Tolerance of shade is not indicated.

Latex tubes are not found in *Eucommia*, but a rubberlike substance is formed in small chambers of the bark, leaves, and seed capsules, a substance that dissolves and precipitates with the same chemical reagents that are used with rubber and gutta-percha. The *Eucommia*

gum is like gutta-percha in being tough rather than elastic; it is not at all pasty or sticky, as are many of the near-rubbers.

A peculiar feature of the *Eucommia* gum is that it does not become plastic or adhesive when heat up to the boiling point of water is applied. Though such a property of resistance to heat is of special value in some of the uses of rubber, the lack of cohesion among the rubber particles has prevented the application to *Eucommia* of the processes of mechanical extraction that have been developed for guayule. Extraction with solvents is possible, and samples obtained in this manner leave no doubt that the material is firm, tough, and flexible, but costs may be prohibitive unless special uses are discovered.

#### EUCOMMIA, A TREE THAT NEVER BLOSSOMS

The *Eucommia* tree has features of such botanical interest as to be valuable for purposes of instruction in any institution where botany is taught. All universities or other schools that have tree collections, or even "garden and grounds," should have *Eucommia* branches as "laboratory material." The period of reproduction is in the early spring, when floral botany usually receives attention. The tree is vigorous and handsome, the foliage much resembling that of an elm, as the specific name indicates.

The educational function that *Eucommia* may serve most effectively is to furnish background for all the courses of study that relate to the development of special floral envelopes in the various families of higher plants, the "flowering plants," as they are usually called. The lack of floral specialization in *Eucommia* is most complete and remarkable; there are no organs that can be interpreted as calyx or corolla, or even as a trace or indication that such organs existed previously and have been suppressed. A more primitive state or base line of floral development is hardly to be imagined.

The stamens and pistils, shown in natural size in plate 15, are the only floral organs, and these are green like the leaves, so that nothing in the nature of a blossom in the popular sense is ever to be seen. An alder or a pussy willow has a much more striking "bloom." Not only are floral envelopes lacking in *Eucommia*, but there are no subtending bracts or other indications that a specialized inflorescence ever existed. The stamens and pistils are mounted directly on simple receptacles rising from the axils of the bud scales and the foliage leaves, and from the axils of intermediate leaf forms, between the bud scales and the foliage leaves. Some of these are slender and weak, not developing chlorophyll and soon withering, while others persist through the season as undersized leaves.

At Lanham, Md., the buds were noted as completely dormant on March 9, 1936, after protracted cold weather, but as beginning to sep-

arate and show green color on March 13, when *Corylus* flowers were well advanced, with many empty stamens. The *Eucommia* stamens are deep green and notably accrescent, becoming only slightly yellowish at maturity. A length of 8 to 10 mm. is attained, with the filaments 1 to 2 mm. long, the receptacle 2 to 4 mm. The number of stamens on one receptacle varies from 3 to 10, usually 6, 7, or 8, with 6 as the modal number.

The pistils and fruits are green, those that are not fertilized, or at least not fertile, often persisting with the fertile fruits, not growing as large but retaining a deeper green color. The fertile fruits exceed 4 cm. in length, the infertile 3 cm. The large, straight embryo is enclosed in a hard shell near the middle of the fruit, shown in plate 15. Two collateral ovules develop in the unfertilized fruits to a length of about 3 mm., noted as still living on July 23, when the fertile fruits were nearly full size but immature. The seeds ripen in September or October, but do not fall until a rather severe frost has occurred—in Maryland about the middle of November. The female tree may defoliate 2 or 3 weeks in advance of the male, while the fruits are still in place.

The *Eucommia* tree is now placed by botanists as a monotypic family Eucommiaceae, apart from any other group, after being assigned provisionally to several other families, such as Magnoliaceae, Trochodendraceae, and Hamamelidaceae. The last group, the witch-hazel family, is considered as remotely related.

#### EUCOMMIA SUPPRESSES ALL TERMINAL BUDS

Another special character of *Eucommia*, adding to the educational interest of the tree, is the complete suppression of terminal buds. Each branch or twig of *Eucommia* ends with an internode that develops only a rudimentary bud, concealed in a minute pit in the leaf base. In the absence of a bud, the petiole of the last leaf continues in the direction of the branch, instead of being pushed aside to a somewhat oblique position by the enlargement of an axillary bud, as happens with all the preceding leaves; also, the petiole of the last leaf of a shoot or twig of *Eucommia* is usually longer than that of the adjacent leaves. Such an elongate petiole marked at the base by the pit enclosing the rudimentary bud is shown in natural size in plate 15, extending obliquely at the right of the lower figure.

The term "sympodial" might be applied to the branching habit of *Eucommia*, as to plants where terminal buds are replaced by flowers or by tendrils, but with *Eucommia* there is no replacement, the apical internode being merely deprived of its bud and then appearing as a sterile lateral stub after a new shoot has grown from the subterminal bud.

The suppression of its terminal buds places *Eucommia* in complete contrast with the tropical rubber trees, where specialization is accomplished very largely by suppression of all the lateral buds in the early stages of growth. The simple primary trunk of the Para rubber tree, without any twigs or scars of branches, represents a complete suppression of the vegetative buds, like the trunk of a palm, with only the terminal bud serving for vegetative growth.

#### THE BALATA TREE

The balata tree of South America, first noted in French Guiana by Aublet in 1775, apparently extends through several neighboring countries. It is one of the near-rubbers that seems worthy of being utilized on a much larger scale. The balata gum is similar to gutta-percha, and although not elastic like rubber, is flexible and tough, even when rolled very thin. In the opinion of manufacturers experienced in the use of both gums, balata would have been valued as highly as gutta-percha if regular supplies had been available. Although the balata gum has had commercial status for nearly a century, the tree remains little known, with even its botanical identity still in question. Leaves and fruits of balata from an experiment at Bayeux, Haiti, are shown in natural size in plate 16. The stock may have come from British Guiana. The growth of balata has been reported as very slow, which doubtless is true of the forest trees, but the growth in Haiti was comparable with that of the rubber trees.

The name given by Aublet was *Achras balata*, which Gaertner placed as *Mimusops balata* in 1807, a designation that has been widely used. A different name, *Manilkara bidentata*, appears in Record's new work on "Timbers of the New World," adopted from writers who inferred that Aublet's *balata* was not a native tree in French Guiana, but had been introduced from Mauritius. Such an introduction is not implied in Aublet's statement, which merely associates the Guiana *balata* with a tree previously seen in Mauritius, where Aublet had spent several years. Two localities in Mauritius were noted, but no Guiana locality, which may simply mean that the tree was well known at Cayenne. Aublet's description is brief, but parallel to those of the sapote and the sapodilla, as species of *Achras*.

The similarity of the leaves and flowers of *balata* in plate 16 with those of the sapodilla in plate 18 leaves little doubt that the trees are closely related. They belong to the sapota family, a remarkable group of tropical trees, some of them attaining great size, producing edible fruits, useful latexes, and valuable woods, very heavy, hard, and durable. Some of the famous South American "milk trees," those known as *massaranduba*, also are included; the latex is potable and is reported by many travelers as pleasant and wholesome. The lucuma of Peru,

the sapote of Mexico, the star apple of the West Indies, and the shea-butter tree of Africa are members of the same family, as are also the original gutta-percha trees of the East Indies, *Palaquium*, *Isonandra* or *Dichopsis*.

The balata gum has often been described as intermediate between rubber and gutta-percha. Gutta-percha has been replaced to a great extent by vulcanized rubber, and now by plastics, but the need for balata may be expected to continue. Insulating of the early Atlantic cables was the culminating service of gutta-percha, largely exhausting the natural resources of that gum. Mechanical extraction of gutta-percha from the leaves of cultivated trees is a modern development in the Dutch colonies, and balata may be obtainable either in that manner, or by extraction from the bark, as practiced with guayule and proposed for Castilla. The close-grained, durable woods obtainable from members of this family may feature as byproducts in considering the cultural problems.

#### THE SAPODILLA, OR CHEWING-GUM TREE

One of the near-rubber trees that doubtless will become better appreciated in the future is sapodilla, well known in the West Indies and in southern Florida for its delicious fruit. The same tree, named by Linnaeus *Achras zapota*, grows extensively in the forests of southern Mexico and Guatemala, where most of our chicle or chewing gum has been obtained, though in recent years substitutes have been sought in many countries and also in laboratories.

The chicle trees in the forests grow so slowly that setting out plantations for the sake of the gum has scarcely been thought of, but other elements of interest should not be overlooked in southern Florida or in other tropical countries. The fruits are delicious and wholesome, the trees are magnificent, and the wood is of fine texture, rich color, and amazing durability. The ancient Mayas used carved timbers of *yas*, as they called it, as lintels over the doorways of their temples, and some of these remain in place after many centuries, even in a tropical climate. The abundance of chicle and breadnut trees (*Brosimum alicastrum*) in the forests that now cover the ruins of the ancient Maya cities suggests that the edible fruits of these trees may have contributed to the support of the former population, supplementing field crops of maize, beans, yautias, and sweetpotatoes.

When it grows in open places the sapodilla is a stately tree with densely tufted, deep green leaves, firm-textured and persistent on all the branches, even near the ground. The tree shown in plate 17, the largest known in Florida, grew at Fort Myers in the main street of the town, but was destroyed in a building project of the boom period. The leaves, flowers, and immature fruits of the sapodilla are shown

in natural size in plate 18. The shape of the fruits varies from oval to broadly rounded, or the base may be flattened like a tomato. The fruit has a russet surface, with white or slightly pinkish flesh, much resembling a high-grade pear in color, taste, and texture, even to the presence of stone cells. The texture may be too delicate for commercial handling in storage and shipment, but for home use in southern Florida and in other tropical countries, the sapodilla is one of the finest fruit trees.

#### OUR HOUSEHOLD "RUBBER PLANT"

One of the tropical rubber trees is well known in Europe and the United States as an ornamental. It is the familiar "rubber plant" of our livingrooms, conservatories, and hotel lobbies, with its burnished emerald leaves. The house plants are grown from cuttings of a large fig tree, *Ficus elastica*, frequently referred to as the Assam rubber tree from its original habitat in the forests of northern India.

Growing in an open place, the tree has a spreading habit, with the trunk and lower branches supported by many buttress roots, like the banyan fig of India. A thriving tree of *Ficus elastica* in Florida is shown in plate 19. The leaves on young and thrifty trees are 6 to 12 inches long, like those of our house-plant cuttings, while the leaves of fruiting branches are only 3 to 4 inches long, as shown in natural size in plate 20, with the small cylindrical figs.

Under natural conditions in deep forests the tree is said to be "usually epiphytic, throwing down numerous aerial roots from the branches." As the first commercial rubber tree to be discovered in the East Indies, it was given much attention during a period of years. The trees in the forests were exploited and mostly exterminated, but large plantings were reported in several districts. The results were reported favorably at first, until the plantations of Para rubber brought prices too low. The latex system and the limitations of the manual tapping method are similar to those of Castilla, and the use of mechanical extraction is an alternative that may be considered in the future.

#### TWO RUBBERS IN ONE TREE

The rubber of the Assam fig tree is of uneven quality, often weak and sticky in young trees, and sometimes in older trees. Even in rubber from the same tree perceptible differences may be found. A large tree in Haiti that in a previous year had furnished a sample of good rubber happened to be heavily manured from an adjacent barnyard. On that side the trunk thickened rapidly, and produced a large, heavy branch, out of proportion with the previous development. Only weak and sticky rubber was found in the latex of the new growth, but on

the other side of the tree, where the previous tapping had been made, the rubber still showed good quality. The contrast of the two samples, one elastic and tough, with the surface clean and dry, the other weak and sticky, left no doubt that the quality of the rubber material formed in the latex could be seriously affected by conditions of growth.

SELECTED LIST OF PREVIOUS PUBLICATIONS RELATING TO RUBBER OR TO GROWTH DISORDERS OF PLANTS

(Unless otherwise stated, all papers were written by the present author. Papers in this list are usually referred to in the text merely by dates.)

1900. Rubber cultivation for Porto Rico. U. S. Dep. Agr., Div. Bot. Circ. 28. 12 pp.
1901. Agriculture in the tropical islands of the United States. U. S. Dep. Agr. Yearbook for 1901, pp. 349-368.
- 1903a. The culture of the Central American rubber tree. U. S. Dep. Agr., Bur. Plant Ind. Bull. 49. 86 pp.
- 1903b. Four new species of the Central American rubber tree. Science, vol. 18, pp. 436-439.
1909. Vegetation affected by agriculture in Central America. U. S. Dep. Agr., Bur. Plant Ind. Bull. 145. 30 pp.
1910. A preliminary treatment of the genus *Castilla*, by H. Pittier. U. S. Nat. Mus., Contr. U. S. Nat. Herbarium, vol. 13, pp. 247-279, pls. 22-42.
- 1911a. Dimorphic branches in tropical crop plants: cotton, coffee, cacao, the Central American rubber tree, and the banana. U. S. Dep. Agr., Bur. Plant Ind. Bull. 198. 64 pp.
- 1911b. Notes on southern Mexico, by G. N. Collins and C. B. Doyle. Nat. Geogr. Mag., vol. 22, pp. 301-320.
1913. Nomenclature of the sapote and the sapodilla. U. S. Nat. Mus., Contr. U. S. Nat. Herbarium, vol. 16, pp. 277-285.
1920. A disorder of cotton plants in China. Journ. Heredity, vol. 11, pp. 99-110. Illustr.
- 1923a. Malformations of cotton plants in Haiti. Journ. Heredity, vol. 14, pp. 323-325. Illustr.
- 1923b. Sources of crude rubber. U. S. Dep. Agr., Rep. of Chief, Bur. Plant Ind., for 1922-1923, pp. 28-30.
- 1923c. Possibilities of rubber production. U. S. Dep. Agr., Rep. of Secretary for 1923, p. 51.
- 1924a. Acromania, or "crazy top," a growth disorder of cotton. Journ. Agr. Res., vol. 28, pp. 803-827. Illustr.
- 1924b. Rubber plants. U. S. Dep. Agr., Rep. of Chief, Bur. Plant Ind., for 1923-1924, p. 34.
- 1925a. Rubber. U. S. Dep. Agr., Rep. of Chief, Bur. Plant Ind., for 1924-1925, pp. 21-23.
- 1925b. Tropical America adapted to rubber. U. S. Dep. Agr. Off. Rec., vol. 4, No. 39, pp. 1-2.
1926. Para rubber tree is found at Palm Beach. U. S. Dep. Agr. Off. Rec., vol. 5, No. 39, pp. 1-2, 8.
1927. Rubber plants. U. S. Dep. Agr., Rep. of Chief, Bur. Plant Ind., for 1926-1927, pp. 28-29.



- 1928a. Dr. Ridley of Singapore and the beginnings of the rubber industry, by D. Fairchild. *Journ. Heredity*, vol. 19, pp. 193-203.
- 1928b. Beginnings of rubber culture. *Journ. Heredity*, vol. 19, pp. 204-215.
- 1928c. Early days of rubber experiments. A letter from Dr. Ridley pictures Singapore of thirty years ago. *Journ. Heredity*, vol. 19, pp. 485-486.
- 1929a. Rubber trees thrive in Florida planting. U. S. Dep. Agr. Off. Rec., vol. 8, No. 5, pp. 1, 8.
- 1929b. Rubber plants. U. S. Dep. Agr., Rep. of Chief, Bur. Plant Ind., for 1928-1929, pp. 26-27.
- 1930a. U. S. hunts a way to produce its own rubber. *Washington Daily News*, January 29.
- 1930b. Branching habits of the Hevea rubber tree. *Science*, vol. 71, pp. 386-387.
- 1930c. Rubber plants. U. S. Dep. Agr., Rep. of Chief, Bur. Plant Ind., for 1929-1930, pp. 31-32.
- 1930d. Habits of Hevea rubber trees. 1st Inter-American Conf. on Agr., Forestry, and Animal Ind., Washington, D. C., Rep. of Delegates, pp. 40-41.
- 1930e. The debt of agriculture to tropical America. *Bull. Pan American Union*, vol. 64, pp. 874-887. (Reprinted in *Ann. Rep. Smithsonian Inst. for 1931*, pp. 491-501; also, with title "Tropical America's Agricultural Gifts," in *Mid-Pacific Mag.*, vol. 42, pp. 344-350, 1931.)
1931. Rubber plants. U. S. Dep. Agr., Rep. of Chief, Bur. Plant Ind., for 1930-1931, p. 24.
1932. Study of supply sources of raw rubber. *U. S. Daily*, vol. 7, p. 874.
1933. Rubber content of various species of goldenrod, by L. G. Polhamus. *Journ. Agr. Res.*, vol. 47, pp. 149-152.
- 1935a. Hevea rubber trees in Florida. *Science*, vol. 81, p. 435.
- 1935b. The desert milkweed (*Asclepias subulata*) as a possible source of rubber, by R. E. Beckett and R. S. Stitt, U. S. Dep. Agr. Techn. Bull. 472. 20 pp.
- 1935c. The Maya breadnut in southern Florida. *Science*, vol. 82, pp. 615-616.
1937. Rubber production from Castilla and Hevea. *Science*, vol. 85, pp. 406-407, April 23.
1938. Rubber content and habits of a second desert milkweed (*Asclepias erosa*) of southern California and Arizona, by R. E. Beckett, R. S. Stitt, and E. N. Duncan. U. S. Dep. Agr. Techn. Bull. 604, p. 11.
1941. Naming the cultivated rubber tree *Siphonia Ridleyana*. *Journ. Washington Acad. Sci.*, vol. 3, pp. 46-65, February 15.
1942. Methods of splitting Hevea seedlings, by H. F. Loomis. *Journ. Agr. Res.*, vol. 65, pp. 97-124.
- 1943a. More rubber from Castilla. *Agriculture in the Americas*, January, pp. 7-9. Spanish trans., *La Hacienda*, pp. 297-299, July 1943.
- 1943b. A summary of the literature of milkweed (*Asclepias* spp.) and their utilization, by A. G. Whiting. U. S. Dep. Agr. Bibliogr. Bull. 2, 41 pp. Oct. 15.

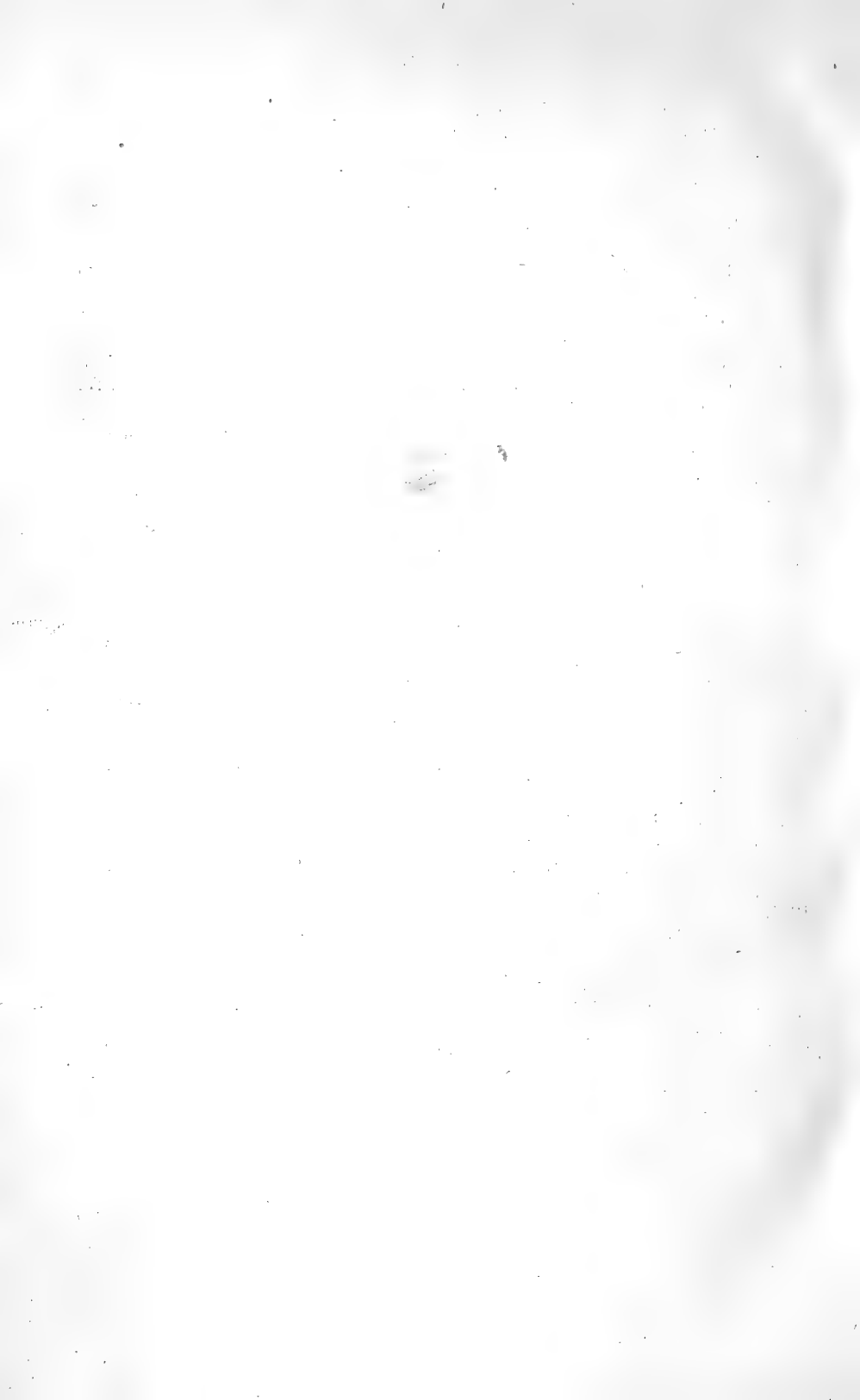



CASTILLA RUBBER TREES IN FOREST FORMATION.

An abandoned Castilla plantation in Panama, with self-sown young trees developing as undergrowth, indicating that self-renewing rubber forests may be established if methods of mechanical extraction of the rubber can be devised.



BRANCHING HABITS OF CASTILLA RUBBER TREES.

The young trees in the foreground have only lateral branches, horizontal or drooping, slender, simple, and deciduous. The older tree, fruiting on its lateral branches, also has strong ascending branches, forming the permanent divisions of the trunk. Trees of fruiting age have an annual leaf fall at the flowering season, but a strong shoot at the left holds its leaves like a young tree.



A CASTILLA TREE WITH SEVERE TAPPING WOUNDS.

Four or five tappings are indicated, although many trees do not survive a second or a third tapping. The creamy, thick latex of *Castilla* often fails to flow, but coagulates in the cuts and is gathered as scrap rubber. The cuts are made more oblique if a flow of latex is expected.

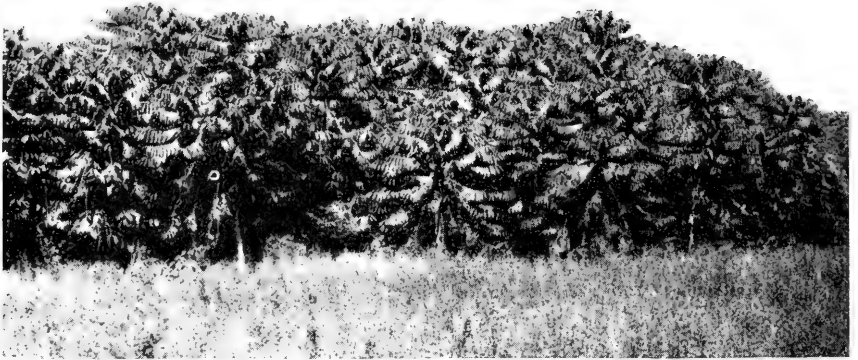

YOUNG CASTILLA TREES WITH SPREADING LOWER BRANCHES.

Upper, a young Castilla plantation in southern Mexico; lower, a close view of a vigorous young tree, one of the branches subtended by a broadly cordate leaf borne on the trunk, different from the oblong leaves borne along the branch.



SPECIALIZED LEAF FORMS IN CASTILLA RUBBER TREES.

A young *Castilla* tree showing three of the specialized leaf forms. The juvenile type is represented by two very large, long-stalked leaves; the trunk type by the much shorter and relatively broader leaf subtending a branch; the branch type by the short-petioled leaves produced in two ranks along the lateral branches.

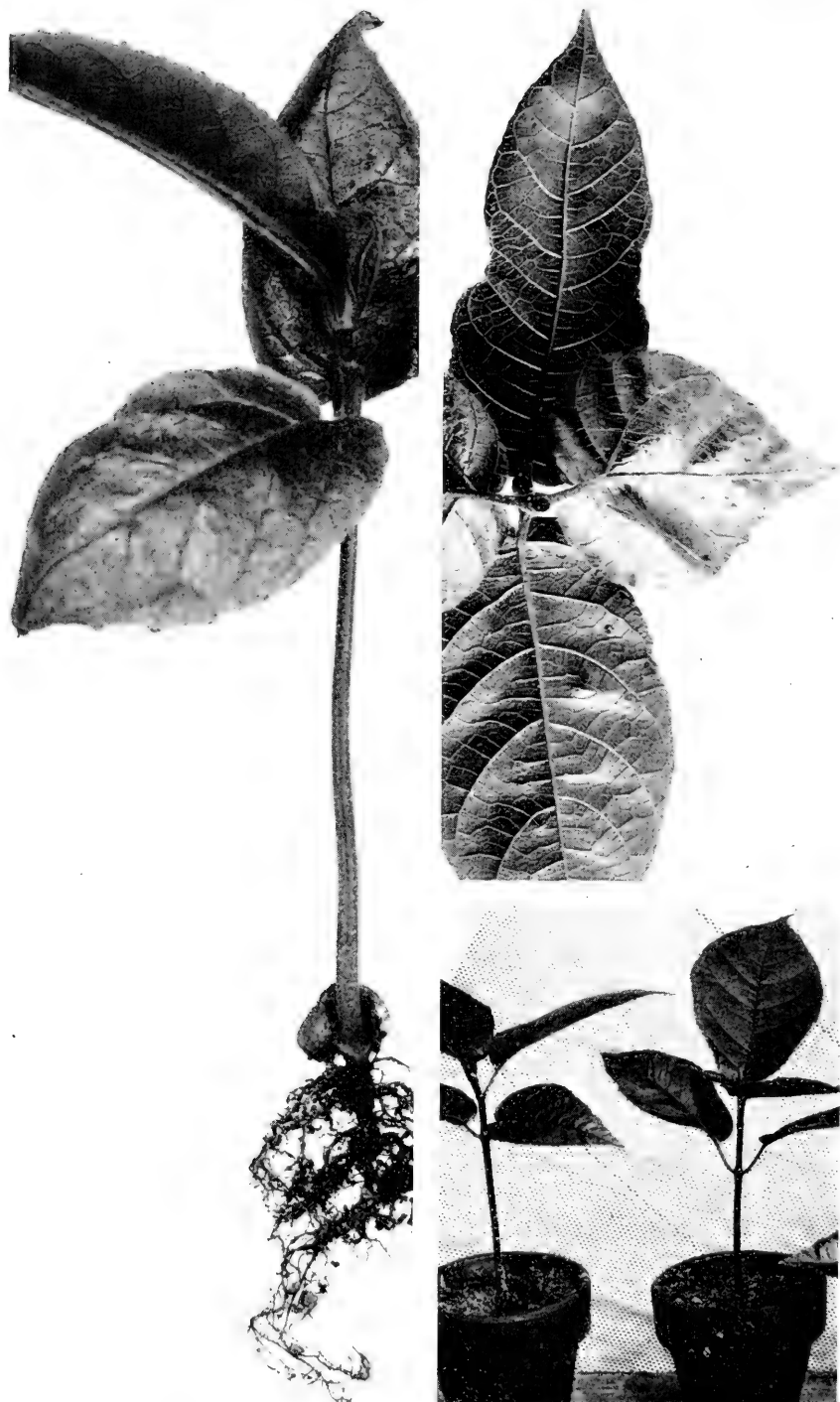

SEEDLING LEAVES OF CASTILLA RUBBER TREES.

Left, a seedling plant natural size, showing subterranean cotyledons and long epicotyl. Right, above, seedling leaves, lower surfaces, the first leaves broadly cordate, the second leaves oblong, with different venation; below, two Castilla seedlings in 4-inch pots, showing that first leaves are opposite and have rather long petioles.



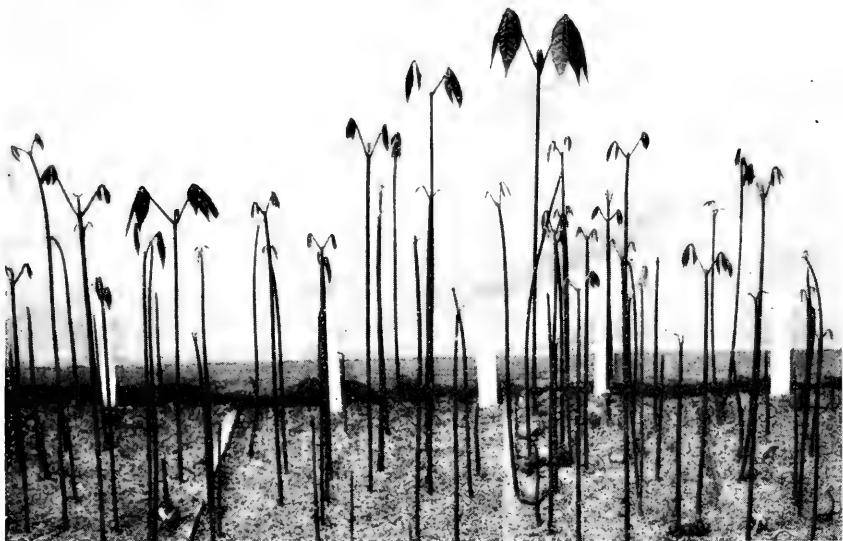

SEEDLINGS AND EARLY STAGES OF THE PARA RUBBER TREE.

The cotyledons are subterranean and the lower joints of the trunk produce no leaves for a foot or more above the ground, where two adjacent joints bear leaves. Larger groups of leaf-bearing trunk sections are formed farther up, with leafless groups between.

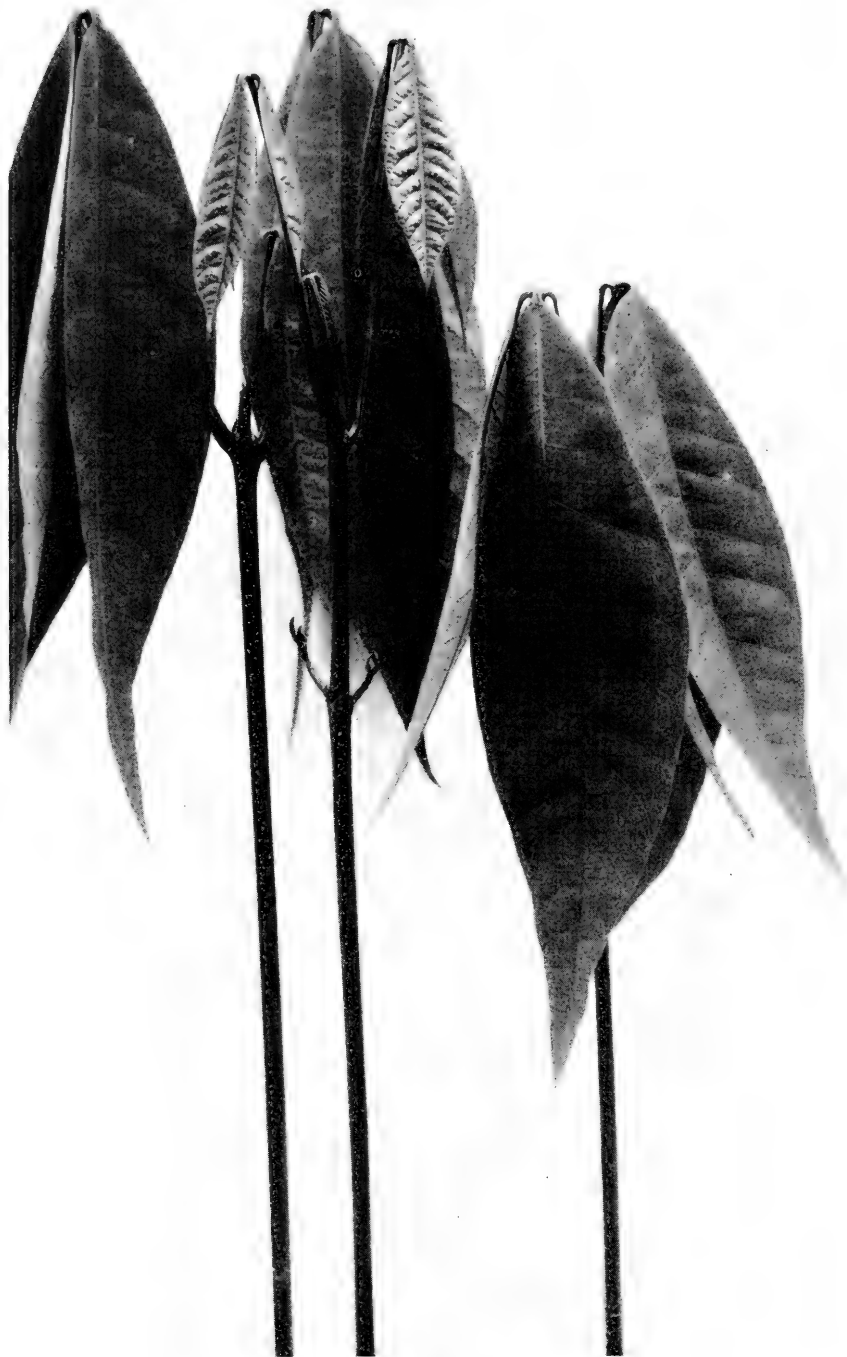

FIRST LEAVES OF HEVEA SEEDLINGS.

Shown in natural size at the stage reached in plate 7 (upper), the lower internodes of the axis not developing leaves. The pinnæ continue in the drooping position to nearly full size, a habit shared with other plants that are specialized to live as undergrowth in tropical forests. The leaves and branches of *Hevea* are not specialized as in *Castilla*.



ABNORMAL HEVEA SEEDLINGS WITH NARROW LEAVES.

A frequent growth disorder, resulting in remarkable diversity of leaf form among the affected plants, most of them stunted and smothered in the seed beds, but a few recovering by abrupt transitions toward normal leaf forms, as in the figure at the left. Right, an example of extreme attenuation of the leaves, abnormal in length and number of veins; natural size, to compare with plate 10



LEAVES AND FLOWERS OF NORMAL AND ABNORMAL HEVEA.

Left, from a normal broad-leaved tree; right, from an abnormal narrow-leaved tree, both natural size. The development of a narrow-leaved tree to maturity is relatively rare, but significant in the study of variation. The flowers of *Hevea* are pale creamy yellow with the odor of lilacs, to which the Brazilian name *seringueira* or *seringueira* may refer.

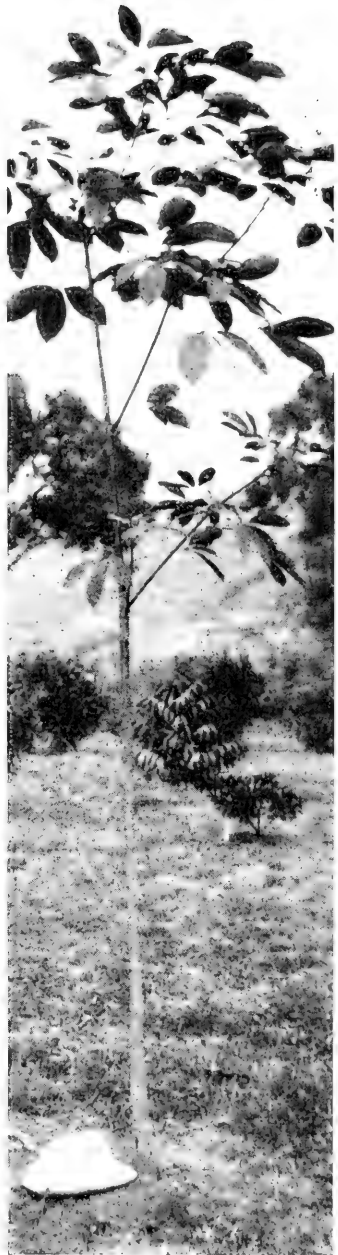

MODIFIED BRANCHING OF HEVEA TREES.

Left, an old *Hevea* stump in Haiti sprouting profusely, although uninjured trees produce no branches near the ground. The sprouts show the normal habit of intermittent growth with several short stem sections forming a "flush" of new leaves, supported by a series of leafless stem sections. Right, a young tree in the Panama Canal Zone, 20 months old in April 1925, with scattered branches a few feet from the ground.



METHODS OF TAPPING HEVEA TREES, NATIVE AND IMPROVED.

Above, tapping with a small ax, the native method in Brazil. The ax wounds do not kill the trees, but the bark becomes too rough for more latex to be collected. Photograph from the Amazon Valley, above Para. Below, method of tapping developed from Ridley's discovery at Singapore of repeated paring of the same wound.



GUAYULE, A RUBBER-BEARING DESERT SHRUB.

Upper, bales of guayule at San Luis Potosi, Mexico, 1902, awaiting shipment to Europe. Lower, left, a guayule shrub, reduced; right, a basal section, natural size. A low, compact, woody shrub scattered through high-altitude desert districts in northern Mexico and in the Big Bend district of western Texas. Rubber is extracted by a process of grinding, retting, and flotation.



A DESERT MILKWEED. *ASCLEPIAS SUBULATA*. CONTAINING RUBBER.

Upper, wild plants growing with cacti near Superior, Ariz. Lower, left, rootstocks and upright stems, natural size; right, experimental cultivation as a field crop. The stems are straight and slender like grass stalks, with minute nonfunctional leaves that soon fall off.





A HARDY CHINESE TREE, *EUCOMMIA ULMOIDES*, CONTAINING GUTTA-PERCHA.

Upper, stamens and pistils, natural size, the stamens grouped on simple receptacles, the pistils solitary in axils of bud scales or of foliage leaves, lacking any specialized floral envelope, either calyx or corolla. The sexes are separate and the tree is placed in a family by itself. It looks like an elm, and is hardy throughout the United States.

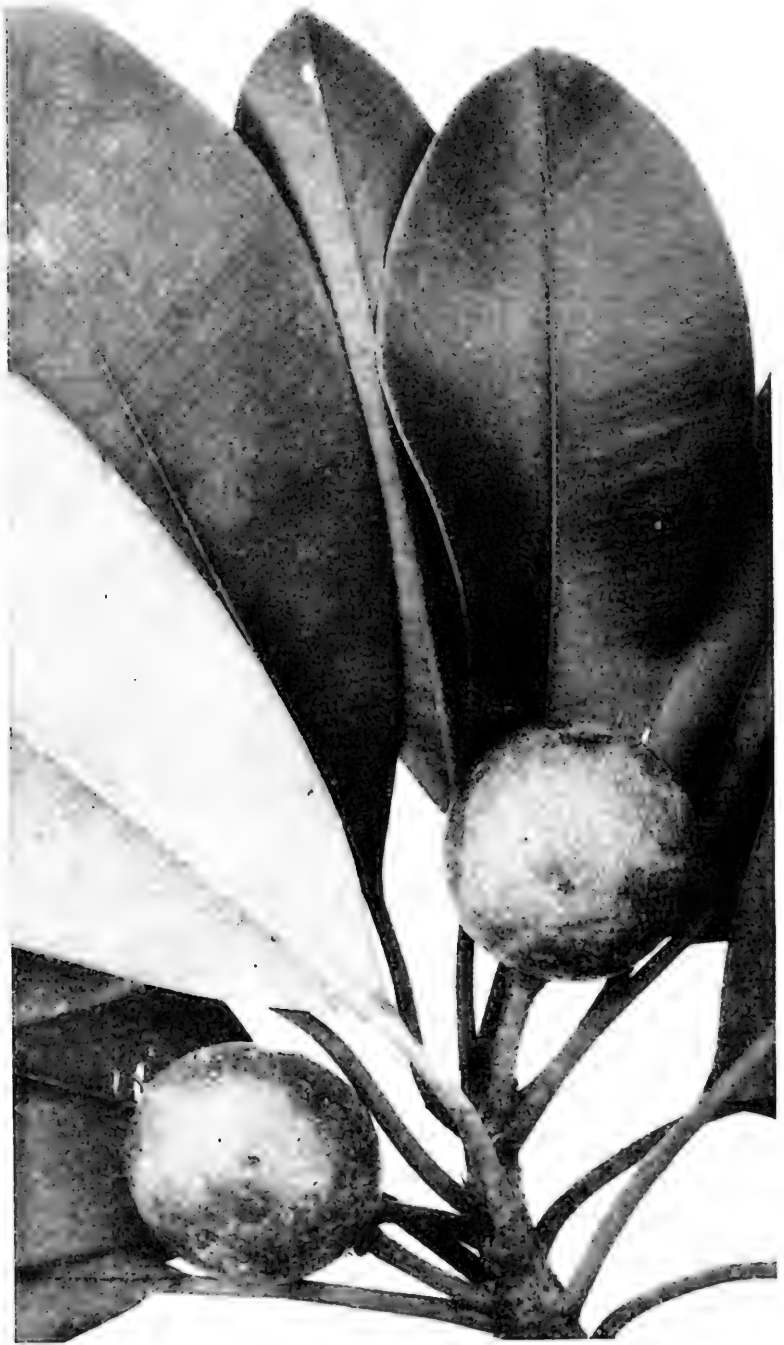

THE BALATA TREE OF SOUTH AMERICA.

Leaves and mature fruits, natural size, from a tree at Bayeux, Haiti. The gum is similar to gutta-percha tough, but not elastic, and has been exported for many years from South America, though the tree is little known.



A SAPODILLA TREE IN FLORIDA.

Native in Mexico and Central America, where the latex is the principal source of chewing gum. Planted in Florida for its fruits, juicy and delicious like high-grade pears. This tree grew at Fort Myers on the principal street but was replaced by a building. The royal palms, possibly 40 years old, may have been younger than the sapodilla tree.

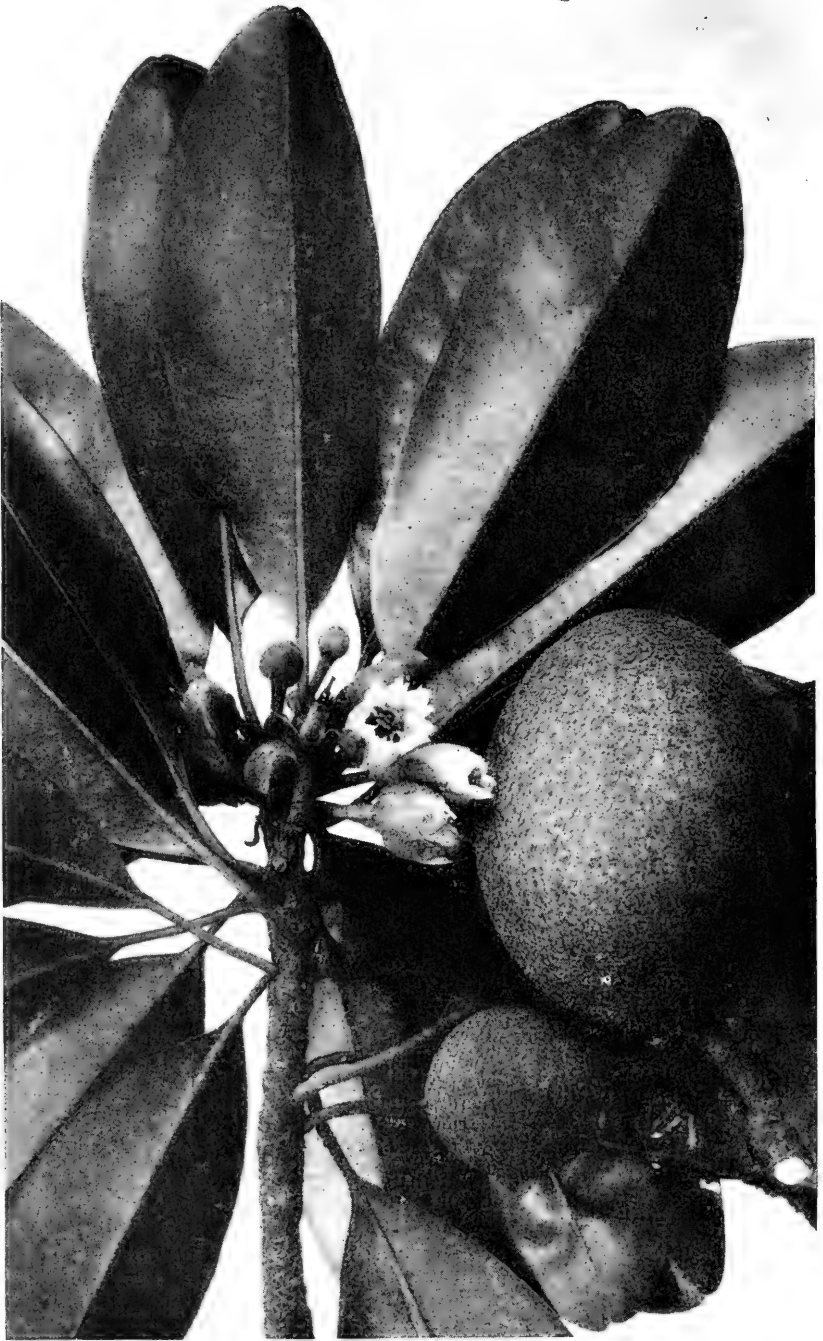

LEAVES, FLOWERS, AND FRUITS OF THE SAPODILLA.

A flowering branch of the sapodilla tree, natural size, showing the tufted leaves of firm texture, with even margins and smooth surfaces, the veins scarcely distinct, the small white flowers, and the russet-brown immature fruits.

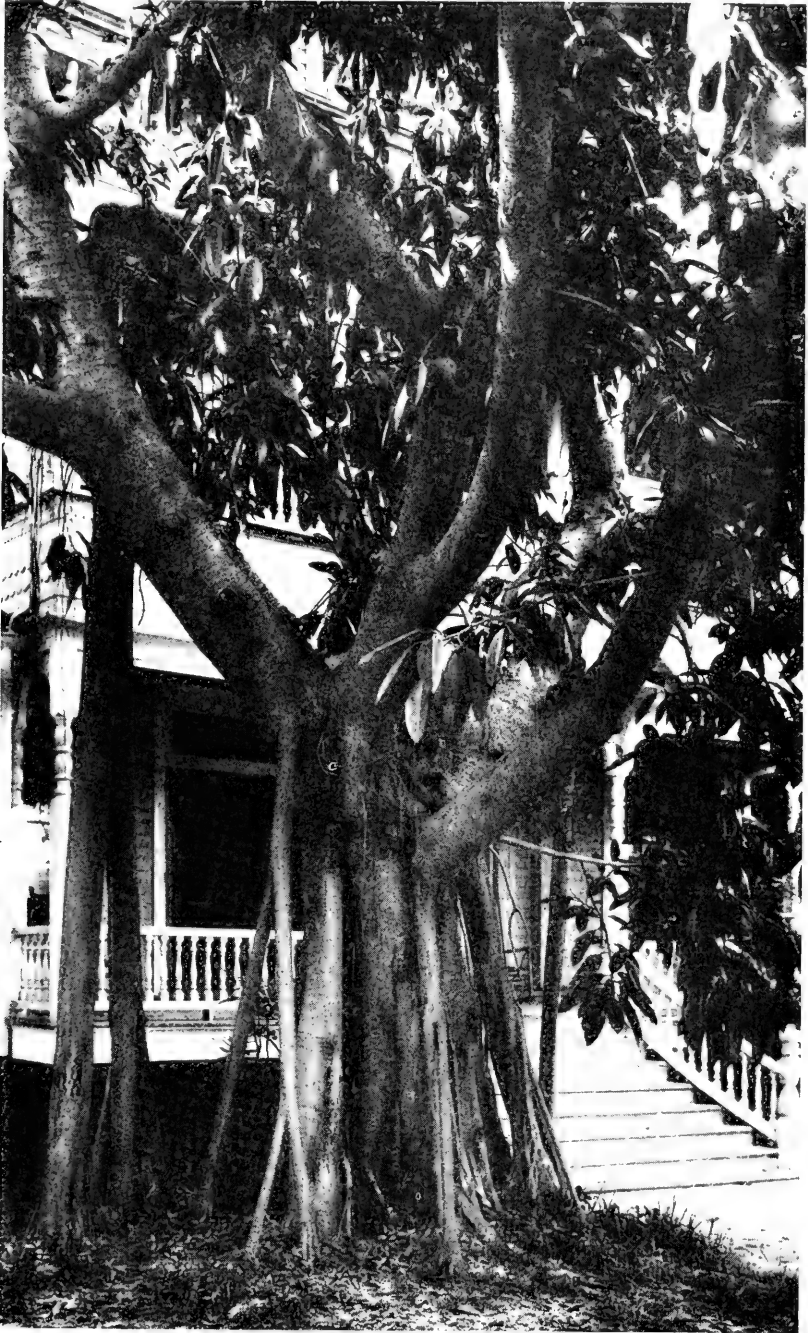

AN ASSAM RUBBER TREE IN FLORIDA.

Our familiar household "rubber plant," a species of fig (*Ficus elastica*) commonly grown from cuttings for decorative use. The tree is native in northern India, but thrives in Florida, the spreading limbs supported on aerial roots, like the banyan fig of India.



FRUITING STAGE OF THE ASSAM FIG TREE.

Leaves and fruits, natural size, from a large tree at Port-au-Prince, Haiti. As with many tropical trees, the leaves are much smaller in mature trees than in juvenile stages. These leaves are only 3 to 4 inches long, while the tree in plate 19 had leaves nearly a foot long.

# LESSONS FROM THE OLD WORLD TO THE AMERICAS IN LAND USE <sup>1</sup>

---

By WALTER CLAY LOWDERMILK

*Assistant Chief, Soil Conservation Service, U. S. Department of Agriculture*

---

[With 4 plates]

Lands of the Old World bear an indelible record written across landscape after landscape by resident populations. The longer the occupation, the deeper is the record written and the easier it is to read the story of man's stewardship of the earth, whether it be wasteful exploitation or use with conservation of the resource. One finds successful adjustments of populations to the land in remarkable terracing and reclamation works, as well as tragedies of land misuse, in gullied fields and alluvial plains, in rocky hills and mountain slopes washed bare of soils, in shifting soils and sands, in silted-up and abandoned irrigation reservoirs and canals, in ruins of great and prosperous cities and in ruins of olive presses and cisterns in desertlike landscapes. The effects of land use through the centuries are cumulative.

In the United States of America, we have in a comparatively short period written far and wide on the face of our country a story of wasteful exploitation and reckless use of abundant natural resources. We have grown wealthy by an economy of exploitation. The time has come with the occupation of all lands of the earth to change to an economy of conservation. It is of timely interest to the New World to read the story of land use as it has been written in the lands of the Old World, that we may profit by the experience of the past in its failures as well as its successes.

Western civilization had its beginnings in the Near East in the alluvial plains of the Nile Valley and of Mesopotamia. Early tillers of soil by irrigation and by selection of food plants produced more food than they themselves required. Surplus food supplies released other members of early societies to engage in useful activities other than food production. Division of labor thus began and increased the command over nature and progress in civilization.

---

<sup>1</sup> Reprinted by permission from Proceedings of the Eighth American Scientific Congress, vol. 5, 1942.

From these far-away lands of the Near East, western civilization has moved westward, until now its vanguard has reached the gleaming billows of the Pacific Ocean that wash the western sands of the Americas. For the first time in the history of the human race there are no more continents to discover, to colonize, and to exploit. The frontiers of new lands are gone forever. The nations of the Americas occupy the last frontier of western civilization.

A survey of land use throughout this westward march of civilization discloses successes and failures in the long use of land. The object of this survey was to profit by failures and achievements of the Old World in our national movement for the conservation of land. This survey covered 28,000 miles of overland travel by automobile from humid England to the margins of the deserts of Sahara and Arabia. Studies were made in consultation with fully a hundred specialists in 124 areas of special interest within 14 countries and dependencies in a period of 15 months of field work.

No attempt is made in this brief paper to account for the destruction or conservation of lands on economic grounds. To profit by the experience of the past it is important to know what has happened to the land after centuries and thousands of years of use. Complexity of causes cannot hide the menace to national welfare in soil erosion and the necessity for setting up national objectives to conserve basic resources of soils and waters in the land. Means of achieving the objectives of conservation will vary in accordance with the genius of peoples and their institutions. Soil erosion, if not controlled, has demonstrated its ability to undermine nations and civilizations regardless of what may have been the social or economic conditions that set it going or stimulated its destructiveness.

The land of special areas was examined for evidences—in changes of the original soil profiles insofar as they could be reconstructed; in the shifting of soils from slopes by erosion; and in the accumulation of sediments on valley floors and plains; in the shifting of sand dunes; in the cutting out of alluvial plains with deep gullies; in the filling of stream channels with erosional debris producing marshy conditions; and in ruins of agricultural works for the control and conservation of waters for domestic and irrigation use; as well as evidences of changes or stability of climate. Furthermore, the fate of the physical body of the soil resource was given more attention in the survey than problems of fertility maintenance. For if the soil is maintained in place, liberty of action in use is assured to succeeding tillers of the soil, in applying more or less fertilizer, in growing this or that crop; but if the soil itself is destroyed, the present and succeeding generations are deprived of their basic heritage.

Throughout this broad expanse of land it became plain that the fate of land under use has been most influenced by slope. The hazard of



soil erosion is low on flat lands, but it is critical on sloping lands. Flat lands have their problems, it is true, in the rise of water tables and in the accumulation of salts, but drainage is usually sufficient. Other problems occur in the formation of sand dunes, for which fixation with vegetation is the solution. But the tiller of soil has met his greatest problem throughout the ages in maintaining cultivation on sloping lands. We found failures and successes throughout this broad expanse of land.

#### ANCIENT PHOENICIA AND SLOPE FARMING

The Near East is believed by archeologists to be the scene of the beginnings of agriculture which made the growth of western civilization possible (11).<sup>2</sup> It is probable that irrigated agriculture preceded rain agriculture. The flat lands of the Nile Valley and Mesopotamia were irrigated before the slopes of ancient Phoenicia were cleared and cultivated. It is probable also that it was on the slopes of the originally forest-clad mountains of ancient Phoenicia that rain agriculture first began, and at the same time the tiller of soil of our western civilization first encountered the hazards of slope cultivation and of soil erosion. It is also probable that the tillers of soil first controlled erosion here with rock walls to terrace sloping lands.

In this connection, we must refer to the remarkable terraces of Peru. I am unaware if the age of the terraces of Peru has been determined. Certainly they were developed by the genius of a resourceful people in great antiquity and independently of the Phoenicians in the Near East, for which they deserve equal praise for a marvelous achievement.

About 5,300 years ago, the Phoenicians migrated from the desert and settled along the eastern shore of the Mediterranean Sea, establishing the harbor towns of Tyre and Sidon, Beyrouth and Byblos. They found their land mountainous, rising to a crest of 10,000 feet and heavily covered with forests, the greatest extent of which were the forests of the famous cedars of Lebanon. These forests became the timber supply for the treeless alluvial plains of the Nile and of Mesopotamia. This conclusion is inferred from inscriptions such as one on the Temple of Karnak, Egypt, placed at 2840 B. C., which announces the arrival in Egypt of 40 ships laden with timber of the cedars of Lebanon (2). Inscriptions found in excavations of Nineveh and of ancient Babylon refer to the use of "huge cedars from Mount Lebanon" in the construction of buildings (9).

In this mountainous land rising boldly out of the sea there was little flat land along the coast. The growing population doubtless soon exceeded the carrying capacity of these restricted flat lands and was

<sup>2</sup> Numbers in parentheses refer to literature cited.

faced with the alternatives of shipbuilding, trade, founding colonies, and the cultivation of slopes. As these slopes were cleared of forests and cultivated, they were subject to soil erosion under heavy winter rains, then as they would be now. The great area of terrace walls in various states of repair indicate that the ancient Phoenician slope farmer sought to retard or control erosion with rock walls across the slope, 40 or possibly 50 centuries ago.

The famous forests of the cedars of Lebanon, which are associated with the rise of civilization in the alluvial plains of the Near East, retreated before the ax and the hoe until today only a few remnants of the original forest of about 1,000 square miles are left. The best known relic is the Tripoli grove of cedars, consisting of about 400 trees, saved from vandalism by a church and from goat grazing by a stone wall. (Pl. 1, fig. 1.) Restocking of this grove within the protection of a stone wall against grazing signifies that under present climatic conditions the forest would spread and grow where soil enough has escaped the ravages of erosion. The disappearance of these famous forests is symbolic of the decline and deterioration of the resources of the country.

Today one may find on the mountains of ancient Phoenicia bare limestone slopes strewn with remnants of former terrace walls, showing that the battle with soil erosion sometimes was a losing fight (13); elsewhere one may find terraces that have been maintained for several thousand years. (Pl. 1, figs. 2 and 3.) Such astounding achievements demonstrate that when the physical body of the soil resource is maintained, it may be cultivated and made productive for thousands of years. Its yield in crops then depends upon its treatment.

The cost in human labor to level terrace slopes of 50 to 75 percent as were found in Beit-Eddine, Lebanon, works out at modern wage scales at 2,000 to 4,000 United States dollars per acre. Such costs are not justified when other lands are available; moreover these costs represent what may and sometimes must be paid in an economy of survival. Such remarkable works demonstrate to what lengths a people will go to survive, as well as the necessity of maintaining the soil resources to support a population. Such examples warn us to find ways of saving good lands before necessity drives a people to such extremes in costs of human effort.

#### A "HUNDRED DEAD CITIES"

Syria holds some of the grandest ruins to be found in the ancient world, such as Baalbek and Jerash. But to a soil conservationist the most striking ruins are found in the graveyard of a "hundred dead cities." (Pl. 2, fig. 3.) An area of about a million acres in North Syria lying between Aleppo, Antioch, and Hama exhibits soil erosion

at its worst. Here are ruins of villages, market towns resting on the skeleton rock of limestone hills, from which 3 to 6 feet of soil have been swept off. Evidence of the depth of soil eroded from these slopes is found in doorsills of stone houses now 3 to 6 feet above the bare rock.

Here soil erosion has done its worst and spread a ghastly destruction over a formerly prosperous landscape, as judged by the ruins of splendid houses in villages and in cities, such as at El Bare, which we examined in the summer of 1939. In reality, these cities are dead, with no hope of resurrection; for the basis of their prosperity is gone. These cities have not been buried, but have been left high and stark by the removal of soil through the irreversible process of erosion. The good earth of terra rossa soils is completely gone from the slopes except in patches where it is held back by walls of ruined buildings or in pockets in the limestone. In these patches a few vines and olive trees stand as sad remnants of a former profitable use of land, which provided exports of olive oil and wine to Rome during the empire. Seminomads now inhabit repaired ruins in a few of the former cities.

As one travels in the desolation of this man-made desert today, amid the barren limestone hills once forested before they were converted to cultivated fields, I was moved by continuous astonishment to find ruins of dead cities which gave every evidence of former prosperity and well-being. (Pl. 2, fig. 1.) While buildings of some cities are tumbled amid their masses of overturned blocks, those of other cities stand upright, showing facades, towers, arches, and walls of convents and cathedrals, as well as details of houses, villas, shops, stores, public baths, hotels, and superb tombs such as those at El Bare. This area was flourishing from the third to the seventh century, without sign of decadence. The invasion of the Persians in 614 and the Arabs in 630 decimated the inhabitants, blotted out their culture, destroyed their cities, and even the traditions of their agriculture.

Today, after 13 centuries of neglect, of terraces overrun by herds and patch cultivation of grain by seminomadic descendants of the invaders, soil erosion has completed the destruction of the good earth with a thoroughness that has left this formerly productive land a man-made desert, generally void of vegetation, water, and soil. The cities could be made habitable again, but they will remain dead forever, because their soils are gone beyond hope of restoration. Here the "unpardonable sin" of land use has been committed.

#### THE "PROMISED LAND" OF PALESTINE

When Moses stood on Mount Nebo and looked across the Jordan to the "Promised Land" about 3,000 years ago, he described the land to his followers as a "land of brooks of water, of fountains and depths that spring out of valleys and hills; a land of wheat, and barley, and vines,

and fig-trees and pomegranates; a land of oil-olive, and honey; a land wherein thou shalt eat bread without scarceness, thou shalt not lack any thing in it; a land whose stones are iron, and out of whose hills thou mayest dig brass" (1). The "Promised Land," as it is today, is a sad commentary on man's stewardship of the earth.

The "Promised Land" which 3,000 years ago was "flowing with milk and honey" has been so devastated by soil erosion that the soils have been swept off fully half the area of the hill lands. The soils have been washed off the hills into the valleys (pl. 2, fig. 2), where they are sorted: the finer particles are swept out in flood waters to change the beautiful blue of the Mediterranean to a dirty brown as far as the horizon; the coarser particles are spread out on former alluvium where they are still cultivated but in a progressively reduced area. Accelerated run-off from barren slopes continues to cut gullies through the alluvial valleys and to carry erosional debris out to choke up the channels of streams flowing through the coastal plains.

In times past, such erosional debris together with sand dunes blown in from the coast created marshes in the plains; then malaria came in, practically depopulating the lowlands. The hills also have been greatly depopulated as shown by the studies of Dr. Guy (5). A survey of ancient village sites abandoned and now occupied discloses how the hill lands of Palestine have been depopulated since the seventh century. The watershed of Wadi Musrara of 312 square miles draining the western slope from Jerusalem to Tel-Aviv was divided into three altitudinal zones: (1) the plain, 0-100 meters; (2) the foothills, 100-300 meters; (3) the hills, 300 meters and over. In the plains outside marshy areas, 32 sites are now occupied and 4 abandoned; in the foothills, 31 occupied and 65 abandoned; and in the hills, 37 occupied and 127 abandoned. The break-down of ancient terrace walls and the erosion of soils to bedrock on the upper slopes is sufficient reason to account for the reduction in population. Erosion in the hills as well as marshes with malaria in the coastal plain has been sufficient to reduce the population of the "Promised Land" to one-third of the Roman and Byzantine period.

Palestine can never be restored to its original condition as the "Promised Land"; it can be much improved over its present condition as the splendid works of the Jewish colonies on 5 percent of the total area have demonstrated, but the lands have been so devastated by the irreversible process of soil erosion in the uplands that they can never be restored to their original productivity as the "Promised Land"—it is too late. This case brings home the tremendous lesson that sloping lands may be damaged beyond full restoration; that unless suitable measures are taken in time, land resources are reduced in the face of increasing populations with their augmented demands.

The recent movement of Jewish colonization to redeem the wasted lands of Palestine is an excellent example of what can be done, but at great cost. (Pl. 1, fig. 4.) Works of reclamation of swamps and of reforestation of barren rocky slopes cost more than can be justified as commercial investments in land. The insidious nature of erosion is here made apparent. It reaches a point where the value of the lands will not justify their restoration as an investment for profit. This work can be justified only on the basis of survival of a people. Such expenditures fall into the category of national defense against a ruthless invader or destroyer; for land is the basis of life of a people.

#### ROMAN AFRICA

North Africa bristles with astounding ruins of opulent and populous cities and of thousands of villages and works of the Roman epoch. (Pl. 2, figs. 4 and 6.) A century or more after the destruction of Carthage by Scipio in 146 B. C. Rome began to colonize North Africa and in the course of time established several important and stately cities at the sites now known as Tingad, Sbeitla, Tebessa, Jemila, El Jem, and Lambesis. These cities were established at cross-roads and along the southern edge of the great agricultural region, devoted principally to the growing of grain and olives.

The Roman city of Thydrus, at the present site of El Jem, was located in the midst of the great coastal plain of Tunisia. The most conspicuous remnant here is the ruin of a great coliseum to seat 60,000 spectators, which was second in size only to that at Rome. (Pl. 2, fig. 5.) Now a wretched village stands on the site of this great Roman city. This center was supported by intensive agriculture of grain fields and olive orchards; now this plain is sparsely covered with wild vegetation and isolated groves of olives overrun by herds of grazing animals.

The Roman city of Thamugadi, at the site called Tingad in Algeria, was one of the more famous centers of Roman power and culture. It was established by Emperor Trajan about A. D. 100 and was laid out in symmetrical pattern, equipped with a magnificent forum embellished with statuary and carved porticoes, with a public library, with 17 Roman baths adorned with beautiful mosaic floors, with a theater to seat some 2,500 and with marble flush latrines. Tingad was a stately city supported by extensive grain fields in the valley plains and olive orchards on the hills.

After the weakening of the Roman power by the Vandal invasion in A. D. 430 the Berbers captured the city, and after the Arab invasion of the seventh century it was lost to knowledge for 1,200 years, buried by dust, the product of wind erosion. Only a few columns and a portion of Trajan's arch stood above undulating mounds as

tombstones to indicate that once a great city was here. There is no counterpart today of the magnificence of this ancient city. A wretched village of mud-wall houses sheltering a few hundred inhabitants is the only descendant of this center of Roman power and culture. Water erosion as well as wind erosion has been at work on the landscape. Gullies have cut through portions of the city and have exposed the aqueduct which supplied the city with water from a great spring some 3 miles away.

Ruins of the land are as impressive as the ruins of cities. The hills have been swept bare of soil, a story which may be read throughout the region. The original soil mantle is being washed off the slopes, often showing that the upper edge of the soil mantle is being gradually worked down slope by accelerated run-off from the bared upper slopes. Erosional debris has been deposited on the lower slopes and valley plain. Torrential storm waters cut great gullies into the alluvial plains. Water tables are lowered and rain waters quickly flow off the land leaving it dry and thirsty. The effects of desiccation of the land are brought about even if rainfall has not diminished.

Out toward the Sahara, 70 miles south of Tebessa, were found ruins of remarkable works for conserving and spreading storm run-off. Check dams were constructed to divert storm waters around the slopes and to spread them on a series of terraces, dating back to Roman or pre-Roman times. Why these terraces were constructed is not yet known. At any rate the French Government is rebuilding the works and is spreading storm waters out on these terraces to increase forage growth for the herds of the Arab nomads. These works of water conservation out so near the Sahara Desert might indicate that climate has changed or that all good lands were intensively utilized during the Roman epoch. All North Africa, as indicated by such a vast display of ruins and works in the midst of a sparsely settled and depressing land, must have had an agriculture of remarkable refinement in measures of soil and water conservation.

The striking contrast between the prosperous and populous condition of North Africa in Roman times and present decadence led early students to believe that an adverse change of climate was responsible for the decline of the granary of Rome. But the researches of Gsell (4), Gautier (3) and Leschi (7) discount an adverse change in climate since Roman times (6 and 10). The most telling evidence of unchanged climate in the past 2,000 years is the successful plantation of olive groves on the sites of ruins of Roman stone olive presses. An experimental grove planted at Timgad by Director Godet demonstrates that olive orchards would thrive today where soil still remains on slopes. The great plantation of more than 150,000 acres in the vicinity of Sfax, Tunisia, which now supports thriving enterprises at

Sfax, also discredits the change of climate theory. Moreover, in the vicinity of Sousse, Tunisia, there are a few Roman olive orchards which escaped the destructive invasions of the seventh century and survive to the present day. No pulsations of climate have been sufficiently adverse to kill off this remnant of the agriculture of Roman times.

The astounding decline in agriculture of the Near East and North Africa is not due primarily to adverse climatic change (14 and 12). It was begun by successful invasions of desert nomads during the seventh century and completed by soil erosion. This remarkable invasion, which not only destroyed a civilization, but its agriculture and, more important, the traditions of its agriculture, is another instance of the age-old struggle between Cain and Abel, between the shepherd and the farmer, between the tent dweller and the house dweller. The desert has always produced more people than it could feed. Farmers built up thriving cultures in the alluvial plains. From time to time the hungry tent dwellers swept into the valleys, when defenses were weak, and destroyed and robbed, sometimes passed on, and left destruction and carnage in their path. At other times they replaced the former population to become farmers and city dwellers themselves, only to be destroyed by another invasion of hungry denizens of the steppes or deserts.

These nomad invaders and their herds unleashed the forces of soil erosion by water and by wind which through centuries have reduced the capacity of the land to produce or to be restored to its former productivity, except in some alluvial valleys. The achievement of conservation of land resources by long and tedious methods was nullified by ruthless invasions and wars.

Such are some instances of the decline in the usefulness of the land due to the wastage of erosion and quickened run-off of storm waters, by the break-down of measures arrived at by long and slow experience of trial and error. The wisdom of the ages was nullified in a brief time, breaking into fragments the glories of the past.

It is also fitting to examine some of the recent works to reclaim lands damaged by inconsiderate and reckless use in the past.

#### RECLAMATION OF MARSHES

The climate of the Mediterranean sets the stage for land destruction by erosion if special precautions are not taken in cultivated fields and on grazed slopes. Heavy rains occur generally as erratic storms during the winter months—October to April. The remainder of the year is rainless and hot.

Where bold mountain ranges are bordered by comparatively broad coastal plains, as in Italy, Greece, Palestine and Algeria, cultivation of slopes unprotected by rock-wall terraces has induced serious soil

erosion. Eroded soils and debris have choked up stream channels in the plains, converting these coastal plains into marshes. Malaria made the lowlands pestilential, weakened or practically depopulated extensive populous areas.

Such is the history of the Pontine Marshes in Italy, whose reclamation is an outstanding example of the application of the modern sciences of medicine, engineering, and agriculture to such problems. The Pontine Marshes were once well populated if we are to accept as evidence remains of 16 cities which predated Roman occupation. Following the rapid rise of Rome from the eighth century B. C., cultivation of the slopes of the Apennine Mountains took the same course as it did in Phoenicia. By the fourth century B. C. Appius Claudius undertook to drain the marshes, which had become a problem (pl. 3, fig. 1). He was unsuccessful in reclaiming these pestilential Pontine Marshes as were his successors, Julius Caesar, Trajan, and Theodoric, and later on a number of Popes, especially Pope Pius VI. But in 1931 the Government of Italy undertook the reclamation of this age-old problem of Rome and Italy with military thoroughness as for a battle. Within 2 months the swamps had been drained and within 6 months farms had been laid out, concrete farmhouses built, and the town of Littoria fitted out with all necessary public buildings, centers, and residences as a service town to more than 100,000 acres of reclaimed land (pl. 3, fig. 2). In this time, 260 miles of roads were built, nearly 6 million cubic yards of dirt were moved to make 1,097 miles of canals.

This is a splendid achievement; 7 years prior to our visit (1938) this thriving area was a deadly marsh, impassable to man and beast alike; only water buffalo were able to survive. During this period approximately 363 million dollars were spent by Italy on public works. An additional amount of about 124 million dollars was granted to private landed properties for reclamation work. More than a third of the total expenditure was made to assist private landowners to prepare their lands for subdivision and colonization.

The justification of such great expenditures is the fundamental importance of the nation's welfare, looking to self-sufficiency in agricultural crops. Investments of public funds for making lands productive for settlement of farm families also served the purposes of giving employment to thousands of unemployed, of settling people from congested industrial centers on the land, and of increasing the productive wealth of the nation as a whole.

#### CONTROL OF TORRENTIAL FLOODS

Population pressures in Italy of 836 and in France of 547 per square mile of cultivated area have exceeded the carrying capacities of the flat lands and have pushed the cultivation line up slopes in the Alps



to steep gradients as forests were cleared away. These mountains had been sculptured by glaciers of the Ice Age into deep gorges bordered by hanging valleys, which set the stage for torrential debris floods as slopes were cleared of forests for cultivation or heavily grazed.

France and Italy have been engaged for many years in the control of debris floods in mountain valleys. France has carried out for 60 years a comprehensive program of works, with notable achievements. The experience of 60 years of such works is especially valuable in meeting the increasing hazards of floods in mountainous areas of the New World. Debris floods bury fields, orchards, and villages in valley floors, interrupt communication, and destroy livestock and human life. Losses over the past century have reached enormous figures and have stimulated brilliant engineering and remarkable measures of erosion control and revegetation.

Correction of mountain torrents is most economically and effectively carried out as a gigantic chess game. It is man against nature, where man may perchance delay the inevitable long enough for his purposes. It takes time and daring as well to play this game, in addition to minute study of natural forces at work. As the torrent-control engineer builds each structure he waits to observe the responses of natural forces. These in turn determine his next move, whether to build another structure, or reinforce existing works, until in due time he is successful in checkmating torrential floods. The high costs of the control of torrents are justified by the protection of valley lands from damage, by the reduction of debris accumulations in stream channels, as a safeguard against rising water tables and marshy conditions in high-value alluvial lands, and by saving life.

Two essential principals are followed in all torrent-control works: establishment of base levels of cutting in torrent channels with permanent check dams, and revegetation of the catchment area. Similar work has been done in Bavaria in southern Germany, but it was not possible for me to continue the projected survey into Germany because of the outbreak of war in that fateful September.

#### FIXATION OF SAND DUNES

Problems of water-erosion control are most common on sloping lands, but those of wind-erosion control most often occur on flat lands. Sand dunes have been formed in semiarid regions by the sorting effect of wind erosion of cultivated lands. The wind sorts dry soils, lifting the fine and fertile particles to blow them away in dust clouds, whereas the heavier particles as sand are left behind to form hummocks and finally active sand dunes. Usually former farm lands of the Old World so damaged have been abandoned and left to their fate (8).

In southwestern France the government has carried out the classic and greatest achievement in the fixation of a vast area of a "moist

Sahara" of sand dunes. A great pestilential sore spot in France, where dwelt poverty, malnutrition, and despair before the merciless march of gigantic sand dunes, was converted into a beautiful and productive forest and into a region of health resorts and prosperity. The destructive invasion of the Vandals in A. D. 407 set sand dunes on the march. By Napoleon's time they had covered 400,000 acres and had buried forests and farm villages, and dammed up the streams, causing a great area of coastal plain to overflow. Marshes brought in malaria, which diminished and weakened the resident population.

Work of fixation and control was begun by Bremontier in 1786 under the command of Napoleon. Reforestation of the dunes was made possible by creating a great littoral dune. This was done by means of a movable palisade of planks which were successively pulled up as the dune crest was raised. In time a dune was built up along the coast whose windward slope reached a grade too steep for the winds longer to blow sand over it. Thereupon, the slopes of the dune were fixed with sand grasses. Reforestation to the leeward and streams were thus safeguarded from further advance of dunes. Following the fixation of dunes, drainage of  $2\frac{1}{4}$  million acres of lowlands was made possible under the direction of Chambrelent. By 1865 this memorable task was completed.

One dune, near d'Arcachon, however, was left uncontrolled for some reason (pl. 4, fig. 1). It is 2 miles long,  $\frac{1}{2}$  mile wide, and 300 feet high and is advancing on the forest at the rate of 60 to 65 feet a year. This active dune serves as a comparison of the present reclaimed dune area and gives some idea of the magnitude of the achievement of converting a devouring menace affecting  $2\frac{1}{2}$  million acres of land into a healing resource. It is estimated that the return from the resin crop alone from the pine plantations has been sufficient to pay off all the original costs of this classic example of reclamation of sand dunes and pestilential marshes.

#### CONQUEST OF THE SEA FOR LAND

Conservation and utilization of natural resources is the striking lesson gained from Holland. Few nations have done so much with what little they have. Among the masterpieces of land reclamation, The Netherlands has achieved wonders in dewatering the ocean and transforming hundreds of thousands of acres of ocean floor into productive farm lands. Holland, with 2,500 persons to the square mile of cultivated area, required more land. She chose a policy of reclamation instead of conquest. When the present Zuider Zee project is completed, more than 550,000 additional acres, formerly inhabited by fish, will be occupied by people. In 1939 we saw farmers plowing the land, 13 to 16 feet below sea level, over which the salt fishermen had plowed the waves only 6 years before. (Pl. 4, fig. 3.) We watched

the farmers threshing their huge stacks of grain, which resembled African villages on the landscape (pl. 4, fig. 2).

Hollanders are experts in the use of land and the control of water. Since early times, picturesque Dutch windmills have drained the otherwise useless lowlands and lifted drainage water into canals to empty into the ocean. Since the completion of the huge 26-mile ocean dyke across the outlet of the Zuider Zee, Holland has conquered her thousand-year-old enemy, the North Sea, and has provided her people with a much-needed sweet-water lake, new agricultural lands, and better transportation. The Dutch take an artistic pride in the excellence of the crops of their native soil; their farms and forests are models in management. This conquest of the soulless sea has carried with it none of the destructive horrors of modern war and has cost much less. The hope of the world in conservation rather than in destruction is made realistic by this masterpiece of reclamation.

#### THE INSIDIOUS NATURE OF EROSION

Our studies in lands long occupied by man disclose that soil erosion, i. e., man-induced erosion as distinguished from normal geologic erosion, is an insidious process that has destroyed lands and undermined progress of civilization and cultures. Achievements in the control of soil erosion and in adjustments of a lasting agriculture to sloping lands are steps in the march of civilization as momentous as the discovery of fire and the selection of food plants.

Solutions to problems of population pressure have too often in the past been sought in the conquest and destruction of the works of peoples rather than in conservation and improving the potential productivity of the earth, with provision for exchange of specialty products. The formula of exploitation and destruction has interrupted the orderly solutions to land-use problems in the past and has unleashed the forces of erosion to spread like the tentacles of an octopus through the lands of North China, North Africa, Asia Minor, and the Holy Lands, as well as in the United States and other countries of the New World.

One generation of people replaces another, but productive soils destroyed by erosion are seldom restorable and never replaceable. Conservation of the basic soil resource becomes more than a matter of individual interest; it becomes a matter of national interest necessary to the continuing welfare of a people. The day is gone when lands may be worn out with the expectation of finding new lands to the west. The economy of exploitation must give place to an economy of conservation if a people will survive into the unknown future. Peace among nations must rest upon such a policy.

In face of the limited area now available to the human race, the realization that enormous areas of land are still being destroyed by inconsiderate and wasteful methods must arouse thinking people to action. If man is making deserts out of productive lands, it is a matter not only of national, but of world-wide concern.

If Moses had foreseen how soil erosion induced by inconsiderate use of land would devastate the "Promised Land," as well as vast areas of the earth, resulting in man-made deserts and decadence of civilizations; if he had foreseen the impoverishment, revolution, wars, migrations, and social decadence of billions of people throughout thousands of years because of the exploitation and desolation of their lands by erosion, he doubtless would have been inspired to deliver an Eleventh Commandment to complete the trinity of man's responsibilities—to his Creator, to his fellow men, and to Mother Earth. Such a Commandment should read somewhat as follows:

Thou shalt inherit the holy earth as a faithful steward, conserving its resources and productivity from generation to generation. Thou shalt safeguard thy fields from soil erosion, thy living waters from drying up, thy forests from desolation, and protect thy hills from overgrazing by thy herds, that thy descendants may have abundance forever. If any shall fail in this stewardship of the land thy fruitful fields shall become sterile stony ground or wasting gullies and thy descendants shall decrease and live in poverty or perish from off the face of the earth.

Hitherto, mankind in its conquest of the land, except in very limited areas, has not been governed by such an injunction; on the contrary, mankind has been impelled by an economy of exploitation, looking to the discovery of new lands or new sources of food and materials as needs arise. The lands of the world are occupied and such a policy leads inevitably to conflict.

The solution of such conflicts in the past has been sought generally in a formula of war with destruction of property, works, and human lives as means of arriving at agreements. As this paper is being written fully half the human population of the earth, more than a billion human beings, have as their most absorbing purpose to destroy the achievements and works of generations and the annihilation of populations, soldiers and civilian men, women, and children. Civilization is committing suicide.

Sooner or later peoples engaged in modern warfare will become weary and exhausted by this hellish frenzy of destruction and carnage. Mankind may then be prepared to accept an alternative—a substitute for destruction in the conservation of the earth's resources, in maintaining and improving necessary supplies. Under scientific conservation, the earth will produce beyond the dreams of mankind.

Besides, the formula of destructive exploitation has failed miserably to solve problems of growing populations; it has only set back the same problem to come forth again with more insistence. The

fate of lands devastated and despoiled by erosion, which is most often associated with war or conquest, stands as a warning to mankind to change from an economy of exploitation to an economy of conservation—of healing and saving conservation.

We must be fully prepared to defend our sovereignty and liberty of action against all aggressors. At the same time, the Americas are best situated to make the principle of conservation realistic in the use of land resources. Thus interpreted and reduced to works of saving soils and waters on the land as necessary to the conservation of human resources and values, the principle of conservation may be compelling and enticing enough to turn a war-weary world from a suicidal frenzy of destruction and carnage to a saving and healing conservation. The lands of the earth will record the decision of mankind as to this momentous question.

## LITERATURE CITED

1. BIBLE.  
Deuteronomy VIII, 7-9.
2. BREASTED, JAMES H.  
1906. Ancient records of Egypt, vol. 1, p. 146. Chicago.
3. GAUTIER, E. F.  
1935. Sahara, the great desert, pp. 95-99. Translated by D. F. Mayhew. New York.
4. GSELL, STEPHANE.  
1913. Histoire ancienne de l'Afrique du Nord, vol. 1. Paris.
5. GUY, P. L. O.  
Unpublished notes.
6. KNIGHT, M. M.  
1928. Water and the course of empire in North Africa. Quart. Journ. Econ., vol. 43, pp. 44-93, November.
7. LESCHI.  
Unpublished reports.
8. LOWDERMILK, W. C.  
1939. Field notes.
9. LUCKENBILL, DANIEL D.  
1927. Ancient records of Assyria and Babylonia, vol. 1, pp. 98, 194 f. Chicago.
10. MARTONNE, EMMANUEL DE.  
1930. La degradation de l'hydrographie. Scientia, vol. 47, pp. 9-20, January. (See p. 19.)
11. PEAKE, HAROLD J.  
1933. Early steps in human progress. Philadelphia.
12. PLAYFAIR, SIR ROBERT L.  
1877. Travels in the footsteps of Bruce in Algeria and Tunis, p. 155. London.
13. THOUMIN, R. L.  
1936. Geographie humaine de la Syrie Centrale, p. 125. Paris.
14. WOOLEY, C. LEONARD, and LAWRENCE, T. E.  
1914-1915. The wilderness of Zin (archaeological report). Palestine Exploration Fund. London.

of the...  
of the...  
of the...

and liberty...  
the...  
to work...  
to the...  
of conservation...  
to a saving and...  
the...

of the...

of the...

of the...

of the...

of the...

of the...

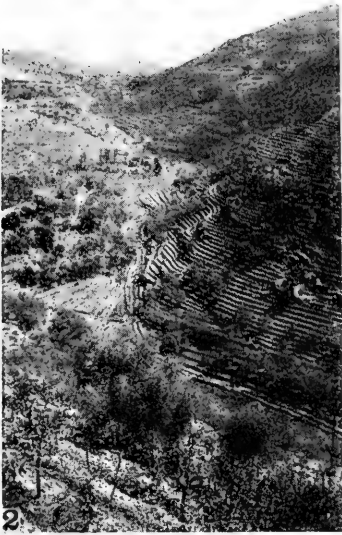

1. The Tripoli groves of cedars in the forests of the cedars of Lebanon, Lebanon, Syria, September 1939.

2, 3. Not far from Beyrouth is a valley where we found the climax in adjustment of permanent agriculture to steep, sloping lands. September 1939.

4. Well-planned and well-constructed Jewish colonies have great agricultural possibilities if the Jews are permitted to continue with their program of land reclamation in Palestine.

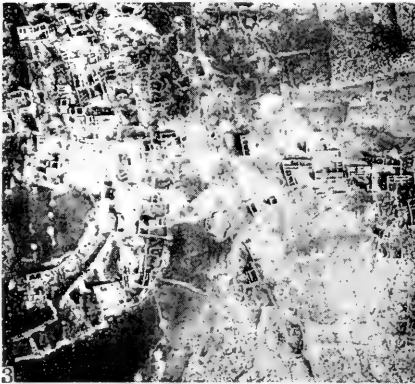
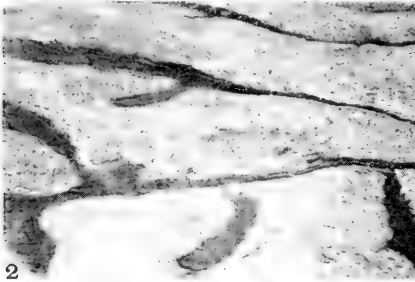

1. Oblique aerial view of Kalaat Samaan ruins of the sanctuary of St. Simon, showing the denuded condition of adjacent slopes. Some cultivation is taking place within the walls of the ruins which have held back the soil from being eroded away. (Courtesy of Father J. Mattern, S. J.)
2. Aerial view of hills of Judaea near Hebron. April 1939.
3. Vertical aerial view of Gerade, which belongs to the southern group of Dead Cities.
4. The largest and only village for many miles around the former city of Djemila, which in Roman times boasted more than 11,000 population. January 1939.
5. View of the giant coliseum at El Djem. February 1939.
6. The market square in the excavated Roman city of Djemila, where once were sold products of the surrounding lands. The denuded erosion-gullied slopes bear mute evidence of their wreckage and soil losses. January 1939.



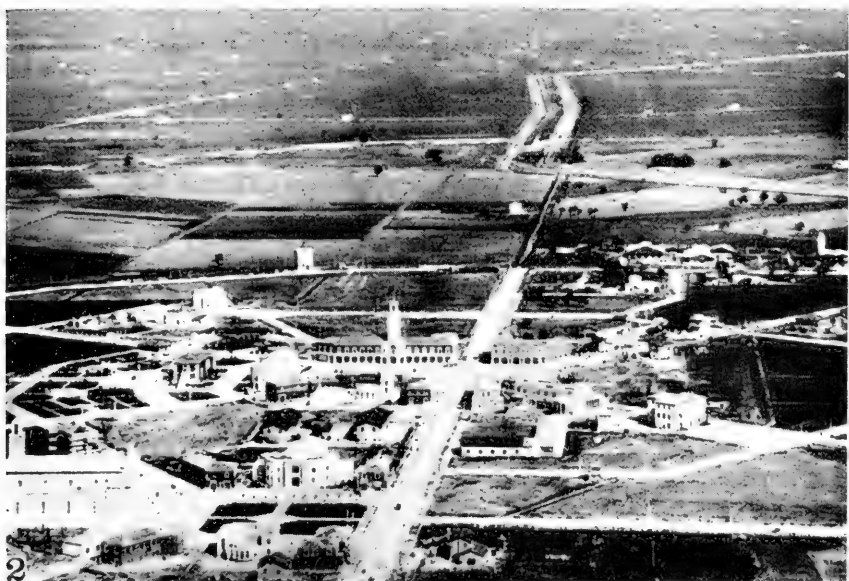

1. The ill-famed fever-infested Pontine Marshes, being a view of the site now occupied by the City of Littoria. Before reclamation.
2. Oblique aerial view of Pontine Marshes, as seen in photograph above, after reclamation, showing the city of Littoria under construction as a beautiful administrative and market center of the reclaimed area. Note scores of farm houses sprinkled over the plain.

Photographs courtesy of the Government of Italy.)

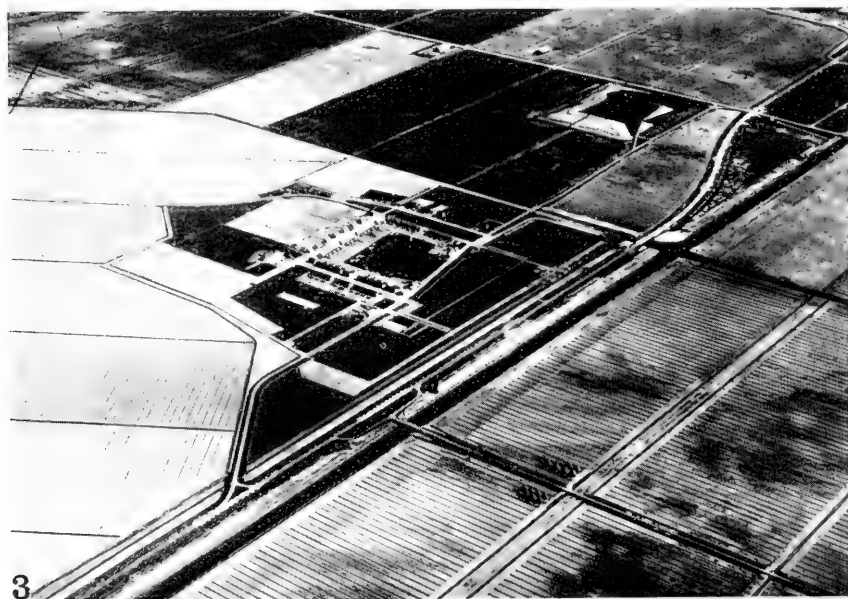
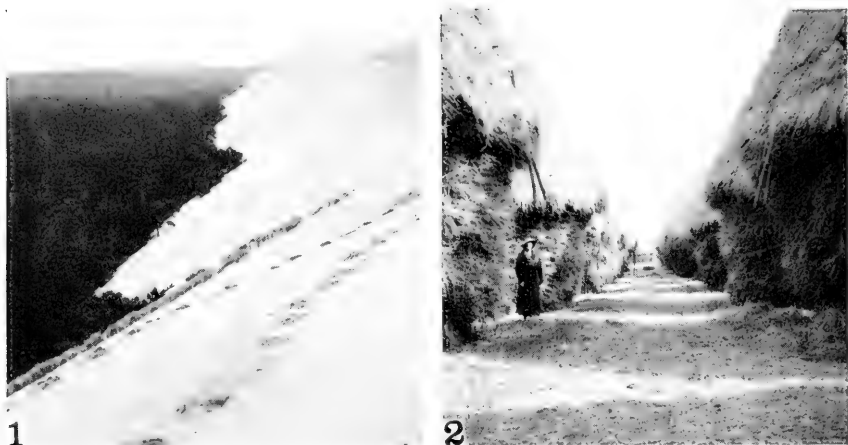

1. Leeward side of the untamed dune near d'Arcachon, showing the advance of the dune on the forest, engulfing it at the rate of about 60 to 65 feet a year. November 1938.
2. Inside view of a Holland farmer's crop of gold in this "Dutch-made Agricultural Heaven on Earth" below sea level. September 1939.
3. Wieringerwerf, the last of three villages, is shown under construction. The broad freight canal running diagonally across the picture has movable bridges. The dark borders around the rectangular farms are barge canals. The drainage ditches for leaching out the salt content from the new-born lands appear as fine lines. Agricultural specialists nurse the land with special treatment until it can be cropped to clover. It is then weaned and turned over to individual farmers.

# AREAL AND TEMPORAL ASPECTS OF ABORIGINAL SOUTH AMERICAN CULTURE <sup>1</sup>

By JOHN M. COOPER  
*The Catholic University of America*

[With 4 plates]

## CONTENTS

	Page
Introduction.....	429
Physical environment.....	430
1. The Andean region.....	430
2. The forested lowlands.....	430
3. The open-country belt.....	431
Somatology.....	431
Linguistic stocks.....	433
Culture.....	434
A. Areal distribution.....	434
1. Marginal culture.....	434
2. Silval culture.....	437
3. Sierral culture.....	438
B. Diffusion and temporal sequence.....	439
1. European and Negro diffusion: post-Columbian.....	440
2. Aboriginal diffusion and sequence: since circa A. D. 1000.....	440
a. Diffusion within and from Sierral culture.....	440
b. Diffusion within and from Silval culture.....	441
3. Aboriginal diffusion and sequence: before circa A. D. 1000.....	445
a. Sierral versus Silval and Marginal.....	445
b. Silval versus Marginal.....	445
(1) Cultural evidence.....	446
(a) South American.....	446
(b) Pan American.....	448
(2) Somatological evidence.....	449
(3) Geographical evidence.....	449
4. The question of Old World influence.....	450
Summary.....	451
Tentative prehistorical reconstruction.....	452
Bibliography.....	455

## INTRODUCTION

The purpose of the present paper is to give a bird's-eye view of aboriginal cultural distribution and sequence in South America. The West Indies and southern Middle America from the Isthmus to about

<sup>1</sup> Reprinted by permission from *Primitive Man*, vol. 15, Nos. 1 and 2, January and April, 1942.

central Honduras are included, since they are linked culturally more to South America than to North America.<sup>2</sup> The paper has been written, not for seasoned specialists in South American anthropology, but for nonspecialists, to set up an areal and temporal framework into which the enormously complex factual data can be provisionally fitted and to offer a first-aid guide to the anthropological literature of the continent. No attempt has been made, of course, to include an adequate list of the innumerable first-hand sources. Good bibliographies of these may be found in Nordenskiöld, especially 1920; Krickeberg, 1922, 1939; W. Schmidt, 1913; Izikowitz, 1935; Gillin, 1940.

For a better understanding of cultural distribution and sequence in South America, a few of the more pertinent data upon physical environment and racial and linguistic divisions are premised.

### PHYSICAL ENVIRONMENT<sup>3</sup>

Geographically Pan America may be looked upon as a quasi peninsula jutting out from the extreme northeast tip of the Afro-Eurasiatic land mass which we assume to be the birthplace of the human race. Thus, of the larger continental areas of the world, South America is farthest removed from man's primal home, the most isolated, and probably the latest to be inhabited.

South America may, for our present purpose, be divided into three major regions: (1) the mountainous western fringe, with its flanking coastal plains, and, east thereof, (2) the forested lowlands of the north, northeast, and center of the continent, and (3) the more or less open country of the east and south. With these three areas coincides fairly well the distribution of the three major cultural groupings of the continent—a correlation to which we shall return later.

1. *The Andean region.*—The Andean cordillera lifts its peaks, ranges, and plateaus, paralleling the coast, from Panama to its dip beneath the ocean at Cape Horn. Toward the Pacific it is flanked over most of its extent by a narrow strip of lowland: tropical rain forest down to about Payta (5° S. lat.), in extreme northern Peru; the Peruvian-Chilean coastal desert thence about 1,600 miles to near La Serena (30° S. lat.), Chile; dry forest and temperate rain forest from La Serena to the Magellanic archipelago.

2. *The forested lowlands.*—The forested lowlands of the Orinoco and Amazon watersheds, lying east of the northern half of the cordillera, form a vast, roughly quadrangular area. The northwestern and southwestern sides of this quadrangle are formed by the Andes; the northeastern, by the Atlantic coast line from central

<sup>2</sup> Thomas and Swanton, 1911, p. 96; Mason, 1938, pp. 311-314; Lothrop, 1940; Kidder II, 1940. Cf. Lothrop, 1939. -

<sup>3</sup> Geographical data in this section of paper largely based on: Jones, 1930; Denis, 1927; Zon and Sparhawk, 1923; Whitbeck, Williams, and Christians, 1940. Cf. James, 1942.

Venezuela to about 400 miles southeast of the mouth of the Amazon; the southeastern, by a broken line running from this last point across country to central Bolivia. The sides of the great quadrangle are about 1,300 to 1,500 miles long. Most of the area is covered with dense tropical rain forest, except for the extensive savannas of the middle Orinoco and of the Guiana highlands.

3. *The open-country belt.*—The third division of South America, representing about one-half of the continental area, is the region bounded on the west by the southern Andes, on the northwest by the Amazonian rain forest, and on the northeast and southeast by the Atlantic. It is mostly open country, treeless or only sparsely wooded—grasslands, savannas, bushlands, and steppes—including the eastern Brazilian and Matto Grosso highlands, the Gran Chaco, the Uruguayan plains, the Argentinian Pampa, the Patagonian plateau and part of Tierra del Fuego. On the Atlantic border of the Brazilian highlands, the tropical rain forest extends in a narrow coastal strip down to about 25° S. lat. The chief break in this great open-country belt is that made by the subtropical forests of southern Brazil and of the Paraguay and Paraná basins. The inland and upland savannas of the Brazilian and Matto Grosso highlands are thus practically ringed with heavily forested country, mostly lowlands. To the far southwest of the open belt lies the Chonoan and Magellanic archipelago, flanking the mainland for about 1,200 miles from Chiloe to Cape Horn and covered mostly with temperate rain forests.

#### SOMATOLOGY

Our data on the living races of man on the Southern American continent are very incomplete. Only in four or five scattered spots do they approach anything like adequacy, while for enormous areas, such as most of the Amazonian forested area, they are lacking almost entirely. No thorough analysis or interpretation even of the sparse data we have has been attempted. Dixon dealt with only certain selected elements. Biasutti's review is wanting in detail. Our most recent study, Eickstedt's, is at best provisional; however, such as it is, it represents at least a start.<sup>4</sup>

Eickstedt isolates four main physical types (pl. 1) two tending toward brachycephaly, two toward dolichocephaly—although one of these latter two, his Brazilid type, falls in the main within mesocephaly. Eickstedt blocks out the following distributions: The Andid subrace, broad-headed and of relatively low stature, occupying most

<sup>4</sup>Dixon, 1923, pp. 443-472; Biasutti, 1912, pp. 140-143, maps 1-7; Eickstedt, 1934, pp. 720-759, 838-876, map opp. p. 752; Pericot, 1936, pp. 593-727, *passim*, good for bibliography; Krickeberg, 1922, pp. 217-219. For references to other classifications and distributions, see: Gusinde, 1939, pp. 406-418; Imbelloni, 1937.

of the Andean area down to Chiloé; the Pampid subrace, brachycephalous and of relatively tall stature, of the Matto Grasso plateau, the Chaco, the Uruguayan plains, most of the Pampa region, and Patagonia; the Brazilid subrace, of medium to short stature and heavy torso, tending toward dolichocephaly [mesocephaly], of the Amazonian and Orinoco watersheds, most of the coastal forest belt flanking the Brazilian highlands, and the Buenos Aires region; the Lagid subrace, more markedly dolichocephalous, of medium to low stature, and of lighter torso, occupying the Brazilian highlands, and the Chonoan and Magellanic archipelago.

In general it can be said that the Andean region is more dominantly brachycephalic, while in what we are calling the open-country belt there is much more of dolichocephaly. In rain-forest areas, apart from the Colombian coastal region, there is more tendency toward mesocephaly. These broad generalizations are subject to local exceptions.

On the prehistoric South American racial types our data are likewise very sparse and inadequate, particularly for the tropical rain-forest region. None of our prehistoric human remains is of demonstrated great age. Ameghino's claim to have discovered Tertiary man has long since been successfully challenged and disproved. In the hill caves of Lagoa Santa in southern Brazil and in the sambaquis (shell heaps) of the southeastern Brazilian coast have been discovered skeletal remains of a race or races of seemingly considerable age. But there is no clear evidence of very great age. The 17 Lagoa Santa skulls are fairly high and, with one exception, dolichocephalous; the coastal shell-heap or sambaqui type is likewise dolichocephalous but with rather low forehead. A number of older post-Pleistocene remains have been found in the Pampas; some others here and there in the Andean region, such as the Punin skull of Riobamba, Ecuador. These earlier skulls from the Pampa and Andean region, like the Lagoa Santa and sambaqui skulls, are consistently long-headed, and many of them show other seemingly significant similarities with some of the living peoples such as the Botocudo and Fuegians, whom Eickstedt includes in his Lagid race.<sup>5</sup>

From such evidence as we have, sparse and incomplete though it be, we seem to be on fairly safe ground in concluding that earlier man in South America was long-headed,<sup>6</sup> that the broadheads represent a later stratum, and that many of the modern Lagids are survivors of this earlier type and have preserved to greater or lesser degree its characteristics. The modern Lagids, or at least many of them, would thus seem to represent the more primitive type of South American

<sup>5</sup> Hrdlička, 1912; Eickstedt, 1934, pp. 748-759; Sullivan and Hellman, 1925, Punin calvarium; Walter, Cathoud, and Mattos, 1937, *Confins man*.

<sup>6</sup> As in North America: Stewart, 1940.

man. Whether the brachycephalic type or types developed out of the earlier dolichocephalic type or types, or represent a later migration into South America across the Panama bridge or the Antilles, is an open question. All that we can say with any confidence is that the broadheads appear in the main to be more recent.

#### LINGUISTIC STOCKS

As our evidence stands today, there are more linguistic stocks, by probably a good 50 percent, in South America than in North and Middle America combined. Our most important recent review, Rivet's, lists 77 such South American linguistic stocks. In view of our scant evidence for many areas and peoples and of our lack of a thorough analysis of the evidence we have, this number is provisional only. In all probability it will be appreciably increased or decreased as our information itself and the analysis thereof become fuller. Particularly defective is our information for the Brazilian highland region, although Nimuendajú and one or two others are helping to clear up the situation.<sup>7</sup>

Of these 77 stocks, about 14 are spoken over a good four-fifths of the continental area. In the Andean region, passing from north to south, Chibcha, Quechua, Aymara, and Araucanian cover nearly the whole area. Over a good two-thirds or more of the Orinoco-Amazonian forest belt and in the West Indies are spoken Arawak, Carib, Tupi, Tucano, and Pano, or were in post-Columbian times spoken.

In the open-country belt, about four-fifths or more of the area is or was inhabited by people of Gê, Guaycurú, Charrua, Puelche, and Tshon stocks.

Most of the remaining 63 stocks are scattered over the rest of the continent, not checkerboard fashion, or at random, but in the main distributed in a great broken crescent extending in the west along the base of the Andes and to the south along the southern borders of the Amazonian forest and of the Brazilian highlands to the Atlantic coast. This marginal distribution may be explained in either one of two ways. The peoples speaking these stocks may have been driven to marginal areas by the more numerous and more powerful peoples of Arawak, Carib, Tupi, and other stocks. Or else we may assume that before the deployment of these latter through the Orinoco-Amazonian belt, this area was occupied by a very great number of peoples of distinct linguistic stocks, and that, as the Arawak, Carib, Tupi, and others spread out over the area, these earlier residents

<sup>7</sup> Rivet, 1924, pp. 639-707; Nimuendajú and Lowie, 1937, pp. 565-566. For linguistic (and tribal) maps of South America, see: Rivet, 1924; W. Schmidt, 1926, Atlas, largely utilizing Rivet; Krickeberg, 1922, 1939; Pericot, 1936, largely based on previous maps, bibliography; Krieger, 1935, adapted from Krickeberg and Roth. For linguistic maps of Middle America, see Mason, 1940, and Johnson, 1940; Thomas and Swanton, 1911.

took over the languages of the invading swarms, thus leaving the earlier atomistic distribution of stocks on the uninvaded margins of the area. We have many instances, historically and ethnologically verified, of such change of language as a result of Tupi, Carib, and Arawak invasion or contact.

At any rate, the distribution of stocks in South America is in itself evidence of very wide migrations and drifts, many of them established historically—migrations and drifts facilitated by the lack of great natural barriers over the vast lowland areas of the continent, and stimulated to a considerable extent, within the horticultural belt by the prevalent milpa agriculture,<sup>8</sup> and for the Tupi, by the ancient and deep-seated tradition of a distant Utopia beckoning them on.<sup>9</sup>

## CULTURE

### A. AREAL DISTRIBUTION

For purposes of description and interpretation, the aboriginal cultures of South America may be classified regionally into three large divisions, the areas occupied by these divisions corresponding roughly to the Andean uplands, the forested Orinoco-Amazon lowlands, and what we have called the open-country belt. For convenience we are calling these three cultural groupings the Sierral, the Silval, and the Marginal, respectively. The Marginal is so denominated in view of the fact that technologically it is simpler than either of the other two and that regionally it borders on<sup>10</sup> and is marginal to the Sierral and Silval areas.<sup>11</sup>

1. *Marginal culture*.—In this grouping we include the Gê-speaking peoples (provisionally) and the Botocudo (Borun), Mašakali Patašo, Puri, Waitaka, and others of eastern Brazil, together with the Bororó, Guató, and Guayakí, as well as the peoples of the Chaco, of the Uruguayan plains, of the Argentine Pampa and of Patagonia, and the Ona, Yahgan, Alacaluf, Chono, and Chango—who, in the main, may be looked upon as externally marginal to the Sierral and Silval areas; and also certain peoples now or until recently of very simple culture such as the Yaruro, Makú, Schirianá, Waíka, Bahúna, Huhú-

<sup>8</sup> M. Schmidt, 1917; cf. Cook, 1921.

<sup>9</sup> Métraux, 1928, pp. 201–224.

<sup>10</sup> We have no satisfactory comprehensive description of South American culture. Krickeberg, 1922 and 1939, and Nordenskiöld, 1912b, come nearest, but much new material has come out in these last two or three decades. Stout, 1938, has a good short summary. The Handbook of South American Indians, now being prepared by the Smithsonian Institution, under the able direction of Dr. Julian H. Steward, with the cooperation of a group of specialists, will be published about 1944 or 1945. For West Indies see: Fewkes, 1907; Lovén, 1935. For Panama region: Lothrop, 1937.

<sup>11</sup> Wissler, 1917, used a fivefold division. Krickeberg, 1922, adopted a twofold one: Naturvölker, with six subdivisions, and Kulturvölker, with four subdivisions; in 1939, a threefold one: collectors, gardeners, and Kulturvölker. Stout, 1938, has worked out a ninefold division, his Nos. 4–6 corresponding roughly to our Sierral, No. 7 to our Silval, the remaining five to our Marginal.



teni, Katapolítani, Mura, and Sironó, who are found widely scattered here and there in the Silval area as internally Marginal groups. (See fig. 1.) The externally Marginal peoples occupy most of our open-country belt, except such sections of the forested land therein as are or were occupied by horticultural tribes, mostly Tupi.<sup>12</sup> Some of the foregoing tribes, such as the Gê, Mura, and Sirionó, may later turn out to be culturally retrogressed Silval peoples.

Between these many Marginal peoples one finds very numerous and profound regional and tribal divergences of culture.<sup>13</sup> But underlying these divergences there exists very considerable uniformity of culture both in what is present and in what is absent.

We may sum up this basic uniformity about as follows: Food-getting by hunting, fishing and gathering, with horticulture either absent or only rudimentary or less developed among most groups; no domestic animals except the dog, and even the dog absent here and there; more commonly no stimulants (alcoholic beverages, tobacco, coca), or else demonstrably or probably of relatively recent or even post-Columbian introduction; pottery very often absent or, where present, of relatively crude type; clothing and adornment usually either very meager or very simple; weaving absent or at best rudimentary; shelter of the simplest, such as the lean-to, beehive hut (pl. 3, upper), and so forth; mats or skins on ground for sleeping; use of stone, bone, or wood for weapons and utensils, with practically complete absence of metals; unusually long bows and arrows among many of the internally Marginal and northern externally Marginal peoples; fire-making by drill over most of the area, but by the percussion method in the Magellanic archipelago and among the Guayakí and some Tehuelche; cannibalism absent or practically so; well-organized family system with prevalent monogamy or simple

<sup>12</sup> For the convenience of readers who may desire to follow through or check up on the content of the culture of these Marginal peoples, the more important first-hand and second-hand sources, many of them containing bibliographies, are here listed. Gê and other Brazilian marginals: Ploetz and Métraux, 1929; Métraux, 1939; Sneath, 1930; Nimuendajú, 1938, 1939, 1942b; Nimuendajú and Lowie, 1937, 1939; Lowie, 1940b, pp. 423-439, 1941; Henry, 1941. Bororó: Colbacchini, [1924]; Lévi-Strauss, 1936; von den Steinen, 1894. Guató: M. Schmidt, 1905, 1914. Guayakí: Vellard, 1934. Chaco: no satisfactory survey available that embodies the newer data from the many scattered sources; a thorough one by Métraux about completed but not yet published; short surveys in Krickeberg, 1922, pp. 293-305, and 1939, pp. 108-117; cf. also Nordenskiöld, 1919, 1920; bibliography in Pericot, 1936. Uruguay and Paraná delta: Lothrop, 1932; Rivet, 1930. Argentine Pampa and Patagonia: Outes and Bruch, 1910; Palavecino, 1934. Ona, Yahgan, Alacaluf (Chono): Gusinde, 1931, 1937; Lothrop, 1928; Cooper, 1917. Chango: Latham, 1910. Yaruro: Petruccio, 1939. Schirianá, Waika, Makú, Bahúna, Huhúteni, Katapolítani: Koch-Grünberg, 1906a, 1906b, 1922, and 1923, pp. 248-319. The Bahúna, Dr. Irving Goldman informs me from his field studies in the area, are a sib rather than a tribe; there is some question, too, as to the correctness of Koch-Grünberg's assumption that the Schirianá and others had only recently adopted horticulture. Mura, Sirionó: extremely meager data available; for Mura, cf. Tastevin, 1923; Bates, 1892, pp. 166-170; for sources on Sirionó, see Pericot, 1936; Gillin, 1940, p. 648. Four subdivisions of the South American Marginals are suggested in Cooper, 1942.

<sup>13</sup> As among Marginals elsewhere, as Lowie, 1940a, pp. 417-418, has recently emphasized.

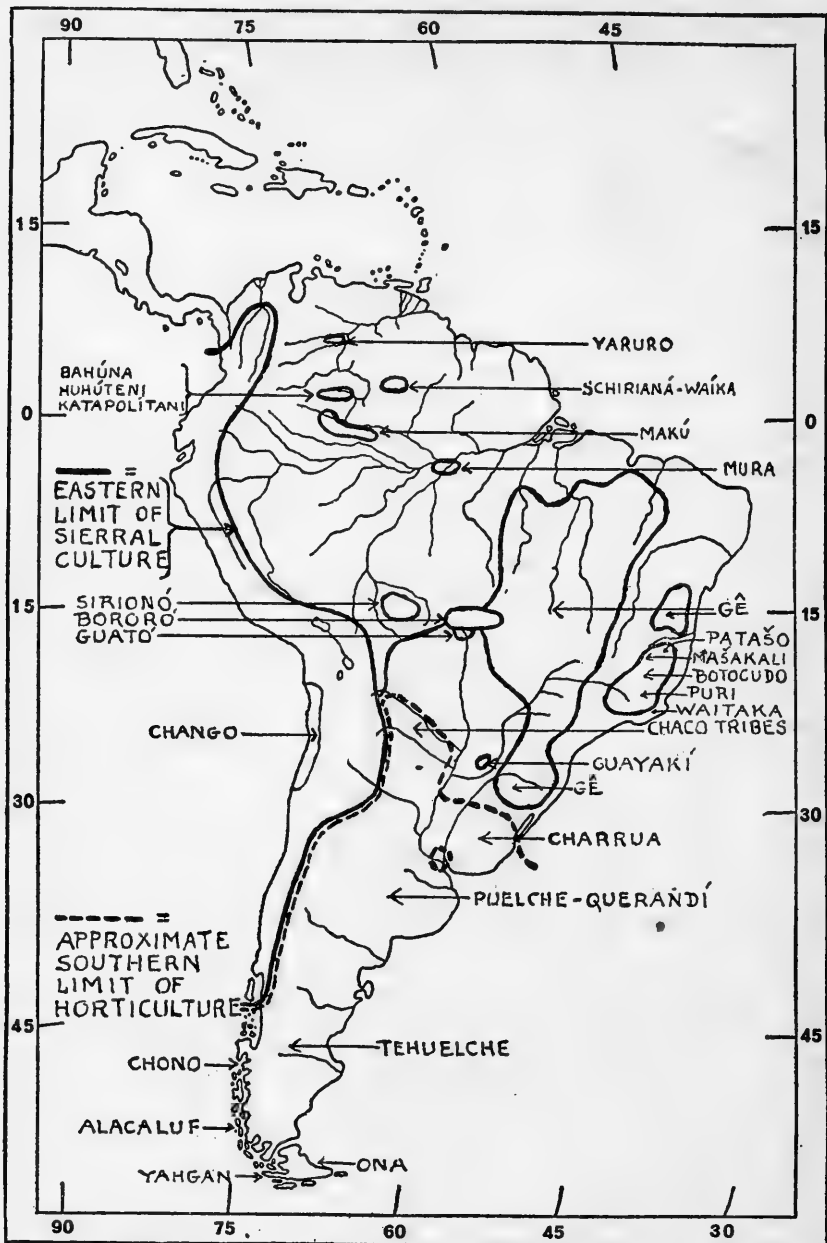

FIGURE 1.—Distribution in historic times of South American Sierral, Silval, and Marginal culture, and southern limit of agriculture. Apart from the areas inhabited by the Marginal peoples designated on the map, nearly all the territory east of the eastern limit of Sierral culture and north of the southern limit of horticulture has in historical times shared the Silval culture.

polygyny, and here and there rather strict monogamy; the typical political unit a small band, usually made up of relatives, with bands occasionally forming loosely cohesive tribes with or without chieftaincy of limited power; moieties and moietylike tribal divisions as a rule absent, but reported among the Yaruro, Bororó, and some of the Gê peoples, the moiety organization among the latter being of marked complexity; levirate, sororate, and avoidances of fairly wide distribution; among a number of the tribes, especially the Yaruro and Ona, land-tenure systems resembling closely the northeastern North American family hunting-ground system; shamanism, but absence of priesthood; religion in general seemingly a little more animistic than manistic, with well-defined theism among at least a good many groups, and recorded in detail among the Fuegians, the Apinayé, and the Yaruro (pl. 4, upper).

2. *Silval culture*.<sup>14</sup>—The area of the Silval culture includes not only the broad Amazonian-Orinoco forested region with its adjacent and enclosed savannas, but also the Guianas, the West Indies, most of Middle America from Honduras to the Isthmus, the rain-forest belt of the Colombian and eastern Brazilian coast, the temperate rain forests of southern Brazil and the Paraná-Paraguay region, and the forested Andean foothills bordering the northern Chaco.

As in the Marginal culture, so in the Silval culture there are innumerable and important local differences, but underlying these there is a quite perceptible uniformity. These more uniform characteristics of this far-flung Silval culture may be summed up about as follows: Horticulture universal, with use of dibble rather than hoe, and carried on under the slash-and-burn, shifting-cropping or milpa system; manioc (pl. 2, upper), sweet or bitter, a, or the, basic staple over most of the area, with, however, a good deal of maize, beans, sweetpotatoes, and so forth; the dog, at present, practically but not quite universal; widespread use of poison in fishing, and, toward the northwest particularly, of the blowgun with curare-poisoned darts in hunting; tobacco and alcoholic beverages throughout the area, the latter made with mastication (except of course for wines and mead) and indulged in to intoxication at festival drinking sprees; cannibalism widespread, particularly but not exclusively among Tupi- and Carib-speaking peoples; well-made but simple pottery, here and there reported archeologically and ethnologically of unusually good type as at Santarem and around the mouth of the Amazon; notable meagerness or absence of clothing, with, however, rather elaborate body adornment, particularly featherwork; lip plug of fairly wide distribution;

<sup>14</sup> Our best reviews of culture of area are Krickeberg, 1922 and 1939. For distributions of material culture elements, see Nordenskiöld, 1919, 1920, 1924, 1931. For social organization, see Kirchhoff, 1931; Haeckel, 1938. For sources, see Gillin, 1940; Pericot, 1936.

fairly well-developed weaving; shelter of timber framework demanding fairly advanced carpentry and commonly of dimensions large enough to house a considerable number of people (pl. 3, middle), with inside ground areas reported up to about 10,000 square feet or more; hammocks; weapons and tools of stone, where it is available; some metal ornaments; major social unit in the tribe consisting more commonly, where data are reported, of the extended family or sib living in the large houses above mentioned, with villages often comprising only one or two, at most several, such houses; villages at times confederated into a loose tribal organization; moiety and sib systems recorded here and there, some of the moiety systems bearing marked resemblance in certain details to those found among the Gê peoples; levirate, sororate, and avoidances not uncommon; couvade widespread; religion, as far as known, largely shamanistic and animistic, with at least a good deal of theism among many groups (pl. 4, lower).

3. *Sierral culture*.—The Sierral culture extends from Colombia to the northern Araucanian area and is shared by the peoples of the region we have previously described as the Andean area, except the tribes of the rain-forest coastal strip in the north who belong more to the Silval culture, and the Changos of the Chilean coastal desert and the Chono-Fuegian Canoe Indians whose culture is of the Marginal type. The Araucanians of middle Chile down to Chiloé are in the main on a markedly simpler culture level than the peoples farther north, but in many respects are linked genetically with the Sierral culture proper and so may best be included therein.

Again, as in the Marginal and Silval culture, marked local differences appear in the Sierral culture as one passes down the Andean highland from Colombia to the south, but there is likewise beneath the divergences an underlying cultural uniformity.

The more characteristic traits of the Sierral culture may be summed up as follows:<sup>15</sup> Horticulture universal, with maize as the chief staple and beans ranking next, except in the very high altitudes where white potatoes, oca, and quinoa are basic; garden plots and fields tending to be of more permanent location than under the Silval milpa system, with irrigation in the drier lowlands and with terraces in the highlands (pl. 2, lower); the llama and alpaca domesticated and used for transportation, wool, food, and sacrifices; coca chewing as a stimulant, in addition to tobacco and alcoholic beverages; very high development of pottery and weaving; full body clothing (in contrast to predominant Silval near-nudity); advanced metallurgy, in copper, platinum, gold, and (from Ecuador south) silver, but not in iron, with smelting, casting by direct and lost-wax methods, alloying of gold and

<sup>15</sup> Thompson, 1936, gives an excellent summary of Sierral cultures, for the general reader, with selected bibliographies. For fuller treatment, especially of Peru, with bibliography, see Means, 1931. For types of horticulture in Sierral and Silval cultures, see Sapper, 1934.

copper (tumbac), of gold and silver, and of copper and tin (bronze), sintering of gold and platinum (Ecuador),<sup>16</sup> plating, gilding, soldering, and welding; ordinary dwellings as a rule of very simple construction but advanced megalithic architecture (pl. 3, lower) in the central Andean region in the building of temples, fortifications, and other public structures; roads, suspension and stone bridges; the quipu knot-record system, but no writing; wide use as weapons of slings, stone-headed and metal-headed clubs, spear and spear thrower, and bolas, with bow and arrow absent or of quite secondary importance (as contrasting with the Silval and most of the Marginal area where the bow and arrow and the unheaded club predominate); advanced political institutions with high organization and centralization, and particularly in the Inca civilization, militaristic imperialism; tribute and taxes; organized standing army; earlier pre-Inca tenure of garden plots in severalty<sup>17</sup> supplanted later under Inca rule by limited communal control of land; elaborate market system; highly organized priesthood and ritualism, alongside of considerable shamanism; animal and, to a limited extent, human sacrifice; marked solar cult.

As is obvious from the foregoing summary descriptions, the Marginal, Silval, and Sierral cultures represent in the main three fairly distinct levels of technological and economico-political achievement, the Marginal being the simplest, the Silval more developed, and the Sierral the most complex.

It has been our main purpose so far to block out only in broadest outline the nature and distribution of these three contrasting cultural types over the South American Continent and the adjacent areas of the West Indies and Central America. To keep the picture from becoming too intricate, we have purposely closed our eyes to the numberless tribal and areal cultural diversities and have tried to see the continent as a cultural whole, even at the risk of appearing to oversimplify the well-recognized unending complexities of South American aboriginal culture.

#### B. DIFFUSION AND TEMPORAL SEQUENCE

Our next task is that of interpretation—here an attempt to determine spatial and temporal relationships. As initial steps toward working out a provisional reconstruction of cultural sequence on the continent we may first isolate and strip off certain cultural elements in modern aboriginal South American culture that are demonstrably post-Columbian, and secondly, survey some of the more significant earlier diffusions that are clearly or reasonably inferable from the data at our command.

<sup>16</sup> Bergsøe, 1937 (cf. reviews by J. A. Mason and D. Horton in *Amer. Antiquity*, vol. 4, pp. 84-87, 1938).

<sup>17</sup> Santa Cruz, 1940.

## 1. EUROPEAN AND NEGRO DIFFUSION: POST-COLUMBIAN

A very great number of important elements, widespread among and well integrated into contemporary aboriginal South American culture, are, as is well known, due to introduction by Europeans since 1492. Such are, for instance, among domesticated plants, sugarcane, banana, watermelon; among domesticated animals, the horse, cattle, sheep, goats, pigs, chickens; firearms; weapons, utensils, and tools of iron; perhaps the pellet-bow; and of course many social, economic, political, and religious concepts and practices. Some less widespread and less significant elements are traceable to post-Columbian Negro influence, such as the marimba, and specific types of African drum.<sup>18</sup>

## 2. ABORIGINAL DIFFUSION AND SEQUENCE: SINCE CIRCA A. D. 1000

With the historical, ethnological, and archeological data at our command today we are able to plot for a great many cultural elements, complexes, clusters, and types the diffusion routes that can be chronologically classified as of post-Columbian times or else as of the centuries immediately preceding the Discovery, and consequently relatively recent. Some of these diffusions are demonstrable or practically so, others rest on reasonable probabilities. Such diffusions of course presuppose and are temporally posterior to the rise and establishment of the respective cultures involved. If we strip them off the cultural picture of modern aboriginal South America we can see a little more clearly the broader outlines of cultural distribution in South America several centuries before the Discovery—say about the year A. D. 1000, to select a more or less arbitrary date. Diffusion of cultural elements from the Marginal peoples to the Silval and Sierral has seemingly been minimal. Diffusion has occurred almost exclusively from and within the Sierral and Silval cultures. In each there have been certain marked major diffusions and others of minor significance. Let us begin with the Sierral.

a. *Diffusion within and from Sierral culture.*—Two major Sierral diffusions may be distinguished, one definitely tied up with the rise and spread of the Inca Empire, the other of less determinable provenance. In the two or three centuries prior to the coming of the Spaniards the Inca Empire developed and spread from around Cuzco to the north along the Andes as far as northern Ecuador and to the south as far as the Rio Maule in central Chile and along the eastern slope of the Andes to the Diaguita territory carrying with it a great

<sup>18</sup> Post-Columbian white influence: Nordenskiöld, 1919, pp. 232-234; 1920, pp. 119-126, 197-202; 1930, ch. 7. Post-Columbian Negro influence: Nordenskiöld, 1930, ch. 7; Izikowitz, 1935, p. 415. Pellet-bow: Nordenskiöld, 1919, pp. 48-51, evidence for post-Columbian origin; Friederici, 1920, p. 186, for pre-Columbian origin.

number of elements which we have previously listed as typical of the Sierral culture. (See fig. 2.)<sup>19</sup>

Partly in pre-Columbian times (Inca and presumably pre-Inca), partly in post-Columbian times, many of the typical Sierral elements drifted south into Araucanian territory. Such elements include, together with others of less importance, irrigation and possibly quinoa and the white potato, the domestication of the llama, wool weaving, certain pottery types, metal work in silver, and the quipu. In post-Columbian times prior to the middle of the eighteenth century the Araucanians deployed far out over the Pampas toward the Atlantic coast, carrying with them their culture, many elements of which through contact diffused well north and south of the central Pampas. Some time between the dates 1670 and 1741 this Araucanian influence profoundly modified the culture of the Tehuelche to the south of the Pampas proper as far as the southern limit of the Tehuelche territory at the Strait of Magellan. The culture of the Tehuelche as recorded in our 20 sources from 1520 to 1670 differed markedly from it as recorded consistently from 1741 on, and the majority of the new elements are obviously of Araucanian origin.<sup>20</sup>

Through trade and other contacts a good deal of Sierral culture has filtered down from the highlands into the adjacent wooded lower eastern slopes of the Andes. But in general only minor Sierral influences, some of them at least recent post-Columbian, are discernible in the Silval and Marginal regions. Such in the Silval region are probably elements such as coca chewing, the feather fire-fan, and the Panpipe.<sup>21</sup> Among the seemingly Sierral elements in Chaco culture are the feather fire-fan, games of chance, sandal and fillet, and certain textile and fictile patterns.<sup>22</sup> All in all, however, Sierral influence on the Amazonian and Chacoan peoples did not, so far as we can determine, very appreciably change their fundamental culture. Whether in far distant prehistoric times agriculture with such arts as weaving and pottery had their origin in the Andean region and thence spread out over the Silval area, in this manner greatly changing an assumed earlier archaic collecting culture there, we are not in a position to say, nor probably will be unless or until the archeologist's spade digs up decisive evidence.

b. *Diffusion within and from Silval culture.*—Let us pass to the cultural diffusions stemming out from the Silval area. It is possible that in remote times the cultivation of manioc originated in the Silval belt east of the Andes and thence spread to the lowlands of the Sierral

<sup>19</sup> Means, 1931; Thompson, 1936. The Diaguita, higher culture was, however, at base independent of, and anterior to, Inca influence and domination.

<sup>20</sup> Cooper, 1924, pp. 406-410.

<sup>21</sup> Nordenskiöld, 1920, pp. 202-206; 1924, ch. 21; 1930, ch. 9.

<sup>22</sup> Nordenskiöld, 1919, pp. 235-251; 1920, pp. 202-206; 1924, pp. 225-226.

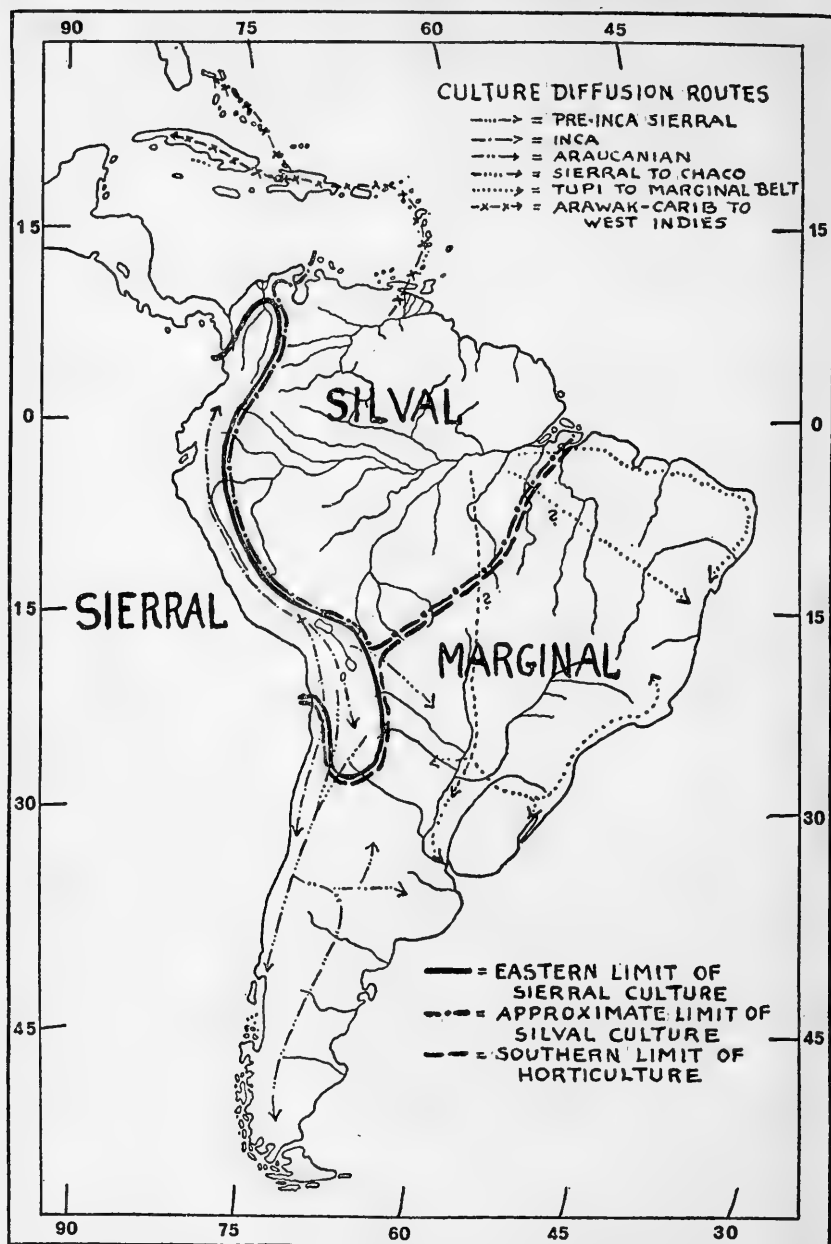

FIGURE 2.—Tentatively reconstructed distribution of South American Sierral, Silval, and Marginal culture, as of circa A. D. 1000, and major cultural diffusions and drifts since then. Marginal enclaves within the Silval belt are not included in map. Araucanian territory is placed in the Marginal area, although horticulture may possibly have reached that far south by A. D. 1000.



region, but the evidence is far from decisive. As regards one minor and two major diffusions of Silval culture, we are on more secure ground.

A minor drift or drifts brought into the Chaco certain Silval elements such as manioc horticulture, the manioc grater, wooden stools, hammocks, and the rubber ball for games.<sup>23</sup>

The first of the two major diffusions is that of the Arawakan peoples into practically the whole of the West Indies probably some centuries before the coming of the Spaniard, and later the invasion, still under way at the time of the discovery, of the Caribs across the Lesser Antilles as far as some of the nearer Greater Antilles islands. Whether or not the presence of typical South American Silval culture in southern Middle America represents migration or cultural intrusion into the area from South America cannot at present be decided. At any rate, most of the region of Middle America where culture similar to the South American Silval culture is found is, like the latter's area of distribution, rain forest.

The original centers of dispersion of the Arawak and Carib peoples cannot in the present state of our evidence be determined. With only rare exceptions the areas over which they have spread are areas of tropical rain forest. They have, it is true, occupied the smaller lower-Amazon savannas and part of the Brazilian highland savanna, but not, except in part, the more extensive savannas of the middle Orinoco, where in historic times at least have dwelt peoples of other linguistic stocks, such as the Otomac, Guahibo, Sáliva, and the very primitive Yaruro. The Arawaks and the Caribs appear, in other words, to have shunned the open country and to have kept in the main to the deep forests. Some of the spread of Arawak and Carib culture within the forested area is pretty clearly a matter of relatively recent generations—as e. g., in the case of the Schirianá and Waíka, if we can rely on Koch-Grünberg.<sup>24</sup> Most of the Arawak and Carib spread must, on the other hand, go back to relatively remote prehistoric times.

The Tupi, like the Arawak and Carib, have also kept pretty consistently to the forests. The earliest determinable center of dispersion seems more probably, since Métraux' studies, and Klimek and Milke's statistical analysis, to be the Amazon basin. Then well prior to the coming of the European they appear to have drifted down to the Paraguay-Paraná and southern Brazilian region, the historic home of the Tupi-Guarani. At least it is mostly from these two centers on the Amazon and the Paraguay-Paraná that the Tupi spread out along the southern bank of the lower Amazon, and along the Brazilian coast with almost no break from the mouth of the Amazon to the extreme

<sup>23</sup> Nordenskiöld, 1919, pp. 252-255; 1920, pp. 208-213.

<sup>24</sup> Koch-Grünberg, 1923, pp. 284-319; cf. M. Schmidt, 1917.

southern Brazilian coast.<sup>25</sup> Thus the Gê-speaking, Botocudo, and other Marginal peoples of the Brazilian highlands became almost entirely ringed by the Tupi, who brought with them into the forested areas wherever they went their typical Silval culture. The regional distribution of the Tupi as mapped by Métraux coincides almost perfectly with the area of distribution of the tropical and subtropical rain forests that all but surround the eastern Brazilian and Matto Grosso highlands.

Silval influence, in most cases mediated through the Tupi, has deeply penetrated into the Brazilian highlands and adjacent regions and has overlaid to differing depths the preexisting Marginal culture, leaving only areas here and there untouched or relatively untouched. To such Silval influence can be with reasonable confidence ascribed such elements as horticulture, tobacco, intoxicants, the hammock, and so forth,<sup>26</sup> and possibly, although the question is still an open one, the basic pattern of the complex social organization revealed among the Bororó and by more recent studies among some at least of the Gê-speaking peoples such as the Apinayé, Canella, and Šerente.<sup>27</sup> Many of these element diffusions from Tupi sources can be well dated by historic documents as post-Columbian. Furthermore, from the scattered distribution of these Silval traits in the area, from their seemingly imperfect assimilation, and from the recency of much or most of the Tupi invasion of the area, Silval influence on the highland region appears to be in the main recent. All in all, then, we have good ground for concluding that the process of Silval diffusion into this Marginal region has been mostly a relatively late one, much of it known definitely to be post-Columbian and most of the rest probably dating back not many centuries prior to the coming of the European.

The numerous migrations of Sierral and Silval peoples and cultures which we have briefly summarized in the preceding several pages are of course by their very nature chronologically later phenomena in the respective regions. Many of them are post-Columbian, most or all of the remaining ones are—some quite clearly, others very probably—of dates later than the one selected above, somewhat arbitrarily, that of circa A. D. 1000. At or about that date, the distribution of the three cultures—the Sierral, the Silval, and the Marginal—was much less broken and more regular than it was at the time of the Spanish conquest or than it has been in more recent times (see fig. 2). At that more remote date, the Sierral culture without the Inca overlay occupied about the area where it was found at the time of the Discovery; the

---

<sup>25</sup> Métraux, 1927; Klimek and Milke, 1935, pp. 87–88. Cf. Nordenskiöld, 1917, on Chiriguano migration across the northern Chaco to the forested foothills to the west thereof; more fully documented in Métraux, 1929b.

<sup>26</sup> Ploetz and Métraux, 1929.

<sup>27</sup> Haeckel, 1938—a valuable assembling of the factual evidence, but theory of ultimate Andean origin provisional only.

Silval culture, approximately where it has been in recent times, in the Amazon-Orinoco watershed; the Marginal culture, the rest of the continent to the east, southeast, and south. In case, however, the Gê should turn out to be partly retrogressed Silvals, the dividing line between the Silval and Marginal cultures would have to be drawn farther to the southeast than we have drawn it in figure 2.

### 3. ABORIGINAL DIFFUSION AND SEQUENCE: BEFORE CIRCA A. D. 1000

We have so far blocked out certain important temporal sequences that have occurred within the last millennium. How far can we get toward determining such sequences prior to our date of circa A. D. 1000? It is recognized of course that any such historic reconstruction on a continental scale must rest on probabilities rather than on certainties. But at least it seems worth while to assemble and appraise such evidence as we have. We shall take up first the temporal relations of the Sierral to the Silval and Marginal, and after that the relations of the Silval to the Marginal.

a. **SIERRAL VERSUS SILVAL AND MARGINAL.**—That the higher pre-Inca culture or cultures of the Sierral region developed at a date later than did the Silval culture appears to rest on fairly solid ethnological and archeological evidence. Ethnologically these civilizations presuppose and are built upon well-advanced horticulture. And we have no good ground for assuming that horticulture developed in the Silval area prior to or at least appreciably prior to its development in the Andean area. A plausible case can even be made for the Sierral region as the birthplace or earliest area of origin of agriculture on the continent, although the claim may be disputed by Middle America or perhaps by the Silval region.<sup>28</sup> While archeologically the earlier Andean pre-Inca civilizations cannot, over most of the area, be shown to have been preceded by simple cultures of the Silval level, at two points at least in the area, Taltal and Arica, early and perhaps the earliest archeological horizons seem to show an even simpler one comparable to that of the nonhorticultural Marginal peoples.<sup>29</sup>

b. **SILVAL VERSUS MARGINAL.**—As regards the temporal relations of the Silval and Marginal cultures the evidence calls for a little more in the way of discussion. Theoretically the Marginal belt might conceivably represent a retrogressive break-down and offshoot of the Silval culture. Actually, the evidence seems to be accumulating that the Marginal culture is in reality a trarriant culture, earlier in point of time on the continent than the Silval. The evidence for this inference we shall now summarize and discuss—first and chiefly the cultural

<sup>28</sup> Cook, 1925; Mangelsdorf and Reeves, 1939; Sauer, 1939; Thompson, 1936, pp. 13-14.

<sup>29</sup> Summary from earlier sources, in Cooper, 1924, p. 413; important recent excavations, in Bird, 1943.

evidence from ethnology and archeology, then briefly the somatological and geographical evidence. Some of the cultural evidence is derived from a consideration of the data from South America alone; other, from consideration of pan-continental conditions, from North as well as South America.

(1) *Cultural evidence.*—(a) South American.—That the Fuegian culture represents in the main such cultural tarriance from very early times seems reasonably clear. The evidence for this conclusion has been previously presented in detail by the present writer, a conclusion strengthened, it seems, by the archeological investigations of Lothrop and Bird which indicate that the earliest inhabitants of the area had a culture seemingly even more simple than that of the modern Yahgan and Alacaluf, and of the Ona and their close cultural relatives, the Tehuelche of southern Patagonia. Furthermore the modern culture of the Yahgan and Alacaluf in particular corresponds in many seemingly significant respects with the extremely simple culture determined archeologically on the earliest horizons at Taltal and Arica, well up the Chilean coast.<sup>30</sup>

That the Gê (?), Botocudo (Borun), Puri, Waitaka, and other Marginals of eastern Brazil represent a survived archaic pre-Silval culture in the region seems the most reasonable hypothesis to account for the evidence we have. The evidence for the region has been marshaled by Ploetz and Métraux, much of the evidence for the northern Gê, by Snethlage.<sup>31</sup> This conclusion, to which we have previously adverted, is drawn partly from the marked primitivity of the culture as compared with the Silval, and partly from the historically proved and reasonably inferred later intrusions of the Tupi and of Tupi culture into the area.

We may also call attention in passing to the fact that, apart from the Carib Pimenteira and (Carib or independent stock) Kariri in the eastern part of the highlands, the Carib and Arawak tribes of the upper Xingú, the Arawak Guana and Tereno of the upper Paraguay—all of these last four on the far western borderlands of the highlands—and the Karayá of the Araguaya River, the Tupi are the only or almost the only people of horticultural or of typical Silval culture who border on and are intrusive into this whole great highland and savanna section of eastern Brazil.<sup>32</sup> Lift Tupi peoples and Tupi influence from the

<sup>30</sup> Cooper, 1917, pp. 223-226; 1924, pp. 411-414; Lothrop, 1928, pp. 110-115, 178-197, 198-212; Bird, 1938. The results, published since the above was in proof, of Bird's more recent excavations along the north Chilean coast show, however, some important contrasts between the earlier Chilean coastal cultures and the modern Yahgan and Alacaluf (Bird, 1943).

<sup>31</sup> Ploetz and Métraux, 1929, pp. 227-234; Snethlage, 1930. Among the foregoing peoples of eastern Brazil, the Gê may turn out to be partly retrogressed Silvals, to judge from the trend of the evidence within the last couple of years.

<sup>32</sup> Nimuendajú's 1937 and 1942 unpublished maps of the area are our best and most complete ones. Cf. also maps previously listed in footnote 7.

area and there remains an almost unbroken vast region of nonhorticultural Marginal culture in the east from the lower Amazon to the La Plata.

The Bororó likewise give every indication of being a fundamentally Marginal culture overlaid only lightly by Silval elements. The Tupi-speaking Guayakí in the midst of Tupi peoples but with a culture sharply contrasting at almost every point with the Tupi, seem to be either remnants of prehorticultural Tupi or else a group later Tupiized as regards language but preserving a pre-Tupi culture. The Guató are somewhat problematical but both the archeological and the ethnological evidence suggests cultural tarriance in their case rather than retrogression.

Upon the Chaco peoples have rained influences from east, north, and west, many of these influences certainly of post-Columbian date. The reasonable assumption is that in times prior thereto and not very remote the Chaco peoples were closely akin in culture to the Charrua of the Uruguayan plains and to the Puelche-Querandí of the Argentine Pampa. Moreover a considerable number of widespread Chaco cultural elements, such as skin clothing, the hairbrush, the sinew bow-string, suggest rather strongly cultural kinship with the peoples of the Pampas and Patagonian plateau to the south.<sup>33</sup> At any rate the peoples of the Chaco, of the Uruguayan plains and of the Pampas have a relatively very simple culture as compared with the more elaborate Silval culture, and there is no evidence whatever to suggest that this simplicity has been the result of cultural retrogression.

It looks, too, as if the internally Marginal peoples scattered here and there in the Silval belt, or at least most of them, may be cultural tarriants from pre-Silval times. The marked simplicity of their culture contrasting sharply with that of the Silval, the absence of evidence of retrogression, except perhaps with the Mura, the scattered type of distribution, and, in some cases, specific historic evidence, all suggest that these peoples are earlier occupants of regions near where they now are, who have been driven forward, conquered, scattered, penetrated, or surrounded, and in some cases profoundly influenced culturally and linguistically by later-coming Silval Arawak, Carib, and Tupi, as well as other peoples of Silval culture. Such is the view, from first-hand study in the field, of Koch-Grünberg, as regards the Schirianá, Waíka, and Makú,<sup>34</sup> although it is possible that what he took for definite recent historical tradition may have been legendary tribal lore. Some of these people, too, seem to differ somewhat somatologi-

<sup>33</sup> Nordenskiöld, 1919, pp. 259-261; Lathrop, 1932, pp. 188-189; Palavecino, 1934, p. 229.

<sup>34</sup> Koch-Grünberg, 1906a, p. 878; 1906b, pp. 180-181; 1922, pp. 226, 260-262, 265-266; 1923, pp. 15-16, 284, 299-300, 307. Cf. Nordenskiöld, 1924, p. 233, Siriono tribe "represents perhaps a remnant of the original population" [of northeastern Bolivia].

cally from the surrounding peoples of Silval culture.<sup>35</sup> Certain cultural correspondences, too—such, for instance, as the extremely long bows found among the Sirionó and among many of the Brazilian highland Marginals—appear significant, and as far as they go, suggest Marginal tarriance with later Silval cultural intrusion. But our information on most of these internally Marginal groups is at present woefully fragmentary. We may say in passing that perhaps no more urgent task in South American ethnology clamors for attention than that of thorough field investigation of these very simple peoples scattered here and there through the Silval belt.

(b) Pan American evidence.—The foregoing South American evidence for the priority of the Marginal culture or cultures to the Silval is appreciably corroborated by the Pan American evidence. A very considerable number of specific and diagnostic cultural elements found in South America, particularly though not exclusively among the Marginal peoples, largely disappear in Silval South America and in Middle America, and then reappear in North America, and in a number of cases even in northeastern and northern Asia.

Nordenskiöld first called attention to the phenomena and their probable significance nearly three decades ago. In his final paper on the subject published shortly before his death in 1932, he listed 64 such elements. Krickeberg later barred or fused some of these but added about 25 others. Loeb, Schmidt, and von Hornbostel called attention to certain specific correspondences in puberty rites, religion, and musical style respectively. A number of striking resemblances in folk lore have been noted by Lowie, Métraux, and others.<sup>36</sup> To the above lists the present writer can add about 15 or 20 further items. All in all, we have before us about 100 or more such North-South correspondences.

Of these, some—such as family hunting territories or the use of skin garments, of crutchless paddles, of plank houses and plank boats—should best be left out of count, as they are not specific enough, or else may well be chance convergences, or convergent functions of similar natural environment or basic *Wirtschaft* in the far north and far south of the continent. Some few of them, too—such as scalping, the hollow rattle, sandals, the husking peg—may quite possibly be the result of independent diffusion from horticultural cultures. But a great many of them, probably a good majority, cannot seemingly be

<sup>35</sup> Koch-Grünberg, 1906a, p. 878; 1906b, p. 180. The Sirionó are assumed by Eickstedt, 1934, pp. 758, 855, so to differ, but such differences as exist may well be due to intrusions of white and Negro blood to which reference is made by Cardús, 1886, p. 280. Cf. Outes, 1924. Definitive conclusions on the Sirionó will have to await the completion of Allen Holmberg's field study now in progress.

<sup>36</sup> Nordenskiöld, 1912a, 1931, pp. 6–15, 74, 77–94 (cf. same, 1926; 1930, pp. 163–165); Krickeberg, 1934; Loeb, 1931, pp. 532–533; W. Schmidt, 1929, pp. 1008–1033; von Hornbostel, 1936 (cf. Danckert, 1937); Lowie, 1937, pp. 194–195; 1940a, pp. 421–422; Métraux, 1939 (cf. Palavecino, 1940); Luomala, 1942.

accounted for on any of the foregoing grounds. Such, for instance, are: Thread-tattooing; fire making by the percussion method; sundial and inclined-stick traveling signs; the association of head-scratcher, drinking tube, hoof rattle, ashes (charcoal), foot race in early morning, and gathering firewood with girls' puberty rites; the remarkable grouping of games—hockey, lacrosse, ring-and-pin, hoop-and-pole, dart game, battledore, dart sticker, dice—in the Brazilian highlands and particularly in the Chaco; the perhaps still more striking occurrence of a large number of very specific folk-lore motifs, especially in the Chaco.

These very numerous and quite specific phenomena appear best accounted for on the hypothesis that the Marginal peoples of North and South America, or many of them, have retained much from a common cultural ancestry of archaic days prior to the rise and spread of the more advanced material arts on the continent. In other words the Marginal cultures of South America, or many of them, are more primitive than the Silval, in the sense that they in appreciable measure represent cultural tarriance with partial retention of pattern from times anterior to the development of the Silval.

Added weight accrues to this inference from the fact that a certain number of these North-South correspondences—such as thread-tattooing and the ring-and-pin game—are shared as well by some of the Marginals of northern Asia.<sup>37</sup> A certain amount of further support is derived from archeology—as for example, the consistent absence of head deformation and sporadic absence of the dog, among earlier populations, as among modern Marginals, of North or South America or both.<sup>38</sup>

(2) *Somatological evidence.*—Somatological data cannot as a rule be cited as evidence in the cultural court. But the fact that so many of the peoples of the Marginal belt appear more or less closely related physically to the earliest physical type so far recorded on the South American continent, does seem to corroborate, as far as it goes, the cultural evidence for the primitivity of the Marginal culture itself. So related physically to the ancient Lagoa Santa-sambaqui type are the modern Yahgan and Alacaluf together with the Ona and Tehuelche, as also many at least of the living Marginal peoples of the Brazilian highlands, and some perhaps of the other Marginal peoples.<sup>39</sup>

(3) *Geographical evidence.*—Geographically the externally Marginal peoples are in the main in more remote areas of the continent, farthest removed from the doorways of ingress to the continent via Panama and the Antilles, and farthest removed by sheer distance as

<sup>37</sup> Birket-Smith, 1929, pt. 2, passim.

<sup>38</sup> On absence of head deformation, cf. Stewart, 1940; Nordenskiöld, 1931, p. 73; Imbeloni, 1934; Lovén, 1935, pp. 488–490; Harrington, 1921, vol. 2, p. 386.

<sup>39</sup> Hrdlička, 1912, pp. 179, 183; Eickstedt, 1934, p. 756–759.

well as by natural barriers from the cultural influences of the advanced civilizations of the continent. Most of the internally Marginal peoples are likewise in remoter "refuge" areas of the tropical rain forest.

#### 4. THE QUESTION OF OLD WORLD INFLUENCE

Within the limits of a short paper like the present, which has already gone far beyond the length originally planned, it is not possible to enter into a detailed review of the evidence bearing on this supercomplicated problem. And unless the evidence pro and con is discussed in minute detail and against a pan-continental and even world-wide background, discussion of it is all but futile. The ablest treatment of it which has yet appeared is, to the present writer's best judgment, that by Nordenskiöld, to which the reader is referred for details.<sup>40</sup> Without entering into the minutiae of the controversy and merely to fill out some of the main lines of culture sequence in South America, we shall confine ourselves to the briefest statement of the conclusions which, in the view of Nordenskiöld and of most of us interested in the problem, seem to follow from such evidence as we have.

The earliest prehistoric human migrants from northeastern Asia to the American continent brought with them their heritage of Old World "paleolithic" culture. Beyond, however, this initial heritage from Old World culture, there appears no convincing or even good probable evidence for appreciable accretions in pre-Columbian days to South American culture through the migration from the Old World either of peoples or of cultures, whether by a northern route across Bering Strait or the vicinity thereof or by a southern route across the Pacific.

Our evidence regarding an element here and there, such as the sweetpotato, the calabash, or the coconut, makes plausible—though far from proved—the assumption of sporadic pre-Columbian cultural contacts between Oceania and South America.<sup>41</sup> But the inference that there has been notable or basic pre-Columbian Old World influence upon South American culture, as maintained by the Heliolithic and Kulturkreis schools,<sup>42</sup> seems to rest on extremely weak positive evidence and furthermore to be in conflict at scores of crucial points with our massive ethnological and archeological evidence. The resemblances on which these two schools mostly rest their respective cases seem far too few, too scattered, and too vague to justify conclusions of large-scale diffusion from the Old World to the New by

<sup>40</sup> Nordenskiöld, 1931, pp. 16-53.

<sup>41</sup> Nordenskiöld, 1931, pp. 27-30; Dixon, 1932; cf. Cook, 1910.

<sup>42</sup> W. Schmidt, 1913; Smith, 1929. Cf. critiques in: Dixon, 1928, chap. 7 and passim; Lowie, 1937, chaps. 10-11. For most recent exposition of Rivet's theories of Oceanic influence in aboriginal South America, see Rivet, 1943.



the Oceanian or any other route. Apart from the initial "paleolithic" (in the sense of "prehorticultural") inheritance, apart from a possible stray pre-Columbian accretion here and there, and apart from obvious post-Columbian influences, the culture of aboriginal South America gives every indication of being home-grown.

#### SUMMARY

In attempting to discover and reconstruct the broad lines of cultural sequence on the South American continent we have resorted to the stripping process, following reverse chronological order.

Since the coming of the white man, four-and-a-half centuries ago, a large group of important elements of European provenance, and a very limited group of minor elements of Negro origin, have spread widely over the continent or parts thereof.

Since our more or less arbitrary date of about A. D. 1000 or since, in round numbers, about a millennium ago, a half-dozen major cultural diffusions or drifts have occurred—the Inca and pre-Inca within the Andean area, from the Southern Andean (Araucanian) out into the Pampean and Patagonian, from the Silval (mostly Tupi) into and around the Brazilian highlands, and (Arawak-Carib) into the West Indies—and other minor diffusions, such as those from the Silval and Sierral into the Chaco, from the Sierral into the Silval, and a great number, not dealt with in the present paper, of more localized ones within the Sierral, Silval, and Marginal respectively.

Earlier, perhaps around the beginning of the Christian Era or maybe long before, came the beginnings of horticulture in the Silval or Sierral area or both, and together with associated or subsequent more advanced material arts and divergent social and religious structures and usages spread out over the western, northern, and central regions of the continent, penetrating to about the limits of the arable land in the Sierral area and of the tropical and subtropical rain forests of the Silval. These cultural drifts, however, left relatively untouched the cultures of the great eastern and southern open-country belt, and seemingly, too, a number of archaic cultural islands here and there within the Silval area as represented by the internally Marginal peoples still surviving there, and even within the Sierral as represented by the coastal Chango.

Still earlier, between the remote first migration or migrations of man to the continent—perhaps 10,000 to 25,000 years ago—and the beginnings of aboriginal American horticulture, the original "paleolithic" culture of these earlier immigrants was carried by them over all or most of both North and South America as they deployed out over forest and open country, highlands and lowlands. Some of

the very early culture, perhaps even of the earliest, survived, and has been retained down to the present. Much or most of it suffered more than a sea change, in the process of adjustment to varying new external environments and under the impulsion of internal forces.

#### TENTATIVE PREHISTORICAL RECONSTRUCTION

Before bringing this paper to a close, it seems worth while, at the risk of some repetition but in the interests of clarity, to give a résumé in chronological order of what, for purposes of discussion, has been dealt with in inverse temporal order. In doing so we are venturing to fill out the picture a little by adding a few details only implicitly or incidentally touched upon in the preceding pages. Some of these details in the following attempted reconstruction of the broad lines of culture growth on the South American continent—and in a certain sense the basic reconstruction itself—must of necessity, in view of the many lacunae in our evidence, be tentative and provisional only. Workers in the natural sciences take for granted that it is legitimate to formulate provisional theories, if only as working hypotheses. Why may not the cultural anthropologist do the same, provided he keeps reasonably close to his evidence and proposes his reconstructions as provisional only and not as established verities? There is a *via media* between giving free rein to fancy and speculation and setting up tentative hypotheses to be tested.

The long-headed earlier peoples of the South American continent must have reached it from North America either by way of the Isthmus of Panama or across the Antilles route. How many thousand years ago this occurred there is no very definite evidence for concluding—possibly only the 4,000 which Spinden allows, perhaps some thousands of years earlier as suggested by our linguistic data, and by some of the more recent archeological evidence for South as well as North America.<sup>43</sup>

Man on his arrival in South America had in all probability a very simple culture without agriculture, weaving, or pottery, without alcoholic intoxicants or tobacco, and, judging from its earlier absence from the extreme southern tip of the continent and its modern absence from a great many other peoples of the Marginal and Silval belts, quite possibly, too, without the dog. Fire in the early stages was more likely by the percussion method as well as by the drill. Boiling with hot stones was practiced. Body painting and depilation went along with the use of the brush comb. Head deformation was lacking. The autonomous politico-economic unit was the small band, mostly composed of kin, each band with its own more or less circumscribed sovereign territory. Sibs, moieties, age classes, marked social stratification,

<sup>43</sup> Spinden, 1937; Bird, 1938; Roberts, 1940.

and powerful chieftaincy were probably absent, although there is some question regarding moieties and age classes in view of the recent Gê evidence. The family was the basic social unit, polygamous or prevalently monogamous in form, with probably some strict or fairly strict monogamy in groups here and there. Esthetic culture was weakly developed; recreative, very slightly organized. Religion was most probably a combination of shamanistic, magical, animistic, and theistic concepts and practices, with relatively less manism. The probable later derivation of the hollow rattle from the Silval culture and the actual absence of rattles of any kind south of the Strait of Magellan suggest that the rattle, at least the hollow rattle, was not part of the earliest magico-religious culture.

The marked dominance of weapons like the sling, club, spear, and spear thrower over most of the Andean area to Cape Horn contrasting broadly with the dominance of the bow and arrow and unheaded club over most of the area east of the Andes, seems to point toward two great more or less independent cultural drifts in the western and eastern regions of the continent, drifts which may well date back to remote archaic times.

For some hundreds, and perhaps thousands, of years the South American continent was occupied by peoples of such simple culture as has been above outlined, a culture partly preserved in varying degrees until the present or until very recent times here and there in the Sierral and Silval regions, and over most of our open-country belt. During, however, these centuries or millennia countless major and minor local and tribal cultural divergences developed within this pre-horticultural pattern.

At the latest during the first millennium B. C. and perhaps much earlier, came the beginnings of horticulture, together with more or less sedentary village life, alcoholic intoxicants and tobacco, weaving, pottery, and other more advanced material arts. Whether horticulture first reached South America via the Isthmus from Middle America, or originated independently south of the Isthmus, is an open question, although some of our recent evidence seems to be a little more favorable to the theory of South American origin. Middle America's claim to be the birthplace of maize cultivation is being sharply challenged. Then, too, at least some weight is given to Peru's claim to priority from the marked variety of plants, about 70 in all, cultivated there in pre-Discovery times. Or else the domestication of plants on the southern continent may have begun as root-tuber horticulture, with perhaps white potatoes in the central Sierral region, or with manioc somewhere in the Silval.

In any case, waiving as still sub judice the question of the exact locality or localities of its origin, horticulture in South America

seems to have later diffused in two main streams: one, carrying chiefly maize, beans, and white potatoes until it covered the western belt from Colombia to Chiloe; a second one carrying chiefly manioc and beans until it extended over the great rain forests of the Orinoco-Amazonian region and flooded out over the Antilles.

At later dates, mostly after our more or less arbitrary one of A. D. 1000 and in many sections even after the coming of the white man, this basically manioc culture spread around and deeply penetrated into the eastern Brazilian and Matto Grosso highlands, diffused into parts of the Chaco, and swept over many of the savannas within and adjacent to the tropical rain forests—areas until then occupied by nonhorticultural Marginal peoples.

In general, it looks as if the typical larger groups of the Silval belt—especially the Carib, Arawak, and Tupi—pretty consistently kept in their spread to the tropical and subtropical rain forests, penetrated to the limit thereof, and stopped short at the savannas and grasslands. They stayed in the deep forests and avoided the open country. Even the Tupi-speaking Chiriguano on their western trek out of the Paraguay country across the Chaco, settled, not in the open Chaco region, but in the forested foothills and lowlands bordering thereon.

For the beginnings of the high civilizations of the Sierral region, archeology has so far yielded us no well-established dates, nor has it determined definitively how much of this more advanced culture may have had its origin north of the Isthmus. Such facts as we have can be fitted comfortably within the assumption that Sierral civilization, with its advanced weaving, pottery, metallurgy, megalithic architecture, and political institutions—to mention only a few of its outstanding characteristics—does not date in its origin or origins beyond the beginning of the Christian Era. At least there is no specific evidence for an earlier date.

Assuming, albeit with reserves, an origin or origins of Sierral civilization around the first centuries of the Christian Era, this pre-Inca higher culture developed and flourished for about a millennium.

Then, somewhere between about A. D. 1100 and A. D. 1300 came the rise of Inca imperialism which, during the generations immediately preceding the coming of the Spaniard, carried its truculent conquests as well as its characteristic culture from around Cuzco to the north as far as northern Ecuador, to the south as far as the Rio Maule in middle Chile, and out into the Diaguita country in northwestern Argentina.

Apart from this main area of diffusion of earlier Andean and later Inca civilization, Sierral culture in diluted form spread to the Araucanians of middle and southern Chile, partly in pre-Columbian times, partly in post-Columbian. In post-Discovery days, this diluted Andean culture was carried by the Araucanians far to the east of the

southern Andes—by the middle of the eighteenth century, through actual Araucanian invasion, to the peoples of the Pampa, and, sometime between 1670 and 1741, through Araucanian contacts, to the Tehuelche of Patagonia as far south as the Strait of Magellan.

Such in brief appear to be the broad lines of aboriginal South American cultural evolution, as far as our available somatological, linguistic, ethnological, archeological, and historical evidence reveals them. Some of this reconstruction is derived from dated historical documents. Much of it rests on evidence that yields temporal inferences of from reasonable to high probability. But on many points our data are pathetically meager, and the provisional reconstruction we have ventured to propose will in all likelihood have to be revised not only in many of its details but also in some of its major lines long before the several kindred disciplines concerned shall have gleaned their last fact and spoken their last word.

## BIBLIOGRAPHY

- BATES, H. W.  
1892. *The naturalist on the river Amazon*. Reprint. London.
- BERGSØE, P.  
1937. *The metallurgy and technology of gold and platinum among the pre-Columbian Indians*. (Translated by C. F. Reynolds.) Copenhagen.  
1938. *The gilding process and the metallurgy of copper and lead among the pre-Columbian Indians*. (Translated by C. F. Reynolds.) Copenhagen.
- BERNATZIK, H. A., AND OTHERS.  
1939. *Die grosse Volkerkunde*. 3 vols. Leipzig.
- BIASUTTI, R.  
1912. *Studi sulla distribuzione dei caratteri e dei tipi antropologici*. Firenze.
- BIRD, J.  
1938. *Antiquity and migrations of the early inhabitants of Patagonia*. *Geogr. Rev.*, vol. 28, pp. 250-275.  
1943. *Excavations in Northern Chile*. *Amer. Mus. Nat. Hist., Anthrop. Pap.*, vol. 38, pt. 4, pp. 171-316.
- BIRKET-SMITH, K.  
1929. *The Caribou Eskimos*. 2 vols. Copenhagen.
- CARDÚS, J.  
1886. *Las misiones franciscanas entra los infeles de Bolivia \* \* \* en 1883 y 1884*. Barcelona.
- COLBACCHINI, A.  
No date (circa 1924). *I Bororos orientali "Orarimugudoge" del Matto Grosso (Brasile)*. Torino.
- COOK, O. F.  
1910. *History of the coconut palm in America*. *Contr. U. S. Nat. Herb.*, vol. 14, pt. 2.  
1921. *Milpa agriculture, a primitive tropical system*. *Ann. Rep. Smithsonian Inst. for 1919*, pp. 307-326.  
1925. *Peru as a center of domestication*. *Journ. Heredity*, vol. 16, pp. 32-46, 93-110.

## COOPER, J. M.

1917. Analytical and critical bibliography of the tribes of Tierra del Fuego. *Bur. Amer. Ethnol. Bull.* 63.
1924. Culture diffusion and culture areas in southern South America. *Compte Rend. 21e Congr. Internat. Américanistes*, pp. 406-421. Göteborg.
1942. The South American Marginal cultures. *Proc. Eighth Amer. Sci. Congr.*, vol. 2, *Anthropological Sciences*, pp. 147-160.

## DANCKERT, W.

1937. Musikethnologische Erschliessung der Kulturkreise. *Mitt. Anthropol. Ges. Wien*, vol. 67, pp. 53-57.

## DENIS, P.

1927. *Amérique du sud*. Paris.

## DIXON, R. B.

1923. *The racial history of man*. New York and London.
1928. *The building of cultures*. New York and London.
1932. The problem of the sweet potato in Polynesia. *Amer. Anthrop.*, vol. 34, pp. 40-66.

## EICKSTEDT, E. VON.

1934. *Rassenkunde und Rassengeschichte der Menschheit*. Stuttgart.

## ESSAYS IN HISTORICAL ANTHROPOLOGY OF NORTH AMERICA.

1940. *Smithsonian Misc. Coll.*, vol. 100.

## FEWKES, J. W.

1907. The aborigines of Porto Rico and neighboring islands. 25th Ann. Rep. *Bur. Amer. Ethnol.*

## FRIEDERICI, G.

1920. Review of Nordenskiöld, 1919. *Gött. Gel. Anzeig.*, vol. 182, pp. 185-189. Berlin.
1932. Review of Nordenskiöld, 1931. *Ibid.*, vol. 194, pp. 350-355.

## GILLIN, J.

1940. Some anthropological problems of the tropical forest area of South America. *Amer. Anthrop.*, vol. 42, pp. 642-656.

## GUSINDE, M.

1931. *Die Selk'nam*. St. Gabriel-Mödling bei Wien.
1937. *Die Yamana*. St. Gabriel-Mödling bei Wien.
1939. *Anthropologie d. Feuerland-Indianer*. St. Gabriel-Mödling bei Wien.

## HAECKEL, J.

1938. Zweiklassensystem, Männerhaus und Totemismus in Südamerika. *Zeitschr. Ethnol.*, vol. 79, pp. 426-454.

## HARRINGTON, M. R.

1921. *Cuba before Columbus*. 2 vols. *Indian Notes and Monographs*, Mus. Amer. Indian, Heye Found.

## HAY, C. L., LINTON, R. L., LOTHROP, S. K., SHAPIRO, H. L., and VAILLANT, G. C. (editors).

1940. *The Maya and their neighbors*. New York and London.

## HENRY, J.

1941. *Jungle people: a Kaingáng tribe of the highlands of Brazil*. [New York.]

## HORNOSTEL, E. M. VON.

1936. *Fuegian songs*. *Amer. Anthrop.*, vol. 38, pp. 357-367.

## HOWARD, E. B.

1936. An outline of the problem of man's antiquity in North America. *Amer. Anthrop.*, vol. 38, pp. 394-413.

HRDLÍČKA, A.

1912. Early man in South America. *Bur. Amer. Ethnol. Bull.* 52.

IMBELLONI, J.

1934. América: cuartel general de las deformaciones craneanas. *Act. y Trab. Cient.* 25o Congr. Internac. Americanistas, La Plata, 1932, vol. 1, pp. 59-68. Buenos Aires.

1937. Razas humanas y grupos sanguíneos. *Rel. Soc. Argentina Antrop.*, vol. 1, pp. 23-42.

IZIKOWITZ, K. G.

1935. Musical and other sound instruments of the South American Indians. Göteborg.

JAMES, P. E.

1942. Latin America. New York.

JOHNSON, F.

1940. The linguistic map of Mexico and Central America. *In* Hay and others, editors, *The Maya and their neighbors*, pp. 88-114.

JONES, C. F.

1930. South America. New York [1940].

KIDDER II, A.

1940. South American penetrations in Middle America. *In* Hay and others, editors, *The Maya and their neighbors*, pp. 441-459.

KIRCHHOFF, P.

1931. Die Verwandtschaftsorganisation der Urwaldstämme Südamerikas. *Zeitschr. Ethnol.*, vol. 63, pp. 85-193.

KLIMEK, S., and MILKE, W.

1935. An analysis of the material culture of the Tupi peoples. *Amer. Anthropol.*, vol. 37, pp. 71-91.

KOCH-GRÜNBERG, T.

1906a. Die Makú. *Anthropos*, vol. 1, pp. 877-906.

1906b. Die Indianerstämme am oberen Rio Negro und Yapurá and ihre sprachliche Zugehörigkeit. *Zeitschr. Ethnol.*, vol. 38, pp. 166-205.

1922. Die Völkergruppierung zwischen Rio Branco, Orinoco, Rio Negro und Yapurá. *In* *Festschr. Eduard Seler* (W. Lehmann, editor), pp. 205-266. Stuttgart.

1923. Vom Roroima zum Orinoco, Band III, *Ethnographie*. Stuttgart.

KRICKEBERG, W.

1922. Die Völker Südamerikas. *In* G. Buschan, editor, *Illustrierte Völkerkunde*, vol. 1, pp. 217-423. Stuttgart.

1934. Beiträge zur Frage der alten kulturgeschichtlichen Beziehungen zwischen Nord- und Südamerika. *Zeitschr. Ethnol.*, vol. 66, pp. 287-373.

1939. Südamerika. *In* Bernatzik and others, *Die grosse Völkerkunde*, vol. 3, pp. 95-258, 288-292.

KRIEGER, H. W.

1935. Indian cultures of northeastern South America. *Ann. Rep. Smithsonian Inst. for 1934*, pp. 401-421.

LATCHAM, R. E.

1910. ¿Quiénes eran los Changos? *An. Univ., Santiago de Chile*, vol. 126, pp. 377-439.

LÉVI-STRAUSS, C.

1936. Contribution à l'étude de l'organisation sociale des Indiens Bororo. *Journ. Soc. Amér. Paris*, n. s., vol. 28, pp. 269-304.

## LOEB, E. M.

1931. The religious organizations of north central California and Tierra del Fuego. *Amer. Anthropol.*, vol. 33, pp. 517-556.

## LOTHROP, S. K.

1928. The Indians of Tierra del Fuego. *Mus. Amer. Ind., Heye Found., Contr.*, vol. 10.
1932. Indians of the Paraná delta, Argentina. *Ann. New York Acad. Sci.*, vol. 33, pp. 77-232.
1937. Coclé, pt. 1. Peabody Mus. Amer. Arch. and Ethnol., Mem. 7. Cambridge.
1939. The southeastern frontier of the Maya. *Amer. Anthropol.*, vol. 41, pp. 42-54.
1940. South America as seen from Middle America. *In* Hay and others, editors, *The Maya and their neighbors*, pp. 417-429.

## LOVÉN, S.

1935. Origins of the Tainan culture, West Indies. Göteborg.

## LOWIE, R. H.

1937. The history of ethnological theory. New York.
- 1940a. American culture history. *Amer. Anthropol.*, vol. 42, pp. 409-428.
- 1940b. An introduction to cultural anthropology. Enlarged ed. New York.
1941. A note on the northern Gê tribes of Brazil. *Amer. Anthropol.*, vol. 43, pp. 188-196.

## LUOMALA, K.

1942. Review of Métraux, 1939. *Journ. Amer. Folklore*, vol. 55, pp. 188-190.

## MACCURDY, G. G. (editor).

1937. *Early man*. Philadelphia.

## MANGELSDORF, P. C., and REEVES, R. G.

1939. The origin of Indian corn and its relatives. *Texas Agr. Exp. Stat. Bull.* 574.

## MASON, J. A.

1938. Observations on the present status and problems of Middle American archaeology, pt. 2. *Amer. Antiquity*, vol. 3, pp. 300-317.
1940. The native languages of Middle America. *In* Hay and others, editors, *The Maya and their neighbors*, pp. 52-87.

## MEANS, P. A.

1931. *Ancient civilizations of the Andes*. New York and London.

## MÉTRAUX, A.

1927. Migrations historiques des Tupi-Guaraní. *Journ. Soc. Amér. Paris*, n. s., vol. 19, pp. 1-45.
1928. La civilisation matérielle des tribus Tupi-Guaraní. Paris.
- 1929a. Les Indiens Waitaka. *Journ. Soc. Amér. Paris*, n. s., vol. 21, pp. 107-126.
- 1929b. Études sur la civilisation des indiens Chiriguano. *Rev. Inst. Etnol., Univ. Nac. Tucumán*, vol. 1, pp. 295-493.
1939. Myths and tales of the Mataka Indians (The Gran Chaco, Argentina). *Etnol. Stud.*, vol. 9, pp. 1-127.

## NIMUENDAJÚ, C.

1938. The social structure of the Ramko'kamekra (Canella). *Amer. Anthropol.*, vol. 40, pp. 51-74.
1939. The Apinayé. *Catholic Univ. America, Anthropol. ser.* 8.
- 1942a. The Šerénte. (Translated from MS. by R. H. Lowie.) *Publ. Hodge Anniv. Publ. Fund, Southwest Museum, Los Angeles*, vol. 4.



## NIMUENDAJÚ, C.—Continued.

- 1942b. Map of tribal distribution, eastern and northeastern South America. Expansion of 1937 map. Unpublished. In Bureau of American Ethnology, Smithsonian Institution.

## NIMUENDAJÚ, C., and LOWIE, R. H.

1937. The dual organizations of the Ramko'kamekra (Canella) of northern Brazil. *Amer. Anthropol.*, vol. 39, pp. 565-582.
1939. The associations of the Šerénte. *Amer. Anthropol.*, vol. 41, pp. 408-415.

## NORDENSKIÖLD, E.

- 1912a. Une contribution à la connaissance de l'anthropo-géographie de l'Amérique. *Journ. Soc. Amér. Paris*, n. s., vol. 9, pp. 19-25.
- 1912b. De sydamerikanska indianernas kulturhistoria. Stockholm.
1917. The Guarani invasion of the Inca empire in the sixteenth century: an historical Indian migration. *Geogr. Rev.*, vol. 4, pp. 103-121.
1919. An ethno-geographical analysis of the material culture of two Indian tribes in the Gran Chaco. *Comp. Ethnogr. Stud.*, vol. 1. Göteborg.
1920. The changes in the material culture of two Indian tribes under the influence of new surroundings. *Ibid.*, vol. 2.
1924. The ethnography of South America seen from Mojos in Bolivia. *Ibid.*, vol. 3.
1926. En jämförelse mellan indiankulturen i södra Sydamerika och i Nordamerika. Reprint from *Ymer*. Stockholm.
1930. Modifications in Indian culture through inventions and loans. *Comp. Ethnogr. Stud.*, vol. 8. Göteborg.
1931. Origin of the Indian civilizations in South America. *Ibid.*, vol. 9.

## OUTES, F. F.

1924. Descripción de un cráneo Sirionó. *Physis*, vol. 7, pp. 190-212. Buenos Aires.

## OUTES, F. F., and BRUCH, C.

1910. Los aborígenes de la República Argentina. Buenos Aires.

## PALAVECINO, E.

1934. Areas culturales del territorio argentino. *Act. y Trab. Cient. 25o Congr. Internac. Americanistas*, La Plata, 1932, vol. 1, pp. 223-234. Buenos Aires.
1940. Takjuaj: un personaje mitológico de los Mataco. *Rev. Mus. La Plata*, n. s., Secc. Antrop., vol. 1, pp. 245-270.

## PERICOT Y GARCÍA, L.

1936. América indígena, vol. 1. Barcelona.

## PETRULLO, V.

1939. The Yaruros of the Capanaparo River, Venezuela. *Bur. Amer. Ethnol. Bull.* 123, pp. 161-290.

## PLOETZ, H., and MÉTRAUX, A.

1929. La civilisation matérielle et la vie sociale et religieuse des Indiens Žê du Brésil meridional et oriental. *Rev. Inst. Etnol., Univ. Nac. Tucumán*, vol. 1, pp. 107-238.

## RIVET, P.

1924. Langues américaines. In A. Meillet et M. Cohen, editors, *Les langues du monde*, pp. 597-712. Paris.
1930. Les derniers Charrúas. *Rev. Soc. "Amigos de l'arqueologia,"* vol. 4, pp. 5-117. Montevideo.
1943. Les origines de l'homme américain. Montreal.

ROBERTS, F. H. H., JR.

1940. Developments in the problem of the North American Paleo-Indian. *In* Essays in historical anthropology of North America, Smithsonian Misc. Coll., vol. 100, pp. 51-116.

ROUSE, I.

1939. Prehistory in Haiti. Yale Univ. Publ. Anthropol., No. 21.

SANTA CRUZ, A. M.

1940. Land tenure in pre-Inca Peru. New Mexico Anthropol., vol. 4, pp. 2-10.

SAPPER, K.

1934. Geographie der altindianischen Landwirtschaft. Petermanns Mitt., vol. 80, pp. 41-44, 80-83, 118-121.

SAUER, C.

1939. American agricultural origins: a consideration of nature and culture. *In* Essays in anthropology, presented to A. L. Kroeber, pp. 279-297. Berkeley.

SCHMIDT, M.

1905. Indianerstudien in Zentralbrasilien. Berlin.  
 1914. Die Guato und ihr Gebiet: Ethnologische und archäologische Ergebnisse der Expedition zum Caracara-Fluss in Matto-Grosso. Baessler-Archiv, vol. 4, pp. 251-283. Leipzig and Berlin.  
 1917. Die Aruaken: Ein Beitrag zum Problem der Kulturverbreitung. Leipzig.

SCHMIDT, W.

1913. Kulturkreise and Kulturschichten in Südamerika. Zeitschr. Ethnol. vol. 45, pp. 1014-1124.  
 1926. Die Sprachfamilien und Sprachenkreise der Erde, with Atlas. Heidelberg.  
 1929. Der Ursprung der Gottesidee, Band II. Münster i. W.

SERRANO, A.

1938. Los sambaquis o concheros brasileños. Rev. Inst. Antropol., Univ. Nac. Tucumán, vol. 1, pp. 43-89.

SMITH, G. ELLIOT.

1929. The migrations of early culture. Reprint. Manchester.

SNETHLAGE, E. H.

1930. Unter nordostbrasilianischen Indianern. Zeitschr. Ethnol., vol. 62, pp. 111-205.

SPINDEN, H. J.

1937. First peopling of America as a chronological problem. *In* G. G. MacCurdy, editor, Early man, pp. 105-114.

STEWART, T. D.

1940. Some historical implications of physical anthropology in North America. *In* Essays in historical anthropology of North America, Smithsonian Misc. Coll., vol. 100, pp. 15-50.

STOUT, D. B.

1938. Culture types and culture areas in South America. Michigan Acad. Sci., Arts, and Letters, Pap., vol. 23, pp. 73-86.

SULLIVAN, L. R., and HELLMAN, M.

1925. The Punin calvarium. Amer. Mus. Nat. Hist., Anthropol. Pap., vol. 23, pp. 309-324.

TASTEVIN, C.

1923. Les indiens Mura de la région de l'Autaz (Haut-Amazone). L'Anthropologie, vol. 33, pp. 509-533.

THOMAS, C., and SWANTON, J. R.

- † 1911. Indian languages of Mexico and Central America. Bur. Amer. Ethnol. Bull. 44.

THOMPSON, J. E.

1936. Archaeology of South America. Field Mus. Nat. Hist., Anthropol. Leaflet 33.

VELLARD, J.

- 1934-35. Les indiens Guayaki. Journ. Soc. Amér. Paris, vol. 26, pp. 223-292; vol. 27, pp. 175-244.

VON DEN STEINEN, KARL.

1894. Unter den Naturvölkern Zentral-Brasiliens. Berlin.

WALTER, H. V., CATHOUD, A., and MATTOS, A.

1937. The Confins man. In G. G. MacCurdy, editor, Early man, pp. 341-348.

WHITBECK, R. H., WILLIAMS, F. E., and CHRISTIANS, W. F.

1940. Economic geography of South America. 3rd ed. New York and London.

WISSLER, C.

1917. The American Indian. New York.

ZON, R., and SPARHAWK, W. N.

1923. Forest resources of the world. 2 vols. New York.



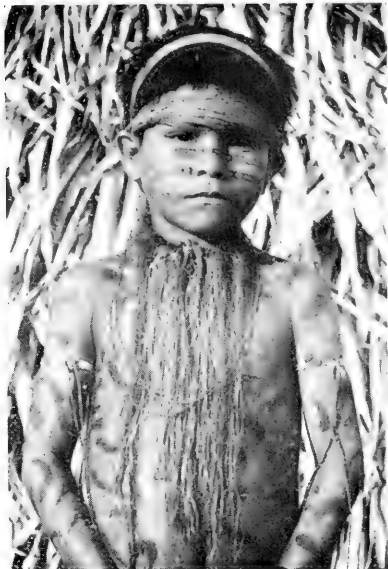

SILVAL PHYSICAL TYPES.

Upper left, headman of the Naravute, a tribe of the upper Xingú River region, eastern Brazil. (Courtesy Vincenzo Petruccio.)

Upper right, boy of the Yagua tribe, of northeastern Peru, with decorative face painting and palm-fiber forehead band and "bib." (Courtesy Paul Fejos.)

Lower, Yagua mother and child. Courtesy Paul Fejos.)



FOOD.

Upper, Wapisiána women of British Guiana grating cassava (*Manihot utilissima*) root, preparatory to squeezing out the juice which contains poisonous hydrocyanic acid. (Courtesy The University Museum, Philadelphia, Pa.)

Lower, Aymara gardening terraces at Ichu, Peru, in sierral territory. (Courtesy Alfred Kidder II.)

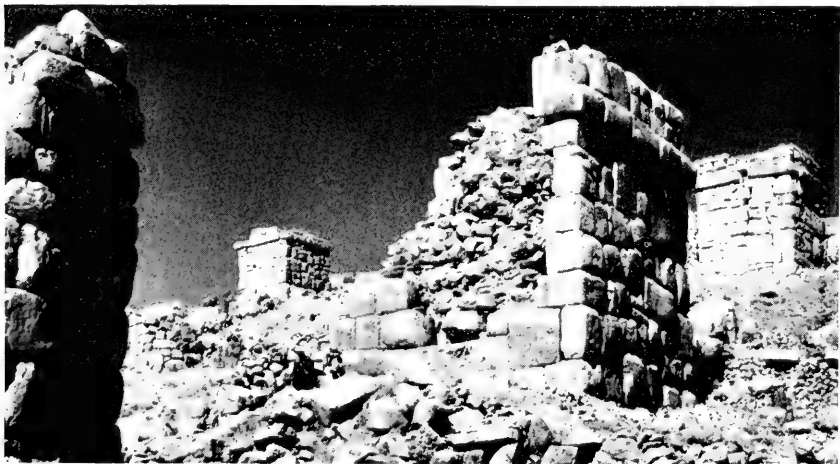

#### SHELTER AND CONSTRUCTION.

Upper, beehive hut of the marginal Yahgan, of the Magellanic Archipelago, the southernmost people of the world, now nearly extinct. (From Hyades and Deniker.)

Middle, half-completed dwelling of the silval Naravute, upper Xingú River, eastern Brazil, showing heavy timber framework. (Courtesy Vincenzo Petruccio.)

Lower, ancient part-ruined chulpas, used as burial places, at Kacha Kacha, Peru, showing a type of sierral dressed-stone construction. (Courtesy Harry Tschopik.)



THE LIGHTER SIDE OF LIFE.

Upper, a wrestling match, among the marginal Bororó, of Matto Grosso, Brazil. (Courtesy Vincenzo Petruccio.)

Lower, Yagua boy, of northeastern Peru, with pet monkeys. (Courtesy Paul Fejos.)



# ORIGIN OF FAR EASTERN CIVILIZATIONS: A BRIEF HANDBOOK<sup>1</sup>

---

By CARL WHITING BISHOP

*Freer Gallery of Art, Smithsonian Institution*

---

[With 12 plates]

## INTRODUCTION

### AIMS AND METHODS OF STUDY

Anthropology is that science which studies man in connection with his environment, physical, social, and economic. But to this end we must also lay under contribution many of its sister sciences, notably those of geology, climatology, biology, and history; for these too can throw light on various aspects of our problem—the career of mankind in ancient eastern Asia. The cultural significance of that part of the globe, moreover, like that of every other, can only be rightly understood if we view it in relation to the cultures of neighboring areas; while the growth of civilization there must, as always, be interpreted in terms both of time and of space.

### CHINA

*Physical environment.*—As a preliminary survey, we need to know in at least its main outlines the geography of China; since it was there that our particular phase of the great human drama began (Cressey, 1934, passim; Latourette, 1934, vol. 1, ch. 1).

As a glance at a map or, better still, a terrestrial globe will show, the area in question occupies a position marginal or peripheral to the Near East—the region where, as we now know, civilization first developed. Ever since fairly remote geologic times, however, these widely sundered areas have been linked by two great land routes or thoroughfares of migration and travel, vegetable, animal, and human. (See map, fig. 1). These pass in a generally east-and west direction to the north and to the south, respectively, of the lofty tableland of Tibet. The former route, that on the north, has in general played far the more

---

<sup>1</sup> Reprinted from Smithsonian War Background Studies, No. 1, Publ. 3681, June 10, 1942. The author died June 16, 1942.

important role in human history; but the latter, known in part as the now famous Burma Road, has come into renewed prominence of late.

The sea route between the Occident and the Far East did not come into use until much later, well on in the historical period—not, in fact, until sails and seagoing ships had long been known in the Near East.

*Surface features.*—Northern China is preeminently a vast, low-lying alluvial plain, bordered by the sea on the one hand, on the other by rugged areas that form the scarp of the central Asian plateau. The Ch'iu-ling chain of hills—dwindling outliers of the mighty K'un-lun Mountains of inner Asia—divides the basin of the Huai River from that of the Yangtze and forms a faunal, botanical, and historical boundary of great importance.



FIGURE 1.—The "stepe corridor" and the Far East.

Southern China, on the contrary, is in general hilly—in parts even mountainous; but its elevations do not form continuous, well-defined ranges.

*Loess soil.*—Over much of northern China, and extending far into central Asia, lies a thick mantle of loess soil (likewise found in other parts of the world, as for instance in many of our western States and portions of Europe). This type of soil, of a fine powdery consistency and grayish yellow in hue, is divided by geologists into two varieties, primary (eolian) and secondary (alluvial) loess. Of these, the first was deposited by the wind, in the form of dust, during the (geologically speaking) Recent epoch, since the close of the last ice age; while the second, a derivative of the first, has been laid down by water (which in this way, for example, created the great North China plains just mentioned). (Cressey, 1934, pp. 184–189 and passim; Anderson, 1934, passim.)

*Rivers and lakes.*—In northern China the rivers are “young” (again in the geologic sense) and are therefore subject to devastating floods. By far the largest is the Huang Ho or Yellow River, sometimes called “China’s Sorrow” on account of the terrible loss of life which it often causes. This stream rises in northeastern Tibet and is 2,500 miles in length. Too shallow and swift to be an important waterway, it has often altered its lower course; the most recent of these changes occurred less than a century ago. South of it flows the Huai River, much shorter, and the mouth of which has for the past few hundred years been cut off by the Grand Canal, so that it no longer flows directly into the sea.

The rivers of southern China, on the other hand, are “mature” in character, with deep, well-defined channels. The most important is the Yangtze, second in size and volume only to the Amazon, in South America. Like the Yellow River, it too rises in northeastern Tibet, and flows in a general easterly direction for 3,200 miles before it reaches the sea, near the present city of Shanghai. Its value as a highway of commerce is very great, and oceangoing steamers are able to ascend it for over 600 miles. In the early historical period it entered the sea through a delta with three mouths, now reduced to one.

The river systems of southeastern China are nearly all short and coastal, few of them extending back into the interior of China. There are likewise, especially in the center and north of the country, numerous lakes, some shallow and subject to seasonal fluctuations of outline, while others are deeper and more permanent in character.

*Flora and fauna.*—The great plains of northern China were before the dawn of history probably open grassland, with belts of timber along the streams and on the watersheds—much like our American prairies in aboriginal times. The Yangtze Basin and southern China in general, on the other hand, seem to have been covered with luxuriant subtropical forest continuous with that clothing Indo-China and much of India, and not unlike the one that once occupied the southeastern part of North America.

There are in eastern Asia two main zoological provinces, a northern and a southern. The boundary between these today extends, roughly, along the southern border of the Yangtze Basin; but in ancient times it ran at least as far north as the latitude of Peiping.<sup>2</sup>

Hence as late as the second millennium B. C. China had, even in the north, many large forms, such as the elephant, the rhinoceros, and the water buffalo, now living only in regions much farther south.

Eastern Asia was, in fact, during ancient times (before human activity had yet had time to produce its usual destructive effect) a region teeming with very many forms of wildlife, both animal and vegetable.

<sup>2</sup> This parallel, of very nearly 40° N. latitude, passes through northern California and central New Jersey on our side of the globe.

Among these, numerous species in both the animal and the vegetable kingdoms were closely related to others that we look on as especially characteristic of the New World. For instance, the only parts of the globe where the true alligator occurs today are North America and a small area on the Yangtze River. Many other examples of like nature might be cited.

There was—and still is—a bird life wonderfully rich in both number of individuals and variety of species, the latter including terrestrial, arboreal, and aquatic forms.

*Climate.*—The controlling factor in the climate of China—of all southeastern Asia, in fact—is the alternating occurrence of the monsoon winds and their influence on precipitation (Cressey, 1934, pp. 60–64 and *passim*). The summer monsoon, blowing steadily from the south, off the equatorial ocean, is warm and moist, whereas the winter monsoon, from the interior of the continent, is dry and bitterly cold. These distinctions are very marked, and their effect is to divide the year rather sharply into a hot, rainy summer and a cold, dry winter.

The Middle and Late Pleistocene periods, when the vast deposits of loess soil were being slowly formed, seem in general to have been much drier than now but to have been followed, during late prehistoric and early historic times, by an interval of rather greater rainfall and warmth than are found in northern China today. The general tendency for at least the past 1,500 years seems to have lain in the direction of growing aridity, interspersed with somewhat wetter phases. All these climatic fluctuations have influenced human activity in countless ways, the effects of which are still clearly visible.

#### ADJACENT LANDS

Northwest of China proper are the lofty plateau of Tibet and that nexus of mountain ranges forming the Pamirs, the “Roof of the World.” North and northeast of China extend the elevated plains of Mongolia and Manchuria, wooded on the east, bare and tending more and more to aridity on the west. Other lands—Indo-China, Korea, and numerous great island groups—lie to the west, south, and east. All these, together with China itself, form that part of the globe which we know collectively as the Far East. The region is one that is playing an increasingly large and important part in world history, as we all realize.

#### PRIMITIVE MAN

#### RACES OF EARLY MAN

It is still undetermined exactly where the human race originated, although we may at least be sure that it did so in the Old World, not in the New. Recent discoveries have revealed, however, that numer-

ous forms of man once existed, but that all save the one found today—*Homo sapiens*—eventually became extinct (Abbot et al., 1938, passim).

#### “PEKING MAN”

About one of these very early human types—whether or not directly ancestral to modern man is still disputed—we have been hearing much of late. This is the primitive creature commonly called “Peking man” (*Sinanthropus pekinensis*), which lived around the very beginning of the Pleistocene period, variously estimated at from 250,000 to 1,000,000 years ago.

#### MEN OF THE OLD STONE AGE

During the past few years also, traces of men of the Old Stone Age or Paleolithic period have come to light in eastern Asia, as, for instance, in northwestern China proper and on the borders of Mongolia. These people lived much later but still as early as the beginning of the deposition of the loess, not less than from 10,000 to 20,000 years ago. From this time onward until late prehistoric times there is a great gap in our knowledge of man in eastern Asia. Possibly he did not exist there at all then, the climate following the ice age being too unfavorable to permit living in that part of the globe by people still in a food-gathering (as opposed to a food-producing) stage of culture.

#### MORE RECENT RACES

##### NEGROID TYPES

In times much less remote from our own but still long before history began, southern Asia and some of the islands off its coast seem to have been inhabited by two dark-skinned races, one of pygmies, the other of a taller people, perhaps akin to the Papuans of New Guinea or to the aborigines of Australia.<sup>3</sup> This second race, some students have suspected, once extended its influence northward as far as Japan, there to contribute to the formation of the Ainu, still found in some of the northern islands of that archipelago.

##### A CAUCASOID TYPE

Somewhat later but still far back in prehistoric times, southeastern Asia and many of the East Indian islands seem to have been overrun by a brown-skinned race of Caucasoid type, perhaps distantly

<sup>3</sup> Of these pygmies, a few scattered remnants still exist, in the Malay Peninsula, the Andaman Islands, the Philippines, and elsewhere; and they are mentioned in old Chinese records. The larger Negroid race was perhaps best represented by the (recently) extinct Tasmanians.

related to the "Mediterraneans" of the west. This type may still be seen entering into the composition of the present population of the area; thus travelers often mention seeing individuals there with the aspect of southern Europeans.

#### MON-KHMER STOCK

The Mongoloid or yellow-brown variety of man seems to have become specialized somewhere in central Asia and to have spread thence outward, toward the sea. The first traceable members of this race in the Far East seem to have belonged to the Mon-Khmer linguistic stock, still found in many parts of southern Asia. They spread (or were driven) southward until they occupied much of southern China, Indo-China, parts of India, and apparently some of the islands. Physically they are shorter and darker than Mongoloid man in general, possibly on account of very early admixture with the pygmies already mentioned.

#### SINO-T'AI STOCK

Probably a good deal later than the Mon-Khmers came the speakers of the Sino-T'ai family of languages (to which, respectively, belong the Chinese and the Siamese). These two groups of speech are very closely related to each other, and this may account in part for the success of the Chinese emigrants to Siam.<sup>4</sup>

The Chinese ancestral stock spread, at some prehistoric time, over northern China (roughly, the Yellow River Basin), while the T'ai speakers occupied much of the Yangtze Valley. Southern China and Indo-China became more especially the home of the Mon-Khmers.<sup>5</sup>

Throughout the historical period, various forms of Chinese speech have been steadily supplanting both T'ai and Mon-Khmer in southern China or have driven them into Indo-China.

#### TIBETO-BURMAN STOCK

Yet another linguistic family, the Tibeto-Burman, is related to the Sino-T'ai group, although less closely than are the two branches of the latter to each other. As their name indicates, languages of the Tibeto-Burman family are today spoken mainly in Tibet and in Burma; but in ancient times they extended over much of northwestern China, and remnants of them still exist there. Physically this stock is very variable, though essentially Mongoloid in character.

---

<sup>4</sup> The Siamese like to call themselves *the* T'ai (or, less correctly, Thai); but they are by no means the only people speaking a T'ai language.

<sup>5</sup> All the groups of whom we are now speaking are today much alike in physical aspect, their distinguishing marks being more especially matters of speech, costume, and custom. This applies in very large measure also to the Japanese.

## NEOLITHIC PERIOD

*Characteristics.*—This stage of culture is characterized by the use of ground and polished stone for tools and implements, but it also marks a really tremendous step in man's progress; for it was then that he became a producer of food instead of depending, as he had always done hitherto, on what he could find for his nourishment, whether animal or vegetable. It was then that he began to domesticate various kinds of animals (except the dog, already associated with man far earlier) and different food plants.

This Neolithic phase of culture prevailed over practically the entire globe, only disappearing from different areas as civilization slowly diffused itself. This was true of eastern Asia as of every other region; thus the Ainu of the Kurile Islands, northeast of Japan proper, remained in that stage until well into the nineteenth century.

About the Neolithic period in western and southern China we as yet know little, for not a great deal of archeological work has been done there. Of that of northern China, Korea, and Japan, we know much more. The Neolithic inhabitants of these regions seem nowhere to have been pastoral nomads but invariably semisedentary planters. It is also interesting to note that in northern China at least the skeletal evidence shows the prehistoric population to have been directly ancestral to the present one.

Like the Neolithic culture of much of eastern Asia was the one that we find in northern China (Bishop, 1932a). There, however, it disappeared, or perhaps more accurately was submerged, under a developed civilization of Bronze Age type, with a knowledge of metal, considerably sooner than was the case in many adjacent lands. In parts of Mongolia, Manchuria, Korea, and Japan, for example, Neolithic cultures survived until the Christian Era and even longer.

In northern China this cultural phase spread over the entire country save for areas subject to seasonal inundation or too heavily timbered for easy clearing with stone tools. There as elsewhere (for instance in Europe), the Neolithic peasants sought more especially lands covered with loess soil, as being at once more fertile than others and less densely overgrown with trees and brush.

*Habitations.*—Habitations in northern China, as in so many other northern lands during this stage of progress, were pit dwellings or earth lodges, roughly circular in form and beehive-shaped, usually with a depth and diameter of around 10 feet, and entered from the top. (See pl. 2.)

The Chinese character *hsüeh*, now meaning a den or cave, in its ancient form clearly represents a vertical section of such a pit dwelling, with its domed and timbered roof (fig. 2). Archeology has in this instance, as in so many others, confirmed the evidence of epigraphy.

During the warmer months, which comprised the period of growth and also the rainy season, these pit dwellings seem to have been temporarily deserted for huts built in trees or on piles and aptly likened to "nests," situated near the cultivated patches.

No signs of fortification of any sort have been found; and in general the Neolithic peoples, in northern China at least, seem not to have been very warlike.

Villages of these underground huts were not occupied continuously over very many years. On the contrary, as soon as the soil of the vicinity had lost its fertility through the wasteful mode of cultivation then used, and which included clearing the ground with the aid of fire, villages were shifted to other localities with unexhausted soil.

*Tillage.*—Cultivation was probably carried on in common, perhaps mainly by the women for magical reasons connected with the idea of fertility. The implements used were digging sticks, hoes, mattocks, sickles, and perhaps spades, shod with stone or shell. (See pl. 3, fig. 1, and fig. 3.) The staple crop was common millet (*Panicum milia-*



FIGURE 2.—Modern and ancient forms of Chinese character for *hsüeh* (a den or pit dwelling).

*ceum*), and many mullets and mealing stones, used in preparing this grain for human consumption, have been found. Rice also was being grown in the Yellow River basin in Neolithic times; and there is some slight (though doubtful) indication that sorghum (kaoliang or giant millet—now an important food crop) was also known then.

Beer, brewed from millet and perhaps also from rice, may likewise have been made. The method used in early times to set up fermentation was that of chewing the grain and then steeping it in water.

*Animal husbandry.*—In its variety of domestic animals during this cultural stage, China was far poorer than was the Occident. The latter then had the ox, sheep, goat, pig, and dog. China, on the other hand, had only the two last, though toward the close of the period the ox, sheep and goats, and even the horse may have appeared (the horse, however, perhaps not as a domestic animal).

*Implements and clothing.*—Supplies of the right kind of stone for making tools and implements have always been of vital importance to Neolithic man everywhere. The most common implement in China, as in other lands, was the ground and polished stone celt, which occurs in two forms, the ax and the adz. A rectangular or semilunar stone knife had a very wide distribution, being found not only in northern



China but also in Siberia, Japan, and even as far afield as among the Eskimo. (See fig. 3.)

Arrow points were of stone, bone, and shell; and picks of deer antler similar to ones found in Europe also occur. Spindle whorls of clay or stone and perforated needles of bone show that at least sewing was known, and perhaps weaving also, for impressions of cloth on certain ancient Chinese potsherds may possibly date back to Neolithic times. Bark cloth like the Polynesian tapa seems also to have been made; and during the cold season furs were undoubtedly worn.

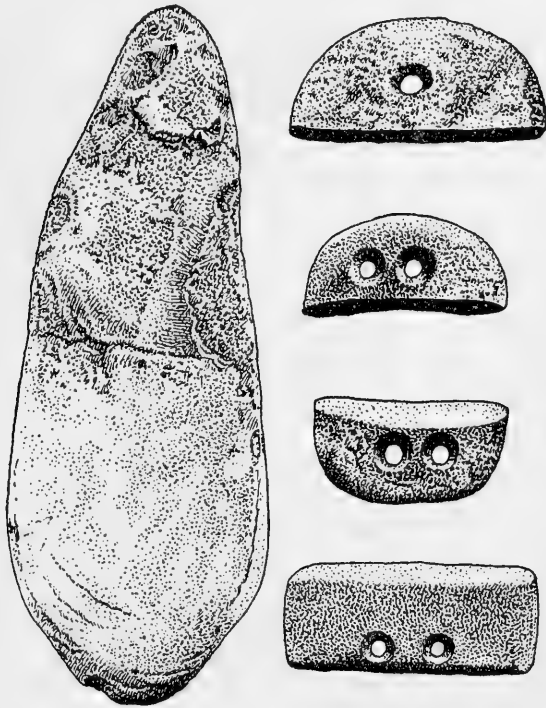

FIGURE 3.—Mattock and knives of stone, northwestern China.

*Pottery.*—Pottery was well known in eastern Asia during this culture phase. Broadly speaking, it falls into two great categories, a northern and a southern, the former usually ornamented in various ways, the latter most often plain.

The northern family is itself divisible into two classes. Of these, one is a coarse gray ware, sherds of which are found all over northern China and are closely akin to the pottery of the neighboring areas. Hand-made, often by the coiling process, it appears in a wide variety of forms. Ornamentation is incised, impressed, punctate, or applied, and the ware itself is as a rule poorly fired.

The other sort of northern ware, far finer in texture and apparently, in some instances at least, made on some rudimentary form of potter's wheel, likewise displays a wide range of shapes, which as a rule differ from those of the foregoing type. This finer ware occurs more especially along the great migration route from Chinese Turkistan across northern China to southern Manchuria. Varying in hue from a light bluff to a dark reddish brown, it is as a rule highly burnished; sometimes it bears simple geometric designs in color, most likely with some magical or symbolic meaning.

Both types of ware occur together, however, and seem to have been made by the same people. The Chinese burnished pottery gradually deteriorated and finally died out before the dawn of history. Not so, however, with the coarse gray ware; for this kept on being made, at least by the peasantry, until well within the Christian Era.

In northern and especially northeastern China there has also recently come to light a very fine black pottery, somewhat later than the kind just discussed. It was, however, still Neolithic; for no metal has been found with it. Its exact significance is not yet clearly understood.

*Trade.*—Trade seems to have been little developed in China then, for given communities were self-sustaining. No particular demand for imports had as yet arisen. Cowry shells from the southern sea-coasts and obsidian (volcanic glass) for certain implements must have been traded from considerable distances; so contacts of some sort must have existed, most probably of an indirect, "hand-to-hand" sort.

*Religion.*—Religion in northern China, as in most lands during the Neolithic period, most likely consisted of beliefs in magic and animism and in orgiastic ceremonies for the promotion of fertility in general. In these, women probably played a large part. In China as elsewhere, indications of human sacrifice and cannibalism have been found in this connection.

The bodies of the dead were buried in the earth; for cremation has never been general in China.

*Discussion.*—The Neolithic stage of culture in northern China lacked many of the elements that it needed to develop into a more advanced civilization. However, it long survived the advent of the Bronze Age, and formed the basis of the peasant culture of the latter period—just as it has done in large measure during even later times.

A word may be said here in regard to the influence of bamboo on cultural progress over so much of southeastern Asia. That plant (which anciently seems to have extended somewhat farther north than now) lends itself to such a wide variety of uses of all kinds that its presence appears to have acted as a definite deterrent to experimentation with other materials, and so to further progress. (See pl. 4).

The Neolithic period elsewhere in the Far East seems to have been similar in a general way to the one just discussed, though in most places without the burnished pottery. Nowhere were the people yet in a pastoral stage, with tending of flocks and herds as their means of livelihood. On the contrary, they were planters, though with more dependence on hunting and fishing than in northern China. Mongolia, for instance (which today we look on as preeminently a pastoral region), seems only to have adopted that type of culture when it acquired sheep and cattle (apparently from the west, to judge from the skeletal evidence); and nomadism proper after obtaining the horse, probably not long before the middle of the first millennium B. C. The effects of the acquisition by the Mongols of the latter cultural trait, incidentally, may profitably be compared with those that took place among our own Plains Indians when they got the horse from the Spaniards.

#### SOUTHERN CHINESE CULTURE

Southern China, Indo-China, Malaya, and the islands off the coast, like the Netherlands East Indies, Borneo, and the Philippines, had a somewhat different type of Neolithic culture, characterized by pile dwelling (see pl. 7, fig. 1), long dugout canoes, undecorated pottery, and in many if not all areas head hunting, tattooing, and ritual cannibalism. The peoples of these areas did some planting, more especially of leaf and root crops, but also depended greatly on fishing.

This southern culture made its way northward along the coast as far as southern Korea and western Japan, where its impress still survives. Eventually it reached a northern form of Neolithic culture more like the one just described.

#### CHALCOLITHIC PERIOD

##### TRANSITION BETWEEN STONE AND BRONZE AGES

Except in northwestern China, almost nothing is yet known about the transition from the Neolithic period to the Bronze Age. In Kansu, stone implements remained in use long after copper (or bronze?) arrow points and trinkets appeared, as signs of contact with metal-using peoples to the west. Burnished (and sometimes painted) pottery continued to be made, but was not as fine as before, and its designs tended to become naturalistic rather than geometric. Villages were now protected by earthen walls, suggesting an increase in warfare, perhaps even invasion from without.

In Shansi there has lately come to light still another Chalcolithic culture. This had a small amount of true bronze and also a different kind of pottery, bearing an impressed spiral design; and sheep seem

to have been the principal if not the only domestic animals. Little, however, is known of this new culture as yet.

#### DISTRIBUTION

Both Kansu and Shensi (for these provinces, see map of China, fig. 21), we should note, are situated along the eastern terminus of the more northern of the two transcontinental migration routes. (See map, fig. 1.) Hence the presumption that bronze and the herding of sheep had diffused themselves to China from the west (where both these culture traits had been known much earlier) becomes almost irresistible.

The Chalcolithic period in eastern Asia still forms a "dark age." In many areas, indeed, it probably never appeared at all, the transition from the Neolithic period to a fully developed Bronze Age or even to one of iron having been a direct one, without intermediate phases.

#### BRONZE AGE

##### GENERAL CHARACTERISTICS

A Bronze Age is by no means an invariable cultural phase everywhere on the globe. It has, on the contrary, been strictly limited in both time and space. Roughly it extended along the North Temperate Zone of the Old World, from the Atlantic to the Pacific. (See map, fig. 4.) Before it had had time to diffuse itself beyond this area, bronze had been overtaken and supplanted, save for limited uses, by that cheaper and more useful metal, iron.

#### DIFFUSION

The true Bronze Age, as distinct from the Chalcolithic period that ushered it in, began in the Near East some 6,000 or 7,000 years ago, and lasted until about 3,000 years ago, when it gradually gave way to the Iron Age. It reached western Europe and eastern Asia less than 4,000 years ago, and lasted there for about 1,500 years.

All the Bronze Age civilizations are based on the same set of fundamental elements. These were: the use of bronze itself for weapons and implements; possession of the common domestic animals, and cultivated plants; knowledge of the wheel and of animal traction; and some form of writing. The spread of these cultural traits took place in various ways, through war, trade, and migration, and of course took a long time. Our present civilization has spread far more rapidly, mainly as the result of improved means of communication and transportation. Witness, for example, the rapidity with which the airplane, invented hardly a generation ago, has reached all parts of the earth.

To return to the Bronze Age, however, the third and second millenniums, before our era were marked by great disturbances, widely felt in the Old World. The ancient kingdoms of the Near East fell, in most cases through invasion by peoples having war chariots and improved weapons of bronze. It was such peoples that overran and conquered Mesopotamia, Egypt, Asia Minor, northwestern India, and northern China. These movements, when traced backward, all point to the western end of the Eurasiatic steppe belt (see map, fig. 1) as their region of dispersion. Significant too is the fact that bronze weapons and war chariots appeared latest and survived longest at the two ex-

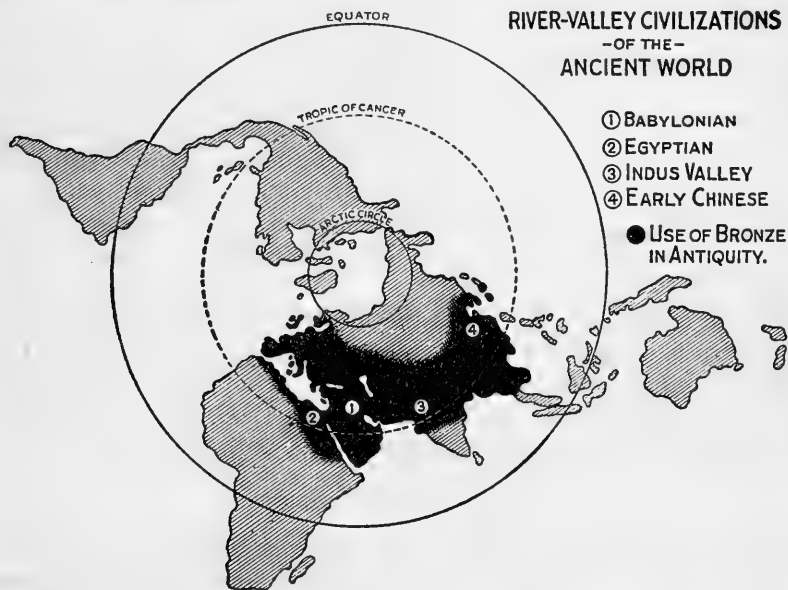

FIGURE 4.—River valley civilizations of the Ancient World, showing (in black) area of use of bronze.

tremities of their region of occurrence—in the British Isles in the west and in China in the east, having gone out of use slightly earlier in the latter region than in the former.

#### BRONZE AGE CIVILIZATIONS OF THE NEAR EAST AND OF CHINA

It is illuminating to compare and contrast the Bronze Age civilizations of the Near East and of China. In the former region the development of the Bronze Age has been traced step by step out of the antecedent Neolithic cultures into the fully developed metal-using civilizations of early historical times. This evolution required at least 4,000 years and in some particulars much more than that.

Thus in Babylonia, writing, wheeled vehicles, the ox-drawn plow, wheat, and all the common domestic animals except the horse, with a complete mastery of bronze working, all existed well before 3000 B. C. In China, on the other hand, there seems to have been no knowledge of the metals before around 2000 B. C. Yet only something like 500 years later we find the Yellow River basin occupied by an already well-developed Bronze Age civilization which had most (though not quite all) of the elements known to the Near East a thousand years or more earlier. This civilization must therefore have appeared in northern China during the first half of the second millennium B. C.

Thus not only did the Bronze Age begin in China many centuries later than in the Near East, but it survived there nearly a thousand years longer. Moreover the Chinese form had from the first, apparently, a well-developed system of writing, a very skilled knowledge of bronze working, and the same domestic animals and food plants (though not yet the ox-drawn plow) as in the Near East. Also it had wheeled vehicles and animal traction, including the use of horses to draw the chariot. The latter object, moreover, was used in exactly the same way as in the Near East, for pagentry, ceremonial, hunting, and war.

On the other hand, in China the local Bronze Age lacked certain traits characteristic of the same cultural stage in the Near East. Thus the Chinese had no dairy economy or weaving of woolen fabrics; and it was not until around the fourth century B. C. that the ox-drawn plow finally appeared there (Laufer, 1914-1915 *passim*).

#### CHINESE ORIGIN LEGENDS

Chinese legends about the origin of their civilization (the only one of which they knew in antiquity) have come down to us in late form, and do not represent genuine folk recollections, at least as they stand. They are not, however, mere inventions or fictions, but preserve, albeit in distorted form, the real beliefs held by their Bronze Age ruling classes about the beginnings of their civilization (Latourette, 1934, vol. 1, pp. 37-40; Bishop, 1934, p. 297):

The oldest traditions cluster about northwestern China, especially southwestern Shansi and central Shensi. This localization is significant; for the area in question is again—like the one just cited as that where the Neolithic painted pottery and traces of the earliest knowledge of metals in China occur—near the eastern terminus of the “corridor of the steppes.” (See map, fig. 1.) Archeologically and culturally, this region is by far the most important in eastern Asia.

#### THE HSIA DYNASTY

According to the orthodox Chinese accounts, the first dynasty was that of the Hsia, but of this we have neither contemporary records nor

identifiable archeological remains, and some have even doubted its existence. In later (but still fairly early) times, however, the Hsias seem to have been regarded as in some sort the forebears of the ruling class during the Chinese Bronze Age; and it seems most probable that they were an actual group, perhaps a local one (Creel, 1937, pp. 97-131).

#### THE SHANG DYNASTY

The second dynasty claimed by the Chinese was the Shang. Here we are on much firmer ground, for of this we have both actual remains and contemporary written records. The Shangs seem in the beginning to have been merely one of several bronze-using groups in northwestern China, located in southwestern Shansi if we may believe an early legend. Our oldest accounts—reduced to their present form centuries after the close of their period—declare that they shifted their capital several times.

Eventually however, perhaps about the sixteenth or fifteenth century B. C., we find them seated in the great North China plain, near the Yellow River. Here they established themselves, thenceforth to be for several hundred years the dominant group in that region. Either then or perhaps earlier the Shangs seem to have adopted numerous cultural features from the aborigines, descendants of the old Neolithic peoples; but essentially the Shangs themselves were a Bronze Age group, of rather primitive type.

In later times the Shangs were sometimes called the Yins; but there is no contemporaneous evidence that they ever applied that name to themselves.

With the Shangs, then, authentic Chinese history may be said to have begun <sup>6</sup> (Creel, 1937, chap. 3; Latourette, 1934, vol. 1, pp. 40-46).

*Nature of the Shang "empire."*—The Shang "empire" meant simply the area, mainly in the middle and lower Yellow River basin, in which they exercised a precarious supremacy over as many other groups (most of them probably with a similar type of culture) as they could hold in subjection. Thus it was a mere tribute-collecting machine of the same kind as the earlier "empires" of the Near East. No evidence exists of any effort on the part of the Shangs to set up a feudal, much less a bureaucratic, system of government—forms which seem indeed to have been quite beyond their political concepts.

The Shang rulers were not emperors but kings, of a primitive priestly type, though some of them seem to have been great war leaders as well. They were regarded by their subjects as intermediaries between mankind and the Unseen Powers and as responsible for the maintenance of the due course of Nature through their observance of the proper rituals

---

<sup>6</sup> Both Chinese and Occidental scholars agree that China's authentic and continuous history does not begin until the ninth century B. C., long after the Shang Dynasty had come to an end.

and tabus. Not the reigning king, however, but his deceased ancestors were the real power in the state. Their will was ascertained by divination, and elaborate worship was paid to them. Succession to the kingly office was of the fraternal type, from older to younger brother, not the filial one, from father to son, usual in later times.

*Habitations.*—Both the rural population and the city poor seem to have lived in round pit dwellings like those of their Neolithic ancestors already described. The ruling class built large rectangular timbered houses of developed type, with roofs supported by rows of wooden pillars with stone or bronze bases. (On this type of architecture, which has survived in China down to recent times, see pl. 12, fig. 2.) These structures, which in some ways recall the megaron house of ancient Greece, were sometimes erected on low platforms of rammed earth.

This last-named material was also used for walls about towns and enclosures, just as it still is in portions of China. This method of erecting walls and platforms is, or once was, common throughout the North Temperate Zone of the Old World; in Babylonia, for example, it was already at least 2,000 years old when the Shang period opened.

Dressed stone and brick did not appear in China until many centuries later. Literary references, however, perhaps based on contemporary evidence, attribute to the Shangs a varied and developed architecture.

*Tillage.*—The economic foundations of the Shang civilization were animal husbandry and especially agriculture. As previously noted, the ox-drawn plow was not yet known in China; but tillage was carried on by the peasantry, direct descendants of the old Neolithic population, with the aid of hoes, mattocks, and apparently foot plows, shod with stone or shell. There is also some indication that irrigation was already being practiced during Shang times.

The staple crops were wheat, millet, and perhaps rice. Of these, the first originated in western Asia, where it had already been domesticated probably thousands of years before the Shang period began. Millet was an inheritance in China from Neolithic times, and later on was the only cereal regarded as sacred—itsself a sign of a high antiquity on account of the workings of religious conservatism. There is also some reason to believe that rice was grown.

Beer was brewed from millet and perhaps from rice, though as to the processes employed, we know nothing. No spirits (distilled liquors) were known in China for something like 2,000 years after the Shang period.

*Animal husbandry.*—Animal husbandry was also economically important. Species both of the wild pony and of the wild ass are known from eastern Asia, although neither has ever been domesticated; but



evidence of the domestic horse in China in Neolithic times is wanting, just as it is, practically, in Europe during the same cultural phase. That the Shangs had it, however, there is no doubt; but they did not ride it, using it instead to draw their chariots. For in China, as in most ancient lands, the horse was driven long before it was ridden.

Shang inscriptions reveal that cattle were the most important domestic animals. They were offered in sacrifice, their flesh was eaten, and their hides made into leather; but milk was not used. Oxen were probably employed to draw carts and carry packs.

Sheep and goats were also kept. They seem, however, not to have been derived from native wild forms but from the same western ones as the domestic sheep and goats of the Occident. Sheep were sacrificed by the Shangs, though not to the same extent as cattle; and mutton was an article of diet. Wool, however, was not spun or woven, either then or later.

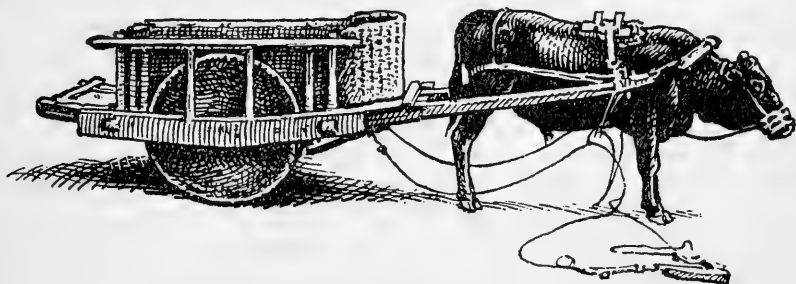

FIGURE 5.—Country oxcart, a primitive survival.

Swine were bred in large numbers, just as in Neolithic times; and dogs were both sacrificed and eaten. The domestic fowl was known, and appears to have reached China, probably by the Burma Road (see map, fig. 1) from Indo-China, during the "dark age" which followed the Neolithic period, for its remains have not been identified from sites of the latter cultural phase in China.

*Trade and transportation.*—A Bronze Age civilization always presupposes a considerable amount of trade, both domestic and foreign. The northern Chinese plain was, however, deficient in many kinds of raw materials, especially metals. And since these played an important part in the life of the time, they had to be imported from other regions, particularly from the Yangtze Valley, then and for long afterward not regarded as part of China.

Some transportation was carried on by water; but mainly it seems to have been by land, probably in oxcarts (for a modern but primitive survival, see fig. 5) and on the backs of oxen, for the horse seems to have been reserved for the uses of war, the chase, and religion.

There seem to have been even then, just as there were later on, contacts with the rich metalliferous regions of the Yangtze Valley, just mentioned; and cowries (*Cypraea moneta*) and bones of the whale show that the Shangs were in touch, directly or indirectly, with the sea. The presence of jade, not known ever to have occurred in China proper, suggests that the Shangs obtained that substance from central Asia. Also, supplies of salt are necessary, for dietetic reasons, to a people subsisting mainly, as the Shangs seem to have done, on a cereal diet.

Attempts to obtain such raw materials from abroad were, however, often not true commercial ventures but great plundering raids, undertaken as state enterprises, with regular armies. The penetration of the Yangtze Valley by certain Shang kings was probably of this character.

*Arts and crafts.*—Among arts and crafts, bronze working was carried to a pitch of technical and esthetic excellence hardly if ever equaled in later times, in any land. Bronze is an alloy of copper and other metals, usually tin and lead. It is uncertain whether Shang metallurgists knew the two latter as separate metals or whether they used copper ores containing them as impurities.

The Shangs also cast magnificent bronze ritual vessels for use in ancestor worship. These vessels bear two styles of ornamentation which regularly appear in combination. Of these, one was a highly conventionalized animal style, the other geometric in design and apparently akin to the old Neolithic art of southeastern Asia. Some and perhaps all designs were thought to have magical power, especially over the weather, most important to a predominantly agricultural community such as were the Shangs. There seems nothing to suggest that ornamentation was ever applied for purely decorative effects.

The wants of the ruling class were supplied by highly skilled craftsmen and artisans of many kinds; for specialization of tasks was already being carried to a high pitch. The needs of the peasantry and of the city poor probably differed little from those of their Neolithic ancestors.

*Pottery.*—The painted pottery of Neolithic times had practically disappeared from northern China by Shang times, most likely during that as yet little-known "dark age" already mentioned. The coarse gray ware, also Neolithic in origin, continued however under the Shangs, as it did in fact all over northern China until well after the Christian Era. The potter's wheel was regularly employed by the Shang potters.

A limited use was also made of a kind of glaze, which, however, disappeared with the fall of the Shangs; and when glaze is again

found in China it is of an entirely different type. The Shang potters also made fine white ware, neither glazed nor painted but bearing incised or impressed on its surface designs identical with those on the bronze ritual vessels just mentioned.

Among all these types of earthenware there appeared a wide variety of forms, shapes, and sizes, many of them being represented in bronze also.

*Textiles.*—Both hemp and silk were woven into cloth during Shang times. Hemp, we may note, occupied the place in ancient China held in the Occident by flax and its derivative, linen. Matting and basketry were also woven.

*Decorative arts.*—Carving, sometimes of very fine quality, was done in stone, ivory, and probably wood. Both bone and bronze objects were inlaid with turquoise or mother-of-pearl. The Shangs also did considerable carving of jade, probably then as later believed to possess magical significance.

*Weapons and implements.*—The weapons used in Shang times were as a rule of bronze. Socketed spears were known, and there were also two distinct types of battle-axes, each with its own method of hafting. Arrow points of bronze, stone, and bone were also used. The bronze sword did not appear in China until very late—not, in fact, until the Shang period had closed.

Needles of bronze and of bone are also known, and knives and chisels were of bronze or stone. Agricultural tools of bronze are however almost entirely lacking; for that metal was always costly and was probably reserved almost exclusively for purposes of religion, luxury, and war.

*Warfare.*—Among the causes of war mentioned in the Shang inscriptions are border raids and encroachments on grazing grounds. There was also the recurring need to enforce the authority of the Shang king over the subject states that withheld tribute and submission; and expeditions were made against non-Chinese people for plunder and captives.

Armies are recorded as numbering from 3,000 to 5,000 men, and the main reliance in fighting was on the chariot, drawn, just as in the ancient Near East, by two horses yoked—not harnessed—abreast. Slaves and captives were employed as foot soldiers, as were also probably levies of peasants. Weapons used by the charioteers were, as far as we know, bronze battle-axes and spears and the composite bow—the latter a weapon of circumpolar distribution. How the foot soldiers were armed, we do not know.

*Hunting.*—Hunting played an important role during Shang times. Many products of the chase were utilized, as for example ivory, hides, horns, and plumes. Great organized battues were periodically held by

the kings, riding in chariots just as in the ancient Near East. Their motive seems to have been not so much that of mere sport as the duty of ridding the land of dangerous and troublesome wild animals and of procuring victims for the sacrifices.

Among the creatures whose bones have been found in Shang deposits are the elephant, the tiger, the bear, the wild boar, deer, hares, and, strangely enough, the whale. Shang inscriptions sometimes state that elephants have been captured alive, not killed; and there is no doubt that the Shangs sometimes tamed these great animals.

*Writing.*—There is no indication of even the beginnings of writing during Chinese Neolithic times, although perhaps quipus (knotted cords) or notched sticks may have been used then to aid the memory, just as by unlettered people in so many lands.

The earliest known Chinese writing, already mentioned as occurring in surviving Shang inscriptions, dates from around the latter half of the second millennium B. C. Even then, however, it was already highly developed, and must have had a long previous period of evolution somewhere. It is moreover directly ancestral to the Chinese writing of the present day (Creel, 1937, pp. 1-16).

Existing specimens of these inscriptions, aside from very brief ones on bronze vessels, are incised or scratched on animal bones and shells of the tortoise. Shoulder blades of oxen were often used. The inscriptions that we possess consist largely of oracular inquiries and responses; but it is known that the Shangs also wrote on wooden tablets and bamboo slips. Hence it is quite possible that a considerable body of literature may have existed; but if so, it has entirely perished.

Inscriptions on bone and shell were incised with a sharp point, perhaps of bronze or obsidian, for steel was not yet known, and the Shangs probably had nothing else hard enough. Some kind of brush was also used. A few characters thus written on potsherds have been found, and it is almost certain that writing on bamboo and wood was done with a brush.

Knowledge of writing during the Shang Dynasty was confined to a very small class, and the art itself was regarded as having a magical and mysterious character. Thus recorders were also diviners. The same way of thinking has survived in China down to much later times.

*Religion.*—We know something of the Shang pantheon—in part from contemporary inscriptions. The supreme god was Shang Ti. The title "Ti" indicated a divine being, and was applied by the Shangs not only to their highest divinity but also to the spirits of deceased royal ancestors. Hence it has been surmised that Shang Ti may have originated merely as the (legendary) first ancestor of the Shang kingly line.

Shang Ti was entreated both for abundant harvests and for success in war. He was believed to live in the sky, perhaps in the North Star, and so was in this sense a sky god; although we have no evidence that the Shangs worshipped the sky itself.

The Shangs also revered many other divinities, often female. Among them, according to the inscriptions, were the Eastern Mother, the Western Mother, the Dragon Woman, gods of the Winds, of Rivers, of Earth, and one called the Ruler of the (Four?) Quarters. This frequency of female divinities is in marked contrast to the later Chinese Bronze Age, and may have been due to aboriginal influence. For goddesses play a great part in the primitive beliefs of eastern Asia, the Japanese Sun Goddess being probably the best-known example.

Of ancestor worship among the Shangs, the only direct evidence applies to the royal line alone; but there is little doubt that the ruling class in general practiced it throughout the original Chinese culture area.

The welfare of the spirits of the dead depended, it was held, on the sacrifices offered to them by their living descendants. It was regarded as highly dangerous, therefore, to withhold them and thus rouse the ancestral spirits to anger. The sacrifices consisted of both human and animal victims (Creel, 1936, pp. 206-216). The former were often "barbarian" (i. e., non-Chinese) captives of war, taken most frequently from the Chiangs, a people to the northwest. The Shangs appear in fact to have been in the habit of raiding the Chiangs for supplies of human victims in a way that recalls similar practices among the Aztecs of ancient Mexico.

Lastly, we may note, the Shangs had a "week" of 10 days, used in connection with their religious observances.

*Disposal of the dead.*—During Shang times, important people were buried in great rectangular or cruciform pits, together with much wealth and many human victims. Mounds were not, however, erected over such tombs as yet.

*Fall of the Shangs.*—A later tradition asserts that the Shang Dynasty came to an end during a period of protracted drought for which the reigning king was held responsible through his neglect to observe the proper rites. And quite apart from such superstitious ways of thinking, such a long interval of dryness must necessarily have led to much suffering, unrest, and discontent. There is also some evidence that the king himself added to this feeling by a determined effort to assert his power over some of the rebellious rulers of the subject city-states that composed the Shang "empire." And, worse still, in this attempt the king appears to have enlisted the aid of certain aboriginal tribes.

The rulers of these city-states were constantly trying to throw off the sway of their titular suzerian; and now some of them sought the aid of a group called the Chous, who lived on the northwestern frontiers of China, along the border between what are now the provinces of Shensi and Kansu (see map, fig. 21).

These Chou people had been in contact with the Shangs for several generations at least. When we first hear of them they seem to have been in process of exchanging a pastoral for an agricultural mode of life. In some ways they appear to have been less civilized than the Shangs, but to have had a better organization for war and more effective leadership. In certain particulars their civilization appears to have had a closer resemblance to those of the ancient Near East than to that of the Shangs. Examples of this are: the use of a 7-day week instead of the one of 10 days employed by the Shangs; possession, by the Chou rulers at least, of regular harems, with eunuch attendants, apparently unknown among the Shangs; and succession in the kingly line from father to son. Lastly, the bronze sword (Janse, 1930a, pp. 67-134; Karlbeck, 1925, pp. 127-133), long known in the Occident (where in fact it was already being replaced by much more effective swords of iron), reached China either with the Chous or early in their period.

The overthrow of the Shangs is not known to us through contemporary accounts; but it seems pretty surely to have been the result of a concerted attack on them by some of their subject city-states together with the Chous. The latter are said to have had with them as subject-allies eight peoples occupying parts of western and northwestern China, mainly in the central and upper Yangtze basin (Bishop, 1932c, pp. 236 et seq.).

The Shangs collapsed perhaps as much from lack of unity and cohesion among the various and heterogeneous elements under their rule as from external force. Their conquest by the Chous did not however take place as the result of a single battle, as the "orthodox" account states. On the contrary, it required a long time, and was not completed for half a century at least after the initial invasion by the Chous.

Perhaps the Shangs were too strong to be wholly crushed by the newcomers; for they were allowed to retain the nuclear part (called Sung) of their former territory, as vassals of the Chous. The princes of this remnant of the old Shang kingdom, said to have belonged to the Shang royal line, were granted the title of *kung* (duke), which no other feudal prince was permitted to hold.

The historical Chinese civilization that we know had its roots firmly implanted in the Bronze Age culture of the Shang period, and there has been no serious break with the past until recent and

even modern times. In this sense, and in this sense only, may we speak of the Chinese as "unchanging."

#### THE CHOU DYNASTY

There are certain slight indications that during the Shang period and possibly even earlier, members of the Tibeto-Burman linguistic stock from the region north of the Tibetan plateau (see map, fig. 1) were pushing eastward and southward. With this movement of peoples the Chou invasion seems to have been connected, if indeed it was not actually part of it.

These migrations perhaps account for the appearance of Tibeto-Burman peoples in so much of western China, especially in the upper Yangtze basin. Be that as it may, at all events there was established there, somewhere around a thousand years before our era, a Bronze Age civilization in large part associated with them. In extreme western China the local culture also contained elements from northern India. Similarly, culture traits, passing through the region traversed by the now famous Burma Road, have gone on diffusing themselves from prehistoric times right down to the present day. To take a fairly recent example of this, maize or Indian corn, an American plant brought by the Portuguese to India during the sixteenth century, lost little time reaching China by this route. And the vital importance of the Burma Road to China today is well known to all.

*Chou origin legends.*—At the time when the Chous first come within the purview of history they were, we are told, being pushed steadily eastward. Legend also states that they even for a time became guardians of the western frontier for the Shang kings. That the latter ever conquered the Chous, we have no evidence; but they evidently attracted them strongly into their cultural orbit.

This outward thrust of the Chous from inner Asia in the direction of the coast lands was, it would seem, comparable to contemporary movements outward from the steppe regions into western Europe, southwestern Asia, and Egypt (Latourette, 1934, vol. 1, pp. 42-44; Creel, 1936, pp. 227-229).

The chief deity of the Chous, now as later, was a sky god, T'ien, believed to control the weather and whom the Chou royal line claimed as its ancestor. For it was from Hou Chi, "Prince Millet," said to have been miraculously sprung from T'ien and who became God of Agriculture under the Chous, that the latter claimed descent. In historical times, indeed, we find the Chou kings arrogating to themselves sole conduct of the worship of T'ien, and also the title of T'ien-tzū (Son of Heaven). This appellation remained the common one for the Chinese supreme rulers—the individuals whom we term "emperors"—down to 1911.

*The Chous conquer northern China.*—The Chous seem long to have meditated conquest of the Shang kingdom, against which they are said to have made at least one ineffectual attempt before they embarked on their final venture.<sup>7</sup> They and their allies are said to have defeated the Shangs in the region of the Shang capital, which recent archeological excavation shows they then savagely sacked and destroyed.

The Chous then conquered much of northern China, where they established their power far more firmly than the Shangs had ever done. (On the Shang and Chou culture areas, see map, fig. 6.) The task

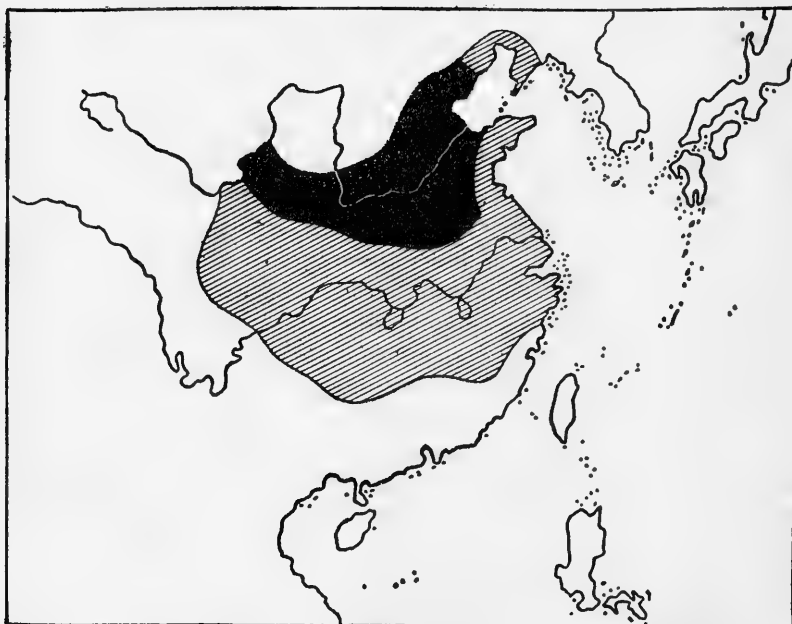

FIGURE 6.—Shang (in black) and Chou (cross-hatched) culture areas, showing southward extension of the latter.

seems to have required something like half a century, and a passage in Mencius tells us that they subdued 50 states. Over these they then set up a feudal kingdom of primitive type but still forming a great step in advance over anything in the way of a political organization that the Shangs had undertaken.

However, the Chous failed to subdue the aboriginal populations of the northern coast lands, and these long remained independent or at most became tribute payers. Their thorough assimilation into the Chinese political body was not accomplished until many centuries later.

<sup>7</sup> The traditional date of 1122 B. C. for the Chou conquest is almost certainly too early by about three-quarters of a century. On this point, see Bishop, 1932c, pp. 235-237.



The Chou conquest of northern China marked an important epoch in the history of civilization in the Far East, for as a result of it, many Shang refugees seem to have carried their own higher culture to various outlying regions hitherto barbarous. Such a process has, in fact, always been one of the ways in which cultural advances have taken place in the Far East just as everywhere else. Further, the Chou period was the one in which the Chinese people gradually developed a consciousness of cultural unity.

*Nature of the Chou kingdom.*—The earlier Chou kings, in organizing their feudal kingdom, are said to have divided it for administrative purposes into 9 (sometimes given as 12) *chou* or circuits. Over these they placed superintendents (significantly called *mu*, bullock drivers) to collect tribute.

Politically, the kingdom is said to have contained at first 1,800 fiefs, many of them grouped into large territorial units granted to the conquering Chou king's relatives and allies. The old city-states did not, however, entirely disappear; in certain instances, indeed, they retained their identity for long periods.

By the eighth century B. C. the Yellow River basin (essentially the Chou kingdom, though the latter seems to have embraced extensions outside of it, particularly on the south; see fig. 6), had about 100 fiefs; but in time even this number was still further reduced. Finally, toward the end of the dynasty only 7 large states were left.

For some three centuries after their conquest of the Shangs, the Chou kings remained in their old seats in the west. They were at first rulers of the war-leader type; but they also took over the sacerdotal functions of their predecessors the Shang kings. As high priests of the kingdom, their persons were sacred, and they were the fountain-heads of all legitimate authority. Their royal symbol was the battle-ax.

The early Chou kings pushed their conquests (at least temporarily) into the Yangtze basin, and perhaps also toward the northwest. But at length their power dwindled. In the eighth century B. C. the Chou line was driven eastward by renewed attacks from the west, and established itself in northern Honan. (See map, fig. 21). It thus lost the territorial basis of its power, and its scions gradually sank to the position of mere political figureheads. But for several centuries longer they retained their priestly functions and remained the sources of legitimacy.

*Social organization.*—Society was divided during most of the Chou period (we know little of its earlier portion) into two classes, a small one of nobles, who held all the land and offices, and a large one of commoners—peasant-serfs, artisans, traders, and slaves—who performed the labor.

The nobles were grouped in 30 or fewer ancestor-worshiping clans. In the "Spring and Autumn Annals," for example, 124 feudal states

are mentioned but only 22 clans. Branches of the latter were located in various parts of the country, often widely separated from one another.

The head of each clan was trustee for its land (which was thus not his own personal property, to do with as he liked); and he also conducted the clan worship. The head of the ruling clan of a state worshiped his own ancestors and also the patron divinities of his state. For no separate priestly class existed in ancient China.

Nobles were subject only to their own code, not to the laws governing the lower classes. Knowledge of these laws gave the nobles a great advantage, and they objected strongly to their being reduced to writing. They also practiced polygamy, though custom strictly forbade their taking wives or even concubines of the same clan as their own, no matter how remote the kinship might be in reality. Headship of the clan passed in the male line, usually to the eldest son of the principal wife; though in this respect usage was not fixed. The latter fact often caused great trouble, through disputed inheritances. Noblewomen could not hold land or succeed to headship either of a clan or of a state. Hence inheritance of these privileges in the female line was impossible.

Of the plebeian class, on the other hand, we know little; for early Chinese writers did not concern themselves with the masses. We may say however that the vast bulk of the population consisted of peasants in a state of serfdom, practically at the mercy of their lords. These peasant-serfs may have been grouped in matrilineal clans; and they probably retained much—as indeed Chinese peasants still do—of the old Neolithic culture of their remote forebears. They seem to have lived in rural hamlets, and to have had little contact with the urban life of the nobility. These little peasant hamlets were organized communally, and their inhabitants did their field work in common. Stone, shell, and wood continued to be used for agricultural implements. The ox-drawn plow was not yet known in China, its place being taken by foot plows used by men working in pairs.

Serfs were bound to the estates on which they were born, and efforts were made by their lords to keep them from shifting their villages about in old Neolithic fashion; for it was the labor of the peasants that gave value to the land, and there was a great demand for workers. It was therefore a crime to entice them away, and runaways could be reclaimed. There are indications, too, that the feudal lords dreaded uprisings among their peasants, and it was a capital offense to arouse discontent or unrest among them.

The peasants tilled the land, but did not own it, although plots of ground on which to grow food for themselves and their families were

periodically assigned to them, on which, however, they had to pay tithes. They had also to perform other work, such as ditching and draining; and they had likewise to follow their lords in the frequent wars, both public and private.

The serfs on an estate were supervised by a land steward or bailiff appointed by the lord, and who among other duties exercised control over peasant marriages.

At the bottom of the social scale, in Chou times as later, was a not very large class of slaves, recruited partly from criminals and captives of war. These were not attached to the soil, like the serfs, but were bought and sold in the market place with domestic animals.

*Economic development.*—During much of the Chou period trade was by barter, and taxes and tribute were levied in kind. Cowry shells were, however, highly prized, both for their scarcity value and because of their religious and magical associations (which seem to have existed in many other lands also). The only basis of wealth, however, was land—arable, pasture, forests, salt marshes, and mines—which could only be held, whether in absolute ownership or as fiefs, by clans of nobles. Plebeians were thus barred from obtaining wealth and consequent power.

Later, however, there occurred a gradual but great economic evolution. No coined money yet existed; but there came to be used in its place as units of exchange rolls of silk and fixed quantities of grain. We have no evidence that oxen or sheep were ever so used in ancient China, as they were in the west.

*Trade and transportation.*—Trade, both domestic and foreign (i. e., mainly with the Yangtze Valley, not then regarded as a part of China) was active, and was partly in the form of state enterprises and partly in the hands of traders, who had however to pay heavy imposts.

No understanding of the true function of trade, as a form of wealth production, seems ever to have arisen in ancient China, where the nobles despised it and regarded traders with contempt. Hence commerce was tolerated merely, not actively encouraged. There are some indications however that it was more highly esteemed in the great Yangtze Valley states, and that they knew better how to make it contribute to building up their strength than did those of the more purely Chinese north.

This earlier dependence on a natural economy and especially on taxes levied in grain rendered transportation of revenue from distant districts to the royal capital a difficult matter, and added greatly to the decentralization characteristic of the time.

But around the middle of the Chou period the idea arose of casting—not striking—metallic token money, or in other words a coinage.

This practice seems to have originated in northeastern China. At first it took the form of miniature models of domestic utensils—knives, spades, and hoes—cast in copper. (See fig. 7.) This innovation fundamentally altered the basis of wealth, and for the first time permitted its accumulation in a form other than that of land. It thus deprived the nobles of that monopoly of the power and prestige that accompany riches, and played an important—perhaps even the decisive—part in undermining the old feudal system and causing its disintegration and ultimate downfall.

This process became accelerated toward the end of the Chou period, and was of course accompanied by the disappearance of many of the

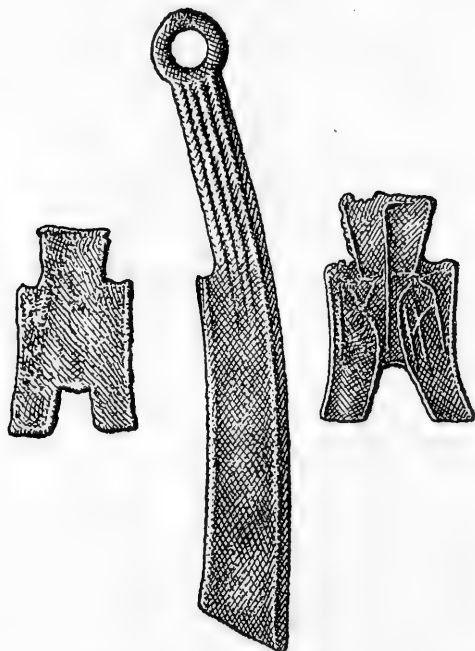

FIGURE 7.—Ancient Chinese token money of copper.

barriers that had formerly separated different classes of society. Traces of these however still survive in both the Confucian and the Taoist beliefs and practices, as we shall see in a moment.

*Arts and crafts.*—What has already been said in regard to the arts and crafts of Shang times will apply, in most cases with increased force, to those which flourished under the Chous.

While few actual remains of the technical skill and esthetic talent of the Chous have come down to us aside from their work in bronze casting and carving in jade (for examples of their work in bronze, see pl. 10, and figs. 8, 9, and 10), we know that their work ranked very high indeed. The subject is, however, too vast a one to receive detailed

treatment here. Fortunately there is no lack of excellent and authoritative books on various aspects of this fascinating subject, and to these the student may turn for further information.



FIGURE 8.—Chou Dynasty monster figure of bronze.



FIGURE 9.—Ancient Chinese bronze bell, Chou period.

*Habitations.*—The Chou nobles and their dependents lived in towns protected by rectangular ramparts of pounded earth provided with gates flanked by wooden towers. (See fig. 11.) In the center stood

the palace enclosure of the local feudal lord (or in the capital of a state, that of its ruler), including his ancestral temple and the "altar" (a mere mound of earth) of the Shê or God of the Soil of the region. Every town had just north of it a market place, from which the lord



FIGURE 10.—Lid of Chou Dynasty bronze vase with bird figures.

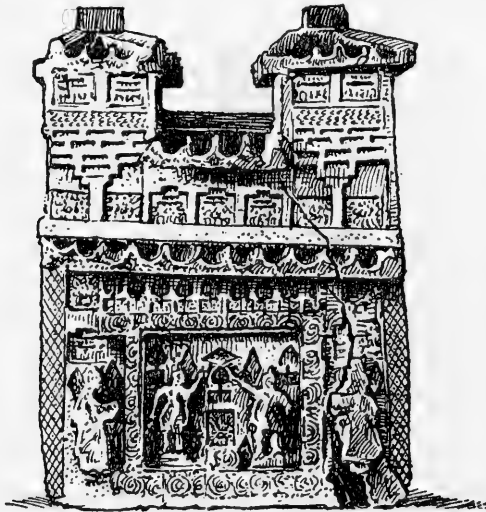

FIGURE 11.—Tile model of ancient Chinese city gate.

drew additional revenue through a sales tax. (For a plan of the ruins of such a town, of the Chou period, see fig. 12.)

The palace enclosure also contained a school for the sons of nobles, the subjects taught being the rites (i. e., correct procedure on all occasions, religious as well as secular), music, archery, chariot driving,

reckoning, and writing. Reverence to superiors or divinities was shown by bowing, kneeling, or prostration, as in the Occident, not by squatting as among the peasants and the peoples of southeastern Asia and the islands off the coast.

Houses were of timber, pillared (see pl. 12, fig. 2), carved, and painted (or laquered), red being a favorite color, regarded as lucky. On the plastered walls were executed paintings of various auspicious creatures, such as the tiger and dragon. Pleasure towers, summer houses, and gardens are also mentioned. The upturned roof corners, regarded in the Occident as so typically Chinese, did not appear

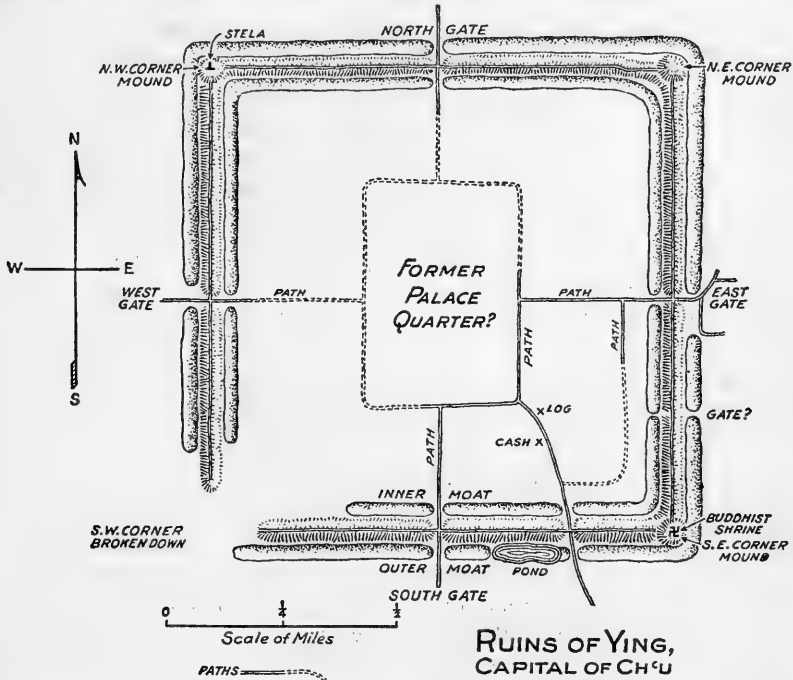

FIGURE 12.—Ruins of Ying, ancient capital of Ch'u, on the Yangtze River.

in China until long after the beginning of the Christian Era; during Chou times Chinese roofs had straight lines, as in the west.

*Costume.*—Costume, of course, varied according to rank, social position, and wealth, and probably, too, from state to state. That of the nobles was in general of silk, and was long and flowing, as in the Near East. Furs and feather capes were worn, particularly in cold weather. Embroidery and fine needlework were highly regarded, and bright colors esteemed. Shoes, at least among the well-to-do, were often ornamented with jade.

*Manners and customs.*—The rank of a noble was indicated especially by his headgear. This, on attainment of his majority by a

patrician youth, was conferred on him with much ceremony in his ancestral temple. The token of a young noblewoman's reaching marriageable age was the assumption of a hairpin, similarly bestowed.

Shoes were removed on entering a house; and bathing seems to have been customary, at least among the nobles. Chairs and tables had not yet been introduced; hence people sat cross-legged on the floor or knelt on mats or cushions, and food was served on low stands.

*Food and drink.*—Generally speaking, the basis of diet among all classes, nobles and commoners alike, was one of cereals—millet, wheat, and rice. Nobles, however, in contradistinction to the peasantry, were also great eaters of meat, especially beef, mutton, and game, and of fish. And, just as today, there was a great variety of sauces.

Dishes were of earthenware, wood, and bamboo. Glazed pottery disappeared with the fall of the Shangs, and true porcelain was still far in the future. Chopsticks were a late invention, and whether they had yet appeared during the Chou period we do not know; they are mentioned even as far back as late Shang times, but this may be an anachronism.

The diet of the peasants was mainly millet, just as it is today in northern China. Their flesh food was chiefly dog, pig, and fowl—the latter apparently more highly esteemed than duck.

All classes were given to drinking, usually done in connection with some religious or other ceremonial occasion; and beverages were various kinds of beer, brewed from millet or rice. The ancient Chinese, like the peoples of the west, early learned, empirically, that water was unsafe to drink on account of risk from typhoid; and tea was as yet unknown. As among many peoples, including ourselves not so many centuries ago, drinking vessels were often horns; those of the wild ox were especially prized by the ancient Chinese, perhaps on account of their capacity.

*Law.*—As we have already remarked, the nobles had their own codes of conduct; and they were, moreover, until long after the beginning of the full historical period, sole repositories of the regulations governing their peasants. These were committed to memory, not put in writing, and this of course gave the nobles a great advantage. Hence the latter vigorously opposed the issuance of written codes, which in fact did not appear in the various states until around the middle of the first millennium B. C. In the Near East advanced codes of laws had appeared 2,000 years earlier.

Witchcraft was much feared, by high as well as low, and penalties against it were severe. In general, execution of the laws was harsh, and included such punishments as boiling alive, tearing asunder, de-



capitation, and mutilation of various kinds. In addition to the regulations imposed on them by their lords, the peasantry also observed the ancient local customs of each region; but just what these were, we have only incidental knowledge.

*Warfare.*—The Chou period, like that of Bronze Age civilizations everywhere, was one of constant war. With the weakening of the royal power, especially after the Chou kings were driven eastward just after 770 B. C., the more powerful feudal states began a process of absorption of their weaker neighbors and of the neighboring non-Chinese peoples which led finally to only seven great kingdoms being left.

In theory, wars were undertaken to punish and coerce those, whether Chinese or "barbarian," who refused to acknowledge obedience to the Son of Heaven; but in reality they were waged for purposes of aggrandizement. The third quarter roughly of the first millennium B. C. came, in fact, to be known as the Age of the Contending States (Latourette, 1934, vol. 1, pp. 251-256).

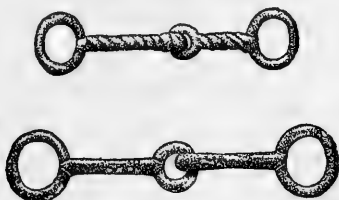

FIGURE 13.—Ancient Chinese snaffle bits of bronze.

The feudal lords also carried on private wars with their neighbors, even of the same state. Rulers, however, constantly tried to put down this practice, productive as it was of so much disorder and misery.

There has been at no time in Chinese history a special military class, comparable, for instance with the Japanese *samurai*. All Chinese nobles, however, were supposed to be warriors. The title of a minister of war, Ssü-ma, meant Master of the Horse, and reflected the great importance of the horse in war.

Armies were composed of two main classes of troops, chariotry and foot. The former, composed of nobles, was called *shih*, while the latter, a rabble of levies of peasant-serfs, was called *lü*. Hence an armed force as a whole was known as a *shih-lü*. In theory each feudal lord's chariot was accompanied by from 75 to 100 of his peasants, on foot, but in reality the proportion of foot soldiers attached to each chariot rarely exceeded 50. Cavalry did not form an element in Chinese armies until near the close of the Chou period, and chariots continued to be the main arm until about the third century B. C., after which they ceased to be mentioned as being employed in war. (For ancient Chinese Bronze Age bits, see fig. 13.)

Chinese armies in Chou times were divided into an advance guard, a center, right and left wings, and a rear guard. Provisions were carried in ox carts and on pack oxen, and consisted largely of dried flesh (often that of wild game) and of grain. Armies then, however, just as elsewhere, eked out their supplies by foraging and pillage. The enormous numbers sometimes attributed to ancient Chinese armies by old writers are evident exaggerations; for it would have been, as a simple calculation will show, impossible to maintain them in the field under the conditions of transport that then prevailed.

*Methods of combat.*—Each chariot carried three men clad in hide armor—a driver, an archer, and a spearman. How the infantry were armed there are no clear indications, although they seem not as a rule to have carried missile weapons such as bows and arrows or slings.

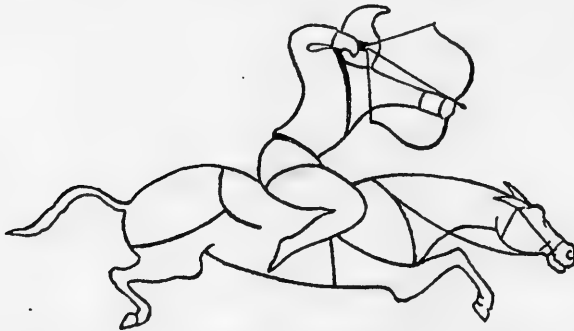

FIGURE 14.—Chinese mounted archer, from design on tile; late first millennium B. C.

Chariots (see pl. 3, fig. 2 for what seems to have been an antler cheek-piece of a Chinese Bronze Age bit) did not generally fight in massed formation but singly, each accompanied by its supporting contingent of foot. Every noble bore his own standard, by which he might be recognized in battle; and nobles as a class deemed it derogatory to fight on foot, "like peasants." There are indications, however, that the practice was growing more usual toward the end of the Chou period.

Armies were accompanied on campaigns by special sacred chariots bearing the tablets (perhaps originally images) of the Shê or God of the Soil of the state and also of the chief ancestor of its ruler; these tablets were supposed to extend their aid in battle, much like the Ark of the Covenant among the ancient Israelites. Omens were taken before an action; and the signal for advance was given on a drum, that for retreat on a gong, both instruments borne on the chariot of the leader. Cessation of these sounds was apt to cause a panic among the troops by giving the impression that the leader had been either slain or made a prisoner by the enemy. Trumpets were not used in war.

Principles of strategy were well understood and applied, but tactics were undeveloped. According to our evidence, battles were confused affairs, with no attempt at maneuvering. Various simple strategems were, however, employed, especially feigned flights, meant to throw the foe off his guard. Attacks were usually directed against the weakest part of the hostile line, and particular efforts were made to kill or capture the enemy commander or seize his standard.

In the Occident, mounted troops and iron weapons began to appear toward the end of the second millennium B. C., but in China not until around 500 years or so later. The idea of riding almost certainly came to the latter country, as it may already have done in the west also, as a culture loan from the nomad peoples of the steppe belt of inner Asia. For example, there are indications that the western "barbarians," who around 770 B. C. expelled the Chous from their



FIGURE 15.—Modern dragon boat, Yangtze River; from a photograph.

old seats in Shensi and drove them eastward, were already in possession of mounted troops.

The earliest Chinese cavalry seem to have been light lancers riding bareback and employed for scouting, skirmishing, and foraging, not in battle. Around 300 B. C., however, the northwestern Chinese states adopted the use of horse archers from their steppe neighbors. (See fig. 14.) Such troops were far more formidable than chariotry, on account of their mobility and speed, and soon supplanted the use of chariots in war. They thus contributed to the downfall of the already crumbling feudal system by depriving the Chinese nobles, preeminently charioteers, of much of their prestige in war.

In the Yangtze basin and along the southern Chinese coasts, wars were often waged in fleets of large dugout canoes, ancestors of the later dragon boats (see fig. 15); for in that region chariotry seems to have been unknown until introduced by Chinese refugees from the north, while the great rivers provided abundance of waterways.

*Armor and weapons.*—The nobles, fighting, as has already been said, from chariots, wore hide armor, with helmets of leather or

copper (perhaps of bronze). Shields, of leather, wood, or wicker, were also used (Laufer, 1914, *passim*). The infantry too may have carried shields; but in other respects their costume in war was probably simply what they wore in peace. Of their weapons we know almost nothing, though in some instances they seem to have borne dagger-axes. (See fig. 16.)

Missile weapons were the bow and arrow and the sling. The former was of the compound type, of wood, horn, and sinew, and in time became the especially characteristic arm of the steppe nomads; the famous Turkish bow is probably the best-known example. Arrow

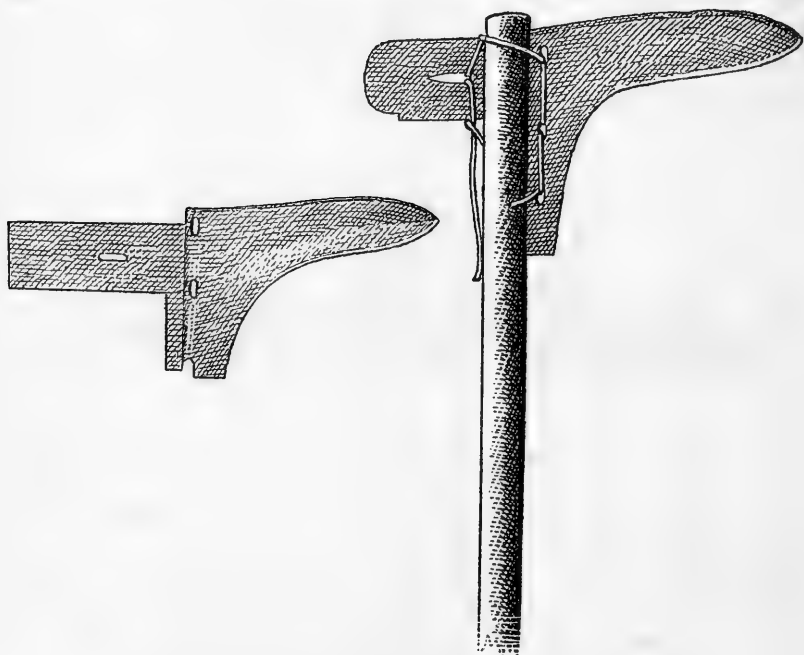

FIGURE 16.—Ancient Chinese dagger-axes of bronze.

points were of bronze, often with three edges. Crossbows were mainly used from chariots and in defending or attacking fortified places. That spears and javelins were ever hurled, there is nothing to indicate.

Hand weapons included different kinds of battle-axes, the dagger-ax especially being often mentioned; and there were different types of bronze spears. (See pl. 10.) The bronze sword, as already noted, appears late in China; and when it does so, it is in an undeveloped Altaic form, perhaps a culture loan from steppe regions. (See fig. 17.)

Standards were of silk, yaks' tails, and tufts of feathers. Forms of these have survived in parts of eastern Asia until very recently.

In general, siegecraft was well understood, and cities were taken in various ways—by surprise attacks, storm, or building around them walls of circumvallation and starving them out. Or their ram-

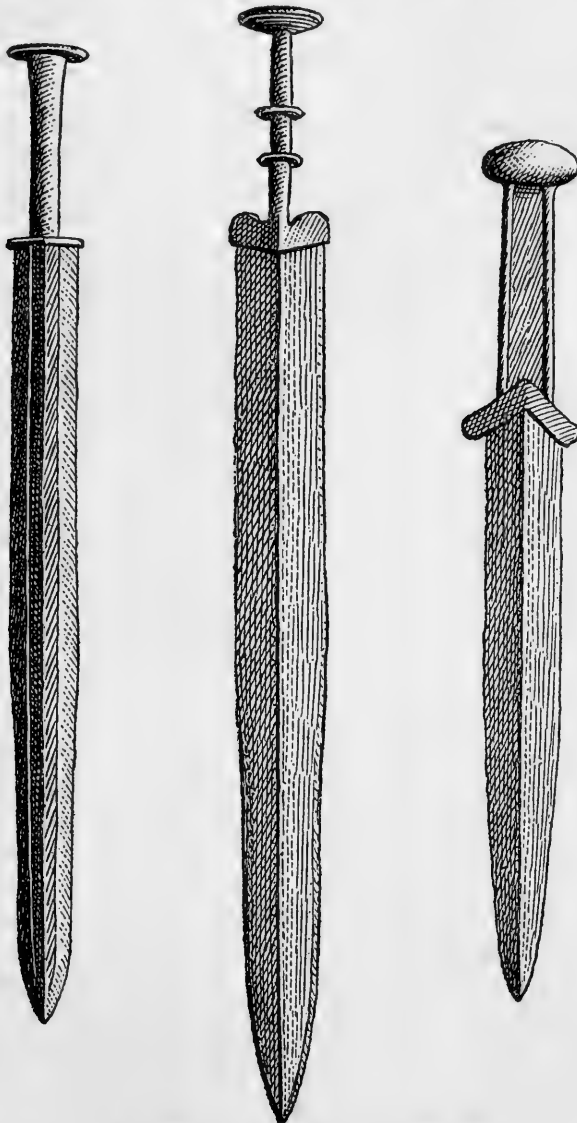

FIGURE 17.—Chinese bronze swords.

parts, of rammed earth, might be breached by diverting rivers against them, or by tunneling under them and then setting on fire the timber props supporting the roof of the mine and thus causing its collapse. The latter method was also employed in the Occident, where it seems to have appeared rather earlier.

*Blood feuds.*—In addition to waging private wars, already mentioned, the Chou Dynasty nobles, turbulent, aggressive, and given to fighting, regarded the relentless prosecution of blood feuds as a sacred duty. This custom the rulers of states found it exceedingly hard to abolish, in spite of the disorders to which it gave rise.

*Social effects of war.*—This constant warfare naturally produced in time important social consequences. For example, as improved methods of fighting appeared, the exclusive place in war held by the Chou nobles could no longer be maintained, and social barriers were broken down. Various classes of plebeians were rewarded for courage or loyalty in war by being elevated to higher positions than any to which they might have aspired before. Thus peasants and members of the artisan class might be ennobled (i. e., become landlords and hence feudal vassals). Slaves were similarly rewarded by being granted freedom.

*Hunting.*—Originally, as we have already noted of the Shang period, it was the duty of Chinese nobles to rid the land of dangerous or troublesome wild beasts; but in Chou times the sport motive seems to have predominated.

For this purpose the Chou kings and nobles held great seasonal hunts, conducted on a large scale. These were carried on in chariots, just as in the ancient Near East, with the aid of large armies of peasant beaters on foot. Such hunts served as training and preparation for war, and they also sometimes masked surprise attacks on unsuspecting states. Game laws were very strict, it being for instance as great a crime to kill a deer as to murder a man.

As the country grew more settled, however, and game scarcer, rulers and powerful nobles enclosed private hunting parks, just as did, for example, the ancient Persians. Prohibitions against killing game or even gathering wood in these parks were among the chief grievances of the peasantry, who regarded them as a great hardship.

*Religion.*—Peasant religion during the Chou period seems to have been derived from the old Neolithic fertility cults, and was marked by much witchcraft, magic, and even human sacrifice, though the latter practice was opposed by the lords, probably on economic rather than humanitarian grounds, and eventually disappeared.

Toward the close of the Chou period feudalism declined, its decay not unnaturally going hand in hand with a recrudescence of the old popular religion. At the same time, too, the masses seem to have adopted elements from the ancestor worship of the nobles. In this way gradually evolved the Chinese cult of ancestors of later and modern times.

Among the nobles, on the other hand, a quite different religion prevailed. In this, the chief god, T'ien, was regarded both as the ultimate ancestor of the royal line and also as a sky god.

Fairly early in the Chou period a tendency arose to identify T'ien with Shang Ti, chief god of the Shangs. This confusion was apparently facilitated by the fact that both divinities were sky gods, just as were the Greek Zeus and the Roman Jupiter, also eventually identified.

The Chous also had a Goddess of Earth, Ti, a kind of consort of T'ien (Bishop, 1939c, pp. 29-31); thus the Confucian "Classics" tell us that "T'ien and Ti are the father and mother of all things living."<sup>8</sup> In the religion of the Chous, in marked contrast to that of the Shangs, goddesses seem to have played a very minor part. They are found more particularly among the coastal populations, not yet fully Chinese, and also among the insular and other peripheral peoples of eastern Asia.

The Chou pantheon, which we know only in late form, comprised, in addition to the gods brought with them by the Chou and including of course the royal ancestors, other divinities, some of them taken over from the Shangs and perhaps also from the aboriginal peoples of eastern Asia. Thus there were local gods (not goddesses) of the soil, the Shê, already mentioned (Bishop, 1933c, pp. 32-34); these we know existed at least as far back as Shang times, and theirs was a primitive concept with many archaic features. There was also a Rain God in the form of a frog.

The dragon was regarded, if not actually as a divinity, at least as a supernatural being, benevolent in nature—not, as in Europe, maleficent. The original of this concept dates back at least to Shang times, and seems to have been founded in part on the Chinese alligator, regarded as a rain bringer, and therefore as a friend of man.

But the real basis of aristocratic religion under the Chous, as most probably under their predecessors the Shangs, was the cult of ancestors. Whether the Chous were ancestor worshipers before their conquest of the Shangs is unknown; but after that event the deceased forbears of their kings became the patron divinities of their kingdom. Hou Chi, "Prince Millet," was at once an ancestor of the Chou royal line and also its official God of Agriculture (Bishop, 1933c, pp. 37 et seq).

Souls of nobles after death became *Shên*; those of plebeians, *kuei*. The latter term was also applied to the gods, demons, and ghosts of non-Chinese peoples.

There is little to indicate that divinities in Chou times were regarded as having human form, or even of their being represented by images. Rather, they seem to have been indicated by symbols. That of T'ien, for example, was a circle or disk; that of Earth, a square. This symbolism persisted, officially at least, down to very recent times.

In general, ancient Chinese divinities and supernatural beings were

<sup>8</sup> The notion of marriage between Sky and Earth is a very common and widespread one.

usually regarded as having grotesque and composite forms, and thus belong to a stage of religious thought corresponding roughly to that of the old Egyptian "beast gods," familiar to most of us. Thus Ho Po ("Count of the Ho"), God of the Huang Ho or Yellow River, had a human face and the body of a fish. Shên-nung, God of Agriculture in the Yangtze basin and who in northern China supplanted Hou Chi in the same capacity toward the close of Chou times, had a human body and the head of a bull. Beings with the bodies of birds and human faces or with the bodies of serpents and human heads, as well as many others of similar composite form, also occur in the old writings.

Among the natural objects worshiped were mountains, rivers, springs (see pl. 9, fig. 1), rocks, and trees. Thus, "famous mountains and great rivers" are often mentioned as worshiped by the feudal princes. This was undoubtedly a very primitive survival; for such objects have been venerated in many countries from remote prehistoric times.

The sacrifices that accompanied worship in the Chou period were similar to those of the Shangs, but with certain progressive modifications. Among the victims offered were cattle, swine, sheep, and dogs. Horses were also sacrificed, especially to the Chou God of War. Human sacrifices, common in Shang times, were still occasionally offered by the Chous; but this practice became rarer as time went on, and at length disappeared almost entirely.

As in most lands at certain stages of religious development, the will of gods and ancestors was sought before embarking on any enterprise of importance. In the official religion this was most usually done with the aid of the shell of the tortoise; hence "to consult the tortoise" came to mean to inquire about the future. Omens were also drawn from various natural phenomena, such as dreams or the flight of birds. The howling of ghosts and the hooting of owls were portents of evil.

With the decline in power of the Chou royal line and the decay of the old aristocratic religion, popular concepts once more rose to the surface. During this period also the religious ideas of the northern Chinese were influenced and modified by others traceable to the Yangtze basin. Instances of this are the displacing by Shên-nung (the "Divine Husbandman") of Hou Chi as God of Agriculture in northern China, and the extension to the latter region of the dragon concept, pretty surely of southern origin.

We may note in this connection that many of the elements of the ancient Chinese religious beliefs and practices had a far wider range than China proper. Some of them point to western Asia and even to eastern Europe. In the main, however, they belong to that body of religious ideas and customs that pervaded southeastern Asia and certain adjacent island groups from times probably before the appearance of a Bronze Age civilization in northern China.



Examples of these latter traits are: the dragon-boat festival, especially characteristic of southern China but extending over a wide area outside China itself (Bishop, 1938b, pp. 415-424); the tug-of-war; ceremonial swinging; and the ritual bullfight (Bishop, 1925)—all of them practices apparently connected with the promotion of fertility.

Later Chinese religion was only in part an outgrowth of the beliefs that prevailed during Chou times. For the eventual disappearance of the feudal system with its aristocratic ancestor worship caused the destruction of the latter in its old form and its adoption, with certain important modifications, by the Chinese people in general. Traces of the old aristocratic religion may, however, be seen even today in the Confucian system (for the temple to Confucius at his birthplace see pl. 12, fig. 1); and many of the ancient beliefs of the masses, among them probably survivals from Neolithic times, still appear in modern Taoism.

For Confucius (551-479 B. C.) was himself a member of the Chou nobility (though claiming descent from Shang times), a loyal subject of his feudal prince and of the Chou king, and a faithful follower of the code of conduct of his own social class. (See pl. 9, fig. 2 for the tomb of Confucius.) During several centuries after his death, however, his teachings exerted little influence; and it was not until the founding of the Han Dynasty (ca. 200 B. C.) that the authorities, realizing the importance of Confucianism as an instrument of statecraft and a means of controlling the people, began to give it recognition and encouragement.

On the other hand, the ancient Chinese popular beliefs and practices tended more and more to associate themselves with the doctrines of Laotze (traditional date of birth 604 B. C.). That philosopher, of whose teachings the later Taoist system is in part the product, voiced the resentment of the masses against the arrogance, tyranny, and bloodshed of the feudal princes. His views were essentially democratic, and denied the value of petty human distinctions and ambitions. Hence the very ancient but long-submerged beliefs of the lower classes have naturally tended to crystallize about his teachings.

Later, during the early centuries of the Christian Era, Chinese religious ideas, together with other cultural features, spread over a large part of the Far East. Notably was this the case with Indo-China, Korea, and Japan. Manchuria, Mongolia, and Tibet—regions no farther away geographically but with different types of culture patterns—were less intimately affected.

*Music.*—Music played a part of great importance during the Chou period in all ceremonial life, on religious occasions as well as at banquets, archery contests, and the like. It had especially religious and magical connotations, and correct tunes were supposed to frighten away evil spirits and summon beneficent ones, including those of the

ancestors when these were to receive worship. Musical instruments were drums and bronze bells (see fig. 9); flutes, single and double; whistles; and sets of musical stones. Simple stringed instruments seem also to have been used (Creel, 1936, pp. 330 et seq.).

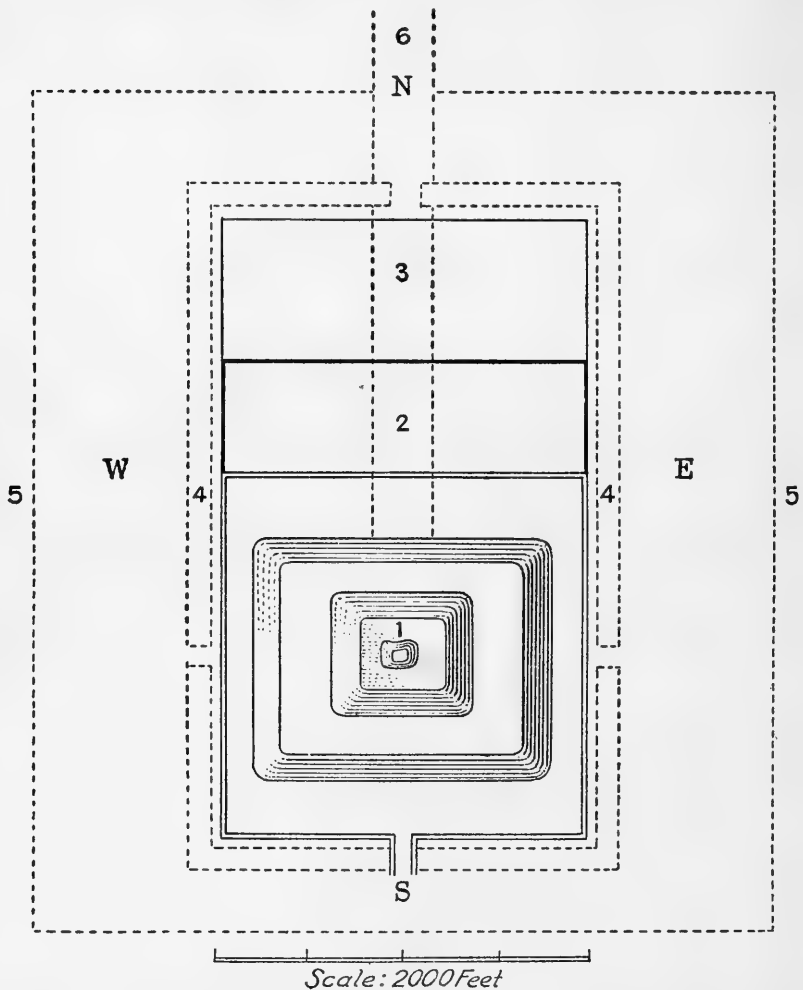

FIGURE 18.—Hypothetical reconstruction of grave mound of Ch'in Shih Huang Ti. (See pl. 1.)

*Disposal of the dead.*—As we have already seen, disposal of the dead naturally played a part of the first importance among an ancestor-worshipping people like the ancient Chinese nobles, during all periods.

During Chou times burial, not cremation, was the general rule. There were, however, exceptions. A few indications exist of a rite of cremation, sometimes accompanied by chariot burial. Mention is made of a group in the northwest (perhaps, however, non-Chinese)

who burned their dead on pyres. And a custom of cremation, apparently not of Buddhist origin, is still practiced by certain Tibeto-Burman tribes of western China.

During the Chou period the important dead, covered with red pigment, were placed in wooden chambers constructed underground. Goods and particularly bronze vessels were buried with them, as well as human beings, although not in such numbers as in the preceding Shang Dynasty. Chariot burials also occurred, as in the west. Burial mounds, usually though not always truncated pyramids of earth, often gigantic in size, were then erected over them. (See pl. 1 and figs. 18, 19, and 20.)

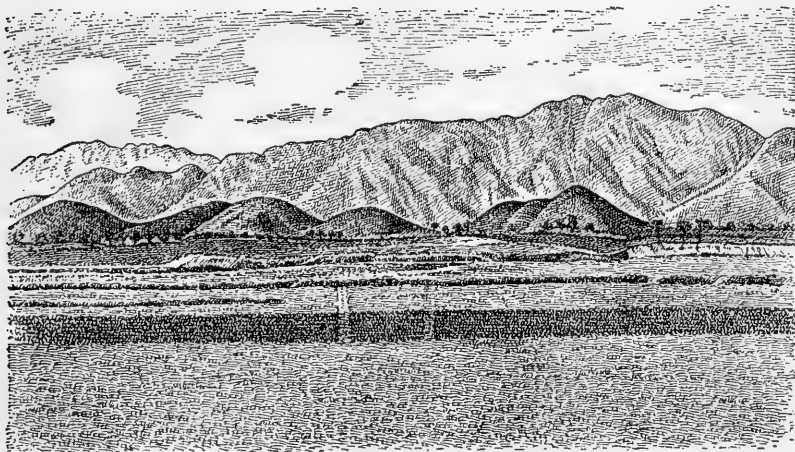

FIGURE 19.—Group of ancient grave mounds, northwestern China.

#### THE BRONZE AGE REACHES WESTERN JAPAN

Apparently about the close of the Chou period or very shortly thereafter, bronze began to appear in western Japan. It came from the Asiatic continent by two routes, the one through Kyushu, westernmost of the larger islands of the archipelago, the other from Korea to the northwestern shores of the main island. The area over which it diffused itself was roughly that bordering the Japanese Inland Sea; it did not extend far beyond the eastern extremity of that body of water.

#### IRON AGE

##### IRON APPEARS IN CHINA

The advent of iron in China had no such revolutionary effect on the development of civilization there as had that of bronze, something like a thousand years earlier. It had no immediate influence on the political, social, or economic life of the country, but meant merely

the gradual substitution of one metal for another as the superiority of iron over bronze for certain purposes became slowly apparent.

Iron had been well known in the Near East for something like a thousand years before it appeared in China, first perhaps in the Yangtze Valley. The balance of probability seems to be that the knowledge of how to smelt and work iron reached China from northern India. The route it followed was apparently the one traversed by rice, the domestic fowl, and other culture traits almost certainly of Indian origin—in other words, the same region through which passes the highly strategic Burma Road.

At all events we find domestic utensils and agricultural implements being made of iron around 500 B. C. In both the Yellow River and the Yangtze basins, however, that metal only very slowly supplanted bronze as the material for weapons. A similar phenomenon also occurred in Homeric Greece, where bronze continued to be employed for weapons of war long after iron was being used for domestic utensils.

Superior iron ores and abundant wood for charcoal encouraged production of steel in the Yangtze Valley; but in northern China, where wood was scarcer, coal came to be used in the reduction and manufacture of iron.

Long, straight, steel swords, often double-edged and far superior to the old short ones of bronze, appeared in China toward the close of the Chou period. Weapons apparently very similar are shown on the Assyrian monuments of something like 500 years earlier, and were probably carried both east and west by the steppe peoples; in the Occident this type eventually developed into the "Crusader's sword."

Swords of this type may, too, very possibly have aided the warlike northwestern state of Ch'in in its conquest of all China, late in the third century B. C. These blades seem to have come into general use in China (save in the extreme south, where bronze still lingered), shortly before the commencement of our era.

#### FALL OF THE CHOUS: FIRST CHINESE EMPIRE

During these conquests, Ch'in brought to an ignominious end the very ancient Chou Dynasty, long since lapsed into powerlessness and insignificance. In its stead, toward the close of the third century B. C., the reigning king of Ch'in established a real Chinese Empire.<sup>9</sup> This he erected on bureaucratic foundations of which traces survive even today. As its absolute ruler he assumed the title "Shih Huang Ti"—"First Emperor." (For a view and plan of the enormous grave mound of this man of genius, see pl. 1, and fig. 18.)

<sup>9</sup> From the name Ch'in almost certainly comes our own for China. Those who dispute this, on the ground that the latter name appears (in India) before the founding of the Chinese Empire, forget that the *state* of Ch'in had previously annexed the eastern terminal of both the two transcontinental routes linking China and the Occident (see map, fig. 1).

## SPREAD OF IRON TO NEIGHBORING LANDS

Into many adjacent regions, such as southern China, Manchuria, Korea, and western Japan, iron was introduced from northern China, during the early centuries of the Christian Era. In certain of these regions, as we have just seen, bronze had already begun to be used; but there iron soon overtook and superseded it. In other areas, as for example eastern Japan, where bronze had not yet been adopted, the transition was direct from the Stone Age to that of iron, without the interposition of a Bronze Age at all. This is in fact what has taken place in most parts of the world.

The seaboard region of northern China was still in the hands of non-Chinese peoples until late in the first millennium B. C. For example, the birthplace of Mencius, about the middle of the fourth century B. C., had less than 200 years earlier (i. e., in the time of Confucius) still been in the hands of "barbarians." The assimilation of the coastal populations of northern China by the Chinese civilization seems indeed to have been a cultural rather than a military conquest.

The inhabitants of extreme southern China, perhaps of the Mon-Khmer linguistic stock, were yet in the Bronze Age at the beginning of the Christian Era; but they soon thereafter came under the influence of the Chinese civilization, already in its Iron Age, pushing down from the north.

*Southern China.*—The numerous waterways and the bold, deeply indented coast line of southern China naturally invited the development of an essentially aquatic mode of life (Bishop, 1934, pp. 316-325; 1938b). Probably even before knowledge of metals had appeared, large dugout canoes were being made. (See fig. 15.) These, propelled by paddles alone, were nevertheless capable of long voyages along the Asiatic coast. Not, however, until the sail had appeared could penetration of oceanic areas begin.

This southern culture had before the (local) dawn of history spread as far as southern Korea, western Japan, and the East Indian islands. Today it survives in purest and least modified form (though it knows iron) in parts of Borneo and of Indo-China.

*Indo-China.*—The civilization of Indo-China, though resting basically on a strong aboriginal foundation, was greatly affected by the more advanced ones of both China and India. These began to make themselves felt there around the beginning of the Christian Era, and provided the necessary stimulus for the development of a characteristic form of culture during the first millennium A. D.

*Korea.*—Northern Korea, too, was drawn increasingly into the Chinese cultural orbit. This tendency was accelerated and augmented; toward the close of the first millennium B. C., by refugees fleeing from

disorders in northern China. Also, the great Han emperor Wu Ti (see fig. 20), late in the second century B. C., established a Chinese colony in northern Korea which survived for several hundred years; while an independent kingdom with a civilization of Bronze Age type arose about the same time or perhaps a little later in the south-eastern part of the peninsula. Both colony and kingdom became im-

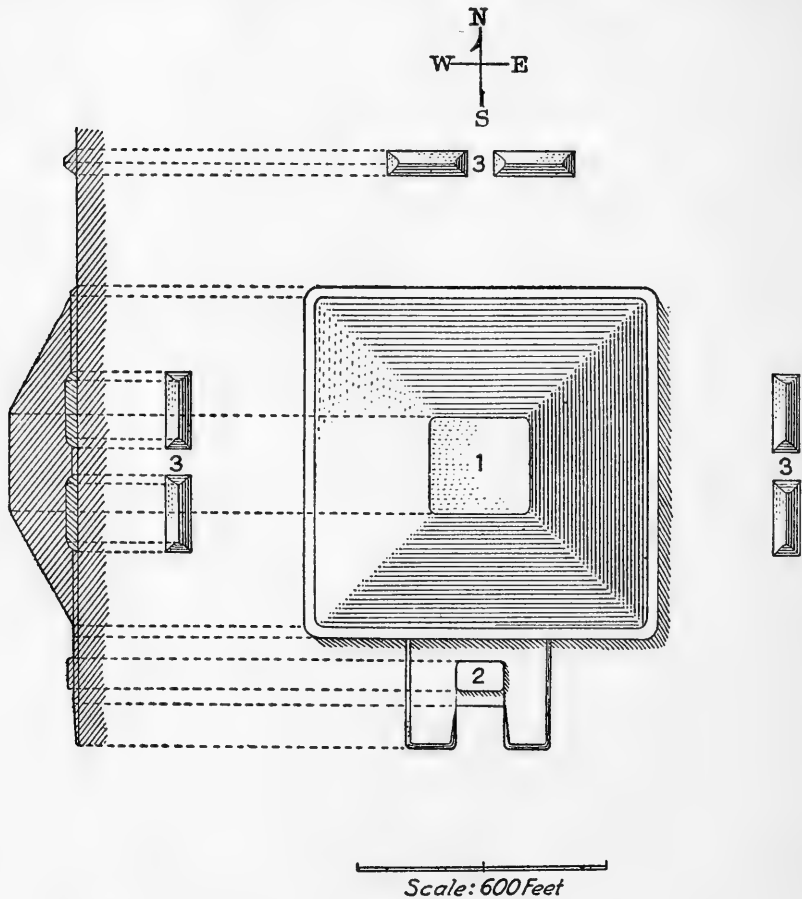

FIGURE 20.—Plan and elevation of grave mound of Han Wu Ti.

portant secondary centers from which civilizing influences spread over much of eastern Asia.

*Japan.*—Toward the close of the Chou period again, a stream of cultural influences from around the mouth of the Yantze River reached Kyushu, in western Japan. In that country it encountered other streams from Korea and even from southern Manchuria, and intermingled with them to form the historical Japanese civilization. The

latter also thus owed its origin and stimulus entirely to the continent of Asia, especially to China.

The founder of the Japanese imperial line, the "official" Japanese accounts tell us, was descended from the Sun Goddess, and conquered the western part of the archipelago.<sup>10</sup> At that time and for long afterward, central and eastern Japan remained in the hands of the Ainu aborigines, then (from their remains) still in the Neolithic stage of culture but gradually absorbing more advanced elements of civilization from their invaders and ultimate conquerors.

The very brief and partial Bronze Age culture of western Japan was thus soon superseded by an Iron Age civilization of continental origin, which by the close of the first millennium A. D. had overspread the entire archipelago save its extreme northern portion.

The Japanese Early Iron Age (the so-called Dolmen Period) was characterized by burial in megalithic chambers or dolmens over which great mounds were erected; by the form of steel sword used; by fighting on horseback with the bow and arrow; and by many other traits, most of them Chinese in origin but others pointing in the direction of central Asia and even of the Occident. (Sansom, 1932.)

#### SUMMARY

Let us now recapitulate. Forms of man have occupied eastern Asia from very ancient times—from the early Pleistocene period at least—for "Peking man," one of the most primitive human types yet found, dates from that remote epoch.

Paleolithic (Old Stone Age) man later appeared in northern China, Mongolia, the extreme south of Asia, and perhaps Japan. He may also, there is some reason to suspect, have spread to the Philippines while those islands were still attached to the continent of Asia, and have survived there for a long time.

Later yet, though still long before the dawn of history, various forms of Neolithic (New Stone Age) cultures spread all over the Far East, where they are divisible into two fundamental classes, a northern and a southern. These both agree however in deriving their subsistence from planting, eked out in the one case by hunting, in the other by fishing. They had thus both already passed far beyond the stage of mere food gathering and had become food producing. Probably toward the second half of the third millennium B. C. there appeared in northern China, near the eastern end of the "corridor of the steppes," a more advanced culture, still Neolithic or New Stone Age in character—that is, quite without metals—but possessing a painted pottery that

<sup>10</sup> The date claimed by the Japanese for the founding of their imperial line, 660 B. C., is of course absurd. The actual time seems to have been about the commencement of our era, and reliable and continuous Japanese history does not begin until considerably later still.

has been likened to similar forms of ware found in southeastern Europe. Not long afterward, again, probably around 2000 B. C. there arose in the same general region a Chalcolithic period, with the first evidence of bronze in China.

A little later still—toward the middle of the second millennium B. C., for we have now reached the protohistoric era—we find in the Yellow River basin a highly developed civilization of Bronze Age type, based on almost the same set of fundamental elements as had been the far more ancient river valley civilizations of the Near East.

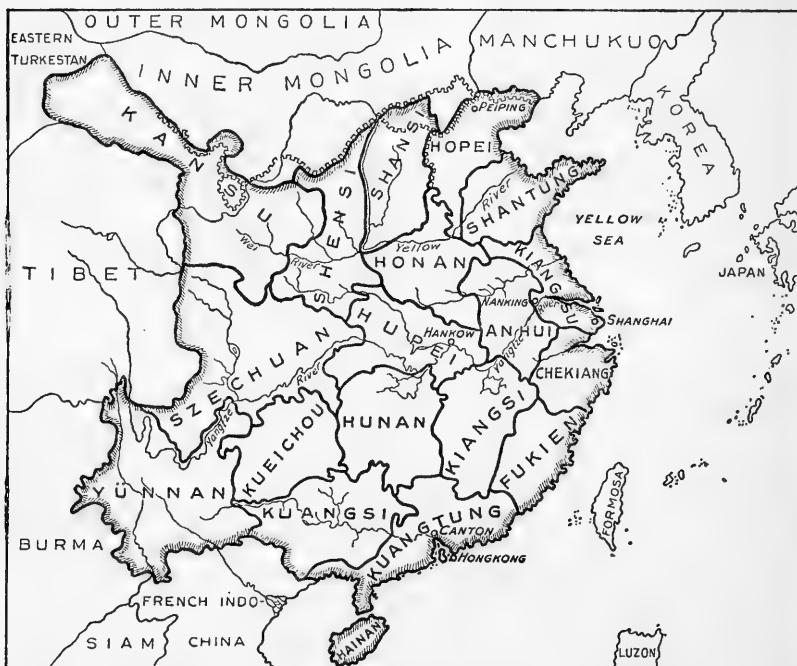

FIGURE 21.—Map of China, showing the 18 provinces.

This new culture—of its origin we as yet know nothing—slowly diffused itself until toward the middle of the following millennium it overspread most of northern China.

It then went on to penetrate various marginal areas, notably southern China, Korea, and western Japan. Soon afterward, however, it yielded place in turn to an Age of Iron (of rather archaic type, it is true, compared with the one that had already come into being in the Near East over half a millennium before).

Thus our survey reveals to us one outstanding fact, viz, that as civilization advanced in the Old World, it developed not one but two great centers of culture diffusion—the Near East on the one hand, China on the other. The latter country has in fact played a civilizing role in



eastern Asia quite worthy of comparison with the better-known one assumed in the Occident by Babylonia and Egypt, by Greece and Rome.

## REFERENCES AND SELECTED BIBLIOGRAPHY

ABBOT, C. G., HRDLIČKA, ALEŠ, and BISHOP, C. W.

1938. Man from the farthest past. *Smithsonian Sci. Ser.*, vol. 7. New York.

ANDERSSON, J. G.

1929. Der Weg die Steppen. *Bull. Mus. Far Eastern Antiquities*, No. 1, pp. 143-163. Stockholm.

1934. Children of the Yellow Earth: Studies in prehistoric China. London.

BISHOP, C. W.

1925. The ritual bullfight. *China Journ.*, vol. 3, No. 12, pp. 630-637, December.

1932a. China: Aesthetic development. *Enc. Britannica*, 14th ed., pp. 546-549.

1932b. The rise of civilization in China with reference to its geographical aspects. *Geogr. Rev.*, vol. 22, No. 4, pp. 617-631, October.

1932c. The chronology of ancient China. *Journ. Amer. Orient. Soc.*, vol. 52, No. 3, pp. 232-247, September.

1933a. The Neolithic Age in northern China. *Antiquity*, vol. 7, pp. 389-404, December.

1933b. Rhinoceros and wild ox in ancient China. *China Journ.*, vol. 18, No. 6, pp. 322-330, June.

1933c. The worship of earth in ancient China. *Journ. North China Branch Roy. Asiatic Soc.*, vol. 64, pp. 22-43. Also printed in *Excavation of a West Han Dynasty Site*, pp. 1-20, Shanghai, 1932.

1934. The beginnings of north and south in China. *Pacific Affairs*, vol. 7, No. 3, pp. 297-325, September.

1936. A civilization by osmosis—ancient China. *Amer. Scholar*, vol. 5, summer No., pp. 323-326.

1938a. An ancient Chinese capital: Earthworks at old Ch'ang-an. *Antiquity*, vol. 12, pp. 68-78, March. Reprinted in *Ann. Rep. Smithsonian Inst. for 1938*, pp. 569-578, 1939.

1938b. Long-houses and dragon-boats. *Antiquity*, vol. 12, pp. 411-424, December.

BUXTON, L. H. DUDLEY.

1928. China, the land and the people. Oxford.

CHAO, Y. R.

1932. Music, in *Zen*, Symposium, pp. 82-96.

CHI, CH'IAO-TING.

1936. Key economic areas in Chinese history. London.

CREEL, H. G.

1935. Dragon bones. *Asia*, March, pp. 176-182.

1936. The birth of China. New York.

1937. Studies in early Chinese culture. Baltimore.

CRESSEY, G. B.

1934. China's geographic foundations. New York and London.

HODOUS, L.

1927. Folkways in China. London.

HUDSON, G. E.

1934. Europe and China: A survey of their relations from the earliest times to 1800. London.

## HU SHIH.

1932. Religion and philosophy in Chinese history, *in Zen, Symposium*, pp. 51-58.

## JANSE, OLOV.

- 1930a. Quelques Epees anciennes trouvees en Chine. *Bull. Mus. Far Eastern Antiquities*, No. 2, pp. 67-134. Stockholm.  
 1930b. Antiquites Chinoises d'un Caractere Hallstattien. *Ibid.*, pp. 177-183.

## KARLBECK, ORVAR.

1925. Ancient Chinese bronze weapons. *China Journ.*, vol. 3, No. 3, pp. 127-133, March.

## KARLGREN, BERNHARD.

1923. Sound and symbol in Chinese. London.

## LATOURETTE, K. S.

1934. The Chinese, their history and culture. 2 vols. New York.

## LAUFER, BERTHOLD.

- 1914-1915. Some fundamental ideas of Chinese culture. *Journ. Race Develop.*, vol. 5, No. 2, pp. 160-174.  
 1934. Chinese clay figures. Chicago.

## LI CHI.

1928. The formation of the Chinese people: An anthropological inquiry. Harvard Univ. Press.  
 1932. Archaeology, *in Zen, Symposium*, pp. 184-190.

## MASPERO, HENRI.

1927. *La Chine Antique*. Paris.

## POPE-HENNESSY, U. B.

1923. Early Chinese jades. London.

## SANSOM, G. B.

1932. Japan, a short cultural history. London.

## TAO, L. K.

1932. Social changes, *in Zen, Symposium*, pp. 293-304.

## TING, V. K.

1932. How China acquired her civilization, *in Zen, Symposium*, pp. 9-30.

## WILHELM, RICHARD.

1929. A short history of Chinese civilization. New York.

## WILLIAMS, E. T.

1927. China, yesterday and today. 3d ed. New York.

## WILLIAMS, S. WELLS.

1901. *The Middle Kingdom*. Rev. ed., 2 vols. New York.

## ZEN, SOPHIA R. CHEN (editress).

1932. A symposium of Chinese culture. Rev. ed., Shanghai. (Cited as "Zen, Symposium.")



GRAVE MOUND OF CH'IN SHIH HUANG T'I, FOUNDER OF THE CHINESE EMPIRE AND BUILDER OF THE GREAT WALL.  
(D. 210 B. C.)



1. NEOLITHIC PIT DWELLING, BLOCKED OUT FOR EXCAVATION.



2. SIMILAR UNDERGROUND HUT, AFTER CLEARING.

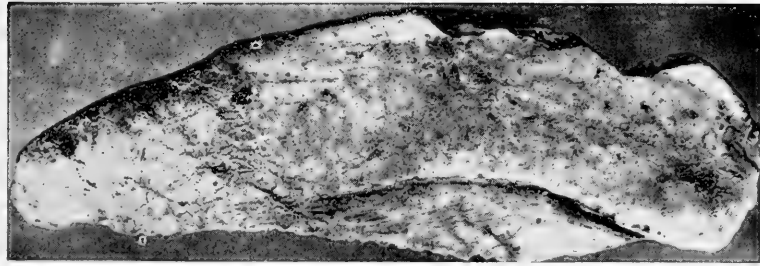

1. SICKLE BLADE OF SHELL WITH SERRATED EDGE.



2. TWO VIEWS OF ANTLER CHEEKPIECE OF BIT.

This form not hitherto reported for ancient China, though occurring in Europe.





1. CHINESE WATER WHEELS MADE OF BAMBOO.



2. CHINESE SUSPENSION BRIDGE WITH BAMBOO CABLES.



1. JUNKS UNDER SAIL, HANGCHOW BAY, NEAR NINGPO.



2. SCENE ON UPPER YANGTZE RIVER.



1. TRAVEL BY LAND.  
Loess deposits in distance.

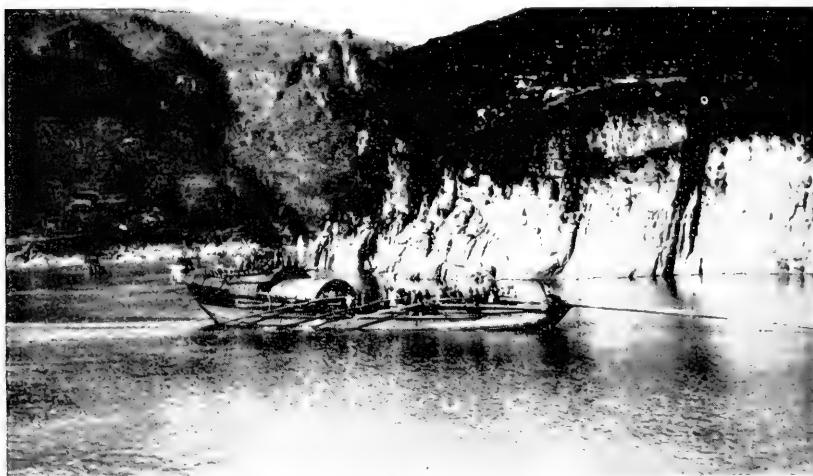

2. TRAVEL BY WATER.  
The Yangtze Gorges.





1. PILE VILLAGE NEAR YANGTZE RIVER.



2. COUNTRY VILLAGE, NORTHWESTERN CHINA.



1. TEMPLE OF HEAVEN, PEKING.



2. SUMMER PALACE, NEAR PEKING.



1. TEMPLE AT SACRED SPRING, NORTHWESTERN CHINA.



2. TOMB OF CONFUCIUS, JUST NORTH OF HIS BIRTHPLACE.



ANCIENT CHINESE LANCE POINTS AND KNIVES OF BRONZE.

Smithsonian Report, 1943. Bishop



CHINESE BRONZE VESSELS FOR CEREMONIAL USE, MIDDLE OF FIRST MILLENNIUM B. C.

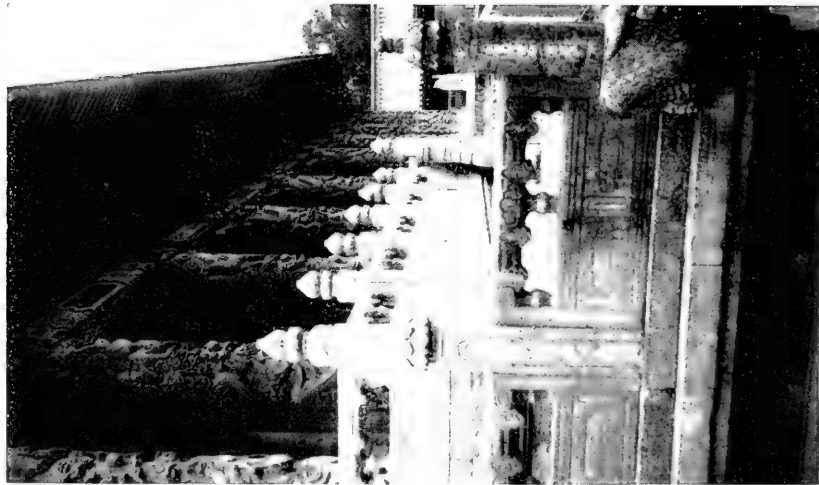

1. TEMPLE OF CONFUCIUS, AT HIS BIRTHPLACE.



2. WOODEN COLUMNS, THE MING TOMBS NEAR PEKING.

# CONTOURS OF CULTURE IN INDONESIA <sup>1</sup>

---

By **RAYMOND KENNEDY**  
*Yale University*

---

[With 12 plates]

The islands of Indonesia are of exceeding interest to the ethnologist for a variety of reasons. This is an ancient area of human habitation, where the history of man runs back to its very beginnings. Java Man stands at the head of Indonesian genealogy, and he lived hundreds of thousands of years ago. Since then, countless waves of migrants have moved into the islands. The ancestors of the primitive Tasmanians and Australians, the Oceanic Negroes of Melanesia, and the Polynesians of the Pacific all trod the soil of the Indies in long-past ages. The texture of history is deep here, deeper than almost anywhere else on earth.

Another remarkable fact about the Indies is that these historical levels have been caught in action, as it were, and preserved until the present day. The various tribes of the islands now exhibit in their cultures virtually the entire range of civilizations which have existed in the past. They represent a living reconstruction of the cultural progression that has taken place in the area. The way of life of the nomadic Kubu of Sumatra and Punan of Borneo is probably a fairly intact survival of general conditions in the archipelago 20,000 years ago, and other isolated groups preserve ancient patterns of culture in the same manner. The Batak and Gayo, now pushed back into the mountainous interior of Sumatra, show the kind of life prevailing much more widely in old times; and the Mentawai and Niassan peoples of the remote islands off Sumatra's west coast present a living picture of an even earlier period. The Minangkabau of Sumatra offer a good approximation to the culture all the later Malays possessed when they first entered the Indies. The Balinese civilization of today is a replica of the life of the medieval Hindu-Javanese, before Mohammedanism swept over Java in the fifteenth century. Thus the present range of cultures in Indonesia is a kind of living museum, giving a composite view of the development of civilization in the area.

---

<sup>1</sup> Reprinted by permission from *The Far Eastern Quarterly*, November 1942.

The Indies also stand out as one of the few remaining parts of the world where actively functioning and relatively intact native cultures may still be studied. Most of the interior regions have only recently been opened up to outside access, many large districts still remain virtually untouched by European influence, and the Dutch colonial administration has maintained a beneficent, paternalistic attitude toward its subject peoples, allowing and even encouraging them to continue their traditional ways of life with a minimum of interference. Probably the greatest factor in preserving the native cultures relatively intact is the enormous populations of the tribes, which are increasing steadily. In many if not most other "native" areas of the world the aboriginal groups have declined markedly in numbers as a result of white conquest. In Indonesia, force of numbers has given strength in resisting alien influences; and the result is that the islands offer a peerless field of research to the ethnologist wishing to study so-called primitive societies in action. And, as remarked above, the cultures cover an amazingly wide range: all the way from the simplest on earth to highly evolved civilizations of long standing.

#### RACIAL TYPES

The Hindu period of Indonesian history began about 1,500 years ago; and with it written records start. The ages before this can be reconstructed only by inference from archeology and legendry. Long before the dawn of written history the ancestors of most of the Indonesians had entered the islands; probably the last influx of the later Malays occurred around 2000 B. C. The only additions after that time were the relatively few Hindus, Arabs, Chinese, and, recently, Europeans. The earliest racial types in the islands have now either disappeared, or appear only in very remote tribes. These archaic strains are Australoid, Oceanic Negroid, Negrito, and Veddoid. The first two passed through the Indies long ago on their way to their ultimate homes in Australia and the Melanesian islands. Traces of them are still discernible in the present population, particularly in the easternmost islands of the Lesser Sundas, the Flores-Timor zone. The Negritos, the dwarf Negroid stock, also apparently very ancient in the Indies, are now pretty well submerged, but in a few places there are tribes showing Negrito characteristics. Mostly they dwell in the remoter districts: the swamps of east Sumatra, the mountainous back-country of the eastern Lesser Sundas, and the deep interior of New Guinea. The primitive, frail-boned Veddoid stock has also been forced out into the poorer swamp and jungle country of south Sumatra, interior Borneo and Celebes, and the eastern islands of Indonesia.



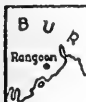

G U L F  
O F  
B E N G A



B A



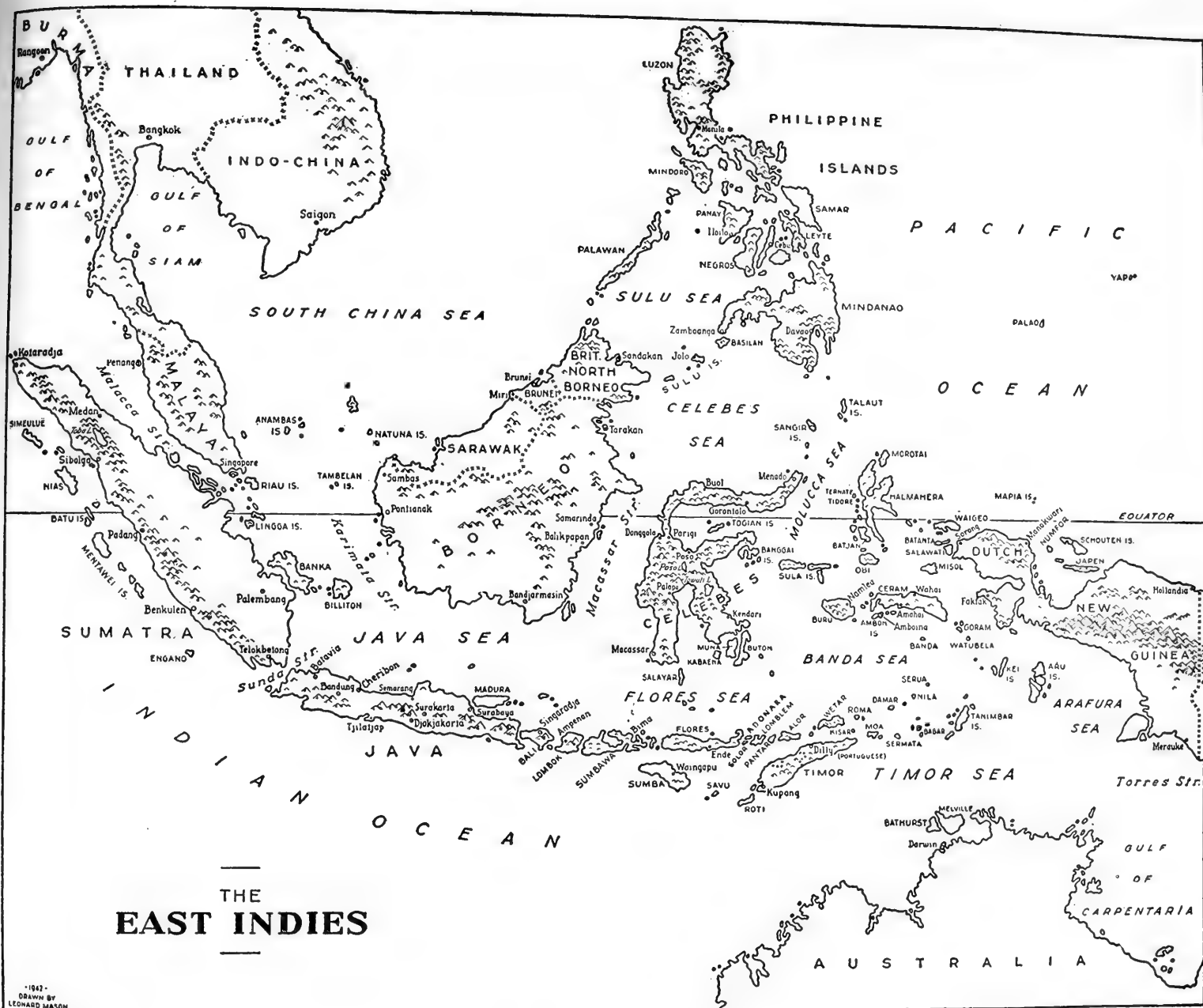

FIGURE 1.—The East Indies.



The two main racial strains are the proto-Malay and the deutero-Malay, or, as we shall call them, the earlier and the later Malays. Both of these racial types are small, brown-skinned, and wavy- or straight-haired; but the earlier Malays, who came into the islands from the mainland of Asia before the later stock, are generally more "Caucasoid" in facial appearance, shorter, more wavy-haired, and narrower-headed. The later Malay type looks much more Mongoloid, has predominantly coarse and straight hair, and is very broad-headed. Whereas the earlier stock is now restricted mainly to the interior districts of the large western islands and to the remoter eastern parts of the archipelago, the later Malay strain predominates in the coastal areas of western Indonesia, and has only recently spread in appreciable force to the eastern islands.

The cultural differentiation runs parallel with the physical, in general. Thus the tribes of earlier Malay type, inhabiting the more inaccessible regions, are still largely pagan in religion, only partially influenced by Hindu civilization or Mohammedanism, lack many of the more advanced techniques of material culture, and preserve ancient features of social organization. The later Malays, living mostly in coastal districts, have undergone strong Hinduist acculturation and are now nearly all Mohammedan in religion, possess a wide repertory of manufacturing techniques, and have long since adopted centralized state forms of government.

#### LANGUAGES

Despite these differences, which are due mainly to the relative locations of the two racial types, there are innumerable elements of cultural similarity prevailing throughout the islands.

One of these is language. All the peoples of Indonesia, with only three exceptions, speak languages belonging to the same basic stock, the Malayo-Polynesian or Austronesian, which also spreads over most of the Oceanic islands, the Philippines, part of southeastern Asia, and Madagascar. The three exceptions are the natives of northern Halmahera in the Moluccas, eastern Alor in the Lesser Sundas, and interior New Guinea. For want of a better term, these languages are lumped together as "Papuan," which means merely that they do not belong to the Austronesian stock but have not yet been properly classified otherwise. Few of the Indonesians can read and write. Those who do use either an ancient kind of script, derived from Hindu writing, or the Arabic alphabet. Recently, the schools established by the government and the missionaries have spread knowledge of the Roman alphabet over many districts. Some of the more primitive tribes, such as the Batak and Redjang of Sumatra, are able to write

in the archaic Hindu-derived script, but this is rapidly giving way to Arabic and Roman writing.

#### ECONOMIC ACTIVITIES

The principal economic activity is agriculture. Some groups still subsist largely by hunting and gathering wild products. These include the nomadic Kubu tribes of Sumatra, the Punan of Borneo, and a few of the remoter peoples of the eastern islands. The archipelago can be divided into three main agricultural zones, each distinguished by its principal crop. The western rice zone includes all the Greater Sunda Islands (Sumatra, Borneo, Celebes, and Java), and the western Lesser Sundas (Bali, Lombok, and Sumbawa). The central maize area, where corn is the mainstay of subsistence, covers the eastern Lesser Sundas and most of the southern Moluccas, as well as the Sula Islands in the northern Moluccas. The eastern sago zone, where the natives obtain their basic food supply from the meal of the sago palm, includes some of the southern Moluccas, nearly all of the northern Moluccas, and runs over into New Guinea. This is the general picture, to which minor exceptions could be made in a more detailed survey. Also, these areas are not mutually exclusive; maize is grown in regions where rice is predominant, and vice versa; while sago eaters in many instances also plant both rice and maize. Other crops, too, are cultivated, such as coconuts, yams, taro, and several varieties of vegetables, but the three main products are rice, maize, and sago. Wet rice, grown on irrigated fields, was introduced into the islands later than dry rice, which is planted in dry earth after the fields have been cleared and burned over. Irrigated rice agriculture has yet to reach the interior regions of the large western islands, and is almost totally unknown in the eastern parts of the Indies. Even dry rice has not spread to the easternmost islands, nor to some of the remoter districts of the Greater Sundas. It appears thus that rice is not a very ancient product of Indonesia, and that before it was introduced, perhaps about 2,000 years ago, yams, taro, and millet were the staple crops. Maize, an American plant, came only recently to the Indies, of course. The areas where it is now the staple formerly had millet as the main crop.

Dogs, cats, chickens, pigs, and goats are the oldest domesticated animals of Indonesia, and are found in nearly every district. Water buffalo and cattle, however, would appear to be much more recent, and are still absent in many parts of the Indies. Horses and sheep are the newest additions among the animals, the former having probably been introduced by the Hindus and the latter by the Europeans. Animal husbandry, except for the raising of pigs and chickens, is relatively unimportant in Indonesian economy, and the native diet

includes far more fish than meat. Fishing, indeed, ranks second only to agriculture as a source of food.

### HOUSES

Nearly all the houses of the Indies peoples are rectangular structures of wood or bamboo, with thatched roofs. In most regions they are raised up on piles, and this appears to be the more ancient type of construction. In Java and a few other places the natives build their dwellings directly on the ground, evidently a newer practice. In Bali, such buildings have clay walls rather than wood or bamboo, but this is a unique case. The Indonesian pile houses range in size all the way from the small single-family Malay structures to the enormous Borneo longhouses, often measuring hundreds of feet in length. There are isolated instances of divergent house types, such as the simple temporary shelters of nomadic tribes, the "beehive" circular dwellings found in parts of Timor and Flores and the little island of Engano off Sumatra, the floating raft huts of the Akit of Sumatra, and the round or oval roofed houses of the Land Dyak in Borneo, the northern Halmaherans, the Savunese, and the northern Niassans. Some of these, particularly the "beehive" structures, probably represent very ancient types which have now disappeared from most of the archipelago. Stone is almost never used for buildings in the Indies, but sculptured monuments of impressive size are erected by the Batak of Sumatra, the people of Nias off the west Sumatra coast, and the Sumbanese. Less pretentious stonework is done in many other regions, and the widespread occurrence of old megalithic remains throughout the archipelago indicates that in the past the use of stone for nonutilitarian, probably mostly religious, purposes was much more prevalent than it is at present. Under Hindu influence, Indonesian stone workmanship attained its supreme height in medieval Java. The Javanese have now lost this art, but it still flourishes in Bali.

### HANDICRAFTS

There are many places in Indonesia where the craft of weaving has yet to penetrate. There the natives, especially in central Celebes, make their clothes of bark cloth, which was once the only dress fabric known in the islands, except for matwork and leaf garments. Weaving arrived relatively late in the Indies and shows two levels of development. The older type of weaving, found in the more isolated districts, is done on a back-bar loom, which has one end of the frame attached to the weaver's body. The more complicated looms have fixed frames. Metalworking evidently predated weaving in the archipelago, and has spread much more widely. Indeed, only the most primi-

tive Indonesians lack the ability to manufacture articles of metal. Pottery, though undoubtedly a very ancient craft, is poorly done. It appears that the ready availability of bamboo and gourd containers inhibited the development of clay vessels in the area. Matwork and basketry and wood carving are universal handicrafts, practiced by even the lowliest tribes. The highest development of material culture occurs, however, in metal and woven artifacts, the finest of all Indonesian products being the ceremonial krisses and the beautifully batikked and ikatted (tie-dyed) textiles.

The most primitive peoples wear bark-cloth loin wrappings, although in New Guinea even these scanty coverings are dispensed with in some districts. The loincloth for men and the short kilt for women carry over into many tribes where woven fabrics are used, but the standard costume of the more advanced regions consists of a sarong and blouse for women, and a sarong or trousers and shirt for men, all made from either locally woven material or trade cloth. Body ornaments are most elaborate on intermediate levels of culture—among the earlier Malay peoples of Borneo, Celebes, and Sumatra, for instance—and decrease in quantity and variety on either end of the cultural spectrum, among the most primitive and the most civilized groups. The most popular decorations are headdresses, ear pendants, necklaces, and arm and leg rings.

Artificial mutilation of the body, for the purpose of beautification and sometimes with social and religious implications, reaches an amazing development in Indonesia. Virtually universal are ear piercing, often involving extreme distension of the lobes and incision of the upper part of the ear as well, and filing of the front teeth, either to points, or horizontally, or with grooves on the outer surface. Almost as prevalent is mutilation of the male sex organ. The older practice is supercision, or splitting the upper part of the prepuce without removing any flesh. Evidently more recent, and largely confined to Mohammedan regions, is true circumcision, or cutting off the prepuce entirely. Incision of the female genitals is so closely coextensive with circumcision that it would appear to be a later, and perhaps associated, practice. A few tribes in Borneo and Celebes pierce the penis for the insertion of knobbed rods or similar devices, the purpose being purely erotic—to augment the sensation of women in coitus. Tattooing is now confined mainly to the less advanced places, but formerly was much more widespread in the archipelago. Borneo, incidentally, is probably the greatest tattooing region in the world. The foregoing are the principal forms of bodily mutilation in the Indies. Sporadic occurrences of artificial head deformation, scarification by burning and cutting, body painting and stippling with resin, and hair bleaching with lime complete the list, except for nose piercing, which is confined to New Guinea.



Spears, swords, and shields are, or were, virtually universal weapons in the islands. The bow and blowgun also find widespread use; but the former is more general in eastern Indonesia, the latter in the western part. This probably means that the blowgun is a more recent weapon than the bow. Clubs and slings are rare, but appear to have been more important in ancient times. One mention of returning boomerangs appears in the literature; they are used as toys in a section of central Celebes.

Although the more advanced peoples of the archipelago have built and navigated large sailing ships for centuries, the Indonesian boat par excellence is the dugout canoe with outriggers. With very few exceptions, the outriggers extend from both sides of the canoe. The attachments of the floats to the booms become more complicated toward the eastern parts of the Indies, and in the Moluccas a wide variety of outrigger styles can be seen. Transportation of goods overland, except in areas where animals take the place of human porters, regularly involves the use of back baskets, with lines going over the forehead or shoulders, or both, in all the primitive parts of Indonesia. The balance pole has replaced the back basket in most of the more advanced regions.

#### SOCIAL ORGANIZATION

The social organization of the Indonesian peoples shows three levels of development. First there are the few modern cities, where the natives are partly Europeanized. Then there are the native states, still semi-independent in most cases, a form of organization originally imported in Hindu times about 1,500 years ago. Before that, the social systems of the Indies had never developed beyond the tribal or village-community stage, which is the third, and by far the most important, level even today in most of the islands. The tribes have little functional significance generally; the basic unit of native government and social organization is the village community, and each of these small groups lives almost entirely independent of the others—politically and economically—even within the same tribal area. Where life is still nomadic, the same pattern holds, and the small bands of wandering Kubu and Punan are functionally discrete units. The prevailing style of government, in both nomadic and settled tribes, is democratic. Chiefs are chosen by general consent, even where the office passes down through a single family line, for an unsuitable successor will be deposed by his people. Moreover, the village councils, composed of all or nearly all the adult males as a rule, exercise effective control over the actions of the chiefs. Economically, too, the Indonesian communities are basically democratic, with communal ownership of land and little class distinction on the

basis of wealth. Despotism in government and marked inequality in property ownership are in nearly all cases traceable to "higher civilization."

In most parts of the islands, the only important social unit besides the community is the family, or rather the extended family, for the Indonesians lay more emphasis on the remoter degrees of kinship than do Europeans and Americans. The majority of the tribes reckon relationship on both the maternal and the paternal sides, as we do; but in certain groups either the female or the male lineage determines a person's family membership. Throughout Java, Borneo, and Celebes, the bilateral type of family prevails; but in most of Sumatra, the Lesser Sundas, and some of the Moluccas, either matrilineal or patrilineal kinship schemes predominate. The kind of relationship system that a tribe employs determines the marriage rules. Thus, while all groups taboo primary incest (marriage with parents or brothers or sisters), those with the "mother family" extend the prohibition of marriage to quite distant degrees of relationship on the mother's side, but may allow even first-cousin marriage if the parties are connected by way of their fathers. Exactly opposite rules apply in groups with the "father family." In parts of Sumatra and in some islands of eastern Indonesia, matrilineal and patrilineal systems of kinship become vastly elaborated by the development of clans. Where this occurs in a patrilineal tribe, the taboo on marriage applies to all members of the father's clan, no matter how distantly related; while in matrilineal tribes all persons in the mother's clan are forbidden as mates. Generally, also, the mode of reckoning descent governs place of residence after marriage—i. e., with the wife's or the husband's people—although in many bilateral kinship areas, notably Borneo and Celebes, even though male relationship is considered as important as female, a married couple nearly always reside among the wife's people.

In eastern Sumbawa, Flores, and the Alor-Solor Islands, totemism, or belief in the descent of clans from animals or plants, occurs; and in some districts here the clans are grouped in marriage classes, with complicated rules of intergroup mating, a pattern strikingly reminiscent of certain New Guinea, Melanesian, and Australian social systems.

#### NATIVE RELIGION

Indonesian native religion rests basically upon three partly overlapping and partly independent sets of concepts, i. e., beliefs concerning magical power, spirits of various kinds, and the ghosts of the dead. Even where Hinduism, and later Mohammedanism and Christianity, have affected the beliefs and practices of the people, the ancient

pagan cults persist and strongly color the more recently adopted religions. The magical concepts emerge in the head-hunting complex, for hunting of heads is preeminently a religious duty, calculated to enrich the supply of spiritual force of a community by capturing heads, and the supernatural power they contain, from some other group. Many of the rituals of the native tribes have the same purpose, and priests and priestesses are regarded as experts in the technique of gaining access to and drawing upon the store of magical force that pervades the universe. Mostly the purpose is beneficent—to heal the sick, improve crops, and the like—but black magic can be used against enemies. The spirit beliefs and practices are more specific than those connected with magic. The rituals are “pointed” at certain recognized spirits, whose properties and powers are known. Some of these beings are good, others bad; and the principal purpose of the spirit cult is to gain the favor of the former in combating the malevolent designs of the latter. Most of the tribes have ideas concerning the existence of pantheons of high gods, but these deities are too lofty and remote to exercise much immediate influence over lowly humans. Therefore the lesser spirits—of the earth, water, air, and sacred places—occupy a more vital and intimate place in the native religions.

Probably the most important cult in Indonesia, as in much of eastern Asia, has to do with the ghosts of the dead and the ancestors. The funeral ceremonies of the Indies are more elaborate than perhaps anywhere else in the world, and sacrifices to the departed ghosts, who are powerful intermediaries between their living relatives and the gods and spirits, must never be neglected. Fear of and respect for ancestors, whose existence in the afterlife is vividly real to the Indonesians, make for stubborn conservatism, because the ancestors are sure to be angered by any change in the ways they were used to on earth, and will withdraw their favors from the living if the old customs are not preserved.

Despite later infusions of Hinduism, Mohammedanism, and Christianity, the base of Indonesian religion is still paganism, the traditional beliefs and practices of the ancestors. “Conversion” usually means merely taking on new names for old things. Nevertheless certain areas have been strongly influenced by alien religions. Bali is unique in preserving the old Hinduist religion, which 600 years ago was the faith of all Java and most of Sumatra. Mohammedanism, of varying degrees of “purity,” has since spread over nearly all of Sumatra, Java, and the coastal lands of Borneo and Celebes. It is steadily making converts throughout the eastern islands, some of which—notably Lombok and Sumbawa—are nominally almost completely Islamized. Christianity has never been able to make headway

in previously Mohammedanized regions; indeed, the areas of influence of the two religions are mutually exclusive to a marked degree. Despite centuries of missionary effort and enormous expenditures in Mohammedan Java, for instance, there are now only about 200,000 Christians there, and probably not more than half of these are natives. Christianity has made best progress among formerly pagan tribes: the Batak of Sumatra, the Toradja and Minahasa of Celebes, and the Amboinese of the Moluccas.

In general, the contours of culture in Indonesia display a strikingly regular pattern of stratification. In the far eastern islands and in the deep interior regions of the larger land masses, the most archaic racial types and cultures are preserved. In the more accessible inland districts of the Greater Sundas and in the westerly islands of the Lesser Sundas, the racial stock is of the earlier Malay type and the level of culture is "intermediate." Finally, in the coastlands of western Indonesia, one finds the most recent physical types and cultural accretions, which are steadily spreading inland and eastward into the territories where until today the ancient peoples of the Indies carry on their age-old traditions in the shadow of impending change.



1. NATIVE OF KUPANG, TIMOR.

The Melanesian physical type, with Negroid features and woolly hair. A hair cylinder is used to fashion the pompoon coilure. (Courtesy Netherlands Information Bureau.)



2. NATIVE OF LARANTUKA, FLORES,  
IN FESTIVE ATTIRE.

The physical type shows a mixture of Melanesian Negroid and Papuan racial traits (c, e, f, the nose, though wide and flat, has a somewhat depressed and fleshy tip. (Photograph by J. Kunst.)



1. JAVANESE GIRLS IN WORKING CLOTHES.

The physical types show proto-Malay (Caucasoid) and deuterio-Malay (Mongoloid) mixture.



2. KARO BATAK GIRL, SUMATRA.

A slight Mongolization of the eyes is detectible, but the type is basically proto-Malay. The pillowlike headdress is characteristic of the Karo subtribe of the Batak.



1. BATAK WOMEN AND GIRLS, SUMATRA, SHOWING THE PROTO-MALAY (CAUCASOID) PHYSICAL TYPE.



2. SETI OF CENTRAL CERAM DOING A WAR DANCE.

The physical type is the so-called Alfur, the proto-Malay and Papuan hybrid characteristic of the Moluccas. (Courtesy Bataviaasch Genootschap.)



1. NIAS WOMEN DANCING, IN FESTIVE DRESS.

The Niassans, on special occasions, wear elaborate double earrings, headdresses, and armbands.



2. MENTAWEI WOMEN FISHING, SHOWING LEAF CLOTHING.

These people cannot weave, but make their garments of either bark cloth or leaves.





1. DYAK GROUP, WESTERN BORNEO. SHOWING WEAPONS AND WAIST RINGS OF BRASS AND RATTAN WORN BY WOMEN.

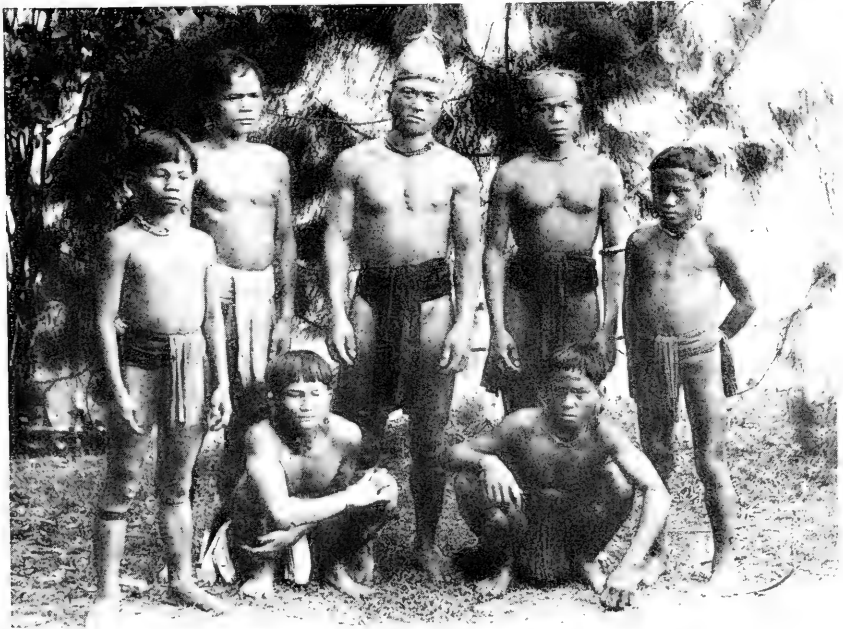

2. BAHAU DYAK GROUP, SHOWING DISTENDED EAR LOBES AND, CENTER REAR, PANTHER-TOOTH EAR ORNAMENTS WHICH MAY BE WORN ONLY BY SUCCESSFUL HEAD HUNTERS.

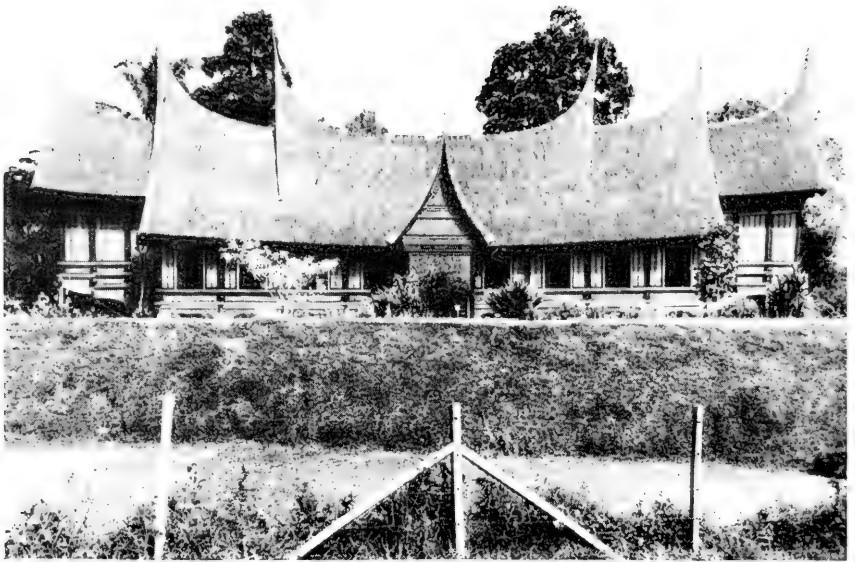

1. MINANGKABAU LONGHOUSE, SUMATRA.

All Minangkabau buildings have graceful saddle-shaped roofs. (Courtesy Netherlands Information Bureau.)



2. TOBA BATAK VILLAGE, SUMATRA, SHOWING THE SLOPING GABLES OF THE HOUSES OF THIS SUBTRIBE.

(Photograph by E. E. Muhs.)

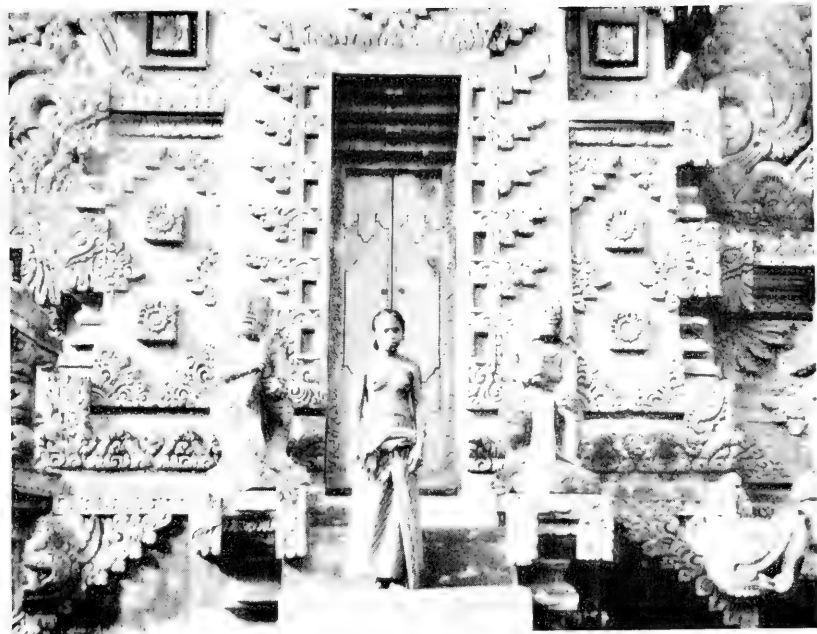

1. BALINESE TEMPLE GATEWAY WITH CARVED WOODEN DOORS.

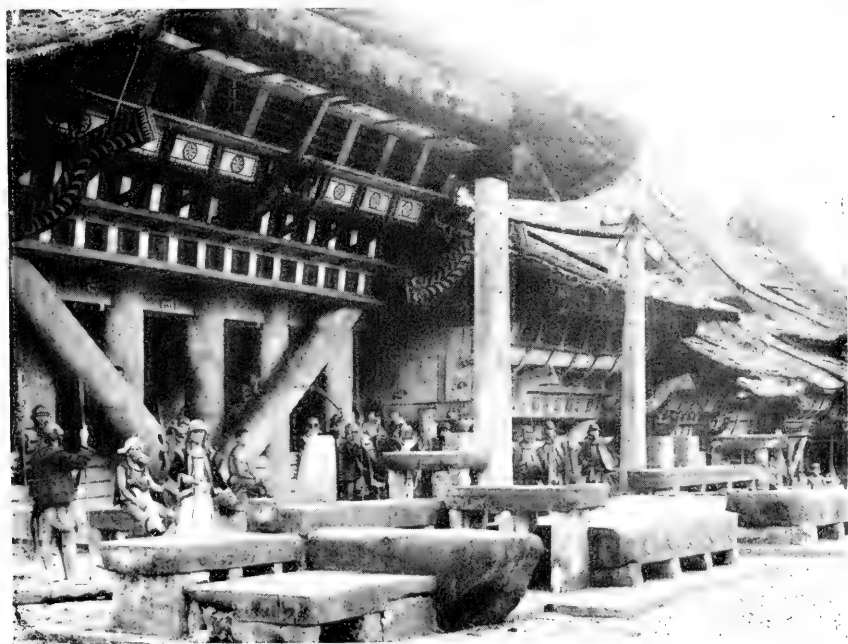

2. HOUSES IN NIAS WITH MASSIVE TIMBERS, CARVED AND PAINTED GABLES, AND HOODED ROOFS.

Sculptured stone monuments dedicated to ancestors, in foreground, on paved village plaza. (Courtesy Netherlands Information Bureau.)



MINANGKABAU OF SUMATRA IN CEREMONIAL COSTUME.  
These richly brocaded garments are *hujflooms*.

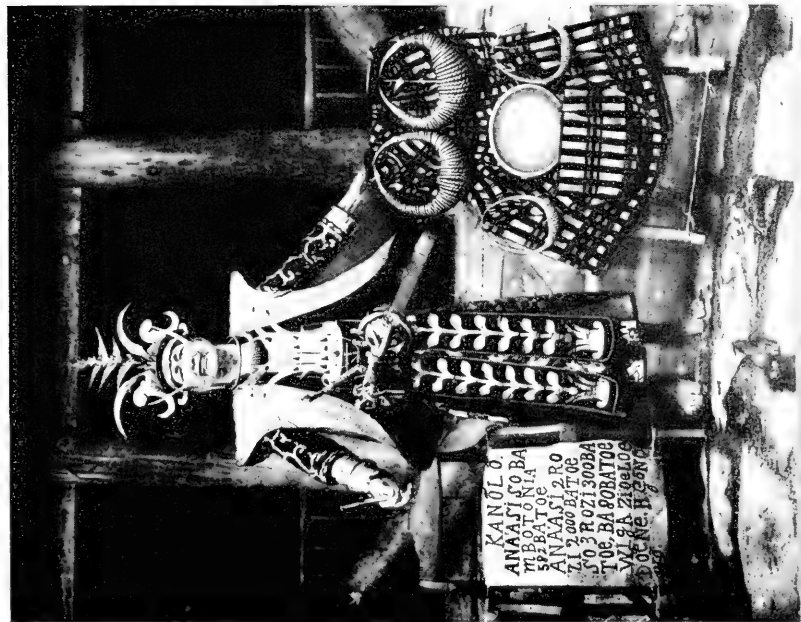

1. MAN OF NIAS IN CEREMONIAL COSTUME, INCLUDING THE WARRIOR'S NECK EMBLEM AND ELABORATE HEADGEAR.

The poster is printed in the Nias language, which was never written until recently.



A Toradja princess in the Celebes, Dutch East Indies. She crosses ropes of the Jira's comb, nearly to her nostrils.

2. TORADJA WOMAN, CELEBES, WITH RESIN STIPPLING ON HER FACE



1. JAVANESE COUPLE, THE MAN IN SEMI-EUROPEAN STYLE CLOTHING.

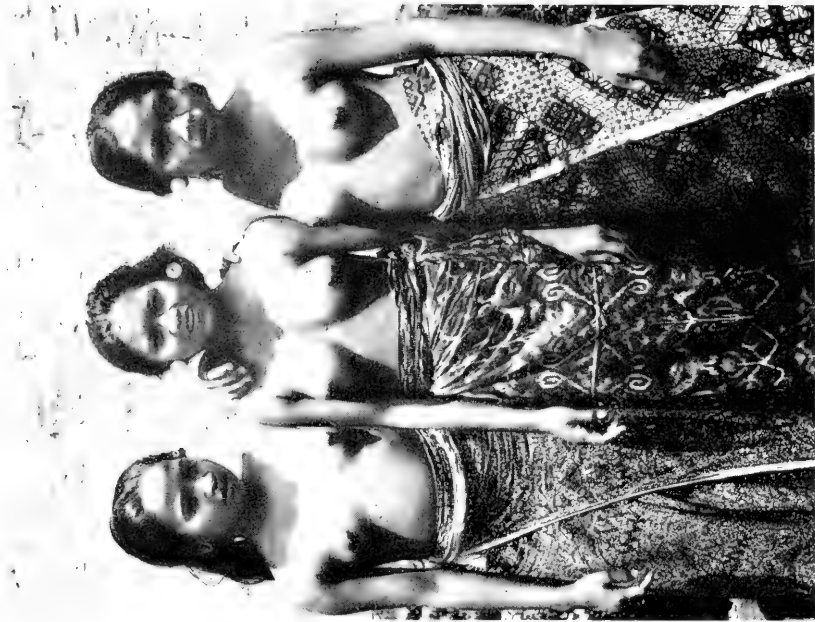

2. BALINESE GIRLS.

In the center, an *ikat* (tie-dyed) sarong; the other sarongs are batik.



1. MENTAWAI GIRL WITH TEETH FILED TO POINTS.



2. BAHAU DYAK, BORNEO, SHOWING DISTENSION OF THE EAR LOBES.



1. SADANG BURIAL CAVES. CELEBES. CHISELED IN THE FACE OF A CLIFF. They have wooden doors and carved guardian images. (Courtesy Netherlands Information Bureau.)



2. PALACE OF THE SULTAN OF SIAK, EASTERN SUMATRA.

Siak is one of the scores of native states which the Dutch ruled "indirectly," retaining the hereditary princes in office.



# THE ARAB VILLAGE COMMUNITY OF THE MIDDLE EAST

---

By **AFIF I. TANNOUS**

*Office of Foreign Agricultural Relations, U. S. Department of Agriculture*

---

[With 14 plates]

## THE REGION AND THE PEOPLE

Despite the fact that it consists of five political entities—Palestine, Trans-Jordan, Lebanon, Syria and Iraq—the region under consideration is in reality one cultural unit. Its geographic boundaries are determined by the Mediterranean Sea on the west, forming a coast line of about 750 kilometers; the Sinai and Arabian deserts and the Persian Gulf on the south; the Kurdistan Mountains on the east; and the Taurus Mountains of Turkey on the north. These boundaries enclose an area of about 770,000 square kilometers (300,000 square miles), of which not more than 85,000 square kilometers (32,000 square miles) are under cultivation by village settlements. The rest of the area consists of arid, sandy deserts and semiarid plateaus over which the nomadic Bedouins graze their herds.

An interesting variety of topographical and climatic features is encountered as one moves inland from the seashore. A narrow coastal plain, with high soil fertility and an altitude of less than 100 meters (about 330 feet), stretches from the Egyptian frontier in the south to the Turkish frontier in the north. In most places the coastal strip does not exceed 1 or 2 kilometers in width. Parallel with the coast and rising abruptly from it, extends a rugged mountain range, reaching its maximum height of over 3,000 meters (over 10,000 feet) in the Lebanon section. To the east of, and parallel with, the Lebanon Mountains rises the equally rugged but slightly lower Anti-Lebanon Range. Between the two ranges lies the high and fertile plateau of Bika'. In contrast with these high mountains is the Jordan valley depression in Palestine, with an altitude of about 100–300 meters (330–990 feet) below sea level. In the northeastern corner of the region stands the third significant mountain range, which is a continuation of the Taurus and Kurdistan Ranges. The remaining greater portion of the region consists of extensive semiarid plains and plateaus. The only two extensive river valleys are those of the Tigris and Euphrates,

running across Iraq from north to south. Smaller rivers are the Orontis in Syria, the Leontis in Lebanon, and the Jordan in Palestine. Along with this varied topography, a similar variation in climatic conditions is encountered. Along the coastal plain prevails the Mediterranean type of climate—a short and mild winter in which rain is concentrated, and a long, damp, and warm summer in which no rain falls. Here rainfall is relatively heavy, especially in the northern section where it reaches an average of over 30 inches per year. On the mountain heights snowfall is heavy during the winter, whereas the summer is cool, bracing, and dry. In the interior there is a marked variation in temperature between day and night and between summer and winter. Here rainfall is scanty. In addition to the above varieties, there is the subtropical climate of the Jordan depression in Palestine and of the Persian Gulf area of Iraq.

Between 9 and 10 million people live within the boundaries of this region. What strikes attention first is their pattern of distribution. As expected, the fertile coastal plains and river valleys are densely populated, whereas the extensive semiarid plains and plateaus of the interior support a sparse population. Coming to the Lebanon Mountains, however, we find a high population density of over 100 per square kilometer (260 per square mile). This is so despite the fact that these mountains are extremely rugged and their soil scanty. Obviously, not only geographical but also cultural factors must be taken into consideration in accounting for this apparent anomaly. Religious and political conflicts during the old Turkish regime forced the Christian minority to congregate and take refuge in the mountain heights.

A second feature of the population is the existence of a high birth rate and a high death rate, especially in the villages. Early marriage, emphasis upon family life as a major value, and the polygynous feature of the Muslim religion are some of the cultural factors responsible for a birth rate that ranges from 30 to 45 per thousand. This is more than double the rate for the United States of America. On the other hand, a death rate of 20 to 28 prevails, which also is much higher than the rate in the United States. A natural increase in population, however, has been the net result. With the advent of modern medical knowledge and sanitation, an acceleration in the rate of increase may be expected.

With respect to racial composition, the population of the region shows a marked degree of admixture. It is true that a relatively high degree of racial purity exists among the Bedouin tribes of the interior. This purity, however, which is the result of relative isolation and consequent inbreeding, becomes in general less and less evident as one moves away from the center toward the periphery, especially the

Mediterranean coastal area. Varieties of eye color, pigmentation, hair texture, and stature can be readily observed. Such a situation can be expected as a result of the fact that the region under consideration has been, since time immemorial, one of the most strategic meeting places of races, cultures, and nations. A large number of ancient peoples, Babylonians, Assyrians, Hebrews, Persians, Hittites, Phoenicians, and others, met there, intermixed, and succeeded one another. Then followed the Greeks, Romans, Arabs, Crusaders, and Turks, each contributing its racial strain to the already existing mixture. What is of primary significance in this connection is the outstanding fact that racial consciousness is practically nonexistent among the people. This is primarily a result of the predominant religion of Islam which accords equality to all Muslims in this life and the life to come, irrespective of color and lineage. It is well known that under the influence of their religious message the Arabs intermarried freely with the various races they conquered.

A fourth aspect of the population is its rural-urban composition. Here we have a situation that is heavily biased in favor of rural culture. A genuinely urban way of life is limited to the few main cities of the region: Baghdad, Basrah, and Mosul in Iraq; Aleppo, Damascus, Antioch, Homs, and Hama in Syria; Beirut, Tripoli, and Sidon in Lebanon; and Jerusalem, Jafa, and Haifa in Palestine. Consequently, between 65 and 80 percent of the inhabitants of these countries can be considered rural. A small minority of these are still in the nomadic stage, whereas the great majority are *fellahin*, agricultural people settled in villages.

Finally, with respect to the cultural composition of the population, one encounters a situation similar in its diversity of elements to that of racial composition discussed above. For thousands of years this part of the world has been a center of dynamic cultural contact. As nation followed nation on that stage, from the ancient Babylonians, Assyrians, and Egyptians to the western powers of today, cultures developed, met, selected and borrowed, invented, and passed on their heritage to future generations. Thus the past lays a heavy hand indeed upon the culture of the Middle East. Within this diversity of cultural origins, the Arabs, who have occupied the region since the middle of the seventh century A. D., have been able to achieve a stable integration, giving the prevailing culture a predominantly Arab orientation. Their religion of Islam is now embraced by about 85 percent of the population. Arabic, the language in which the Muslims believe that Allah revealed the Qor'an (Koran), is the mother tongue of each one of these countries. Dialects may differ from locality to locality, but written Arabic is the same for all. Other main cultural values and practices have been either modified

or originated by the Arabs and more or less uniformly spread throughout the region. Among these are emphasis upon family solidarity, exaltation of individual prowess and daring, group consciousness and identity rather than individualism, hospitality, and the predominance of the personal touch in all types of human relationships. The way in which a cup of coffee is prepared and served and its symbolic significance are practically the same in the Muslim villages of southern Palestine and in the Christian villages on the high slopes of Lebanon. Similarly, everywhere there is heavy dependence upon bread as the main staple in the diet and the same reverent attitude toward it.

## THE VILLAGE COMMUNITY

### ORIGIN AND DEVELOPMENT

Everywhere in the Middle East, whether on the coastal plains or on the high mountain slopes, on the interior plateaus or in the river valleys, the village type of rural settlement prevails. Unlike the North American pattern, practically no isolated farmsteads or rural neighborhoods exist between the villages. Farmers and animals live in the village, from which they go out daily to work in the surrounding fields and come back in the evening. The origin and evolution of the village type of settlement in this, the oldest part of the world, is lost in the remote and obscure past. It is certain that the village was there long before Biblical times. How long ago and in what manner it developed, whether directly as such or gradually along a line of several stages, is a matter that is still open for speculation. One can reasonably conclude, as did Professor Sanderson, that development possibly followed a line of transition from the nomadic tribe to the subagricultural group, to the semipermanent village, to the permanent village settlement.<sup>1</sup> This explanation seems to gain support from the contemporary existence in the Middle East of the older stages of settlement. In fact, one can observe the process of transition actually taking place. In general, it can be readily seen that as one moves from the coastal areas and river valleys toward the interior, villages assume less and less of a permanent character, until pure nomadism is reached. The large Bedouin tribe of Fa'oor, who used to roam with its herds over a wide area along the borders of Syria, Palestine, and Trans-Jordan is now in the process of transition. The Emir of the tribe and his brothers are rapidly developing into feudal lords. They and their entourage occupy a compound of modern stone buildings, whereas around the compound one still sees the old tents of the Arab nomads. Some branches of the tribe have begun to live in more permanent dwellings, made of reed cane or of

<sup>1</sup> Sanderson, Dwight, *The rural community*, chaps. 2 and 3. Ginn and Company, 1932.

stone. They still follow the seasons with their herds, but in addition they now cultivate the soil and raise crops. In the Jordan valley of Palestine, as well as in several places in Syria and Iraq, various stages of the same process of transition can be observed. Even in Lebanon, where permanent village settlement has been established since ancient times, the writer came across modified forms of the original nomadic and seminomadic stages.

#### LOCATION

The factors responsible for determining the location of each village are many and varied. A few of them, however, seem to be more outstanding and more common than others. An obvious one of these is the availability of water supply. The significance of this factor can be better appreciated when one is reminded of the fact that rainfall in the region is scanty (not exceeding 10 inches per year in most places) and that all of it is concentrated during 3 or 4 months of the fall and winter seasons. In Lebanon, where snow accumulates on the mountain tops, springs are abundant, and practically every village has one or more of these running through it or just outside its limits. The people use such village springs both for human consumption and for irrigation. In most of the villages of the interior, where running springs are scarce, the necessary water is obtained from wells, which are sunk to varying depths until the underground water table is struck. In other places cisterns are used, which are filled with rain water and which supplement other sources. Another way of supplementing the water supply is to dig a large and shallow pit just outside the village proper and make use of the accumulated rain water. In river valleys, naturally, direct use is made of the river water.

A second factor in the choice of a location is the matter of defense. Almost invariably, whether on the mountain heights, in the interior plains, or in the river valleys, one finds that the settlers have chosen the site that best lent itself to defense. This was essential in early times in the face of attacks from other villages or from marauding Bedouins. Hilltops, bluffs, and invincible shoulders of deep ravines afforded such easily defensible sites. It must be observed that this factor has lost its significance in the greater part of the region, in view of the prevailing public security.

Fertility of the soil has been another determining factor. This is to be expected in view of the fact that the village people are dependent almost completely upon agriculture for a living. Through the use of farmyard manure in some places, or the development of a suitable crop rotation in others, the people did their best to maintain the fertility of the land as long as possible. Permanent and continuous settlement on the same land for generations made the application of some conser-

vation techniques imperative. This has been singularly successful in the Lebanon Mountains where terracing and manuring have been extensively used. In some places, especially where manure is used for fuel, soil depletion could not be avoided.

It must be pointed out that in some cases all these factors of location, as well as others not mentioned, have been equally operative. On the other hand, we find a great number of villages in which one or more of the required conditions had to be neglected in favor of others that seemed more compelling. Such is the case of the Kura Valley in northern Lebanon, which offered the settlers an extremely fertile soil, but no adequate water supply. For a long time before underground water was discovered in some places, village people had to depend upon rain water and upon a running stream several miles away. All the villages on the rugged Lebanon slopes serve as an illustration of the predominance of the defense factor, which was eagerly sought by religious minorities.

#### PHYSICAL STRUCTURE

A compact, nucleated form of structure is the first striking impression one gets of the Middle Eastern village. It is a conglomeration of houses standing close to each other, divided by winding alleys and paths that do not seem to have any regular design. In parts of some villages the houses are so close together that one can walk or jump from roof to roof without much difficulty. In other villages the houses are scattered enough to leave room for small garden plots. To a casual observer such a mass of dwelling places shows no evidence of differentiation. Upon investigation, one finds that the people are conscious of the existence of certain sections in their village. Each one of these is called a *Hara* or a *Hei'*, which is usually the habitat of one kinship group. In this we see a carry-over from the tribal organization and an indication of the significance of family in the early development of the community.

Normally, the mosque or the church stands as the physical and cultural center of the settlement. Dwellings are erected on all sides of this center by the original family groups. As a family multiplies, its dwelling place also multiplies by a process of "budding." Under the influence of a strongly partilocal system, in which the wife comes to reside with her husband's people, the newly married couple add one more room on top or to the side of the groom's ancestral house where the rest of the family dwell. For generations this process of budding has been going on, resulting in the entangled mass of houses described above. Next to the church or mosque is the *Saha*, an open space where people hold social gatherings or present their produce for sale. In the villages of the interior, where regular biweekly or monthly markets are held, the *Saha* is of a fairly large size. Normally, the few

existing stores are located around this central space. In large villages, or those that have two religious sects, two centers exist. Such settlements may be designated as bicentral.

With respect to the structure of dwelling places, the following main forms may be distinguished. Tents, made mainly of goat hair, are used exclusively by the nomads. Shacks made of reed cane can be observed in marshy localities, such as exist in northern Palestine, northern Syria, and southern Iraq. This type of dwelling is used mainly by seminomadic tribes who are in the process of settlement. In the hilly areas of the region in general, and in Lebanon in particular, stone (mostly limestone) is the most common building material. It is cut by expert masons, of whom practically every village boasts a good number. In most cases stone is used exclusively in constructing the foundation, the walls, the ceiling, and the roof. A solid dome-shaped structure is the result, which may have a flat or a convex roof. Sometimes wooden beams are used for the ceiling and bricks for the roof. On the plains of the interior, adobe houses are the most prevalent. A special variety of these are the so-called beehive houses of some villages in northern Syria. The distinctive feature here is the conical shape of the dome, which helps to mitigate the effect of the blazing sun. A typical house of the whole region consists of a courtyard, which may or may not be surrounded by a wall, and two or more square rooms, one of which is occupied by the farm animals during the short cold season. In many cases, when the family dwelling consists of one room, it is shared by both animals and human beings. In some cases people occupy the top floor and animals the first floor. It seems that the idea of a separate barn has never taken root in that part of the world. Finally, it must be mentioned that in recent years, especially in the villages of the coastal area, some departure from the typical structure has been taking place. New detached houses are being built outside the original conglomeration and away from the ancestral home, and modern construction materials are being used.

Agricultural land owned or cultivated by the farmers begins just outside the village proper and extends in all directions from it. In some cases there is an established division of the land into zones. The first of these, adjoining the dwelling places, is used for gardens and an assortment of fruit trees. Farther out orchards prevail. In between, or beyond the orchards, are the open fields for the growing of cereals. On the outskirts, or wherever the land is brushy and least fertile, a portion is set aside for grazing. In many localities, however, no such zoning pattern exists. There are villages that use the land exclusively for raising cereals and grazing. Others specialize in raising fruits, and leave practically no space for vegetable gardens or for

grazing. A more regular and more outstanding feature of the village territory is its extreme fragmentation. In the mountain settlements this takes the form of an extensive system of terracing. A terrace is usually a few feet or a few yards wide and as long as the hillside. The side of the terrace is supported by a strong stone wall. In the valleys and on the plains, fragmentation takes the form of a great number of small plots, separated by a laborious network of hedges, ditches, or stone fences. The cultural necessity for this seemingly absurd agricultural practice will be pointed out later.

#### THE LAND

One of the strongest ties exists between the Arab *fellah* and his land. Its significance to him and his attachment to it cannot be explained in cold economic terms, for land is one of the few main pillars of village life, involving a deep-rooted complex of behavior and sentiment. For countless generations it has been the only source of life for him and for his ancestors. Year in and year out he has depended upon it to sustain him, and it did. He calls it the "blessed earth" and refers to it with reverence. He has worked on it since he was a child, and so did his ancestors before him. He inherited it from them, as they, in their turn, inherited the same land. The attachment is so strong that the *fellah* resorts to migration or to selling his land only under extreme pressure. One example of this is the great difficulty which the Egyptian Government has encountered in its attempt to settle some of the *fellahin* on newly reclaimed land, with a view to relieving high population pressure. They are offered all sorts of facilities and inducements, yet they are reluctant to leave their ancestral communities.

Another illustration is afforded by the early emigrants from the villages of Palestine, Syria, and Lebanon. Under extreme population pressure, they began to emigrate to the Americas around 1880-1890. In practically all cases they intended to save some money as soon as possible, then return to their original homes. Very few of them indeed were willing to sell their land when they emigrated. The first money many of them were able to send home was for the purpose of rebuying the land they had to sell or releasing it from mortgage. Some of them, who are now married and established immigrants in this country, still own land in the old village. It is a bond they do not like to sever, although they know very well that they will never go back.<sup>2</sup>

Another indication of the significance of land is the manner in which the *fellah* responds to it, as if it were a living organism. In

<sup>2</sup> For an analysis of the influence of emigration upon village life, see my article, "Emigration, a Force of Social Change in an Arab Village," *Rural Sociology*, vol. 7, No. 1, March 1942.



many cases each plot he owns has a personal history that is handed down with it. It may be that an important village incident took place there, or that an ancestor had an intimate connection with the place. Consequently, one finds that proper names are often given to various plots or various sections of the village territory. Many of these names indicate the quality or behavior of the land as experienced by the *fellahin*. In the case of one small village in Lebanon, the writer was able to record over 30 such names. Here are a few examples: Mawadeh, meaning loyalty; Al-Hamra, meaning land with reddish soil; Al-Akra', meaning the bald land; Juret Muhanna, land named after Muhanna, an ancestor.

The prevailing system of land tenure among the *fellahin* of the Middle East goes back in its origin mainly to the time of the Arab conquest. Toward the middle of the seventh century the Arabs ousted the Romans and occupied the region. Cultivators of the soil who had already been there were left generally unmolested. Gradually, however, an elaborate system of land tenure developed, springing mainly from two foundations, the tribal and the religious organization of the Arab conquerors. Several hundred years later the Ottoman Turks took the rule over from the Arabs. At the same time they adopted in the main the culture of the latter, including their religion of Islam, much of their language, and the land system they had developed, into which some modification was introduced. With this brief statement of the background, we may now discuss the main categories of land and types of ownership.<sup>3</sup>

1. *Mulk*.<sup>4</sup>—This is the same as ownership in fee simple. The owner of such land is free to do with it whatever he wishes. He may plant it to any kind of crop or leave it uncultivated, erect buildings on it, and bequeath it as he sees fit. This type may be traced back to two sources. One of these was the *Mulk* that was in existence at the time of the Arab conquest. Owners of such land were left unmolested, except that they had to pay a certain tax in kind. The other source was the custom of Arab rulers, and later the Turkish Sultans, to grant land from the public domains to tribal chiefs and other local leaders, or to soldiers, in order to appease them, or in compensation for some service. Despite the strong desire of the *fellah* for this type of ownership, it covers only a small percentage of the land in the Middle East.

2. *Miri*.<sup>5</sup>—By far the greater portion of land is of this category. It is state property that has been leased out to cultivators either temporarily or in perpetuity. In the latter case, it is virtually the property

<sup>3</sup> The interested reader is referred to my article, "Land Tenure in the Middle East," *Foreign Agriculture*, U. S. Dep. Agr., August 1943.

<sup>4</sup> From the Arabic root *Malaka*, to own fully and absolutely.

<sup>5</sup> Corrupted from the Arabic word *Emiriyah*, that which belongs to the Emir or ruler.

of the farmer, as he can cultivate it as he wishes and bequeath it to his heirs. He has, however, to abide by certain conditions, the main among which are the following: (*a*) if the land is left uncultivated for 3 consecutive years, it will revert to the state; (*b*) such reversion also takes place when no heirs claim the land; (*c*) the owner cannot bequeath such property through a will. Upon death, inheritance takes place automatically, as prescribed by the Muslim law; (*d*) also the owner cannot offer it in dedication for any purpose, as explained below.

3. *Waqf*.<sup>6</sup>—By this term is designated property that has been dedicated for religious or charitable purposes. With the advent of the religion of Islam, this practice, which already had been in existence, became highly institutionalized and widely spread. In almost every village of the Middle East one comes across such dedicated property. This may be a building, an open field, an orchard or a few trees of one, offered as a perpetual gift to a church, a mosque, or a patron saint. A common one, mostly in towns, is the *Sabil*, a public fountain or drinking place. The main goal people have sought through such dedication has been the invocation of mercy from the Almighty or His saints upon their sick ones, or upon the souls of their dead. It is also good religion to dedicate for charity of various kinds. Another form is dedication for the benefit of one's heirs. It should be noted that only *Mulk* land, as described above, can be dedicated as true *Waqf*, which entails absolute and perpetual transfer of ownership. On the other hand, *Miri* land can be dedicated only as untrue *Waqf*, which involves usufruct and not ownership. True *Waqf* cannot be exchanged or sold except when replacing it is the ultimate aim of such transaction.

4. *Masha'*.<sup>7</sup>—In Lebanon, ownership of land by individual families is the rule, whereas in the rest of the region a form of communal ownership is practiced. Most probably this came about as a natural development of the original tribal organization. It is just one step, possibly the only one that could be taken, from common ownership by a nomadic tribe of grazing rights over a certain territory to communal ownership of agricultural land, when that tribe settles down. In fact, one can still observe this transition taking place in several localities within the region, where nomadism and settled agriculture meet. Under the *Masha'* system no one owns any specific plot in the village territory. Instead, each individual farmer or family owns a certain number of shares, which entitle the owner to cultivate a certain amount of land for a period varying from 1 to 5 years. At the end of such period a rotation of cultivators takes place. Usually, regular inheritance of shares takes place by dividing them among

<sup>6</sup> From the Arabic root verb *Waqafa*, to stop or to hold steady and unchanged.

<sup>7</sup> From the Arabic root verb *Sha'a*, to be shared in common.

the grown-up children. The right of a female child to such inheritance is recognized, although normally she foregoes that right in favor of her brothers. In some villages the right of inheritance is not established. Instead of that, at regular intervals the land is divided into as many shares as there are males, including infants.

At this point it is essential to dwell briefly on the apparent bias of the culture in favor of males and against females. An implied explanation for this prejudice may be found in two other cultural practices. One of these is the custom of patrilocalism, whereby a girl upon marriage goes to live with her husband's people and becomes completely identified with them. In case she should inherit land, undesirable complications for both family groups would inevitably arise. Such complications become accentuated when the girl marries into another village community. The other practice is the emphasis of the culture upon marriage. Practically every woman has a chance of getting married (remembering that polygyny, more than one wife to one husband, is permitted among the Muslims) and her economic security is attained through that of her husband's.

It was mentioned above that in the case of villages where land is owned directly by individual families in the form of specific plots, extreme fragmentation of holdings takes place. A certain farmer, for example, may own some 20 acres, divided into 10 to 15 plots and scattered in all directions from the village proper. Such a situation seems to be an inevitable result of the prevailing family organization and of the nucleated type of settlement. Family solidarity is strongly emphasized, to the extent that three generations live together, own and cultivate the land as one unit. Upon the death of the grandparents, the land is equally divided among the married and unmarried sons. None of them thinks of selling out to the others and emigrating. This process of subdivision continues generation after generation, with the size of the plots dwindling. Scattering of holdings is the outcome of all farmers living in a central place instead of on their land. The village territory is naturally divided into several sites, according to fertility and other qualities. From the beginning each family group is allowed to own a certain portion in each of these sites. Through occasional purchase and inheritance from the mother's side, scattering becomes more and more accentuated.

Finally, in connection with tenure it must be mentioned that approximately 50 percent of agricultural land is cultivated under one form of tenancy or another. This should be expected in a region where the *Miri* category, land owned by the ruler or the state, has been predominant. As mentioned above, it was the practice of rulers to offer large tracts of land to local leaders in compensation for certain services. Gradually, such leaders became absentee landlords and

left their land to be cultivated by tenants. Another source of the system has been the constant transition from nomadism to settled agriculture. Normally, as the tribe settles down, leadership of the sheikh is maintained. He assigns certain portions of the land to individual families, who contribute to him a part of the produce. Within a generation or two, he assumes the role of a feudal lord and they sink to the level of tenancy. In Iraq, for example, such a feudal sheikh may be the virtual owner of some 20 or more villages.

#### AGRICULTURE AND DIET

Perhaps more than any other occupation, it may be said of agriculture that it is a way of life. This is especially true of the Arab village in the Middle East. The strong attachment of the *fellah* to the soil and its deep significance to him have been pointed out above. He is born into the village where everybody is a farmer, and where farming of the same soil, according to the same techniques, has taken place for countless generations. His personality is developed according to a cultural pattern, the major portion of which is woven around the team of oxen, the plow, the good earth, the year's store of wheat for making bread, and scores of other agricultural items and activities. His diet is derived almost entirely from the soil he cultivates.

Space does not permit a thorough analysis of this important aspect of village life. Discussion will be limited to the main crops produced in the region and the main features of the activities involved in the production and consumption of these crops. The growing of cereals predominates in each of the five countries under consideration. Wheat comes first, followed by barley, maize, dura (grain sorghum), and rice. Some of the maize and dura and practically all the barley are used for feeding farm animals. Barley is especially fed to horses, donkeys, and mules. Possibly this is why the people have a prejudice against eating it, except in stringent years and in areas where the other cereals do not grow well. In Arabic literature and in local sayings there are several references to the lower status of barley. Wheat is especially desired for making bread, of which the adult *fellah* consumes from 1 to 2 pounds daily. He eats it morning, noon, and evening, a piece of it with every mouthful of the meal. No meal is considered complete without bread, whereas bread alone is acceptable. It is literally "the bread of life" to these people. In this connection, it should be of interest to point out the cooperative and social character of the baking activity. In many localities, instead of a family oven constructed in the courtyard, there are established village bakeries. Families take turns at using these, baking enough bread for a week or two. On such occasions the housewife is helped by several

neighbor women. As the 8 or 10 of them sit at opposite sides of a long table and pound the dough into large, round, and thin loaves, they exchange news and gossip about the village affairs. Further, it should be noted that preparing bread is almost entirely a woman's activity. In some places the activity of tending the oven is open to men.

One cereal, which is common in Palestine, Lebanon, and Syria, deserves special mention. This is *burghul*, which is made of wheat by a process of boiling, drying in the sun, removing some of the bran by sprinkling with water and rubbing with hands, then crushing at the mill into a coarse and a fine variety. As in the case of bread, most of the work involved is done cooperatively and is combined with social visiting and recreation. The coarse variety is used in cooking various usual cereal dishes, whereas the finer portion is used exclusively in preparing the well-known dish *kubbeh*. This consists basically of *burghul* and lean meat pounded together into thick paste in a large stone mortar. The paste may be eaten raw, with olive oil or *samn* (clarified butter), or it may be cooked in a number of ways.

Fruits are rather plentiful, with oranges, grapes, figs, apricots, melons, dates, and olives leading. The activities involved in the production and consumption of each one of these constitute a clearly defined culture complex. As an illustration, the olive complex, which is widely spread in Lebanon, Syria, and Palestine, will be described. The olive, a native of the Mediterranean region, is a very hardy evergreen tree, and lives to be several hundred years old. In some localities olive groves have been in existence longer than village traditions can reach. With little care, year in and year out, the olive tree gives its highly valued fruit. Pruning takes place yearly, and the cut-off branches are used for fuel or as supports for grapevines. The small, but thick, oblong leaves that drop from the tree are gathered regularly by women and used for fuel. The fruit begins to ripen in the fall. From that time until the end of January, village life becomes highly olive centered. The season is begun cooperatively, in that no one can start before the elders decide upon the time and the place of picking. This decision is announced at the church or the mosque, or by the village crier. At that time in Christian villages the priest usually goes around and blesses the produce. Picking the fruit is done mostly by beating it down with long sticks. This is exclusively a man's activity. On the other hand, only women and children gather the fallen fruit and put it in baskets or sacks. Also sorting is done by women. Each housewife then pickles enough olives to last the family the whole year. The rest of the crop is taken by the farmer to one of the three or four presses that exist in the village. Work at the press is done exclusively by men. The owner is usually paid in kind, and in the same manner he pays the few workers he employs. A

year's store of oil is put aside for family use, and the surplus is sold for cash. With enough oil and cereal to last the year round, the *fellah* feels secure.

Regarding the consumption of meat, a few distinctive practices should be noted. The most conspicuous of these is the effective taboo the Muslim religion has placed upon pork. The animal itself is repulsive to the Muslim, and he would rather go hungry than touch its meat. Under the influence of the Muslim majority, the Christians in this region have also refrained from eating pork. A similar Muslim taboo covers alcoholic beverages. It is interesting to note, however, that in this case the Christian minority has not been influenced by the Muslim rule. Another practice is that animals should be slaughtered in a specified manner, by cutting the throat and letting the blood drain out. No one would touch meat from an animal that has been killed in a different way. A further observation is that the people of Lebanon are fond of eating raw meat, especially certain cuts of it.

Dairy products are consumed mainly in the form of *leben* (fermented milk), white cheese, and *samn* (clarified butter). Milk is obtained from sheep, goats, cows, buffaloes, and camels.

Coffee is the most important beverage. The nomadic Bedouin, the *fellah*, and the city dweller relish it. For several hundred years they have used it, until it has become the core of a body of traditions. It is the symbol of hospitality and honoring a guest. Refusing it is taken as an insult or a sign of enmity.

A final point that should be observed in connection with the subject of agriculture is the amazing persistence of ancient techniques. One still encounters the Biblical team of oxen, wooden plow and yoke, and threshing board, as well as the hand sickle, the clay beehive, and the primitive chicken coop. In some places, even the threshing board is omitted, and animals are made to tread over the straw instead. Side by side with such manifestation of cultural stability, one witnesses drastic changes in some aspects of life. Practically every village has been invaded by the automobile and the radio. It is said that the former has been used by the Bedouin in his raids! In Lebanon the western type of dress is now more common than the native. It seems that we have here a vivid illustration of the fact that there is no necessary carry-over in the process of acculturation from one aspect of culture to another.

#### FAMILY ORGANIZATION

The fundamental significance of family life in the culture of the Arab village cannot be overemphasized. It is equal in this respect to land and agriculture. We have shown above that the origin of the

nucleated settlement can be traced probably to the tribal organization, which is essentially based upon blood ties. When the first boy is born to a married couple, people cease to call them by their names. Instead, they are called after the name of their son, Abu-Ahmed and Um-Ahmed, for example (i. e., the father and mother of Ahmed.) This is an indication of the emphasis of the culture upon family continuity through the new generation. Reciprocally, children and adults are constantly identified with their parents and family groups. "Whose son is he?"; "To what family does he belong?"; "From what village does he come?" are the first questions asked about a stranger. In village proverbs and sayings reference to blood ties and relations is frequent. Insulting an individual as such may be dismissed without much ado, whereas violent reaction is certain to result if the insult is directed at the individual's family. "May Allah curse your ancestors" is one of the toughest swearing expressions used. In situations of serious conflict, members of a family rally together and face the threat as one solid unit. Such and similar indices serve to show clearly how predominant is identification with the family group.

Considering the region as a whole, three types of family units can be distinguished. The first of these is the ordinary biological family, consisting primarily of the married couple and their children. This type, which prevails in the north American rural culture, is the least significant in the Arab village. Beyond fulfilling its biological function, the unit does not figure much in life's situations. It should rather be considered as a stage leading to the development of the larger and more important unit that will be described presently. It should be remarked, however, that under the impact of Western culture, especially its economic system, the biological family is beginning to play a more dominant role. This is particularly evident in the villages of the coastal area where direct contact with the West has been taking place intensively during the last 50 years.

The second and most important unit is the joint family, consisting of three generations. Taking one of the grandchildren as a point of departure, the group normally consists of brothers and sisters, first paternal cousins, married and unmarried paternal uncles, unmarried paternal aunts, and the paternal grandparents. All these, varying in number from 10 to 30 people, live close together within the same compound of dwellings. Socially and economically they function as one unit. They own the land collectively, cooperate in its cultivation, and share equally its produce. At the death of the grandfather, the family splits into as many units as there are sons, each one of whom becomes the nucleus for the development of a separate entity. Within this patrilineal and patrilocal system, the girl is considered as an integral member of the paternal group as long as she stays unmarried.

Upon marriage, she moves to the abode of her husband's people and becomes completely identified with them. In case the girl does not marry at all, which is rather exceptional, arrangements are made for her to live with one of the brothers when the original unit splits. Upon divorce, which takes place only among Muslims, the woman normally returns to live with her people.

A clear division of work between the sexes and differentiation of status-role can be observed. This differentiation is sharper within Muslim than it is within Christian families. It can be said that in general the female's status-role is subordinate to that of the male's. The following are a few indications of this tendency. As was mentioned above, parents are named after the first son, but never after their first daughter. The desire expressed by the parents and their relatives is always for a male child. "May Allah give you a son" is the usual saying. One never hears, "May Allah give you a daughter." Circumcision or baptism of a boy are occasions for village celebration, whereas a girl's baptism is observed quietly. In some localities women of the household eat only after men have finished their meal. In such places a certain degree of segregation of the sexes takes place, and women are generally kept in the background. However, no veiling of women is practiced in any of the villages, as is done among the Muslims of towns and cities. In general, it is men who make all important decisions regarding family affairs.

Regarding the division of work, two generalizations may be made—that men handle the heavier tasks, and that they take up those tasks that carry more prestige. Taking care of the children, preparing meals, getting water from the spring or well, and washing and mending clothes is done exclusively by women. They also do the lighter tasks in the fields, such as weeding, gleaning, and fruit picking. Men do very little at home. In fact, they would be looked down upon by the community, including their wives, if they should handle any of the jobs assigned to women. In the fields, they do the heavier jobs, such as plowing, pruning, harvesting, and threshing.

The influence of the joint family extends also to the marriage institution. In fact, the latter may be considered as a function of the former. A boy may know his girl well, and the two may fall in love, but the final decision in the matter rests with the families concerned. The parents, the aunts, the uncles, and the grandparents must have their say. Such an apparent "interference" or "meddling" is a logical consequence of the fact that the newly married couple will not establish an independent home, but will live with the rest of the family unit. In exceptional cases, the boy and girl may rebel against a negative decision by their families and elope. Reaction against such deviation varies from locality to locality. It may take



the form of a mild and temporary ostracism, or it may lead to the murder of the girl by an infuriated brother or father. Choice of a mate within the kinship group is preferable to marriage with an outsider. In this respect, Muslims go as far as to permit marriage between first cousins, whereas Christians make second or third cousins the limit, depending upon the sect. Having children, and the more of them the better, is the primary purpose of marriage, as far as the joint family is concerned. They constitute an economic asset on the farm, and through them the prestige of the unit is enhanced and its continuity assured. In the face of such a situation, the lot of a barren woman is miserable indeed. Divorce and polygyny do not occur in Christian communities, whereas both are practiced by the Muslims, with certain restricting conditions.

A third entity that is based on blood relationship is the kinship group. This is more comprehensive than both the biological and the joint family. It consists of all those who claim descent from the same paternal ancestor. The number of joint families that make up a kinship group varies from village to village, according to the age of the community and the occurrence of disruptive factors that may split the group at a certain stage in its development or retard its growth. Its influence is felt by the individual in a variety of situations. From the start, the child learns that he should address every member of the unit as "cousin" or "uncle" or "aunt" or "grandfather" or "grandmother." As mentioned above, it is expected of a young man to marry within rather than outside the kinship group. In times of serious conflicts or feuds within the village, kinship loyalty asserts itself and is binding upon every member.

#### RELIGIOUS ORGANIZATION

It is not a matter of coincidence that three of the five leading religions of the world originated in the region of the Middle East. A discussion of the factors that have made such a development possible is not our present task. What concerns us in this respect is the fact that man in this part of the world has always been highly religion-conscious, and that his religious traditions are well established and reach as far back as early human history. A continuous and direct line of descent can be traced from the various religions of early ancient times to Judaism, then Christianity, and more recently Islam. The earlier forms of religion have ceased to exist, excepting inasmuch as their practices have been absorbed by the three that followed them, and which are still living in the region. Of these, Judaism is the least influential. Its followers, aside from the recent Zionist settlements in Palestine, are limited to small communities of a few thousands each in the cities of Beirut, Damascus, Bagh-

dad, and Aleppo. There are no Jewish village communities. By the end of the Roman rule in the Middle East, Christianity had become the predominant religion, spreading widely among city and village people. Toward the middle of the seventh century, conquest of the territory by the Arabs took place, and their religion of Islam prevailed. Many Christian communities embraced the new religion, and new Muslim settlements increased. At present, except in the predominantly Christian Lebanon, Christian villages constitute a small minority in the various countries of the Middle East.

In the light of this background, a description of the religious organization of the village community will now be attempted. The first distinctive feature to be noted is that religion, like agriculture, is a way of life in this part of the world. It is so old and so deep-rooted an institution that it has permeated all aspects of community life and become inseparable from them. A visit to one of the old Christian monasteries on the Lebanon heights is sufficient to give one the impression of a religion that does not lend itself readily to the forces of change. It must also be remembered that the central core or primary motive in the Arab wave of conquest was their religious message—a call to all peoples to embrace Islam, the religion of surrender unto Allah. Through such surrender, the various aspects of life took shape and color. Consequently, in the village community of today everybody is born into its church (Muslim or Christian) and is expected to remain in it for the rest of his life. He may not know much about its dogmas or subscribe to their letter, but he conforms loyally to the community folkways and mores which have been inspired mainly by the rules of the church. Every seventh day of the week (Friday for the Muslims) and during the many religious festivals of the year, village people stop work and indulge in social visiting and other recreational activities. Recently in Palestine important religious festivals have been successfully transformed into occasions for political demonstration. The *Haj* (pilgrimage to Mecca) is a dominating factor in the life of the *fellaḥ*. He may never be able to accomplish such a religious trip, but he is always planning for it. When he succeeds, his departure and his return are occasions for celebration by the whole community. And when the elements of nature fail him and his crops are threatened with ruin, he turns to the village church as a final resort. It has prayers to bring down rain, to bless the produce, and to ward off the evil eye. Never would a *fellaḥ* talk about his children, livestock, land, or produce without uttering at frequent intervals the name of Allah in a variety of phrases. No marriage is considered possible unless it is sanctioned by the regular religious ceremony. Circumcision and baptism, two

religious rituals, are occasions for social and other recreational activities. One could go on citing scores of other examples showing the far-reaching integration of religion with agriculture, family, recreation, and other aspects of village culture.

Stability is a second prominent feature of the village church. This may be seen as a natural consequence of the first feature just analyzed. When religion permeates community life to such an extent as described above, change must perforce be extremely slow. Another explanation may be found in the intensity of emotional experience that goes with various religious practices in the village. Being a product of the culture under consideration, the writer knows from personal experience the force of the emotional factor. He was also able to see it in operation in his study of one of the Arab communities established in this country.<sup>8</sup> A convincing manifestation of this stability has been shown in the extreme reluctance of the village people to yield to conversion. Muslims and Christians, whether living in the same village or in separate villages, have settled down, in the course of 1,300 years, to an implicit understanding that those who are born Muslim shall remain Muslim, and those who are born Christian shall continue to be so. The idea of proselyting is alien to their minds. The same attitude has been shown toward the energetic attempt at conversion by Western missionaries during the last hundred years. It is a well-known fact that not more than 10 to 20 Muslims in the whole region have been converted.

A third feature is the high degree of autonomy enjoyed by the village church. This is another indication of its identification with the life of the community, rather than with an outside hierarchy. Islam, in fact, does not have much of an ecclesiastical organization, and the Muslim village church is very much of a local affair. The people choose their *Imam* or sheikh, who leads them in prayer and performs for them certain ceremonies. He is paid a certain unassigned wage, mostly in kind. The Christian priest is similarly chosen and paid. He is one of the villagers, well known to them, and they expect him to be their priest all his life. There is no question of his being called somewhere else. In addition, he owns land as they do, and does some farming. After being ordained by the bishop, he is left very much on his own with his congregation. One condition with which he must conform is that he should get married before he is ordained; otherwise he will have to remain celibate. Most of the village priests are married, which is preferred by the community. On the other hand, celibacy is required in all other statuses of the hierarchy, from the monk to the patriarch; but this hierarchy has very little to do with village

---

<sup>8</sup> See the writer's article, "Acculturation of an Arab-Syrian Community in the Deep South," *Amer. Sociol. Rev.*, vol. 8, No. 3, June 1943.

life. In ceremonies, festivals, intervillage relations and legal affairs, the local church is named after, and identified with, its own village community.

#### THE COMMUNITY

So far we have shown how land, agriculture, family, and church weave a pattern of life for the Arab *fellah*. To complete the description of the pattern, one more element should be discussed. This is community life as a whole, which is dependent upon the other elements, yet goes beyond them. Short of the association and emotional experience afforded by the totality of the community, the *fellah's* life is incomplete. The village is, more or less, his self-sufficient world. Under the discussion of its physical structure above, we emphasized its nucleated nature and indicated how clearly it can be identified. This clarity of the physical boundaries is a true reflection of a complete form of association within, of which the individual is part, as much as he is part of his family, church, and agricultural occupation.

The *fellah* is always conscious of the fact that he is a member of a certain community, and he knows wherever he goes people expect him to identify himself as such. A stranger is always "placed" with respect to his village, family, and church. The influence of the community extends also to agriculture. This is obvious in the case where communal ownership of the land prevails, as discussed above. Even where land is privately owned, rotation of crops, grazing grounds, dates of harvesting, and appointment of crop guards are all fixed by the village as a whole. Marriage within the settlement is preferable to marriage with an outsider; and individuals usually conform. We have indicated above how the local church is identified primarily with the community, rather than with the mother church. In intervillage competition or conflict loyalty to the local community asserts itself in an unmistakable manner and is expected from every individual. Practically every village has developed a sort of a reputation, a general character, by which it is well known in the surrounding area. This may be the prowess of its youth, its learning, the industry of its farmers, its loose morals, etc.

Local leadership and government also reflect the authority and interests of the community. Leaders develop gradually and spontaneously, by measuring up to certain esteemed qualifications. These are, ideally, land ownership, old age, good family background, generosity, good moral character, and intelligence, which they express as "wisdom." Naturally, very few individuals ever attain all of these points, and a compromise has to be made. Usually, there is a formally organized or informal village council consisting of leaders from the various kinship groups. This representative body settles disputes between individuals and decides upon various village affairs. In some

localities, under the influence of the central government municipalities have been established, members of which are elected by the people.

Under the tremendous impact of Western culture, as is now being brought about by the exigencies of the present global war, one wonders how this village-world of the Middle East will fare. Will it succeed in absorbing the shock and maintain its stability, as it did in the days of the Greeks, the Romans, the Arabs, and the Turks? Will the present forces of change—the tractor, the automobile, the radio, the gun, and Western ideologies—prove too much for it to control and force it to be uprooted with the rest of humanity? Or will there be a chance of selective acculturation under the guidance of an intelligent world organization?



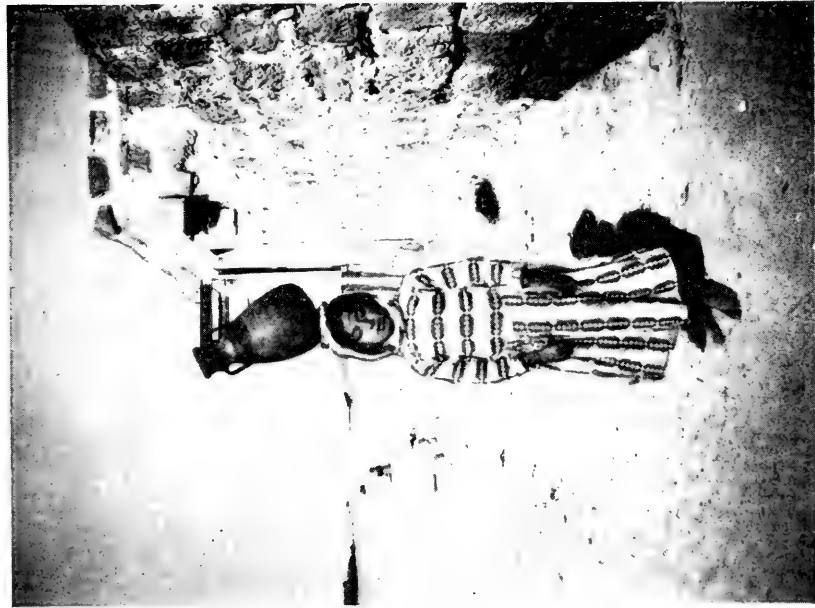

CARRYING A JAR OF WATER FROM THE SPRING IN A VILLAGE OF CENTRAL PALESTINE.  
Such activity is assigned to women in the Middle East.



1. THE VILAGE WELL OF BISHMIZZEEN, NORTH LEBANON.

Water is hauled by means of a kerosene can and a rope.



2. IN SOME VILLAGES THE PEOPLE DEPEND UPON WATER FROM A RUNNING STREAM FOR WASHING AND DRINKING.





THE ANCIENT WATERWHEEL OF THE ORONTIS RIVER VALLEY IN  
NORTHERN SYRIA.

The river current turns the wheel and lifts the water to a suitable height, whence it is conducted for irrigation purposes.



1. TYPICAL HOUSE IN THE BIKA' PLAIN, LEBANON.

Note the heap of dung cakes which are used for fuel.

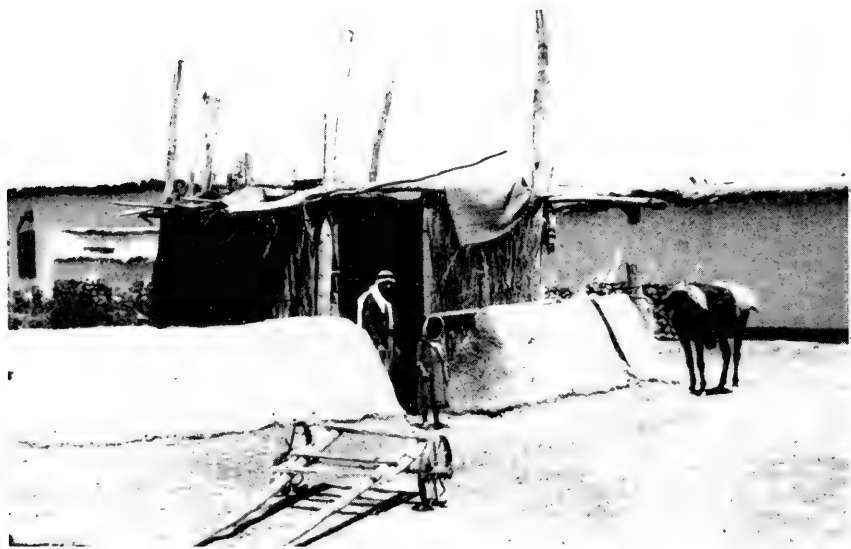

2. A REED-CANE DWELLING FOR SUMMER USE.



1. THE NUCLEATED STRUCTURE OF A VILLAGE IN CENTRAL SYRIA.



2. THE SAHA, WHERE MARKETS ARE HELD, IN A VILLAGE OF SOUTHERN PALESTINE.



1.



2.

THE COURTYARDS OF VILLAGE HOUSES IN SOUTHERN PALESTINE (1)  
AND IN THE INTERIOR OF LEBANON (2).



1. A STONE HOUSE IN THE VILLAGE OF BISHMIZZEEN, TYPICAL OF THE MOUNTAINOUS SECTION OF LEBANON AND NORTHERN PALESTINE.



2. GENERAL VIEW OF A "BEEHIVE" VILLAGE IN THE ALLOUITE REGION, NORTH SYRIA.



1. BAKING BREAD ON THE SAJ (THE HEATED IRON PLATE IN THE CENTER) IN THE INTERIOR OF LEBANON.

Note the thin loaves.



2. BAKING BREAD IN THE VILLAGE BAKERY IS A HIGHLY COOPERATIVE AND SOCIAL ACTIVITY.

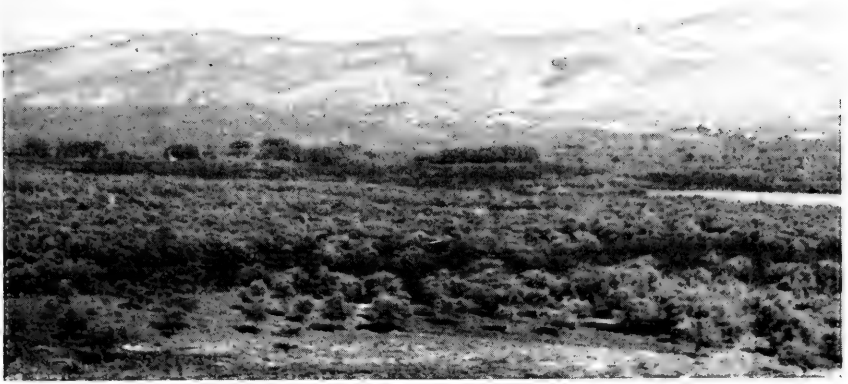

1. GENERAL VIEW OF OLIVE ORCHARDS IN THE KURA VALLEY, LEBANON.



2. ELABORATE TERRACING IS MAINTAINED IN ORDER TO PREVENT EXCESSIVE EROSION ON THE MOUNTAINSIDES.



1. A TEAM OF OXEN IS THE MAINSTAY OF A LEBANON FARM.  
The farmer holds the goad in one hand and directs the plow with the other.



2. THE ANCIENT THRESHING BOARD IS STILL IN USE.  
The under surface is studded with hard stones.





1. FREQUENTLY THE COOP IS PERCHED IN A TREE, AND THE CHICKENS LEARN HOW TO CLIMB TO IT.

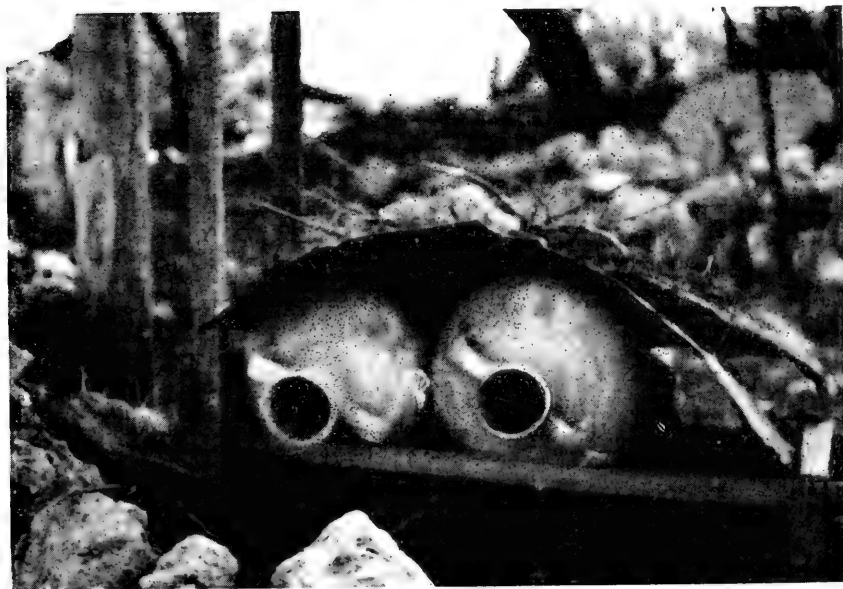

2. AN EARTHENWARE JAR SERVING FOR A BEEHIVE IS ANOTHER OLD AGRICULTURAL PRACTICE.

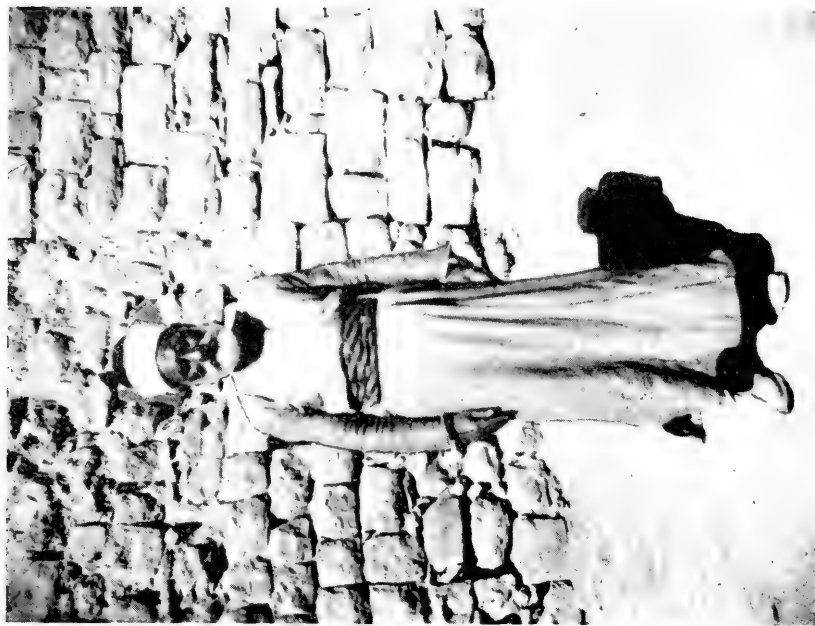

2. A TYPICAL VILLAGE ELDER IN NORTHERN PALESTINE.



1. A TYPICAL VILLAGE ELDER IN SOUTHERN PALESTINE.



1. THE COUNCIL OF ELDERS MEETING WITH GOVERNMENT OFFICIALS IN A DRUZE VILLAGE.



2. ARAB COFFEE AND HOSPITALITY ARE SYNONYMOUS.  
Note the mortar in which the roasted beans are pounded.



1. THE AMERICAN AUTOMOBILE HAS INVADDED THE OUTLYING ARAB VILLAGE, BRINGING ABOUT FAR-REACHING CHANGES IN ITS WAY OF LIFE.



2. THE RETURNING EMIGRANT HAS BEEN ANOTHER FORCE OF SOCIAL CHANGE IN VILLAGE CULTURE.

He brings back new ideas, a higher standard of living, and a new outlook on life.

# CHEMOTHERAPEUTIC AGENTS FROM MICROBES

---

By ROBERT L. WEINTRAUB  
*Division of Radiation and Organisms*  
*Smithsonian Institution*

---

[With 5 plates]

## RETROSPECT

The treatment of disease with chemical agents is as old as the practice of medicine itself. Since the beginnings of the healing art, there has been a constant effort to discover specific remedies for the maladies that beset the human organism. During the dawn of our present scientific era, hopes of success in this direction were voiced by some of the outstanding workers, such as Paracelsus in the sixteenth century and Boyle in the seventeenth, but the search for chemical specifics was of necessity conducted in an entirely empirical manner. Until the twentieth century only three valuable specific remedies for infectious diseases had been found: cinchona bark (containing quinine) for malaria, ipecac (containing emetine) for amebic dysentery, and mercury for syphilis.

The firm establishment of the germ theory of disease, due largely to Pasteur during the latter half of the nineteenth century, created a rational basis for the development of chemotherapy. Today various connotations have become associated with this term. To the earlier workers it meant the internal disinfection of the body by chemicals which would destroy the pathogenic parasites without harming the host—in the words of Paul Ehrlich, the father of chemotherapy: “by magic bullets which strike only those objects for whose destruction they have been produced.”

The recognition of the powerful bactericidal action of a number of chemicals, such as carbolic acid and bichloride of mercury, stimulated expectations of the early accomplishment of inner disinfection. Despite a great deal of labor, however, this goal was not achieved; the disinfectants which appeared so promising in test-tube experiments were found to be either ineffective *in vivo* or too toxic toward the body. It was not until 1910, with the introduction of salvarsan, or “606,” developed after years of painstaking work by Ehrlich, that

successful chemotherapy by a synthetic compound could be regarded as accomplished. Hopes were again raised that, having reached this milestone, further progress would be rapid, but once again the expectation proved futile. In the ensuing quarter of a century only a handful of useful chemotherapeutic agents were developed and all these, like quinine and salvarsan, were limited to the treatment of protozoal diseases. All experience indicated that the ordinary pathogenic bacteria could not be attacked by chemotherapy.

Then in 1935 announcement was made of the curative effects on bacterial infections in mice by the dye prontosil. It was soon shown that the action of this compound is due entirely to a small portion of the molecule, sulfanilamide. From this parent substance have been derived all the sulfonamide compounds so widely used in recent years. In a period of half a dozen years approximately three thousand derivatives and related compounds have been tested; four of these—sulfapyridine, sulfaguanidine, sulfathiazole, and sulfadiazine—have been outstanding. The introduction of these drugs has revolutionized many phases of medicine. Dozens of infectious diseases have responded to sulfonamide therapy, and the prospects for cases of septicemia, pneumonia, scarlet fever, and meningitis, to mention only a few, have been dramatically improved. Without doubt hundreds of thousands of lives have already been saved by the sulfonamides.

These drugs are not, however, without their disadvantages. In many patients they produce symptoms of great discomfort and may even cause severe toxic effects and tissue damage. Further, it has been discovered that some strains of pneumococci and other bacteria are resistant to the action of the sulfonamides, so that a considerable percentage of infections by these bacteria is not amenable to the treatment. Even in the case of susceptible organisms, there are other limitations on the usefulness of the sulfonamide compounds. Their antibacterial activity is greatly diminished in the presence of large numbers of bacterial cells, even of dead bacteria, and also by the presence of pus, blood serum, and various products of tissue destruction, all of which are very likely to be found in infected wounds.

While progress in the sulfonamide field still continues and further valuable discoveries may well be anticipated, the successes here have served to stimulate rather than to deter investigation of other, unrelated, chemotherapeutic agents. A powerful impetus to these studies has been furnished by the present war with its greatly increased demand for better antiseptics.

Within the past few years, considerable attention has been given to a number of substances which are the metabolic products of various

micro-organisms. As yet, the study of none of these has reached the final stage, but already very promising preliminary results have been obtained. As is true of most scientific advances, the ultimate flowering of this field has been preceded by a long preparatory period of scattered observations whose practical implications were unrecognized or ignored. During the past three-quarters of a century numerous examples of antagonistic relationships between various micro-organisms have been noted. In many instances the inhibitory effects have been shown to be due to the production of toxic materials. In the following account an attempt will be made to sketch the development and present status of knowledge of the more potent antibacterial substances which have been obtained from bacteria and fungi.

#### AGENTS FROM *PSEUDOMONAS AERUGINOSA*

In 1877 Pasteur reported that the injection of anthrax bacilli into susceptible animals frequently failed to elicit the disease when the inoculum was contaminated with "common bacteria" and suggested that this observation could "perhaps justify great hopes from a therapeutic point of view." A dozen years later two other French bacteriologists, working independently, announced that by injecting cultures of *Pseudomonas aeruginosa*, the so-called bacillus of blue pus, into rabbits infected with anthrax, an appreciable number of the animals was prevented from dying of this disease.

*Pyocyanase*.—This discovery aroused a great deal of interest and it was soon shown, first, that a sterilized culture of *Pseudomonas* could be employed in place of the living bacteria, and then that an active material could be obtained from the culture fluid itself after removal of the cells. Minute amounts of this product, originally believed to be an enzyme and designated "pyocyanase" after the old name (*Pseudomonas pyocyanea*) of the organism, were capable of causing the dissolution, or lysis, of billions of cells of staphylococci, pyogenic streptococci, the bacilli of diphtheria, plague, typhoid, and anthrax, and the cholera vibrio.

During the early years of the present century, pyocyanase was employed therapeutically to a considerable extent and was produced on a commercial scale in Germany. Favorable results were reported in the treatment of a large number of diseases, including anthrax, diphtheria, cerebrospinal meningitis, infectious catarrh, wounds and abscesses, as well as many infections of the eyes, mouth, and skin. In general the surface infections were treated with greater success than those of more deep-seated occurrence. Later, however, there began to accumulate a number of reports of negative and inconsistent results, and interest in the therapeutic use of pyocyanase waned.

Studies of the physical and chemical properties of the substance also resulted in lack of agreement.

The reasons for most of the observed discrepancies are now apparent. In recent years it has been demonstrated that several antibacterial substances, which differ in their mode and specificity of action, are produced by *Pseudomonas aeruginosa*. Furthermore, different strains of this organism do not behave alike in their elaboration of the various compounds and, moreover, for a given strain the production of each of the active agents is influenced by a number of environmental factors. The methods of extraction also are of importance in determining the composition of the antibacterial preparations.

*Pyocyanic acid*.—In 1908 it was found that the bactericidal activity of pyocyanase, as well as of *Pseudomonas aeruginosa* cultures, could be extracted by various organic solvents. That pyocyanase really was an enzyme had already been questioned by a number of investigators and this new finding was interpreted as evidence that the active agent was a fatlike substance. The extracts were demonstrated to possess the ability to dissolve, or lyse, red blood cells, as well as bacteria. Several investigators attempted to identify the active compound. In 1933 an active substance which appeared to be a fatty acid was isolated and named "pyocyanic acid." This compound has not yet been identified and its precise chemical structure is unknown. It is quite potent against certain bacteria; complete inhibition of the growth of the cholera vibrio is produced by 0.001 percent, of the anthrax bacillus by 0.005 percent, of staphylococci by 0.02 percent. Somewhat higher concentrations cause lysis. Pyocyanic acid is a surface-active compound, that is, in aqueous solutions it has the property of accumulating at the interface between phases, such as at the water-air boundary, and of reducing the surface tension of the water. This property, which is characteristic of detergents or cleaning agents such as soap, seems to be of importance in its bacteriolytic action, inasmuch as a number of other detergents have been found to produce similar biological effects.

The purest preparations of pyocyanic acid thus far tested have been found to be moderately toxic to mice. No attempt has yet been made to use the substance therapeutically.

*Pyocyanine*.—One of the most obvious characteristics of *Pseudomonas aeruginosa* is the production of a water-soluble blue pigment. As early as 1860 this pigment had been isolated from blue pus and given the name "pyocyanine." Not until 1929, however, was its chemical nature elucidated and its synthesis accomplished in the laboratory; it was the first natural product demonstrated to belong to a class of organic substances known as phenazonium compounds. There is



considerable evidence that the pigment may play a role in the metabolic activities of the bacterial cell.

In 1932 it was shown that pyocyanine is fairly strongly bactericidal. In 6 hours the causal organisms of anthrax and diphtheria are killed by 0.025 percent; numerous other species are also susceptible, although to a lesser degree. The pigment is about twice as toxic for mice as is pyocyanic acid. Promising results have been obtained in preliminary trials in which the noses of diphtheria carriers were sprayed with pyocyanine solution.

*α-Hydroxyphenazine.*—In addition to pyocyanine, *Pseudomonas aeruginosa* produces a number of pigments which have been less thoroughly studied. One of these, a decomposition product of pyocyanine known as *α*-hydroxyphenazine, was shown in 1935 to be bactericidal toward a large variety of organisms. This compound is not very stable, so that its activity rapidly decreases with time; in tests of short duration, however, it has proved to be highly potent. The growth of the cholera vibrio, for example, is completely inhibited by a concentration of 0.00013 percent. The pus-forming streptococci and the pneumonia bacterium are about one-half as sensitive. The toxicity to mice is less than one-fifth that of pyocyanine. Therapeutic trials have not yet been reported.

The increased knowledge of the multiplicity of antibacterial agents produced by *Pseudomonas aeruginosa* sheds considerable light on the contradictory experiences of the older workers with pyocyanase. It is now clear that different preparations contained these components in varying extent. Pyocyanine was doubtless present in many of them. In view of the many favorable results obtained with the old unstandardized preparations, a reexamination of the possible applications of the pure components seems desirable. Against staphylococci, streptococci, the organisms of typhoid and paratyphoid fevers, as well as other micro-organisms, pyocyanine and *α*-hydroxyphenazine, have a much greater growth-inhibiting, or bacteriostatic, potency than the sulfonamide drugs. The action against several pathogenic fungi also compares favorably with that of the common disinfectants. Owing to the toxicity of the *Pseudomonas* agents their potential usefulness would appear to be limited to surface or localized infections. The high potency against fungi which are responsible for such infections suggests a possible therapeutic application.

#### AGENTS FROM BACILLUS BREVIS

The remarkable diversity of the chemical transformations brought about by the varied bacterial population of the soil led Dubos, at the Rockefeller Institute for Medical Research, to attempt to isolate

therefrom an organism capable of attacking Gram-positive cocci.<sup>1</sup> The technic adopted was to add, from time to time, suspensions of living streptococci and staphylococci to soil in the hope of provoking the development of a microbial flora able to utilize these cells. In 1939, after a period of 2 years, he was able to announce the success of the experiment. There was isolated from the soil a bacterium, identified as *Bacillus brevis*, which brought about the lysis of living staphylococci, streptococci, and pneumococci. A short time later Hoogerheide, who had been working independently at the Franklin Institute, also reported the isolation of several strains of soil bacilli which produced antibacterial substances. Other species, endowed with the same type of antagonistic activity, have been obtained also from sewage and from cheese.

*Tyrothricin, gramicidin, and tyrocidine.*—It was soon found that the lytic properties were exhibited not only by the living *Bacillus brevis*, but also by cell-free solutions obtained from old cultures in which self-digestion, or autolysis, of the bacteria had taken place. From such solutions there have been obtained several active fractions which differ in chemical composition and in biological properties. Apparently these various substances are derived, through the processes of autolysis and the subsequent manipulations of extraction, from a single parent substance originally present in the bacterial cell. On acidification of the culture fluid there is obtained a protein precipitate from which a protein-free active substance can be extracted with alcohol and precipitated with salt solution. The material obtained in this manner has been designated "tyrothricin" after *Tyrothrix*, the old generic name of a group of bacteria early recognized as having antagonistic properties. About half a gram of tyrothricin can be prepared from a liter of bacterial culture. Tyrothricin has been further separated into two active components, named "gramicidin" and "tyrocidine," which account for approximately 20 and 50 percent, respectively, of the parent material.

Both gramicidin and tyrocidine have been isolated in pure crystalline state and considerable information concerning their chemical properties has been obtained. Both compounds are complex poly-

<sup>1</sup>In the staining technic devised by the Danish bacteriologist Gram, the bacteria are treated successively with a dye, such as gentian violet, with iodine, and with alcohol. Those which are decolorized by the alcohol are termed Gram-negative, whereas those which retain the dye are Gram-positive. Although the Gram stain was introduced as a purely empirical procedure, it has been found to differentiate bacterial species into two fairly sharply defined groups which differ also in numerous structural and physiological characteristics. The reason for the difference in staining properties is not entirely clear but presumably is related to the properties of the cell wall.

Of the common disease-producing cocci, the streptococci, staphylococci, and pneumococci are Gram-positive, whereas the gonococci and meningococci are Gram-negative. Among the Gram-positive bacilli are the causal organisms of diphtheria, gas gangrene, tetanus, tuberculosis, leprosy, and anthrax; Gram-negative bacilli include the agents of typhoid and paratyphoid fevers, bacillary dysentery, bubonic plague, and undulant fever.

peptides constructed in a fashion somewhat similar to the common proteins but differing from these in a number of important details. The precise empirical formulas are not yet known; gramicidin appears to be approximately  $C_{74}H_{105}N_{15}O_{13}$ , while tyrocidine may be  $C_{126}H_{166}N_{26}O_{26}$  or possibly a unit one-half this size.

Although both gramicidin and tyrocidine possess antibacterial activity, and despite their chemical similarity, their biological properties are quite different. The action of gramicidin is primarily bacteriostatic; the great majority of Gram-positive species tested are highly susceptible, whereas the Gram-negative bacilli are entirely insensitive. Tyrocidine, on the contrary, exerts a marked bactericidal effect upon both Gram-negative and Gram-positive organisms.

Tyrocidine causes the lysis of a number of bacterial species, whereas gramicidin has no such effect. It appears likely, however, that the dissolution is not a direct result of the action of tyrocidine but rather is a secondary self-digestion brought about by the bacterial enzymes after the cells have been killed by the bactericidal agent. Gramicidin, on the other hand, does not occasion the lysis of even the most susceptible bacteria.

Both agents cause the dissolution of red blood cells, but the mechanism of the action is quite different for the two substances. The hemolytic effect of gramicidin becomes apparent only after several hours, although it may be elicited by very small amounts of the agent. The action is completely inhibited by the presence of glucose or certain other carbohydrates. Tyrocidine, contrariwise, produces immediate hemolysis irrespective of the presence of glucose; its action, however, is inhibited by blood serum to a much greater degree than is that of gramicidin. The hemolytic activity of gramicidin and tyrocidine seems to be influenced by factors which are not yet entirely appreciated, as conflicting results have been obtained by different workers.

The mechanism of the action of gramicidin and tyrocidine on cells has been studied to a greater extent than that of most of the other natural antimicrobial substances. Tyrocidine acts much like a general protoplasmic poison. It induces an immediate and irreversible cessation of metabolic activity which, in many cases, is followed by cellular disintegration. Its action in these respects resembles closely that of certain detergents, as do also its behavior as a protein precipitant and its surface activity.

While gramicidin has many of the physical and biological properties of detergents, there is considerable evidence that its antibacterial activity is not due to these characteristics alone, although its tendency to concentrate at the bacterial surface well might enhance the action due to other properties. The effects produced by gramicidin are

greatly influenced by the composition of the medium. In the presence of glucose (or some other substrates), phosphate, and potassium, low concentrations of gramicidin markedly stimulate the respiration of various cells. Small amounts of certain substances, e. g., the ammonium ion, prevent this stimulatory effect. Higher concentrations of gramicidin may cause complete inhibition of respiration. It is known that the cellular oxidation of carbohydrate is brought about by means of certain phosphoric acid compounds. Recently there has been procured evidence that the formation of one of these compounds, adenosine triphosphoric acid, may be inhibited by gramicidin. This agent thus does not behave as a gross protoplasmic poison but appears to exert its bacteriostatic effect through an interference with the energy-supplying processes of the cell.

The antibacterial activity of both gramicidin and tyrocidine is reduced by serum and tissue extracts. Tyrocidine is inhibited also by proteins and peptones. Of a large number of pure substances which have been tested, only a few, belonging to the class of phospholipides, have been found to possess the ability of diminishing the gramicidin potency. A gramicidin-neutralizing fraction rich in phospholipides can also be obtained from Gram-negative bacilli; whether this material plays a role in the nonsusceptibility of Gram-negative organisms to gramicidin has not yet been established.

Both gramicidin and tyrocidine are quite toxic when administered intravenously or intraperitoneally. This, together with the lowered effectiveness in the presence of various biological substances, would appear to preclude the therapeutic application in systemic infections. For the treatment of many types of localized infections the prospects are much brighter. A considerable number of clinical trials with very favorable results have already been reported. In vivo, gramicidin is a much more active agent than tyrocidine. In practice the mixture of the two—tyrothricin—has been used much more extensively than gramicidin itself, inasmuch as it appears to possess some advantages, as well as being much more easily produced. Tyrothricin is now commercially available.

Among the diseases which have shown favorable response to tyrothricin therapy are inflammations of the nose and sinuses, bladder infections, empyema due to streptococci, postoperative wounds, and burns. Skin ulcers which had persisted for years, despite various forms of treatment, have healed after a few weeks, or even days, of tyrothricin therapy. In general, streptococcal infections are more amenable than those due to staphylococci or pneumococci. Good results have been obtained also in the treatment of bovine mastitis, a streptococcal infection of the cow's udder.

The application of tyrothricin after surgical operations on the nose, sinuses, and mastoid has been reported to prevent postoperative infections and so to reduce fever, swelling, and pain in a number of instances. There is some indication also that the process of wound healing may be stimulated by this agent.

On the other hand, it must be pointed out that among even the susceptible species of bacteria there may exist, or be developed during the course of treatment, strains which are very resistant to the action of tyrothricin. Treatment with this material may occasionally fail also in the presence of a mixed bacterial infection, inasmuch as certain Gram-negative bacteria appear to counteract the activity against susceptible Gram-positive forms. A further point of importance is that the infected area must be accessible to local treatment.

Obviously, gramicidin (tyrothricin) is not a cure-all but, with due regard for its limitations, it would appear to furnish a valuable addition to the medical armamentarium.

#### AGENTS FROM BACILLUS MESPENTERICUS

Another spore-bearing bacillus which has long been recognized as having antagonistic properties is *Bacillus mesentericus*, the so-called potato bacillus. In 1904 it was shown that the antibacterial principle occurs in the culture medium and can diffuse through a collodion membrane. In 1939 the active agent was identified as a mixture of isovaleric and oleic acids, both of which are well-known chemical compounds found in biological materials. Oleic acid, which is especially widespread among plants and animals, is the more potent of the two and also possesses hemolytic properties. The agents are especially active against diphtheria and pseudodiphtheria bacilli, although other bacteria are inhibited by higher concentrations.

#### OTHER AGENTS OF BACTERIAL ORIGIN

A great many instances of bacterial antagonism have been described and the indications are that a considerable proportion of these is due to the production of specific inhibitory substances. The information available is so fragmentary, however, that a detailed discussion of these agents would not appear to be justified in the present account. Some of the bacterial species from which cell-free antimicrobial preparations have been obtained are: *Pseudomonas fluorescens*, *Pseudomonas putida*, *Pseudomonas phosphorescens*, *Proteus vulgaris*, *Serratia marcescens*, *Staphylococcus aureus*, *Staphylococcus albus*, *Klebsiella pneumoniae*, *Vibrio comma*, *Bacillus adhaerens*, *Bacillus anthracis*, *Bacillus mycoides*, *Bacillus subtilis*, *Bacillus simplex*, *Bacillus cereus*, *Escherichia coli*, and *Mycobacterium tuberculosis*.

## AGENTS FROM ACTINOMYCETES

The actinomycetes comprise a large group of organisms somewhat intermediate between the true bacteria and the higher fungi. They are very widespread in nature, occurring in soils, composts, and water basins; the group includes also several species which cause diseases in plants and animals.

In 1890 an Italian worker observed that certain actinomycetes were able to destroy the cell membranes of many bacteria and fungi. In the ensuing third of a century no further study of this phenomenon appears to have been undertaken. During the past two decades, however, investigations in a number of laboratories have provided evidence that several antimicrobial substances are elaborated by actinomycetes and that antagonistic properties are widely distributed among various strains of this group of organisms. To date only a few of these active substances have been studied to any extent.

*Actinomycetin.*—In 1924 two French workers who had been studying the lysis of killed staphylococci sought to isolate, from air or water, micro-organisms which could bring about this process. They succeeded in obtaining an actinomycete which was capable of causing the disintegration of a large number of microbial species.

The production of the disintegrating agent, or lysin, occurs in any medium which permits the growth of the actinomycete and commences at the time of spore formation; prior to this stage no activity can be demonstrated in either the culture medium or the cells of the organism. Preparations of the active principle, which has been designated "actinomycetin," are protein in nature; however, as they are further purified, the ratio of protein content to activity decreases.

As previously noted the living actinomycete is capable of lysing a great variety of living bacteria and molds. With the exception of a few strains of *Streptococcus pyogenes*, *Staphylococcus aureus*, and *Klebsiella pneumoniae*, the micro-organisms are resistant to the cell-free filtrate of the actinomycete, however. But if the bacteria are first killed, by whatever means, they become susceptible to the sterile actinomycete culture filtrate. Actinomycetin preparations which have been concentrated to the extent of a hundredfold increase in potency exhibit the same type of action and specificity as the crude culture filtrate. It thus appears that at least two principles are involved: a lytic factor which can act only upon dead micro-organisms and a bactericidal factor which exists in the culture medium in a relatively inactive form, albeit sufficiently active to kill the few susceptible strains enumerated.

Support for this view has been contributed by the recent discovery that on extraction of purified actinomycetin with ether there is obtained a fraction bactericidal to a number of Gram-positive bacteria.

The role of the actinomycete cells is visualized as that of freeing the bactericidal agent from its hypothetical inactive complex. Evidence for the tendency of the bactericidal substance to form such complexes is considered to be furnished by the finding that the bactericidal potency is much less in complex media than in solutions of inorganic salts.

While information on the chemical nature of the active agent is still very fragmentary, it is thought by some workers to be a fatty acid. This is very suggestive of a parallel with the agents of *Bacillus mesentericus* and of the pyocyanic acid of *Pseudomonas aeruginosa*. At least one pigment with antibacterial activity has also been isolated from another species of actinomycete, although most of the pigments produced by this group of organisms do not appear to have such activity.

No direct therapeutic use of actinomycetin has been made; it has been found, however, that the actinomycete-produced lysates of a number of pathogenic bacteria are very good antigens and much less toxic than the organisms themselves. Favorable results in a number of cases of various infections in man have been claimed through the use of such lysates.

*Actinomycins A and B.*—From cultures of another actinomycete, *Actinomyces antibioticus*, there has been obtained a strongly antibacterial preparation which was termed "actinomycin." Subsequently this material was separated into two components, both of which exhibited activity. These have been designated "actinomycin A" and "actinomycin B." Both substances have been obtained in crystalline form.

Actinomycin A, which is a bright red pigment, has been studied chemically to some extent. Its structure is not yet known but it appears to be a polycyclic nitrogen compound; possible formulas are  $C_{41}H_{56}N_8O_{11}$  and  $C_{37}H_{50}N_7O_{10}$ . The compound has a high degree of antibacterial activity which, for a given organism, may be bacteriostatic or bactericidal, depending upon the concentration and time of action. Gram-positive organisms are considerably more susceptible than the Gram-negative forms. Among the susceptible bacteria are streptococci and staphylococci, which are inhibited completely by concentrations of 0.00001 percent; the gas gangrene bacillus, inhibited by 0.0001 percent; and the tubercle bacillus, inhibited by 0.001 percent. The mechanism of the killing effect by higher concentrations appears to be a chemical interaction similar to that of the common antiseptics.

Unfortunately actinomycin A is exceedingly toxic, so that its internal administration is precluded. Whether it would be useful in surface application remains to be determined.

Actinomycin B has been studied to only a limited extent. No information as to its chemical nature is yet available. Some difficulties

have been encountered in obtaining preparations of uniform antibacterial activity; the substance apparently has comparatively little bacteriostatic activity but is more highly bactericidal than the A component.

*Streptothricin*.—This antibacterial agent, which is produced by *Actinomyces lavendulae*, has the properties of an organic base; up to the present it has not been prepared in pure condition. In the culture fluid it seems to be associated with protein. The crude streptothricin is strongly bacteriostatic toward a considerable variety of Gram-positive and Gram-negative organisms. For example, *Brucella abortus*, the etiological agent of undulant fever, is inhibited completely by 0.001 percent; 0.003 percent is inhibitory for the causal organisms of paratyphoid fever, of hog cholera, and of infectious abortion in mares. In higher concentrations streptothricin is also bactericidal.

It has been reported that in guinea pigs experimentally infected with *Brucella abortus*, the pathogens can be eliminated or reduced in number by administration of streptothricin.

*Proactinomycin*.—This name has been given to an antibacterial substance extracted from cultures of a species of *Proactinomyces*. Like streptothricin, it seems to be an organic base. Its action is primarily bacteriostatic. The growth of the pneumococcus is inhibited by 0.00007 percent; 0.0002 percent inhibits streptococci, staphylococci, meningococci, and anthrax bacilli. Proactinomycin is moderately toxic to mice. White blood corpuscles are unaffected by concentrations well in excess of those required for the inhibition of the microorganisms specified above.

*Micromonosporin*.—This agent, obtained quite recently from a species of *Micromonospora*, has been but little studied. It is bacteriostatic toward a number of Gram-positive bacteria, whereas all the Gram-negative organisms tested have been found very resistant to its action.

*Lysozyme*.—In 1922 Fleming discovered that various tissues and secretions of the body contain a substance capable of causing the dissolution of a variety of bacteria. This agent, named "lysozyme," is present also in egg white. A bacteriolytic substance prepared by Russian investigators from *Actinomyces violaceus* has been regarded as possibly identical with lysozyme, although there appear to be differences in certain properties of the two agents. The *Actinomyces* lysozyme, which is of protein nature, exhibits a selective action against certain bacterial species but can dissolve both living and dead cells.

#### AGENTS FROM MOLDS

*Penicillin*.—In 1929 Alexander Fleming, the English bacteriologist who a few years previously had discovered the lysozyme of tissues, was



making a study of staphylococci. Culture dishes of the bacteria were kept in the laboratory for periodic inspection, during which they were exposed to the air. Fleming noticed that in one dish, which had become contaminated with a mold (similar to the common blue mildew on jam or citrus fruits), the surrounding *Staphylococcus* colonies became transparent and were dissolved. This is the type of observation of a chance occurrence which is frequently made by scientific investigators. But it is only by the alert, inquisitive, and trained worker that further exploitation is made. In the words of Pasteur: "Chance favors the mind that is prepared." Fleming transferred the mold to a liquid nutrient solution and found that there appeared in the fluid a substance that was markedly inhibitory toward many of the more common disease-producing bacteria. The mold was later identified as *Penicillium notatum* and its bactericidal culture filtrate was designated "penicillin." Recently a preparation with very similar antibacterial properties has been obtained also from *Penicillium chrysogenum*.

Fleming clearly realized the potential utility of the active material as a chemotherapeutic agent, which must have two essential characteristics: ability to inhibit pathogenic organisms and low toxicity toward living tissues. Penicillin was found to combine these properties to an unusual extent. It was not at all toxic to animals but was at least twice as powerful an inhibitor as carbolic acid toward sensitive organisms, such as the various pus-producing cocci.

Local application of penicillin to septic wounds was tried in a limited number of cases with generally favorable, although not miraculous, results. The further investigation of the substance as a therapeutic agent suffered from a serious handicap—it was very difficult to prepare in sufficiently large quantity and in purified condition, owing chiefly to its chemical instability which resulted in loss of antibacterial activity. In the decade following its discovery, no further progress along this line was made, although it was employed for the purpose of isolating certain types of bacteria which, on the ordinary culture media, were overgrown by accompanying species. By this means it was shown that the so-called influenza bacillus was present in the mouths of all normal persons examined and hence was probably not the causal organism of epidemic influenza, as had theretofore been widely assumed. More recently, penicillin has been used to isolate the acne bacillus from acne pustules and so to make possible a simple method for the preparation of autogenous vaccines of the organism.

The discovery and rapid development of the sulfonamide drugs since 1935 had stimulated renewed interest in chemotherapy, and the success of gramicidin had directed attention to the antibiotic agents of microbial origin. In 1940 a research team at Oxford University

commenced a concerted attack on the penicillin problem from several directions; the promise of the initial results inspired a large number of investigators on both sides of the Atlantic to take up the work. In the United States a number of governmental laboratories are now participating in this research.

Obviously the widespread utilization of any rare biological product would be greatly facilitated if the substance could be prepared artificially. In recent years we have seen numerous instances of the rapid extension of use which follows the success of the chemist in synthesizing natural materials; some of the vitamins are outstanding examples. Further than this there always exists the possibility of improving nature's product by some modification of the chemical structure of the molecule. As a matter of fact, it is not the synthesis but the determination of the structure of the natural product which is the fundamental and difficult problem, for once the chemical pattern is known the synthetic chemist can usually devise one or more ways to duplicate it by starting with much less rare and expensive materials.

As in the famous recipe for rabbit stew, so the first requirement in elucidating the structure of a chemical is to obtain a supply of the pure material. This was the problem which confronted the Oxford workers. A method was worked out for growing the *Penicillium* on shallow layers of liquid in special stoneware bottles for a period of 10 days after which the fluid was removed for extraction of the penicillin. All operations must be performed with the most exacting bacteriological cleanliness, since certain bacteria, if they gain access to the solutions, cause a marked reduction in the yield of active material. Normally about 14 gallons of culture solution could be harvested each day, an amount which contains about one-half gram of penicillin, although only a part of this can be obtained in purified form, due to the losses which occur during the many stages of the purification process.

Quite recently there has been worked out, on a laboratory scale, a continuous-flow method similar to that used for the production of vinegar. The mold is cultured in a long glass column packed with wood shavings. Fresh culture medium is slowly dripped in at the top and the fluid containing the penicillin is constantly drawn off at the bottom. At the time of writing (summer of 1943), a large number of pharmaceutical concerns are engaged in production of penicillin; some of these have already progressed to the pilot-plant stage.

Penicillin has not so far been obtained in absolutely pure form, so that its chemical constitution cannot as yet be fully determined. Fortunately it has turned out that certain derivatives may be prepared from penicillin which, while retaining its full antibacterial activity, are also permanently stable and may be kept indefinitely.

The action of penicillin, like that of the various sulfonamide drugs, is different from that of the older antiseptics, in that these newer chemotherapeutic agents act only on certain strains or species of bacteria and also in that their action is primarily an inhibition of the bacterial development, rather than a killing of the germs. The mode of action of penicillin appears to be an interference with the processes of cell division while growth may be allowed to proceed, resulting in very greatly lengthened rods or swollen spheres.

Among the micro-organisms most susceptible to penicillin in test-tube experiments are the gonococcus (the causal organism of gonorrhoea in man), the meningococcus (responsible for about 70 percent of all acute cases of cerebrospinal meningitis), *Staphylococcus aureus* (the most frequent cause of abscesses, boils, and many surgical suppurations), the pneumococcus (principal etiological factor in lobar pneumonia), *Streptococcus pyogenes* (found in human infections of very varied types), *Clostridium tetani* and *Clostridium welchii* (the tetanus and gas gangrene bacilli, respectively), and the anthrax bacillus. Relatively resistant pathogenic organisms, on the other hand, include the bacillus of tuberculosis, the vibrio of Asiatic cholera, the organisms of undulant fever, and certain types of dysentery bacilli.

The exact potency of penicillin cannot, of course, be ascertained until the pure compound is available. Nevertheless, the activity of even the impure material far exceeds that of most other antiseptics. Thus 1 part of penicillin in 60 million parts of culture fluid completely inhibits the growth of staphylococci; partial inhibition is obtained at dilutions of more than 300 million. In comparison with gramicidin, the antibacterial agent obtained from certain soil bacteria, penicillin is 20 to 40 times as potent against staphylococci. Additional advantages of very great importance are the remarkably low toxicity of penicillin toward animals and its lack of inactivation by pus, blood serum, or products of tissue break-down. Indeed, it has been reported even that the bactericidal action of penicillin, in some cases, is enhanced by blood and serum. It is so innocuous that it can be introduced directly into the eye in the treatment of conjunctivitis.

Even the first clinical trials by the Oxford workers, although performed with an impure penicillin preparation of relatively low potency and hampered by lack of material, were attended by dramatic results. In these studies the scarcity of the therapeutic agent was so great, indeed, that advantage was taken of its rapid excretion by the kidneys; penicillin was recovered from the urine of treated patients, repurified, and reused.

With the increasing availability of penicillin, it has been possible to confirm the early promise. A successfully treated case of *Sta-*

*phyllococcus aureus* infection is illustrated in plate 5. An infection of this type, complicated by blood poisoning, is almost universally fatal. The patient, a 4-year-old girl, presumably became infected after biting the inside of her cheek. Redness and swelling of the jaw appeared, and within a few days the child's condition had become critical. Much of the tissue of the floor of the mouth had been killed, and the tongue was nearly frozen to the hard palate. She was unable to sleep, could breathe only with difficulty and had a temperature of 104°. There was evidence of pneumonia in one lung. Penicillin administration was begun. Within 36 hours the staphylococci had disappeared from the blood. Within 96 hours the child was again able to swallow, was breathing easily, and could take a liquid diet by mouth. By the next day, she was able to eat solid foods, and by the ninth day the temperature was normal. The total amount of penicillin administered during the 12 days of treatment was only a little more than 1 gram. In another, somewhat similar, case in which penicillin therapy was begun at an earlier stage, the damage to the tissues and the bacterial invasion of the blood stream were prevented.

Many other types of staphylococcus and streptococcus infections have responded to penicillin. Cases of gonorrheal infections which were not benefited by sulfonamides have also been cured with dramatic rapidity by penicillin treatment. So far, the results of extensive trials have not been reported in detail. In the United States, clinical studies have been organized by the National Research Council. Early in 1943, clinical trials were begun by the United States Army. Among the cases subjected to treatment were many soldiers returned from the Pacific area with unhealed compound fractures, osteomyelitis, and wounds with long-established infections. Very promising results have been obtained and the tests are being greatly extended. In animal experiments, it has been found that the early administration of penicillin is a powerful prophylactic against gas gangrene, one of the most serious complications of battle and air-raid wounds.

For systemic infections, penicillin is usually administered intravenously. Inasmuch as it is destroyed by acids, inactivation occurs in the stomach when the drug is given by mouth. However, oral administration is possible, although less efficient, if large amounts are taken together with sodium bicarbonate to neutralize the gastric acidity.

Of the chemotherapeutic agents of microbial origin which have thus far been studied, penicillin is preeminently the most promising. At the moment, the principal handicap in its application is its limited availability. The outlook for the future, when the problems of production shall have been solved, is very bright indeed.

*Notatin, penatin, penicillin B.*—From several laboratories has come evidence that certain strains of *Penicillium notatum* produce, in addition to penicillin, another antibacterial substance. Various investigators, working simultaneously but independently, have proposed different names for their preparations: “notatin,” “penatin,” “penicillin B”; the available evidence, while not entirely conclusive, suggests that the active principle is the same.

It is the most potent natural antibiotic substance so far described. The growth of *Staphylococcus aureus*, which is one of the most susceptible species, is inhibited by concentrations as low as 0.00000002 percent. It is active against a large number of both Gram-negative and Gram-positive bacteria. The substance is bactericidal, as well as bacteriostatic, but does not appear to cause lysis.

The available evidence indicates that notatin is a flavoprotein in which the protein is combined with flavine adenine dinucleotide. It functions as an enzyme which catalyzes the oxidation of glucose by oxygen, with the production of gluconic acid and hydrogen peroxide. Certain other sugars are oxidized also. It is believed that the antibacterial action is due to the hydrogen peroxide formed. Support for this view is furnished by the fact that the activity is appreciable only in the presence of oxygen and glucose and in the absence of catalase, the enzyme which promotes the destruction of hydrogen peroxide. The activity is reduced in the presence of fresh serum, owing, presumably, to its content of catalase.

Inasmuch as the active agents have not been freed from impurities, the toxicity cannot be determined with certainty. Some preparations have been found to be rather toxic, others much less so. No detailed information as to the therapeutic applicability of the substance is yet available, although notatin has been reported as having been found effective in this respect.

*Penicillic acid.*—This substance, which is not related to penicillin, despite the similarity of names, was isolated from *Penicillium puberulum* in 1911, at which time it was found to have an inhibitory effect upon the growth of certain bacteria. Interest in the substance was revived in recent years by the discovery of other antibacterial mold products. Chemically it has been shown to be  $\gamma$ -keto- $\beta$ -methoxy- $\delta$ -methylene- $\Delta^2$ -hexenoic acid, a type of structure hitherto unknown among natural products. Penicillic acid is rather strongly bacteriostatic toward a number of organisms, some of which are resistant to many of the other antibacterial products of microbial origin. The toxicity for mice is fairly low. Therapeutic studies have not been undertaken up to the present time.

*Penicidin.*—The name “penicidin” has been given to an antibacterial substance obtained from an unnamed species of *Penicillium*.

The material is soluble in organic solvents, relatively thermostable, inactivated by alkalis but not by acids. It has not yet been isolated in pure form and its chemical nature and possible identity with previously discovered mold agents have not been determined. *Eberthella typhosa* is inhibited by a 0.001 percent concentration of the partially purified preparation.

*Spinulosin and fumigatin.*—During a study of the chemical products of various molds, the pigments spinulosin and fumigatin were isolated some years ago from cultures of *Penicillium spinulosum* and *Aspergillus fumigatus*, respectively. Investigation of the structure of these substances showed them to be quite closely related, fumigatin being 3-hydroxy-4-methoxy-2,5-toluquinone, while spinulosin is 6-hydroxyfumigatin. Recently these compounds have been examined for antibacterial properties and both have been found to be moderately active. Spinulosin and fumigatin are less important by virtue of their own potencies, however, than because of the information concerning the relationship between structure and activity which has been obtained from their study. This will be discussed below.

*Fumigacin.*—Although isolated from *Aspergillus fumigatus*, this substance is not to be confused with fumigatin. Fumigacin, which has been obtained in crystalline form but not yet characterized chemically, is said to be active against Gram-positive bacteria but nearly inactive against Gram-negative species.

*Citrinin.*—This is another substance previously isolated from a mold, *Penicillium citrinum*, and on recent reinvestigation found to possess antibacterial activity, although not to an especially marked extent. Its structure has been worked out as a complex substituted quinone; it has not yet been synthesized.

*Clavacin.*—This substance, obtained from *Aspergillus clavatus*, is said to be particularly effective against Gram-negative bacteria, including a number of species not affected by penicillin, mandelic acid, or the sulfonamides. Various strains of the fungus differ greatly in their production of clavacin. The substance, which is rather unstable, has not yet been prepared in pure form, but even the partially purified product exhibits a considerable measure of activity.

*Claviformin.*—This material, isolated in crystalline form from the culture medium of *Penicillium claviforme*, may have the formula  $C_9H_8O_6$ . It is considerably more potent than citrinin, clavacin, or fumigacin, although less so than penicillin. However, in view of its decreased activity in the presence of serum, as well as its fairly high toxicity, its therapeutic application does not appear particularly promising.

*Gliotoxin*.—An antimicrobial substance isolated in crystalline form from *Gliocladium fimbriatum* has been given the name “gliotoxin.” It has the empirical formula  $C_{13}H_{14}O_4N_2S_2$  and is the first antibiotic compound of microbial origin which has been found to contain sulfur. The chemical structure has not yet been elucidated completely but it appears to be a condensed 3-ring compound with a unique type of sulfur bridge. Gliotoxin is both bacteriostatic and bactericidal toward Gram-negative as well as Gram-positive organisms. Staphylococci and streptococci are completely inhibited by concentrations of the order of 0.0001 percent, Gram-negative bacteria by somewhat higher concentrations. It is toxic for higher animals in doses of 50 to 75 milligrams per kilogram. No therapeutic trials have been reported.

*Aspergillic acid*.—Some, but not all, strains of *Aspergillus flavus* have been found to produce an antibacterial substance which has been designated “aspergillic acid.” The material has been obtained in crystalline form in yields as high as 400 milligrams per liter of culture fluid. The empirical formula of aspergillic acid appears to be  $C_{12}H_{20}N_2O_2$ ; its chemical structure has not yet been worked out. In vitro it is fairly potent against certain Gram-positive cocci; pneumococci and hemolytic streptococci, for example, are killed by a concentration of about 0.0002 percent. Gram-negative bacilli are much more resistant to its action.

The toxicity toward mice is not especially high. The maximal tolerated dose is about 200 milligrams per kilogram when given orally and approximately half of this when injected intraperitoneally. However, neither oral nor intraperitoneal administration has been found to exert any therapeutic effect on experimental mouse infections with pneumococci or hemolytic streptococci, although preliminary experiments have shown some protection in experimental infections with gonococci and gas gangrene bacilli.

*Aspergillin*.—This name has been given to an antibacterial substance which has been obtained in partially purified form from a strain of *Aspergillus flavus*. What relation this material may have to other antibacterial agents of microbial origin cannot be determined from the limited information so far available. Making allowances for the impure state of the aspergillin tested, its bacteriostatic potency and toxicity appear to correspond approximately with those of aspergillic acid.

*Puberulic and puberulonic acids*.—These substances have been isolated in crystalline form as metabolic products of several species of *Penicillium*. The empirical formulas are  $C_8H_6O_6$  and  $C_8H_4O_6$ , respectively. The chemical constitution is unknown, but puberulonic

acid is believed to be a quinonoid compound and puberulic acid the corresponding quinol.

Both compounds inhibit the growth of a number of Gram-positive bacteria, puberulic acid being somewhat more effective than puberulonic. Neither shows much activity against Gram-negative species.

*Unnamed substances.*—Several workers have obtained evidence of the production of antibacterial substances by other molds. In one survey of 100 fungal species, 30 were found to exhibit activity, with the added possibility that some of the negative species might well give positive results under different cultural conditions or against test bacteria other than those employed. In view of the existence of thousands of species of molds, it seems certain that many other antibacterial agents produced by these organisms remain to be discovered. Some yeasts, too, have been found to produce bacteriolytic substances.

### PROSPECT

Of the score or more products of microbial origin which have been described here, the antibiotic activity of the great majority has been discovered only within the last 2 or 3 years. Most of them have not yet been studied sufficiently to determine what therapeutic applications may eventually be made. It is, therefore, highly encouraging that some of these agents, particularly penicillin and tyrothricin, already offer definite promise of practical utility. However, even though none of the presently known substances should ultimately be found of use in itself, the value of the rapidly increasing knowledge in this field is very great. This is true for two reasons: in the first place, the identification of a compound possessing some of the properties desirable in a chemotherapeutic agent, even though it may at the same time have other undesirable characteristics, opens the door for the chemist to manipulate the molecular architecture so as to enhance the one and suppress the other; secondly, studies of the mode of action of the available inhibitory agents upon micro-organisms may suggest the use of other substances, which, while chemically unrelated, will exert similar biological effects.

A wide range of chemical types is represented among the limited number of antimicrobial agents of which the composition has been even partially elucidated: proteins (notatin, lysozyme), polypeptides (gramicidin, tyrocidine), fatty acids (pyocyanic acid, isovaleric acid, oleic acid, possibly actinomycetin), organic bases (streptothricin, proactinomycin), quinones (citrinin, fumigatin, spinulosin, possibly puberulonic acid), heterocyclic compounds (gliotoxin, actinomycin A, pyocyanine,  $\alpha$ -hydroxyphenazine). Obviously, complete knowledge of the constitution is necessary before the relationship between structure and biological properties can be studied.



So far such studies have been made in only one or two cases but these have proved very fruitful. It has been mentioned that the two mold products, fumigatin and spinulosin, are structurally very similar, differing only in the possession of an additional hydroxyl group by the latter. Spinulosin was found to have only about one-tenth the antibacterial potency of fumigatin. This unexpected discovery that the activity was markedly decreased by the introduction of a hydroxyl group led to a study of a considerable number of substituted toluquinones and benzoquinones, from which several important generalizations concerning the effect of structure on activity could be drawn. As a valuable byproduct of the investigation, it was found that several of the compounds tested were more potent than fumigatin itself.

A variety of effects is produced by the different antibacterial agents of microbial origin. At the one extreme are those like actinomycin and lysozyme which cause the disintegration of the bacterial cells. Others, such as gramicidin, may also produce dissolution but presumably only through the self-digestion brought about by the enzymes of the killed cells. Killing without lysis is brought about by a number of substances: pyocyanine, clavacin, fumigacin, gliotoxin, notatin, etc. The least drastic action is that of such agents as actinomycin which are primarily bacteriostatic, preventing growth or reproduction without killing the cells.

As might be expected, an even greater diversity appears to exist among the mechanisms by which the antibacterial effects are brought about. In very few cases has much insight been gained into these mechanisms, but progress is being made rapidly.

Ehrlich and other early workers in the field of chemotherapy proceeded largely on the assumption that the most effective agents would be those which produced the maximum killing of the pathogens without greatly damaging the cells of the host, a sort of selective sledge-hammer action. In later years it has become apparent, however, that actual killing of the parasite by the chemical agent itself may not be at all necessary. The natural defense mechanisms of the body in many cases are able to cope with a limited number of invaders and can effect their elimination if the bacterial multiplication can be prevented. Prevention of reproduction can be achieved through interference with some metabolic process of the micro-organism and, since the biochemical processes of the bacterial cell differ in numerous respects from those of higher animals, there exists the possibility that there may be found subtle methods of interference which will be relatively innocuous to the host.

An outstanding example of such a state of affairs is furnished by the action of sulfanilamide. One of the essential growth factors,

or vitamins, for various bacteria is p-aminobenzoic acid which must be available if these organisms are to multiply in the infected animal. The utilization of this substance is effected through the agency of certain enzymes of the bacterial cell. Now it has long been known that compounds structurally similar to those upon which the enzyme normally acts may, if furnished together with the natural substrate, compete with it for the enzyme and so prevent or retard the normal interaction. In just this way the utilization of p-aminobenzoic acid is prevented by the presence of the chemically related sulfanilamide. This mechanism was not at all understood at the time of the introduction of sulfanilamide, of course, but it appears now that a similar principle may obtain in the action of many, though not all, other antibacterial agents. This has been indicated above in the discussion of gramicidin, one of the few microbial agents of which, to date, the mode of action is at all understood: In this connection it may be significant also that  $\alpha$ -hydroxyphenazine, one of the antibacterial substances produced by *Pseudomonas aeruginosa*, bears a certain structural similarity to riboflavin, or vitamin B<sub>2</sub>.

The inhibitory effect of notatin, on the other hand, appears to be of a quite different nature, being occasioned by the toxicity of the hydrogen peroxide which it produces.

An interesting phase of the mechanism of action is the high degree of specificity for certain micro-organisms exhibited by many of the agents. In a number of cases this specificity appears to parallel closely the Gram-staining reaction. Better understanding of the factors responsible for bacterial differences in this staining technic may conceivably aid in the further development of other specific chemical inhibitors.

It seems axiomatic now that a practical chemotherapeutic agent must be inhibitory toward the pathogen, not merely in vitro but under the conditions existing in the diseased host, and that it should exert a minimal deleterious effect on the latter. There are, in addition, a number of subsidiary desiderata, such as convenient mode of administration, stability in the body and during storage, etc. In the past these requirements have not always been fully appreciated. Before the etiology of infectious disease was understood, the search for chemical specifics was of necessity a trial and error affair. With the recognition of pathogenic micro-organisms came the idea of chemical bullets fatal to the parasite but not the host. Knowledge of the chemical structure of such bullets furnished guiding principles, according to which better ammunition could be molded. Increased knowledge of the precise means by which inhibition of bacterial activities can be effected and of bacterial physiology in general may be expected to lead to a new phase in the development of chemo-

therapy. It is in this respect that the microbial products may be of greatest value, since even at this early stage of their study many new avenues of exploration have been opened up. Through some of these, conversely, will come better understanding of the physiology and nutrition of micro-organisms and, in all likelihood, of higher animals also.

In passing, mention may be made of another possible application of these agents, namely, in the control of certain plant diseases. Very little has been done along this line and its practicability cannot yet be forecast. However, the few experiments which have been carried out indicate that the treatment of fungus-infested soil or seeds with certain bacterial preparations may reduce seed decay and the damping off of the seedlings.

Finally, attention should be directed to other roles of the antimicrobial substances of microbial origin which may possibly be of far greater significance than any eventual therapeutic application. It has long been realized that countless numbers of pathogenic bacteria, such as those responsible for pneumonia, diphtheria, plague, dysentery, cholera, tuberculosis, etc., gain access to the soil via the excreta or remains of diseased organisms. Yet the soil is not a source of epidemics of these diseases and, indeed, the pathogenic micro-organisms cannot be recovered from the soil in significant numbers. It is hence obvious that the survival of such forms in the soil is very limited. The suggestion was made long ago that other soil-inhabiting microbes, antagonistic to the pathogens, might be at least partially responsible for the rapid disappearance of the latter. The results of recent work lend much support to this view, so that it appears entirely likely that antimicrobial agents, such as those described here, may be of great importance in the natural control of infectious disease. Possibly this may apply to diseases of plants, as well as to those of animals.

Certain of the antibiotic microbial substances may, perhaps, play an even more intimate role in the natural control of some superficial infections in man. The skin is a nearly constant habitat of certain micro-organisms, some of which are known to form antimicrobial products. Whether these actually serve to protect against skin infections is not known, but there is a little circumstantial evidence indicating that the normal skin flora may be absent or altered in cases of some fungus infections. The mouth and intestinal tract, too, harbor a bacterial flora which conceivably could be of importance in the control of certain infections.

It is hoped that this brief and incomplete account of the antibiotic substances of microbial origin will have served to call attention to a field of inquiry, as yet merely scratched, whose further cultivation may well be expected to contribute greatly to the welfare and scientific advancement of man.

June 1944.

NOTE.—During the year, since the preparation of the foregoing account, many notable advances have been made. Of greatest immediate interest are those relating to penicillin. Twenty-one plants for the manufacture of this drug are being erected in the United States and Canada, at a total cost of nearly \$20,000,000. During the year production has been increased by more than 10,000 percent, and the present program calls for a further fivefold increase. Concurrently, the price has been reduced markedly and will doubtless fall much lower. The great potency of penicillin is emphasized when it is pointed out that the projected maximum production of these 21 plants will aggregate only about 9 pounds of the pure material per day, an amount, however, which is sufficient for the treatment of approximately 10,000 serious cases.

Much of the credit for making possible the production program is due to the Northern Regional Research Laboratory of the United States Department of Agriculture which, through selection of better strains of the mold and improvement of the culture medium, has increased greatly the yields obtained.

Penicillin has been isolated in pure crystalline form. Information as to its structure and synthesis, however, is at present classified as a military secret.

Considerable additional experience in the clinical use of penicillin has been gained; it has been found very effective in treatment of pneumococcic pneumonia and possibly may prove of value against syphilis.

Space permits brief mention of only two of the many recent developments in other phases of the field of microbial antibiotic substances.

It has been shown that the products isolated from a number of molds and designated by various workers as claviformin, clavacin, clavatin, and patulin are identical and have the formula  $C_7H_6O_4$ . This substance has been claimed to be efficacious in treatment of the common cold.

Among the newly discovered antibiotics, special interest attaches to the finding that an antibacterial substance is produced by the unicellular green alga *Chlorella* when grown under autotrophic conditions. This material, named chlorellin, is active against both Gram-positive and Gram-negative organisms; it has not yet been obtained in a pure state.

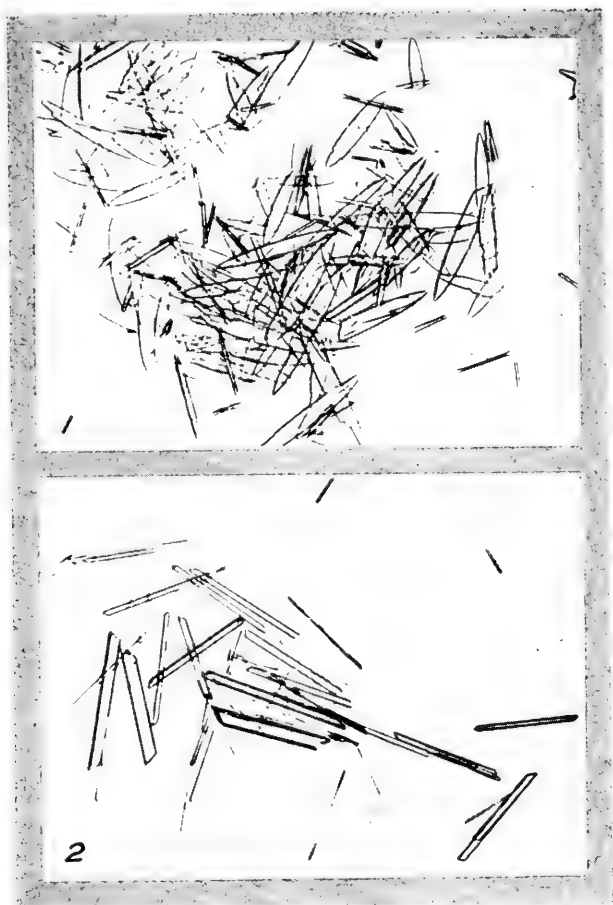

1. Photomicrograph of crystals of gamicidin.  $\times 225$ . 2. Photomicrograph of crystals of tyrocidine hydrochloride.  $\times 320$ .  
(From Dubos and Hotchkiss, *Trans. and Stud. Coll. Physicians*, Philadelphia, April 1942.)



1



2

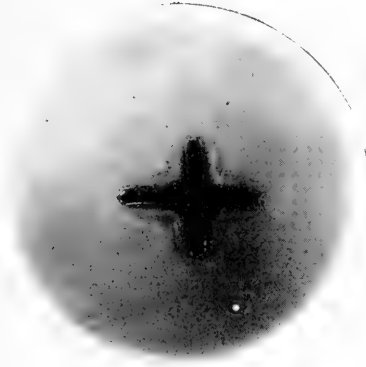

3

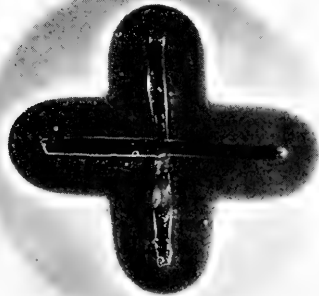

4

DEMONSTRATION OF THE GROWTH-INHIBITING EFFECT OF ACTINOMYCIN.

The substance, applied in the cross-shaped groove, diffuses some distance into the agar and prevents the growth of gram-positive bacteria (2= *Bacillus mycoides*; 4= *Sarcina lutea*) but not of gram-negative bacteria (1= *Escherichia coli*; 3= *Azotobacter heijerinki*). (Courtesy Waksman and Woodruff, *Journal of Bacteriology*, August 1941.)

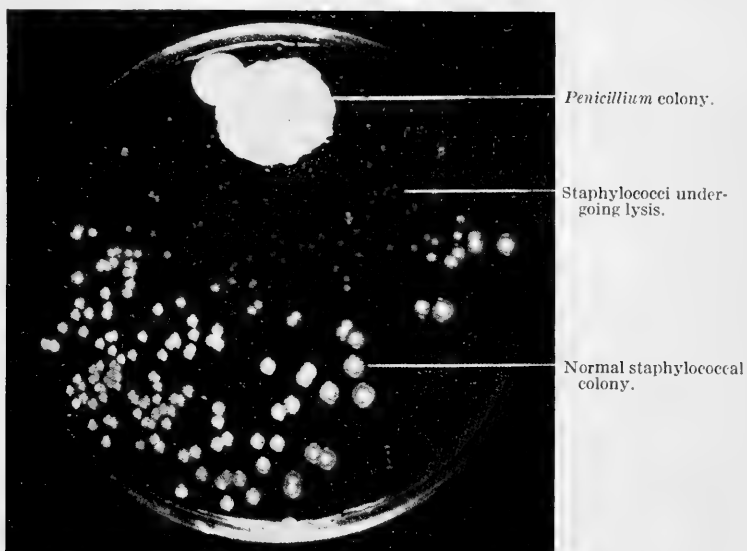

PHOTOGRAPH OF A CULTURE PLATE SHOWING THE DISSOLUTION OF STAPHYLOCOCCUS COLONIES IN THE NEIGHBORHOOD OF A COLONY OF PENICILLIUM NOTATUM.  
(From the publication of Fleming announcing the discovery of penicillin, in *British Journal of Experimental Pathology* for 1929.)

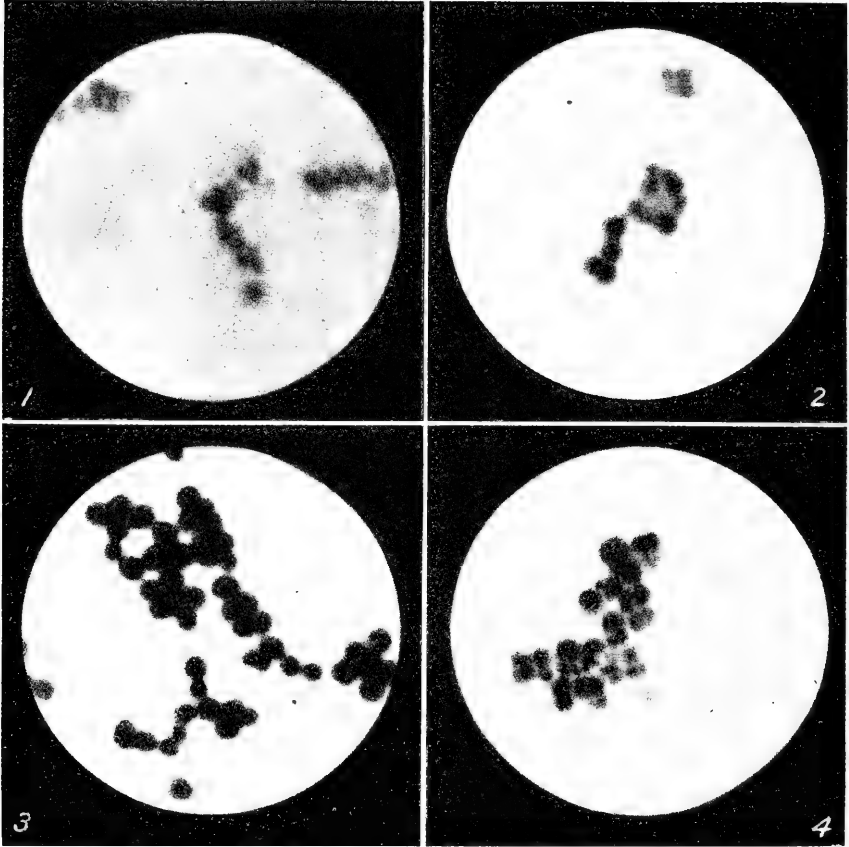

EFFECT OF PENICILLIN ON GROWTH AND CELL DIVISION OF  
STAPHYLOCCOCUS AUREUS.

1, control culture in broth, after 24 hours; 2, 3, 4, cultures in broth containing 0.00009 percent penicillin, after 3, 5, and 24 hours respectively. Penicillin permits growth of the cells but interferes with their normal division and separation. (From Smith and Hay, *Journal of the Franklin Institute*, June 1942.)





1 and 2, front and side views of patient at onset of penicillin therapy. Extensive facial cellulitis and edema of both eyes may be noted; patient moribund; 3, appearance of child 96 hours later; 4, appearance of patient 9 days after onset of treatment; 5 and 6, front and side views of patient before dismissal. Complete recovery. (Courtesy W. E. Herrell, Proc. Staff Meetings Mayo Clinic, March 1943.)







# SULFONAMIDES IN THE TREATMENT OF WAR WOUNDS AND BURNS<sup>1</sup>

---

By CHARLES L. FOX, JR., M. D.

*Department of Bacteriology, College of Physicians and Surgeons*

---

One of the major problems of global warfare is the immediate medical care of those injured by the ruthlessness of mechanized warfare and aerial bombardment. Our Government has mustered every possible resource to meet this medical emergency.

It is indeed ironic that the horror of war casualties has stimulated tremendous progress in medical research. Under the Office of Scientific Research and Development in Washington, specialized committees, such as the Committee on Medical Research, have contracted with scientific institutions throughout the nation for specific, vital war research on problems such as the treatment of shock, the control of malaria, the use of sulfonamides in wounds and burns, and many others. New developments are communicated directly to representatives of the armed forces—almost from the test tube to the battlefield.

Let us now focus on the problem of war wounds and burns and see the progress that has been made. To understand the treatment, attempt to visualize exactly what happens. A man is engaged in combat. Suddenly he is struck by a bullet or shell fragments, or his clothes may be set on fire, or he may be flung off his ship into water covered with burning oil. Within a very short time help arrives.

Through first-aid courses you have learned enough to recognize the immediate problem: treatment for shock and control of bleeding.

Now this is where recent research has made an important contribution. Patients in shock from burns should not be "kept warm" or have "heat applied" with hot blankets or hot water bottles. Careful studies have shown that room temperature (70°-75°) is best; that the extremes of heat or cold are definitely harmful.

After shock has been treated, the next problem is to prevent infection. Gunshot wounds are relatively clean but, since bacteria that cause serious infection are everywhere about us, most wounds and

---

<sup>1</sup>Address delivered to the Biological Sciences Group, Special Libraries Association, at their annual conference, 1943. The recent research mentioned is work done under a contract, recommended by the Committee on Medical Research, between the Office of Scientific Research and Development and Columbia University.

practically all burns are potentially infected. The word potentially is used because frequently bacteria may be present but no infection will develop provided the bacteria do not gain the upper hand.

For example, in the Revolutionary and Napoleonic wars, only 1 out of every 25 soldiers was killed in battle but 1 of every 2 soldiers—50 percent of the army—died of infections in hospitals.

That was before anything was known about bacteria. Then followed the great discoveries, by Pasteur, Koch, Welch, and many others, of the bacteria that cause infectious diseases. Lord Lister then developed surgical asepsis—which means simply keeping bacteria from getting into open wounds.

These great advances were reflected in the medical history of the last war. To understand the present tremendous progress let us compare some results from the last war with similar cases as described by Capt. Reynolds Hayden after the Pearl Harbor raid. In World War I, gunshot wounds of the abdomen resulted in 60 to 80 percent mortality; at Pearl Harbor the mortality from these cases was less than 1 percent, and recent reports from the Solomon Islands place the mortality from these cases at less than 5 percent.

Medical officers from all parts of the world who have been treating patients under a variety of circumstances have agreed unanimously that the sulfonamide drugs have been in large measure responsible for this great improvement. Now what are these drugs and how do they help accomplish miracles?

It is interesting that the first reports of the amazing chemical that cured bacterial infections came from Germany in 1935. Domagk, of the notorious German chemical and dye trust, reported that he had discovered a red powder which when fed to mice infected with virulent hemolytic streptococci would save all the treated animals while the untreated control animals died in one day. Furthermore, to make the picture confusing, he stated that this red powder had no effect whatsoever against the same bacteria in the test tube. This made everyone very skeptical even though reports of miraculous cures of patients continued to come out of Germany. Some English and French research workers wanted to repeat these experiments but the French couldn't get any of the red powder from the dye trust. Fortunately, a brilliant French organic chemist figured out what was in the red powder and discovered how to make it.

Then the French bacteriologists made an amazing discovery—most of the big red molecule wasn't really necessary at all—only a small part of the molecule, the sulfanilamide part, was needed to save the infected mice. And equally amazing, whereas the big red molecule of the Germans had no effect on bacteria in the test tube, the small sulfanilamide part could stop the growth of bacteria in the test tube as

well as in the body. Since this sulfanilamide part had first been made in 1908 by Gelmo—who, by the way, had found that this chemical helped dyes stick to wool—there were no patent restrictions and every chemical company began making sulfanilamide so that doctors everywhere could try it out.

In the meanwhile research was conducted in many laboratories, including this, to determine how sulfanilamide worked.

It was soon found that bacteria were not killed by the drug but that their rate of multiplication was temporarily retarded. This was called bacteriostasis. In the animal organism, this retardation aided the white blood cells to gain the upper hand and effectively dispose of the inhibited bacteria. Furthermore, this bacteriostatic effect did not begin immediately but only after a lag of several hours during which time the bacteria in the drug environment grew just as well as the control bacteria. It is possible that this delay in action represented the time needed for conversion of the drug itself by oxidation to an active principle.

A recent discovery, however, has led to another explanation. That is Woods' observation that para-aminobenzoic acid almost specifically nullifies the action of sulfanilamide, and that there is a definite quantitative relationship; i. e., one part of PAB can "block" or nullify 5,000 parts of sulfanilamide. This ratio obtains regardless of which bacterium is used for the test. Woods suggested that PAB is an essential metabolite for the bacteria and that sulfanilamide because of its chemical similarity "blocks" the utilization of PAB by bacteria. Although PAB has been shown to be an essential growth factor for two nonpathogenic bacteria, it has not yet been shown to participate in the metabolism of pathogenic bacteria so the mechanism of the definite antisulfonamide action of PAB remains to be discovered.

It is important to differentiate PAB from the other so-called "inhibitors" of sulfanilamide. Pus, peptone, devitalized tissue, and certain bacterial extracts have been asserted to "inhibit" the action of sulfanilamide. Careful study has shown, however, that in general these substances improve the growth of bacteria so that the drug has to grapple with more vigorously growing organisms. These are quite different from PAB which does not appear to alter the growth of bacteria, nevertheless definitely inhibits sulfanilamide bacteriostasis. The practical importance of this distinction will be clarified below.

During this time chemists were attempting to synthesize sulfanilamide like compounds which might be more potent and more effective against a wider variety of bacteria than sulfanilamide itself. Sulfapyridine was the first important improvement and established its merit by the success attained in the treatment of pneumonia. Soon afterward, sulfathiazole was synthesized. This substance is free of

many of the unpleasant and dangerous complications of sulfapyridine and is somewhat more effective. Sulfadiazine, the latest of this group, is about as effective as sulfathiazole but is less toxic and is easily tolerated by most people. Up to this point the usefulness of these drugs has been evaluated for systemic diseases like pneumonia, meningitis, or infection of the blood stream with streptococcus. In these cases sulfonamides are given by mouth and the drug is distributed through the body. A localized infection in one part of the body like a limb or the abdomen can be treated by placing the drug directly in the wound in contact with the infection zone. This provides a high concentration of drug immediately in the dangerous infection zone without subjecting the entire body to the treatment.

There are, however, certain practical difficulties. These drugs do not dissolve well and tend to lump or "cake" when poured into wounds. In addition, pus and partly devitalized tissues are excellent nourishment for the bacteria and sometimes interfere with the action of the sulfonamides.

Studies in this laboratory were focused on the local use of these drugs as a problem of military importance. It soon became apparent that the order of increasing therapeutic potency—sulfanilamide, sulfapyridine, sulfathiazole, and sulfadiazine—was a consequence of a single physicochemical characteristic: increasing degrees of ionization of these weak acids. It was of further interest that the more effective drugs were likewise more effective in overcoming the blocking effect of PAB. It was then found that acidity which reduced the ionization of these drugs likewise reduced their activity against bacteria. In addition, acidity also reduced the solubility of these substances.

Measurements at the bedside showed that infected wounds usually become extremely acidic. This acidity is sufficient to reduce markedly the antibacterial activity of sulfanilamide and sulfapyridine and to prevent sulfathiazole or sulfadiazine powder from freely dissolving in the infection zone. In addition, this acidity tends to destroy the white blood corpuscles or leucocytes. Since these cells are needed to dispose of the sulfonamide-treated bacteria, they must be preserved to help eradicate invading bacteria. Clinical trials have shown that by using the soluble sodium salts of sulfathiazole or sulfadiazine (instead of the insoluble acids themselves) the interference of wound acidity can be minimized and wound infections can be controlled. The chemically "activated" drug is held in solution in the infection zone; and, with the cooperation of the leucocytes, speedily eradicates the bacteria.

It is important to realize that this can be accomplished without harming the tissues. On the other hand, antiseptics such as iodine



kill bacteria but also destroy tissue cells in the wounds. This is one of the greatest virtues of the sulfonamides—their selective action against bacteria without damaging tissue cells.

With this background you might predict that burns would be particularly suited for local sulfonamide therapy. Insofar as burns represent destruction of the skin, which is man's natural barrier against infection, sulfonamides are valuable in preventing bacteria from establishing infection in the damaged areas. But destruction of the skin also presents another serious problem—loss of the mechanical covering of the underlying tissues. The heat of a burn causes the tissues to become greatly swollen and waterlogged with a plasmalike fluid. Loss of the skin covering from burns permits the escape of this fluid and aggravates the shock. Many types of substitute coverings have been proposed but the most satisfactory seems to be a new pseudo skin formed in the burned region from the damaged skin. To accomplish this, tannic acid has been used for years to coagulate the burned skin and produce a hard, stiff, adherent covering known as an eschar.

Now, tannins are used in the leather industry to "tan" animal skins and convert them into leather. The late Charles Wilson, a leather chemist, showed that tannic acid itself caused animal skins to become swollen and unfit for leather. In contrast, however, he found that when tannic acid is neutralized to the slightly alkaline reaction of the tissues, skins can be "tanned" without swelling, and soft, pliable leather is formed. Similarly, when neutralized tannic acid is used on burned human skin, very little swelling occurs and a soft, pliable covering is formed. This effectively prevents loss of the plasmalike tissue fluids. In addition, pain is alleviated immediately.

This neutralized or slightly alkaline tannic acid works very well with the sodium salts of the sulfonamides. In the past, tannic acid itself has been used with the sulfonamides but too frequently infections have occurred under the hard eschar of coagulated burned skin. The probable explanation is that the acidity of the tannic acid chemically inactivated the sulfonamide as described above. The neutralized tannic acid, on the other hand, keeps the sulfonamide in solution in the activated ionized form. The trials in human burns up to the present have indicated that this combination effectively prevents infection.

The mixture is prepared in ointment form so that it can be quickly and easily applied and then covered with a light protective bandage. Since the soluble sulfonamide is brought into immediate contact with the zone of potential infection, no additional drug by mouth is necessary. It is not understood how this mixture relieves the pain, but the fact remains that the pain disappears after applying the ointment.

After a week the dressing is removed. Most of the ointment is found to have disappeared but the burn is covered with a soft, pliable protective eschar. Regeneration of new skin will occur under this covering provided that infection does not stifle this process.

Treatment in this phase follows a cardinal principle of sulfonamide therapy—maintaining the concentration of drug in the infection zone as long as any bacteria may be present. This is accomplished by placing gauze impregnated with petrolatum, paraffin, and sodium sulfathiazole on the burned areas.

When the skin is completely destroyed, skin from another part of the body must be grafted to make up the loss. To insure that the grafts will grow and not be overrun by spreading infection, additional sodium salts of the sulfonamides are used in the grafted areas.

This brief report has given you a glimpse of the local uses of sulfonamides. They are used first in the fresh wound or burn to prevent the development of infection; then they are used to keep down infection while healing occurs or when skin grafts are used to cover the defect. Recent research has shown that infected wounds become acidic and that when the acidity is overcome the drugs are "activated" and in solution in the infection zone. It remains for future research to discover additional improvements that may further reduce the present low incidence of infection in wounds and burns.

# THE YELLOW FEVER SITUATION IN THE AMERICAS<sup>1</sup>

---

By WILBUR A. SAWYER

*Director, International Health Division, The Rockefeller Foundation*

---

The early history of yellow fever, dominated by records of epidemics in cities and outbreaks on ships, was largely characterized by waves of the disease. There were outstanding epidemic years in which the disease extended to the seaport cities of Spain, to Philadelphia, and to New York, or up the Mississippi to Memphis and beyond, and also years in which there was widespread involvement of Central America and Mexico. The same changeable epidemic picture has been observed in West Africa and South America. The disease was nevertheless continuously present for long periods in certain cities, like Habana and Guayaquil, where the supply of susceptible persons and an abundance of *aegypti* mosquitoes (*Aedes aegypti*) permitted the disease to appear year after year. The outstanding characteristics of the historic yellow fever picture were sudden epidemic extensions of the disease far beyond any known endemic foci, followed by absence of the disease or relative quiescence.

## THE SHIFTING LOCALIZATION OF JUNGLE YELLOW FEVER

Observations during the past few years in several countries of South America suggest that jungle yellow fever resembles, more closely than was at first apparent, the old-time urban *aegypti*-transmitted disease in its tendency toward wavelike epidemics and shifting localization. The world-wide yellow fever immunity survey, carried out from 1931 to 1937, by testing human sera from many countries by means of the mouse-protection test, showed that immunizing infections had recently occurred in many places previously supposed to be free of infection (Sawyer, Bauer, and Whitman, 1937; Soper, 1937a) and the systematic collection and histologic examination of liver specimens in South America showed that fatal cases of yellow fever were occurring in scattered locations in the newly revealed endemic areas

---

<sup>1</sup> The observations on which this paper is based have been made in large part by members of the staff of the International Health Division of The Rockefeller Foundation and of the health authorities of the governments with which the Division is collaborating. The paper is here reprinted by permission from the Proceedings of the Eighth American Scientific Congress, vol. 6, 1942.

in South America. The tendency was to consider the disease in these areas as more or less static although the first observation of proved jungle yellow fever was made during a sharp epidemic in the Valle do Chanaan in Brazil (Soper et al., 1933). The very fact that jungle yellow fever was transmitted only under biological conditions peculiar to a forest environment with its special insects and animals would seem also to limit the spread as jungle yellow fever. It has, however, become increasingly clear that jungle yellow fever may sweep as an epidemic through a wide extent of the favorable environment and then become urban, *aegypti*-transmitted yellow fever when it reaches a community in which that mosquito abounds. That such spread of yellow fever from jungle to city has not been observed to occur recently needs special comment.

#### THE ABSENCE OF AEGYPTI-TRANSMITTED EPIDEMICS AND THE DANGER OF THEIR REAPPEARANCE

A striking and reassuring feature of the present situation in the Western Hemisphere is the absence of the classical type of yellow fever outbreak, in which the disease is transmitted by the long-recognized mosquito vector *Aedes aegypti* and tends to be localized in cities and to invade the channels of commerce. For 3 years no reports of such outbreaks have been confirmed in the Americas. The credit must rest largely with those who have continued and perfected the control of *Aedes aegypti*, so successfully begun by Gorgas and Oswaldo Cruz, for the threat of infection from areas of endemic and epidemic jungle yellow fever in the interior of South America appears to have been continuous for an undetermined period extending far into the past. Were it not for the noninfectibility of Rio de Janeiro in 1938, owing to well-organized *aegypti* control, we might have seen another serious epidemic in that city, with spread to other communities and shipping, for Soper (1938) has reported that four persons infected in a nearby epidemic of jungle yellow fever were known to have come into the city without causing any local infections.

That jungle yellow fever is the same disease as urban yellow fever is well established. That it may be transmitted by *Aedes aegypti* has been repeatedly demonstrated in the laboratory (Whitman and Antunes, 1938), and on one occasion the establishment of yellow fever of jungle origin in a Brazilian town and its transmission there by *Aedes aegypti* were observed (Walcott et al., 1937). Some risk of urban yellow fever epidemics will remain as long as jungle yellow fever persists. Inasmuch as the possibility of complete extermination of the disease now seems remote if not impossible, the health authorities are faced with the problem of choosing wisely between the available methods of confining jungle yellow fever to the areas in which it is endemic, reducing the human involvement within these areas,

and protecting threatened cities and rural populations against infection.

The greatest disaster which yellow fever could bring would be the renewed involvement of large urban populations in *aegypti*-spread yellow fever, particularly if the cities affected were seaports from which the disease might easily spread to other seaports as well as to the surrounding towns. It is therefore a matter of moment that the methods of preventing urban yellow fever through suppression of *Aedes aegypti* have been so perfected by the Brazilian Yellow Fever Service that any city may easily solve its yellow fever problem without excessive cost by making itself noninfectible and may maintain this condition.

#### METHOD IN USE TO PREVENT AEGYPTI-TRANSMITTED YELLOW FEVER

The essential improvements of method that have made it possible to reduce the breeding of *Aedes aegypti* almost to the point of local extermination have been described by Soper (1937b). The weekly inspection of premises for *aegypti* larvae and the destruction of breeding places are being supplemented by the search for adult mosquitoes by special squads. If any are found, the breeding foci are sought out and destroyed. To render the destruction of foci as certain as possible, petroleum (3 parts fuel oil and 1 part kerosene) is placed on water found to contain larvae. The oil and the necessary subsequent cleaning are much more likely to destroy mosquito eggs than the older method of merely emptying out the water. Such methods have so reduced breeding that it has been possible in many cities to lengthen the period between house inspections and thus to lower the cost of the service.

These methods make it entirely practicable for cities to acquire and maintain complete immunity to yellow fever regardless of the degree of exposure. The nearer to jungle yellow fever the more urgent the precautions, but it must be kept in mind that the critical distances have been greatly extended by the increased rapidity of travel, especially by airplane. Those cities and towns through which yellow fever would have to pass in order to spread from the jungle areas or to invade an uninfected country have a special responsibility for keeping themselves noninfectible.

#### THE IDENTIFICATION OF YELLOW FEVER

To be completely on their guard against *aegypti*-transmitted yellow fever, the health authorities need to be in a position to recognize yellow fever immediately if it should appear, particularly if adequate steps have not already been taken to make their cities noninfectible. The history of yellow fever contains many instances in which failure

to suspect yellow fever or disagreement as to the diagnosis have caused the loss of valuable time. No longer is it sufficient to accept as final the weighed opinion of the experienced clinician, although a decision on the basis of symptoms may be all that is possible before the first precautionary measures have to be taken. For the final decision as to the nature of a case or outbreak, the laboratory is now giving conclusive information even when the cases are clinically mild and lack nearly all the well-known classical symptoms (Sawyer, 1939). In such cases blood specimens are drawn aseptically as early as possible during the acute disease and again 3 weeks after the onset. If the serum from both specimens is examined by means of the mouse-protection test in a yellow fever laboratory, and the first specimen gives no protection against yellow fever virus while the second protects definitely, the case is one of yellow fever. If neither or both specimens give definite protection, the illness must be some other disease. Where a more serious investigation is required, the attempt is made to isolate the virus itself from cases during the first 3 days of illness by injecting blood serum from the sick person intracerebrally in amounts of 0.03 cc. into six susceptible mice. Any virus thus isolated may be studied in detail in the laboratory. Great care must be exercised to prevent infectious blood from coming into contact with the hands of a nonimmune investigator. These methods establish the diagnosis beyond dispute whenever the case has been seen early. If there are fatal cases, it is important to obtain at least a specimen of liver by autopsy or puncture with the viscerotome and to send it in 10 percent formalin to a pathologist acquainted with the lesions of yellow fever. The determination of the nature of the disease in the individual case is, however, only one step in the thorough epidemiologic investigation necessary for the adequate study of an outbreak of yellow fever.

#### THE PROBABLE ABSENCE OF YELLOW FEVER OUTSIDE SOUTH AMERICA

When adequate in number, sufficiently representative, and completely negative, protection tests give the strongest possible evidence of the absence of yellow fever, whether transmitted by *aegypti* or the unknown jungle vectors. The results of protection tests of sera from North America, Central America, and the West Indies were published by Sawyer, Bauer, and Whitman early in 1937. The specimens had been collected by many cooperating persons from 1932 through the early part of 1936. When the collection began, jungle yellow fever had not been discovered or defined, and fewer specimens were taken in rural or forest environment than would otherwise have been the case. Moreover, a brief survey with completely negative

results only in young children could not be accepted as fully conclusive evidence of the absence of yellow fever, and this was the only evidence available in some countries. The disease had been present in El Salvador in the form of a sudden epidemic of unknown origin as late as 1924 and had been widespread in Central America and Mexico in 1921, and consequently many adult immunes were discovered. The results of the survey were in general consistent with the complete disappearance of yellow fever from the entire region, including North America, Central America, and the West Indies, but the finding of three protective sera among those from 321 Mexican children under 10 years of age made it seem probable that unrecognized yellow fever infection had existed in that country as late as 1925, when the youngest of the three immune children was born. It was apparent that yellow fever might still be lingering in Mexico or some one of the Central American countries or West Indian islands, and it was decided to watch the situation over a period of years and investigate all suspicious reports. Canada and the United States seemed definitely free of infection. In the absence of any suspicion of the reintroduction of the disease, no further investigation of these two countries was made. In Mexico, the West Indies, and all but two of the countries of Central America, there have been neither observations nor rumors suggesting the reappearance of yellow fever. Accordingly, the tentative opinion that they are free from yellow fever, as published in 1937, seems to have been strengthened by the lapse of time.

#### CASES RESEMBLING YELLOW FEVER IN COSTA RICA

Reports of two fatal illnesses in Costa Rica aroused apprehension lest jungle yellow fever might be present there. The first case originated early in October 1938 in the town of Parrita at about the middle of the southwestern coast of that country, and the patient died in a hospital in the town of Puntarenas. Parrita is in a region being developed for banana culture by the clearance of virgin jungle, exactly the kind of situation which would bring jungle yellow fever to light if it were present. The symptoms of the patient included pronounced jaundice, high fever, slow pulse, albuminuria, and vomiting of blood. There was no necropsy.

The second case was in a man 26 years old. It originated in Sierpe, on the seacoast near the southwestern end of the Pacific slope of Costa Rica. Here, too, there is a banana development and forest clearance. This patient had fever, a pulse rate of 120, albuminuria, acute epigastric pain, slight jaundice, and persistent vomiting. There were no malaria parasites in his blood. The patient died on the fourth day after admission to hospital at Puntarenas. At autopsy the stomach was found to contain a dark fluid, and there were hemorrhagic spots

in the mucosa. The liver was yellow and friable and the kidneys large and congested. There were no histological examinations.

No further cases suspicious of yellow fever were reported. It was decided to make a thorough study of the situation in the forested hinterland of the Golfo Dulce region on the Pacific slope, inland from the place in which the second case had occurred.

The investigation was considered especially necessary as the previous investigation in Costa Rica had been confined largely to urban communities and had not reached the forested regions. In the original immunity survey of Costa Rica 190 blood specimens were collected by Dr. D. M. Molloy from 1932 to 1934 in the cities of San José, Alajuela, Liberia, Puntarenas, and Puerto Limón and sent for examination to the laboratories of the International Health Division of The Rockefeller Foundation in New York. The results were included in the report published by Sawyer, Bauer, and Whitman (1937). There were no immunes among the 115 persons bled who were under 20 years of age, while there were 18 among the 75 older persons. Among the countries of Central America, Costa Rica and Panama stood out in the published report as the only ones in which immunes were not found in the age group 15 to 19 years.

Realizing the significance of the reports of suspected yellow fever, Dr. Peña Chavarría, then Secretary of Public Health and Welfare for Costa Rica, and Dr. Henry W. Kumm, of the International Health Division, made a field investigation in January 1939 and collected 133 blood specimens from three Boruca Indian communities in the region in which the deaths had occurred. These villages were Potrero Grande, Boruca, and Palmar. They are located in or near extensive tracts of virgin forest at elevations of 800 feet, 2,000 feet, and 100 feet, respectively. Specimens were taken only from persons who had always lived in the same locality and this restriction prevented obtaining more than 19 specimens from males over 15 years of age. The inhabitants were principally Indian, although some of the blood donors were mestizos. Some of the older Indians stated that they had often seen severe cases of fever, some of which were fatal in a few days and were characterized by jaundice and black vomit. No evidence of malaria was found in Boruca, but the disease was quite prevalent in Palmar. As in the case of the other investigations here reported, the specimens were sent to the laboratories of the International Health Division for examination. No evidence of immunity was obtained in any of the tests. The results are included in table 1. The locations in which blood specimens were collected are shown in figure 1.

Although the investigation seemed adequately to rule out the presence of yellow fever in the region in which the suspect cases had occurred, it was deemed advisable to make similar inquiries in other representative forested regions of Costa Rica. In the following year



Dr. Henry W. Kumm collected 70 blood specimens from the Guatuso Indians. They inhabit a forested region about equidistant from the Atlantic and Pacific Oceans near the northern frontier of Costa Rica, in the Province of Alajuela. As is seen in table 1 the protection test results were entirely negative. Dr. Kumm then completed the study by investigating 10 districts of the Talamanca Valley at the southeastern end of the Atlantic slope of Costa Rica. The number of specimens collected was 193 and the results are classified by age groups in table 1. The persons bled had never been out of the area. They

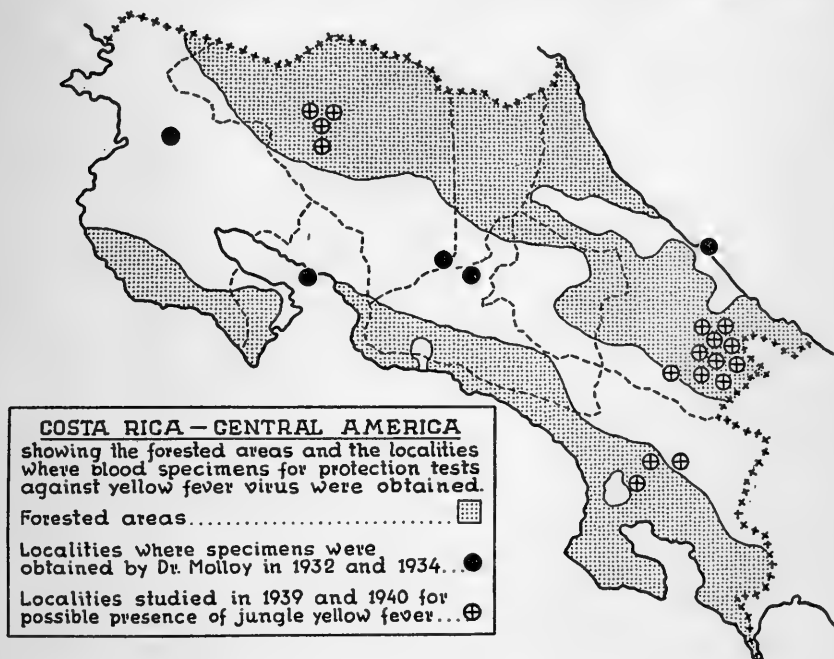

FIGURE 1.—Localities in Costa Rica where yellow fever immunity surveys were made in 1932-34 and 1939-40.

were mostly American Indians, although a few were listed as mestizos and were only partly of Indian blood. The blood from the Talamanca Indians was devoid of protective power against yellow fever.

The new evidence, when considered in relation to that which was previously collected, strongly suggests that yellow fever has not been present in Costa Rica for at least 20 years and that it had not been prevalent among the Indians of the forested regions of the interior during the lives of the present inhabitants. There is a possibility that these regions were never involved. The conclusion published in 1937 that yellow fever had probably not been present in Costa Rica since the epidemic of 1910 seems still to hold good.

TABLE 1.—Recent protection test results for sera collected from Panama and Costa Rica

Locality	Age groups of donors										Total for all age groups		Year specimens were collected
	5 to 9 years		10 to 14 years		15 to 19 years		20 to 24 years		25 years and over		Number tested	Percent positive	
	Number tested	Percent positive	Number tested	Percent positive	Number tested	Percent positive	Number tested	Percent positive	Number tested	Percent positive			
COSTA RICA													
Puntarenas Province, Boruca Indians:													
Potrero Grande	13	0	0	0	6	0	0	9	0	0	7	0	0
Boruca	11	0	0	0	8	0	0	5	0	0	9	0	0
Palmar	16	0	0	0	6	0	0	1	0	0	7	0	0
Total for Boruca Indians	40	0	0	0	20	0	0	15	0	0	23	0	0
1939 (Jan.)													
Alajuela Province, Guatuso Indians:													
Palenque La Margarita	11	0	0	0	5	0	0	1	0	0	5	0	0
Palenque El Tojiba	12	0	0	0	5	0	0	11	0	0	2	0	0
Palenque El Sol	0				3	0	0	1	0	0	2	0	0
San Rafael de Guatuso	0				1	0	0	0			0		
Total for Guatuso Indians	23	0	0	0	14	0	0	13	0	0	9	0	0
1940 (Mar.)													
Limón Province, Talamanca Indians:													
Amubre	16	0	0	0	4	0	0	5	0	0	21	0	0
Coen	1	0	0	0	0			4	0	0	7	0	0
Katsi	8	0	0	0	6	0	0	0			8	0	0
Kobri	2	0	0	0	0			0			0		
Total for Talamanca Indians	27	0	0	0	10	0	0	9	0	0	36	0	0
Total for all age groups	133	0	0	0	67	0	0	47	0	0	70	0	0
1940 (Mar.)													
Total for all age groups	133	0	0	0	67	0	0	47	0	0	70	0	0

Lari.....	3 0 0	2 0 0	6 0 0	3 0 0	13 0 0	27 0 0	
San José Cabecar.....	0	0	0 0 0	1 0 0	0	1 0 0	
Suretka.....	0	0	1 0 0	0	0	1 0 0	
Aito Urén.....	7 0 0	4 0 0	6 0 0	4 0 0	11 0 0	32 0 0	
Boca Urén.....	6 0 0	10 0 0	0 0 0	3 0 0	3 0 0	22 0 0	
Yorkin.....	7 0 0	5 0 0	3 0 0	1 0 0	7 0 0	23 0 0	
Total for Talamanca Indians.....	50 0 0	31 0 0	21 0 0	21 0 0	70 0 0	193 0 0	1940 (Apr.)
Total for Costa Rica.....	113 0 0	77 0 0	55 0 0	49 0 0	102 0 0	396 0 0	1939-40
PANAMA							
Darién Province:							
Yavisa and vicinity.....	50 0 0	53 2 1	13 0 0	0 0 0	1 0 0	117 1 9	1937
El Real de Santa María.....	8 0 0	26 3 1	5 0 0	1 0 0	0	40 1 2.5	1936
Yape.....	3 0 0	9 0 0	11 0 0	12 0 0	20 0 0	55 0 0	1936
Chagres River: Santa Rosa.....	32 0 0	24 0 0	0	0	0	56 0 0	1936
San Blas Indians:							
Sasardi.....	2 4 1	4 0 0	2 0 0	4 1 25	8 3 37	20 5 25.0	1936
Porto Gandi.....	0	0	1 0 0	1 0 0	15 5 33	17 5 29.4	1936
Nargana.....	0	0	1 0 0	3 0 0	8 4 50	12 4 33.3	1936
Tigre.....	0	1 0 0	0	4 2 50	6 3 50	11 5 45.5	1936
Total for Panama.....	95 1 1.1	117 2 1.7	33 0 0	25 3 12.0	58 15 25.9	328 21 6.4	1936-37

<sup>1</sup>Including one child aged 4.

<sup>2</sup>11 years old.

<sup>3</sup>12 years old.

<sup>4</sup>9 years old.

## FURTHER INVESTIGATIONS IN PANAMA

In the report by Sawyer, Bauer, and Whitman (1937) it was stated that no protective sera had been obtained in Panama from persons born after 1905, the date of the last recognized case, but that further investigation was in progress in the territory south of the Panama Canal Zone, a region which had not then been studied. Through the courtesy of Dr. Herbert C. Clark and Dr. Carl M. Johnson, of the Gorgas Memorial Laboratory, and Col. George R. Callender, of the Army Research Board, Panama Canal Zone, specimens were subsequently obtained from Darién Province, from the San Blas Indians, and from Santa Rosa on the Chagres River. The results are shown in table 1. Of the 149 children of Darién Province who were tested, two gave protective sera and were aged 11 and 12 years. None of the 56 Chagres River specimens from children protected. Of the six San Blas children tested one, aged 9, gave a protective serum. This serum was collected in 1936 and the evidence suggests that yellow fever was present at least as late as 1927. No conclusion as to the present existence of yellow fever there can be drawn except that it has not yet been shown to be present, but if yellow fever exists in Central America it will probably be found in this region of Panama close to South America. A cooperative program including viscerotomy, protection tests, and supplementary studies in this region has been arranged between the government of Panama and the International Health Division, and ultimately it should be known whether the virus is actually present.

## JUNGLE FEVER IN SOUTH AMERICA

The reports of Soper (1937, 1938) on the studies of jungle yellow fever in South America leave little to be added here. An important recent observation was made by Shannon, Whitman, and Franca (1938), who demonstrated that wild-caught forest-inhabiting mosquitoes of Brazil of the species *Aedes leucocelaenus* and *Haemagogus capricornii* contained yellow fever virus and were capable of infecting rhesus monkeys by biting. The epidemiology of jungle yellow fever is not yet completely known. The infection is transmitted by some vector, or perhaps several, peculiar to the uncleared forest, and it is probable that animals other than man and monkeys are involved in the transmission cycle. The infection may be endemic in the sense of being continuously or frequently present in an area, as for example in the vicinity of Muzo, Colombia, or it may be sharply epidemic. In the latter case, the infection appears at times to invade new territory and probably to disappear from previously infected areas.

Soper (1938) has described a progressive epidemic, or series of seasonal epidemics, which was first observed in 1934 at Coronel Ponce in

Matto Grosso in the center of Brazil, and which has since then progressed eastward, then southward, and again eastward in warm-season outbreaks through the states of Goiaz, Minas Geraes, São Paulo, and Rio de Janeiro. This year the epidemic was manifest in Espirito Santo, still farther to the east, and cases were found farther to the south in the states of Paraná, Santa Catarina, and Rio Grande do Sul. It seemed quite probable that in the far south, territory had been invaded which had previously been entirely free of the disease, for yellow fever had not been reported in Rio Grande do Sul during the last decade. As the principal epidemic advanced to new territory, the area involved during the previous years became almost free of cases, probably largely on account of natural immunization of available animals and men and partly as the result of preventive vaccination of a considerable proportion of the population.

In Colombia, where jungle yellow fever is being studied by Dr. H. H. Smith and his associates in the yellow fever service maintained cooperatively by the government and the International Health Division, a shift of the involved territory has also been observed. Dr. Smith reports that an epidemic of jungle yellow fever has appeared recently in areas to the west of the Magdalena River in the states of Caldas and Antioquia, where cases had not previously been observed. This outbreak is being studied. At the same time, it is becoming apparent that jungle yellow fever has largely disappeared from the region around Villavicencio, where there were epidemic conditions in 1934 and where a field laboratory has been built to study the disease. Cases were diagnosed in the general region of Villavicencio each year from 1934 to 1938, but in spite of careful observations no case of yellow fever has been found in that area since August 1938. Even animals with protective sera are being found less frequently in this region than formerly, and studies with sentinel animals exposed in the jungle, and protection tests on young wild animals have led to the belief that active virus is not now present in the area.

#### THE USE OF VACCINATION IN PREVENTING THE SPREAD OF YELLOW FEVER

The present yellow fever situation on which control measures must be based may be briefly summarized. There appears to be no yellow fever outside South America, unless possibly close to South America in Panama. There have been no recognized urban outbreaks of *aegypti*-transmitted yellow fever in South America for several years. Jungle yellow fever occurs continuously in endemic form or as wandering epidemics in a vast area involving the greater part of the Amazon watershed and extending into the interior of Colombia and the hinterland of other countries.

The first obvious control measure has already been mentioned. Cities in South America or elsewhere which are threatened with invasion by yellow fever from the jungle areas should keep themselves noninfectible by the well-known methods of *aegypti* control. There still remains to be considered the more direct control of jungle yellow fever itself.

Jungle yellow fever is very widely distributed in sparsely inhabited regions and is seldom revealed except when a considerable number of susceptible persons are present and become infected. *Aedes aegypti* control is inapplicable because that mosquito is not involved. The suppression of other vectors is at present impracticable because it is not known what insects play the dominant role in transmission, and it seems improbable that thorough and widespread insect control will be possible in the jungle areas. Extermination of the infection is obviously impossible at present. The prevention of disease in human beings through widespread vaccination becomes our only practical means of keeping the people of the region noninfectible.

Large-scale yellow fever vaccination has been applied mostly to stop an existing epidemic or immunize against an expected one. The effective use of vaccination on a large scale in Brazil for such purposes has been described by Soper and Smith (1938b). In Colombia, in the absence of such large sweeping epidemics, much thought is being given to the immunization of selected communities for the purpose of preventing the possible future spread of nearby jungle yellow fever through them. At the same time, vaccination is being made available to the people, usually relatively few in number, under actual exposure in the jungle areas. Even this is an important measure to prevent the spread of yellow fever, for it is the nonimmune working in the jungle who will become infected and bring yellow fever into the towns and cities. The need is for the intelligent mapping of the campaign against yellow fever, using both *aegypti* control in the cities and vaccination at strategic points, which are obviously our most effective present safeguards against surprise invasion of our cities and our commerce by yellow fever.

To use vaccination effectively and on a large scale it is necessary to have available a vaccine which is both safe and effective. The vaccine in use in the Americas is known as 17D. Its safety and efficiency have been up to expectations, as is shown by the report of Soper and Smith (1938b), but experience has shown that eternal vigilance will be needed to keep this living vaccine at a low level of virulence and free from contaminating viruses and at the same time to avoid any fall in immunizing power.

Much has been done to improve the vaccine since Sawyer, Kitchen, and Lloyd (1932) began vaccinating human beings effectively with

yellow fever virus adapted to mice and human immune serum. The original method could be used only on a small scale on account of the difficulties of obtaining enough of the immune serum. Through years of patient research the virulent Asibi strain was so modified through tissue culture by Lloyd, Theiler, and Ricci (1936) and Theiler and Smith (1937) that its lowered virulence made possible its use without serum. At the same time, the use of chick embryo tissues in place of the brains of living mice in producing the vaccine reduced the risk of the introduction of unknown pathogenic viruses, thus increasing the element of safety. After the experience of Findlay and MacCallum (1937) and Soper and Smith (1938a) with delayed infections characterized by jaundice after yellow fever vaccination with tissue culture material, used in the latter case along with hyperimmune serum, the possibility of the introduction of an unknown virus into the vaccine from the blood of apparently healthy human donors became a matter of concern. As a result, human serum used in the tissue cultures is now being inactivated with heat.<sup>2</sup> Any reports of jaundice or other symptoms following vaccination are being carefully investigated. One such report in 1939 is still under study in Brazil to find out its possible relationship to the vaccine. With the present precautions the tissue culture vaccine 17D would seem to have as high a degree of safety for the vaccinated person as could be expected of a biological product containing a living virus. That the infection is not likely to be spread from vaccinated persons to others through the medium of mosquitoes and finally to revert to a more virulent form has been shown by the studies of Roubaud and his associates (1937) and Whitman (1939).

As to the effectiveness of the vaccine made from strain 17D, there has been much recent evidence. Reports by Smith, Penna, and Paoliello (1938) and by Soper and Smith (1938b) showed a high percentage of immunes among vaccinated persons whose blood was afterward tested by the mouse-protection test. At the end of 1938 and early in 1939, however, the results with certain lots of vaccine were not so happy, as reported by Soper, Smith, and Penna (1940). While 90 percent of persons tested after vaccination earlier in 1938 had developed protective antibodies in their blood, and field experience in the presence of epidemics had suggested that vaccinated groups were protected against natural infection as early as 1 week after the inoculation, a considerable number of persons vaccinated at the time mentioned and later exposed to an anticipated epidemic developed yellow fever. Among 136,000 persons vaccinated with 15 different lots of vaccine, there were 56 cases and 14 deaths from 7 days to 14

---

<sup>2</sup>Subsequent to the presentation of this paper there has been further observation of jaundice after vaccination against yellow fever, and methods have been perfected and adopted for completely omitting normal human serum in manufacture.

months after vaccination. Groups vaccinated with certain lots of vaccine showed absence of demonstrable protective antibodies in from 50 to 80 percent of the cases. Investigation showed that the ineffective lots of vaccine contained living virus which had undergone over 309 passages in tissue culture, while the virus previously used so successfully had been passaged only from 229 to 255 times. It was necessary to test and revaccinate many persons for their protection. There seemed to have been a qualitative change in the virus which resulted in a drop in its antigenicity. Whether this was directly due to an excessive number of passages is being subjected to experimental test in Colombia and the International Health Division Laboratories in New York, as well as in Brazil. The return to lower passage material has again brought satisfactory results. To prevent the recurrence of this episode, new lots of vaccine in Brazil are being used first in vaccinating small groups of persons whose serum must pass a rigid test for protective antibodies before the lot is sent into the field for use.

In simplest terms, the outstanding features of the yellow fever situation in the Americas are: (1) absence of definite outbreaks of urban, *aegypti*-transmitted yellow fever anywhere; (2) absence of recognized yellow fever of any transmission type outside of South America; (3) jungle-transmitted yellow fever, endemic and as migrating epidemics, in wide areas of the interior of South America; (4) effective methods for keeping cities noninfectible through *aegypti* control; and (5) a safe and effective way to immunize against yellow fever and prevent its spread from the jungle to infectible cities.

#### LITERATURE CITED

- FINDLAY, G. M., and MACCALLUM, F. O.  
1937. Note on acute hepatitis and yellow fever immunization. *Trans. Roy. Soc. Trop. Med. and Hyg.*, vol. 31, p. 297.
- LLOYD, W., THEILER, M., and RICCI, N. I.  
1936. Modification of the virulence of yellow fever virus by cultivation in tissues *in vitro*. *Trans. Roy. Soc. Trop. Med. and Hyg.*, vol. 29, p. 481.
- ROUBAUD, E., STEFANOPOULOU, G. J., and FINDLAY, G. M.  
1937. Essais de transmission par les stégomyies du virus amaril de cultures en tissu embryonnaire. *Bull. Soc. Path. Txot.*, vol. 30, p. 581.
- SAWYER, W. A.  
1939. Yellow fever. *Oxford Medicine*, vol. 5, p. 731.
- SAWYER, W. A., BAUER, J. H., and WHITMAN, L.  
1937. The distribution of yellow fever immunity in North America, Central America, the West Indies, Europe, Asia, and Australia, with special reference to the specificity of the protection test. *Amer. Journ. Trop. Med.*, vol. 17, p. 137.
- SAWYER, W. A., KITCHEN, S. F., and LLOYD, W.  
1932. Vaccination against yellow fever with immune serum and virus fixed for mice. *Journ. Exp. Med.*, vol. 55, p. 945.



SHANNON, R. C., WHITMAN, L., and FRANCA, M.

1938. Yellow fever virus in jungle mosquitoes. *Science*, vol. 88, p. 110.

SMITH, H. H., PENNA, H. A., and PAOLIELLO, A.

1938. Yellow fever vaccination with cultured virus (17D) without immune serum. *Amer. Journ. Trop. Med.*, vol. 18, p. 437.

SOPER, F. L.

1937a. The geographical distribution of immunity to yellow fever in man in South America. *Amer. Journ. Trop. Med.*, vol. 17, p. 457.

1937b. Present-day methods for the study and control of yellow fever. *Amer. Journ. Trop. Med.*, vol. 17, p. 655.

1938. Yellow fever: The present situation (October, 1938) with special reference to South America. *Trans. Roy. Soc. Trop. Med. and Hyg.*, vol. 32, p. 297.

SOPER, F. L., PENNA, H., CARDOSO, E., SERAFIM, J., Jr., FROBISHER, M., Jr., and PINHEIRO, J.

1933. Yellow fever without *Aedes aegypti*. Study of rural epidemic in the Valle do Chanaan, Espirito Santo, Brazil, 1932. *Amer. Journ. Hyg.*, vol. 18, p. 555.

SOPER, F. L., and SMITH, H. H.

1938a. Yellow fever vaccination with cultivated virus and immune and hyperimmune serum. *Amer. Journ. Trop. Med.*, vol. 18, p. 111.

1938b. Vaccination with virus 17D in the control of jungle yellow fever in Brazil. *Trans. Third Int. Congr. Trop. Med. and Malaria*, vol. 1, p. 295.

SOPER, F. L., SMITH, H. H., and PENNA, H.

1940. Yellow fever vaccination: field results as measured by the mouse protection test and epidemiological observations. *Proc. Third Int. Congr. for Microbiol.*, Sept. 2 to 9, 1939, p. 351.

THEILER, M., and SMITH, H. H.

1937. The effect of prolonged cultivation *in vitro* upon the pathogenicity of yellow fever virus. *Journ. Exp. Med.*, vol. 65, p. 767.

WALCOTT, A. M., CRUZ, E., PAOLIELLO, A., and SERAFIM, J., Jr.

1937. An epidemic of urban yellow fever which originated from a case contracted in the jungle. *Amer. Journ. Trop. Med.*, vol. 17, p. 677.

WHITMAN, L.

1939. Failure of *Aedes aegypti* to transmit yellow fever cultured virus (17D). *Amer. Journ. Trop. Med.*, vol. 19, p. 19.

WHITMAN, L., and ANTUNES, P. C. A.

1938. The transmission of two strains of jungle yellow fever virus by *Aedes aegypti*. *Amer. Journ. Trop. Med.*, vol. 18, p. 135.

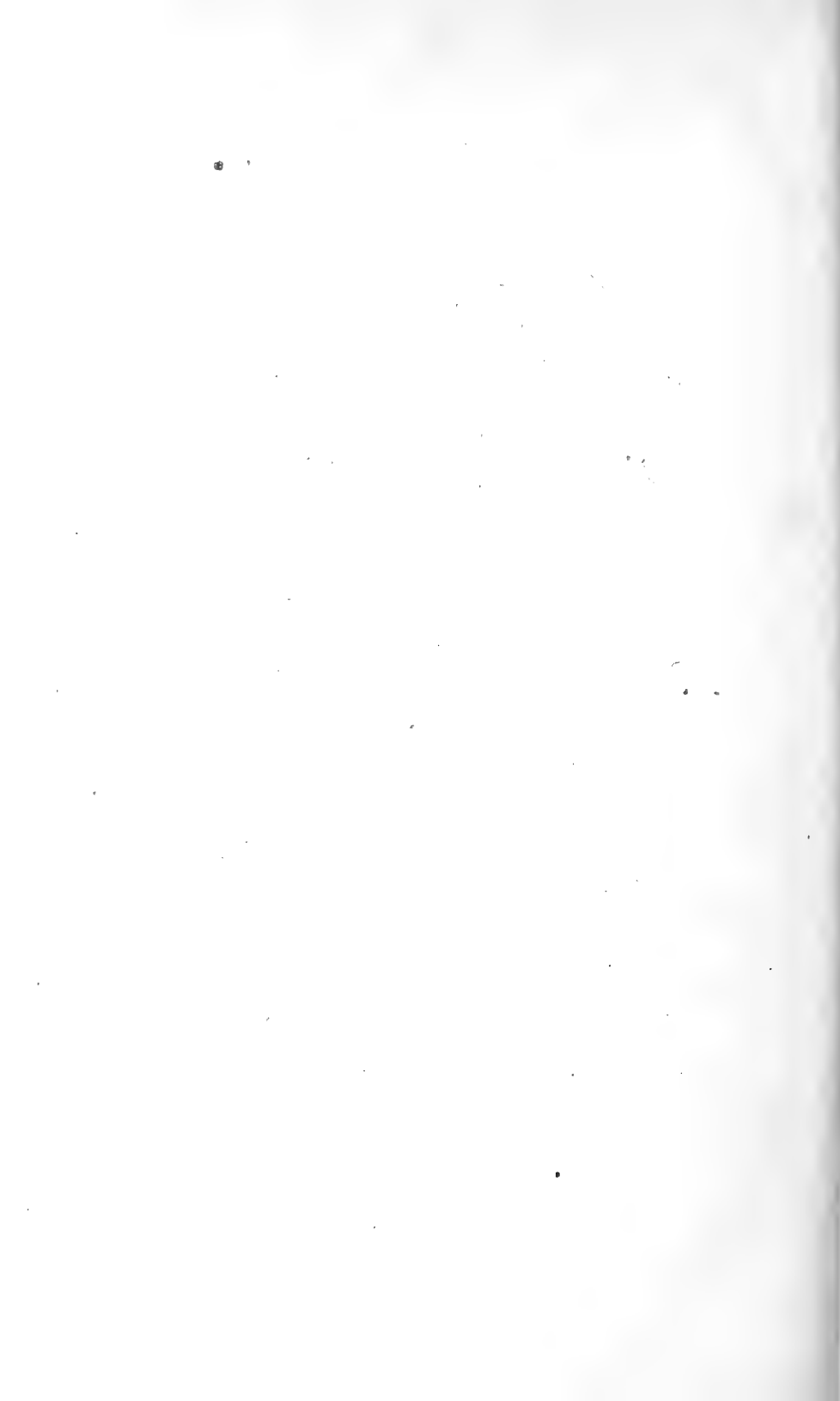

## SOME FOOD PROBLEMS IN WARTIME <sup>1</sup>

---

By GEORGE R. COWGILL  
*Yale University*

---

As a result of the war, communities all over the Nation are finding their young men in the armed forces serving as representatives in almost every part of the world. Consider, for example, a group of men from your own community. One of them may be in an artillery unit hidden in the jungles bounding the Panama Canal. Another may be doing guard duty in Iceland. A third "joined the marines" to see action, and has seen it in the Solomon Islands of the South Pacific. A fourth received training as a mechanic for servicing airplanes and eventually found himself in an air squadron suddenly assigned to duty in North Africa.

Before the war, all these boys were exposed to a reasonably uniform set of influences, social, climatic, and otherwise. Their habits of eating are a reflection of family training, racial background, the kinds of foods readily available in their community, and related factors. Now that they are in the service, will their diet be quite different from that to which they have been accustomed? Will it vary according to the part of the world in which they are serving? These are some of the questions that will occur to their parents and friends.

The planned feeding of our armed forces today affords a marked contrast to that of the days of 1914-18. Between 1900 and about 1910 it was considered that any combination of foods that furnished enough energy, protein, certain mineral nutrients like calcium for the bones, and iron for the blood would meet the requirements of good nutrition. Today if a student of this science attempts to list individually all of the specific factors known to be important for nourishing the body, he must mention approximately 40 items, the exact number depending upon whether certain claims for existence of new vitamins are to be regarded as acceptable or not. We are much closer now than our predecessors ever were to being able to write a *complete* list of factors required. A rough classification of them would be as follows: (a) food energy, measured in calories; (b) protein; (c) mineral

---

<sup>1</sup> Reprinted by permission from the Yale Review, Winter, 1943. Copyright, Yale University Press.

nutrients; and (*d*) vitamins. In addition to knowing that these many factors are necessary, we also have at hand some information bearing on the question of how much food the average person needs, and the factors that may change that requirement. Although at the present time we do not know all we should like to know about the requirements of certain dietary essentials, such as vitamins B<sub>1</sub> and B<sub>2</sub>, we already have a body of knowledge sufficiently large to warrant interesting applications not merely to a civilian peace-time population but an ever-growing armed force as well. All this information has been used in planning the commissary of our armed forces. In other words, the modern science of nutrition enables us to deal with this new worldwide food problem in far more effective fashion than was ever before possible.

For about 10 years, the Chicago Quartermaster Depot of the United States Army has maintained what is called the Subsistence Research Laboratory devoted to the application of this modern knowledge in the practical solution of army food problems. The older standard rations have been examined in the light of the new developments and appropriate changes made. Numerous new rations designed to fit special situations in the field have been devised. The question whether the good standard army-post ration in common use in this country, known to contain ample supplies of vitamins and other essential factors, would be improved by supplementation with vitamin tablets has been put to scientific test with soldiers under properly controlled experimental conditions. The answer to this particular question proves to be negative. It does not necessarily follow from this that the provision of an unusual and extra supply of one or more vitamins to soldiers never serves any useful purpose. As yet too few of the special work situations of interest have really been investigated from this point of view. In another study, carried out in a university laboratory, where men subjected themselves to extreme muscular work to the point of exhaustion, it was found that their endurance of, and ease of recovery from, the severe strain was related to their receiving daily a liberal supply of a natural source of the vitamin B complex (such as dried yeast); daily administration of a supply of vitamin B<sub>1</sub> alone was not as effective. In still another study, evidence has been obtained that two of the most recently discovered members of the vitamin B complex are of some importance in relation to muscular fatigue and recovery from vigorous exercise. Numerous investigations relating to this general problem are being carried on in the laboratories of the country as part of our research contribution to winning the war.

Earlier in this article the factors important in nutrition were classified. The first one to be mentioned was energy. The need for

this factor has long been known. It was the first to receive thorough scientific investigation. At the risk of seeming to emphasize the obvious, I must summarize briefly important facts centering around food energy. Failure to "eat sufficient calories" results in loss of body weight because the energy cost of living cannot be dodged, and therefore the body consumes its own tissues in order to secure the needed energy. Conscious and planned reduction in consumption of calories as a means of reducing weight is the scientific basis for the so-called Hollywood diet by which one "eats to get thin." The amount of energy required by a normal individual is related to his age, sex, body size, and amount of muscular exercise, this last named being most variable and perhaps the most significant of all the factors listed.

The layman frequently asks whether mental effort or "strain" has an energy cost. In discussing this topic, one must distinguish between the energy cost of the special activity of brain cells associated with intense cerebration and the energy demands due to emotional reactions which involve greater muscular activity. It has proved impossible to measure the energy cost of the mental effort involved in studying for an examination, for example; it doubtless exists but is so small a fraction of the total energy exchange of the body that it cannot be measured by the methods used hitherto. On the other hand, emotional reaction or "strain" that brings about greater muscular activity, more intense application to a task requiring muscular effort or activity of a different sort, is thereby associated with a greater energy exchange; in this situation it is obvious that the energy cost being measured is quite definitely related to greater activity of the muscles.

Measurements have been made of the energy costs of various occupations, and the results have constituted the basis of numerous tables published in standard texts. Of course, the energy cost of the soldier's life needs investigating, and such studies have in fact been made. The results of these investigations have been utilized in the formulation of special rations intended for use in special situations.

In these days of modern mechanized warfare, the troops may move very fast, and it is not always practical for the mess sergeant and cook to set up the old-style traveling kitchen. A food that is concentrated, readily digested, nutritionally complete, easily eaten, and packaged in a way that permits rough handling in the field, is the ideal aimed at for this warfare. Such a ration has been devised. It has been tested on the members of the Subsistence Research Laboratory and also in the field, in mountainous country and in the desert, and it has been judged satisfactory. For example, Field Ration K is a three-meal package of concentrated food furnishing 3,726 calories and packed in a heat-and-cold-proof box, 6 by 6 by 4 inches. The

breakfast package furnishes enriched biscuits, compressed graham crackers, veal, a fruit bar, malted milk dextrose tablets, soluble coffee, sugar, chewing gum, and four cigarettes. The contents of the dinner package are much the same with the addition of powdered bouillon but without coffee or fruit bar. For supper the allowance is biscuits, cheese, chocolate bar, fruit-juice powder, sugar, chewing gum, and cigarettes. Gum is included because its chewing promotes the flow of saliva, thus keeping the lining of the mouth moist, and this seems to reduce the consumption of water. In field trials of the rations, cigarettes were found to have value in promoting morale.

People frequently ask the professional nutritionist whether armed forces fighting in various parts of the world have different food requirements according to the climate in which they find themselves, or to other factors peculiar to their respective regions. Must the soldier in Iceland be fed differently from his comrade in Morocco?

The observation that marked differences in food habits characterize the inhabitants of different parts of the globe may suggest to some laymen that the nutritive needs of these widely distributed people are correspondingly different, and, therefore, in the feeding of our armed forces, differences in requirements seemingly related to regions should be considered. Students of nutrition agree that such an interpretation of the fact of variety in food habits is erroneous. The kinds of foods eaten by any group of people constitute a reflection of economic factors, such as availability and relative cost, and socioreligious factors involving established customs, taboos, religious training, and the like. Naturally, foods that are readily produced in a given area will predominate in the dietaries of the inhabitants of those areas over foods that must be imported.

If differences in food habits do not mean differences in fundamental nutritive requirements of different places, it follows that a basic ration, with perhaps minor modifications, could serve for all troops regardless of where they are. All soldiers will need enough calories to meet the energy costs of their respective activities. The soldier in Iceland will have to face the problem of greater heat loss to the environment and will solve this very largely through the use of warmer clothing and heated quarters. The soldier in Libya will dress so as to facilitate loss of body heat to environment. It is quite possible that the soldier in Iceland will eat a few more calories daily than his comrade in Libya depending upon the severity of the cold weather and the care taken to conserve heat through proper clothing.

The soldier in Libya, and particularly his comrades in the humid Tropics, will have another problem to face: that due to the greater sweating caused by the warmer climates. It is known that workmen in steel mills and other industrial plants whose activities result in

profuse sweating may lose so much salt through the sweat as to develop muscle cramps and pains; the administration of tablets of table salt has been found to be the remedy here, and has become an established practice in industrial medicine. Recently it has been learned that appreciable amounts of various water-soluble vitamins may also be lost from the body by way of sweat. Just how significant this loss can be, remains to be determined by research directed to this specific end. For the present any bearing that this fact may have on the soldier's need for vitamins can doubtless be met by having the basic ration contain amounts of these factors that are really liberal and appreciably greater than the known minima.

Conditions in the Tropics have played an interesting role in determining some of the specifications of certain emergency rations, such as, for example, an experimental chocolate bar designed to be carried in the soldier's shirt pocket, and to be eaten only as a last resort when separated from the troop unit. The size of the bar was determined by the dimensions of the shirt pocket. One specification was that the bar remain solid at 120° F., so that the bar would not melt in the pocket under tropical conditions and thus become impossible to eat. When a committee of scientific advisers sampled numerous bars submitted in response to the advertised specifications, some of the members rated certain bars unfavorably on the ground of poorer taste, and were surprised to learn from the Quartermaster representative that a delectable bar was not desired because it was intended to serve as an emergency ration; if its taste was too good, it would be eaten too soon and thus be unavailable when the emergency finally occurred.

The selection of foods for aviators is not without its special problems. One that might be mentioned here is the advisability of avoiding foods that readily produce gas. When the pilot and his crew rise to high altitudes, gases expand in corresponding degree; if much gas is present in the alimentary tract, its expansion can cause considerable discomfort.

Because we as a nation have been peace-loving, and have not over a period of years planned intensively for the waging of offensive war, the food problems mentioned thus far have received our concentrated attention only comparatively recently. The Axis nations, particularly Germany and Japan, went into the present war with the soldier relatively well equipped for blitz tactics, jungle fighting, and the like. The individual Japanese soldier carries a remarkable equipment suited for penetration of the jungle. As far as our knowledge goes, this equipment includes rice and certain other dry foods valuable in supplementing rice with the nutritive factors it lacks.

For some years, Dr. T. Saiki, Director of the Imperial Institute of Nutrition in Tokyo, concentrated on the problem of finding new but

cheap food resources with which to feed the Japanese masses who are extremely poor. Into various sections of the country went young students and research workers from Saiki's laboratory to study the food values of literally everything edible in those areas, including weeds, numerous insects, and other forms of life hitherto unused as human food. One result of the knowledge thus gained was that nutritionally adequate diets for the masses could be secured for a cost as low as 5 cents a day.

As a result of the war, the shipment of silk to this country was stopped. Other uses for the silkworm have been found however. Recently it was learned that the silkworm cocoon contains a significant amount of vitamin B<sub>1</sub>. This is now being extracted and used as a food. There can be no doubt that the information gained through Dr. Saiki's activities is now being applied by the Japanese militarists in providing the soldiers and sailors with the food needed for them to carry on. Because the Japanese masses have long been accustomed to simple and cheap fare, it is probably relatively easy for the Japanese soldier to adjust to his special field rations.

The bulk of a ration cannot be reduced below a certain amount if a desired number of calories is to be furnished. This point is not always appreciated by the layman. Food energy is derived from protein, carbohydrate, and fat, the first two of which yield 4 calories per gram in contrast to fat which furnishes 9 calories per gram. The "average man" weighs 154 pounds (70 kilograms) and requires 3,000 calories per day. To secure this number of calories from the most concentrated source available—fat—333 grams (roughly three-quarters of a pound) are required. However, man develops ketosis when fat furnishes more than about one-half of the energy. Calories from carbohydrate are required to prevent this. Therefore the 333 grams of fat must be diluted with some carbohydrate; still more dilution is necessary in order to secure needed protein, mineral nutrients, and vitamins.

This question of bulk has assumed great importance recently. In natural foods, the various dietary factors may be greatly diluted with water. Seeds like the cereal grains and legumes, and special products made from them, like baked goods, are concentrated foods which are low in water content in contrast to muscle tissue, for example, which has from 70 to 80 percent water, and a food like canned tomatoes which contain over 95 percent water. In the early days of its work in this country, the British Food Commission bought large quantities of water-rich foods like canned tomatoes for shipment to England. This meant using a large part of the available space for shipping the water contained in these foods. As a result of the sinking of so many ships, it has become necessary to make the best possible use of all avail-



able shipping space. Elimination of the water present in many foods by commercial dehydration processes has thus assumed tremendous importance.

The dehydrated-food industry is expanding at a most rapid rate. This expansion has been so great and is so important that the Government has established a school at which interested industrialists may learn the dehydration processes that have been perfected and how a given industrial plant may therefore be converted to the dehydration of one or more foods.

Some idea of what the saving in shipping space can be as a result of dehydration can be gained from the following: A ship's ton of canned boiled potato furnishes only 920 pounds of potato. The same ship's ton of dehydrated potato, when reconstituted by the addition of water, supplies 3,980 pounds of this vegetable. Dehydrated foods as prepared for shipment take, on an average, only about one-sixth the cargo space required for shipments in nondehydrated or natural form. Another fact of particular interest is that many dehydrated foods, dry skim milk and eggs, for example, can be packed in nonmetal containers thus saving tin, the supply of which is dangerously low.

Over a period of years, many important foods have proved to be very difficult to dehydrate satisfactorily; recently, as a result of intensive experimentation, they have yielded to the laboratory in this respect, and can now be used not only in economical shipments abroad as food for civilian populations but as ingredients of concentrated rations for the armed forces. Meat is a good example of this. Dried soup stocks of known nutritive value have also been made from which tasty soups may be prepared by the mere addition of water. One food concern recently announced that it had finally succeeded, after much laboratory experimentation, in drying ham-and-eggs. With such a product it becomes possible to provide the American soldier with this traditional reminder of breakfast at home regardless of where he may happen to be.

In our American approach to the food problem we have not gone so far in developing entirely new food resources as Saiki has done in Japan. However, a survey has revealed that there are many valuable foods in this country not now being used in the quantities that their nutritive values warrant. A few examples are skim milk powder, peanut meal, products of the soybean, pig liver, and dried yeast. The oil of the peanut is squeezed out and used in soap making, and the manufacture of munitions and other products; the meal residue, valuable as a source of protein and certain vitamins, could well be used more as a food by man. It has already proved possible to make a tasty bread containing as much as 20 percent peanut flour. Skim milk powder is an especially valuable product that is used to some

extent as an ingredient in making certain human foods but to a much greater extent as a component of feed for livestock. Greater use of it by our housewives would improve significantly the nutrition of our people. In certain industries devoted to the production of special substances from animal tissues, such as antianemic principle from liver and insulin from pancreas, the tissue residues remaining from such processing have been largely regarded as almost worthless. Recent tests on animals of these materials for their nutritive value have revealed qualities quite unsuspected and such as to give them high ratings as foods. The successful introduction into our American dietaries of these various valuable but at present little-used foods will doubtless require education of the consumer concerning relative food values and the role that these unappreciated foods may play in meeting nutritive needs. Even if such an educational campaign should prove only moderately successful in the so-called pellagra areas of the South, for example, this would be significant in combating the pellagra problem.

Many of these valuable but little-used foods are now being utilized in special army rations, dried soup stocks, and the like, and are thus finding their way into the feeding of the armed forces as well as the war-torn populations reached by the International Red Cross. If such products prove successful, it is not unreasonable to suppose that they will find a place in the national dietary after the war in serious competition with the present established staples. No one can really say what the future holds in store for us in this field. This much is certain: the war has precipitated a great deal of valuable research in the development of new foods.

It is to be expected that we shall do all that is possible to feed our armed forces scientifically wherever they may be placed in this global war. On the home front, we have the problem of producing enough of the various basic food supplies to meet the need not only of the armed forces but our home population and that of the Allied nations. It does not suffice merely to produce these foods; when they are to be shipped around the world, they must be concentrated and otherwise processed so as to enable such shipment to be made with the minimum required space. Some foods like skim milk powder and cheese are both highly concentrated and of high nutritive value, and thus have a superior rating in relation to this particular situation.

We may, therefore, receive from time to time from our Secretary of Agriculture and other responsible officials recommendations that we on the home front eat less of certain foods and more of others, in order to release particular foods for shipment abroad. Certain foods are now being rationed for various reasons, and we may expect many others to be sooner or later. The consumer should welcome this pro-

cedure as an indication of careful planning toward solution of the basic problem.

It seems obvious that a successful attack on this phase of our general problem involves the education of every citizen in the principles of nutrition and dietetics—how to select the good diet, how to think practically of food energy, protein, minerals, and vitamins in terms of common foods, classes of foods from which substitutes may be selected when we are told to conserve some foods, how to “pack a lunch a man can work on,” and kindred topics. A program for accomplishing this has been formulated. Through the nutrition division of the Office of Defense Health and Welfare Services in Washington a national nutrition program has been organized that has in it a place for everybody—food producer, wholesaler, retailer, consumer, advertiser, and all the agencies for influencing public opinion. State and local nutrition committees have been established throughout the nation. Through these committees and the Red Cross, nutrition classes have been organized in such a way as to touch nearly every home in the land. Today every citizen has ample opportunity to learn how, through selection of food, he can in simple fashion make a very important contribution and adjustment to this problem of properly utilizing our food resources in order to win the war.

#### REFERENCES

Those who wish to read further on this subject will find much of interest in the following recent publications:

BLACK, J. D., and COLLABORATORS.

1943. Nutrition and food supply: the war and after. *Ann. Amer. Acad. Polit. and Soc. Sci.*, vol. 225, January.

FEDERAL SECURITY AGENCY.

1942. A series of eleven lectures delivered in the U. S. Department of Agriculture Auditorium, Washington, D. C., March 11-15, 1942. Publ. of Office of Defense Health and Welfare Services.

INTERNATIONAL LABOUR OFFICE, MONTREAL, CANADA.

1942. Food control in Great Britain. *Studies and Reports*, ser. B. (economic conditions), No. 35, March.



# INDEX

---

## A

	Page
Abbot, Charles G., Secretary of the Institution.....	vii, xi, 10, 12, 25, 76, 99
Administrative assistant to the Secretary (Harry W. Dorsey).....	vii
Administrative staff.....	x
Aldrich, Loyal B.....	xi, 76
Andrews, A. J.....	viii
Arab village community of the Middle East, The (Tannous).....	523
Areal and temporal aspects of aboriginal South American culture (Cooper).....	429
Armstrong, E. F. (The sea as a storehouse).....	135
Artists for Victory, Inc.....	30
Assistant Secretary of the Institution (Alexander Wetmore).....	vii, 24
Associate Director of the National Museum (John E. Graf).....	vii
Astrophysical Observatory.....	xi, 9, 75
Division of Astrophysical Research.....	75
Division of Radiation and Organisms.....	75
Field observatories.....	9, 75
Personnel.....	76
Report.....	75
Staff.....	xi
Attorney General (Francis Biddle, member of the Institution).....	vii
Awl, Aime M.....	viii

## B

Barkley, Alben W. (regent of the Institution).....	vii, 10
Barnes, J. T.....	viii
Bartsch, Paul.....	viii, ix
Bassler, R. S.....	ix
Beach, Jesse G.....	ix
Beals, Ralph L.....	4, 51
Belin, Ferdinand Lamot, Vice President, National Gallery of Art.....	x, 25, 26, 34
Belote, T. T.....	ix
Bent, Arthur C.....	viii
Biddle, Francis, Attorney General (member of the Institution).....	vii
Biological effects of solar radiation, Some (O'Brien).....	109
Bishop, Carl Whiting (Origin of Far Eastern civilizations: A brief hand- book).....	463
Blackwelder, R. E.....	viii
Borie, Charles L.....	6, 35
Boss, Norman H.....	ix
Böving, A. G.....	ix
Brown, W. L.....	viii
Bruce, David K. E., President, National Gallery of Art.....	x, 25, 26
Bryant, H. S.....	x
Buchanan, L. L.....	viii
Bush, Vannevar (regent of the Institution).....	vii, 10, 95

## C

Cairns, Huntington, Secretary-Treasurer and General Counsel National Gallery of Art.....	x, 25
Cannon, Clarence (regent of the Institution).....	vii, 10, 95
Carey, Charles.....	ix
Carriker, M. A., Jr.....	21
Cassedy, Edwin G.....	x, 55

	Page
Chancellor of the Institution (Harlan F. Stone, Chief Justice of the United States).....	vii, 10
Chapin, Edward A.....	viii
Chase, Agnes.....	viii
Chemotherapeutic agents from microbes (Weintraub).....	545
Chief Justice of the United States (Harlan F. Stone, Chancellor of the Institution).....	vii, x, 10, 25
Clark, Austin H.....	viii
Clark, Bennett Champ (regent of the Institution).....	vii, 10
Clark, Leila F., librarian of the Institution.....	vii, 81
Clark, Leland B.....	xi
Clark, Robert Sterling.....	ix
Cochran, Doris M.....	viii
(Dangerous reptiles).....	275
Cole, William P., Jr. (regent of the Institution).....	10
Collins, H. B., Jr.....	x, 8, 51
Commerford, L. E.....	x
Compton, Arthur H. (regent of the Institution).....	vii, 10
Congdon, Charles E.....	52
Conger, Paul S.....	viii
Contours of culture in Indonesia (Kennedy).....	513
Cook, O. F.....	viii
(Natural rubber).....	363
Cooper, Gustav A.....	ix, 21
Cooper, John M. (Areal and temporal aspects of aboriginal South American culture).....	429
Cowgill, George R. (Some food problems in wartime).....	591
Cox, Edward E. (regent of the Institution).....	vii, 10
Cross, Whitman.....	ix
Cushman, Joseph A.....	viii
Cushman, Robert A.....	viii

## D

Dale, Chester, Associate Vice President, National Gallery of Art.....	x, 31
Dangerous reptiles (Cochran).....	275
Davis, Harvey N. (regent of the Institution).....	vii, 10
Davis, Leonard E.....	50
Deardorff, M. H.....	52
Deignan, H. G.....	viii
Delano, Frederic A. (regent of the Institution).....	vii, 10, 95
Densmore, Frances.....	8, 53
Desch, C. H. (New metals and new methods).....	213
Director of the National Museum (Alexander Wetmore).....	vii, 24
Dorsey, Harry W., administrative assistant to the Secretary.....	vii
Dorsey, Nicholas W., Treasurer of the Institution.....	vii, x
Drucker, Philip.....	53

## E

Editorial division, Chief (Webster P. True).....	vii, 88
Ellis, Max M.....	viii
Eruption of Mauna Loa, Hawaii, The 1942 (Macdonald).....	199
Establishment, The.....	9
Ethnogeographic Board.....	3
Ethnology, Bureau of American.....	x, 7, 47
Collections.....	55
Editorial work and publications.....	8, 53
Field work.....	7, 8
Illustrations.....	55
Library.....	8, 54
Miscellaneous.....	55
Personnel.....	55
Report.....	46
Special researches.....	53
Staff.....	x
Systematic researches.....	47

	Page
Executive Committee of the Board of Regents.....	vii, 95
Report.....	89
Appropriations.....	94
Audit.....	95
Cash balances, receipts, and disbursements.....	92
Classification of investments.....	92
Consolidated fund.....	91
Freer Gallery of Art.....	91
Gifts and bequests.....	94
Smithsonian endowment fund.....	89
Summary.....	91

## F

Fairchild, D. G.....	viii
Federal Works Agency.....	26
Fenton, W. N.....	x, 8, 51, 52
Fernández, Don Luis.....	39
Finances.....	11
Finley, David E., Director, National Gallery of Art.....	x, 25, 26
Fisher, A. K.....	ix
Fisher, W. K.....	ix
Flores C., Ing. Luis.....	22
Food problems in wartime, Some (Cowgill).....	591
Foshag, W. F.....	ix, 22
Fox, Charles L. (Sulfonamides in the treatment of war wounds and burns).....	569
Freer Gallery of Art.....	x, 7, 41
Attendance.....	44
Changes in exhibition.....	44
Collections, The.....	7, 41
Curatorial work.....	43
Docent service.....	45
Lectures.....	7, 43
Personnel.....	45
Report.....	41
Staff.....	x
War work.....	7, 43
Friedmann, Herbert.....	viii
(The natural-history background of camouflage).....	259
Frison, Robert E.....	50

## G

Gass, F. E., Acting Chief Clerk, International Exchange Service.....	xi, 64
Gazin, C. Lewis.....	ix
Gazin, Elisabeth H.....	x
Gilmore, Charles W.....	ix, 22
Graf, John E., Associate Director of the National Museum.....	vii
Graham, David C.....	ix
Greene, Charles T.....	viii
Guest, Grace Dunham, Assistant Director, Freer Gallery of Art.....	x, 43

## H

Harrington, John P.....	x, 8, 48
Harrison, Richard Edes (Maps, strategy, and world politics).....	253
Henderson, E. P.....	ix
Heroy, William B. (Petroleum geology).....	161
Hershkovitz, Philip.....	21
Hess, Frank L.....	ix
Hill, James H., property clerk of the Institution.....	vii
Hoover, William H.....	xi, 76
Hopkins, A. D.....	viii
Howard, L. O.....	viii
Howell, A. Brazier.....	viii
Hrdlička, Aleš.....	viii
Hull, Cordell, Secretary of State (member of the Institution).....	vii, 25, 26

## I

	Page
Inter-American cooperation.....	3
International Exchange Service.....	xi, 8, 56
Appropriation.....	56
Depositories of Congressional Record.....	60
Foreign depositories of governmental documents.....	57
Foreign exchange agencies.....	62
Interparliamentary exchange of the official journal.....	60
Packages sent and received.....	8, 56
Personnel.....	63
Report.....	56
Staff.....	xi

## J

James, Macgill, Assistant Director, National Gallery of Art.....	x, 25
Johnson, D. H.....	viii
Johnston, Earl S.....	xi, 76
Jones, Jesse H., Secretary of Commerce (member of the Institution).....	vii
Judd, Neil M.....	viii

## K

Kellogg, Remington.....	viii, 20
Kennedy, Raymond (Contours of culture in Indonesia).....	513
Keppel, David.....	25
Ketchum, Miriam B.....	x
Killip, Ellsworth P.....	viii, 20
Knox, Frank, Secretary of the Navy (member of the Institution).....	vii
Kramer, Andrew.....	76
Kress, Samuel H.....	x, 25, 26
Krieger, H. W.....	viii

## L

Leonard, Emery C.....	viii
Lessons from the Old World to the Americas in land use (Lowdermilk).....	413
Lewton, Frederick L.....	ix
Librarian of the Institution (Leila F. Clark).....	vii
Library.....	12, 77
Accessions.....	78
Branches.....	81
Cataloging.....	80
Gifts.....	79
Personnel.....	80
Report.....	77
Statistics.....	81
War work.....	77
Library of Congress.....	57
Life magazine.....	29, 30
Link, Anna M.....	38
Lodge, John E.....	6, 7, 35, 45
Lowdermilk, Walter Clay (Lessons from the Old World to the Americas in land use).....	413

## M

MacCurdy, George Grant.....	vii <sup>i</sup>
Macdonald, Gordon A. (The 1942 Eruption of Mauna Loa, Hawaii).....	199
Maloney, James O.....	viii
Mann, William M., Director, National Zoological Park.....	viii, xi, 74
Manning, Catherine L.....	ix
Maps, strategy, and world politics (Harrison and Strausz-Hupé).....	253
Marshall, William B.....	ix
Mauersberger, Herbert R. (Progress in new synthetic textile fibers).....	151
Maxon, W. R.....	viii
McAlister, Edward D.....	xi
McBride, H. A., Administrator, National Gallery of Art.....	x, 25



	Page
McNary, Charles L. (regent of the Institution).....	vii, 10
Mears, Eliot G. (The ocean current called "The Child").....	245
Mellon, A. W., Educational and Charitable Trust.....	31
Members of the Institution.....	vii
Métraux, Alfred.....	8, 51
Miller, Gerrit S., Jr.....	viii
Mitman, Carl W.....	ix
Mongan, Elizabeth.....	25
Moore, Elizabeth L.....	52
Moore, J. Percy.....	viii
Morgenthau, Henry, Jr., Secretary of the Treasury (member of the Institution).....	vii, 25, 26
Morris, Roland S. (regent of the Institution).....	vii, 10
Morrison, Joseph P. E.....	viii
Morton, Conrad V.....	viii
Myers, Jack E.....	76

## N

National Academy of Design, Council of.....	37
National Collection of Fine Arts.....	x, 6, 35
Acquisitions.....	6, 35
Appropriations.....	35
Catherine Walden Myer fund.....	35
Henry Ward Ranger fund purchases.....	37
Loans accepted.....	36
Loans to other museums and organizations.....	36
Other activities.....	38
Publications.....	40
Reference library.....	37
Report.....	35
Smithsonian Art Commission.....	6, 35
Special exhibitions.....	6, 39
Withdrawals by owners.....	37
National Gallery of Art.....	x, 6, 25
Acquisitions.....	6, 27
Acquisitions committee.....	26
Air-raid protection.....	27
Appropriations.....	26
Attendance.....	6, 27
Audit of private funds of the Gallery.....	34
Curatorial department.....	32
Educational program.....	33
Executive committee.....	25
Exhibitions.....	6, 29
Expenditures and encumbrances.....	26
Finance committee.....	26
Gifts of paintings and sculpture.....	6, 28
Gifts of prints.....	6, 27
Library.....	33
Loan of works of art by the Gallery.....	29
Loan of works of art returned.....	29
Loans of works of art to the Gallery.....	30
Officials.....	x, 25
Organization and staff.....	25
Other gifts.....	34
Photographic department.....	34
Publications.....	6, 27
Report.....	25
Restoration and repair of works of art.....	32
Sale or exchange of works of art.....	30
Trustees.....	x, 25
Various Gallery activities.....	6, 31
Works of art stored in a place of safekeeping.....	32
National Geographic-Smithsonian archeological expedition.....	7, 20, 21, 47, 53

	Page
National Museum.....	vii, 5, 13
Accessions.....	5, 14
Appropriation.....	13
Changes in organization and staff.....	23
Collections.....	14
Explorations and field work.....	6, 19
Miscellaneous.....	22
Museum in wartime, The.....	13
Publications and printing.....	6, 22
Report.....	13
Special exhibits.....	23
Staff.....	vii
Visitors.....	6, 22
National University of Mexico.....	51
National Zoological Park.....	xi, 8, 65
Acquisitions of specimens.....	9, 67
Air-raid precautions.....	67
Appropriation.....	65
Deposits.....	72
Donors and their gifts.....	68
Exchanges.....	72
Gifts.....	68
Maintenance and improvements.....	66
Natural reproduction.....	71
Needs of the Zoo.....	66
Personnel.....	65
Purchases.....	72
Removals.....	73
Report.....	65
Species new to the history of the collection.....	73
Staff.....	xi
Statement of accessions.....	74
Status of collection.....	74
Visitors for the year.....	8, 66
Natural-history background of camouflage, The (Friedmann).....	259
Natural rubber (Cook).....	363
Nelson, O. E.....	20
New metals and new methods (Desch).....	213
Newman, M. T.....	viii

## O

O'Brien, Brian (Some biological effects of solar radiation).....	109
Ocean current called "The Child," The (Mears).....	245
Oceanography (Stetson).....	219
Oehser, Paul H.....	x, 85
Office of Censorship.....	57, 60
Office of Strategic Services.....	33
Officials of the Institution.....	vii
Oliver, Lawrence L.....	x
Olmsted, A. J.....	ix, x
Olmsted, Helen A., personnel officer of the Institution.....	vii
Origin of Far Eastern civilizations: A brief handbook (Bishop).....	463
Other wartime activities.....	4

## P

Paine, R. G.....	viii
Palmer, M. Helen.....	x, 53, 87
Palmer, Theodore S.....	ix
Pan American Union.....	39
Pearce, George B.....	22
Pennsylvania Historical Commission.....	51
Perkins, Frances, Secretary of Labor (member of the Institution).....	vii
Perry, S. H.....	ix
Personnel officer of the Institution (Helen A. Olmsted).....	vii
Petroleum geology (Heroy).....	161

	Page
Phillips, Duncan	x, 25, 26
Pichetto, Stephen	32
Pittier, Henri	ix, 20
Plants of China and their usefulness to man, The (Walker)	325
Pope, J. A.	x
Postmaster General (Frank C. Walker, member of the Institution)	vii
President of the United States (Franklin D. Roosevelt, Presiding Officer ex officio of the Institution)	vii, 10
Presiding Officer ex officio (Franklin D. Roosevelt, President of the United States)	vii
Price, Waterhouse & Co	34
Progress in new synthetic textile fibers (Mauersberger)	151
Property clerk of the Institution (James H. Hill)	vii
Public Buildings Administration	26
Publications	11, 82
Allotments for printing	88
American Historical Association, Reports	87
Astrophysical Observatory, Annals	11
Daughters of the American Revolution, Report of the National Society	88
Distribution	12, 82
Ethnology, Bureau of American	11, 82
Annual Report	82, 87
Bulletins	11, 82, 87
National Museum	11, 82, 85
Annual Report	82, 85
Bulletins	11, 82, 87
Contributions from the U. S. National Herbarium	11, 82, 87
Proceedings	11, 82, 85
Report	82
Smithsonian	11, 82
Annual Reports	11, 82, 84, 85
Miscellaneous Collections	11, 82
Special publications	82, 85
War Background Studies	11, 82, 83

## R

Rawley, W. N.	x
Reberholt, B. O.	ix
Reed, F. C.	ix
Regent, The Board of	vii, 10
Members	vii, 10
Proceedings	10
Rehder, Harald A.	viii
Reid, E. D.	viii
Resser, Charles E.	ix
Rice, Arthur P.	viii
Roberts, Frank H. H., Jr.	x, 8, 49, 50
Rohwer, S. A.	viii
Roosevelt, Franklin D., President of the United States (Presiding Officer ex officio and member of the Institution)	vii
Rosson, Elizabeth W.	ix
Russell, J. Townsend	viii

## S

Sawyer, Wilbur A. (The yellow fever situation in the Americas)	575
Schaller, W. T.	ix
Schmitt, Waldo L.	viii, 6, 20
Schultz, Leonard P.	viii
Schwartz, Benjamin	viii
Scientific staff	viii
Sea as a storehouse, The (Armstrong)	135
Searle, Harriet Richardson	viii
Secretary of Agriculture (Claude R. Wickard, member of the Institution)	vii
Secretary of Commerce (Jesse H. Jones, member of the Institution)	vii

	Page
Secretary of the Institution (Charles G. Abbot).....	vii, x, xi, 10, 12, 25
Secretary of Labor (Frances Perkins, member of the Institution).....	vii
Secretary of the Navy (Frank Knox, member of the Institution).....	vii
Secretary of State (Cordell Hull, member of the Institution).....	vii, x, 25, 26
Secretary of the Treasury (Henry Morgenthau, Jr., member of the Institution).....	vii, x, 25, 26
Secretary of War (Henry L. Stimson, member of the Institution).....	vii
Segura, Alfonso.....	22
Setzler, Frank M.....	viii
Shamel, H. Harold.....	viii
Shepard, Donald D.....	25
Shoemaker, C. R.....	viii
Sinclair, Charles C.....	x
Smithsonian Art Commission.....	6, 35
Smithsonian in wartime, The.....	1
Solar radiation as a power source (Abbot).....	99
Spencer, William.....	50
Stanton, T. W.....	ix
State Department.....	20, 21, 50, 56
Stearns, Foster (regent of the Institution).....	vii, 10
Stejneger, Leonhard.....	6
Sternberg, George F.....	22
Stetson, Henry C. (Oceanography).....	219
Stevenson, John A.....	viii
Steward, Julian H.....	x, 4, 8, 50, 51
Stewart, T. Dale.....	viii
Stimson, Henry L., Secretary of War (member of the Institution).....	vii
Stirling, Matthew W., Chief, Bureau of American Ethnology.....	x, 7, 20, 47, 55
Stone, Harlan F., Chief Justice of the United States (Chancellor of the Institution).....	vii, 10, 25
Strategic information to war agencies.....	2
Strausz-Hupé, Robert (Maps, strategy, and world politics).....	253
Strong, William Duncan.....	3
Sulfonamides in the treatment of war wounds and burns (Fox).....	569
Summary of the year's activities of the branches of the Institution.....	5
Swanton, John R.....	x, 7, 48
Swingle, W. T.....	viii

## T

Tannous, Afif I. (The Arab village community of the Middle East).....	523
Taylor, Frank A.....	ix
Tolman, R. P., Acting Director, National Collection of Fine Arts.....	ix, x, 40
Treasurer of the Institution (Nicholas W. Dorsey).....	vii
Trembly, R. H.....	x
True, Webster P., Chief, editorial division.....	vii, 88

## U

Ulrich, E. O.....	ix
-------------------	----

## V

Vaughan, T. W.....	ix
Vice President of the United States (Henry A. Wallace, member and regent of the Institution).....	vii, 10

## W

Walcott, Frederic C. (regent of the Institution).....	vii, 10
Walker, Egbert H.....	viii
(The plants of China and their usefulness to man).....	325
Walker, Ernest P., Assistant Director, National Zoological Park.....	xi
Walker, Frank C., Postmaster General (member of the Institution).....	vii
Walker, John, Chief Curator, National Gallery of Art.....	x, 25
Wallace, Henry A., Vice President of the United States (member and regent of the Institution).....	vii, 10
Walter Rathbone Bacon Traveling Scholarship.....	21

	Page
Wang, C. M.-----	38
War Committee, Smithsonian-----	2
War Department-----	52
War research projects-----	3
Warthin, A. S., Jr.-----	21
Watkins, William N.-----	ix
Weber, W. A.-----	viii, 21
Wedel, Waldo R.-----	viii, 19, 47
Weintraub, Robert L.-----	xi
(Chemotherapeutic agents from microbes)-----	545
Wenley, A. G., Director, Freer Gallery of Art-----	x, 7, 46
Wetmore, Alexander, Assistant Secretary of the Institution and Director of the National Museum-----	vii, viii, 24
Whitebread, Charles-----	ix
Wickard, Claude R., Secretary of Agriculture (member of the Institution).-----	vii
Widener, Joseph E.-----	x, 25, 26
Willoughby, Marion F.-----	ix
Wu, K. T.-----	38

## Y

Yaeger, William L.-----	95
Yellow fever situation in the Americas, The (Sawyer)-----	575











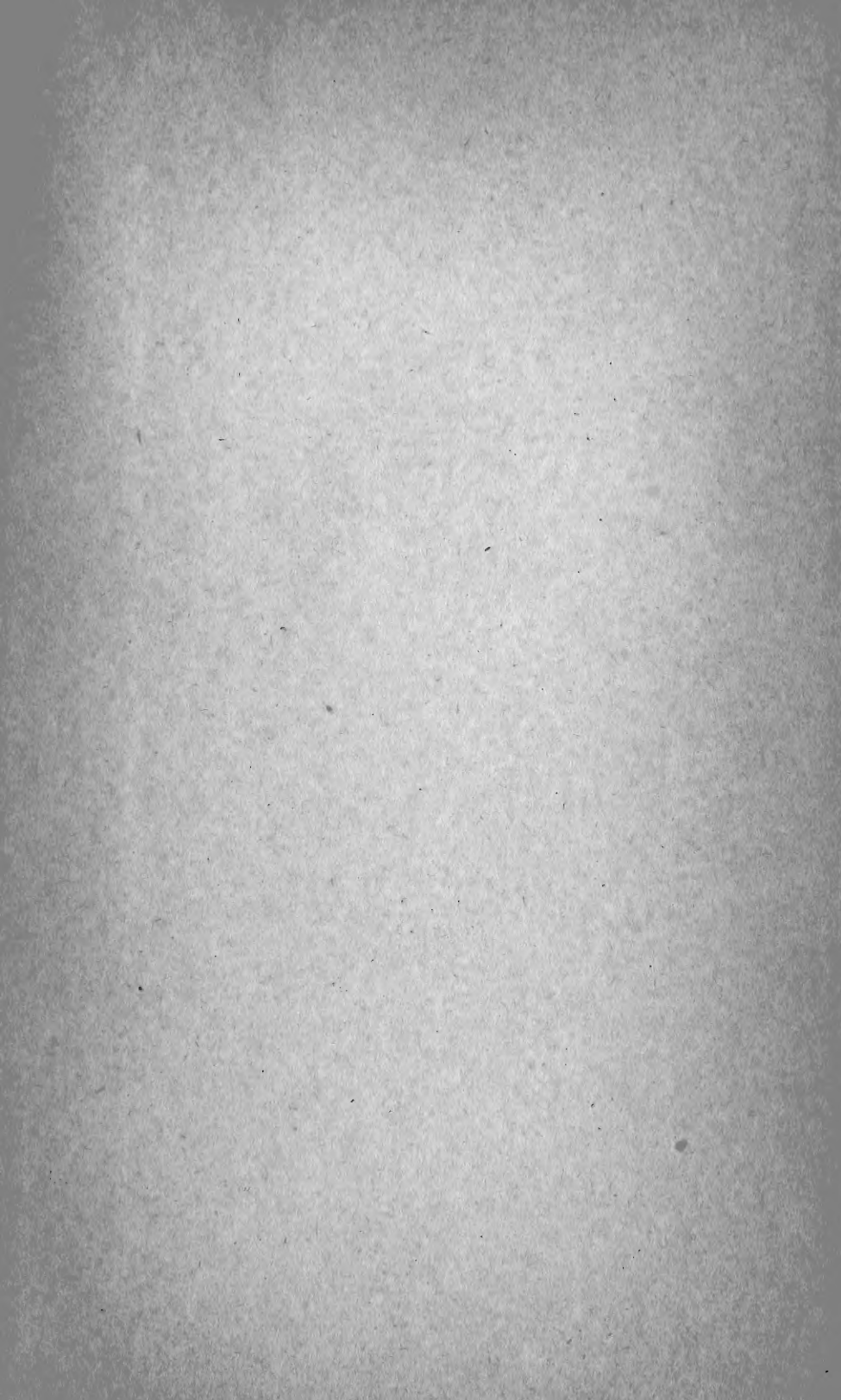





SMITHSONIAN INSTITUTION LIBRARIES



3 9088 00944 9729