



Ref
1951

ANNUAL REPORT OF THE
BOARD OF REGENTS OF
THE SMITHSONIAN
INSTITUTION

SHOWING THE
OPERATIONS, EXPENDITURES, AND
CONDITION OF THE INSTITUTION
FOR THE YEAR ENDED JUNE 30

1951



(Publication 4062)

UNITED STATES
GOVERNMENT PRINTING OFFICE
WASHINGTON : 1952

LETTER OF TRANSMITTAL

SMITHSONIAN INSTITUTION,
Washington, December 20, 1951.

To the Congress of the United States:

In accordance with section 5593 of the Revised Statutes of the United States, I have the honor, on behalf of the Board of Regents, to submit to Congress the annual report of the operations, expenditures, and condition of the Smithsonian Institution for the year ended June 30, 1951. I have the honor to be,

Respectfully,

A. WETMORE, *Secretary.*

CONTENTS

	Page
List of officials	v
General statement.....	1
The Establishment.....	3
The Board of Regents.....	3
Finances.....	4
Appropriations.....	5
Visitors.....	5
Eighteenth annual James Arthur lecture on the sun.....	6
Opening of Adams-Clement collection.....	6
Memorial gifts.....	7
Summary of the year's activities of the branches of the Institution.....	7
Publications.....	11
Library.....	12
Appendix 1. Report on the United States National Museum.....	14
2. Report on the National Gallery of Art.....	25
3. Report on the National Collection of Fine Arts.....	41
4. Report on the Freer Gallery of Art.....	49
5. Report on the Bureau of American Ethnology.....	56
6. Report on the International Exchange Service.....	96
7. Report on the National Zoological Park.....	104
8. Report on the Astrophysical Observatory.....	117
9. Report on the National Air Museum.....	123
10. Report on the Canal Zone Biological Area.....	134
11. Report on the library.....	144
12. Report on publications.....	148
Report of the executive committee of the Board of Regents.....	154

GENERAL APPENDIX

Stormy weather on the sun, by Walter Orr Roberts.....	163
An appraisal of cloud seeding as a means of increasing precipitation, by Henry G. Houghton.....	175
On Einstein's new theory, by Leopold Infeld.....	189
Some results in the field of high-pressure physics, by P. W. Bridgman.....	199
Ultrasonics, by Arthur R. Laufer.....	213
The industrial applications of atomic energy, by M. L. Oliphant.....	223
Some prospects in the field of electronics, by V. K. Zworykin.....	235
The new chemical elements, by Saul Dushman.....	245
The insides of metals, by Carl A. Zappe.....	253
Atomic weapons against cancer, by E. N. Lockard.....	263
Enzymes: Machine tools of the cellular factory, by B. A. Kilby.....	273
The fauna of America, by Austin H. Clark.....	287

	Page
The mechanics of snakes, by Alfred Leutscher.....	303
Hormones and the metamorphosis of insects, by V. B. Wigglesworth.....	313
Utilizing our soil resources for greater production, by Robert M. Salter....	319
The carbon-14 method of age determination, by Frank H. H. Roberts, Jr....	335
River Basin Surveys: The first five years of the Inter-Agency Archeological and Paleontological Salvage Program, by Frank H. H. Roberts, Jr.....	351
Artificial lighting in America: 1830-1860, by C. Malcolm Watkins.....	385
The development of the halftone screen, by Jacob Kainen.....	409
The artist and the atom, by Peter Blanc.....	427

LIST OF PLATES

Secretary's report:	
Plates 1, 2.....	52
Plates 3, 4.....	108
Stormy weather on the sun (W. O. Roberts): Plates 1, 2.....	174
Ultrasonics (Laufer): Plates 1-3.....	222
Electronics (Zworykin): Plates 1-4.....	238
Insides of metals (Zapffe): Plates 1-4.....	262
Enzymes (Kilby): Plate 1.....	286
Fauna of America (Clark): Plates 1-8.....	294
Mechanics of snakes (Leutscher): Plates 1-3.....	310
Hormones and the metamorphosis of insects (Wigglesworth): Plates 1-4.....	318
Utilizing our soil resources (Salter): Plate 1.....	334
River Basin Surveys (F. H. H. Roberts): Plates 1-10.....	374
Artificial lighting (Watkins): Plates 1-8.....	390
Halftone screen (Kainen): Plates 1-12.....	422
Artist and the atom (Blanc): Plates 1-5.....	430

THE SMITHSONIAN INSTITUTION

June 30, 1951

Presiding Officer ex officio.—HARRY S. TRUMAN, President of the United States.
Chancellor.—FRED M. VINSON, Chief Justice of the United States.

Members of the Institution:

HARRY S. TRUMAN, President of the United States.
ALBEN W. BARKLEY, Vice President of the United States.
FRED M. VINSON, Chief Justice of the United States.
DEAN C. ACHESON, Secretary of State.
JOHN W. SNYDER, Secretary of the Treasury.
GEORGE C. MARSHALL, Secretary of Defense.
J. HOWARD MCGRATH, Attorney General.
JESSE M. DONALDSON, Postmaster General.
OSCAR CHAPMAN, Secretary of the Interior.
CHARLES F. BRANNAN, Secretary of Agriculture.
CHARLES SAWYER, Secretary of Commerce.
MAURICE TOBIN, Secretary of Labor.

Regents of the Institution:

FRED M. VINSON, Chief Justice of the United States, Chancellor.
ALBEN W. BARKLEY, Vice President of the United States.
WALTER F. GEORGE, Member of the Senate.
CLINTON P. ANDERSON, Member of the Senate.
LEVERETT SALTONSTALL, Member of the Senate.
CLARENCE CANNON, Member of the House of Representatives.
JOHN M. VORYS, Member of the House of Representatives.
E. E. COX, Member of the House of Representatives.
HARVEY N. DAVIS, citizen of New Jersey.
ARTHUR H. COMPTON, citizen of Missouri.
VANNEVAR BUSH, citizen of Washington, D. C.
ROBERT V. FLEMING, citizen of Washington, D. C.
JEROME C. HUNSAKER, citizen of Massachusetts.

Executive Committee.—ROBERT V. FLEMING, *chairman*, VANNEVAR BUSH,
CLARENCE CANNON.

Secretary.—ALEXANDER WETMORE.

Assistant Secretaries.—JOHN E. GRAF, J. L. KEDDY.

Administrative assistant to the Secretary.—MRS. LOUISE M. PEARSON.

Treasurer.—J. D. HOWARD.

Chief, editorial division.—PAUL H. OEHSER.

Librarian.—MRS. LEILA F. CLARK.

Administrative accountant.—THOMAS F. CLARK.

Superintendent of buildings and labor.—L. L. OLIVER.

Assistant Superintendent of buildings and labor.—CHARLES C. SINCLAIR.

Personnel officer.—JACK B. NEWMAN.

Chief, division of publications.—L. E. COMMERFORD.

Property, supply, and purchasing officer.—ANTHONY W. WILDING.

Photographer.—F. B. KESTNER.

UNITED STATES NATIONAL MUSEUM

Director.—A. REMINGTON KELLOGG.

Chief, office of correspondence and records.—HELENA M. WEISS.

Editor.—JOHN S. LEA.

Associate librarian.—MRS. ELISABETH H. GAZIN.

SCIENTIFIC STAFF

DEPARTMENT OF ANTHROPOLOGY:

Frank M. Setzler, head curator; A. J. Andrews, exhibits preparator;

W. W. Taylor, Jr., collaborator in anthropology.

Division of Archeology: Waido R. Wedel, curator; Clifford Evans, Jr., associate curator; Mrs. M. C. Blaker, museum aide; J. Townsend Russell, Jr., honorary assistant curator of Old World archeology.

Division of Ethnology: H. W. Krieger, curator; J. C. Ewers, associate curator; C. M. Watkins, associate curator; R. A. Elder, Jr., assistant curator.

Division of Physical Anthropology: T. Dale Stewart, curator; M. T. Newman, associate curator.

Associate in Anthropology: Neil M. Judd.

DEPARTMENT OF ZOOLOGY:

Waldo L. Schmitt, head curator; W. L. Brown, chief exhibits preparator;

Mrs. Aime M. Awl, scientific illustrator.

Associates in Zoology: T. S. Palmer, W. B. Marshall, A. G. Böving, C. R. Shoemaker, W. K. Fisher, Austin H. Clark.

Collaborator in Zoology: R. S. Clark.

Collaborator in Biology: D. C. Graham.

Division of Mammals: D. H. Johnson, associate curator; H. W. Setzer, associate curator; Charles O. Handley, Jr., assistant curator; A. Brazier Howell, collaborator; Gerrit S. Miller, Jr., associate.

Division of Birds: Herbert Friedmann, curator; H. G. Deignan, associate curator; Alexander Wetmore, custodian of alcoholic and skeleton collections; Arthur C. Bent, collaborator.

Division of Reptiles and Amphibians: Doris M. Cochran, associate curator.

Division of Fishes: Leonard P. Schultz, curator; E. A. Lachner, associate curator; W. T. Leapley, Robert H. Kanazawa, museum aides.

Division of Insects: Edward A. Chapin, curator; R. E. Blackwelder, associate curator; W. D. Field, associate curator; O. L. Cartwright, associate curator; Grace E. Glance, associate curator; Sophy Parfin, assistant curator; W. L. Jellison, collaborator.

Section of Hymenoptera: W. M. Mann, assistant custodian; Robert A. Cushman, assistant custodian.

Section of Diptera: Charles T. Greene, assistant custodian.

Section of Coleoptera: L. L. Buchanan, specialist for Casey collection.

Division of Marine Invertebrates: F. A. Chace, Jr., curator; P. L. Illg, associate curator; Frederick M. Bayer, assistant curator; Mrs. L. W. Peterson, museum aide; Mrs. Harriet Richardson Searle, collaborator; Max M. Ellis, collaborator; J. Percy Moore, collaborator; Mrs. Mildred S. Wilson, collaborator in copepod Crustacea.

Division of Mollusks: Harald A. Rehder, curator; Joseph P. E. Morrison, associate curator; R. Tucker Abbott, associate curator; W. J. Byas, museum aide; P. Bartsch, associate.

Section of Helminthological Collections: Benjamin Schwartz, collaborator.

DEPARTMENT OF BOTANY (NATIONAL HERBARIUM) :

Jason R. Swallen, head curator.

Division of Phanerogams: A. C. Smith, curator; E. C. Leonard, associate curator; E. H. Walker, associate curator; Lyman B. Smith, associate curator; Velva E. Rudd, assistant curator; E. P. Killip, research associate.

Division of Ferns: C. V. Morton, curator.

Division of Grasses: Ernest R. Sohns, associate curator; Agnes Chase, F. A. McClure, research associates.

Division of Cryptogams: C. V. Morton, acting curator; Paul S. Conger, associate curator; John A. Stevenson, custodian of C. G. Lloyd mycological collections and honorary curator of Fungi; W. T. Swingle, custodian of Higher Algae; David Fairchild, custodian of Lower Fungi.

DEPARTMENT OF GEOLOGY :

W. F. Foshag, head curator; J. H. Benn, museum aide; Jessie G. Beach, aide.

Division of Mineralogy and Petrology: W. F. Foshag, acting curator; E. P. Henderson, associate curator; G. S. Switzer, associate curator; F. E. Holden, museum technician; Frank L. Hess, custodian of rare metals and rare earths.

Division of Invertebrate Paleontology and Palcobotany: Gustav A. Cooper, curator; A. R. Loeblich, Jr., associate curator; David Nicol, associate curator; Arthur L. Bowsler, associate curator; W. T. Allen, museum aide; J. Brookes Knight, research associate in paleontology.

Section of Invertebrate Paleontology: T. W. Stanton, custodian of Mesozoic collection; J. B. Reeside, Jr., custodian of Mesozoic collection; Preston Cloud, research associate.

Section of Paleobotany: Roland Brown, research associate.

Division of Vertebrate Paleontology: C. L. Gazin, curator; D. H. Dunkle, associate curator; W. D. Crockett, scientific illustrator; F. L. Pearce, A. C. Murray, exhibits preparators.

Associates in Mineralogy: W. T. Schaller, S. H. Perry, J. P. Marble.

Associates in Paleontology: T. W. Vaughan, R. S. Bassler.

DEPARTMENT OF ENGINEERING AND INDUSTRIES :

Frank A. Taylor, head curator.

Division of Engineering: Frank A. Taylor, acting curator.

Section of Civil and Mechanical Engineering: Frank A. Taylor, in charge.

Section of Marine Transportation: Frank A. Taylor, in charge.

Section of Electricity: K. M. Perry, associate curator.

Section of Physical Sciences and Measurement: Frank A. Taylor, in charge.

Section of Land Transportation: S. H. Oliver, associate curator.

Division of Crafts and Industries: W. N. Watkins, curator; E. A. Avery, William E. Bridges, museum aides; F. L. Lewton, research associate.

Section of Textiles: Grace L. Rogers, assistant curator.

Section of Wood Technology: William N. Watkins, in charge.

Section of Manufactures: W. N. Watkins, in charge.

Section of Agricultural Industries: W. N. Watkins, in charge.

Division of Medicine and Public Health: G. S. Thomas, associate curator.

Division of Graphic Arts: J. Kainen, curator; E. J. Fite, assistant curator.

Section of Photography: A. J. Wedderburn, Jr., associate curator.

DEPARTMENT OF HISTORY:

Mendel L. Peterson, acting head curator.
Divisions of Military History and Naval History: M. L. Peterson, associate curator; J. R. Sirlouis, assistant curator.
Division of Civil History: Margaret W. Brown, assistant curator.
Division of Numismatics: S. M. Mosher, associate curator.
Division of Philately: Franklin R. Bruns, Jr., assistant curator.

NATIONAL GALLERY OF ART

Trustees:

FRED M. VINSON, Chief Justice of the United States, *Chairman*.
 DEAN C. ACHESON, Secretary of State.
 JOHN W. SNYDER, Secretary of the Treasury.
 ALEXANDER WETMORE, Secretary of the Smithsonian Institution.
 SAMUEL H. KRESS.
 FERDINAND LAMMOT BELIN.
 DUNCAN PHILLIPS.
 CHESTER DALE.
 PAUL MELLON.

President.—SAMUEL H. KRESS.
Vice President.—FERDINAND LAMMOT BELIN.
Secretary-Treasurer.—HUNTINGTON CAIRNS.
Director.—DAVID E. FINLEY.
Administrator.—HARRY A. MCBRIDE.
General Counsel.—HUNTINGTON CAIRNS.
Chief Curator.—JOHN WALKER.
Assistant Director.—MAGGILL JAMES.

NATIONAL COLLECTION OF FINE ARTS

Director.—THOMAS M. BEGGS.
Curator of ceramics.—P. V. GARDNER.
Exhibits preparators.—G. J. MARTIN, ROWLAND LYON.
Assistant librarian.—ANNA M. LINK.

FREER GALLERY OF ART

Director.—A. G. WENLEY.
Assistant Director.—JOHN A. POPE.
Assistant to the Director.—BURNS A. STUBBS.
Associate in Near Eastern art.—RICHARD ETTINGHAUSEN.
Assistant in research.—HAROLD P. STERN.
Research associate.—GRACE DUNHAM GUEST.

BUREAU OF AMERICAN ETHNOLOGY

Director.—MATTHEW W. STIRLING.
Associate Director.—FRANK H. H. ROBERTS, JR.
Senior ethnologists.—H. B. COLLINS, JR., JOHN P. HARRINGTON, W. N. FENTON.
Collaborators.—FRANCES DENSMORE, JOHN R. SWANTON, A. J. WARING, JR.
Editor.—M. HELEN PALMER.
Assistant librarian.—MIRIAM B. KETCHUM.
Scientific illustrator.—E. G. SCHUMACHER.
Archives assistant.—MAE W. TUCKER.
 INSTITUTE OF SOCIAL ANTHROPOLOGY.—G. M. FOSTER, JR., *Director*.
 RIVER BASIN SURVEYS.—FRANK H. H. ROBERTS, JR., *Director*.

INTERNATIONAL EXCHANGE SERVICE

Chief.—D. G. WILLIAMS.

NATIONAL ZOOLOGICAL PARK

Director.—WILLIAM M. MANN.

Assistant Director.—ERNEST P. WALKER.

Head Keeper.—FRANK O. LOWE.

ASTROPHYSICAL OBSERVATORY

Director.—LOYAL B. ALDRICH.

Assistant librarian.—MARJORIE R. KUNZE.

DIVISION OF ASTROPHYSICAL RESEARCH :

Chief.—WILLIAM H. HOOVER.

Instrument makers.—ANDREW KRAMER, D. G. TALBERT, J. H. HARRISON.

Research associate.—CHARLES G. ABBOT.

DIVISION OF RADIATION AND ORGANISMS :

Chief.—R. B. WITHROW.

Plant physiologists.—LEONARD PRICE, V. B. ELSTAD, ALICE P. WITHROW.

Chemist.—EMANUEL HOBOWITZ.

NATIONAL AIR MUSEUM

Advisory Board:

ALEXANDER WETMORE, *Chairman.*

MAJ. GEN. DONALD L. PUTT, *U. S. Air Force.*

REAR ADM. T. S. COMBS, *U. S. Navy.*

GROVER LOENING.

WILLIAM B. STOUT.

Assistant to the Secretary for the National Air Museum.—CARL W. MITMAN.

Curator.—P. E. GARBER.

Associate curators.—R. C. STROBELL, W. M. MALE.

Museum aide.—WINTHROP S. SHAW.

CANAL ZONE BIOLOGICAL AREA

Resident Manager.—JAMES ZETEK.

Report of the Secretary of the Smithsonian Institution

ALEXANDER WETMORE

For the Year Ended June 30, 1951

To the Board of Regents of the Smithsonian Institution:

GENTLEMEN: I have the honor to submit herewith my report showing the activities and condition of the Smithsonian Institution and its branches during the fiscal year ended June 30, 1951.

GENERAL STATEMENT

The lengthy discussions and debates among both scientists and legislators that preceded the creation of the National Science Foundation, on May 10, 1950, are reminiscent of the ten-year deliberations more than a century ago that culminated in the establishment of the Smithsonian Institution. James Smithson, the English benefactor who bequeathed half a million dollars to the United States of America to found at Washington "an institution for the increase and diffusion of knowledge among men," had been dead 17 years before our Government decided what form the "institution" was to take or even to accept the gift. Finally, on August 10, 1846, President James K. Polk signed the bill that created the Smithsonian Institution, our first "national science foundation." With that act, which was actively supported by John Quincy Adams, Joel R. Poinsett, and other science-minded leaders of the day, our Government formally recognized that science is a matter of national concern, and as a nation we committed ourselves to the Jeffersonian idea that science is a legitimate function of government.

Today, in the wake of the atom bomb, no one dares question that concept. Present-day exigencies have forced us to recognize that there are certain types of scientific investigation which are essential to our national security and that these must not be left to haphazard and uncertain backing of private individuals and organizations, no matter how worthy or well-meaning. They must be publicly and continuously financed so long as science continues to be so strategically integrated with our politics, economics, and social well-being. The statement that "this is the age of science" has taken on deeper and more somber implications.

Throughout the 105 years since it was established, the Smithsonian Institution has seen and has been a part of the development of this national attitude toward science. It has witnessed and sometimes aided the establishment of many great and potent scientific agencies, such as the National Academy of Sciences, the National Research Council, the National Bureau of Standards, the National Advisory Committee for Aeronautics, and others that came into being during World War II. The Institution itself has undergone many changes and vicissitudes: it has survived four major wars, several panics and depressions, and controversies that seemed important at the time. But its one continuing purpose has been, and is, to serve science—not merely American science but all science—in a way that its founder Smithson might have envisioned. It has endeavored not to compete but to serve as a sort of catalyst to complement and cooperate in the work of other agencies, Government and non-Government alike, and to support worthy projects that otherwise might languish. The unique character of its status—as a privately endowed institution and at the same time a ward of the United States Government—has given it a freedom of action backed by authority that has proved fortunate and has increased its usefulness.

In the early days of its existence the Institution carried on its research programs largely by subsidizing the work of scientists not on its own staff and by publishing the results of their work. Sources of such aid to American scientists were then extremely limited, and the favor that this practice found can well be understood. Gradually, however, the activities of the Institution became channelized as they expanded, and “bureaus” grew up around the Institution, each with its own staff specializing in the work of its particular field. These are now ten in number, as follows: United States National Museum, National Gallery of Art (with separate board of trustees), National Collection of Fine Arts, Freer Gallery of Art, Bureau of American Ethnology, International Exchange Service, National Zoological Park, Astrophysical Observatory, National Air Museum, and Canal Zone Biological Area. Most of these branches are now supported by Government funds although remaining under Smithsonian direction. At present, nearly all the research and exploration of the Institution is done through these bureaus, notably the United States National Museum, the Bureau of American Ethnology, and the Astrophysical Observatory.

Curtailment of the Government’s nondefense spending since the Korean crisis has prevented the Institution from proceeding with some of its long-term programs, such as the modernization of museum

exhibits, construction of urgently needed new buildings, and purchase of modern instruments and equipment for its laboratories. The demands made upon our buildings, as has been pointed out in previous reports, are little short of incredible: the annual number of visitors is rapidly approaching the 3,000,000 mark, and the increase of the collections in the fields of natural history, industry, history, and aeronautics has long since crowded all available storage space. It should be emphasized that the Institution has no desire to expand its activities inordinately or to add functions unjustified by normal demands. At the same time the public expects certain services from the Federal Government, through the Smithsonian, in maintaining the priceless collections in the National Museum and in the art galleries under the Institution's care and in making them available for exhibit and study. These are services that have long been entrusted to the Smithsonian; they fall in that category of activities aimed at the cultural and scientific advancement of all the people, and hence their support by Federal appropriations of funds is proper and justifiable. Smithsonian administrators, therefore, are duty bound to do everything in their power to obtain adequate support for the irreplaceable treasures in their custody, even in times of national emergency.

In the pages that follow the director of each of the bureaus under Smithsonian direction presents his detailed report for the year (Appendices 1-10). Included also are the reports of the Librarian and the Chief of the Editorial Division (Appendices 11 and 12).

THE ESTABLISHMENT

The Smithsonian Institution was created by act of Congress in 1846, in accordance with the terms of the will of James Smithson, of England, who in 1826 bequeathed his property to the United States of America "to found at Washington, under the name of the Smithsonian Institution, an establishment for the increase and diffusion of knowledge among men." In receiving the property and accepting the trust, Congress determined that the Federal Government was without authority to administer the trust directly, and, therefore, constituted an "establishment" whose statutory members are "the President, the Vice President, the Chief Justice, and the heads of the executive departments."

THE BOARD OF REGENTS

There were no changes in the personnel of the Board of Regents during the year. One vacancy still exists in the class of citizen regents. The roll of regents at the close of the fiscal year, June 30,

1951, was as follows: Chief Justice Fred M. Vinson, Chancellor; Vice President Alben W. Barkley; members from the Senate: Walter F. George, Clinton P. Anderson, Leverett Saltonstall; members from the House of Representatives; Clarence Cannon, John M. Vorys, E. E. Cox; citizen members: Harvey N. Davis, Arthur H. Compton, Vannevar Bush, Robert V. Fleming, and Jerome C. Hunsaker.

The regular annual meeting of the Board was held in the Regents' Room on January 12, 1951. The Secretary presented his annual report covering the activities of the Institution and its bureaus, including the financial report of the Executive Committee, for the fiscal year ended June 30, 1950, and this was accepted by the Board. The usual resolution authorized the expenditure by the Secretary of the income of the Institution for the fiscal year ending June 30, 1952.

The Secretary announced that he would reach retirement age in June 1951 and brought to attention the question of the selection of a successor. Accordingly, the Chancellor appointed a Special Committee to make recommendation in this connection. Dr. Wetmore agreed to serve until a successor had been chosen.

Concerning the Gellatly art collection, the Secretary reported that under date of February 28, 1950, the office of the Attorney General informed the Institution that the Supreme Court had denied Mrs. Gellatly's petition for a writ of certiorari to review the decision of the United States Court of Appeals. This long controversy of more than 20 years apparently has come to an end, with result favorable to the Smithsonian.

On the evening of January 11, 1951, preceding the annual meeting, an informal dinner meeting of the Board was held in the Main Hall of the Smithsonian Institution, with the Chancellor, Chief Justice Fred M. Vinson, presiding. This occasion gave opportunity for members of the Smithsonian staff to make a fuller presentation of the scientific work of the Institution than was practicable at the regular meeting the next day.

On May 3, 1951, a special meeting of the Board of Regents was held in the Regents' Room with the Chancellor presiding, concerned with the operation of the Institution, including the extension of tenure of office of the Secretary.

FINANCES

A statement on finances, dealing particularly with Smithsonian private funds, will be found in the report of the Executive Committee of the Board of Regents, page 154.

APPROPRIATIONS

Funds appropriated to the Institution for the fiscal year ended June 30, 1951, totaled \$2,700,000, obligated as follows:

Management-----	\$57, 322
United States National Museum-----	781, 754
Bureau of American Ethnology-----	57, 297
Astrophysical Observatory-----	127, 188
National Collection of Fine Arts-----	48, 852
National Air Museum-----	182, 931
Canal Zone Biological Area-----	18, 000
International Exchange Service-----	70, 388
Maintenance and operation of buildings-----	927, 919
General services-----	316, 483
Estimated savings-----	11, 866
Impounded funds-----	100, 000
Total-----	2,700, 000

Of this total \$100,000 was impounded by the Bureau of the Budget through direction of the Congress.

In addition, \$1,170,000 was appropriated to the National Gallery of Art, a bureau of the Institution but administered by a separate board of trustees; and \$636,000 was provided in the District of Columbia appropriation act for the operation of the National Zoological Park.

Besides these direct appropriations, the Institution received funds by transfer from other Federal agencies, as follows:

From the State Department, from the appropriation International Information and Educational Activities, 1951, a total of \$92,740 for the operation of the Institute of Social Anthropology, including the issuance of publications resulting from its work.

From the National Park Service, Department of Interior, \$309,949 for archeological projects in connection with the River Basin Surveys.

VISITORS

Visitors to the Smithsonian buildings during the year 1950-51 totaled 2,867,544, an all-time record of attendance and about a 10-percent increase over the previous year. July 1950 was the month of largest attendance, with 383,919 visitors; May 1951 was the next largest, with 362,443. A summary of attendance records for the five buildings is given in table 1. These do not include 3,460,400 visitors estimated at the National Zoological Park and 1,503,148 at the National Gallery of Art.

TABLE 1.—Visitors to the Smithsonian buildings during the year ended June 30, 1951

Year and month	Smithsonian Building	Arts and Industries Building	Natural History Building	Aircraft Building	Freer Gallery of Art	Total
<i>1950</i>						
July.....	77,651	189,476	85,020	23,365	8,407	333,919
August.....	69,703	170,219	83,630	20,780	8,104	352,436
September.....	45,092	94,608	53,219	13,956	5,836	202,711
October.....	32,806	77,964	56,120	14,079	4,404	185,373
November.....	26,095	59,334	43,146	10,913	3,510	143,898
December.....	16,224	32,851	27,448	7,331	2,281	86,135
<i>1951</i>						
January.....	18,960	40,600	31,891	8,912	2,652	103,015
February.....	23,521	46,924	39,181	10,936	3,030	123,592
March.....	45,016	102,411	66,355	18,527	5,047	237,356
April.....	70,480	160,948	89,012	23,476	6,919	350,835
May.....	65,533	169,949	99,362	21,696	5,963	362,443
June.....	64,129	158,706	82,742	23,452	6,802	335,831
Total.....	558,110	1,303,990	757,126	187,423	62,595	2,867,544

¹ Building closed September 5 through 28, 1950, during installation of the Bell X-1.

EIGHTEENTH ANNUAL JAMES ARTHUR LECTURE ON THE SUN

In 1931 the Institution received a bequest from James Arthur, of New York, a part of the income from which was to be used for an annual lecture on some aspect of the study of the sun.

The eighteenth Arthur lecture was delivered in the auditorium of the Natural History Building on March 22, 1951, by Dr. Walter Orr Roberts, astrophysicist and director of the High Altitude Observatory, Boulder, Colo. The subject of Dr. Roberts's address was "Stormy Weather on the Sun." This lecture is published in full in the General Appendix of the present Report of the Board of Regents (p. 163).

OPENING OF ADAMS-CLEMENT COLLECTION

Exercises were held in the Arts and Industries Building on the afternoon of April 18, 1951, formally opening a collection of memorabilia of the Adams family given to the Institution on June 1, 1950, by Miss Mary Louisa Adams Clement, of Warrenton, Va., a descendant through her mother of John Adams, second President of the United States, and of John Quincy Adams, sixth President. The collection contains nearly 600 heirlooms pertaining to the Adamses and their descendants, including 15 portraits by Gilbert Stuart, Edward Dalton Marchand, Pieter van Huffel, Thomas H. Hull, Asher B. Durand, John Trumbull, and other artists; a good representation of period costumes and jewelry; china, glassware, and silver; books and family letters; and numerous miscellaneous items. The gift is

one of the most important historically to come to the Institution in recent years. The portraits have been assigned to the National Collection of Fine Arts; the remaining objects to the Department of History, United States National Museum. At present those portions of the Adams-Clement Collection chosen for public display are exhibited in the west hall of the Arts and Industries Building. It is expected that changes and substitutions in the exhibit will be made as the documentation of the specimens proceeds. The donor died on September 23, 1950, unfortunately before the formal opening of the collection. At the ceremonies the speakers were Mrs. Katharine McCook Knox, art historian; Maj. Gen. U. S. Grant, 3d, president of the American Planning and Civic Association; Dr. Remington Kellogg, director of the United States National Museum; and Dr. Alexander Wetmore, Secretary of the Smithsonian Institution.

MEMORIAL GIFTS

In memory of their mother, Alice Pike Barney (1860-1931), Washington artist and civic leader, Natalie Clifford Barney and Laura Dreyfus-Barney have given the Institution a fund of \$15,000 and also a collection of 224 paintings by Mrs. Barney, 54 pictures by other artists, and many sculptures and objects of art. The art material is to be used as the nucleus of a collection for loan in the interests of art education in the United States and will be known as the Alice Pike Barney Loan Collection. The fund, to be known as the Alice Pike Barney Memorial Fund, will be used by the National Collection of Fine Arts to maintain the loan collection and to organize and circulate traveling art exhibitions in this country.

Also received during the year was a bequest of \$15,000 from the late George H. Stephenson, of Philadelphia, for the purpose of executing an appropriate memorial to Brig. Gen. William Mitchell (1879-1936), of military-aviation fame. Plans for the memorial are being instituted through the National Air Museum.

SUMMARY OF THE YEAR'S ACTIVITIES OF THE BRANCHES OF THE INSTITUTION

National Museum.—The increment to the national collections, distributed among the Museum's six departments, this year aggregated more than 303,000 objects, bringing the catalog entries to a total of 32,617,298. Some of the year's more noteworthy accessions included: In anthropology, fine collections of Colonial furniture and utensils, further archeological material from Neolithic sites in Honshu, Japan, and a collection of wooden objects representing the native culture of a village in northeastern New Guinea; in zoology, a large lot of mam-

mals, birds, and marine invertebrates from Labrador and Newfoundland; several accessions of Central American birds; a comprehensive collection of fishes, crustaceans, mollusks, and miscellaneous invertebrates from the Gulf of Mexico; several large and important collections of insects, and several thousand marine invertebrates and shells from the vicinity of Point Barrow, Alaska; in botany, gifts of plants especially from Alaska, Honduras, Perú, México, Venezuela, and Colombia, and more than 16,500 plants received in exchanges with other institutions; in geology, 22 minerals heretofore unrepresented in the Museum, 7 meteorites, fossil invertebrates and plants from several important localities, and fossil vertebrate material from Panamá and the western United States; in engineering and industries, a collection of historical electronic and electrical apparatus, a complete technical exhibit of the halftone process, and an exhibit telling the story of modern surgical sutures; and in history, a model of the battleship *Missouri* and the Adams-Clement Collection of memorabilia pertaining to the families of John Adams and John Quincy Adams.

Members of the staff conducted field work in Cuba, Panamá, Costa Rica, Honduras, Colombia, South Africa and Southern Rhodesia, British North Borneo, Okinawa, Alaska, and many sections of the United States. The Museum issued 26 publications.

National Gallery of Art.—Slightly more than one and a half million visitors were recorded at the Gallery for the year, about 684,000 less than for 1949-50. Accessions as gifts, loans, or deposits totaled 4,044, nearly 1,700 more than last year. On March 17, 1951, the Gallery celebrated its tenth anniversary at a special opening of an exhibition of paintings and other works of art acquired since 1945 by the Samuel H. Kress Foundation. Over 24,000 invited guests attended. Eight special exhibits were held at the Gallery during the year. Special traveling exhibitions of prints from the Rosenwald Collection were circulated to eight galleries and museums in this country, and exhibitions from the "Index of American Design" were shown 55 times in 20 States and the District of Columbia. The volume on "The Index of American Design" was published and placed on sale during the year. Progress was made on the second volume of "Masterpieces of American Painting from the National Gallery of Art." More than 37,000 persons attended the Gallery's special tours and the "Picture of the Week" talks. The Sunday afternoon lectures in the auditorium and the Sunday evening concerts in the garden courts were continued. The Eighth Annual American Music Festival was held at the Gallery in April.

National Collection of Fine Arts.—The Smithsonian Art Commission met on December 5, 1950, and accepted for the National Collection 15 paintings (part of the Adams-Clement gift to the Smithsonian Institution), 5 miscellaneous oil paintings, 50 miniatures by American

and foreign artists, and several items of Austrian, Dutch, French, Swedish, and Bohemian glass. Eight miniatures were acquired through the Catherine Walden Myer fund. A gift in memory of Alice Pike Barney (1860-1931), Washington artist, brought the Institution a collection of 278 paintings, to be used as the nucleus of a loan collection, and a fund of \$15,000 to be used in maintaining the collection and in organizing and circulating traveling art-appreciation exhibits in this country. Sixteen special exhibits were held during the year, one of the most noteworthy being the Centennial Anniversary Exhibition of Paintings by Thomas Wilmer Dewing. Also of special interest was the opening, on February 23, of the Albert Pinkham Ryder Room of the John Gellatly Collection, exhibiting together the 17 Ryders in the collection.

Freer Gallery of Art.—The Freer collections were enhanced by the accession of Chinese paintings, pottery, and bronzes; Japanese paintings; and Persian metalwork. The cleaning and restoration of the Whistler Peacock Room were completed, and the room was reopened to the public on October 13, 1950. The staff members devoted their time to the study of new accessions and of objects contemplated for purchase and to general research in the field of Oriental and Islamic art. Reports were made on 2,377 objects. Two members of the staff spent parts of the year pursuing research projects in other countries: John A. Pope studied Chinese porcelain collections in Tehran and Istanbul, and Dr. Richard Ettinghausen began a year's trip to the Near East, studying in Egypt, Iran, Iraq, and Afghanistan. Visitors to the Gallery totaled 62,895 persons. The Gallery issued five publications during the year and assisted in the publication of the final number of *Ars Islamica*, under Dr. Ettinghausen's editorship.

Bureau of American Ethnology.—Ethnologists and archeologists on the Bureau staff continued their respective researches, Director Stirling in Panamá, Dr. Collins in the Canadian Arctic, Dr. Harrington in Montana and México, and Dr. Fenton in New Mexico, California, and Montana. Dr. Frank H. II. Roberts, Jr., continued as director of the River Basin Surveys, a unit of the Bureau now in its sixth year of operation, and completed the collection of the first volume of River Basin Surveys papers. Since the beginning of the River Basin Surveys field work 2,894 archeological sites have been located and recorded, and 545 of these have been recommended for excavation or additional testing. This year's excavation work covered 20 reservoir areas in 10 States, with 26 excavating parties in the field.

The Institute of Social Anthropology, an autonomous unit of the Bureau financed through transfer of funds from the Department of State, carried on its research and teaching programs in Brazil, Colombia, Guatemala, México, and Perú.

The archival material of the Bureau was enriched by the addition of the original catalog (in Powell's handwriting) of the photographic negatives made on Maj. John W. Powell's famous expedition down the Grand Canyon of the Colorado.

International Exchange Service.—As the official agency for the exchange with other countries of governmental, scientific, and literary publications, the Exchange Service handled 1,011,000 packages of such publications (total weight, 788,773 pounds) for transmission, or about the same as during the previous year. As last year, no shipments were made to China or Rumania, but consignments are moving to all other countries. The number of sets of United States official publications sent abroad in exchange for similar publications of other countries is now 102 (61 full and 41 partial sets). Eighty-five copies of the Federal Register and 92 of the Congressional Record are also sent abroad through the Exchange Service.

National Zoological Park.—This year brought the largest attendance in the history of the Zoo—an estimated total of 3,460,400 visitors, or at the average rate of more than 9,000 a day. At the close of the fiscal year, there were 2,813 animals in the Zoo collections, the additions during the year (1,768) almost exactly balancing the losses and removals (1,776). Among the more unusual accessions, some representing species never before shown in this Zoo, were 17 Santa Marta tinamous from Colombia; a splendid example of the black-headed python of Australia; a rare native wild goat from Crete; specimens of the large Meller's chameleon from Africa; three-banded armadillos from central South America; and six Labrador lemmings. In all, 217 creatures were born or hatched at the Zoo—62 mammals, 57 birds, and 98 reptiles.

Astrophysical Observatory.—The Observatory continued its studies of solar radiation at its two high-altitude field stations at Table Mountain, Calif., and Montezuma, Chile. At Table Mountain a method is being developed for determining by spectrobolometric measurements the quantity of ozone in the upper atmosphere. The textile-exposure studies at the Montezuma station for the Office of the Quartermaster General were terminated in May. In cooperation with the Meteorological Division, Chemical Corps, at Camp Detrick, Md., some work was done on the problem of improving the melikeron, an instrument developed some years ago by the Observatory to measure outgoing radiation from earth to space. Two silver-disk pyrhelimeters were constructed and furnished at cost, one to the Government of Israel and the other to the Air Force's Research Laboratories at Cambridge, Mass. The division of radiation and organisms, following a 2-year period of setting up specialized equipment and facilities, and new electronic instruments, has begun a series of biochemical investiga-

tions of photomorphogenesis in green plants which promise interesting results.

National Air Museum.—A number of outstanding accessions were received by the National Air Museum during the year. Foremost among these were the Bell X-1, the world's first supersonic, man-carrying airplane, which has been installed on exhibit in the Aircraft Building; and a duplicate example of the world's first successful supersonic ram-jet engine and its rocket booster. In all, 99 specimens, including four full-sized aircraft, were recorded from 30 sources. Inasmuch as over two-thirds of the Air Museum's collection of full-sized aircraft are in storage, providing and maintaining storage facilities remain a serious problem; and toward the end of the year this became aggravated when the Museum was ordered to vacate its storage facility at Park Ridge, Ill., to make way for aircraft manufacture. The National Air Museum Advisory Board met on June 28, 1951, with this problem a primary concern. During the year, by means of a special exhibit, shown first in the Navy Department and then in the Pentagon Building, the Museum marked the fortieth anniversary of Naval Airplane Carrier Operations.

Canal Zone Biological Area.—Contract was let during the year for constructing a new laboratory building of modest design at the Barro Colorado Island station. Thirty-three scientists made use of the island's facilities during the period, carrying on studies in various fields of biology. Some of the research projects under way are worth noting: An exhaustive study of the spiders of the region; a checklist of Barro Colorado Island birds; investigation of the population density and social organization of the island's howler monkeys; a study of the light-sensitive structures of animals; corrosion and deterioration tests; and studies of fungi. The resident manager continued his long-term termite-resistance tests and his fruit-fly studies.

PUBLICATIONS

Throughout the entire history of the Smithsonian, publications have constituted the Institution's principal medium for the "diffusion of knowledge," one of the two basic functions of the organization as prescribed by James Smithson, the founder. The Institution issues eight regular series of publications and six others that appear less frequently. Embodying the results of researches of the Smithsonian staff and collaborators, these publications are distributed free to more than a thousand libraries, both here and abroad, as well as to a large list of educational and scientific organizations and specialists in various fields. In all, 123,401 copies of Smithsonian publications were distributed this year.

During the past year, 61 publications appeared under the Smithsonian imprint. Outstanding among these were Part 11 of "Birds of North and Middle America," by Herbert Friedmann; another volume of "A Monograph of the Existing Crinoids," by Austin H. Clark; volume 6 of the "Handbook of South American Indians"; "The Northern and Central Nootkan Tribes," by Philip Drucker; and two monographs of the Institute of Social Anthropology. A complete list of the year's publications will be found in the report of the chief of the editorial division, appendix 12.

Smithsonian tables.—It has long been the practice of the Institution to assist students and research workers by publishing compilations of tables useful in all kinds of technical, industrial, and scientific work. Since 1852, when the first edition of Prof. Arnold Guyot's "Meteorological and Physical Tables" was published by the Institution, thousands of copies of the Smithsonian tables have been distributed throughout the world. These volumes, which have fallen in four categories (meteorological, physical, mathematical, and geographical), have been kept revised and reprinted as new data in these fields became available. During the present year, three volumes of these tables were in process:

The sixth revised edition of the Smithsonian Meteorological Tables, prepared by Robert J. List, of the U. S. Weather Bureau, was expected to be off the press before the end of the calendar year 1951.

The manuscript for the ninth revised edition of the Smithsonian Physical Tables, compiled under the direction of Dr. W. E. Forsythe, of Cleveland, was completed during the year and submitted for printing estimates.

The Institution accepted the manuscript for a new volume in the mathematical series: Smithsonian Logarithmic Tables, prepared by G. W. Spenceley, Rheba M. Spenceley, and E. R. Epperson, of Miami (Ohio) University. These tables present 23-decimal-place values of natural and common logarithms and will be published by the Institution under a grant from the Research Corporation of New York.

LIBRARY

The library of the Institution received 52,685 publications during the year, mostly by gifts and through exchanges with other organizations and institutions. The largest single gift of the year was in the field of philately—a collection of about 500 books and periodicals presented by Malcolm Macgregor, of Bronxville, N. Y., which were assigned to the philatelic sectional library in the Department of History.

Statistics compiled by the librarian show that the staff entered 17,854 periodical parts, circulated 11,869 books and periodicals, ar-

ranged 465 new exchanges, cataloged 6,992 volumes and pamphlets, added 29,981 cards to shelflists and catalogs, transferred 19,016 publications to the Library of Congress, prepared 1,250 volumes for binding, and repaired 1,300 volumes in the National Museum. At the close of the year the library's holdings totaled 932,740 volumes (exclusive of incomplete volumes of serials and separates and reprints from serials). More than half of these are housed in the Library of Congress as the Smithsonian Deposit.

Respectfully submitted.

ALEXANDER WETMORE, *Secretary.*

APPENDIX 1

Report on the United States National Museum

SIR: I have the honor to submit the following report on the condition and operations of the United States National Museum for the fiscal year ended June 30, 1951:

BUILDINGS AND EQUIPMENT

Construction began on the conversion of the southwest court in the Arts and Industries Building to a modern storage facility, and \$80,295 was obligated from funds appropriated for this purpose. The sum of \$47,013 was allotted for the construction of storage cases and drawers, and outside contracts were let for building the wooden frames for these; the mechanical shops of the Institution will cover the frames with sheets of thin steel. Steel racks to provide accessibility to the stacks of large-sized drawers, totaling about 3,500, are now being fabricated by the maintenance and operation division.

COLLECTIONS

More than 303,000 specimens were incorporated into the national collections and distributed among the six departments during the year, as follows: Anthropology, 15,396; zoology, 225,638; botany, 38,603; geology, 16,723; engineering and industries, 3,073; and history, 3,716. Most of the accessions were acquired as gifts from individuals or as transfers from Government departments and agencies. The complete report on the Museum, published as a separate document, includes a detailed list of the year's acquisitions, of which the more important are summarized below. Catalog entries in all departments now total 32,617,298. It may be noted that the annual increment of specimens varies from a quarter to three-quarters of a million objects, depending upon the number of large collections obtained.

Anthropology.—Household furniture, ceramics, glassware, pewter, wrought-iron and brass utensils, woodenware, folk paintings, embroideries, and textiles used by residents of New England during the period 1630 to 1840, which had been assembled by Dr. and Mrs. Arthur M. Greenwood at Time Stone Farm, Marlborough, Mass., have now been added to the national collections. Another outstanding addition to the ceramic and cultural collections is the gift by Mrs. Lura

Woodside Watkins of 314 earthenware utensils, which were excavated at 20 documented New England potteries in existence between 1687 and the late 1880's. Colonial utensils and Indian artifacts from Kicotan, Va., one of the earliest English settlements in America, were presented by Alvin W. and Joseph B. Brittingham.

From Maj. Howard A. MacCord, U. S. Army, 413 specimens of stone artifacts, pottery, and other materials from various Neolithic sites on the island of Honshu, Japan, were received.

Gen. and Mrs. David G. Barr and Patty Barr presented a black silk cape with fur collar and lining of golden-haired monkey skins, worn by a Manchu emperor. Lt. Col. Clifford Lee Smires gave a collection of wooden objects, including a ceremonial staff, wooden bowl, bamboo arrows, shell trumpet, decorated wooden drums, and carved and decorated wood utensils, which were obtained from the natives of a village near Aitape, northeastern New Guinea.

Casts of fossil apelike hominoids from East Africa, one a replica of a nearly complete skull of *Proconsul africanus* and the others replicas of bones belonging to australopithecines, were presented by the American Institute of Human Paleontology and the Wenner-Gren Foundation for Anthropological Research.

Zoology.—Six unusually fine chamois from the Bavarian Alps were presented by the collector, Capt. Kimberly Brabson, U. S. Army. Maj. Robert Traub, a member of the scrub-typhus unit organized by the United States Army Medical Service, forwarded 88 mammals from Malaya and 57 reptiles and amphibians from Selangor. More than 200 arboreal mammals, collected by Dr. H. C. Clark and associates in connection with research on jungle yellow fever at the Gorgas Memorial Laboratory in Panamá and México, were presented to the division of mammals. Drs. Robert Rausch and Everett L. Schiller, Arctic Health Research Center, United States Public Health Service, transferred 58 Alaskan mammals. During the summer cruise of the *Blue Dolphin*, conducted by Commander David G. Nutt under the auspices of the Arctic Institute of North America, Charles O. Handley, Jr., collected for the Museum 194 mammals and 201 birds from Labrador and Newfoundland; and to the national collections were also added approximately 1,500 marine invertebrates.

Income from the W. L. Abbott bequest financed the ornithological field work of M. A. Carriker, Jr., in Colombia, and the Smithsonian private funds that of Dr. A. Wetmore and W. M. Perrygo in Panamá. The Colombian collection comprised 3,480 bird skins, 53 skeletons, 2 sets of eggs, and 1 nest; the Panamanian, 526 bird skins, 6 skeletons, and 6 carcasses in alcohol. In addition, 393 bird skins from Denmark and 344 from British Columbia were purchased from private funds. Especially worthy of mention this year are the 453 skins and 29 skele-

tons of birds from South Africa and Southern Rhodesia, including 59 species new to the Museum, which were collected by Dr. Herbert Friedmann. Other accessions of importance were 28 bird skins from the South Australian Museum; 5 Pacific Island birds from Peabody Museum, Yale University; 117 skins of Portuguese East African birds from Museu Dr. Álvaro de Castro, Lourenço Marques; 188 Japanese bird skins from Col. L. R. Wolfe; 219 sets of eggs from Venezuela and Trinidad collected by Robert N. Berryman; and 692 skins, 35 sets of eggs, and 28 nests from Alaska transferred to the Museum through Dr. Laurence Irving by the Arctic Health Research Center, United States Public Health Service.

Among the accessions worthy of note received by the division of reptiles and amphibians were 35 specimens from Korea presented by William E. Old, Jr.; 71 Indian reptiles, including two species of *Uropeltis*, from the School of Tropical Medicine, Calcutta, India; 70 reptiles and amphibians collected by Harry Hoogstraal, mostly in Kenya, Africa; and 15 reptiles and amphibians from Saudi Arabia, a gift of Sgt. Edward Murray.

The fishery investigations conducted by Stewart Springer on the Fish and Wildlife Service vessel *Oregon* resulted in the transfer to the Museum of one of the most comprehensive collections of fishes, crustaceans, mollusks, and miscellaneous invertebrates ever made in the deeper waters of the Gulf of Mexico. As exchanges, there were received from the Applied Fisheries Laboratory, University of Washington, through Drs. Lauren R. Donaldson and Arthur D. Welander, 144 fishes, including a number of types of new species, from the Marshall Islands; from Rhodes University College, through Dr. J. L. B. and Margaret M. Smith, 91 fishes from Knysna Estuary, Cape Province, South Africa; and from the University of Hawaii, through Dr. William A. Gosline, 43 Hawaiian fishes, including several types. While studying the poisonous fishes of Micronesia, Dr. Eugenie Clark made a collection of 3,730 fishes, which she presented to the division of fishes.

The most important accessions received by the division of insects were transfers from the Bureau of Entomology and Plant Quarantine, totaling 66,498 insects, of which 18,498 were derived from the Alaska insect project. The gift to the U. S. Bureau of Entomology and Plant Quarantine by Dr. Albert R. Shadle of his lifetime collection of nearly 5,400 insects and transferred to the Museum, along with Egger's collection of bark beetles, and over 1,900 Egyptian insects obtained by Curtis Sabrosky, likewise enhanced the usefulness of the national collections. As a gift, the Museum acquired the collection of H. G. Barber, consisting of 32,151 bugs and beetles.

In the course of an ecological survey in the vicinity of Point Barrow, Alaska, Prof. G. E. MacGinitie, formerly director of the Arctic Research Laboratory, and Mrs. MacGinitie, assembled nearly 7,500 miscellaneous invertebrates and approximately 1,600 marine shells, and through their active interest these collections came to the Museum as a transfer from the Office of Naval Research.

As gifts, the division of marine invertebrates received nearly 3,000 crayfishes and other fresh-water invertebrates collected in Indiana and the TVA region by Dr. Rendell Rhoades; 367 specimens of sponges, including 98 types, collected in Micronesia by Dr. M. W. de Laubenfels while participating in the scientific investigations sponsored by the Pacific Science Board, National Research Council; and 437 miscellaneous invertebrates dredged off the west coast of Florida, a gift of Dr. J. Brookes Knight. A selected series of more than 5,000 copepods and other marine invertebrates were collected for the Museum in Puget Sound, Wash., by Associate Curator Paul L. Illg. As an exchange with Dr. R. Zariquiey A., Barcelona, the Museum received a selected set of decapod crustaceans from the Mediterranean coast of Spain. Types and paratypes of a number of invertebrates were received as gifts.

Most noteworthy of the 208 accessions received during the year by the division of mollusks were 275 marine forms from Malindi, presented by the Kenya Colony Game Department, Nairobi, through R. Teague; nearly 2,000 land mollusks from Cuba, a gift from Sr. Oscar Acalde Ledón, of Cienfuegos; 604 land and fresh-water mollusks from Panamá and Ecuador, transferred by Dr. James Zetek, Canal Zone Biological Area; 105 Japanese mollusks from the Zoological Institute, Kyoto University; and the types and paratypes of several recently described mollusks. Types of parasitic nematodes, annelids, trematodes, and cestodes were received from several specialists.

Several interesting echinoderms, including a specimen of *Asterias vestita*, described by Thomas Say in 1825 and not seen heretofore since then, were accessioned this year from the Institute of Fisheries Research, University of North Carolina.

Botany.—C. V. Morton, curator, division of ferns, collected 2,610 plants in Honduras and 851 in West Virginia and Michigan for the National Herbarium. Justice William O. Douglas presented a collection of 134 mounted plants from Lebanon, and 825 plants obtained in Alaska and the Aleutian Islands by Dr. Louis H. Jordal were transferred from the Office of Naval Research, Department of the Navy. Other gifts included 2,234 plants from the Museo de Historia Natural "Javier Prado," Lima, Perú; 662 Mexican plants from the University of Washington; and 522 Venezuelan plants from Brother Ginés. As exchanges, the National Herbarium received 16,645 specimens, of

which 1,814 were from the Instituto de Ciencias Naturales, Bogotá, Colombia; 1,509 were from Gray Herbarium, collected in Newfoundland and eastern United States; 1,043 from the California Academy of Sciences, collected in California and western United States: 795 Canadian Arctic plants from the Department of Agriculture, Ottawa; 595 from the New York Botanical Garden, collected in Kashmir; 1,273 Hawaiian and Pacific Islands plants from the Bernice P. Bishop Museum; and 689 southern Brazilian plants from Fundación Miguel Lillo, Tucumán, Argentina.

Geology.—Twenty-two minerals hitherto unrepresented were added to the mineralogical collection, of which three were received as gifts and nineteen were acquired through exchange.

The 13 specimens of euclase from Ouro Preto, Minas Gerais, Brazil, purchased under the Roebing fund, comprise some of the finest known specimens of this mineral. The Canfield bequest provided the funds for the purchase of vanadinite crystal groups from México, two Brazilian tourmaline crystals, a large and perfectly formed manganotantalite and simpsonite from Brazil, proustite crystals from Chile, a fine group of quartz crystals from Japan, and an opalized cedar cone from Nevada.

An unusual 71.20-carat aquamarine from Ceylon was purchased under the Chamberlain fund for the gem collection, and a very fine 110.8-carat pink tourmaline from Manchuria under the Roebing fund. A collection of Japanese cultured pearls, consisting of 2 strands and 395 individual pearls, were received as a gift from K. Mikimoto & Co., Ltd. Other additions to the collection included uranium and vanadium ores from Utah; chrome ores from Pakistan; manganese ores from India; and tin and tungsten ores from Burma.

The meteorite collection again benefited by the continuing interest of Dr. Stuart H. Perry, who donated seven meteorites, one of which was an iron recently found at Mayodan, N. C., weighing 15.46 kilograms. A small sample of the Maziba, Uganda, Africa, meteorite was presented by John S. Albanese.

Many noteworthy specimens of fossil invertebrates and plants came to the division of invertebrate paleontology and paleobotany as gifts, including 719 slides of types of Mesozoic and Cenozoic ostracods and Foraminifera from Dr. C. I. Alexander; 20 holotype and paratype Tertiary Foraminifera from P. Bronnimann; 1,000 upper Miocene invertebrates from S. E. Crumb; 200 Triassic invertebrates from the European Alps, presented by Dr. Franco Rasetti; 600 British Paleozoic and Mesozoic invertebrates from Alwyn Williams; and 900 late Tertiary plants from Credo, Colo., presented by the late Belle K. Stewart.

More than 100 Mississippian and Pennsylvanian crinoids from Oklahoma were purchased under the Springer fund from Harrell L.

Strimple. As in previous years, the income from the Walcott fund financed paleontological field work which resulted in the acquisition of additional invertebrate fossil materials by Dr. G. Arthur Cooper and W. T. Allen from western Texas and by Dr. Cooper from Virginia and Tennessee.

Transfers from the United States Geological Survey include, among others, upper Paleozoic invertebrates from the Brooks Range of Alaska, fresh-water mollusks, and ammonites. Exchanges brought to the Museum seeds of Tertiary plants from Germany; lower Ordovician brachiopods from Norway; Cretaceous and Tertiary Foraminifera from Sweden, France, Italy, Algeria, and Cuba; Permian fusulinid Foraminifera from Tunisia; and Jurassic and Recent Foraminifera from Germany.

Material sufficient for the mounting of a skeleton of the giant ground sloth, *Megatherium*, which was excavated by Dr. C. L. Gazin and Franklin Pearce in Panamá, constitutes the most noteworthy addition to the vertebrate fossil collection. Beautifully preserved middle Eocene fish were found in the Green River shales of Colorado, Utah, and Wyoming by Dr. D. H. Dunkle and Franklin Pearce. The field work in Panamá and that on fossil fishes was financed from the income of the Walcott fund. Some 80 fossil mammals from the Wind River Eocene of Wyoming and from the Oligocene of Montana and North Dakota, collected by Dr. T. E. White and transferred to the Museum by River Basin Surveys, deserve special mention.

Engineering and industries.—The section of wood technology received 345 samples of woods of Surinam by exchange from the Hout Instituut, Netherlands. In textiles, 407 wooden blocks used as braiding and embroidery patterns in the nineteenth century were presented by Edna Plummer, and 15 coverlet drafts of the period 1831–53 by Lelah Allison. E. I. du Pont de Nemours & Co., Inc., prepared and presented an exhibit showing the manufacture, properties, and versatility of nylon yarn.

The National Bureau of Standards transferred a collection of 155 pieces of historical electronic and electrical apparatus, including a radiosonde and a radiosonde transmitter. Early electrical measuring instruments developed by Europeans and Americans were presented by the Weston Electrical Instrument Corp. The American Screw Co. donated 13 inventors' models and machines illustrating the development of wood-screw-making machinery in the transition from hand-fed, individually operated machines to the hopper-fed, semiautomatic machines.

The most important accession by the division of graphic arts was a gift from the Sun Chemical Corp., through the Lithographers National Association, of 23 lithographs of the Fuchs and Lang collection of historical lithographs. A complete technical exhibit of the half-

tone process was presented by R. R. Donnelley & Sons Co. The section of photography accessioned a collection of 71 fine pictorial photographs made by members of the American Society of Photographic Art and representing work in control process printing by many noted photographers.

An exhibit entitled "The Story of Modern Surgical Sutures," donated by Davis & Geck, Inc., depicts in full color the development of sutures from their source through the various stages of manufacturing, research, and testing into actual use in the operating room.

History.—The Adams-Clement collection, the gift of the late Mary Louisa Adams Clement, of costumes, jewelry, portraits, silverware, china, books, and papers belonging to the families of John Adams and John Quincy Adams, constitutes the most important accession received by the division of civil history.

The naval collections were increased by the deposit by the Department of the Navy of scale models of the battleship *Missouri*, the cruiser *Brooklyn* of the Spanish-American War period, an LSM and an LCI.

The medal press and tools used by Edward Stabler, diesinker and seal engraver of Sandy Spring, Md., 1794–1883, were acquired by the division of numismatics as a gift from Mrs. Maurice J. Stabler.

Recently issued stamps, totaling some 900 in number, were transferred to the division of philately by the Universal Postal Union and the United States Post Office Department.

EXPLORATION AND FIELD WORK

Following the conclusion of the conference convened by the Cuban Ministry of Education at Habana on problems of Caribbean archeology and ethnology, H. W. Krieger visited several historical Taino Indian village sites, notably Vigia and Barajagua, in the province of Oriente, eastern Cuba. On June 14, Dr. Waldo R. Wedel was detailed to the Smithsonian River Basin Surveys to supervise the excavation of a stratified Arikara village site near Pierre, S. Dak.

In connection with his studies on distribution and variation in the bird life of southern Central America and northern South America, Dr. Alexander Wetmore, Secretary of the Smithsonian Institution, made his seventh expedition to the Republic of Panamá, accompanied by W. M. Perrygo of the U. S. National Museum. The men located at the beginning of March on Cerro Campana, the first mountain of size found to the west of the depression through which the Panama Canal crosses the Isthmus. The work here served to extend the known range of a number of mountain forms of birds from Veraguas and Chiriquí to this southern outpost of the great mountain chain that comes down through Central America. Additional collections were made from El Valle in the Province of Coclé, where forest still remains

on mountain shoulders around the valley. The field studies terminated at the beginning of April, when administrative matters recalled Dr. Wetmore to Washington.

Under the income of the W. L. Abbott fund, M. A. Carriker, Jr., continued ornithological collections in northern Colombia from December to the end of the fiscal year. The work this season extended into the difficult and poorly known area of the western slopes of the Chocó in the northwestern part of the country. From Buenaventura Mr. Carriker went to the lower Río San Juan where he made important collections at Punto Muchimbo. On January 19 he moved to Nuquí, on the Pacific coast at the mouth of the Río Nuquí, and later continued inland to a base at the highest point to be reached by canoe travel in the foothills of the Baudó Mountains. His collections covered the area from the river to the crest of the range. Maps of the region are incorrect, as the altitudes are lower than recorded and the summit is a narrow steep-sided ridge without extensive level ground. In March Mr. Carriker traveled farther north to Jurubidá where again he located inland at the end of canoe navigation whence he had access to the Baudó range. The work here terminated early in April, and the party returned to Medellín. The latter part of the season was devoted to the region in the vicinity of Sonson near the Río Magdalena. The collections made this year represent more than 400 species of birds, a number of forms being new to the National Museum series.

Grants from the Guggenheim Foundation, the American Philosophical Society, and special research funds of the Smithsonian Institution enabled Dr. Herbert Friedmann to devote 5 months to a study of the habits and life histories of the honey-guides and parasitic weaverbirds in South Africa and Southern Rhodesia. At the request of the U. S. Army Medical Department Graduate School, Dr. David H. Johnson was detailed to accompany a medical research unit engaged in an intensive study of the mammalian and other hosts involved in the transmission of scrub typhus, and part, at least, of this field study will be carried on in the vicinity of Mount Kinabalu, British North Borneo. Under a cooperative arrangement with the Office of Naval Research, Dr. Henry W. Setzer departed from Washington for the Arctic Research Laboratory at Point Barrow, Alaska, on June 3 to make an ecological survey during the summer months of the mammals inhabiting the Arctic slope of Alaska. O. L. Cartwright made an intensive study of the insect fauna in the vicinity of the Inter-American Institute at Turrialba, Costa Rica.

During March and April, C. V. Morton was the guest of the Escuela Agrícola Panamericana, of the United Fruit Co., located at El Zamorano in a mountain valley some 25 miles from Tegucigalpa, Honduras. Collecting trips for ferns were made to the cloud forest

on the summit of Mount Uyuca and to other areas in the departments of Morazán and El Paraíso. While collecting in the cloud-forest area of the San Juancito Mountains, Mr. Morton was the guest of the New York and Honduras Rosario Mining Co. Another longer trip was made to Lake Yojoa, in the departments of Santa Bárbara and Cortés, and to the mountains near Siquatepeque, Comayagua. On May 31 Dr. E. H. Walker departed from Washington for Okinawa in response to a request made to the Pacific Science Board, National Research Council, by the Department of the Army for the assignment of a botanist to make a 4-months' study of the flora of the Ryukyu Islands.

The program of investigations undertaken by the department of geology and financed for the most part from income of the Walcott bequest, involved field work in Alaska, California, Utah, Wyoming, Colorado, Texas, Virginia, Tennessee, and Panamá. Dr. George S. Switzer completed field studies relating to the genesis of iron ores in the Iron Springs district of southwestern Utah. During the early part of the summer of 1950, Dr. G. Arthur Cooper and W. T. Allen continued field work on the Wolfcamp formation, the lowest portion of the Permian beds in the Glass Mountains of west Texas. Later in the summer Dr. Cooper visited Blacksburg, Va., where, accompanied by Dr. B. N. Cooper, of the Virginia Polytechnic Institute, he spent several days collecting Ordovician fossils from the Catawba Valley section. Subsequently a thick sequence of Ordovician rocks was examined by Dr. Cooper and Dr. R. B. Neuman, of Gatlingsburg, Tenn., during a brief visit to the west side of the Great Smoky Mountains. Under a contract between the Office of Naval Research and the Smithsonian Institution, Dr. A. R. Loeblich, Jr., assembled a large collection of living Arctic foraminiferal faunas near Point Barrow, Alaska, during the summer of 1950. With the assistance of Max B. Payne, of Bakersfield, Calif., Dr. Loeblich, late in April and in May 1951, obtained foraminiferal samples from the Moreno and Panoche formations in Fresno County, Calif., and with Dr. Edward Bailey, of the U. S. Geological Survey, in the Franciscan series in Santa Clara County, Calif.

In the summer of 1950, Dr. D. H. Dunkle and F. L. Pearce made careful stratigraphic collections of fossil plants, invertebrates, fishes, and mammals in the Green River shales of Colorado, Utah, and Wyoming. Early in 1951, Dr. C. L. Gazin and his assistant, F. L. Pearce, returned to the interior of western Panamá to continue with the investigation of the Pleistocene fauna of that area. Most of the skeletal remains excavated belonged to the giant ground sloth, *Megatherium*, but, in addition, fragmentary remains were found of a peccary, a giant armadillo, and a bird. The field work in Panamá

this year was restricted to large springs near the town of Pesé. As in the previous year, the expedition was carried on in cooperation with the Panamanian Government, and in particular with the Museo Nacional de Panamá.

At the invitation of Dr. George Crile, Jr., Mendel L. Peterson, associate curator of military and naval history, during the first two weeks of June 1951 participated in the investigation of ships wrecked during the seventeenth and eighteenth centuries off the Florida Keys. Two boats equipped with air compressors for use with diving equipment and a large water pump attached to a jet hose for clearing sand from objects found on the sea bottom were utilized in this underwater exploration. Many interesting relics from one British ship, including iron cannon barrels, 6- and 12-pound shot, fragments of Chinese porcelain and pottery, pieces of rum bottles, clay pipes, and remnants of a silver-trimmed jar, were brought to the surface.

VISITORS

An increase of 246,340 visitors to the Museum buildings was recorded over the previous year, the totals being 2,617,226 for 1951 and 2,370,886 for 1950. July 1950 was the month of the largest attendance with 352,147 visitors; May 1951 was the next largest with 334,844. Attendance records for the three buildings show the following numbers of visitors: Smithsonian Building, 556,110; Arts and Industries Building, 1,303,990; Natural History Building, 757,126. The average daily number of visitors was 7,190. During the past 10 years more than 19,445,000 visitors have viewed the exhibits in these three buildings.

CHANGES IN ORGANIZATION AND STAFF

On October 30, 1950, Dr. Clifford Evans, Jr., whose particular field of interest is Latin America, was appointed associate curator in the division of archeology.

After 42 years of association with the institution, Austin H. Clark retired from active service as curator of the division of echinoderms on December 31, 1950. During his incumbency the collection of echinoderms grew to be the largest, and, except for east Atlantic and Mediterranean areas, by far the most representative in the world. Charles O. Handley, Jr., was appointed assistant curator in the division of mammals on November 28, 1950.

After being associated with the National Herbarium for 32 years, Ellsworth P. Killip, head curator since the organization of the department of botany, retired at his own request on September 30, 1950, and to this vacancy Jason R. Swallen, who had served as curator,

division of grasses, was promoted on December 10, 1950. Other changes in that department were the resignation of Dr. George A. Llano, associate curator, division of cryptogams, on February 8, 1951, and the appointment of Dr. Ernest R. Sohns as associate curator, division of grasses, on June 1, 1951.

Arthur L. Bowsler, associate curator, division of invertebrate paleontology and paleobotany, returned to the Museum rolls on August 1, 1950, from temporary transfer to the U. S. Geological Survey for special stratigraphic and paleontologic studies in the Mississippian rocks of northern Alaska in connection with exploration for oil in Naval Petroleum Reserve No. 4.

On June 21, 1951, the department of engineering and industries lost by retirement Fred C. Reed, associate curator in charge of the sections of manufactures and agricultural industries, after 28 years of service.

Charles Carey, acting head curator, department of history, retired at his own request on November 30, 1950, after 30 years of government service. Mrs. Catherine L. Manning, assistant curator, division of philately, retired January 31, 1951, after 27 years in that division, having reached the statutory age limit. Franklin R. Bruns, Jr., philatelic staff columnist for the New York World Telegram and Sun, was appointed on February 9, 1951, to succeed Mrs. Manning.

Respectfully submitted.

REMINGTON KELLOGG, *Director.*

Dr. A. WETMORE,

Secretary, Smithsonian Institution.

APPENDIX 2

Report on the National Gallery of Art

SIR: I have the honor to submit, on behalf of the Board of Trustees, the fourteenth annual report of the National Gallery of Art, for the fiscal year ended June 30, 1951. This report is made pursuant to the provisions of section 5 (d) of Public Resolution No. 14, Seventy-fifth Congress, first session, approved March 24, 1937 (50 Stat. 51).

ORGANIZATION

The statutory members of the Board of Trustees of the National Gallery of Art are the Chief Justice of the United States, the Secretary of State, the Secretary of the Treasury, and the Secretary of the Smithsonian Institution, *ex officio*. The five general trustees continuing in office during the fiscal year ended June 30, 1951, were Samuel H. Kress, Ferdinand Lamot Belin, Duncan Phillips, Chester Dale, and Paul Mellon. The Board of Trustees held its annual meeting on May 1, 1951. Mr. Kress was reelected President and Mr. Belin Vice President, to serve for the ensuing year. Donald D. Shepard continued to serve during the year as Adviser to the Board.

All the executive officers of the Gallery continued in office during the year:

Huntington Cairns, Secretary-Treasurer.
David E. Finley, Director.
Harry A. McBride, Administrator.
Huntington Cairns, General Counsel.
John Walker, Chief Curator.
Macgill James, Assistant Director.

The three standing committees of the Board, as constituted at the annual meeting on May 1, 1951, were as follows:

EXECUTIVE COMMITTEE

Chief Justice of the United States, *ex officio*, Fred M. Vinson, Chairman.
Samuel H. Kress, Vice Chairman.
Ferdinand Lamot Belin.
Secretary of the Smithsonian Institution, Dr. Alexander Wetmore.
Paul Mellon.

FINANCE COMMITTEE

Secretary of the Treasury, *ex officio*, John W. Snyder, Chairman.
 Samuel H. Kress, Vice Chairman.
 Ferdinand Lammot Belin.
 Chester Dale.
 Paul Mellon.

ACQUISITIONS COMMITTEE

Samuel H. Kress, Chairman.
 Ferdinand Lammot Belin, Vice Chairman.
 Duncan Phillips.
 Chester Dale.
 David E. Finley, *ex officio*.

On June 30, 1951, the Government employees on the staff of the National Gallery of Art numbered 308, which is the same number as on June 30, 1950. The United States Civil Service regulations govern the appointment of employees paid from appropriated public funds.

APPROPRIATIONS

For the fiscal year ended June 30, 1951, the Congress of the United States appropriated for the National Gallery of Art the sum of \$1,179,000 to be used for salaries and expenses in the operation and upkeep of the Gallery, the protection and care of works of art acquired by the Board of Trustees, and all administrative expenses incident thereto as authorized by section 4 (a) of Public Resolution No. 14, Seventy-fifth Congress, first session, approved March 24, 1937 (50 Stat. 51). Of this appropriation \$25,000 was reserved under section 1214 of the General Appropriation Act 1951, Public Law No. 759, Eighty-first Congress, approved September 6, 1950, by the terms of which the Bureau of the Budget was required to save a total of \$550,000,000 from the funds included in the general appropriation bill for the fiscal year 1951. Of the available balance of \$1,154,000 the following expenditures and encumbrances were incurred:

Personal services.....	\$1,004,628.36
Printing and reproduction.....	8,335.41
Supplies, equipment, etc.....	140,976.59
Unobligated balance.....	59.64
	<hr/>
Total.....	1,154,000.00

In the fiscal year 1950, the National Capital Sesquicentennial Commission transferred \$25,000 to the Gallery to be used for expenses incurred in connection with the "Makers of History in Washington, 1800-1950" exhibition which ran for the period from June 29, 1950, to November 19, 1950. A total of \$23,868.94 was spent on the exhibition, and the balance of \$1,131.06 was returned to the United States Treas-

ury Department for the account of the National Capital Sesquicentennial Commission.

ATTENDANCE

There were 1,503,148 visitors to the National Gallery of Art during the fiscal year 1951—a daily average of 4,141. From March 17, 1941, when the National Gallery of Art was opened to the public, to June 30, 1951, the number of visitors totaled 18,761,417.

TENTH ANNIVERSARY CELEBRATION

On March 17, 1951, the tenth anniversary of the opening of the National Gallery of Art, a special night opening was held from 9 until midnight, and on that occasion an exhibition of paintings and sculpture and Renaissance bronzes acquired by the Samuel H. Kress Foundation from 1945 to 1951 was placed on view for the first time. The number of guests attending was 24,350.

ACCESSIONS

There were 4,044 accessions by the National Gallery of Art, as gifts, loans, or deposits, during the fiscal year. Most of the paintings and a number of the prints were placed on exhibition.

PAINTINGS

On October 17, 1950, the Board of Trustees accepted a painting, "Portrait of a Man," attributed to Justus Sustermans, from Mrs. Charles Baird and Mrs. Gerhard H. Dieke. The Board on December 6, 1950, accepted four paintings: "Madonna and Child with Saint Peter and Saint Stephen," Sieneese School, c. 1400, and "Portrait of a Man with a Dog" by Cariani, from Samuel L. Fuller; "Thomas Paine" by Jarvis, from Miss Marian B. Maurice; and an anonymous gift of a portrait of Chief Justice Fred M. Vinson by Thomas E. Stephens. The Board accepted three paintings on May 1, 1951: from Mrs. Albert J. Beveridge, "Madame Dietz-Monin" by Degas; from the estate of Mrs. Julia Marlowe Sothern, a portrait of Mrs. Sothern by Irving R. Wiles; and from Mrs. Richard Southgate, "A Scholar of Merton College, Oxford" by Joseph Highmore. At the same time the Board accepted from the estate of Sam A. Lewisohn "The Bathers" by Gauguin, "Oarsmen at Chatou" by Renoir, and "Mending the Harness" by Ryder. During the year the Board received "Woman with a Cat" by Renoir from Mrs. Benjamin E. Levy.

DECORATIVE ARTS

The Board of Trustees on May 1, 1951, accepted a Gobelins tapestry representing Apollo and Daphne from Lewis Einstein.

PRINTS AND DRAWINGS

On October 17, 1950, the Board of Trustees accepted from David Keppel an engraving, "Portrait of Gellius de Bouma, Minister at Zutphen," by Cornelis Visscher. The Board on December 6, 1950, accepted 1,295 Historical Portrait Prints from Lessing J. Rosenwald. On the same date the Board approved the addition of 46 etchings by Alphonse Legros to the gift by George Matthew Adams of prints and drawings by Legros and other works of art. On December 6, 1950, the Board accepted 295 prints and drawings and again on December 28, 1950, 779 prints and drawings from Lessing J. Rosenwald to be added to his gift to the Gallery; and also during February the Board received from Mr. Rosenwald 10 old-master drawings from the Liechtenstein Collection. The Board on May 1, 1951, accepted an engraving of a portrait of Augustus Stellingwerf, First Lord Admiral of Friesland, by Blooteling after van der Helst, from David Keppel, and a collection of 14 prints of historical portraits from Hermann Wunderlich.

EXCHANGE OF WORKS OF ART

An October 17, 1950, the Board of Trustees accepted the offer of Lessing J. Rosenwald to exchange the Delacroix etching "Rencontre de Cavaliers Maures" for a superior impression of the same work; and on December 6, 1950, the Board also accepted Mr. Rosenwald's offer to exchange a Renoir etching, "La Danse à la Campagne," for a superior impression of the same work.

WORKS OF ART ON LOAN

During the fiscal year 1951 the following works of art were received on loan by the National Gallery of Art:

<i>From</i>	<i>Artist</i>
Mrs. Robert Brookings, Washington, D. C.:	
Isabel Vallé.....	Sargent.
Chester Dale, New York, N. Y.:	
Nude with Red Hair.....	Bellows.
Portrait of a Lady.....	Antonis Mor.
Sir Robert Liston.....	Stuart.
Samuel L. Fuller, New York, N. Y.:	
Portrait of a Lady.....	Salviati.
Madonna and Child.....	Sieneese School, Early XIV Century.
Portrait of a Man.....	Spanish School.
Portrait of a Man and Boy.....	Tintoretto.
William H. Jeffreys, New York, N. Y.:	
The Jeffreys Family.....	Hogarth.

<i>From</i>	<i>Artist</i>
Samuel H. Kress Foundation, New York, N. Y.:	
The Expectant Madonna with Saint Joseph.....	Amiens, School of.
The Adoration of the Magi.....	Angelico, Fra; and Lippi, Fra Filippo.
Portrait of a Young Lute Player.....	Bacchiacca.
Daphne Found Asleep by Apollo.....	Bartolommeo di Giovanni.
Daphne Fleeing from Apollo.....	Bartolommeo di Giovanni.
Portrait of a Man of Letters.....	Bassano, Jacopo.
An Episode from the Life of Publius Cornelius Scipio.	Bellini, Giovanni.
Portrait of a Bearded Man.....	Bellini, Giovanni.
Entrance to a Palace.....	Bellotto, Bernardo.
Saint Anthony Abbot.....	Benaglio, Francesco.
Passion of Our Lord.....	Benvenuto di Giovanni.
Death and the Miser.....	Bosch, Hieronymus.
The Virgin Adoring Her Child.....	Botticelli.
Queen Christina of Sweden.....	Bourdon, Sebastien.
The Resurrection of Lazarus.....	Bramantino.
The Gathering of Manna.....	Bramantino.
The Apparition of Christ among the Apostles...	Bramantino.
Madonna and Child with the Infant Saint John the Baptist.	Bronzino, Agnolo.
Landscape with the Temptation of Saint Anthony Abbot.	Bruegel, Pieter, the Elder.
Landscape with the Martyrdom of Saint Catherine of Alexandria.	Bruegel, Pieter, the Elder.
The Piazzetta in Venice.....	Canaletto.
Il Bacino di San Marco.....	Canaletto.
Landscape.....	Carracci, Annibale.
Venus Adorned by the Graces.....	Carracci, Annibale.
The Dream of Saint Catherine of Alexandria....	Carracci, Lodovico.
Omer Talon.....	Champagne, Philippe de.
The Attentive Nurse.....	Chardin, Jean-Baptiste- Siméon.
The Kitchen Maid.....	Chardin, Jean-Baptiste- Siméon.
Still Life.....	Chardin, Jean-Baptiste- Siméon.
A Donor and His Wife.....	Christus, Petrus.
Madonna and Child with Two Angels.....	Cimabue, School of.
Landscape with Merchants.....	Claude Lorrain.
Madonna and Child.....	Cranach, Lucas, the Elder.
Madonna and Child Enthroned, Surrounded by Angels and Saints.	Daddi, Bernardo.
The Presentation and Marriage of the Virgin, Annunciation.	Diana, Benedetto.
Portrait of a Clergyman.....	Dürer, Albrecht.
Madonna and Child Rev., Lot and His Daughters.	Dürer, Albrecht.
Dona Polyxena Spinola Guzman de Leganes....	Dyck, Sir Anthony van.

<i>From</i>	<i>Artist</i>
Samuel H. Kress Foundation, New York, N. Y.—Continued	
Portrait of a Man.....	Emilian Master, XV Century.
The Assumption of the Virgin.....	Fei, Paolo di Giovanni.
Madonna and Child with Saint Francis.....	Florentine School, c. 1440.
Portrait of a Lady.....	Florentine School, c. 1475.
Saint Anthony of Padua.....	Foppa, Vincenzo.
Altobello Averoldo of Brescia.....	Francia, Francesco.
Madonna in Glory with Infant Christ.....	Garofalo.
The Coronation of the Virgin.....	Ghirlandaio, Domenico.
The Peruzzi Altarpiece.....	Giotto and Assistants.
Crucifixion with Scenes from the Passion and from the Life of John the Baptist.	Giotto, School of.
Saint Jerome Penitent.....	Gossaert, Jan (Mabuse).
Dance of Salome and Beheading of Saint John the Baptist.	Gozzoli, Benozzo.
The Adoration of the Magi.....	Hispano-Dutch Master, Late XV Century.
The Marriage at Cana.....	Hispano-Flemish Master.
Christ among the Doctors.....	Hispano-Flemish Master.
Monsieur Marcotte.....	Ingres, Jean-Auguste Do- minique.
Pope Pius VII in the Sistine Chapel.....	Ingres, Jean-Auguste Do- minique.
Madonna and Child Enthroned.....	Jacopo del Casentino.
The Picnic after the Hunt.....	Lancret, Nicolas.
A French Interior.....	Le Nain, Louis.
Portrait of a Young Lady.....	Leonardo da Vinci Studio.
Saint Jerome in His Study.....	Lippi, Filippino.
Saint Jerome.....	Lotto, Lorenzo.
Christ Blessing.....	Luca di Tomme.
The Christ Child Blessing.....	Mantegna, Andrea.
Portrait of a Man.....	Mantegna, Andrea.
A Miracle of Saint Benedict.....	Marmion, Simon, Studio of.
Portrait of a Man.....	Master of the Archinto Portrait.
The Madonna of Humility.....	Master of the Bucking- ham Palace Madonna.
The Enclosed Garden.....	Master of Flemalle, Studio of.
Saint John the Baptist Meets Two Pharisees....	Master of the Life of Saint John the Baptist.
Birth, Naming, and Circumcision of Saint John the Baptist.	Master of the Life of Saint John the Baptist.
The Obsequies of Saint Anthony Abbot.....	Master of the Osservanza Altarpiece.
The Conversion of an Arion by Saint Remy....	Master of St. Gilles.
The Baptism of Clovis.....	Master of St. Gilles.
Mary Queen of Heaven.....	Master of the Saint Lucy Legend.

<i>From</i>	<i>Artist</i>
Samuel H. Kress Foundation, New York, N. Y.—Continued	
The Crucifixion.....	Matteo di Giovanni.
The Magi before Herod.....	Matteo di Giovanni.
Portrait of a Man.....	Mazzola, Filippo.
Saint Veronica.....	Memling, Hans.
Pieta.....	Moretto da Brescia.
Portrait of a Gentleman in Black.....	Moroni, Giovanni Bat- tista.
Portrait of a Man.....	North Italian School (probably).
Christ among the Doctors.....	Orley, Bernart van.
The Marriage of the Virgin.....	Orley, Bernart van.
The Triumph of Caesar.....	Palma Vecchio.
Rebecca at the Well.....	Pellegrini, Giovanni An- tonio.
Elijah Taken up in a Chariot of Fire.....	Piazzetta, Giovanni Bat- tista.
Young Man in Oriental Costume.....	Piazzetta, Giovanni Bat- tista.
The Feeding of the Child Jupiter.....	Poussin, Nicolas.
Holy Family on the Steps.....	Poussin, Nicolas.
Saint Bartholomew.....	Ribera, Jusepe de.
The Old Bridge.....	Robert, Hubert.
Portrait of a Man in Armor.....	Romanino, Girolamo.
Coral Fishing in Africa.....	Rosa, Salvatore.
Portrait of a Man.....	Rosso.
Portrait of a Knight.....	Savoldo, Giovanni Girol- amo.
The Adoration of the Child.....	Salvoldo, Giovanni Girol- amo.
Cardinal Bandinello Sauli, His Secretary and two Geographers.	Sebastiano del Piombo.
Portrait of a Young Woman as Mary Magdalen.....	Sebastiano del Piombo.
The Adoration of the Shepherds with Saint John the Baptist and Saint Bartholomew.	Sieneese School, c. 1440.
Calvary.....	Signorelli, Luca.
The Flight into Egypt and Christ among the Doctors.	Signorelli, Luca.
Saint George and the Dragon.....	Sodoma.
Bishop Alvise Grimani.....	Strozzi, Bernardo.
Saint Lawrence Giving the Treasures of the Church to the Poor.	Strozzi, Bernardo.
Apollo Pursuing Daphne.....	Tiepolo, Giovanni Battista.
The Sacrifice of Iphigenia.....	Tiepolo, Giovanni Battista.
The Circumcision of the Children.....	Tiepolo, Giovanni Battista.
Venetian Lady in Domino and Tricorne.....	Tiepolo, Giovanni Battista.
The Apotheosis of Orazio Porto.....	Tiepolo, Giovanni Battista.
Portrait of a Member of the Contarini Family.....	Tintoretto.
Portrait of a Procurator of Saint Mark's.....	Tintoretto.
Portrait of a Young Lady as Venus Binding the Eyes of Cupid.	Titian.

<i>From</i>	<i>Artist</i>
Samuel H. Kress Foundation, New York, N. Y.—Continued	
Ranuccio Farnese.....	Titian.
Alessandro Alberti with a Page.....	Titian, Northern Follower of.
Annunciate Virgin, Archangel Gabriel, Saint Francis, Bishop Saint Maurelius.	Tura, Cosimo.
The Flagellation of Christ.....	Umbrian School, c. 1505.
The Holy Family.....	Venetian School, c. 1500.
The Countess of Schoenfeld.....	Vigee-Lebrun, Elizabeth.
Allegory.....	Bordone, Paris.
The Deposition of Christ.....	Greco, El (Domenico Theotokopulos).
Thetis.....	Bernini, Giovanni Lorenzo, School of.
Cupid.....	Bouchardon, Edme.
Apollo of Lycia.....	Candido, Elia.
A Bacchant.....	Clodion (Claude Michel).
A Bacchante.....	Clodion (Claude Michel).
A Bacchante with Cluster of Grapes in Left Hand.	Clodion (Claude Michel).
Madame Royale as an Infant.....	Clodion (Claude Michel).
Poetry and Music.....	Clodion (Claude Michel).
A Vestal.....	Clodion (Claude Michel).
Louis XIV.....	Coysevox, Antoine.
Phillipe, Duc d'Orleans.....	Coysevox, Antoine.
Madame de Pompadour as the Venus of the Doves.	Falconet, Etienne- Maurice.
Saint Barbara.....	Franco-Portuguese School.
Apollo and Marsyas.....	Michelangelo, attributed to.
The Muse Calliope.....	Pajou, Augustin.
Galatea.....	Robert le Lorrain.
The Dew.....	Robert le Lorrain.
Painting and Sculpture.....	Tassaert, Jean-Pierre- Antoine.

C. S. Gulbenkian, Lisbon, Portugal:

3 rare books (from the Wilmerding Collection).

Robert Woods Bliss, Washington, D. C.:

26 objects of Pre-Columbian art.

LOANED WORKS OF ART RETURNED

The following works of art on loan were returned during the fiscal year 1951:

<i>To</i>	<i>Artist</i>
Copley Amory, Washington, D. C.:	
Elizabeth Copley (Mrs. Gardiner Greene).....	Copley.
Self-Portrait.....	Copley.
Chester Dale, New York, N. Y.:	
Le Chevalier Louis Eusebe de Montour.....	Carle (Charles-Andre) Van Loo.

WORKS OF ART LENT

During the fiscal year 1951 the Gallery lent the following works of art for exhibition purposes:

<i>To</i>	<i>Artist</i>
Birmingham Museum of Art, Birmingham, Ala.:	
George Pollock.....	Gilbert Stuart.
Mrs. George Pollock.....	Gilbert Stuart.
Andrew Jackson.....	Thomas Sully.
Fogg Art Museum, Cambridge, Mass.:	
Costume Study (drawing).....	Dürer.
Metropolitan Museum of Art, New York, N. Y.:	
Young Woman in White.....	Robert Henri.
Philadelphia Museum of Art, Philadelphia, Pa.:	
The Dead Toreador.....	Manet.
The Dancer.....	Renoir.
Mrs. Richard Yates.....	Gilbert Stuart.
The White Girl.....	Whistler.
Drawings:	
Tête-à-Tête.....	Boucher.
Costume Study.....	Dürer.
La Petite Loge.....	Moreau le Jeune.
Elieser and Rebecca at the Well.....	Rembrandt.
Colonial Williamsburg and the College of William and Mary, Williamsburg, Va.:	
Henry Laurens.....	J. S. Copley.
Thomas Paine.....	Jarvis.
Benjamin Harrison.....	C. W. Peale.
John Randolph.....	Gilbert Stuart.
Alexander Hamilton.....	John Trumbull.

EXHIBITIONS

During the fiscal year 1951 the following exhibitions were held at the National Gallery of Art:

Rosenwald Collection. Exhibition of recent accessions of prints and drawings in the Lessing J. Rosenwald Collection. Continued from previous fiscal year through October 15, 1950.

"Makers of History in Washington, 1800-1950." Exhibition Celebrating the Sesquicentennial of the Establishment of the Federal Government in the City of Washington. Continued from previous fiscal year through November 19, 1950.

Paintings from the Gulbenkian Collection. Lent for an indefinite period to the National Gallery of Art for exhibition by C. S. Gulbenkian. Opened October 8, 1950.

Canadian Paintings. Exhibition of Canadian paintings arranged by the National Gallery of Canada. October 29 through December 10, 1950.

"Vollard, Connoisseur." Exhibition of prints from the Lessing J. Rosenwald Collection. December 17, 1950, through April 15, 1951.

Kress Collection. Exhibition of paintings, sculpture, and bronzes for the Tenth Anniversary of the National Gallery of Art. Opened March 17, 1951.

Flower Prints, Original Botanical Drawings, and Color-Plate Books. Exhibition from the collection of Mrs. Roy A. Hunt. April 22 through June 10, 1951.

American Paintings from the Collection of the National Gallery of Art. Opened June 17, 1951.

The following exhibitions were displayed in the cafeteria corridor of the National Gallery of Art during the fiscal year 1951:

Folk Sculpture and Folk Painting. Index of American Design. Water-color renderings. Continued from previous fiscal year through August 1, 1950.

Prints by Mary Cassatt. Rosenwald Collection and gift of Miss Elisabeth Achelis. August 2 through October 15, 1950.

Popular Art in the United States. Index of American Design. Water-color renderings. October 16, 1950, through January 14, 1951.

Portraits of Stuart and Tudor Times. Rosenwald Collection and gift of Willis E. Ruffner. January 15 through April 23, 1951.

Etchings by Whistler. Gift of Mr. and Mrs. J. Watson Webb. April 24 through June 24, 1951.

Engravings by William Blake. Gift of anonymous donor. Opened June 25, 1951.

TRAVELING EXHIBITIONS

Rosenwald Collection.—Special exhibitions of prints from the Rosenwald Collection were circulated to the following places during the fiscal year:

Philadelphia Museum of Art, Philadelphia, Pa.:

3 drawings.

October 1950.

University of Minnesota Art Gallery, Minneapolis, Minn.:

3 prints.

October 1950.

American Federation of Arts, Washington, D. C.:

50 prints for circulation by the Federation.

October 1950.

Columbia Museum of Art, Columbia, S. C.:

40 Hogarth and Rowlandson prints.

October 1950.

Philadelphia Art Alliance, Philadelphia, Pa.:

8 prints.

November 1950.

Smith College Museum of Art, Northampton, Mass.:

34 prints.

December 1950.

Pasadena Art Institute, Pasadena, Calif.:

11 Toulouse-Lautrec prints.

January 1951.

University of Pennsylvania Museum, Philadelphia, Pa.:

1 water color.

April 1951.

Index of American Design.—During the fiscal year 1951 exhibitions from this collection were shown in the following States:

<i>State</i>	<i>Number of exhibitions</i>
Arkansas.....	1
California.....	4
Connecticut.....	8
District of Columbia.....	5
Delaware.....	1
Florida.....	2
Illinois.....	1
Indiana.....	1
Kentucky.....	1
Maryland.....	1
Massachusetts.....	2
Michigan.....	2
Minnesota.....	1
Missouri.....	2
New Hampshire.....	1
New York.....	8
North Dakota.....	1
Ohio.....	4
Pennsylvania.....	5
Texas.....	3
Utah.....	1

Two exhibitions from this collection were circulated in Europe during the fiscal year.

CURATORIAL ACTIVITIES

The Curatorial Department accessioned 2,457 new gifts to the Gallery during the fiscal year. Advice was given in the case of 305 works of art brought to the Gallery for opinion, and 41 visits to other collections were made by members of the staff in connection with proffered works of art. About 300 paintings were studied and considered for possible acquisition. A total of 1,311 inquiries requiring research were answered. During the year, 10 individual lectures were given by members of the curatorial staff, both at the Gallery and elsewhere. In addition, Miss Elizabeth Mongan conducted a seminar with Robert Walker for Swarthmore College; and Charles M. Richards gave two courses in art history under the auspices of the Department of Agriculture. Perry B. Cott served as chairman of the Medieval section of the Symposium of the College Art Association held at Dumbarton Oaks; Mr. Richards presented reports to the American Association of Museums meeting in Philadelphia on "Preservation of Essential Records during an Emergency" and "Suggestions for a Work of Art Shipping Label." He served on two committees of the Association, acting as chairman of one. During the year Miss Katharine Shepard was elected secretary of the Washington Society, Archaeological Institute of America.

Special installations were prepared for the European Paintings from the Gulbenkian Collection, lent by C. S. Gulbenkian, Esq., and for Paintings and Sculpture from the Kress Collection acquired by the Samuel H. Kress Foundation, 1945-1951.

The cataloging and filing of photographs in the George Martin Richter Archives continued to make progress, with the gradual enlargement of the collection. Also, about 100 additional catalog notes were prepared for the new catalog of paintings in the National Gallery.

Further activities of the department are indicated under the heading "Publications."

RESTORATION AND REPAIR OF WORKS OF ART

Necessary restoration and repair of works of art in the Gallery's collections were made by Francis Sullivan, resident restorer to the Gallery. All work was completed in the restorer's studio in the Gallery.

PUBLICATIONS

During the year Huntington Cairns contributed an article on the late American philosopher, Morris R. Cohen, to the *Rivista Internazionale di Filosofia del Diritto*; reviews of "Styles in Painting," by Paul Zucker, "Impressionists and Symbolists," by Lionello Venturi, and "Painting in France, 1895-1949," by San Lazzaro, to the *Yale Review*; and the foreword to "Morals and Law: the Growth of Aristotle's Legal Theory," by Max Hamburger. He also delivered a series of eight lectures at the Johns Hopkins University on "The Theory of Criticism."

The book "Paintings from America," by John Walker, published by Penguin Books, Ltd., appeared during this year, and Mr. Walker's book review of "Landscape into Art," by Sir Kenneth Clark, was published in the December 1950 number of *Burlington Magazine*. Also, Mrs. John Shapley contributed an article, "A Predella Panel by Benozzo Gozzoli," to the *Gazette des Beaux-Arts*, 1950.

An illustrated catalog of European Paintings from the Gulbenkian Collection was prepared by Mrs. John Shapley and was issued for the opening of the Gulbenkian exhibition on October 8, 1950. An illustrated catalog of Paintings and Sculpture from the Kress Collection acquired by the Samuel H. Kress Foundation, 1945-1951, was compiled by William E. Suida, curator of research of the Samuel H. Kress Foundation, in collaboration with the Curatorial Department, with foreword by Mr. Finley and introduction by Mr. Walker, for the opening of the Tenth Anniversary Exhibition, March 17, 1951. Perry B. Cott completed a catalog of the Kress Renaissance bronzes for the same opening.

Progress was made on the second volume of "Masterpieces of Painting from the National Gallery of Art" by Huntington Cairns and John Walker; and work on Erwin O. Christensen's second Decorative Arts Handbook, "Objects of Medieval Art," and his third Decorative Arts Handbook, "Jewels and Rock Crystals," approached completion.

During the past fiscal year the Publications Fund added 8 new 11-x-14" color reproductions to the large group already available, and 5 more plates of the new Kress paintings were completed and ready for use; 17 additional new plates in this size were on order. Portfolio No. 2 on "The Life of Christ," containing fifteen 11-x-14" color reproductions and accompanying text, was issued. An exchange of 11-x-14" prints with the Metropolitan Museum in New York was also instituted.

The long-awaited book entitled "The Index of American Design," with a foreword by Erwin O. Christensen, was published during the fiscal year and received wide acclaim. A new type of publication, a guidebook to the Italian paintings, is now on order.

About 3,000 copies of the catalog for the Sesquicentennial Exhibition, put on sale a year ago, were sold; and during the exhibition of Canadian paintings over 300 catalogs as well as portfolios and magazines were distributed.

A new set of Index of American Design playing cards was made available; and three recordings by the National Gallery Symphony Orchestra were put on sale for the first time.

EDUCATIONAL PROGRAM

The attendance for the General, Congressional, and Special Tours, and for the "Picture of the Week," was more than 37,000 for the fiscal year. The Sunday afternoon lectures in the auditorium, by members of the staff and visiting lecturers, continue to be a popular activity of the Education Office. Three Sunday afternoon programs were given over to the showing of educational art films.

The work of the Department has been extended by circulating the black-and-white film strip of 300 paintings from the Gallery's collection; by lending slides and the film "The National Gallery of Art."

The monthly Calendar of Events announcing all the Gallery activities, including notices of exhibitions, new publications, lectures, gallery talks, tours, and concerts, was mailed to approximately 4,700 persons each month.

LIBRARY

The most important contributions to the Library this year were the books, pamphlets, periodicals, and subscriptions purchased out of the fund presented to the National Gallery of Art by Paul Mellon. These included the collection of 2,775 art sales catalogs dating from

1727 through 1948 purchased from Martinus Nijhoff at The Hague, a collection containing several rare manuscript catalogs. Gifts included 145 books, pamphlets, and periodicals, while 700 books, etc., were received on exchange from other institutions. During the year 375 persons other than the Gallery staff have used the Library for research either in person or by phone.

INDEX OF AMERICAN DESIGN

During the fiscal year, 603 examples from the Index were reproduced in various magazines while 284 were borrowed for use in forthcoming publications. Of the 630 persons visiting the Gallery for the purpose of studying Index material, 567 were new users. In all, 948 photographs of Index material were sent out for use by designers, possible publication, for research, study, etc., and for publicity; and 413 slides of Index renderings were used in connection with lectures.

Mr. Christensen, as a member of the faculty of the Seminar in American Culture, New York State Historical Association, Coopers-town, N. Y., participated in lecture courses, panel discussions, and classes.

CARE AND MAINTENANCE OF THE BUILDING

During the past year, the Gallery building and grounds and mechanical equipment were maintained at the high standard established in the past. Considerable redecorating work was done, including the painting of several galleries and offices. Flowering plants, totaling 3,394 in number, and valued at approximately \$6,975, were grown in the moats and used for decoration of the Garden Courts.

The condenser water, chilled-water, and dehumidifier pumps, and the fountain and sump pumps were overhauled; all air-conditioning equipment was inspected, serviced, and repairs made; two refrigeration machines were completely overhauled; new lawn sprinklers were installed in the space between the sidewalk and Constitution Avenue, east of the service entrance; 12 sections of skylight, representing an area of more than 5,000 square feet, were completely overhauled; an azalea storage frame was constructed in the southwest moat with surplus building tile; a contract was entered into in June 1951 for the raising to the original level of the granite and marble platforms at the Mall entrance which had settled and created a potential hazard to the public.

CONSTRUCTION OF NEW GALLERIES AND OFFICES

Work under the contract accepted June 24, 1949, for completing 12 galleries in the east end of the building was completed on July 15,

1950; and work under the contract awarded March 10, 1950, for the completion of five offices with a slide storage room in the west wing on the ground floor for the Educational Office, was completed in December 1950.

A contract was entered into on July 31, 1950, for the completion of five galleries in the west end of the building. It was anticipated that the work on these galleries would be completed early in 1951; however, completion has been greatly delayed because of the difficulty encountered in obtaining the quality of oak flooring called for in the specifications. Private funds were made available for these purposes.

CONSTRUCTION—STORAGE FACILITIES

A contract was entered into on March 1, 1951, to build a storage room adjacent to the Gallery building in the southeast moat. Work is progressing satisfactorily, and it is expected that this project will be completed by late summer.

A contract was entered into on March 2, 1951, to build a storage building and reconstruct a cottage on the site of Randolph-Macon Woman's College, Lynchburg, Va. This work is also progressing satisfactorily and, unless unforeseen delays occur, will be completed in the late autumn of 1951. Both of these projects are being carried out with private funds advanced for these purposes.

OTHER ACTIVITIES

Forty-five Sunday evening concerts were given in the Garden Courts during the fiscal year. The Eighth Annual American Music Festival was held in April, featuring 22 works by American composers. Most of the concerts were broadcast in their entirety by radio station WCFM, Washington. The National Gallery Orchestra also made four long-playing records for WCFM Recording Corporation, recording works by Mozart, Handel, and Ives.

The Photographic Laboratory of the Gallery produced 12,593 prints, 313 black-and-white slides, and 1,723 color slides during the fiscal year, in addition to 2,110 negatives, as well as X-rays, infrared and ultraviolet photographs.

A total of 2,298 press releases and 21,000 invitations for exhibitions at the Gallery were issued during the fiscal year, while 222 permits to copy paintings and 214 permits to photograph were issued. Also 416 releases on current weekly activities of the Gallery were sent to the Washington newspapers, radio station WGMS, and the weekly guidebook, "This Week in the Nation's Capital."

During the year, a group of German leaders in the field of art and other educational and cultural endeavors, toured the United States,

first visiting the National Gallery of Art, where itineraries for their trips were arranged by the Assistant Director's office.

Also, during the year, two Austrian leaders—one a museum official, the other an artist—visited the Gallery and were accorded the same help in making plans for their tour of this country.

OTHER GIFTS

Gifts of books on works of art and related material were made to the Gallery by Paul Mellon and others. Gifts of money during the fiscal year 1951 were made by the A. W. Mellon Educational and Charitable Trust.

AUDIT OF PRIVATE FUNDS OF THE GALLERY

An audit of the private funds of the Gallery has been made for the fiscal year ended June 30, 1951, by Price, Waterhouse & Co., public accountants, and the certificate of that company on its examination of the accounting records maintained for such funds will be forwarded to the Gallery.

Respectfully submitted.

HUNTINGTON CAIRNS, *Secretary.*

THE SECRETARY,
Smithsonian Institution.

APPENDIX 3

Report on the National Collection of Fine Arts

SIR: I have the honor to submit the following report on the activities of the National Collection of Fine Arts for the fiscal year ended June 30, 1951:

THE SMITHSONIAN ART COMMISSION

The twenty-eighth annual meeting of the Smithsonian Art Commission was held in the Regents' Room of the Smithsonian Building on Tuesday, December 5, 1950. The members present were: Paul Manship, chairman; Alexander Wetmore, secretary (member, ex officio); John Nicholas Brown, George H. Edgell, David E. Finley, Gilmore D. Clarke, Archibald G. Wenley, Lloyd Goodrich, John Taylor Arms, Robert Woods Bliss, and George Hewitt Myers. John E. Graf, Assistant Secretary, Smithsonian Institution, Thomas M. Beggs, Director, National Collection of Fine Arts, and Paul V. Gardner, curator of ceramics, National Collection of Fine Arts, were also present.

The resignations of William T. Aldrich and Gifford Beal as members of the Commission were submitted and accepted with regret. The Commission recommended to the Board of Regents Lawrence Grant White to succeed Mr. Aldrich, and Andrew Wyeth to succeed Mr. Beal. The Commission recommended the reelection of John Taylor Arms and Gilmore D. Clarke for the usual 4-year period. The following officers were elected for the ensuing year: Paul Manship, chairman; Robert Woods Bliss, vice chairman, and Dr. Alexander Wetmore, secretary. The following were elected members of the executive committee for the ensuing year: David E. Finley, chairman, Robert Woods Bliss, Gilmore D. Clarke, and George Hewitt Myers. Paul Manship, as chairman of the Commission, and Dr. Alexander Wetmore, as secretary of the Commission, are ex-officio members of the executive committee.

Mr. Beggs reported that the reorganization of the permanent collection progressed steadily during the year as further work of individual artists and various types of artistic work were assembled. Seventeen paintings by Albert Pinkham Ryder, N. A. (1847-1917), have been installed in a gallery to be known as the Ryder Room of the Gellatly Collection. Meissen, Worcester, and Sèvres porcelains

have been grouped by Mr. Gardner for systematic display in the Pell Collection. Two additional storage rooms with movable screens and air conditioning are being provided for the better maintenance of the collections.

Mr. Gardner explained briefly the progress made in a project involving spectrochemical analysis of ancient glass, the purpose being to associate known types with the time and location of their manufacture and to trace ancient trade routes and material sources. An initial group of specimens lent by two museums has been turned over to the National Bureau of Standards for qualitative analysis, the results of which are to be interpreted in collaboration with Ray Smith, of the Archeological Institute of America.

The Secretary outlined briefly further legal action relative to the Gellatly Collection under which the United States Supreme Court had ruled that there were no grounds for reopening the case. He also mentioned briefly tentative suggestions relative to the art collections in connection with present threats of war.

The Commission accepted as a whole the 15 paintings of the Adams-Clement Collection, gift of Miss Mary Louisa Adams Clement in memory of her mother, Louisa Catherine Adams Clement, with discretionary powers to be exercised by the National Collection of Fine Arts in regard to the showing of the individual pictures:

Oil portrait, Mary Louisa Adams, by Asher B. Durand.

Oil portrait, Georgianna Frances Adams, by Asher B. Durand.

Oil portrait, John Adams, by Edward Dalton Marchant.

Oil portrait, George Washington, by Edward Dalton Marchant.

Oil portrait, John Adams, by Gilbert Stuart.

Oil portrait, Joshua Johnson, attributed to John Trumbull.

Oil portrait, Mrs. Joshua Johnson, attributed to John Trumbull.

Oil portrait, John Quincy Adams, by Pieter van Huffel.

Oil portrait, Mrs. John Quincy Adams, by undetermined artist.

Oil portrait, Little Girl (one of the Adams children), by undetermined artist.

Water-color portrait, Mary Louisa Adams, by undetermined artist.

Miniature, Joshua Johnson, by Thomas H. Hull.

Miniature, Boy in Peasant Costume, by Mary Louisa Adams Clement.

Miniature, Portrait of a Young Woman, by Mary Louisa Adams Clement.

Miniature, Louisa Catherine Adams Clement, by Mary Louisa Adams Clement.

The following objects were also accepted:

Oil portrait, Miss Mildred Lee, by S. Seymour Thomas. Gift of the artist.

Oil portrait, Col. William Shakespeare King, by George Catlin. Gift of Daniel Packard King and Allene Packard King, through Mrs. Harry Lazelle King.

Oil portrait, Townsend Bradley Martin, by Abbott H. Thayer, N. A. Gift of Mrs. Grosvenor Backus.

Oil painting, Great Western, by William Marsh. Gift of Mrs. Alfred Bornmann, in memory of her father, Frederick Boesen.

Oil painting, Street Shrine, by Jerome Myers, N. A. Henry Ward Ranger bequest.

Fourteen pieces of modern glass including Austrian, Dutch, French, and Swedish. Gift of Mr. and Mrs. Hugh J. Smith, Jr.

Four items of Bohemian glass. Gift of Mrs. John E. Lodge.

A collection of 50 miniatures by American and foreign artists. Gift of Mrs. Henry L. Milmore.

THE CATHERINE WALDEN MYER FUND

Eight miniatures, water color on ivory unless otherwise stated, were acquired from the fund established through the bequest of the late Catherine Walden Myer, as follows:

71. August Fricke, by Henry Elouis; from Edmund Bury, Philadelphia, Pa.

72. A Member of the Washington Family, attributed to James Peale; from the estate of H. W. A. Cooke (L. B. Alexander, executor), through Mrs. J. H. Reiter.

73. Zachariah F. Johnston, by undetermined artist; from Conrad Reid, Washington, D. C.

74. Mrs. Frances Barton Stockton, by Hugh Bridport.

75. Mrs. John McCluney, by James Peale.

76. Portrait of a Gentleman, by James Peale.

77. Dr. Joseph Glover, by Charles Fraser.

(Numbers 74 through 77 were acquired from the Mr. and Mrs. Norvin Green Sale, Parke-Bernet Galleries, Inc., New York City.)

78. Rev. William White, D. D. (Bishop of Pennsylvania, 1747-1836), enamel, by William Birch; from Katharine Woodward, Middleburg, Va.

STUDY COLLECTION

The following were accepted by the Smithsonian Institution for the Study Collection of the National Collection of Fine Arts:

Ten pieces of Sèvres (4 cups and saucers, 1 sugar bowl without cover, 1 cream pitcher), and eight pieces of Worcester type (2 small pitchers, 1 sugar bowl with cover, 2 bonbon dishes, 1 cup and saucer), the gift of Mrs. John E. Lodge.

An Oriental ceramic, Ch'ien Lung (1736-1795) vase with base, the gift of Mrs. James W. Riekey.

A piece of stained glass from one of the shattered windows of the demolished cathedral at Verdun, France, period of World War I, was transferred from the division of military and naval history, Department of History, United States National Museum.

ALICE PIKE BARNEY LOAN COLLECTION

On January 1, 1951, a collection of approximately 224 paintings by Alice Pike Barney (1860-1931), well-known Washington artist, social worker, and civic leader, 54 pictures by other artists, together with many sculptures and objects of art, was presented to the Smithsonian Institution by her daughters, Natalie Clifford Barney and Laura Dreyfus-Barney. This collection is to be used by the National Collection of Fine Arts as the nucleus of a loan collection for the embellishment of Federal buildings and for lending to museums, libraries,

colleges, and other educational institutions for the development of public appreciation of art in this country.

An oil painting, *Old Woman and Child*, by Hendrik Maarten Krabbe, was given by Mrs. Edith Newlands Johnston and Mrs. William B. Johnston for use as a loan to museums, libraries, and colleges.

ALICE PIKE BARNEY MEMORIAL FUND

A generous fund has also been given to the Smithsonian Institution by Natalie Clifford Barney and Laura Dreyfus-Barney for the use of the National Collection of Fine Arts in maintaining the Alice Pike Barney Loan Collection and in organizing and circulating traveling exhibitions for the development of art appreciation in the United States.

TRANSFERS ACCEPTED

A full-length plaster cast of the statue of George Washington, executed by William J. Hubbard from the original statue in marble by Jean Antoine Houdon, was transferred from the United States Capitol on July 21, 1950.

Seventeen oil paintings, ten oil sketches, and ten crayon studies of Arctic and Antarctic scenes, by Frank W. Stokes, were transferred from the United States National Museum on August 1, 1950.

An oil portrait, *Alexandre Dumas*, by William H. Powell, A. N. A., was transferred from the Public Library of the District of Columbia on August 17, 1950.

An oil, *Your Forests, Your Fault, Your Loss*, by James Montgomery Flagg, was transferred from the United States Forest Service on October 13, 1950.

TRANSFERS TO OTHER DEPARTMENTS

Twelve medals awarded to Edmund C. Tarbell, N. A. (1862-1938), given by the heirs of Edmund C. and Emeline Tarbell, were accepted for the Smithsonian Institution and transferred to the division of numismatics, Department of History, United States National Museum, June 29, 1951.

LOANS ACCEPTED

Three pieces of Bohemian glass were lent by Mrs. John E. Lodge, Washington, D. C., on July 17, 1950.

A silver sugar bowl and a silver cream pitcher, made by William Thompson, were lent by William E. Huntington, Washington, D. C., on October 20, 1950.

A bronze, *Destiny of the Red Man*, by Adolph A. Weinman, was lent by the R. W. Norton Art Foundation, Shreveport, La., on December 7, 1950.

Two oils, portraits of Charles II and the Earl of Lauderdale, by undetermined artists, were lent by Lady Ross of Balnagown Castle, Ross-shire, Scotland, on March 22, 1951.

WITHDRAWALS BY OWNERS

Two oils, portraits of Lady Mary Ross and the late Sir Charles W. A. Ross, by Andrew Somerville, lent by the Bruce Corporation (Ltd.), of Kildary, Scotland, and Wilmington, Del., through Sir Charles Ross on December 2, 1926, and one miniature, portrait of the 8th Baronet, Sir Charles Ross, by E. C. Thomson, lent by Lady Ross on April 4, 1949, were withdrawn by Lady Ross for shipment to Balnagown Castle, Ross-shire, Scotland, on March 21, 1951.

LOANS TO OTHER MUSEUMS AND ORGANIZATIONS

Two oils, *Moonrise at Ogunquit*, by Hobart Nichols, and *The Storm*, by Ludwick Backhuysen, were lent to the Bureau of the Budget on July 27, 1950, for a period not to exceed 4 years. (*The Storm* was returned on March 28, 1951.)

Twenty-five booklets of sketches on the protective coloration in the Animal Kingdom, by Abbott H. Thayer, and a bird model used by him were lent to Mrs. Mary Fuertes Boynton, Trumansburg, N. Y., on December 7, 1950, for lecture purposes. (Returned January 8, 1951.)

Two Japanese cloisonné vases were lent to Howard University on January 15, 1951, to be used as exhibition material in connection with a series of lectures on Asia and the Asians, January 15 through 30, 1951. (Returned January 31, 1951.)

Oil, *Fired On*, by Frederic Remington, was lent to the Denver Art Museum on February 9, 1951, for an exhibition, "Life in America," held in its new Schleier Gallery, March 4 to April 30, 1951. (Returned May 14, 1951.)

Bronze, *Field Artillery*, by Herbert Haseltine, with pedestal, was lent at the request of the owner, Hon. Robert Woods Bliss, to The Baltimore Museum of Art on April 6, 1951, to be included in the special exhibition of "Sculpture of Herbert Haseltine," April 16 through June 3, 1951. (Returned June 6, 1951.)

Three water colors, *Ancient Castle*, by Georgette Agutte, *Sketch of a Village*, by Albert Lebourg, and *The Windmill*, by Guillaume Tronchet, and one drawing, colored crayon and pencil, *Landscape*,

by Henri Le Sidaner, were lent to the Bureau of the Budget on May 16, 1951, for a period not to exceed four years.

Nine oil paintings, *Elf Ground*, by George Inness; *At Nature's Mirror*, by Ralph A. Blakelock; *Spring*, by Alexander H. Wyant; *Indian Summer*, by John Francis Murphy; *The Return from the Fold*, by Elliott Daingerfield; *Lower Ausable Pond*, by Homer D. Martin; *Cliffs of the Upper Colorado River, Wyoming Territory*, by Thomas Moran; *In Jamaica*, by William H. Holmes (owned by Glenn J. Martin); and *October*, by Robert C. Minor (owned by the United States National Museum), were lent to Howard University on April 24, 1951, to be included in the May Festival from May 1 to June 15, 1951. (Returned June 20, 1951.)

LOANS RETURNED

Oil, portrait of Commodore Stephen Decatur, by Gilbert Stuart, lent to the Truxtun-Decatur Naval Museum on April 27, 1950, to be included in their first exhibition, was returned on September 26, 1950.

Three oil paintings, *Gen. John J. Pershing*, by Douglas Volk; *Admiral William S. Sims*, by Irving R. Wiles; and *Gen. William T. Sherman*, by George P. A. Healy; and one marble bust of Alexander Graham Bell, by Moses W. Dykaar, lent to the National Gallery of Art on May 22, 1950, to be included in the Sesquicentennial celebration, "Makers of History in Washington, 1800-1950," were returned November 27, 1950.

THE HENRY WARD RANGER FUND

The paintings purchased by the Council of the National Academy of Design from the fund provided by the Henry Ward Ranger bequest, which, under certain conditions, are prospective additions to the National Collection of Fine Arts, are as follows:

<i>Title</i>	<i>Artist</i>	<i>Date of purchase</i>
126. New Lebanon Railroad Station.	Louis Bouche, N. A. (1896-)	Mar. 19, 1951
127. The City—No. 2	Ralph Gleitsmann (1910-)	Mar. 19, 1951
128. Harbor	Xavier Gonzalez (1899-)	Mar. 19, 1951
129. Four Houses	Antonio P. Martino, N. A. (1902-)	Mar. 19, 1951
130. Night	Albert John Pucci (1920-)	Mar. 19, 1951
131. Paris (water color)	William A. Smith, A. N. A.	Mar. 19, 1951
132. Farm in Essex	Gifford Beal, N. A. (1879-)	May 7, 1951
133. Nine Men	Joseph Hirsch (1910-)	May 7, 1951
134. Rabbit Island, Hawaii (water color).	Millard Sheets, N. A. (1907-)	May 7, 1951
135. Blacksmith Shop (water color).	John Alonzo Williams, N. A. (1869-)	May 7, 1951
136. Chimney Beams (water color).	Andrew Wyeth, N. A. (1917-)	May 7, 1951

Since it is a provision of the Ranger bequest that the paintings purchased by the Council from this fund and assigned to American art institutions may be claimed by the National Collection of Fine Arts during the 5-year period beginning 10 years after the death of the artist represented, five paintings were recalled for action of the Smithsonian Art Commission at its meeting on December 5, 1950.

One painting, listed earlier in this report, was accepted by the Commission to become a permanent accession.

The following four paintings were returned to the institutions to which they were originally assigned by the National Academy of Design, as indicated.

No. 19. *East Coast, Dominica, British West Indies*, by Frederick J. Waugh, N. A. (1861-1940), assigned to the Museum of History, Science, and Art, Los Angeles County Museum, Los Angeles, Calif.

No. 87. *Eagle Lake*, by Jonas Lie, N. A. (1880-1940), assigned to the Iowa Memorial Union, State University of Iowa, Iowa City, Iowa.

No. 99. *Easterly Coming*, by Charles H. Woodbury, N. A. (1864-1940), assigned to the Society of Liberal Arts, Joslyn Memorial Art Museum, Omaha, Nebr.

No. 113. *Fifteenth Century French Madonna and Child*, by Harry W. Watrous, N. A. (1857-1940), assigned to the Coker College for Women, Hartsville, S. C.

THE NATIONAL COLLECTION OF FINE ARTS REFERENCE LIBRARY

In all, 280 publications (173 volumes and 107 pamphlets) were accessioned during the year; 671 parts of periodicals were entered in the periodical record; and 17 volumes and 45 pamphlets (serials) were entered in the catalog. The total accessions in the National Collection of Fine Arts Library now number 12,026.

INFORMATION SERVICE

The requests of 1,629 visitors received special attention, as did many similar requests by mail and phone. During the year 1,285 art works were submitted for identification.

The members of the staff served as judges or as members of juries of selection and award for a number of exhibitions held in and around Washington.

SPECIAL EXHIBITIONS

Sixteen special exhibitions were held during the year as follows:

July 1 through 25, 1950.—Exhibition of 56 paintings of Ancient Egyptian Monuments, by Joseph Lindon Smith, held under the patronage of His Excellency Mohamed Kamil Abdul Rahim Bey, Ambassador of Egypt. A catalog was provided. This exhibition opened on June 8.

August 6 through 28, 1950.—Exhibition of Ceramic Art by The Kiln Club of Washington, consisting of 62 pieces by local ceramic artists and 75 pieces by outstanding artists in this and other countries, lent by the artists themselves or

by embassies and collectors. The technique of throwing on the potter's wheel was demonstrated. A catalog was privately printed.

August 6 through 28, 1950.—Exhibition of 31 pieces of sculpture by the Washington Sculptors Group. Gallery talks and demonstrations were given.

September 8 through 24, 1950.—Exhibition of Pictorial Art of the American Indian: A Living Tradition, from the collections of the Philbrook Art Center and the Department of Anthropology of the United States National Museum, consisting of 158 paintings, drawings, and other examples of graphic art.

October 8 through 29, 1950.—The Eighth Annual Exhibition of The Artists' Guild of Washington, consisting of 86 oils and sculpture. A catalog was privately printed.

November 5 through 26, 1950.—The Thirteenth Metropolitan State Art Contest, held under the auspices of the District of Columbia Chapter, American Artists Professional League, assisted by the Entre Nous Club, consisting of 333 paintings, sculpture, prints, ceramics, and metalcraft. A catalog was privately printed.

December 10 through 29, 1950.—The Fifty-fourth Annual Exhibition of the Washington Water Color Club, consisting of 174 water colors, etchings, and drawings. A catalog was privately printed.

February 8 through 27, 1951.—The Fifty-ninth Annual Exhibition of the Society of Washington Artists, consisting of 47 paintings and 7 pieces of sculpture. A catalog was privately printed.

February 23, 1951.—The opening of the Albert Pinkham Ryder Room of the John Gellatly Collection.

March 8 through 28, 1951.—Memorial Exhibition of 84 oil paintings and pastels by Alice Pike Barney (1860-1931). A catalog was published.

March 9 through 29, 1951.—Exhibition of 48 paintings and sculpture by artists from El Salvador, sponsored by the Ambassador of El Salvador to the United States, Dr. Héctor David Castro, under the auspices of the Pan American Union. A catalog was privately printed.

April 13, 1951.—The opening of an exhibition of the Adams-Clement Collection given by the late Mary Louisa Adams Clement to the National Collection of Fine Arts and the Department of History of the United States National Museum, in the west hall of the Arts and Industries Building.

May 6 through 30, 1951.—The Eighteenth Annual Exhibition of The Miniature Painters, Sculptors and Gravers Society of Washington, D. C., consisting of 180 examples. A catalog was privately printed.

May 17 through July 1951.—A Centennial Anniversary Exhibition of Paintings by Thomas Wilmer Dewing, N. A. (1851-1938). Twenty paintings were shown in the Natural History Building and twenty-one in the Freer Gallery of Art. A list was mimeographed.

June 7 through 27, 1951.—The Second Annual Exhibition of the Florida Artist Group, consisting of 24 paintings. A catalog was privately printed.

June 8 through 26, 1951.—An exhibition of 147 Swiss posters, held under the patronage of His Excellency Charles Bruggmann, Minister of Switzerland, and the auspices of the American Federation of Arts. A catalog was privately printed.

Respectfully submitted.

THOMAS M. BEGGS, *Director.*

Dr. A. WETMORE,

Secretary, Smithsonian Institution.

APPENDIX 4

Report on the Freer Gallery of Art

SIR: I have the honor to submit the thirty-first annual report on the Freer Gallery of Art for the year ended June 30, 1951.

THE COLLECTIONS

Additions to the collections by purchase were as follows:

BRONZE

- 50.7. Chinese, Chou dynasty (1122-256 B. C., early). A ceremonial vessel of the type *fang ting*. Design cast in relief and intaglio, the latter filled in with black substance. Inside one side a 41-character inscription. $0.263 \times 0.246 \times 0.107$.
- 50.9. Chinese, Shang dynasty (ca. 1766-1122 B. C.). A ceremonial weapon of the type *ko*, inlaid with turquoise. Protruding bottle horns. 0.096×0.411 .
- 50.10. Chinese, Chou dynasty (1122-256 B. C., late). Gilt bronze plaque inlaid with jade, turquoise, carnelian, and silver. Relief design of fabulous animals sporting among waves. 0.028×0.095 .
- 50.17. Chinese, Chou dynasty (1122-256 B. C., late). Incense burner of the type *hsiang-lu*. Decorations incised, gilded, and inlaid with gold; open-work cover; powdery gray-green patina. 0.107×0.103 .
- 50.18. Chinese, Chou dynasty (1122-256 B. C., early). A ceremonial vessel of the type *fang tsun*. Design cast in high and low relief. Twelve-character inscription cast inside bottom. 0.279×0.290 . (Illustrated.)
- 51.2. Chinese, Han dynasty (207 B. C.-A. D. 220). A cylindrical covered box of the type *lien*. Incised designs on sides and cover; removable tray inside. Loose ring on cover, and three very low feet. 0.142×0.155 .
- 51.5. Chinese, Han dynasty (207 B. C.-A. D. 220). A cylindrical vessel of the type *lien* with cover missing. Design of fabulous beasts in landscape cast in high and low relief and incised; two loose ring handles on sides; three feet in form of bears. 0.177×0.255 .
- 51.6. Chinese, Han dynasty (207 B. C.-A. D. 220). Garment hook, *kou*, inlaid with turquoise. A tiger, a water-buffalo head, and a snake head in relief. 0.217 .
- 51.7. Chinese, Chou dynasty (1122-256 B. C., late). Statuette in two parts: (1) figure of a dancing man in nomad costume with belt and dagger, with upraised arms; (2) a small bear crouched on top of a pole the lower end of which is socketed to fit the man's right arm. 0.164 over all.

METALWORK

- 50.5. Persian, 10th-11th century. A silver bottle of globular shape with flaring foot and tall, straight neck. Decoration includes birds, animals, and inscriptions in relief with niello and gilding. 0.249×0.120 . (Illustrated.)

- 50.6. Persian, 10th century. A silver bowl of shallow form with no foot. Decorated inside with two bands of inscription surrounding an eagle in the center, all incised in the metal. 0.043 x 0.239.
- 50.21. Persian, 12th-13th century. A bracelet made in eight links; gold decorated with filigree and niello outlining birds, floral scrolls, and inscriptions. Stones missing. 0.197 x 0.030.

PAINTING

- 50.11. Chinese, Ch'ing dynasty (A. D. 1644-1912). Scroll painting by Wu Tan dated in correspondence with A. D. 1675. Landscape in ink and color on paper; inscription, artist's signature, and two seals on painting; label, four inscriptions, and seven seals on mounting. 0.179 x 2.614.
- 50.19. Chinese, Ch'ing dynasty (A. D. 1644-1912). Scroll painting by Wang Hui (1632-1717). Landscape in ink and color on paper; eight seals on painting; three inscriptions and seven seals on mounting. 0.384 x 7.435.
- 50.20. Chinese, Yüan dynasty (A. D. 1260-1368). Scroll painting by Chu Te-jun dated in correspondence with A. D. 1364. Landscape in ink and color on paper, signature, 45 seals, and 2 inscriptions on the painting; 68 seals and 26 inscriptions on the mounting. 0.283 x 2.112.
- 50.23. Japanese, Kamakura period (A. D. 1186-1334). Portrait by Fujiwara Nobuzane (1176-1268) of Onakatomi no Yoritomo; one of a set of 36 poets painted in ink and colors on paper; inscription on painting. 0.279 x 0.511. (Illustrated.)
- 50.24. Japanese, Kamakura period (A. D. 1186-1334). Portrait by Fujiwara Nobuzane (1176-1268) of the poetess Saigu no Nyogo; one of a set of 36 poets painted in ink and colors on paper; inscription on painting. 0.279 x 0.511.
- 50.25. Japanese, Kamakura period (A. D. 1186-1334). Portrait by Fujiwara Nobuzane (1176-1268) of Minamoto no Kintada; one of a set of 36 poets painted in ink and colors on paper; inscription on painting. 0.279 x 0.511.

POTTERY

- 50.8. Chinese, Sung dynasty (A. D. 960-1279). *Chün* ware bottle with pear-shaped body and tall, slightly flaring neck; gray-blue glaze with purple splashes. 0.280 x 0.128.
- 50.12. Chinese, Chou dynasty (1122-256 B. C., late). Figure of a horse; soft, dark-brown clay with polished black surface; traces of red pigment. 0.080 x 0.092.
- 50.13. Chinese, Chou dynasty (1122-256 B. C., late). Figure of a dancing woman; soft, dark-brown clay with polished black surface; traces of red pigment. 0.107.
- 50.14. Chinese, Chou dynasty (1122-256 B. C., late). Figure of a standing woman; soft, dark-brown clay with polished black surface; traces of red pigment. 0.081.
- 50.15. Chinese, Chou dynasty (1122-256 B. C., late). Figure of a warrior; soft, dark-brown clay with polished black surface; traces of red pigment. 0.068.
- 50.16. Chinese, Ch'ing dynasty (A. D. 1644-1912). Peach-bloom vase of slender form with flaring lip and deep narrow foot; 6-character mark of the K'ang-hsi period (A. D. 1662-1722). 0.150 x 0.053.
- 50.22. Chinese, Sung dynasty (A. D. 960-1279). Southern *kuan* ware vase of bottle shape with glassy, crackled glaze of mottled brown. 0.139 x 0.088.

- 51.1. Chinese, Sung dynasty (A. D. 960-1279). Bowl of *chien* type from Yü Chou, Honan; ferruginous glaze running from reddish brown to deep glossy black. 0.085 x 0.143.
- 51.3. Chinese, Ming dynasty (A. D. 1368-1644, early). Bowl of Yung-lo type; white porcelain decorated with floral designs in underglaze blue; iron-red wash on unglazed base. 0.157 x 0.410.
- 51.4. Chinese, Ming dynasty (A. D. 1368-1644). Bowl of white porcelain with floral designs reserved in white against a ground of underglaze blue; 6-character mark of the Hsüan-tê period (A. D. 1426-1435) on base. 0.087 x 0.187.

REPAIRS TO THE COLLECTION

A total of 114 objects were cleaned, resurfaced, remounted or repaired as follows:

American paintings	103
Chinese paintings repaired.....	2
Chinese pottery repaired.....	2
Japanese pottery repaired.....	1
Persian pottery repaired.....	1

This includes the final work of cleaning and restoration of the Whistler Peacock Room mentioned in the last three annual reports. The room was reopened to the public on October 13, 1950. Work on the Peacock Room and on all other American paintings was carried out as before by John and Richard Finlayson of Boston.

CHANGES IN EXHIBITIONS

Changes in exhibitions totaled 907 as follows:

American art:	
Oil paintings	108
Pastels.....	31
Silverpoints	2
Water colors	11
Chinese art:	
Bronze.....	292
Jade	300
Marble.....	4
Metalwork.....	52
Pottery.....	35
Stone sculpture.....	34
Japanese art:	
Lacquer sculpture.....	2
Paintings	34
Pottery.....	2

LIBRARY

During the year the following work was accomplished in the library: Accessions of all kinds including books, pamphlets, periodicals, study material, and photographs, 780; cataloging of all kinds, includ-

ing cards typed and filed, 4,096; binding, labeling, repairing, and mounting, 496. Mr. Freer's letters from Canfield, Dewing, Metcalf, Thayer, Tryon, and other artists represented in the collection were arranged chronologically and listed on cards which were filed; this project is continuing and these letters will be indexed in the future. Cataloging was completed of the collection of rare books purchased by Mr. Freer in the Orient; and two bibliographies were prepared for publication. Work continued on the major project of indexing both the English and Japanese editions of the Japanese periodical *Kokka*.

PUBLICATIONS

Five publications of the Gallery were issued during the year:

- Ettinghausen, Richard: *Studies in Muslim Iconography, I. The Unicorn*. Occasional Papers, vol. I, No. 3. S. I. Publ. 3993. September 1950.
 Freer Gallery of Art Pamphlet, revised edition. September 1950.
 Gallery Book VIII—*The Art of India*. October 1950.
 Steindorff, George: *A Royal Head from Ancient Egypt*. Occasional Papers, vol. I, No. 5. S. I. Publ. 4022. February 1951.
 The Whistler Peacock Room. An illustrated pamphlet containing a brief description and history of the Peacock Room decorated by James A. McNeill Whistler. S. I. Publ. 4024. April 1951.

Papers by staff members in outside publications were as follows:

- Pope, John A.: *Ming blue-and-white at Philadelphia*. *Oriental Art*, vol. 3, No. 1 (1950), pp. 21–27.
 ——— Selected Chinese antiquities from the collection of Gustav Adolf, Crown Prince of Sweden, by Nils Palmgren. (A review.) *The Far Eastern Quarterly*, vol. 10, No. 1 (Nov. 1950), pp. 85–89.
 ——— Letter from the Near East. *Harvard Journal of Asiatic Studies*, vol. 13, Nos. 3 and 4 (Dec. 1950), pp. 558–564.
 Wenley, A. G.: Selected Chinese antiquities from the collection of Gustav Adolf, Crown Prince of Sweden, by Nils Palmgren. (A review.) *The Journal of the American Oriental Society*, vol. 69, No. 3 (Oct./Dec. 1949), pp. 238–239.

REPRODUCTIONS

During the year the photographic laboratory made 3,809 prints, 433 glass negatives, and 189 lantern slides.

BUILDING

The cabinet shop has been kept busy with the usual work of making necessary equipment, doing repair work on the collections and making minor repairs on the building. A temporary painter made a small start on the long-accumulated backlog of work in the redecoration of the exhibition galleries and painting other parts of the building.



50.23

RECENT ADDITION TO THE COLLECTION OF THE FREER GALLERY OF ART



50.5

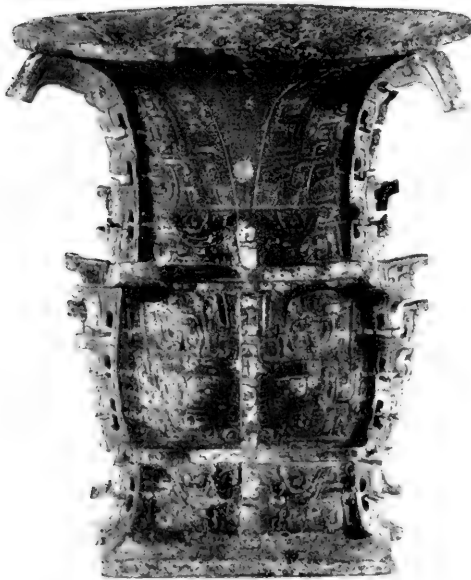

50.18

RECENT ADDITION TO THE COLLECTION OF THE FREER GALLERY OF ART

At the end of the year work was begun on the construction of a technical research laboratory in the west end of the building.

The firm of Keally and Patterson, architects, of New York, completed a survey of the building with a view to modernization of the lighting throughout, air conditioning, and effecting structural changes for enlarging the library and adding much-needed office space. Plans were also drawn for a proposed addition to the building. All this work was preliminary in nature.

ATTENDANCE

The Gallery was open to the public from 9 to 4:30 every day except Christmas Day. The total number of visitors to come in the main entrance was 62,895. The weekday total was 49,893, and the Sunday total 13,002. The highest monthly attendance was in July, 8,407, and the lowest was in December, 2,281.

There were 1,471 visitors to the office during the year.

HERZFELD ARCHIVE

Mrs. Charlotte Bradford, sister of the late Ernst Herzfeld, presented to the Herzfeld Archive additional squeezes, plans, maps, drawings, etc., executed by Professor Herzfeld.

STAFF ACTIVITIES

The work of the staff members has been devoted to the study of new accessions, of objects contemplated for purchase, and to general research within the collections of Chinese, Japanese, Persian, Arabic, and Indian materials. Reports, oral or written, were made upon 2,377 objects as follows: Belonging to private individuals, 1,552; belonging to dealers, 705; at other museums, 120. In all, 289 photographs of objects were examined, and 242 Oriental language inscriptions were translated for visitors. By request, 10 groups met in the exhibition galleries for docent service by staff members; the total attendance was 208. Two members of the staff spent parts of the year engaged in research projects outside the United States as follows:

During the summer months of 1950, Mr. Pope traveled to the Near East to study the uniquely important Chinese porcelain collections in Tehran and Istanbul. In Iran, additional material was examined in Mashhad and Isfahan; and passing through Europe to and from the Near East provided an opportunity to see important Chinese ceramics in museums and private collections in Bristol, Cirencester, Oxford, London, Paris, Amsterdam, and Leeuwarden, as well as scattered examples in Rotterdam, Rome, Faenza, Venice, and Zürich.

In October Dr. Ettinghausen began a year's study trip to the Near East. After a month in Europe, he proceeded to Cairo where he studied for two months. A brief stop was made in Baghdad en route to Iran where he spent four months studying and visiting the important sites and monuments. At the end of the year he was continuing his work in Afghanistan.

By invitation the following lectures were given outside the Gallery by staff members:

1950

- Nov. 5. Mr. Pope addressed the fall meeting of the Far Eastern Ceramic Group in the Brooklyn Museum on "Notes on Chinese Ceramics in the Near East." (Illustrated.) Attendance, 40.
- Dec. 7. Mr. Pope addressed the Washington Society of the Archaeological Institute of America at the Corcoran Gallery of Art on "Chinese Porcelain in Europe and the Near East." (Illustrated.) Attendance, 40.

1951

- Jan. 8. Dr. Ettinghausen addressed the faculty of art, Faruk I University, Alexandria, Egypt, on "Animal Lore in Moslem Art." (Illustrated.) Attendance, 60.
- Jan. 9. Dr. Ettinghausen addressed the Société Royale d'Archéologie of Alexandria, Egypt, on "Moslem Art in the West from the Middle Ages to Modern Times." (Illustrated.) Attendance, 75.
- Jan. 11. Mr. Pope addressed the annual dinner of the Smithsonian Board of Regents, giving a brief account of his findings in the Near East. Attendance, 25.
- Jan. 17. Dr. Ettinghausen addressed the U. S. Offices of Information and Educational Exchange, at the U. S. Embassy, Cairo, Egypt, on "Animal Lore in Moslem Art." (Illustrated.) Attendance, 75.
- Jan. 22. Mr. Pope addressed the Fine Arts Group of the Special Libraries Association in the Whittall pavilion of the Library of Congress, on "Chinese Porcelain in Europe and the Near East." (Illustrated.) Attendance, 25.
- Mar. 6. Dr. Ettinghausen addressed a group at the Tehran University, Tehran, Iran, on "Science and Fiction in Islamic Art." (Illustrated.) Attendance, 120.
- Mar. 27. Mr. Pope addressed the Far Eastern Art and Archaeology Section of the annual meeting of the Far Eastern Association at Philadelphia on "Two Kamakura Kongorikishi." (Illustrated.) Attendance, 60.

During the year 7 members of the staff made a total of 16 trips outside of Washington on official business.

Members of the staff held honorary posts and undertook additional duties outside the Gallery as follows:

- Mr. Wenley: Trustee, Hermitage Foundation, Norfolk, Va.
 Chairman of the Louise Wallace Hackney Scholarship Committee of the American Oriental Society.
 Trustee, Textile Museum of the District of Columbia.
 Member, Visiting Committee, Dumbarton Oaks Research Library and Collection.

- Mr. Wenley—Cont.** Member, Smithsonian Art Commission.
 Research Professor of Oriental Art, University of Michigan.
 Member, Committee of Expert Examiners, U. S. Civil Service
 Commission, for the Smithsonian Institution.
- Mr. Pope:** President, Far Eastern Ceramic Group.
 Art Editor, Far Eastern Quarterly.
 Member, Two Advisory Selection Committees for Fulbright
 Awards in Fine Arts and Architecture, under the Con-
 ference Board of Associated Research Councils. (One
 meeting in New York, one in Washington, both *ad hoc.*)
- Dr. Ettinghausen:** Editor, Bibliography of the Near East prepared by the Com-
 mittee on Near Eastern Studies, American Council of
 Learned Societies.
 Editor, *Ars Islamica.*

Respectfully submitted.

A. G. WENLEY, *Director.*

Dr. A. WETMORE,
Secretary, Smithsonian Institution.

APPENDIX 5

Report on the Bureau of American Ethnology

SIR: I have the honor to submit the following report on the field researches, office work, and other operations of the Bureau of American Ethnology during the fiscal year ended June 30, 1951, conducted in accordance with the Act of Congress of April 10, 1928, as amended August 22, 1949, which provides for continuing "independently or in cooperation anthropological researches among the American Indians and the natives of lands under the jurisdiction or protection of the United States and the excavation and preservation of archeologic remains."

SYSTEMATIC RESEARCHES

Dr. M. W. Stirling, Director of the Bureau, left Washington early in January to continue the program of archeological work in Panamá inaugurated in 1948 in cooperation with the National Geographic Society. En route, he made stops of several days each in México, Guatemala, El Salvador, and Costa Rica to study and photograph archeological collections in those countries. In Panamá the primary objective was an archeological reconnaissance on the relatively unexplored Atlantic coast of Panamá lying between the Canal Zone and the Chiriquí lagoon. It was here in 1502 that Columbus attempted to establish the first European colony on the American mainland. Three river systems in this region were explored—the Río Salud, Río Indio, and Río Coclé del Norte. The latter is the largest river on the Panamá north coast. Columbus found this region inhabited by Indians who wore gold ornaments and who did not live in villages but in single houses separated from one another by considerable distances. Dr. Stirling's archeological work confirmed this observation. The archeological remains consisted primarily of pottery and stone objects removed from the refuse deposits where the houses had stood. Near the coast the pottery was simple in style, unpainted, and with a limited variety of forms. Near the headwaters of the rivers the pottery became more elaborate as a result of influences from the high culture centers that existed in pre-Columbian times on the Pacific side of the divide. On concluding this survey, in the latter part of March, the expedition established headquarters at La Pintada in the Pacific drainage opposite the headwaters of the Coclé del Norte, where additional excavations were undertaken with the intention of estab-

lishing the relation between the prehistoric cultures of the two regions. Dr. Robert Rands accompanied Dr. Stirling in the field as archeological assistant.

Dr. Frank H. H. Roberts, Jr., Associate Director of the Bureau and Director of the River Basin Surveys, devoted most of his time during the year to the management and direction of the River Basin Surveys. In October he went to Lincoln, Nebr., to inspect the Missouri Basin headquarters. Accompanied by Paul L. Cooper, field director, he then proceeded to the Fort Randall Reservoir area near Chamberlain, S. Dak., and visited a number of archeological sites that were being tested by one of the field parties. From Chamberlain he went to Pierre, S. Dak., and inspected the investigations being carried on in the area of the Oahe Dam. Dr. Roberts also went to several other sites that will be flooded by the Oahe Reservoir and discussed with Mr. Cooper plans for excavation projects at those locations when field work got under way in the spring months. After returning to the headquarters at Lincoln, Dr. Roberts went to Colorado where early in November he spent two days at the Lindenmeier site seeking charcoal that could be used for carbon-14 dating. He also spent two days testing a rock shelter near Livermore, which had been reported to contain materials belonging to the Folsom complex. Dr. Roberts found considerable evidence of occupancy of the shelter by recent Indians but saw nothing to indicate the older horizon. In April he went to Clarksville, Va., where excavations were under way in sites that will be flooded by the Buggs Island Reservoir. In May he went to Evanston, Ill., to attend the annual meeting of the Society for American Archaeology, of which he was President, and then proceeded to Lincoln, Nebr., where he assisted in the preparation of plans for the summer field season in the Missouri Basin. From Lincoln he went to Oklahoma and spent several days visiting sites in the Tenkiller Ferry Reservoir and observing the excavations that were being made by a River Basin Surveys' party near Tahlequah.

At the beginning of the fiscal year Dr. Henry B. Collins, anthropologist, left for a second season of field work on Cornwallis Island in the Canadian Arctic. As in the two preceding years the work was conducted under the joint auspices of the Smithsonian Institution and the National Museum of Canada. Dr. Collins and his assistant, Walter E. Taylor, anthropology student at the University of Toronto, were flown by the Royal Canadian Air Force from Montreal to the Resolute Bay weather station on Cornwallis Island, stopping en route at Churchill on Hudson Bay. The excavations yielded a large collection of the Thule culture material, most of it from in and around an unusually large stone and whalebone house at the site designated as M 1, a mile from the weather station. Just to the rear of this house was a small and inconspicuous house ruin, indicated only by a shal-

low depression in the ground, which turned out to be the oldest Thule structure thus far found in the central or eastern Arctic. The artifacts from this house were identical with those from the earliest Thule sites in Alaska. The house had evidently been occupied very briefly, for perhaps only one or two years, by some of the first Thule migrants from Alaska, who in all likelihood had then continued on their way to northwest Greenland. A similar shallow depression nearby yielded Dorset objects, the first indication that this early but little-known Eskimo culture had reached Cornwallis Island. Three culture stages are thus represented at Resolute—Dorset, early Thule, and developed Thule. The first two were probably represented by only a few families who lived there for very short periods. The last stage was of much longer duration, probably a century or more, during which time the population was probably to be numbered in the hundreds. In June 1951 Mr. Taylor returned to Resolute to complete some of the excavations that had to be left unfinished the preceding August.

Dr. Collins was reelected to the board of governors of the Arctic Institute for a 3-year term, and also for a 1-year term as treasurer of the organization. He continued to serve as chairman of the directing committee that planned and supervised the bibliography and roster projects on which the Arctic Institute has been engaged for the past four years under contract with the Office of Naval Research. The Roster of Arctic Specialists, containing biographical data on American and Canadian citizens having expert knowledge of the Arctic regions, was completed and turned over to the agencies that had sponsored and financed the work—U. S. Departments of the Army, Navy, Air Force, and Defense Research Board of Canada. The first five volumes of the Arctic Bibliography were also completed and delivered to the Government Printing Office through the Department of the Army, which had contributed additional funds for its publication. Prepared under the direction of Miss Marie Tremaine with a staff including expert bibliographers, translators, and scientists working at the Library of Congress and other libraries in the United States and Canada, the Arctic Bibliography is one of the most comprehensive regional bibliographies ever assembled and should be a useful research tool for scientists and others interested in the North.

At the beginning of the fiscal year, Dr. John P. Harrington was on the Crow Indian Reservation in southern Montana conducting linguistic studies. Dr. Harrington found in connection with his studies that the word Missouri, formerly thought to mean "large canoe" or "wooden canoe," means simply "canoe" and, as applied since aboriginal times to the Missouri River, means by implication the navigated river. Dr. Harrington also obtained detailed information concerning the Mandan coracle or bull boat from Crowsheart, an Indian 94 years of age. An article was completed on this subject. On December 19,

Dr. Harrington returned to Washington, D. C., and spent the time until March 9 writing reports on his field work. On this date he left for México in order to resume his studies on the Maya language. At the end of the fiscal year he was in Mexico City continuing this work.

Commencing July 1, Dr. William N. Fenton, having completed an assignment for the Indian Service at Taos Pueblo, conducted a survey of manuscripts relating to the ethnohistory of eastern Indians in the Henry E. Huntington Library at San Marino, Calif. The latter research, carried out with the aid of grants from the research funds of the American Philosophical Society, was published in the Proceedings of the American Philosophical Society, vol. 95, No. 3.

Factions are a peculiar feature of American Indian political organization that has yet to be worked out for the country as a whole. Some ideas about political structure and methods of field work, which Dr. Fenton developed over a long period of field and library study among the Six Nations, were this past year transferred to the study of Indian self-government, which is riddled with factional disputes, in three divergent tribal cultures—Taos, Klamath, and Blackfeet. Each field situation was unique and required adjusting techniques, but the main principles hold. Field work was completed at Klamath Indian Agency in August, and the situation at Blackfeet Agency in Montana was explored during September. On returning to Washington late in September, at the request of the Indian Bureau Dr. Fenton drafted a comprehensive plan for the study of the Blackfeet problem by a team of social-science specialists who would be drawn from several disciplines including anthropology.

RIVER BASIN SURVEYS

(Report prepared by FRANK H. H. ROBERTS, JR.)

Instituted in the fall of 1945 as a unit of the Bureau of American Ethnology, the River Basin Surveys were organized to carry into effect a memorandum of understanding between the National Park Service and the Smithsonian Institution. The memorandum pertains to the salvage of archeological and paleontological remains that would otherwise be lost as a result of numerous projects for flood control and irrigation, hydroelectric installations, and navigation improvements in the river basins of the United States. The field work was started in July 1946 and has continued since that date. During the entire period of operations the investigations have been conducted as an interagency program with full cooperation on the part of the Smithsonian Institution, the National Park Service, and the Bureau of Reclamation of the Interior Department, and the Corps of Engineers of the Department of the Army. In addition, numerous non-Federal institutions scattered throughout the various States have

aided in the work. The program in the last fiscal year was financed by a transfer of \$174,375 to the Smithsonian Institution by the National Park Service. Those funds were derived in part from the National Park Service and in part from the Bureau of Reclamation. The money from the Bureau of Reclamation was for use in the Missouri Basin, while that from the National Park Service was for use in all other areas throughout the United States. Because the appropriations for the previous year became available so late in the field season, a substantial carry-over (\$135,574) increased the 1951 funds so that a much larger series of investigations was possible than would otherwise have been the case.

Activities during the year consisted of reconnaissance or surveys for the purpose of locating archeological sites or paleontological deposits that will be flooded or otherwise destroyed by construction work and in the excavation of sites located by previous surveys. In all, 45 reservoir basins located in 13 States and scattered over 8 river basins were visited by survey parties. In addition one lock project and four canal areas were examined. Excavations were completed or were under way at the end of the fiscal year in 20 reservoir areas in 10 States. During the course of the year there were 26 excavating parties in the field. Eight of the excavation projects were in areas where digging was done in previous years, but the remainder were new undertakings. When the fiscal year closed, the total of the reservoir areas where surveys had been made or excavations carried on since the beginning of actual field work in July 1946 was 225 located in 25 States. During the course of the work 2,894 archeological sites have been located and recorded, and of that number 545 have been recommended for excavation or additional testing. Preliminary appraisal reports were completed for all the reservoirs surveyed, and 14 reports were mimeographed for limited distribution to the cooperating agencies. This makes a total of 134 such reports issued since the start of the program. In some cases a series of reservoirs is included in a single report covering a subbasin, and for that reason the total number of reports is less than that of the reservoirs. The excavations made during the fiscal year brought the total for areas where such work has been done to 33. The results of some of that work have been published as technical reports in various scientific journals, and one Bulletin of the Bureau of American Ethnology containing eight such papers is now in press. That Bulletin inaugurates a new series, to be called "River Basin Surveys Papers" and designed as an outlet for the reports resulting from the interagency archeological salvage program. Paleontological surveys have been made in 115 reservoir areas, 70 being those where archeological work has also been done. The remaining 45 in due course will be investigated by

archeological parties. The over-all total of reservoirs visited, including those where archeological work still needs to be done, is 270.

The reservoirs investigated for archeological remains as of June 30, 1951, have the following distribution by States: California, 20; Colorado, 24; Georgia, 4; Idaho, 11; Illinois, 2; Iowa, 3; Kansas, 7; Kentucky, 1; Louisiana, 1; Minnesota, 1; Montana, 14; Nebraska, 27; New Mexico, 1; North Dakota, 13; Ohio, 2; Oklahoma, 7; Oregon, 26; Pennsylvania, 2; South Dakota, 9; Tennessee, 1; Texas, 15; Virginia, 2; Washington, 11; West Virginia, 2; Wyoming, 19. Excavations since the start of the program have been made in: California, 5; Colorado, 1; Georgia, 1; Kansas, 1; Montana, 1; Nebraska, 1; New Mexico, 1; North Dakota, 4; Oklahoma, 2; Oregon, 3; South Dakota, 5; Texas, 7; Virginia, 1; Washington, 8; Wyoming, 3.

The River Basin Surveys received extensive cooperation during the year from the National Park Service, the Bureau of Reclamation, the Corps of Engineers, and numerous State and local institutions. Guides and transportation were furnished staff men in the field at a number of projects, while at others office and laboratory space was provided. In several cases labor and mechanical equipment were contributed by the construction agency. Had it not been for the assistance provided in that way, it would not have been possible for the River Basin Surveys' men to accomplish as much as they did. As in past years, the National Park Service served as the liaison between the various agencies and provided the Smithsonian Institution with the necessary information concerning the locations of the proposed dams and reservoirs and also their priorities. In addition, the National Park Service carried the responsibility for budgeting the costs of the program and for procuring the funds.

General supervision and direction of the work in California, Georgia, Kentucky, Oklahoma, Pennsylvania, and Virginia were from the main office in Washington. The program in the Columbia Basin was directed from a field headquarters and laboratory at Eugene, Oreg.; that in the Missouri Basin was under the supervision of a field office and laboratory at Lincoln, Nebr.; and that in Texas was under the field office at Austin. All the materials collected by the survey and excavation parties in those three areas were processed at the field laboratories. In addition, the collections made in Georgia were processed at a laboratory at Athens.

Washington office.—The main headquarters of the River Basin Surveys continued under the direction of Dr. Frank H. H. Roberts, Jr. Joseph R. Caldwell, Carl F. Miller, and Ralph S. Solecki, archeologists, were based on that office, although Caldwell spent the entire year in Georgia, and Solecki took leave of absence to join an expedition going to the Near East. Dr. Theodore E. White, paleontologist, di-

vided his time between the Washington office, the Missouri Basin, and the Texas area.

Mr. Caldwell spent the early months of the fiscal year working on his report on the results of the excavations completed during the previous year at the Allatoona Reservoir. In November he proceeded to the Buford Reservoir area on the Chattahoochee River northeast of Atlanta where he carried on a survey until April 6. In the latter part of April Mr. Caldwell made an investigation at the site of Fort Charlotte in McCormick County, S. C., to determine what work might be necessary to obtain full information about it before it is flooded by the waters of the Clark Hill Reservoir. From Fort Charlotte Mr. Caldwell returned to his field base at Athens where he prepared a manuscript "The Booger Bottom Mound: A Forsyth Period Site in Hall County, Georgia."

At the beginning of the year, Carl F. Miller was carrying on excavations at a site on the east bank of the Roanoke River near Clarksville, Va. He continued operations there until August 4, when he returned to Washington. During the months spent in the office, Mr. Miller worked on his section of the report on the excavations at the Allatoona Reservoir in Georgia. On February 28 he returned to Clarksville and resumed investigations in the Buggs Island Reservoir area. Those operations continued until June 20, when he proceeded to Bassett, Va., and made a survey at the Philpott Reservoir on the Smith River. He returned to Washington on June 30. During such times as the Director was absent from the Washington office, Mr. Miller served as Acting Director of the River Basin Surveys.

Ralph S. Solecki devoted the early months of the year to the completion of reports on work done previously. In October he made a brief investigation of the area at Morgantown, W. Va., where a new navigation lock was under construction. From there he proceeded to the Conemaugh Reservoir on the Conemaugh River in western Pennsylvania, where he made a reconnaissance of the area that will be flooded. From the Conemaugh project he proceeded to the East Branch Reservoir basin on the Clarion River, also in Pennsylvania. After completing the survey of that area, he returned to Washington and completed his report on the field investigations.

Dr. Theodore E. White spent the winter and early spring months in Washington studying the materials he had collected during the summer field season and in the preparation of a manuscript "Preliminary Analysis of the Fossil Vertebrates of the Canyon Ferry Reservoir Area." In April he went to Texas where he collected fossils from the Lavon Reservoir on the East Fork of the Trinity River in Tarrant County and from the Garza-Little Elm Reservoir on the Elm Fork of the same river in Denton County. In June Dr. White proceeded from

Texas to Lincoln, Nebr., and resumed his activities in the Missouri Basin.

California.—At the beginning of the fiscal year a party under the direction of Franklin Fenenga was excavating a site in the Terminus Reservoir area on the Kaweah River, in Tulare County. That work was continued until August 1, and upon its completion detailed information had been obtained about a small village consisting of 14 houses and 3 distinct milling places. The site was important because it provided an opportunity to study the remains left by a group of people who occupied the region in historic times and concerning whom there is an extraordinarily complete ethnographic record. The lower end of the Kaweah Canyon was formerly occupied by a small band of the Yokut Indians known as the Wukchumne or Wickchamni. Correlations of the data from both the ethnological and archeological sources of information will make it possible to prepare an archeological report containing an almost unique amount of information on the function and significance of the artifacts and the various features of the site. Many items of the material culture previously known only through tradition are now represented by actual objects recovered during the archeological researches.

Upon the completion of the digging at the Terminus Reservoir, Mr. Fenenga moved his party to the Folsom Reservoir located on the American River, in Eldorado County, where excavations were carried on from August 3 to September 16. About 75 percent of the site was investigated. The returns were small in that only a single burial and 214 artifacts were found. The burial was that of a child about 12 years old and had no accompanying offerings. The artifacts consist for the most part of stone and, as most of them are unspecialized forms making functional identifications or comparisons with objects from other sites difficult, they are not particularly significant. A small series of arrow points, about half of which were made from a native opal, will be useful in the matter of correlation with other sites, but at present there is so little material available for study from that particular region that conclusions are not warranted. Until more data are obtained, it will not be possible to give a reasonably complete picture of the material culture of the people who occupied the site.

Two field parties excavated at the Cachuma Reservoir on the Santa Ynez River, in Santa Barbara County. One of them, under Albert D. Mohr, worked from August 1 to September 12, while the other, under Martin Baumhoff, worked from April 3 until May 18. The first party excavated in a site that contained evidence of three cultures previously described by David Banks Rogers. They are the Oak Grove, Hunting, and "Chumash." The evidence obtained there substantiated the re-

ported sequence for the Santa Barbara area. It also indicated that two phases each of the last two periods might be defined as the result of further work. The same party also did some testing in another site which apparently represents a single late period that extended into early historic times.

The party under Mr. Baumhoff concentrated its efforts at the second site where Mr. Mohr worked and obtained considerable additional information from it. Preliminary study of the artifacts indicates that the occupation is attributable to the Canaliño. There is evidence of trading activities in the form of tubular beads from the San Joaquin Valley and potsherds similar to the pottery made by the Yokuts of that region and the western Paiutes. No house remains were found, but there were scattered piles of stones that appear to have been intentional rather than accidental, and in one case there was a pear-shaped pit 12 feet 8 inches long, 6 feet 3 inches wide, and 1 foot 3 inches in depth, which had been lined with slabs of shale and was filled with rocks of all sizes. The function of the pit has not been determined. It was at first thought that the feature may have been a sweat house, but the nature of the shale lining was such that it probably would not have withstood the heating necessary for sweat-house purposes. Additional work is needed at the Cachuma Reservoir in order to gain a better understanding of the aboriginal history of the area.

Columbia Basin.—Work in the Columbia Basin was continued under the supervision of the field headquarters at Eugene, Oreg., where laboratory and office space were provided by the University of Oregon. Joel L. Shiner served as acting field director throughout the year. Activities in that area consisted of a survey of six reservoir projects and excavations in four areas where preliminary reconnaissance work had already been completed. The John Day Reservoir basin on the John Day River, in Oregon, was examined by Robert Farrell and Stuart Peck during the first two weeks in July. The party found 88 sites and recommended testing or more extended excavations for 8 of them. From the John Day Reservoir, Peck and Farrell proceeded to the Hells Canyon Reservoir on the Snake River, in Oregon-Idaho, where they found 22 sites, of which 4 were recommended for investigation. The latter survey was completed the middle of August. During July George L. Coale and Octavio Romano surveyed the area to be flooded by the Albeni Falls Reservoir on the Pend Oreille River, in northern Idaho. They found 13 sites and recommended the testing of 5. Construction work on the dam has progressed to such an extent that the indicated work may not be possible at that location. From the Albeni Falls area, Coale and Romano proceeded to the Katka and Libby Reservoir projects on the Kootenai River, in Idaho and Montana, where they made a preliminary reconnaissance. The Katka Dam is located in Idaho, but the reservoir will extend upstream into

Montana. The survey of the Katka area located and recorded 14 sites, of which one was recommended for excavation. Three others, however, were found to be worthy of testing. The Libby area contains 11 archeological sites, and because so little is known of the archeology of the Kootenai Indians, 6 of the 11 were recommended for further study. Extensive excavation would not be required at any of them, however. John M. Campbell spent July and August making a survey of the Priest Rapids Reservoir basin. The Priest Rapids Dam is to be built in the Columbia River just below the rapids and will create a pool area 56 miles long. The district to be flooded is an important one from the standpoint of the aboriginal occupation of the area, and 74 sites were found there. Of that number, 29 are considered to be of high archeological significance. The sites consist of those with well-preserved house pits, the remains of open camps, cave shelters, burial grounds, and various groups of pictographs. The region is one that was occupied by several different Indian groups, and knowledge from it should have an important bearing on a large section of the Plateau Culture area.

At the start of the fiscal year a party under the direction of Douglas Osborne, consulting archeologist, was continuing excavations at a site on the Washington side of the Columbia River near Mottinger in the McNary Reservoir basin. The site was that of a postcontact village and probably was the location of that visited by Robert Stuart in 1812. During the course of the digging three house pits and one mat lodge were uncovered, and three additional house pits were tested. The house pits were circular, and if the identification of the village is correct it would indicate that the circular earth lodge was in use in that area at a later date than most anthropologists have believed. The artifacts obtained were not numerous, which is a condition found at most of the places worked in the McNary basin. In addition to aboriginal stone and bone implements and shell ornaments, a variety of European goods was obtained. Several of the house pits gave evidence of several separate occupations, which may indicate that the village was not lived in continuously but was revisited from time to time, perhaps by the same group of people. The remains of the long narrow mat house, which was a popular form of multifamily dwelling during the historical period in that area, agree closely with the descriptions of such houses given by the Umatilla Indians to ethnological investigators in previous years. One complete burial was recovered at that location. Late in July Mr. Osborne transferred his party to a site near Cold Springs on the Oregon side of the river where he dug four house pits in the remains of a small village. During periods of high water the site appears to be located on an island, as a portion of the river flows through an old channel and separates it from high ground to the south. The village was situated on the side nearest

the main channel and consisted of two distinct groups of houses. The largest group was centered about 500 feet downstream from the smaller one. An almost identical condition had previously been noted at another site where work was done during the summer of 1949, but thus far no explanation for such a division has been found. The pits at this particular location were also circular in form and indicated a single occupation. The lack of well-developed midden or refuse areas implies that the village must have been short-lived or that particular care was taken to throw refuse into or near the river. Trade goods were scarce at this site, which would seem to indicate that it should be dated as slightly earlier than the time of the first contact with the Whites or just prior to 1800. The Lewis and Clark map shows the "island" but does not indicate the presence of a village or at least the existence of houses. It would appear that the village had been abandoned and had fallen into ruin before 1805. The most important contribution from the excavations at these sites is the verification of data secured at other locations in the McNary, particularly with respect to the size and shape of the former houses and their artifact associations; also, it was indicated that, while fishing was the primary source of subsistence, hunting actually played a larger part in the economy than previously supposed. Mr. Osborne also completed the excavation of a house pit at a site 1 mile downstream where work was done the previous summer, and in addition located and removed 17 burials from Sheep Island in the middle of the river about equidistant from the other three sites. Some work had been done previously at that location by Thomas R. Garth, who was then with the National Park Service. Osborne, who was under a temporary appointment as consulting archeologist, completed his investigations the end of August and returned to his regular duties at the Washington State Museum.

Richard D. Daugherty and his party continued the excavations started near the end of the previous fiscal year at the O'Sullivan Reservoir near Ephrata, Wash., and completed the investigations on September 2. They spent the summer season at a small village site close to a larger one where Daugherty did some work in the summer of 1948. During the current year two large circular house pits were dug, and the remains of a rectangular mat dwelling were uncovered. A series of cairns that had formerly contained burials was also studied. The graves had been systematically rifled by local collectors, however, and little could be learned other than that the piles of stone had covered the remains of cremations. Information pertaining to the house types agreed with that from the previous digging, and from that data it will be possible to draw a number of conclusions about the dwellings of the area. Not a single item was found suggesting White contact, but the similarity of the artifacts to those from other sites in the region where there was association with contact material suggests that

the occupancy was not long prior to the time the first white men reached the area. In general the artifacts consist of projectile points, various types of scrapers, knives, drills, hammerstones, sinkers, pendants, grinding stones and pestles, stone pipes, bone awls and points, bone flaking tools, gaming pieces, and beads. While carrying on his excavations, Daugherty also tested a site in the Lind Coulee where materials attributable to the Paleo-Indian occur. The site is outside the reservoir basin but is along the course of lateral and distribution-system canals, and as Lind Coulee is to be used as a wasteway for them the archeological remains will ultimately be destroyed.

A party under the direction of Samuel J. Tobin was excavating in a large rock shelter in the Equalizing Reservoir basin southwest of the town of Grand Coulee, Wash., at the start of the fiscal year. The work was carried on through July. Evidence obtained there was that the shelter was not a regular dwelling place but rather a spot where small parties probably camped from time to time. Three distinct levels of occupation were found, but apparently no great length of time intervened between each level, and the materials suggest that the same cultural group was involved throughout. The chief significance of the shelter is that a considerable amount of dry material such as is rarely found in open sites was obtained. Included in it are cordage, fragments of bow staves, arrow or spear shafts, textile fragments, matting, and pieces of basketry. Nonperishable artifacts are projectile points, bone implements and beads, and shell beads. The rear wall of the shelter was decorated with pictographs, some made with white paint and others in red. Analysis of the dry materials should throw considerable light on that phase of the material culture of the people in the area. Present indications are that the shelter may well have been occupied by either the Nespelem or their eastern neighbors the Sanpoil. Although contact objects were lacking below the surface, it is difficult to assign either a historic or a pre-Columbian age to the site.

The beginning of the fiscal year found a party under George A. Cheney digging in village remains along the Columbia River in the basin to be flooded by the Chief Joseph Reservoir. The work continued through July and August and into early September. In August Tobin's party was shifted to that project to assist in the investigations. The work in September was a cooperative effort, the Washington State Museum providing the necessary labor. At the end of the season 42 house pits located in 7 sites had been dug and accompanying trash mounds examined. Good information was obtained concerning the house type, and indications are that there was no particular village pattern. The structures do not seem to have been grouped, but at all the sites were strung along a terrace above the river in sheltered areas well back from the water. The artifacts

recovered consisted in the main of stone projectile points, blades, scrapers, hammers, pestles, pipes, choppers, and bowl fragments. The evidence in general appears to show that a single cultural level was represented at all the sites investigated. The area is one, however, where the river has done considerable scouring and shifting, and it is possible that older materials may have been destroyed. Though many of the data from the Chief Joseph Reservoir supplement those reported by earlier workers for the Upper Columbia-Grand Coulee Reservoir, there are some marked differences in certain artifact categories. Considerable light will be thrown on the archeology of that portion of the Columbia Basin when studies on the materials from the Chief Joseph Reservoir are completed.

On April 2 Joel L. Shiner started excavations at a site in the McNary Reservoir where a cultural layer had been discovered underneath a thick stratum of wind-deposited volcanic ash. The site, which was reported to the River Basin Surveys in January by Thomas R. Garth, represented a single occupation by a group of Indians having a simple culture and, except for the projectile points, very crude tools. Some 100 artifacts, including hammerstones and choppers in addition to the points, were found there. Large numbers of animal bones, many of them burned, and mussel shells were present in the midden. There were no indications, however, of any type of habitation. The culture probably represents a fairly early horizon in the Columbia Basin, but its proper place in the sequence for the area cannot be determined definitely until the volcanic ash is correlated with one of the known eruptions in the region or the burned bones have been dated by the carbon-14 method. Typologically the artifacts appear to be of respectable age.

At the end of April Mr. Shiner moved his party to the site of a former fishing village at the mouth of the Walla Walla River and carried on excavations there until the middle of May. Most of the digging was done in a midden deposit adjacent to the house remains, and a good series of artifacts was obtained. That is one of the few locations where enough material was found to make possible a satisfactory statistical study of the types of artifacts. The village apparently was occupied just prior to and during the first coming of the white man. A large number of burials had been present at one time, but the locality had been so thoroughly dug by local collectors that only scattered bones were found by Shiner's party.

During the year seven preliminary reports were completed and mimeographed at the Eugene office. Specimens from the various surveys were processed and cataloged and the photographs taken by the various parties were cataloged and filed. Because of the situation with respect to funds for the following fiscal year, it was necessary to close the Eugene office on June 30, 1951.

Georgia.—Field work in Georgia was carried on from a base of operations furnished by the University of Georgia at Athens. The main investigations during the year were of a survey nature. From November 14 to April 6 a reconnaissance was made of the area that will be inundated by the proposed Buford Reservoir on the Chattahoochee River. From April 23 to 28 a brief reconnaissance was made in the Clark Hill Reservoir, on the Savannah River, for the purpose of locating the remains of Fort Charlotte.

The Buford Reservoir basin occupies a large intermediate section of north-Georgia terrain lying between the Allatoona Reservoir area on the Etowah River and the north-Oconee drainage. The region is one that is virtually unknown archeologically, and it should contain significant data as far as a proper understanding of cultural developments in that part of Georgia is concerned. The preliminary survey located 46 sites in the area to be flooded. Included in the group are 29 that appear to represent a rather early prepottery period. There is some evidence that this group of sites may be somewhat older than the Stallings Island Prepottery Culture. A larger proportion of sites belong to the Woodstock period than was found to be the case during the investigations at the Allatoona Reservoir. The larger number of early sites indicates either that there was a sizable population in the district or that it was occupied over a long span of time. Extensive investigation of a number of the sites should give an answer in that respect. Two large previously unrecorded mounds were also noted, and some test digging was done in them. One gave evidence of having been erected over a small natural knoll, and the outlines of a small square house with a bench, bed, or throne at one end were found on its summit. The mound appears to represent a rather late and previously unknown complex which probably is pre-Lamar in age. The other mound apparently is one of the oldest artificial structures thus far found in Georgia. It differs from previously recognized types of eastern mounds in that it was not accretional and probably was not intended for burial purposes. Neither does it seem to have been a temple platform or domiciliary mound. Evidence obtained during the course of testing it and adjacent areas suggests that it probably belongs in the Forsyth Period, which falls into the general category known as the Burial Mound I Period. In many ways the mound suggests similarities to the well-known Swift Creek Mound. One postulation as to its function is that it may have been erected for ceremonial purposes even though there are no traces of a structure on its summit. A simple earthen platform without a structure would be the logical beginning in the development of the eastern temple-mound complex.

In addition to the pre-Columbian sites, the survey found a number attributable to the historic Cherokee. The latter are located for the

most part along the course of the old Federal Road, which passed through the Cherokee country to the Tennessee settlements. A brief study was made of the Vann House which was built between 1805 and 1813 to serve as an inn for people traveling along the Federal Road and stands on a high knoll overlooking the Chattahoochee River about 1½ miles from the present town of Oscarville. It is one of the few Indian country taverns still standing. In its present form the structure shows several periods of enlargement, but the old original portion is readily discernible, and careful study of it should produce interesting data on the nature of the taverns of the period when built.

The search for the remains of Fort Charlotte, in the Clark Hill Reservoir area, showed that it was located on the South Carolina side of the Savannah River, but inasmuch as it will be inundated by the Clark Hill Reservoir, the dam for which is being built in Georgia, investigation of the site is considered to be a part of the Georgia project. Fort Charlotte, built in 1765 as one of the Colonial defenses against the Cherokee Indians, was seized on July 12, 1775, by South Carolina troops—one of the first overt acts of defiance by the rebellious Colonies against the British Government. It continued to be occupied by Colonial troops until the close of the Revolutionary War. Because of the lack of accurate information about the actual physical character of the fort and the fact that certain phases of its history correlate with Indian activities in that area, it is hoped that all remaining evidence pertaining to it can be retrieved from the site before it is inundated.

Kentucky.—During the period April 16 to May 18 Douglas W. Schwartz, field assistant, made a reconnaissance and carried on limited test excavations in the basin to be flooded by the proposed Celina Reservoir on the Cumberland River, in southern Kentucky. He located 24 archeological sites, representing a number of cultural periods; further work in the area probably would make it possible to establish a sequence for them. Excavations in six major sites have been recommended, but inasmuch as all of them are above the pool line there is no immediate urgency for their investigation. Their location is such, however, that after the reservoir is filled they may be subject to some wave action and will be easily available to unauthorized diggers. Consequently, plans should be made for additional work in that district.

The survey in the Celina area was done in cooperation with the University of Kentucky, which furnished Mr. Schwartz with the necessary transportation and provided him with office and laboratory space for working over his material. Dr. William S. Webb, head of the university's department of anthropology, assisted Mr. Schwartz in an advisory capacity.

Missouri Basin.—Activities in the Missouri Basin continued to be supervised and directed from the field headquarters at the University of Nebraska in Lincoln. Paul L. Cooper served as acting field director from July 1 until October 3, when he was made field director for the Missouri Basin program. The operations in the Missouri Basin shifted in character during the course of the year. Where previously most of the activities had been concerned with preliminary surveys, a larger number of excavating parties were sent into the field and greater emphasis was placed on the actual salvage of materials from sites that eventually will be inundated.

From July 3 to November 21 a two-man archeological survey party headed by Robert L. Shalkop made preliminary reconnaissance of the Apex, Brenner, Clark Canyon, Gibson, Kelley, Landon, Nilan, and Wilson Reservoirs in Montana; the Middle Fork and South Fork projects in Wyoming; and the Narrows in Colorado. The party also revisited the Keyhole Reservoir area in Wyoming and the Moorhead and Yellowtail projects whose basins occur in both Montana and Wyoming. The Shalkop party located and recorded 127 new sites. From August 12 to November 3 a two-man party led by George Metcalf investigated the area of the Fort Berthold Reservation in the Fort Garrison area in North Dakota, locating and recording 55 new sites. During October a two-man reconnaissance party under Richard Page Wheeler visited 10 potential reservoirs in the Niobrara subbasin in Nebraska. The party found a total of 41 archeological sites. Robert B. Cumming, Jr., and an assistant carried out a reconnaissance of the Ashton Reservoir area in the Lower Platte basin in Nebraska from November 7 to 15 and at the same time examined the sites of the Sargent, Woods Park, and Ashton Feeder canals. Since only one archeological site was found by Cumming's party, the area does not appear to have had much aboriginal occupation. This party also investigated an ossuary that had been uncovered at the Cushing dam site. During the period June 5 to 9, Franklin Fenenga and an assistant surveyed the Lovewell Reservoir area on White Rock Creek in northern Kansas and recorded six archeological sites. On June 19 Fenenga and an assistant proceeded to Wyoming and by the end of the fiscal year had made surveys at the Bull Creek, Smith, Buffalo Bill, Triangle Park, Willow Park, and Red Gulch Reservoirs. Five sites were found in the Bull Creek Reservoir and one large workshop area, which may be relatively old, was discovered in the Red Gulch Reservoir. None of the other projects visited contained archeological manifestations.

At the beginning of the fiscal year a party under the direction of Richard Page Wheeler was excavating at the Long site in the Angostura Reservoir basin on the Cheyenne River in South Dakota. That

work, which had been started in the previous year, continued until July 19, when the Wheeler party moved to the Boysen Reservoir area in Wyoming. The Long site is of particular interest because it represents one of the early hunting-culture occupations in the Plains area. The material from it is limited in quantity, but the blades, scrapers, and projectile points probably can be correlated with some of the types from other hunting cultures and will aid materially in filling in the gaps in present knowledge about the prehistory of the western Plains. Charcoal obtained from unprepared hearths has been dated by Dr. W. F. Libby by the carbon-14 method and shows that the occupation at the Long site was in the interval from $7,073 \pm 300$ to $7,715 \pm 740$ years before the present.

The Wheeler party began work in the Boysen Reservoir area on the Big Horn River near Shoshoni, Wyo., on July 20 and continued operations until September 20. During that period a number of sites were tested, and fairly extensive excavations were carried out at three locations. Most of the sites were in the open and proved to be the remains of camps rather than of villages. One small rock shelter was found to contain considerable refuse material as well as various types of artifacts and broken animal bones. One crevice burial, discovered on a butte top overlooking the reservoir area, presumably belonged to the historic period as a number of porcelain beads and a short coil of iron were sifted from the sand that lay directly below the crevice. Two of the sites examined probably are late prehistoric, while the others are older, perhaps considerably older. In addition to the excavating work, the Wheeler party photographed and sketched many petroglyphs and made extensive surface collections from numerous occupational sites, several of which were newly discovered while the digging was going on.

On June 21 Wheeler and his field assistant, J. M. Shippee, returned to Wyoming and started excavations at the only known pottery site in the Keyhole Reservoir area on the Belle Fourche River near Moorcroft. By the end of the fiscal year they had dug three shallow test areas across the site and recovered a series of artifacts consisting of stone and bone implements and a variety of potsherds. The apparent absence of dwellings of any kind, the shallowness of the middenlike deposits, and the character of the material found there suggest that the site, which covers approximately 30 acres, was a late prehistoric or protohistoric hunting camp. The work there had not yet progressed sufficiently to make possible the correlation of the remains with one of the historic tribes known to have inhabited that part of Wyoming.

The largest excavation operations in the Missouri Basin during the year were those in the Oahe Reservoir area on the main stem of the Missouri River near Pierre, S. Dak. A party under the supervision of Donald J. Lehmer was digging in the remains of a large

fortified village near the Oahe dam site on July 1 and continued at that location until October, when it was shifted to another fortified village a short distance farther downstream. At the first location, called the Dodd site, the remains of 21 earth lodges, 27 cache pits, and 16 miscellaneous features were uncovered. In addition, 8 test trenches and 27 test pits were dug. The Dodd site is of particular interest because of the fact that three types of houses were found there, and there was definite stratigraphic evidence for a sequence of the various forms. The latest structures at the location had been circular earth lodges, while the earlier ones were rectangular. There apparently were two types of rectangular earth lodge, the oldest being smaller and with a somewhat different pole arrangement than the later ones. Although it has not been established beyond question, it appears that the circular houses were those built by the Arikara, while the rectangular ones are attributable to the Mandan. Several thousand specimens, consisting of potsherds, stone, bone, shell, and metal artifacts, were found during the digging, and the analysis of that material should be a definite contribution to the archeology of the area. At the second location, known as the Phillips Ranch site, 5 earth lodges and 46 cache pits had been cleared and one test trench dug across the fortification ditch when weather conditions brought the activities to a close on November 26. The structures at the Phillips Ranch site were circular and appear to correlate with those of the final period at the Dodd site. Mr. Lehmer returned to the Phillips Ranch site on June 20 and resumed his excavation program. It was still under way at the close of the fiscal year. During the short period involved one house was completely cleared and another started. The presence of a palisade inside the fortification ditch surrounding the site was established, and the overburden from the northeast quadrant of the area was stripped away, revealing a number of features lying outside the houses.

Additional work in the Oahe area got under way in June when a party under the direction of Dr. Waldo R. Wedel, who was detailed to the River Basin Surveys from the U. S. National Museum, began excavations at the Cheyenne River village site, about 45 miles north of the Dodd site. The Cheyenne River village is one of the largest and best preserved of the fortified sites along the Missouri River, although a portion of it has been carried away by the encroaching stream. It apparently was occupied for a considerable period and probably contains several components. By the end of the fiscal year one earth lodge had been uncovered, the work on a second was nearly completed, and digging had started on a third. One cache pit had been cleaned and another located. Two test trenches excavated across the moat had shown that the original bottom was about 6 feet below the present surface. The artifact yield from the investigations was proving

highly satisfactory, and the artifacts should give a well-rounded picture of the material culture of the former occupants of the village, as well as indicating their relationship to other peoples in that portion of the Plains.

Early in July a party led by Thomas R. Garth started investigating historic sites in the area to be affected by the Fort Randall Reservoir in South Dakota. They spent a short time examining the site of old Fort Randall, across the river from Pickstown, but devoted most of the field season to work in the vicinity of Chamberlain. Extensive but unsuccessful efforts were made to locate the site of Fort Recovery, an early fur-trading post. The remains of other trading posts and military establishments were found, however, and partially investigated. Included in that group are Fort Hale, Fort Brule, Fort Lookout trading post, Fort Lookout military post, and the Whetstone Agency. At Fort Hale there was evidence of a large building that probably had been a trading post, two smaller buildings, and indications of a stockade. There was also evidence that there had been an earlier Indian occupancy of the site. At Fort Lower Brule the remains of a cabin 45 feet long were uncovered, and an 18-by-12-foot cellar was excavated. An abandoned well was also investigated, and about 30 "snow snakes," some of which were decorated with geometric and some with realistic designs, were recovered. "Snow snakes" were frequently made from bison ribs and in some cases were equipped with feathers stuck to two wooden pegs inserted in one end of the bone. Objects of this type were generally used in playing a rather simple game, which consisted of sliding them along the frozen crust or in a rut in the snow. The players chose sides, and when a "snake" outdistanced all on the other side it counted as a point. The remains of the fur-trading post, presumably adjacent to the military post, were found, and an Indian earth lodge was located while the area was being tested for the historic remains. The Garth party also located 29 new Indian sites in the Chamberlain area.

Further work was started in the Fort Randall Reservoir area on June 3 when a party under the supervision of Robert B. Cumming, Jr., began excavations at Indian sites near the mouth of Platte Creek. Work was started at the Oldham site, an earth-lodge village, and at the close of the fiscal year the remains of one house had been uncovered and a second was in the process of excavation. Efforts to trace the fortification ditch that had surrounded the village had not been wholly successful because surface indications of a large part of that feature had been completely obliterated by cultivation. However, it was hoped that subsequent digging would make it possible to follow its entire course.

At the beginning of the year a party under the direction of G. Ellis Burcaw was excavating at the Rock Village located in the Gar-

rison Reservoir basin, near Hazen, N. Dak., a few miles above the dam site. Rock Village was reputedly occupied in the late eighteenth century by the Hidatsa. During the field season, which terminated November 3, five house floors had been uncovered and a number of other features investigated. A party under the direction of Donald D. Hartle resumed work at that location early in June. Additional house floors were being uncovered and a number of cache pits had been cleaned of their accumulated debris. The artifact yield was proving satisfactory and the specimens should add to the picture of the Plains culture as a whole. Rock Village is particularly interesting because it presumably was the most northerly of the fortified earth-lodge villages belonging to the period preceding the replacement of aboriginal material culture by trade goods obtained from the white man.

A second party, under the direction of G. H. Smith, was sent to the Garrison Reservoir in June to study the site of Fort Stevenson, one of the important military posts in that area during the period 1867 to 1883. The post was located a few miles above the dam site on the left side of the Missouri River. By the end of the year the foundations of the post hospital had been traced and excavations had been started on the site of the south barracks. There is considerable documentary information about Fort Stevenson, but knowledge of the post will be considerably broadened by the study of its actual location and remains.

At the beginning of the fiscal year excavations were being conducted at the Tiber Reservoir on the Marias River in Montana by a party under the supervision of W. D. Enger. Two of the sites investigated were occupation levels attributable to a simple hunting culture. They were characterized for the most part by hearths; charcoal; bones from bison, deer, and smaller mammals; and scattered chips of stone with an occasional artifact. The cultural levels began approximately 2 to 4 feet beneath the present surface, and in one of them a rock-ringed hearth about 2 feet in diameter was found $7\frac{1}{2}$ feet below the surface. The yield from both sites was small, but there is sufficient evidence to indicate that the area was not heavily populated and that the people were dependent for the most part on the hunt for their subsistence. Other sites examined, but not extensively dug, included tipi-ring clusters, bison kills, and surface camp sites. Sites such as that containing the deeply buried hearth may contribute important information on the rate of deposition in the area in question. When materials from the low level are correlated with those from other districts, it may be possible to determine the lapse of time since the fire pits were built and used.

Paleontological and geological investigations were continued in the Missouri Basin during the year. In the summer of 1950 a party under Dr. Theodore E. White explored Tertiary deposits in reservoir

areas in Montana and North Dakota and Cretaceous deposits in South Dakota. Work in the Lewis and Clark and Broadwater Counties in Montana where the Tertiary stratigraphy has been imperfectly known since its discovery in 1904 by the late Dr. Earl Douglass definitely established the presence of Lower and Middle Oligocene and Lower and Middle Miocene in that area. In North Dakota the investigations demonstrated that the Cannonball Marine member of the Fort Union formation has a much greater areal distribution than was formerly supposed. Other activities consisted of rapid surveys of proposed reservoir projects in Nebraska and Colorado. Investigations in Montana were resumed in June of 1951.

Laboratory activities at the field headquarters in Lincoln during the year included the processing and cataloging of specimens; the processing of records, including the indexing and filing of photographs; and the preparation and mimeographing of preliminary reports for distribution to the cooperating agencies. The specimens processed, numbering 84,255, came from 371 sites distributed over 18 reservoirs and other projects. In all, 11,764 reflex copies of records were made. Color transparencies totaling 651 were cataloged. Black-and-white photographic negatives numbering 1,707 were made, and 7,507 contact prints were processed. In addition, 197 8-by-10" enlargements were made. The drawings, tracings, and maps prepared for use in the various reports numbered 469.

Several exhibits were prepared interpreting the salvage program and the prehistory of the Missouri Basin area. One of them was displayed at the Eighth Conference for Plains Archeology, while another was placed in the windows of the Surveys' quarters in downtown Lincoln. A series of lantern slides illustrating the salvage program, particularly with respect to Nebraska, for use in an automatic projector, was prepared in cooperation with the University of Nebraska State Museum and was installed in the latter institution.

G. Ellis Burcaw, archeologist, was in charge of a field party excavating at the Rock Village in the Garrison Reservoir, N. Dak., at the start of the fiscal year. He continued his activities there until late in October and returned to the field headquarters at Lincoln on November 3 where he worked on his field report covering the summer's activities.

Paul L. Cooper, field director, devoted most of his time to management problems and general supervision of the field office and laboratory. He made numerous trips to inspect and consult with field parties and served in an advisory capacity to the Region Two office of the National Park Service at Omaha, Nebr., in the matter of preparing agreements for cooperative projects carried on by State and local institutions in the Missouri Basin.

Robert B. Cumming, Jr., archeologist, served as laboratory supervisor at the Lincoln headquarters from July 1 to November 6. During such times as the director was absent from the office, Mr. Cumming assumed administrative responsibility for the Lincoln office. After November 6 Mr. Cumming took over the duties of a field archeologist, conducting surveys in the Ashton Reservoir area and carrying on excavations in the Fort Randall Reservoir basin. During the winter months he wrote a preliminary report on the results of his survey work and assisted with the preparation of a preliminary report on the Oahe Reservoir. He also prepared a report on the physical anthropology of skeletal material excavated at the Massacre Creek site, Nebr., by the Nebraska State Historical Society, a cooperating institution. At the close of the year he was supervising the excavations at the Oldham site near Platte, S. Dak.

Walter D. Enger, Jr., archeologist, was engaged in a series of excavations at the Tiber Reservoir on the Marias River in Montana at the beginning of the fiscal year. The party under his supervision continued its activities until September 16, when it returned to the Lincoln headquarters.

Franklin Fenenga, archeologist, reported to the headquarters at Lincoln, Nebr., on October 26 and served as laboratory supervisor from November 6 to June 1, when he was assigned to duty in the field. Early in June he made a survey of the Lovewell Reservoir area in Kansas and in the latter part of the month made a preliminary reconnaissance of six potential reservoir areas in Wyoming. During the winter months in Lincoln he wrote preliminary archeological reconnaissance appraisals of the Sun River basin and the Jefferson River basin which were issued in mimeograph form. He also prepared survey reports for the following reservoir projects: Keyhole, Yellowtail, Narrows, Moorhead, Fort Randall, and Lovewell. In addition, Mr. Fenenga wrote "A Historical Analysis of Anthropological Interests in the Psychological Sciences," for publication in the Proceedings of the Nebraska Academy of Sciences. In November Fenenga was elected editor of the Plains Conference News Letter.

Thomas R. Garth, archeologist, joined the River Basin Surveys on July 2 by transfer from the National Park Service. On July 17 a party under his supervision began a series of investigations of historic sites in the Fort Randall area. That work continued until late in October, when he turned his attention to a survey of the area in the vicinity of Chamberlain, S. Dak., for the purpose of locating Indian sites. He completed his reconnaissance and returned to the Lincoln office on November 7. On November 27 he was detailed to the National Park Service to complete reports on work he had previously done at the Whitman Mission and Fort Walla Walla in Washington.

He returned to duty with the River Basin Surveys on February 27, when he prepared a report on the results of his activities in the Fort Randall area.

Donald D. Hartle worked at the Oahe Reservoir as assistant to Donald J. Lehmer from the beginning of the fiscal year until December 1. During February and March he was employed on a Texas project. On April 17 he was appointed archeologist and from then until June 1 assisted in the laboratory at Lincoln. He then proceeded to the Rock Village site in the Garrison Reservoir, N. Dak., where he started a series of excavations which were still under way on June 30.

Donald J. Lehmer, archeologist, was in active supervision of the excavations at the Oahe Reservoir in South Dakota from July 1 until December 1. From the latter date until March he worked at the Lincoln office preparing the report on the results of his investigations at the Dodd site. In March he was transferred from the Missouri Basin headquarters to a project in Oklahoma, where he remained until the first of June, when he returned to the Lincoln headquarters. On June 20 he proceeded to the Oahe Reservoir and resumed excavations at the site where he was working when the field season ended the previous November. That work was continuing at the end of the fiscal year. While at Lincoln Mr. Lehmer completed a paper giving preliminary descriptions of the pottery types found at the Dodd site.

George Metcalf, field and laboratory assistant, was at the Angostura Reservoir in South Dakota assisting Richard Page Wheeler at the beginning of the fiscal year. On July 10 he returned to the Lincoln office, where he worked on material obtained during the course of excavations at the Medicine Creek Reservoir. On August 12 he proceeded to the Garrison Reservoir and joined the party under G. Ellis Burcaw. From August 22 until October 18 he carried on a reconnaissance of the area around the Fort Berthold Indian Reservation and located and recorded 55 sites, including historic buildings, the remains of earth-lodge villages, camp areas, deeply buried hearths, tipi-ring sites, burial sites, and one reputed battleground. After completing the survey he remained at the Rock Village excavation assisting Mr. Burcaw until the end of the field season, when he returned to Lincoln. During the winter months he assisted in the processing and analysis of materials from the various excavations and helped to prepare sections of some of the reports on the previous season's work. On June 1 he left Lincoln for the Garrison Reservoir to assist in the work at the Rock Village. At the end of the fiscal year he was continuing his activities at that location.

James M. Shippee, field and laboratory assistant, was at the field headquarters in Lincoln until July 17, when he left to join the excavating party at the Angostura Reservoir in South Dakota. He assisted in the activities there and accompanied the party when it moved to

the Boysen Reservoir in Wyoming, returning with it to Lincoln in September. During the period September 28 to October 30 he assisted in the survey in the Niobrara River subbasin in Nebraska and from November 7 to 15 aided in the examination of the Ashton Reservoir area and the region adjacent to the Sargent, Woods Park, and Ashton Feeder canals. He also assisted in the salvage of the burials uncovered by activities at the Cushing dam site. During the winter months he devoted his time to the restoration of pottery vessels from the Boysen and Oahe Reservoirs and assisted in other laboratory duties. On June 21 he accompanied the excavating party that was sent to the Keyhole Reservoir in Wyoming and was occupied there at the end of the fiscal year.

George H. Smith joined the River Basin Surveys staff as archeologist on May 2. Until June 4 he devoted his time to a study of the problems centering about historic sites in the Fort Randall, Oahe, and Garrison Reservoirs, and in familiarizing himself with the work already accomplished in those areas. He also made a quick trip to the Oahe and Garrison Reservoirs in company with M. J. Mattes and R. H. Mattison, historians of the National Park Service. On June 11 a party under his supervision began excavations at the site of Fort Stevenson, and at the close of the fiscal year he was still engaged in that activity.

At the beginning of the year Richard Page Wheeler, archeologist, was in charge of a party excavating at the Angostura Reservoir in South Dakota. In July he and his party moved to the Boysen Reservoir in Wyoming, where they carried on excavations until September 20. Wheeler then returned to the headquarters at Lincoln and from September 28 through October 30 directed the survey of 10 potential reservoir sites in the Niobrara River subbasin in northern Nebraska. Returning to the field headquarters, he spent the winter months completing his report on the Niobrara survey and working on detailed technical reports on his investigations in the Angostura and Boysen areas. On June 21 he left for the Keyhole Reservoir near Moorcroft, Wyo., where he began a series of excavations which were actively under way at the end of the fiscal year. In April Mr. Wheeler was elected chairman of the anthropology section of the Nebraska Academy of Sciences to serve for 1952.

On July 1 Dr. Theodore E. White, paleontologist, was investigating deposits in the Canyon Ferry Reservoir. From there he proceeded to the Garrison Reservoir and subsequently to the Fort Randall Reservoir. At all three locations he collected fossils and continued his studies of the geology of the various areas. From September 22 to 29 he made a rapid survey of 10 proposed reservoir projects in the Niobrara River subbasin in Nebraska. The completion of that task in so short a time was made possible through the cooperation of Morris

Skinner of the Frick Laboratories who is thoroughly familiar with the area. From October 8 to 14 Dr. White examined Pliocene deposits in the Bonny Reservoir in northeastern Colorado. From November until June he was engaged in work elsewhere. Returning to the Missouri Basin on June 17, he proceeded to the Canyon Ferry Reservoir in Montana to continue his search for fossils. Nearly 100 specimens were collected, including forms previously unknown from the area. Those from the Oligocene deposits consisted of marsupials, insectivores, rodents, and small artiodactyls. The larger animals, such as the rhinoceroses, are represented only by fragments. The material obtained from the Miocene deposits consists of large oreodonts, beavers, rabbits, and small rodents. While at the Lincoln office Dr. White prepared a paper, "Observations on the Butchering Technique of Some Aboriginal Peoples," which was presented before the Eighth Annual Conference for Plains Archeology held at Lincoln late in November.

Oklahoma.—During the fiscal year both surveys and excavations were carried on in Oklahoma. From July 1 to August 10 Leonard G. Johnson and James G. Smith, field assistants, made a reconnaissance of the Gaines Creek Reservoir on Gaines Creek, a tributary of the South Canadian, in eastern Oklahoma. They located 52 archeological sites, most of which indicate temporary occupation despite the fact that at two locations there were mounds, and at other places villages seemed to have existed. Most of the sites in the Gaines Creek area were found on high ground above the high-water mark, but a number of those that will be flooded appear to be of some significance, and excavations have been recommended for six of them. In addition to the aboriginal remains, the former location of one historic settlement, North Fork Town, was established. The Gaines Creek Reservoir constitutes part of an alternate plan that has been prepared for that area. One plan calls for a single large reservoir to be known as the Eufaula. The other calls for three smaller projects which in the main will inundate approximately as large an area as the one reservoir. In view of that situation the surveys have been carried on from the standpoint of the three smaller reservoirs but extending the investigations sufficiently beyond their limits to take in the one large project. The other two smaller reservoirs, the Canadian and the Onapa, were surveyed during previous years. At that time the Canadian was found to involve 41 archeological sites and the Onapa 25. With the results of the Gaines Creek survey, it now is evident that a total of 118 sites will be included in the Eufaula basin if the one large project is carried through. If only one or two of the smaller reservoirs are completed, the archeological salvage needs will, of course, be less.

After completing their studies at the Gaines Creek project, Johnson and Smith proceeded to the Optima Reservoir area on the North Canadian (Beaver) River in Texas County. The dam for the project is to be erected just above the confluence of the North Canadian and Coldwater Creek and will flood areas along both streams. Three sites were found along the North Canadian and one along Coldwater Creek. In all cases they were found to be above the high-water line, and there is no urgency with respect to excavating them. Site 3 lies at the upper end of the basin that will be flooded along the North Canadian, and investigation at some future date has been recommended.

The excavations made in Oklahoma were in the area to be flooded by the Tenkiller Ferry Reservoir on the Illinois River near Tahlequah. Some testing was done at two locations, but most of the work was at a third, known as the Cookson site, where a party under the direction of Donald J. Lehmer dug 6 houses, 4 graves, 2 hearths, and 31 cache pits. Two components were isolated. The early one was characterized by rectangular houses with four center posts and trench entrances, while the later was characterized by rectangular houses with two center posts and indications of a bench along the north wall. There was no evidence of an entryway for these houses. The projectile points accompanying the early horizon fall within the range that is considered typical of Archaic and early Woodland in the Southeast. They also are common in the material from the prepottery Grove Focus in northeastern Oklahoma. Associated potsherds indicate a ware similar to the utility forms from the Spiro components. The latter ware in itself cannot be limited to an early horizon, but the small amount found in the excavations of the early component suggests that pottery was just beginning to appear in the complex. Stone artifacts in the late horizon differ somewhat from those of the earlier. Slate hoes and double-bitted axes are absent and projectile points are predominately small. The pottery associated with the late horizon is a shell-tempered ware which usually is decorated. The total complex has certain similarities to Orr's Fort Coffee Focus, but it probably will warrant being set up as a separate focus. The houses of the early horizon are similar to those considered typical of the early Spiro component, while those of the late horizon are quite similar to those for the late Spiro component.

The work at the Tenkiller Ferry was completed at the end of May, and Mr. Lehmer returned to the Missouri Basin headquarters at Lincoln. Throughout the period of the activities in Oklahoma, both for the surveys and the excavations, Dr. Robert E. Bell, of the University of Oklahoma, aided the field parties in the capacity of a consultant, and the University of Oklahoma cooperated in the loan of equipment and in making office space available to the men when they were in Norman.

Pennsylvania.—Investigations in Pennsylvania consisted of two survey projects. During October a reconnaissance was made of the Conemaugh River Reservoir in Indiana and Westmoreland Counties and of the East Branch Reservoir on the Clarion River in Elk and McKean Counties. The dam for the Conemaugh Reservoir, situated near Tunnelton, is scheduled for completion by December 1951. The reservoir will flood approximately 21 miles of the Conemaugh River and 11 miles of one of its larger branches, the Black Lick Creek. Within the pool area eight archeological sites were located. Of this group only one was deemed worthy of further exploration and excavation. It covers about 10 acres and is located on one of the larger terrace bottoms above the river near an old fording place. An Indian trail, the Venango, is supposed to have crossed the river at that point. The East Branch Reservoir apparently is located in a district where there was little aboriginal occupation because no archeological sites were found there. This probably may be attributed to the fact that the reservoir will fill a narrow V-shaped valley which was not suitable for Indian inhabitation. The surveys in Pennsylvania were made by Ralph S. Solecki.

Texas.—The River Basin Surveys in Texas continued to operate from the base and headquarters furnished by the department of anthropology of the University of Texas at Austin. Robert L. Stephenson was in charge from July 1 until April 15, when he was granted an extended leave of absence. Edward B. Jelks then assumed direction of the project. During the fiscal year surveys were begun and completed in the Ferrell's Bridge Reservoir on Cypress Creek in northeast Texas and in the Granite Shoals Reservoir on the Colorado River in central Texas. Excavations were continued and brought to completion in two field sessions in the Lavon Reservoir on the East Fork of the Trinity River, while the first field session at Garza-Little Elm Reservoir on the Elm Fork of the Trinity resulted in the excavation of two sites and the brief testing of three others. Excavations were also started and brought to completion in three sites in the Falcon Reservoir on the Rio Grande. The excavation of two sites and testing of three others were completed in the Belton Reservoir on the Leon River in central Texas.

The excavations started the previous year in the Lavon Reservoir were completed on August 2, with recommendation for additional excavation to be undertaken during the spring of 1951. The work there included excavation of over 40 percent of the large circular pit in the Hogge Bridge site as well as several test squares and several deep-strata squares outside the pit. The purpose for which the pit was built is still unknown, but it was determined that the site is a pure component of the newly delineated Wylie Focus. This is a culture complex probably overlapping the latter part of Gibson aspect and

the early part of Fulton aspect times in the Caddoan area and is coeval with the Henrietta Focus of the southern Plains area. It is not a part of either of those complexes but apparently an independent culture in contact with both and dating probably between 1300 and 1500.

Excavations were started in three archeological sites in the Falcon Reservoir on February 9. Donald D. Hartle was appointed temporary field archeologist for this project, and, under the supervision of Mr. Stephenson, he dug two historic sites and one deeply buried site. No positive evidence of Indian occupation was found in the two historic sites, which consisted of two and four stone-house ruins, respectively. Both probably may be referred to the Early to Middle Spanish Colonial period in the area. In the prehistoric site, a bulldozer was used for half a day and an area 20 feet by 40 feet was uncovered to an average depth of 12 feet below the surface, exposing an extensive occupation area which was excavated by hand in arbitrary 6-inch levels to an additional depth of 18 inches. Large quantities of workshop refuse and 200 artifacts were recovered from the level. The stratigraphic profile provided by the 12-foot trench wall revealed two additional occupation levels at depths from the surface of approximately 4 and 7 feet, respectively.

In the Ferrell's Bridge Reservoir, E. O. Miller and E. H. Moorman conducted a survey from January 29 to February 16 and from April 9 to 21. During that survey 34 archeological sites were located and recorded. Five of them contain small artificial earth mounds; the remainder are open occupational areas. Six of the sites have been recommended for further excavation.

The Belton Reservoir, surveyed the preceding year and recommended for no further excavation, was later found to contain two previously unknown archeological sites meriting some investigation. Mr. Miller and Mr. Moorman, who had located the sites, spent the periods December 11 to 13 and February 28 to March 2 in brief excavations of the Urbantke site and the Grimes-Houy site. In addition, they made extensive tests in three other nearby sites. It was found that the Urbantke site contained considerably more pottery than most of the sites in the area. The artifact analysis showed considerable similarity to the three rock shelters excavated the previous year in the Whitney Reservoir area. The excavations at the Grimes-Houy site uncovered 10 burials, and analysis of the artifacts and site features indicates a relatively late date. It possibly was a Comanche burial site.

The second season of excavations at the Lavon Reservoir was begun on March 12 and continued until May 4. The work included further digging in the Hogge Bridge site and extensive excavations in the Branch and Campbell Hole sites. In order to determine quickly the stratigraphic profile involved in the large circular pits in those sites,

a bulldozer was used for a total of 221½ hours. This provided extensive stratigraphic trenches through the pit and the midden areas in the Branch and Hogge Bridge sites and one long exploratory trench in the Campbell Hole site. The use of a bulldozer for this work proved very satisfactory, and little material damage was done to the artifacts or the features encountered.

The first field session at the Garza-Little Elm Reservoir was begun on May 7 and continued until June 13. Extensive excavations were completed in the Lake Dallas and Ledbetter sites and brief tests were made at the Pease and Craft sites. One of the few large Archaic sites in this area, the Lake Dallas site, yielded artifacts that should be valuable in the integration of the Archaic complexes of northeast Texas. At the Ledbetter site—one of the most extensive local examples of the later agriculture-pottery period—an interesting group of artifacts was found that suggests contacts with both the Caddoan peoples to the east and the peoples who lived to the west and southwest.

At the Granite Shoals Reservoir, surveyed during February and March by Robert H. Humphreys, 12 archeological sites were located and recorded. They are all open occupational areas along the narrow valley of the Colorado River. None are extensive or deeply stratified, and since some information is on record from sites both upstream and downstream from this project no further investigations are recommended. Such evidence as was found during the reconnaissance and testing indicated that the Granite Shoals region probably was occupied by people of the Round Rock and Uvalde Foci over a period of many centuries.

Dr. Theodore E. White spent the first 2 weeks in April in the Austin laboratory identifying the faunal remains from the archeological excavations of the Whitney, Lavon, Belton and Falcon Reservoirs. During the remainder of April and the first week of May, he collected fossils from the Upper Cretaceous deposits of the Lavon Reservoir. He devoted most of May to investigations at the Garza-Little Elm Reservoir, where he located and collected several vertebrate specimens of Pleistocene age. They included a bison skull, a turtle, and a horse jaw.

When he was not in the field, Robert L. Stephenson, archeologist, devoted his time to analysis and study of the archeological materials from the Lavon and Whitney Reservoirs and in organizing and programming the work for the various field parties sent out from the Austin headquarters. He completed an article on "Culture Chronology in Texas," which was published in *American Antiquity*, and finished a paper, "The Hogge Bridge Site and the Wylie Focus," for publication in the same periodical.

Edward B. Jelks, archeologist, assisted Mr. Stephenson in the field and laboratory throughout the year until April 15, when he took

over supervision of the Texas project. He spent most of the remainder of the year in the field at the Lavon and Garza-Little Elm excavations. He prepared a "Field Manual for Beginners in Central Texas Archeology," which was mimeographed and distributed to amateur archeologists who had requested guidance. As a result of historical research undertaken to supplement archeological investigation at the Stansbury site in the Whitney Reservoir, he prepared a paper, "Indians of the Central Brazos Area," which was presented at the annual meeting of the Texas Historical Association on April 27.

E. O. Miller and E. H. Moorman served as field and laboratory assistants throughout the year. They participated in the investigations in the Lavon and Garza-Little Elm Reservoirs, began and completed the excavations in the Belton Reservoir, and carried on the survey of Ferrell's Bridge Reservoir. The remainder of their time was spent in the laboratory in Austin cataloging and tabulating the materials from the various field projects and preparing a report on their survey of the Ferrell's Bridge Reservoir.

As a result of the financial status of the River Basin Surveys' work in the Texas area, the Austin office was closed on June 30.

Virginia.—Field work in Virginia during the year included the survey of one reservoir area and the excavation of a number of sites in another. On July 1, Carl F. Miller was digging at a site immediately east of Clarksville, Va., on the east bank of the Roanoke River in the Buggs Island Reservoir. Stripping operations there had destroyed a large part of the site before information was received about the work under way. Consequently, it was possible to salvage material from only two small portions of the site. From those areas 77 burials with their accompanying artifacts were recovered, and various midden pits, as well as the remains of a rectangular structure, were uncovered. That project was completed early in August. On February 28, excavations in the Buggs Island area were resumed, and from then until June 20, digging was carried on at nine different sites. At one there was stratification showing that it was first occupied during the pre-ceramic times and had continued in use until about the middle of the ceramic period, when it was abandoned. Two of the sites investigated were on Occaneechi Island near Clarksville. One of them contained heavy cultural deposits consisting of both Indian and European materials. Unfortunately, there had been so much disturbance by the later occupation that it was difficult to obtain satisfactory evidence from it, although a good series of artifacts was found. The second site on the island was one of the largest thus far examined in the basin. Forty-four burials were found there representing all types from fully flexed to partial cremation. The burned floor area of a large rectangular structure measuring 35 by 15 feet was uncovered. The house had five distinct floor levels interspersed with layers of clean sand.

Whether that indicated five separate occupations of the structure or remodeling activities during the course of a long-continued tenancy is not known, but further study of the data obtained from the digging may throw light on the subject. The structure had been built over a number of burials, and after it was abandoned other graves were dug through the floor, showing that the site continued to be inhabited after the dwelling had burned. A number of the burials were accompanied by turtle carapaces, which undoubtedly were placed there as funerary offerings. They do not seem to have been used as food receptacles, for in every instance they were inverted. Possibly they may have had totemic significance and were placed with the dead to indicate that the individual was a member of the turtle clan. A good pottery series obtained from the site should fill certain gaps in the sequence for the area. The work on Occaneechi Island indicates that it was not the place where the village mentioned by Lederer, who visited it in 1670, was located and that previous identification of it as such was in error. The current investigations indicate that the Occaneechi village probably was on another island lying some distance downstream from the one that now bears that name.

It had been hoped that at two of the sites, where fluted points and other artifacts suggestive of the eastern variant of the Folsom complex had been picked up from the surface, some remnants of the deposits belonging to that period would still be intact. The excavations showed, however, that the sites had suffered extensive erosion and that the artifacts previously found there were simply float material that remained when the deposits were carried away. Additional work still remains to be done at the Buggs Island Reservoir. The survey was made at the Philpott Reservoir during the last week in June. The archeological manifestations found there are so closely related to those in the Buggs Island area that no additional work will be required. Materials gathered from the surface are so similar to those from Buggs Island sites that they could not be recognized if placed in the same collections.

West Virginia.—The only work done in West Virginia during the year was the brief survey made at the site of the new navigation lock at Morgantown. Examination of the area involved by the construction disclosed that practically no new lands will be inundated by the project. The water there is to be kept within the limits of the river channel, which has rather steep and confining banks. Railroads parallel the channel on both sides, and any archeological remains that may have been there at one time were long since destroyed. No further investigations are necessary at that project.

Cooperating institutions.—Various State and local institutions cooperated with the River Basin Surveys during the year. Space for field offices and laboratories for units of the Surveys were provided

by the Universities of Nebraska, Oregon, Georgia, and Texas. The Universities of Oklahoma and Kentucky furnished temporary bases of operations for the parties working in their States. The University of Oklahoma took over the responsibility for the excavation of sites in the Fort Gibson Reservoir, and the University of Georgia continued making surveys along the Flint River in the southern part of that State. The University of Missouri and the Missouri Archeological Society continued to make surveys in a number of proposed reservoir areas and carried on excavations in others. The University of Arkansas also made surveys and did some digging in reservoir areas in that State. In June, parties with which the River Basin Surveys were cooperating began excavations in the McNary Reservoir and at Lind Coulee in Washington. The McNary party came from the University of Washington at Seattle; that at Lind Coulee from the Washington State College at Pullman.

The program developed by the National Park Service late in the previous year whereby various scientific agencies carried on salvage work in proposed reservoir areas continued throughout fiscal year 1951. On the basis of agreements between the agencies concerned and the National Park Service, certain funds were made available to the agencies to help finance specified investigations. The River Basin Surveys served in a consultative and advisory capacity only in the carrying out of that program. Agreements were made, however, with the University of Nebraska, the Nebraska State Museum, the Nebraska State Historical Society, the University of Kansas, the University of South Dakota, the North Dakota Historical Society, the University of Wyoming, and the University of Montana for work in the Missouri Basin. Similar agreements were made with the University of Mississippi for a survey of the Grenada Reservoir in that State, with the University of Oklahoma for excavations at the Eufaula Reservoir, with the University of Texas for excavations at the Falcon Reservoir, with the Museum of New Mexico at the Chamita Reservoir, with the University of California for excavations at the Farmington Reservoir, and with the University of Washington for work in the McNary area. The final results of the work accomplished under those agreements will be published by the institutions concerned, but they will correlate with and augment the information obtained by the River Basin Surveys.

INSTITUTE OF SOCIAL ANTHROPOLOGY

(Report prepared by G. M. FOSTER)

General statement.—The objectives of the Institute of Social Anthropology are anthropological research on the community life of rural peoples of Latin America and the training of Latin American

nationals in the methods and principles of modern social anthropology. The purpose is to inform both the social scientist and layman in the United States concerning little-known peoples of other parts of the world and to build up in various Latin American countries a corps of professionally trained scientists and friends.

During the past year the Institute was financed by transfers of funds from the Department of State, totaling \$92,740, from the appropriation "International Information and Educational Activities, 1951." As in the previous year, long-term planning has been done on a very tentative basis because of budget uncertainties for the future. Nevertheless, a full program was maintained in all countries, and work on a short-term basis was initiated in Guatemala. The year in review has seen increasing interest on the part of the Institute in a more direct application of anthropological knowledge and techniques to the practical problems of social and economic change that face Latin American countries. Accordingly, for the first time an attempt was made to enlist Institute personnel in a common research problem in all four countries in which programs have been maintained for several years for the purpose of pointing up some of the types of contributions anthropologists can make to "action" programs of economic and social betterment in so-called underdeveloped areas. It was decided that an analysis of American-sponsored technical-aid programs, with a history of several years of successful operations, might reveal common operational problems, the solution of which might be facilitated by anthropological counseling. After reviewing a number of programs, it was decided that health centers developed by the Institute of Inter-American Affairs in cooperation with the Ministries of Health of México, Colombia, Perú, and Brazil would be the most satisfactory subjects. Two centers in each country, one urban and one rural, were selected, and during March and April the operations of these centers were studied, particularly in relationship to the basic cultures of the peoples served. A dual goal was envisaged: (1) that of determining, if possible, what may be the common factors that favor and factors that inhibit the introduction and acceptance of ideas and habits new to the ethnic groups in question; (2) that of pointing up difficulties in going projects, and making remedial suggestions. A 100-page mimeographed report was prepared, which outlined the theoretical basis for the work, described the work of health centers, discussed salient aspects of indigenous culture that were affected by this work, and made suggestions as to how utilization of anthropological knowledge would increase the effectiveness of such work. One hundred copies were sent to the Institute of Inter-American Affairs, and plans made to distribute additional copies to various national and international organizations carrying out a wide variety of technical-aid programs.

Major activities in each of the field offices, and in Washington, were as follows:

Brazil.—Drs. Donald Pierson, sociologist, and Kalervo Oberg, social anthropologist, continued their research and teaching activities in cooperation with the Escola Livre de Sociologia e Política in São Paulo. Dr. Pierson's administrative duties as dean of the graduate division occupied much of his time. In addition, he gave three courses in sociology and guided independent and graduate research. In February 1951, he directed an intensive course on rural life in Brazil, sponsored by several ministries of the state of São Paulo, to about 70 persons who are government employees and administrators in various offices. Dr. Pierson continued to develop plans for extensive social-science research as a part of the Brazilian Government's plan for economic and social development of the São Francisco River Valley. This planning came to a head with an offer from the National Commission of the São Francisco Valley to transfer \$27,000 to a fund to be directed by Dr. Pierson for intensive socioethnological study and analysis of the problems of industrialization and settlement in this enormous area.

Dr. Oberg returned to São Paulo in July 1950, via Lima, after a period of consultation in the United States. While in Lima he visited and consulted with Ozzie Simmons, Institute representative in that country. During the fall, and a part of the spring, he gave courses in anthropology as usual at the Escola. During March and April he carried out health-center investigations at Colatina, in the Rio Doce Valley, and Cameté, at the mouth of the Tocantins River in the Amazon basin. A lengthy report covering this work was submitted to the local offices of the Institute of Inter-American Affairs. In April Dr. Oberg represented the Smithsonian Institution and the United States Government in Rio de Janeiro at the Second Annual National Indian Week. At the end of the year plans were being completed to lend Dr. Oberg for a 6-week period to the Institute of Inter-American Affairs for additional anthropological work in Chonin, in Minas Gerais.

Colombia.—Because of the budgetary uncertainties it was necessary to discontinue the Colombian program in 1949. A new memorandum of understanding was agreed upon in November 1950 by the Ministry of Foreign Affairs of Colombia and the United States Department of State whereby it was agreed that future Smithsonian Institution activities in Colombia would be in collaboration with the Instituto Etnológico Nacional in Bogotá, directed by Licenciado Luis Duque Gómez, rather than with the Popayán branch of the Instituto, as in former years. Charles J. Erasmus joined the staff of the Institute of Social Anthropology in the fall of 1950 to take charge of this program. Mr. Erasmus has given a general course in ethnography at the Insti-

tuto *Etnológico* as a part of the regular curriculum of this organization. A number of Colombian towns and villages were surveyed for possible field work, and final decision was made on the village of Kota, about 20 kilometers to the north of Bogotá. This is a typical mestizo village of the Savanna of Bogotá, representative of much of rural Colombian life, and conveniently close to Bogotá so that short vacation periods as well as long field periods are possible. During March and April Mr. Erasmus devoted his time to the health-center research described in the introduction, working in the Ricuarte barrio of Bogotá, and in the Magdalena River port of La Dorada.

Guatemala.—Late in 1950, upon the request of Dr. Antonio Goubaud-Carrera, Guatemalan Ambassador to the United States, the temporary detail of an Institute ethnologist to Guatemala became possible. Accordingly, Richard N. Adams joined the staff, arriving in that country in December. In the seven months at his disposal Dr. Adams gave a general course in the Instituto de Antropología e Historia. A series of special lectures was also given to personnel of the Instituto Indigenista. Dr. Adams also supervised field research in several villages, including La Magdalena, near Guatemala City, in which the Central American Institute of Nutrition is carrying out long-range investigations. This work was designed to shed light on the cultural factor in a program aimed at bettering the nutritional and general health practices of the peoples concerned, and in gathering data applicable to similar projects in other Central American countries. Because of budgetary limitations it was, unfortunately, necessary to drop Dr. Adams from the Institute staff at the end of the fiscal year. Fortunately, it was possible to make arrangements for him to continue his Guatemalan work by means of a Department of State specialist grant.

México.—During the fall of 1950 Dr. Isabel T. Kelly, Institute representative, continued preparation of the second volume on the Tain Totonac Indians, the first volume of which was sent to the printer in June 1950. In March 1951 she participated in health-center analyses, studying the Beatriz Velasquez Alemán Center in Mexico City, and that in the suburb of Xochimilco. Late in the winter she made a reconnaissance trip through the Sierra de Puebla and selected the highland Totonac village of San Marcos Eloxochitlán for field work. In April a 3-month period of field work was initiated, in which five students from the Escuela Nacional de Antropología participated. This study of a highland Totonac community will, among other things, in conjunction with the lowland Tain Totonac afford data on the relationship of environment to culture.

Dr. William Wonderly joined the Institute in March 1951 to teach linguistics at the Escuela Nacional. This was the first time that linguistics had been taught in México under Institute of Social Anthro-

pology auspices since Dr. Stanley Newman left three years ago. Two courses were given, one on general linguistics and the other on morphology and syntax.

Perú.—Ozzie G. Simmons continued his teaching activities at the Instituto de Estudios Etnológicos in Lima. Field studies, in which several Peruvian students participated, were initiated in the non-Indian village of Lunahuaná, in the upper Cañete Valley, south of Lima. This work, when completed in 1951, will still further broaden our knowledge of contemporary Peruvian rural culture, which already includes the villages of Moche (Gillin), Sicaya (Tschopik, Muelle, and Escobar), and Virú (Holmberg and Muelle). During April Mr. Simmons carried out his part of the health-center investigations, studying the Lima center in Rimac barrio, and the center in Chimbote, on the north coast of Perú.

Washington.—Dr. Gordon R. Willey served as Acting Director of the Institute until September, at which time he went to Harvard University as Bowditch Professor of Mexican and Central American Archeology and Ethnology.

Dr. George M. Foster returned in September from a year's field trip to Spain to resume duties as Director of the Institute. While in Spain, Dr. Foster worked with Dr. Julio Caro Baroja, director of the Museo del Pueblo Español in Madrid, making a general survey, based on printed sources and field studies, of Spanish ethnography. Dr. Foster's part of the work was oriented toward the historical and theoretical problems involved in the carrying of Spanish culture to the New World, and its assimilation with native American culture. This work was planned to give added depth and background to the continuing studies of Institute and cooperating Latin American personnel.

Dr. Foster made a month's trip in March to Guatemala, Colombia, and Perú, for the purpose of consulting with Institute field personnel, and appraising the new Guatemalan project as well as the newly opened Bogotá office. Consultations were also held with heads of the participating national institutions in all three countries. Dr. Foster spent much of the month of June in assembling the health center's report.

EDITORIAL WORK AND PUBLICATIONS

There were issued one Annual Report and two Bulletins (one a volume of the Handbook of South American Indians), and two Publications of the Institute of Social Anthropology, as listed below:

Sixty-seventh Annual Report of the Bureau of American Ethnology, 1949-50. ii+25 pp. 1951.

Bulletin 143. Handbook of South American Indians. Julian H. Steward, editor. Volume 6, Physical anthropology, linguistics, and cultural geography of South American Indians. xiii+715 pp., 47 pls., 3 figs., 18 maps. 1950.

Bulletin 144. The northern and central Nootkan tribes, by Philip Drucker. ix+480 pp., 5 pls., 28 figs., 8 maps. 1951.

Institute of Social Anthropology Publ. No. 11. Quiroga: A Mexican municipio, by Donald D. Brand, assisted by José Corona Núñez. v+242 pp., 35 pls., 4 maps. 1951.

Institute of Social Anthropology Publ. No. 12. Cruz das Almas: A Brazilian village, by Donald Pierson, with the assistance of Levi Cruz, Mirtes Brandão Lopes, Helen Batchelor Pierson, Carlos Borges Teixeira, and others. x+226 pp., 20 pls., 13 figs., 2 maps. 1951.

The following publications were in press at the close of the fiscal year:

Bulletin 145. The Indian tribes of North America, by John R. Swanton.

Bulletin 146. Chippewa child life and its cultural background, by Sister M. Inez Hilger.

Bulletin 147. Journal of an expedition to the Mauvaises Terres and the Upper Missouri in 1850, by Thaddeus B. Culbertson. Edited by John Francis McDermott.

Bulletin 148. Arapaho child life and its cultural background, by Sister M. Inez Hilger.

Bulletin 149. Symposium on diversity in Iroquois culture. Edited by William N. Fenton.

No. 1. Introduction: The concept of locality and the program of Iroquois research, by William N. Fenton.

No. 2. Concepts of land ownership among the Iroquois and their neighbors, by George S. Snyderman.

No. 3. Locality as a basic factor in the development of Iroquois social structure, by William N. Fenton.

No. 4. Some psychological determinants of culture change in an Iroquoian community, by Anthony F. C. Wallace.

No. 5. The religion of Handsome Lake: Its origin and development, by Merle H. Deardorff.

No. 6. Local diversity in Iroquois music and dance, by Gertrude P. Kurath.

No. 7. The Feast of the Dead, or Ghost Dance at Six Nations Reserve, Canada, by William N. Fenton and Gertrude P. Kurath.

No. 8. Iroquois women, then and now, by Martha Champion Randle.

Bulletin 150. The modal personality of the Tuscarora Indians, as revealed by the Rorschach test, by Anthony F. C. Wallace.

Bulletin 151. Anthropological Papers, Numbers 33-42.

No. 33. "Of the Crow Nation," by Edwin Thompson Denig. With biographical sketch and footnotes by John C. Ewers.

No. 34. The water lily in Maya art: A complex of alleged Asiatic origin, by Robert L. Rands.

No. 35. The Medicine Bundles of the Florida Seminole and the Green Corn Dance, by Louis Capron.

No. 36. Technique in the music of the American Indian, by Frances Densmore.

No. 37. The belief of the Indian in a connection between song and the supernatural, by Frances Densmore.

No. 38. Aboriginal fish poisons, by Robert F. Heizer.

No. 39. Aboriginal navigation off the coasts of Upper and Baja California, by Robert F. Heizer and William C. Massey.

No. 40. Exploration of an Adena Mound at Natrium, W. Va., by Ralph S. Solecki.

Bulletin 151. Anthropological Papers, Numbers 33-42—Continued

No. 41. The Wind River Shoshone Sun Dance, by D. B. Shimkin.

No. 42. Current trends in the Wind River Shoshone Sun Dance, by Fred W. Voget.

Bulletin 152. Index to Schoolcraft's "Indian Tribes of the United States," compiled by Frances S. Nichols.

Bulletin 153. La Venta, Tabasco: A study of Olmec ceramics and art, by Philip Drucker.

Bulletin 154. River Basin Surveys Papers. Inter-Agency Archeological Salvage Program. Numbers 1-6.

No. 1. Prehistory and the Missouri Valley Development Program: Summary report on the Missouri River Basin Archeological Survey in 1948, by Waldo R. Wedel.

No. 2. Prehistory and the Missouri Valley Development Program: Summary report on the Missouri River Basin Archeological Survey in 1949, by Waldo R. Wedel.

No. 3. The Woodruff Ossuary, a prehistoric burial site in Phillips County, Kans., by Marvin F. Kivett.

No. 4. The Addicks Dam site:

I. An archeological survey of the Addicks Dam basin, Southeast Texas, by Joe Ben Wheat.

II. Indian skeletal remains from the Doering and Kobs Sites, Addicks Reservoir, Texas, by Marshall T. Newman.

No. 5. The Hodges site:

I. Two rock shelters near Tucumcari, N. Mex., by Herbert W. Dick.

II. Geology of the Hodges site, Quay County, N. Mex., by Sheldon Judson.

No. 6. The Rembert mounds, Elbert County, Ga., by Joseph R. Caldwell.

Appendix. List of River Basin Surveys reports published in other series.

Bulletin 155. Settlement patterns in the Virú Valley, Perú, by Gordon R. Willey.

Institute of Social Anthropology Publ. No. 13. The Tajin Totonac: Part 1. History, subsistence, and technology, by Isabel Kelly and Angel Palerm.

Institute of Social Anthropology Publ. No. 14. The Indian caste of Peru, 1795-1950: A population study based upon tax records and census reports, by George Kubler.

Institute of Social Anthropology Publ. No. 15. Indian tribes of Northern Mato Grosso, Brazil, by Kalervo Oberg. With appendix by Marshall Newman on "Anthropometry of the Umotina, Nambicuará, and Iranxe."

Institute of Social Anthropology Publ. No. 16. Penny capitalism: A Guatemalan Indian economy, by Sol Tax.

Publications distributed totaled 22,377 as compared with 19,116 for the fiscal year 1950.

LIBRARY

One hundred twenty-three volumes were added to the library of the Bureau, bringing the total accessions as of June 30, 1951, to 34,961.

ARCHIVES

Manuscript material has been made available to research workers both in the office and through the furnishing of microfilm copies. The

major project accomplished during the year was the classification of the great collection of Iroquois material assembled by J. N. B. Hewitt.

The addition of five new metal storage cabinets greatly improved the conditions for protecting the manuscripts. Since more cabinets could not be obtained, another method of storage for the material in the archives annex was developed. Using heavy cardboard filing boxes, graded to size, does away with the wrappings formerly used and makes the material much easier to consult.

A method of preserving the rare Indian drawings in the collections by the process of lamination was adopted on advice from the preservation division of the National Archives.

Through the librarian of the Geological Survey, the collections have been enriched by the addition of the original catalog of the photographic negatives made on the famous Grand Canyon expedition of J. W. Powell. This list in Major Powell's handwriting, removes all doubt as to the identification of the pictures made by J. K. Hillers and E. O. Beaman. The original negatives have long constituted an important sector of the Bureau's Indian photographic archives.

COLLECTIONS

Acc. No.

185184. Archeological materials and skeletal remains of 7 individuals from the Addicks Reservoir, on South Mayde Creek in Harris County, 16 miles west of Houston, Tex., collected 1947 by Joe Ben Wheat, River Basin Surveys.
187265. Archeological materials from 12 sites in Tenkiller Ferry Reservoir area, located on the Illinois River about 13 miles above its confluence with the Arkansas River and about 7 miles northwest of Vian, in Sequoyah and Cherokee Counties, Okla., collected by David J. Wenner, Jr., River Basin Surveys.
187266. Archeological materials surface-collected from 2 sites in the Hulah Reservoir area on Caney River about 15 miles northwest of Bartlesville, near Hulah, northeastern Osage County, Okla., collected in 1947 by David J. Wenner, Jr., River Basin Surveys.
187267. Archeological materials surface-collected from 17 sites in the Fort Gibson Reservoir area, a Corps of Engineers water-control project on the Grand (Neosho) River, beginning 7.7 miles above its mouth and including portions of Wagoner, Cherokee, and Mayes Counties, Okla., collected in 1947 by David J. Wenner, Jr., River Basin Surveys.
187539. Archeological material from Postcontact Eskimo sites on Itkillik Lake and at Anaktuvuk Pass in the Brooks Range, northwestern Alaska, collected during the summer of 1949 in the Colville Basin by Arthur Bowsher and Dr. George Llano.
187540. Archeological material, mainly stonework, from the West Fork Reservoir, Lewis County, W. Va., collected in April 1948 by Ralph Solecki, River Basin Surveys.
187541. Archeological material from Bluestone Reservoir area, on the New River, 100 miles south of Charleston, between Hinton and Narrows, W. Va.; in Giles County, Va.; Monroe and Summers Counties, W. Va., collected March-May 1948 by Ralph S. Solecki, River Basin Surveys.

Acc. No.

187542. Archeological materials from a mound at Natrium, Marshall County, W. Va., collected by Ralph S. Solecki during December 1948 and January 1949.
187742. Approximately 80 fossil mammals from the Boysen Reservoir area of Wyoming, the Canyon Ferry Reservoir area of Montana, and the Garrison Reservoir area of North Dakota, collected by Dr. T. E. White, River Basin Surveys.
188194. (Through Dr. F. H. H. Roberts, Jr.) 4 specimens, including Creodont skull from the Paleocene of North Dakota, Plesiosaur skull, fish and a marine turtle from the Pierre Cretaceous, collected by Dr. T. E. White at the Fort Randall Reservoir area in South Dakota, River Basin Surveys.
188807. (Through Dr. Paul L. Cooper) 4 fresh-water mussels from Hitchcock County, Nebr., River Basin Surveys.
189103. Archeological material, mostly potsherds, from Utivé, Panamá, collected by Dr. Matthew W. Stirling.
189439. Archeological materials from Round Bottom site on the Travis farm about 3½ miles south of Moundsville, Marshall County, W. Va., collected, with the exception of 3 celts presented by Mr. Travis, by Ralph S. Solecki during December 1948 and January 1949.
191092. 23 lizards, 6 snakes, 13 frogs, 10 marine invertebrates, and insect specimens from Panamá, collected by Dr. Matthew W. Stirling and party during the 1951 Smithsonian Institution-National Geographic Society Expedition.
188344. (Through Dr. Henry B. Collins, Jr.) Approximately 250 spiders, 27 springtails, and 1 parasitic wasp from Cornwallis Island, Canadian Arctic, collected by Dr. Collins in summer of 1950 on National Museum of Canada-Smithsonian Institution Expedition.

MISCELLANEOUS

During the year Dr. Frances Densmore, Dr. John R. Swanton, and Dr. Antonio J. Waring, Jr., continued as collaborators of the Bureau.

Information was furnished during the year by members of the Bureau staff in reply to numerous inquiries concerning the American Indians, past and present, of both continents. Requests from teachers of primary and secondary grades and from Scout organizations continue to increase and indicate a rapidly growing interest in the American Indians throughout the country. Various specimens sent to the Bureau were identified and data on them furnished for their owners.

Respectfully submitted.

M. W. STIRLING, *Director.*

Dr. A. WETMORE,

Secretary, Smithsonian Institution.

APPENDIX 6

Report on the International Exchange Service

SIR: I have the honor to submit the following report on the activities of the International Exchange Service for the fiscal year ended June 30, 1951:

The Smithsonian Institution is the official United States agency for the exchange with other nations of governmental, scientific, and literary publications. The International Exchange Service, initiated by the Smithsonian Institution in the early years of its existence for the interchange of scientific publications between learned societies and individuals in the United States and those of foreign countries, serves as a means of developing and executing in part the broad and comprehensive objective, "the diffusion of knowledge." It was later designated by the United States Government as the agency for the transmission of official documents to selected depositories throughout the world, and it continues to execute the exchanges pursuant to conventions, treaties, and other international agreements.

Although the weight of the packages received for transmission during the year decreased by 43,314 pounds to the total of 788,773 pounds, the number of packages increased by 1,375 to the total of 1,011,000—the greatest number of packages received during any year of the existence of the International Exchange Service.

The average weight of the individual package decreased to 12.46 ounces, approximately the same as the 13-ounce average of 1950. The majority of the publications now being transmitted are current publications rather than large lots of accumulated publications. The publications received from both the foreign and domestic sources for shipment are classified as shown in the following table:

Classification	Packages		Weight	
	Number	Number	Pounds	Pounds
United States parliamentary documents sent abroad.....	531, 033		204, 355	
Publications received in return for parliamentary documents.....		10, 963		18, 175
United States departmental documents sent abroad.....	257, 542		220, 279	
Publications received in return for departmental documents.....		8, 013		17, 455
Miscellaneous scientific and literary publications sent abroad.....	154, 960		234, 803	
Miscellaneous scientific and literary publications received from abroad for distribution in the United States.....		48, 489		93, 706
Total.....	943, 535	67, 465	659, 437	129, 336
Grand total.....	1, 011, 000		788, 773	

The packages of publications are forwarded to the exchange bureaus of foreign countries by freight or, where shipment by such means is impractical, to the addressees by direct mail. The number of boxes shipped to the foreign exchange bureaus was 2,884, only 5 less than for the previous year. Of these boxes 765 were for depositories of full sets of United States Government documents, these publications being furnished in exchange for the official publications of foreign governments which are received for deposit in the Library of Congress. The number of packages forwarded by mail and by means other than freight was 190,690.

The reduction in transportation costs, accomplished by exporting through Baltimore rather than New York and first effected in 1947, is being gradually neutralized by steadily increasing transportation rates. The increasing freight and postal rates are primarily responsible for the 145,727 pounds of publications that remained unshipped at the end of the fiscal year.

No shipments are being made to either China or Rumania. Publications intended for addresses in Formosa and formerly sent through the Chinese Exchange Bureau at Nanking are now forwarded by direct mail.

FOREIGN DEPOSITORIES OF GOVERNMENTAL DOCUMENTS

The number of sets of United States official publications received by the Exchange Service for transmission abroad in return for the official publications sent by foreign governments for deposit in the Library of Congress is now 102 (61 full and 41 partial sets), listed below. Changes that occurred during the year are shown in the footnotes.

DEPOSITORIES OF FULL SETS

- ARGENTINA: División Biblioteca, Ministerio de Relaciones Exteriores y Culto, Buenos Aires.¹
- AUSTRALIA: Commonwealth Parliament and National Library, Canberra.
- NEW SOUTH WALES: Public Library of New South Wales, Sydney.
- QUEENSLAND: Parliamentary Library, Brisbane.
- SOUTH AUSTRALIA: Public Library of South Australia, Adelaide.
- TASMANIA: Parliamentary Library, Hobart.
- VICTORIA: Public Library of Victoria, Melbourne.
- WESTERN AUSTRALIA: Public Library of Western Australia, Perth.
- AUSTRIA: Administrative Library, Federal Chancellery, Vienna.
- BELGIUM: Bibliothèque Royale, Bruxelles.
- BRAZIL: Biblioteca Nacional, Rio de Janeiro.
- BULGARIA: Bulgarian Bibliographical Institute, Sofia.
- BURMA: Government Book Depot, Rangoon.

¹ Changed from Dirección de Investigaciones, Archivo, Biblioteca y Legislación Extranjera.

- CANADA: Library of Parliament, Ottawa.
 MANITOBA: Provincial Library, Winnipeg.
 ONTARIO: Legislative Library, Toronto.
 QUEBEC: Library of the Legislature of the Province of Quebec.
- CEYLON: Department of Information, Government of Ceylon, Colombo.
- CHILE: Biblioteca Nacional, Santiago.
- CHINA: Ministry of Education, National Library, Nanking, China.²
 PEIPING: National Library of Peiping.²
- COLOMBIA: Biblioteca Nacional, Bogotá,
- COSTA RICA: Biblioteca Nacional, San José.³
- CUBA: Ministerio de Estado, Canje Internacional, Habana.
- CZECHOSLOVAKIA: Bibliothéque de l'Assemblée Nationale, Prague.
- DENMARK: Institut Danois des Échanges Internationaux, Copenhagen.
- EGYPT: Bureau des Publications, Ministère des Finances, Cairo.
- FINLAND: Parliamentary Library, Helsinki.
- FRANCE: Bibliothéque Nationale, Paris.
- GERMANY: Öffentliche Wissenschaftliche Bibliothek, Berlin.
 Parliamentary Library, Bonn.
- GREAT BRITAIN:
 ENGLAND: British Museum, London.
 LONDON: London School of Economics and Political Science. (Depository of the London County Council.)
- HUNGARY: Library of Parliament, Budapest.
- INDIA: National Library, Calcutta.
 Central Secretariat Library, New Delhi.⁴
- INDONESIA: Ministry for Foreign Affairs, Djakarta.
- IRELAND: National Library of Ireland, Dublin.
- ISRAEL: Government Archives and Library, Hakiryá.
- ITALY: Ministerio della Pubblica Istruzione, Rome.
- JAPAN: National Diet Library, Tokyo.⁵
- MEXICO: Secretaría de Relaciones Exteriores, Departamento de Información para el Extranjero, Mexico, D. F.
- NETHERLANDS: Royal Library, The Hague.
- NEW ZEALAND: General Assembly Library, Wellington.
- NORWAY: Utenriksdepartementets Bibliothek, Oslo.
- PERU: Sección de Propaganda y Publicaciones, Ministerio de Relaciones Exteriores, Lima.
- PHILIPPINES: Bureau of Public Libraries, Department of Education, Manila.
- POLAND: Bibliothéque Nationale, Warsaw.
- PORTUGAL: Biblioteca Nacional, Lisbon.
- SPAIN: Biblioteca Nacional, Madrid.
- SWEDEN: Kungliga Biblioteket, Stockholm.
- SWITZERLAND: Bibliothéque Centrale Fédérale, Berne.
- TURKEY: Department of Printing and Engraving, Ministry of Education, Istanbul.
- UNION OF SOUTH AFRICA: State Library, Pretoria, Transvaal.
- UNION OF SOVIET SOCIALIST REPUBLICS: All-Union Lenin Library, Moscow 115.
- UNITED NATIONS: Library of the United Nations, Geneva, Switzerland.
- URUGUAY: Oficina de Canje Internacional de Publicaciones, Montevideo.

¹ Suspended.² Changed from Oficina de Depósito y Canje Internacional de Publicaciones.³ Added during year.⁴ Receives two sets.

VENEZUELA: Biblioteca Nacional, Caracas.

YUGOSLAVIA: Bibliografski Institut, Belgrade.⁵ ⁶

DEPOSITORIES OF PARTIAL SETS

AFGHANISTAN: Library of the Afghan Academy, Kabul.

ANGLO-EGYPTIAN SUDAN: Gordon Memorial College, Khartoum.⁴

BOLIVIA: Biblioteca del Ministerio de Relaciones Exteriores y Culto, La Paz.

BRAZIL:

MINAS GERAIS: Directoria Geral de Estatística em Minas, Belo Horizonte.

BRITISH GUIANA: Government Secretary's Office, Georgetown, Demerara.

CANADA:

ALBERTA: Provincial Library, Edmonton.

BRITISH COLUMBIA: Provincial Library, Victoria.

NEW BRUNSWICK: Legislative Library, Fredericton.

NEWFOUNDLAND: Department of Provincial Affairs, St. John's.⁷

NOVA SCOTIA: Provincial Secretary of Nova Scotia, Halifax.

SASKATCHEWAN: Legislative Library, Regina.

DOMINICAN REPUBLIC: Biblioteca de la Universidad de Santo Domingo, Ciudad Trujillo.

ECUADOR: Biblioteca Nacional, Quito.

EL SALVADOR:

Biblioteca Nacional, San Salvador.

Ministerio de Relaciones Exteriores, San Salvador.

GREECE: National Library, Athens.

GUATEMALA: Biblioteca Nacional, Guatemala.

HAITI: Bibliothéque Nationale, Port-au-Prince.

HONDURAS:

Biblioteca y Archivo Nacionales, Tegucigalpa.

Ministerio de Relaciones Exteriores, Tegucigalpa.

ICELAND: National Library, Reykjavik.

INDIA:

BIHAR AND ORISSA: Revenue Department, Patna.

BOMBAY: Undersecretary to the Government of Bombay, General Department, Bombay.

UNITED PROVINCES OF AGRA AND OUDH:

University of Allahabad, Allahabad.

Civil Secretariat, Council House, Lucknow.

WEST BENGAL: Library, West Bengal Legislative Secretariat, Assembly House, Calcutta.

IRAN: Imperial Ministry of Education, Tehran.

IRAQ: Public Library, Baghdad.

JAMAICA: Colonial Secretary, Kingston.

University College of the West Indies, St. Andrews.

LIBERIA: Department of State, Monrovia.

MALAYA: Federal Secretariat, Federation of Malaya, Kuala Lumpur.

MALTA: Minister for the Treasury, Valleta.

NICARAGUA: Ministerio de Relaciones Exteriores, Managua.

PAKISTAN: Chief Secretary to the Government of Punjab, Lahore.

PANAMA: Ministerio de Relaciones Exteriores, Panama.

PARAGUAY: Ministerio de Relaciones Exteriores, Sección Biblioteca, Asunción.

⁴ Changed from Ministère de l'Éducation.

⁷ Changed from Department of Home Affairs.

SCOTLAND: National Library of Scotland, Edinburgh.

SIAM: National Library, Bangkok.

SINGAPORE: Chief Secretary, Government Offices, Singapore.

VATICAN CITY: Biblioteca Apostolica Vaticana, Vatican City, Italy.

INTERPARLIAMENTARY EXCHANGE OF THE OFFICIAL JOURNAL

There are now being sent abroad 85 copies of the Federal Register and 92 copies of the Congressional Record. This is an increase over the preceding year of 2 copies of the Federal Register and 5 copies of the Congressional Record. The countries to which these journals are being forwarded are given in the following list:

DEPOSITORIES OF CONGRESSIONAL RECORD AND FEDERAL REGISTER

ARGENTINA:

Biblioteca del Congreso Nacional, Buenos Aires.

Biblioteca del Poder Judicial, Mendoza.⁸

Cámara de Diputados, Oficina de Información Parlamentaria, Buenos Aires.

Boletín Oficial de la República Argentina, Ministerio de Justicia e Instrucción Pública, Buenos Aires.

AUSTRALIA:

Commonwealth Parliament and National Library, Canberra.

NEW SOUTH WALES: Library of Parliament of New South Wales, Sydney.

QUEENSLAND: Chief Secretary's Office, Brisbane.

WESTERN AUSTRALIA: Library of Parliament of Western Australia.

BRAZIL:

Biblioteca da Camera dos Deputados, Rio de Janeiro.

Secretaria de Presidencia, Rio de Janeiro.⁴ ⁹

AMAZONAS: Archivo, Biblioteca e Imprensa Publica, Manaus.

BAHIA: Governador do Estado da Bahia, São Salvador.

ESPIRITO SANTO: Presidencia do Estado do Espirito Santo, Victoria.

RIO GRANDE DO SUL: Imprensa Oficial do Estado, Porto Alegre.

SERGIPE: Biblioteca Publica do Estado de Sergipe, Aracajú.

SÃO PAULO: Imprensa Oficial do Estado, São Paulo.

BRITISH HONDURAS: Colonial Secretary, Belize.

CANADA:

Library of Parliament, Ottawa.

Clerk of the Senate, Houses of Parliament, Ottawa.

CEYLON: Ceylon Ministry of Defense and External Affairs, Colombo.⁴ ⁹

CUBA:

Biblioteca del Capitolio, Habana.

Biblioteca Publica Panamericana, Habana.⁸

House of Representatives, Habana.

CZECHOSLOVAKIA: Library of the Czechoslovak National Assembly, Prague.⁹

EGYPT: Ministry of Foreign Affairs, Egyptian Government, Cairo.⁹

EL SALVADOR: Library, National Assembly, San Salvador.

⁸ Federal Register only.

⁹ Congressional Record only.

FRANCE :

- Bibliothèque Assemblée Nationale, Paris.
- Bibliothèque Conseil de la République, Paris.
- Library, Organization for European Economic Cooperation, Paris.⁹
- Publiques de l'Institute de Droit Comparé, Université de Paris, Paris.⁸
- Research Department, Council of Europe, Strasbourg.⁹
- Service de la Documentation Étrangère, Assemblée Nationale, Paris.⁹

GERMANY: Bibliothek der Instituts für Weltwirtschaft an der Universität Kiel, Kiel-Wik.⁴

- Archiv, Deutscher Bundesrat, Bonn.⁴
- Der Bayrische Landtag, Munich.^{9, 10}
- Deutscher Bundesrat, Bonn.⁹
- Deutscher Bundestag, Bonn.⁹

GREAT BRITAIN :

- House of Commons Library, London.⁹
- Printed Library of the Foreign Office, London.
- Royal Institut of International Affairs, London.^{4, 9}

GREECE: Bibliothèque, Chambre des Députés Hellénique, Athens.

GUATEMALA: Biblioteca de la Asamblea Legislativa, Guatemala.

HAITI: Bibliothèque Nationale, Port-au-Prince.

HONDURAS: Biblioteca del Congreso Nacional, Tegucigalpa.

INDIA :

- Civil Secretariat Library, Lucknow, United Provinces.⁸
- Indian Council of World Affairs, New Delhi.⁹
- Legislative Assembly Library, Lucknow, United Provinces.
- Legislative Department, Simla.
- Parliament Library, New Delhi.⁹

INDONESIA: Provisional Parliament of East-Indonesia, Macassar, Celebes.

IRELAND: Dail Eireann, Dublin.

ITALY :

- Biblioteca Camera dei Deputati, Rome.
- Biblioteca del Senato della Repubblica, Rome.
- European Office, Food and Agriculture Organization of the United Nations, Rome.⁸
- International Institute for the Unification of Private Law, Rome.⁸

JAPAN: Library of the National Diet, Tokyo.

MEXICO :

- Dirección General Información, Secretaría de Gobernación, Mexico, D. F.
- Biblioteca Benjamin Franklin, Mexico, D. F.
- AGUASCALIENTES: Gobernador del Estado de Aguascalientes, Aguascalientes.
- CAMPECHE: Gobernador del Estado de Campeche, Campeche.
- CHIAPAS: Gobernador del Estado de Chiapas, Tuxtla Gutierrez.
- CHIHUAHUA: Gobernador del Estado de Chihuahua, Chihuahua.
- COAHUILA: Periódico Oficial del Estado de Coahuila, Palacio de Gobierno, Saltillo.
- COLIMA: Gobernador del Estado de Colima, Colima.
- DURANGO: Gobernador Constitucional del Estado de Durango, Durango.
- GUANAJUATO: Secretaría General de Gobierno del Estado, Guanajuato.
- GUERRERO: Gobernador del Estado de Guerrero, Chilpancingo.
- JALISCO: Biblioteca del Estado, Guadalajara.
- LOWER CALIFORNIA: Gobernador del Distrito Norte, Mexicali.

¹⁰ Three copies.

MEXICO—Continued

- MÉXICO: Gaceta del Gobierno, Toluca.
 MICHOACÁN: Secretaría General de Gobierno del Estado de Michoacán, Morelia.
 MORELOS: Palacio de Gobierno, Cuernavaca.
 NAYARIT: Gobernador de Nayarit, Tepic.
 NUEVO LEÓN: Biblioteca del Estado, Monterrey.
 OAXACA: Periódico Oficial, Palacia de Gobierno, Oaxaca.
 PUEBLA: Secretaría General de Gobierno, Puebla.
 QUERÉTARO: Secretaría General de Gobierno, Sección de Archivo, Querétaro.
 SAN LUIS POTOSÍ: Congreso del Estado, San Luis Potosí.
 SINALOA: Gobernador del Estado de Sinaloa, Culiacán.
 SONORA: Gobernador del Estado de Sonora, Hermosillo.
 TABASCO: Secretaría de Gobierno, Sesión 3a, Ramo de Prensa, Villahermosa.
 TAMAULIPAS: Secretaría General de Gobierno, Victoria.
 TLAXCALA: Secretaría de Gobierno del Estado, Tlaxcala.
 VERACRUZ: Gobernador del Estado de Veracruz, Departamento de Gobernación y Justicia, Jalapa.
 YUCATÁN: Gobernador del Estado de Yucatán, Mérida.
- NETHERLANDS: Koninklijke Bibliotheek, The Hague.⁸
 NEW ZEALAND: General Assembly Library, Wellington.
 NORWAY: Library of the Norwegian Parliament, Oslo.
 PAKISTAN: Punjab Legislative Assembly Department, Lahore.
 PERU: Cámara de Diputados, Lima.
 POLAND: Ministry of Justice, Warsaw.⁸
 PORTUGAL: Secretaria de Assembla Nacional, Lisbon.⁹
 SWITZERLAND: Bibliothèque, Bureau International du Travail, Geneva.⁸
 Library, United Nations, Geneva.
 International Labor Office, Geneva.¹¹
- UNION OF SOUTH AFRICA:
 CAPE OF GOOD HOPE: Library of Parliament, Cape Town.
 TRANSVAAL: State Library, Pretoria.
- UNION OF SOVIET SOCIALIST REPUBLICS: Fundamental'niia Biblioteka, Obshchestvennykh Nauk, Moscow.⁹
 URUGUAY: Diario Oficial, Calle Florida 1178, Montevideo.
 VENEZUELA: Biblioteca del Congreso, Caracas.

FOREIGN EXCHANGE AGENCIES

Exchange publications for addresses in the countries listed below are forwarded by freight to the exchange agencies of those countries. Exchange publications for addresses in other countries are forwarded directly to the addresses by mail.

LIST OF AGENCIES

- AUSTRIA: Austrian National Library, Vienna.
 BELGIUM: Service des Échanges Internationaux, Bibliothèque Royale de Belgique, Bruxelles.
 CHINA: Bureau of International Exchange, National Central Library, Nanking.²
 CZECHOSLOVAKIA: Bureau of International Exchanges, National and University Library, Prague.

¹¹ Two copies.

- DENMARK: Institut Danois des Échanges Internationaux, Bibliothèque Royale, Copenhagen K.
- EGYPT: Government Press, Publications Office, Bulaq, Cairo.
- FINLAND: Delegation of the Scientific Societies of Finland, Kasärngatan 24, Helsinki.
- FRANCE: Service des Échanges Internationaux, Bibliothèque Nationale, 58 Rue de Richelieu, Paris.
- GERMANY: Notgemeinschaft der Deutschen Wissenschaft, Bad Godesberg.
- GREAT BRITAIN AND IRELAND: Wheldon & Wesley, 83/84 Berwick Street, London, W. 1.
- HUNGARY: Hungarian Libraries Board, Ferenciektere 5, Budapest, IV.
- INDIA: Superintendent of Government Printing and Stationery, Bombay.
- INDONESIA: Department of Cultural Affairs and Education, Djakarta.
- ISRAEL: Jewish National and University Library, Jerusalem.
- ITALY: Ufficio degli Scambi Internazionali, Ministero della Pubblica Istruzione, Rome.
- JAPAN: Division of International Affairs, National Diet Library, Tokyo.
- NETHERLANDS: International Exchange Bureau of the Netherlands, Royal Library, The Hague.
- NEW SOUTH WALES: Public Library of New South Wales, Sydney.
- NEW ZEALAND: General Assembly Library, Wellington.
- NORWAY: Service Norvégien des Échanges Internationaux, Bibliothèque de l'Université Royale, Oslo.
- PHILIPPINES: Bureau of Public Libraries, Department of Education, Manila.
- POLAND: Service Polonais des Échanges Internationaux, Bibliothèque Nationale, Warsaw.
- PORTUGAL: Secção de Trocas Internacionais, Biblioteca Nacional, Lisbon.
- QUEENSLAND: Bureau of Exchanges of International Publications, Chief Secretary's Office, Brisbane.
- RUMANIA: Ministère de la Propagande Nationale, Service des Échanges Internationaux, Bucharest.³
- SOUTH AUSTRALIA: South Australian Government Exchanges Bureau, Government Printing and Stationery Office, Adelaide.
- SPAIN: Junta de Intercambio y Adquisición de Libros y Revistas para Bibliotecas Públicas, Ministerio de Educación Nacional, Avenida Calvo Sotelo 20, Madrid.
- SWEDEN: Kungliga Biblioteket, Stockholm.
- SWITZERLAND: Service Suisse des Échanges Internationaux, Bibliothèque Centrale Fédérale, Palais Fédéral, Berne. -
- TASMANIA: Secretary of the Premier, Hobart.
- TURKEY: Ministry of Education, Department of Printing and Engraving, Istanbul.
- UNION OF SOUTH AFRICA: Government Printing and Stationery Office, Cape Town, Cape of Good Hope.
- UNION OF SOVIET SOCIALIST REPUBLICS: Bureau of Book Exchange, State Lenin Library, Moscow 19.
- VICTORIA: Public Library of Victoria, Melbourne.
- WESTERN AUSTRALIA: Public Library of Western Australia, Perth.
- YUGOSLAVIA: Bibliografski Institut FNRJ, Belgrade.

Respectfully submitted.

D. G. WILLIAMS, *Chief.*

Dr. A. WETMORE,
Secretary, Smithsonian Institution.

APPENDIX 7

Report on the National Zoological Park

SIR: Transmitted herewith is a report on the operations of the National Zoological Park for the fiscal year ended June 30, 1951.

During the year 1,768 individual animals were added to the collection by gifts, deposits, purchases, exchanges, births, and hatchings. Among the accessions were many rare specimens never before shown in this Zoo. The addition of new kinds of animals enhances the value of the collection, which is maintained not only for exhibition, but for research and education, thus fostering the Smithsonian's established purpose of "the increase and diffusion of knowledge."

Valuable opportunities for research are afforded students of biology, particularly vertebrate zoology, as well as artists, photographers, and writers. Only methods of study that do not endanger the welfare of animals or the safety of the public are permitted.

Services of the staff included answering in person or by phone, mail, and telegraph questions regarding animals and their care and transportation; furnishing to other zoos and other agencies, public and private, information regarding structures for housing animals; cooperating with other agencies of Federal, State, and municipal governments in research work; and preparing articles for publication.

The stone restaurant building, which was constructed in the Park in 1940, is leased at \$23,052 a year. This money is deposited in the general fund of the United States Treasury. The concessionaire serves meals and light refreshments and sells souvenirs.

VISITORS

The estimated number of visitors was 3,460,400, an increase of 22,731 over the previous year. This was the largest attendance in the history of the Zoo and was probably due to a combination of circumstances, such as the continued high employment in the Washington area, increase in travel accompanying the general economic prosperity, and the frequency with which the Zoo was able to announce the addition of interesting specimens to the collection.

Before the war, early days of the week had relatively low attendance, with an increasing number of visitors the latter portion of the week and very large crowds on Saturdays, Sundays, and holidays. Now the variation in attendance on the different days is much less. There is also a considerable increase in attendance in the mornings.

ESTIMATED NUMBER OF VISITORS FOR FISCAL YEAR 1951

July (1950).....	452, 500	February.....	193, 600
August.....	470, 000	March.....	263, 200
September.....	290, 700	April.....	391, 300
October.....	296, 900	May.....	418, 500
November.....	156, 600	June.....	350, 700
December.....	64, 150		
January (1951).....	112, 200	Total.....	3, 460, 400

Groups came to the Zoo from schools in Canada, Cuba, Haiti, and 29 States, some as far away as Maine, Florida, Oklahoma, Kansas, and North Dakota. There was an increase of 167 groups and 13,445 individuals in groups over last year.

NUMBER OF GROUPS FROM SCHOOLS

State	Number of groups	Number in groups	State	Number of groups	Number in groups
Alabama.....	11	362	Mississippi.....	4	121
Arkansas.....	1	15	Missouri.....	1	18
Canada.....	2	116	New Jersey.....	17	1, 160
Connecticut.....	12	571	New York.....	104	5, 487
Cuba.....	4	74	North Carolina.....	195	7, 125
Delaware.....	14	613	North Dakota.....	1	42
District of Columbia.....	128	6, 680	Ohio.....	52	5, 784
Florida.....	7	634	Oklahoma.....	2	36
Georgia.....	36	4, 265	Pennsylvania.....	241	12, 993
Haiti.....	1	23	Rhode Island.....	1	182
Illinois.....	2	64	South Carolina.....	78	2, 379
Indiana.....	10	918	Tennessee.....	41	1, 699
Kansas.....	4	124	Virginia.....	512	26, 096
Kentucky.....	10	331	West Virginia.....	63	3, 556
Maine.....	6	391	Wisconsin.....	4	135
Maryland.....	541	31, 839			
Massachusetts.....	12	656	Total.....	2, 140	115, 998
Michigan.....	23	1, 515			

About 2 p. m. each day the cars then parked in the Zoo are counted by the Zoo police and listed according to the State, Territory, or country from which they came. This is, of course, not a census of the cars coming to the Zoo but is valuable in showing the percentage of attendance, by States, of people in private automobiles. Many of the District of Columbia, Maryland, and Virginia cars come to the Zoo to bring guests from other States. The tabulation for the fiscal year 1951 is as follows:

Maryland.....	Percent	25. 5	Ohio.....	Percent	1. 9
Washington, D. C.....	23. 7	West Virginia.....	1. 5		
Virginia.....	21. 5	New Jersey.....	1. 4		
Pennsylvania.....	5. 0	Florida.....	1. 0		
New York.....	2. 7	Massachusetts.....	1. 0		
North Carolina.....	2. 5	California.....	0. 8		

The cars that made up the remaining 11.5 percent came from every one of the remaining States, as well as from Alaska, Austria, Bahamas, Belgium, Canada, Canal Zone, Cuba, England, Germany, Guam, Guatemala, Hawaii, Holland, Japan, Mexico, Newfoundland, Nicaragua, Okinawa, Philippines, Puerto Rico, some of the South American Republics, and Switzerland.

THE EXHIBITS

Specimens for exhibition are acquired by gift, deposit, purchase, exchange, births, and hatchings and are removed by death, exchange, or return of those on deposit. Although depositors are at liberty to remove their specimens, many leave them permanently.

As in any colony of living things, there is a steady turn-over, and so the exhibits are constantly changing. Thus, the inventory list of specimens in the collection on June 30 of each year does not show all the kinds of animals that were exhibited during the year; sometimes creatures of outstanding interest at the time they were shown are no longer in the collection at the time the list is prepared.

The United States National Museum is given first choice of all specimens that die in the Zoo. If they are not desired for the Museum they are then made available to other scientific institutions or scientific workers. Thus, the value of the specimen continues long after it is dead.

ACCESSIONS

During the year there were 267 accessions comprising 862 individual animals received as gifts or deposits. These included an unusual number of interesting specimens.

OUTSTANDING ACQUISITIONS

There were received 38 different kinds of animals that either had never before been exhibited in this Zoo or are such rare specimens that they are outstanding additions.

One of these is the Agrimi goat, "Kri Kri" (*Capra aegagrus cretensis*), a choice male specimen of a very rare native wild goat of Crete. This was a gift to the United States Government from the Greek Government, through the Economic Cooperation Administration and the State Department.

A single specimen of toucan (*Ramphastos*), which is as yet unidentified, was received from Colombia. This bird had never been exhibited formerly in the National Zoological Park, and it is apparently rare in the wild, as well as in collections.

Seventeen specimens of the Santa Marta tinamou (*Crypturellus noctivagus idoneus*) were also received from Colombia. These were new to the Zoo collection, and they are large enough and so conspic-

uously marked as to be choice exhibits. They have hitherto been considered rare.

Specimens of the large Meller's chameleon (*Chamaeleon melleri*) were received from J. D. Handman, of Nyasaland, Africa. These are rare in collections, and their size, conspicuous coloration, and a peculiarly shaped projection on the end of the nose make them showy exhibition animals. Mr. Handman also sent such rarities as giant wingless crickets (*Enyaliopsis petersi*), quaint blesmols (*Cryptomys*), and numerous reptiles.

A splendid specimen of the black-headed python (*Aspidites melanocephalus*) of Australia was received. This is a large snake that had never before been in the Zoo collection.

The three-banded armadillos (*Tolypeutes tricinctus*) received from central South America are interesting little creatures not much larger than a good-sized grapefruit. They are the first this Zoo has ever exhibited.

A pair of the large burrowing gopherlike tuco-tuco (*Ctenomys* sp.), also from central South America, makes an interesting exhibit and the first of its kind the Zoo has had.

Six Labrador lemmings (*Dicrostonyx hudsonius*), likewise the first that have been exhibited here, were received from the Arctic Institute of North America through Dr. Graham Rowley, T. H. Manning, and Dr. A. L. Washburn.

The big black-bellied hamsters (*Cricetus cricetus*) of eastern Europe are striking contrasts to the much smaller and better-known golden hamsters that have become so popular as pets. Efforts are being made to breed these. None have previously been exhibited in the Zoo.

Three large mouselike creatures (*Mastomys coucha*), new to the collection, are particularly interesting because they are used in Africa as laboratory animals and are now being tried out in the United States for research work. They were turned over to the Zoo by the Army Medical Center.

Three specimens of the rarely found little burrowing frog (*Ceratotryps calcarata*) of Colombia were received. These, also, are new to the collection.

Other animals that, though not the first of their kind in the Zoo, are sufficiently rare or interesting to be noteworthy include a pencil-tailed tree mouse (*Chiropodomys gliroides*) from the Malay Peninsula; hairy armadillos (*Chaetophractus villosus*); least marmoset (*Callithrix pygmaea*); two of the rare and peculiar maned or crested rat (*Lophiomys imhausi*) of Africa; white-tailed Colobus monkey (*Colobus polykomos*); potto (*Perodicticus potto*); brush-tailed porcupines (*Atherurus africanus*); young mandrills (*Mandrillus sphinx*); shoebill stork (*Balaeniceps rex*); black-necked swan (*Cygnus melanocoryphus*); a king vulture (*Sarcorhamphus papa*); quetzals (*Pharo-*

machus mocino); fer-de-lance snakes (*Bothrops lanceolatus*); king cobra (*Naja hannah*); Gaboon viper (*Bitis gabonica*); Australian copperhead snake (*Denisonia superba*); the little burrowing snake (*Typhlops*) from Africa; and coconut crabs (*Birgus latro*), which were a gift to us from the Governor of Guam.

The Army Medical Center, through its various workers, has continued to turn over to the Zoo interesting animals no longer needed in their work. Through Maj. Robert Traub, of the Research and Graduate School, there was received a very fine collection of rodents from Kuala Lumpur, Malay Peninsula. There were six different species of the genus *Rattus*, which included a very small richly colored rat, and a large somber-colored one, as well as other intermediate forms. These rats are of particular interest as they are being studied in connection with human diseases. Also received through Major Traub were three species of the inconspicuously marked squirrels of the *Callosciurus* group, the long-pointed-nose Malayan ground squirrel (*Lariscus*), another of the queer little pencil-tailed tree mice (*Chiropodomys*), and three excellent specimens of the slow loris (*Nycticebus coucang*).

E. M. Blocker, of the Fresno (Calif.) Zoo, presented two California jack rabbits, which were particularly desirable additions as they have rarely been available to the National Zoo.

Dr. Gabriel Ospina Restrepo, Director of the Instituto Nacional de Antropología Social de Colombia, Bogotá, Colombia, kindly presented the Zoo with two pygmy marmosets. These are the smallest of the marmosets and, being rare in collections, are especially desirable additions.

It has been possible to acquire many of these rarities for the Zoo through the use of air transportation to bring animals quickly from their native haunts, and by maintaining contacts with persons in remote regions who are interested in collecting specimens. By a continuance of these methods it is hoped to bring to the American public more interesting creatures that have not heretofore been available for study alive.

DEPOSITORS AND DONORS AND THEIR GIFTS

(Deposits are marked *)

- Acorn Pet and Gift Shop, Washington, D. C., yellow and blue macaw.*
- Adams, E., Bethesda, Md., copperhead snake.
- Adams, T. M., Arlington, Va., ring-necked snake, 10 common newts.
- Alford, John N., Saegerton, Pa., white ring-necked pheasant.
- Alston, Gene, Washington, D. C., wood turtle, painted turtle, 2 box turtles.
- Altizer, David H., Washington, D. C., white rabbit.
- Anderson, A. William, Takoma Park, Md., rabbit.
- Animal Rescue League, Washington, D. C., 2 white king pigeons.
- Arctic Institute of North America, through Dr. Graham Rowley, T. H. Manning, and Dr. A. L. Washburn, 6 lemmings.

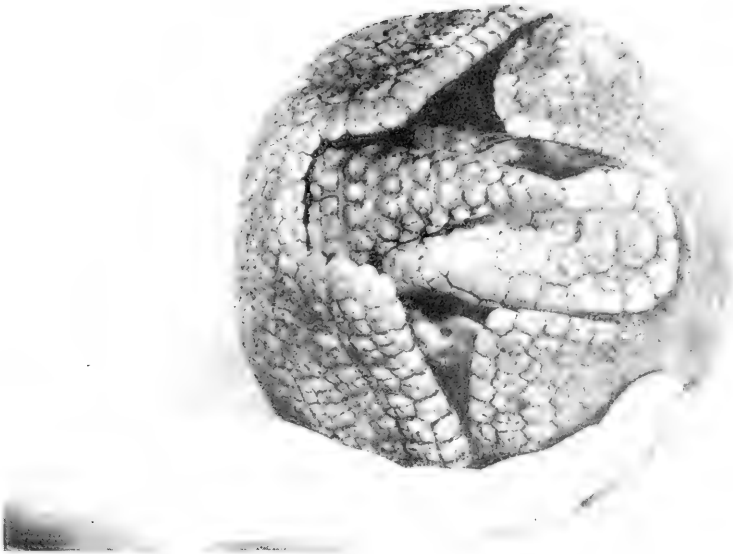

1. THREE-BANDED ARMADILLO (*TOLYPEUTES TRICINCTUS*)

Almost completely closed for protection against enemies. The large, somewhat triangular shield at the right is the top of the head, and the slightly smaller triangular member studded with tubercules is the tail. (Photograph by Ernest P. Walker.)

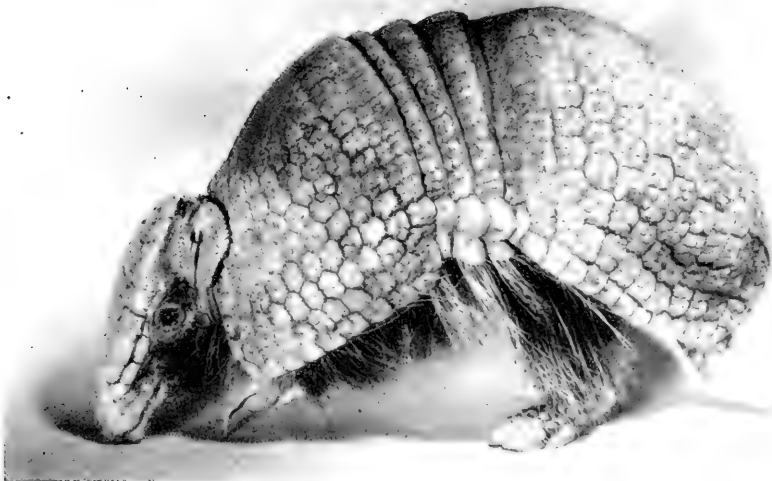

2. THREE-BANDED ARMADILLO UNROLLED, READY FOR WALKING

Most of the time it touches only the tips of the very strong claws of its front feet to the ground. (Photograph by Ernest P. Walker.)



1. MELLER'S CHAMELEON (*CHAMAELEON MELLERI*). FROM NYASALAND, AFRICA
A large chameleon with prehensile tail and a hornlike projection on the end of the snout. It can change color at will and move its eyes independently.

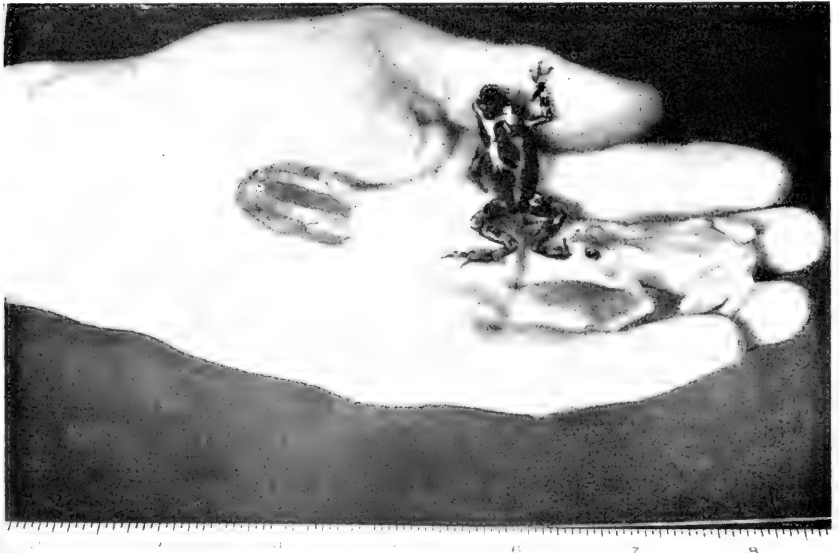

2. TINY FROGS IN THE NATIONAL ZOOLOGICAL PARK

Left, striped African tree frog (*Afrivalus fornasinii* Bianconi); center, black and green frog (*Dendrobates tintoria*) from South America, commonly known as the arrow-poison frog; right, yellow atelopus (*Atelopus varius cruciger*), a delicate translucent lemon-colored frog from the Panama region. (Photograph by Ernest P. Walker.)

DEPOSITORS AND DONORS AND THEIR GIFTS—continued

- Armstrong, Brig. Gen. Clare H., Camp Stewart, Ga., 2 Rosella parakeets.*
 Army Medical Center, Washington, D. C., 3 agoutis; through Mr. Rogers, 3 *Mastomys coucha*; through Maj. Robert Traub, Research and Graduate School, Asiatic squirrel,* large spiny-backed tree rat,* 2 Rajah tree rats,* 2 Bower's tree rats,* Whitehead's tree rat,* *Rattus canus malasia*,* *Callosciurus caniceps*,* *Callosciurus notatus*,* Malayan ground squirrel,* pencil-tailed tree rat,* pencil-tailed tree mouse,* 3 slow loris.*
- Badger, June, Middleburg, Va., and Cochran, Dr. Doris, National Museum, Washington, D. C., corn snake,* southern ribbon snake,* legless lizard,* Cumberland turtle,* false map turtle,* 2 musk turtles,* 3 Japanese newts.*
- Baird, Bill, National Park Service, Washington, D. C., 2 copperhead snakes.
- Bailey, Mrs. H. E., College Park, Md., 3 red-shouldered hawks.
- Bailey, Lee, Washington, D. C., barn owl.
- Baker, Judd O., Washington, D. C., opossum.
- Baker, Patricia, Lake Forest, Ill., ring-necked snake.
- Barfield, Gordon, Cabin John, Md., rabbit.
- Baxter, Mr., Washington, D. C., brown capuchin monkey.
- Belcher, James E., Bethesda, Md., ground hog.
- Bentz, Sgt., and Reeves, Sgt. E., Washington, D. C., loon.
- Black, Maj. E. L., Ft. McNair, Washington, D. C., horned lizard.
- Blocker, E. M., Fresno, Calif., 2 California jack rabbits.
- Boose, Mrs., Arlington, Va., opossum.
- Boyle, John, III, Washington, D. C., skunk.
- Bresman, Commander J., Rockville, Md., great horned owl.
- Brown, G. S., Silver Spring, Md., white rabbit.
- Brown, Mrs. I., Arlington, Va., Pekin duck.
- Brown, Mrs. M., Washington, D. C., 2 rabbits.
- Brown, Russell L., Washington, D. C., horseshoe crab.
- Bryant, Terrell W. W., Takoma Park, Md., 3 crows.
- Bunnell, Miss T. J., Baltimore, Md., mynah.
- Burt, Robert A., Arlington, Va., 3 opossums.
- Butler, Mrs. P. E., Fairfax, Va., opossum.
- Castle, Guy, Oxon Hill, Md., great horned owl.
- Chappelle, Susan, Washington, D. C., rabbit.
- Cherry, Zeal, Kearneysville, W. Va., 4 ring-necked pheasants.
- Clifford, Happa, Washington, D. C., blue jay.
- Colpin, Dr. H. L., Washington, D. C., red fox.
- Cox, Charles G., Jr., Spokane, Wash., hawk.
- Cross, James, Rockville, Md., pilot snake.
- Dahlgren, Daniel, New Alexandria, Va., 2 horned lizards.
- Daniel, R. O., Washington, D. C., albino opossum.
- Davis, Floyd, Washington, D. C., woodchuck.
- de Murguiondo, Victor, Jr., Washington, D. C., 2 barn owls.
- Denham, Mrs. W. L., Vienna, Va., 3 horned lizards.
- DeVore, Warren, Washington, D. C., horned lizard.
- Diggs, Mrs. Thomas I., Washington, D. C., rabbit.
- Dillion, Mrs. J. J., Washington, D. C., 2 opossums.
- Dillon, Kathleen and Mike, Washington, D. C., red hen.
- Dix, Michael, Washington, D. C., pilot black snake.
- Donallon, Mrs. H., Washington, D. C., 7 hamsters.
- Dore, Richard, Arlington, Va., Pekin duck.
- Drusback, F. W., Bethesda, Md., pilot snake.

DEPOSITORS AND DONORS AND THEIR GIFTS—continued

- Ducharme, Leon C., Washington, D. C., skunk.
- Dunlap, R. Peter, Chevy Chase, Md., and Gilpin, Kenny, Bethesda, Md., bald eagle.
- Duvall, Mrs. F., Seat Pleasant, Md., red fox.
- Edwards, J. E., Washington, D. C., 4 red foxes.
- Ehrwantrout, Edw., Takoma Park, Md., horned lizard.
- Eshenbough, P. H., Washington, D. C., Pekin duck.
- Espey, Mrs. H. Clay, Jr., Washington, D. C., snapping turtle.
- Eubank, Gerald A., Washington, D. C., 2 Pekin ducks.
- Evans, C. P., Washington, D. C., gray fox.
- Evans, James, Green Acres, Md., Pekin duck.
- Fawcett, Arthur F., Washington, D. C., corn snake.
- Fenton, John W., McLean, Va., 7 black Pekin ducks.*
- Fine, C. B., Silver Spring, Md., robin.
- Fish and Wildlife Service, U. S. Department of the Interior, through E. R. Atkinson, Tappahannock, Va., bald eagle; through Dr. Gardiner Bump, Washington, D. C., 2 southern Pacific swamp hens (gallinule); through Harvey O. Edwards, Ely, Nev., 3 western bobcats, 2 pumas; through Vernon Ekedahl, Willows, Calif., 5 cackling geese, 4 lesser snow geese, whistling swan, pintail duck, mallard duck, 4 snow geese; through Patuxent Wildlife Research Refuge, Laurel, Md., 6 pairs bobwhite quails, 2 pairs ring-necked pheasants; through Leonard Llewellyn, 6 copperhead snakes; through J. W. Wolfey, Orlando, Fla., 87 black-bellied tree ducks; Branch of Game Management, Washington, D. C., whistling swan.
- Fisher, Charlie J., Washington, D. C., alligator.
- Fisher, F. B., Washington, D. C., 2 Cumberland turtles.
- Fisher, Mrs. J., Alexandria, Va., Pekin duck.
- Foster, Mrs., Washington, D. C., white rabbit.
- Funk, David, Bethesda, Md., black-widow spider.
- Gantt, A. E., Arlington, Va., yellow-headed parrot.
- Gatti, Mrs. S. A., Washington, D. C., canary, grass parakeet, zebra finch.
- Gaver, Gordon, Thurmont, Md., 2 hog-nosed snakes, rainbow boa,* coral snake,* 2 tegu lizards,* 3 Gila monsters,* 3 timber rattlesnakes,* copperhead snake, 2 fox snakes,* corn snake,* bull snake,* king cobra,* 5 Siamese cobras,* 6 cape cobras,* cottonmouth,* Indian rock python,* regal python,* 2 boa constrictors,* Mexican water moccasin,* mangrove snake,* Gaboon viper,* Javan macaque.*
- Gebhardt, Richard J., Arlington, Va., American crow.
- Geisler, Lloyd G., Washington, D. C., horned lizard.
- Geletner, Mr., Washington, D. C., 8 canaries.
- Gillogly, C. O., Washington, D. C., false chameleon.
- Gladding, Robert, Washington, D. C., Holbrook king snake.
- Gollan, John R., Washington, D. C., Pekin duck.
- Graham, Brig. Gen. Wallace H., Washington, D. C., ariel toucan.
- Graybill, L., Cabin John, Md., 3 Pekin ducks.
- Greek Government, through Economic Cooperation Administration and State Department, Agrimi goat.
- Green, Austin R., Greenbelt, Md., snowy owl.
- Greeson, E. L., Arlington, Va., 3 golden-mantled ground squirrels.
- Griffin, Mr. and Mrs. Roy D., Silver Spring, Md., rabbit.
- Guffy, Pat, Washington, D. C., box turtle.
- Hamlet, John N., Pritchardville, S. C., king vulture,* 2 hairy armadillos.*

DEPOSITORS AND DONORS AND THEIR GIFTS—continued

- Handman, J. D., Nyasaland, Africa, hinged-back tortoise, puff adder, giant wingless crickets, Meller's chameleon, blesmols.
- Hanson, Chas., Alexandria, Va., chain king snake.
- Harris, Mrs. E. C., Falls Church, Va., black-widow spider.
- Harris, Frank H. E., Washington, D. C., squirrel monkey.
- Harris, L., Jr., Washington, D. C., great horned owl.*
- Harris, Lester E., Jr., Takoma Park, Md., 4 timber rattlesnakes.
- Harris, Mrs. L. H., Washington, D. C., 2 starlings.
- Hathaway, H. F., Silver Spring, Md., 110 hamsters.
- Hechler, Mrs. Carrie, West Reading, Pa., yellow-naped parrot.
- Henderson, R. S., Jr., Washington, D. C., 4 chipmunks.
- Higgins, Emily, Kensington, Md., Pekin duck.
- Hill, C. C., Bethesda, Md., 2 horned lizards.
- Hope, A. R., Washington, D. C., rabbit.
- Hopkins, P., Washington, D. C., 8 alligators, 2 Cumberland turtles.
- Hopwood, Thomas, McLean, Va., 3 horned lizards.
- Howe, E. H., Falls Church, Va., raccoon.
- Hoyer, Mrs. Edgar, Kensington, Md., 2 raccoons.
- Humbert, Roy, Eustis, Fla., 4 giant anolis, 6 anolis (sp.).
- Humphries, Roy, Covington, Va., 2 black racers,* 2 milk snakes,* 2 corn snakes,* 6 timber rattlesnakes,* corn snake, 6 water snakes, 3 garter snakes.
- Iilff, R. G., Dunn Loring, Va., hog-nosed snake.
- Infantile Paralysis Foundation, through John N. Hamlet, Javan macaque.
- Ingham, Rex, Ruffin, N. C., mangabey,* agouti,* palm civet,* magpie,* green macaw,* blue-fronted parrot,* 3 zebra finches,* 2 cacomistles.*
- Jellison, Dr. W., Federal Security Agency, Hamilton, Mont., rubber boa, western bull snake.
- Jenches, Mr. and Mrs. E. K., Washington, D. C., diamondback turtle.
- Jenkins, Jimmie, Arlington, Va., garter snake.
- Jenkins, Murdock, Washington, D. C., bull frog.
- Jessup, G. L., Washington, D. C., 2 pilot snakes.
- Johns Hopkins School of Hygiene and Public Health, Baltimore, Md., through Dr. A. Howe, 7 chimpanzees.*
- Johnson, Mr. and Mrs. C. R., Washington, D. C., horned lizard.
- Johnson, J. R., Washington, D. C., bald eagle.
- Johnston, Mrs. Morgan, Washington, D. C., mockingbird.
- Jolley, Edward M., Rockville, Md., pilot snake, rattlesnake, black snake, pilot black snake, 2 gray foxes, copperhead snake.
- Jones, Mrs. C., Washington, D. C., Pekin duck.
- Jones, W. J., Washington, D. C., rabbit.
- Kane, Lorraine, Kensington, Md., Pekin duck.
- Kidwell, Guss, David Taylor Model Basin, Carderock, Md., copperhead snake.
- Kinstler, Wm. A., Baltimore, Md., 2 alligators, 2 snapping turtles.
- Kremkau, Omer G., Bethesda, Md., black snake.
- Lachey, Harry T., Brookmont, Md., skunk, Pekin duck.
- Langford, Steven, Washington, D. C., musk turtle, 4 hamsters.
- Law, Charles E., Alexandria, Va., worm snake.
- Lease, A. W., Arlington, Va., 2 raccoons.
- Leebrick, Frank, Washington, D. C., opossum.
- Leigh, J. F., Washington, D. C., rabbit.
- Lewis, Lt. Garner L., Medical Corps, U. S. Navy, 7 hamsters.
- Liebert, John G., Bethesda, Md., rabbit.

DEPOSITORS AND DONORS AND THEIR GIFTS—continued

- Locke, R. L., Jr., Washington, D. C., horned lizard.
 Lomax, E. G., Falls Church, Va., 4 Pekin ducks.
 Lumpkin, H. H., Annapolis, Md., killdeer.
 Lynch, Phillips L., Falls Church, Va., 2 Pekin ducks.
 Marfield, W. T., Arlington, Va., 16 hamsters.
 Marshall, Otis, Washington, D. C., 2 rabbits.
 McCary, Mrs., Washington, D. C., 2 gray squirrels.
 McDonald, James, Washington, D. C., box turtle.
 McInnes, J. S., Raleigh, N. C., 4 Canada geese.
 McKlan, F. E., Bethesda, Md., copperhead snake.
 Middlekauff, A. I., Washington, D. C., 2 gray squirrels.
 Miller, Kenneth, Wheaton, Md., brown water snake.
 Miller, Ronnie and Kennie, Silver Spring, Md., Ford, Bobbie and Jackie, and Caserta, Mario and Benito, Wheaton, Md., hog-nosed snake, Blanding's turtle.
 Millingham, Elaine, Arlington, Va., eastern skunk.
 Milne, Robbie, and Beeman, Deane, Bethesda, Md., box turtle, snapping turtle.
 Monahan, J. P., Falls Church, Va., mourning dove.
 Montminy, Clarence, Washington, D. C., great horned owl.
 Morris, D. H., Washington, D. C., opossum and 10 babies.
 Morrison, Mrs. R., Westmoreland Hills, D. C., Pekin duck.
 Mount, William, Indianhead, Md., marbled salamander.
 National Capital Parks, through Evan A. Haynes and Robert Shepherd, Washington, D. C., black-crowned night heron.
 National Park Service, through A. E. Demaray, Director, and Edmund B. Rogers, Yellowstone National Park, American elk; through Arthur Fawcett, Luray, Va., copperhead snake.
 Nebel, John, B., Silver Spring, Md., barred owl.
 Neves, Zeuxis Ferreiro, Brazilian Embassy, Washington, D. C., copperhead snake.
 Newcomb, Mr. and Mrs. O., Arlington, Va., 2 opossums.
 New York Zoological Society, New York, N. Y., Australian tiger snake, Australian red-bellied black snake, Australian copperhead snake; through Brayton Eddy, 6 fer-de-lance snakes.
 Orr, Mrs. O. C., Washington, D. C., Pekin duck.
 O'Shea, Chad, and Easter, William, Alexandria, Va., chicken snake.
 Page, John C., Washington, D. C., tarantula.
 Paricer, A., Washington, D. C., 2 Pekin ducks.
 Park Police, D. C., Washington, D. C., Pekin duck.
 Paulling, John M., Falls Church, Va., brown capuchin.
 Peeles, Mrs. Tyrus, Hyattsville, Md., red fox.
 Perkins, F. S., Compton, Md., black snake.
 Peruvian Embassy, Washington, D. C., barred owl.
 Philadelphia Zoological Society, 2 rococo toads.
 Pindell, Charles, Washington, D. C., 2 hamsters.
 Porter, C. B., Washington, D. C., skunk.
 Prescott, John W., Washington, D. C., woodcock.
 Preston, John H., Mt. Pleasant, Pa., 3 cross foxes.
 Privo, Marcel, Alexandria, Va., king snake.
 Pullin, William A., Washington, D. C., raccoon.
 Raditick, D., Washington, D. C., copperhead snake, 3 green snakes, 2 ring-necked snakes, water snake, garter snake.

DEPOSITORS AND DONORS AND THEIR GIFTS—continued

- Rageot, Roger, Washington, D. C., eastern weasel,* flying squirrel,* 2 woodpeckers.
- Randel, Capt. Hugh, Panama, C. Z., yellow atelopus.
- Rasser, John, Colmar Manor, Md., green snake.
- Restrepo, Dr. Gabriel Ospina, Director, Instituto Nacional de Antropología Social de Colombia, Bogotá, Colombia, 2 pygmy marmosets.
- Rhodericks, R. M., Washington, D. C., rabbit.
- Richardson, Robert, Alexandria, Va., 2 Pekin ducks.
- Ringgold, Robert, Seat Pleasant, Md., red fox.
- Robert, Mrs. Evie, Washington, D. C., 2 leopard cubs.*
- Rohrbaugh, A. B., Chevy Chase, Md., sparrow hawk.
- Schnegg, Paul, Barranquilla, Colombia, 2 black-bellied tree ducks, 2 coral snakes, 2 capybaras.
- Schultz, Theodore A., Washington, D. C., 2 copperhead snakes.
- Seegers, Scott, McLean, Va., blue jay.*
- Seward, Miss M. W., Arlington, Va., 2 Pekin ducks.
- Shadle, Cebert A., McLean, Va., barred owl.
- Shaw, Mrs. R. F., Arlington, Va., Chinese mantis.
- Sherier, James, Alexandria, Va., 7 horned lizards.
- Sherwood Elementary School (children of), through Mrs. Mary R. Heffner and Mrs. Millet Genetti, Sandy Springs, Md., 4 cottontail rabbits.
- Shoemaker, Lula, Alexandria, Va., screech owl.
- Skinner, Carlton, Governor of Guam, 7 coconut crabs.
- Smith, Thomas, Middleburg, Va., rhesus monkey.
- Smith, Wm., Silver Spring, Md., Pekin duck.
- Solman, Mary Louise and Spike, Beltsville, Md., rabbit.
- Sparks, Pete, Washington, D. C., banded krait,* 2 Russell's vipers,* 2 spectacled cobras.*
- Sparks, Mrs. Richard, Alexandria, Va., chipmunk.
- Stearn, Larry, Bethesda, Md., Pekin duck.
- Stephenson, Kathy, Washington, D. C., Pekin duck.
- Stone, Sue and Sally, Arlington, Va., horned lizard.
- Stoop, Frances, Washington, D. C., flying squirrel.
- Straight, David and Michael, Alexandria, Va., garter snake.
- Stripe, Mrs. Carol, Bethesda, Md., gray squirrel.
- Suter, Courtney, Washington, D. C., horned lizard.
- Sutherland, A. L., Jr., Arlington, Va., DeKay's snake.
- Terrell, Marlynn M., Washington, D. C., Pekin duck.
- Thomas, Mrs. J. W., College Park, Md., flying squirrel.
- Thorne, Mrs. E. N., Fullerton, Md., white-throated capuchin.
- Tingley, F. S., Washington, D. C., white rabbit.
- Trans-Lux Theater, Washington, D. C., 2 lion cubs.*
- Troolnick, Mrs. Doris, Burke, Va., pilot black snake, garter snake.
- Turner, Robert, Charlotte, N. C., great horned owl.
- Turner, S. M., Washington, D. C., turtle.
- Vann, Nina, Olney, Md., skunk.
- Warfield, Miss, Washington, D. C., 2 horned lizards.*
- Warren, C. W., Fairfax, Va., raccoon.
- Washington, Bufford S., Washington, D. C., 40 golden hamsters.
- Webb, J. B., Bethesda, Md., 2 white rabbits.
- Weber, R. C., Arlington, Va., red-bellied turtle.

DEPOSITORS AND DONORS AND THEIR GIFTS—continued

Weeks, Ben T., Booneville, Miss., 2 rat snakes.
 Wilkie, D., Arlington, Va., white rabbit.
 Williams, Frank, Washington, D. C., South American opossum.
 Williams, Robert, Jr., Washington, D. C., 3 guinea pigs.
 Wilson, J. A., Washington, D. C., 2 barred owls.
 Wolski, Jos. H., Detroit, Mich., Massasauga rattlesnake, 8 fox snakes.
 Wright, Mrs. Marion, Washington, D. C., Pekin duck.
 Wyatt, Walrer, Washington, D. C., canary, 2 canary-siskin hybrids.
 Young, Mrs. Lottie, Silver Spring, Md., 50 guinea pigs.
 Zimmerman, Mrs. Dorothy, Arlington, Va., red fox.

BIRTHS AND HATCHINGS

MAMMALS			
Scientific name	Common name		Number
<i>Ammotragus lervia</i> -----	Aoudad-----		6
<i>Aeteles geoffroyi vellerosus</i> -----	Spider monkey-----		1
<i>Bos taurus</i> -----	British park cattle-----		5
<i>Bubalus bubalis</i> -----	Water buffalo-----		1
<i>Camelus bactrianus</i> -----	Bactrian camel-----		1
<i>Canis latrans</i> -----	Coyote-----		1
<i>Cercopithecus aethiops sabaeus</i> × <i>C.</i> <i>a. pygerythrus</i> .	Hybrid green guenon × vervet guenon.		1
<i>Cervus nippon</i> -----	Japanese deer-----		3
<i>Choeropsis liberiensis</i> -----	Pygmy hippopotamus-----		2
<i>Cryptomys lugardi</i> -----	Blesmol-----		4
<i>Cuniculus paca</i> -----	Paca-----		3
<i>Dama dama</i> -----	{ Brown fallow deer-----		3
		{ White fallow deer-----	4
<i>Erythrocebus patas</i> -----	Patas monkey-----		1
<i>Felis leo</i> -----	Lion-----		5
<i>Giraffa camelopardalis</i> -----	Nubian giraffe-----		2
<i>Hydropotes inermis</i> -----	Chinese water deer-----		2
<i>Lama glama guanicoe</i> -----	Guanaco-----		1
<i>Lama pacos</i> -----	Alpaca-----		1
<i>Leontocebus rosalia</i> -----	Golden, or lion-headed, marmoset.		2
<i>Odocoileus virginianus</i> -----	Virginia deer-----		4
<i>Otocyon megalotis</i> -----	Big-eared fox-----		2
<i>Papio hamadryas</i> -----	Hamadryas baboon-----		1
<i>Thalartos maritimus</i> × <i>Ursus</i> <i>middendorffi</i> .	Hybrid bear-----		5
<i>Vulpes fulva</i> -----	Silver fox-----		1
BIRDS			
<i>Anas platyrhynchos</i> -----	Mallard duck-----		22
<i>Anas platyrhynchos</i> × <i>A. p. domestica</i> -----	Hybrid mallard-Pekin-----		2
<i>Branta canadensis</i> -----	Canada goose-----		6
<i>Chenopsis atrata</i> -----	Black swan-----		2
<i>Gallus gallus</i> -----	Red junglefowl-----		2
<i>Nycticorax nycticorax hoactli</i> -----	Black-crowned night heron-----		16
<i>Pavo cristatus</i> -----	Peafowl-----		2
<i>Taeniopygia castanotis</i> -----	Zebra finch-----		2
<i>Tigrisoma lineatum</i> -----	Tiger bittern-----		3

REPTILES

Scientific name	Common name	Number
<i>Agkistrodon mokeson</i>	Copperhead snake.....	10
<i>Agkistrodon piscivorus</i>	Cottonmouth moccasin.....	1
<i>Bitis arietans</i>	Puff adder.....	33
<i>Constrictor constrictor</i>	Boa constrictor.....	54

It is particularly gratifying that the original pair of big-eared foxes (*Otocyon megalotis*) produced their second litter and raised them successfully, and that three young were hatched from the eggs laid by the original pair of tiger bitterns (*Tigrisoma lineatum*).

STATUS OF THE COLLECTION

Class	Species or subspecies	Individuals	Class	Species or subspecies	Individuals
Mammals.....	233	724	Insects.....	2	103
Birds.....	332	1,160	Mollusks.....	2	11
Reptiles.....	119	529			
Amphibians.....	21	101	Total.....	730	2,813
Fish.....	21	185			

SUMMARY

Animals on hand July 1, 1950.....	2,821
Accessions during the year.....	1,768
Total number of animals in collection during the year.....	4,589
Removals for various reasons such as death, exchanges, return of animals on deposit, etc.....	1,776
In collection on June 30, 1951.....	2,813

MAINTENANCE AND IMPROVEMENTS

In July 1950 a portion of the arched acoustical block ceiling in the large-mammal house fell. The building was immediately closed to the public, and the Public Buildings Administration was requested to make a study of the condition to determine the extent of the necessary repairs and how best to do them. On their advice a deficiency appropriation of \$63,000 was obtained, and the work of repairing the entire ceiling was undertaken under a contract handled by the Public Buildings Administration. Most of the work was completed by June 30, 1951.

Progress was made during the year in repairing and improving buildings, cages, roads, and walks. New bear cages were built in the line above the reptile house; 2,000 linear feet of 7-foot fence around four deer and mountain-sheep paddocks were replaced; the steel frame of the silver-gull cage was repaired and painted, and the cage was re-covered with new wire fabric; the wolf and fox cages were extensively repaired; a new shelter house was constructed for the wild hog;

a 6-foot concrete sidewalk, 600 feet in length, was constructed along the base of lion-house hill between the mechanical shops and the cross roads; 7,800 square feet of bituminous surfacing was laid between walks and roads to prevent erosion; 900 linear feet of cement copings for roads and walks were constructed; electric hot-water heaters were installed in the small-mammal house, reptile house, monkey house, lion house, mechanical shops and Director's office to provide hot water at locations where it had not previously been available; the wooden park benches were extensively repaired and painted; 60 table tops and legs, 12 bench legs with arms, and 24 table tops were cast of concrete; and a new waterproof electric cable with lamps was installed in the underground steam conduit from the central heating plant to the large-mammal house.

NEEDS OF THE ZOO

Replacement of antiquated structures that have long since ceased to be suitable for the purposes for which they are used is still the principle need of the Zoo. The more urgently needed buildings are: (1) A new administration building to replace the 146-year-old historic landmark which is now in use as an office building for the Zoo but which is neither suitably located nor well adapted for the purpose; (2) a new building to house antelopes and other medium-sized hoofed animals that require a heated building; and (3) a fireproof service building for receiving shipments of animals, quarantining animals, caring for animals in ill health or those that cannot be placed on exhibition.

Respectfully submitted.

W. M. MANN, *Director.*

Dr. A. WETMORE,
Secretary, Smithsonian Institution.

APPENDIX 8

Report on the Astrophysical Observatory

SIR: I have the honor to submit the following report on the operations of the Astrophysical Observatory for the fiscal year ended June 30, 1951:

The two divisions of the Astrophysical Observatory, the division of astrophysical research engaged in the study of solar radiation and the division of radiation and organisms concerned with radiation effects on organisms, report improvement in instrumentation and in results obtained.

Dr. R. B. Withrow, chief of the division of radiation and organisms, with a staff of six research men, has augmented the program outlined in last year's report to include a new biochemical investigation of photomorphogenesis in green plants, under contract with the Atomic Energy Commission.

Dr. Withrow's division occupies offices in the tower of the Smithsonian building, with laboratories in the west end of the basement. The laboratories, recently completely reconditioned, form an excellent setting for the specialized work of the division.

The division of astrophysical research and part of the shop facilities occupy a group of small structures just south of the Smithsonian Building. These buildings were this year sheathed in asbestos shingles, not only to improve their appearance but also to make them warmer in winter and cooler in summer.

On February 24 and 25, 1951, the Director attended a conference at the American Academy of Arts and Sciences, Boston, on "The Sun in the Service of Man." The stimulating program and discussions emphasized one fact—that man must learn to make better use of the energy received daily from the sun if he is to avoid hunger and discomfort in the not too distant future. Sixty years ago this fact was uppermost in the mind of Samuel P. Langley when he founded the Astrophysical Observatory.

DIVISION OF ASTROPHYSICAL RESEARCH

Two high-altitude field stations for solar observations—at Montezuma, Chile, and Table Mountain, Calif.—have continued in operation throughout the year. Reestablishment of a third station was still uncertain at the close of the fiscal year, inasmuch as the requested

funds had not been provided. Clark Mountain, near the Nevada border in southern California, a region whose annual precipitation averages about 3 inches, has been chosen as the best available location in North America for this proposed station.

W. H. Hoover, chief of the division, conducted special studies at the Table Mountain station during October and November 1950. He returned to the station at the close of the fiscal year to continue these studies.

Dr. W. E. Forsythe, of Cleveland, Ohio, who during the past 2½ years has prepared the ninth revised edition of the Smithsonian Physical Tables, submitted his completed manuscript on June 1, 1951.

Work in Washington.—As in previous years, the monthly solar-constant records from the two field stations have been checked, computed when necessary, and final corrections applied.

Four reports have been submitted to the Office of the Quartermaster General summarizing the radiation observations made at Montezuma, Chile, during the year. These observations, a part of the textile-exposure work under contract with the Quartermaster Department and referred to in previous reports, were completed May 10. The Quartermaster Department has indicated a desire to start a new series of studies at Montezuma and also at the proposed Clark Mountain station.

Some years ago the Observatory developed an instrument, called the melikeron, to measure outgoing radiation from the earth to space. Several of these instruments have been used with fair success by the United States Weather Bureau and others, and it has been the hope to improve the melikeron and make it a more sensitive recording instrument. Inasmuch as the Meteorological Division, Chemical Corps, Camp Detrick, Md., is interested in the same general problem, it was arranged to work cooperatively. At the close of the year a new instrument was being assembled and undergoing preliminary tests and calibration at Camp Detrick.

During the year two silver-disk pyrheliometers were built, calibrated, and sold at cost as follows:

S. I. No. 83 to the Government of Israel, Jerusalem.

S. I. No. 85 to the Air Force, Cambridge Research Laboratories, Cambridge, Mass.

A third pyrheliometer was lent to the Radiological Defense Laboratory, San Francisco, Calif., and three new orders were received. It is a satisfaction to note the continued demand for Smithsonian pyrheliometers. Since Dr. Abbot designed the silver-disk instrument 40 years ago, over 100 have been built. Eighty-four have been sold to interested institutions: 34 are in various parts of Europe, 19 in North America, 10 in South America, 14 in Asia and Australia, and 7 in Africa. In

consequence the Smithsonian standard scale of radiation has been made available throughout the whole world.

Dr. Abbot, research associate since his retirement from administrative work, continues his special studies, and Dr. Henryk Arcetowski continues his researches concerning solar and terrestrial atmospheres.

Work in the field.—Last year's report mentioned the new concrete observing tunnel on Table Mountain, Calif., about 100 feet west of the old tunnel, in which the spectrobolometric equipment formerly used at Tyrone, N. Mex., had been set up. This gave duplicate equipment in the two tunnels, and at the beginning of the year a series of simultaneous observations was in progress, observing through identical skies. The series continued for 40 observing days, including 8 long-method days. Detailed comparisons of the observations showed satisfactory agreement. One unexpected difference persisted through the observations, namely, the ratio of the galvanometer deflections for successive wavelengths changed progressively through the spectrum. The ratio $\frac{\text{old tunnel deflection}}{\text{new tunnel deflection}}$ started at about 1.150 in the violet end and decreased to 0.960 in the red end. These differences in deflections are compensated for by the transmission factors, which are regularly determined for each individual spectrobolometer and the deflections altered accordingly.

Following this series of observations, the stellite mirrors in the new tunnel were replaced by aluminized mirrors. As expected, this materially increased the deflections in the new tunnel—a gain of twofold in the red end and approximately fivefold in the violet end. A second series of simultaneous observations, one tunnel with stellite mirrors and the other with aluminized, is now in progress.

Mr. Hoover took with him to Table Mountain a specially built double spectroscope with rock-salt prisms, designed to measure the ozone absorption in the infrared, between 9 and 10 microns wavelength. This was mounted and tested in the new tunnel.

A new and important project has developed at Table Mountain, resulting from a paper published in 1931 by Dr. Oliver R. Wulf, of the United States Weather Bureau and the California Institute of Technology, on the determination of ozone by spectrobolometric measurements (Smithsonian Misc. Coll., vol. 85, No. 9). Dr. Wulf has long felt that a method could be developed for daily measurement of the quantity of ozone in the upper atmosphere from the Smithsonian solar-constant records. He bases his method on the relatively weak Chappuis absorption bands in the yellow-orange region of the visible spectrum. Dr. Wulf fortunately was able to spend some days on Table Mountain, working on the details of his method. On February 1, 1951, the Table Mountain staff started the required daily measurements. Preliminary results look promising, and the method will be

strengthened as more data accumulate. It is hoped that a daily determination from our bolographs of the quantity of ozone in the upper atmosphere may become a regular part of our records at the Table Mountain station.

DIVISION OF RADIATION AND ORGANISMS

(Report prepared by R. B. WITHROW)

During the past 2 years the division of radiation and organisms has been setting up specialized equipment and facilities for an investigation of the plant photochemical reactions involving photomorphogenesis, which is a light reaction controlling the growth and development of higher plants, and photoperiodism which is another light reaction controlling the flowering of many higher plants. Wavelengths in the red end of the spectrum from about 600 to 700 $m\mu$ are the most effective in producing these responses.

The first experimentation has involved photomorphogenesis as it pertains to the effect of red light on leaf expansion and pigment formation in seedlings of bean and corn. In the dark, a young bean seedling develops with a sharp bend just below the bud, called a plumular hook, and the leaves fail to develop beyond a very immature stage. With very low intensities of red light, leaf expansion occurs quite rapidly, nodes develop from the bud, and the plant form approaches normal. Heretofore, with such developmental reactions there has always been associated other photochemical reactions as chlorophyll synthesis and photosynthesis.

Since the elucidation of the biochemistry of photomorphogenesis is greatly complicated by the simultaneous occurrence of other light-controlled reactions, an attempt has been made to induce photomorphogenesis independently of other light processes. Special dyed gelatin light filters have been prepared which have a sharp cut-off at about 730 $m\mu$, so that they transmit only wavelengths longer than the cut-off, but strongly absorb the shorter wavelengths. In bean it has been found possible to cause almost complete development of leaves and the first few internodes without any measurable synthesis of chlorophyll; thus photomorphogenesis has been excited with only the most minute traces of chlorophyll synthesis, no photosynthesis, and no phototropic reaction. From this it is evident that the photomorphogenic reaction has an action spectrum that goes a little farther into the infrared than that of the other photochemical reactions.

By using the 436 $m\mu$ line from a mercury arc isolated with a blue filter, it has been possible to produce bean plants in which the leaf development occurred to a very small degree, but yet considerable chlorophyll synthesis took place. The blue-treated plants had roughly 10,000 times as much chlorophyll as the 730- $m\mu$ -treated

plants. It is thus concluded that protochlorophyll and chlorophyll as photoactivating pigments are probably not associated with photomorphogenesis and that some other pigment must be present which is causing this reaction.

Pigment analysis showed that the corn and bean plants treated with radiation in the range from 730 to about 1,000 $m\mu$ developed from 50 to 100 percent more protochlorophyll, carotenoids, and, in the case of bean, anthocyanin pigments per unit of fresh tissue than those kept in the dark. On a per-plant basis, the increase varied from 200 to 300 percent depending upon temperature and intensity.

Higher plants can grow "normally," the normal being considered the growth form of a sunlight-grown plant, when a balanced spectrum involving the proper proportions of blue and red radiation are present. At moderate intensities of blue light, where there is sufficient photosynthesis, growth is rather poor with most higher plants, and the plants appear short and stunted. In red light of the same energy, growth is rapid but the plants are tall and weak-stemmed. Since the alga *Chlorella pyrenoidosa* is a standard test object that has been studied in relation to photosynthesis and can be grown rapidly and reproductively under precisely controlled conditions, it was considered desirable to test whether growth of *Chlorella* is dependent upon the red-light reaction necessary for the growth of higher plants. *Chlorella* cultures were grown under blue radiation from a mercury lamp isolated at 435.8 $m\mu$, and the red cultures were grown in an incandescent band from 635 to 670 $m\mu$. Results thus far indicate that *Chlorella* is not dependent upon the same photomorphogenic red-light reactions as the higher plants, since growth in the blue-treated cultures is similar to that in the red-treated cultures when equal quantum energies are used. However, there is evidence that the blue cultures contain more chlorophyll. Thus growth with *Chlorella* appears to be dependent entirely upon the rate of supply of the products of photosynthesis. The other photochemical reactions do not appear to be limiting as in higher plants.

Gas-exchange studies made in a Warburg manometric apparatus have indicated that in *Chlorella* there is no detectable increase in respiration rate with radiation of wavelengths beyond 730 $m\mu$ and there is, likewise, no photosynthesis. Thus these radiations that produce such marked growth reactions in higher plants produce no measurable reactions in *Chlorella*.

A second phase of the research has dealt with the effect of growth regulators on salt uptake and water exchange by plants. The particular reference plant used was black valentine bean and the growth regulator was ammonium 2,4-dichlorophenoxyacetate acid. The uptake of salts was measured continuously by a recording electronic

conductance bridge especially designed for the purpose. Absorption of various nitrates, chlorides, and sulfates of potassium, calcium, and magnesium was studied. The results indicate that there is a marked reduction in salt uptake when the plants are treated with $\text{NH}_4\text{-2,4-D}$ and that this reduction is concomitant with a reduction in growth and does not precede it. With all salts except potassium and calcium nitrates, the reduced uptake does not appear until 24 to 48 hours after application of the regulator. In the case of potassium and calcium nitrate the effect begins within the first 24 hours.

It was also found that water absorption was markedly reduced when either the bud or primary leaf of bean was treated with $\text{NH}_4\text{-2,4-D}$, the greater reduction occurring when the leaf was treated. The reduction was not related to an effect on a root mechanism since it occurred on excised shoots to the same magnitude as in whole plants. A rapid weighing technic showed that the loss of water from the plant treated with $\text{NH}_4\text{-2,4-D}$ was considerably less than for plants not so treated, indicating that transpiration is greatly reduced by treatment with 2,4-D.

During the year a contract was assigned to the division by the Atomic Energy Commission to study the effect of radiation on the growth and development of plants. A contract renewal was awarded by the Biological Department, Chemical Corps, Camp Detrick, Md., to continue physiological studies of the effect of growth regulators on plants.

Respectfully submitted.

L. B. ALDRICH, *Director.*

Dr. A. WETMORE,

Secretary, Smithsonian Institution.

APPENDIX 9

Report on the National Air Museum

SIR: I have the honor to submit the following report on the activities of the National Air Museum for the fiscal year ended June 30, 1951:

HIGHLIGHTS

Because of the tense international situation this year the National Air Museum encountered difficult obstacles in the conduct of its operations. As the program progressed, rumor of the reuse of war plants became fact, and before the close of the year the Air Museum was ordered to vacate its storage facility at Park Ridge, Ill., to make way for aircraft manufacture. Despite such deterrent factors, however, all normal functions of the bureau were carried on, including the maintenance of the exhibited collections in Washington, the operation of the storage facility near Chicago, the survey for aeronautical museum material, and the conducting of the bureau's informational services.

Although new material added to the aeronautical collections was less in quantity than usual, the quality equaled that received in former years. Foremost on the list of 99 objects received was the Bell X-1 supersonic airplane, considered by many to be the greatest forward step in aeronautics since the Wright Brothers' invention of the *Kitty Hawk*. The acquisition of this important addition to the aeronautical collections and notes of other worthwhile items received are further described under the heading "Accessions and Events."

ADVISORY BOARD

This year one meeting of the Advisory Board of the National Air Museum was held, on June 28, 1951, called primarily to consider the problem of the required removal of the Air Museum's collections stored in the former Douglas bomber manufacturing plant, Park Ridge, Ill. The Board formally reaffirmed its belief in the great historical and technical value of the collections and directed that all possible care be taken to effect the preservation of the aircraft and other components of the collections. In this connection, the wholehearted cooperation of the Departments of the Navy and Air Force was assured.

Changes in the composition of the Advisory Board were announced as follows: Lt. Gen. K. B. Wolfe, United States Air Force, on retiring from active duty was succeeded by Maj. Gen. Donald L. Putt, United States Air Force. Rear Adm. A. M. Pride, Bureau of Aeronautics, Department of the Navy, upon assignment away from Washington was succeeded by Rear Adm. Thomas S. Combs.

STEPHENSON BEQUEST

Public Law 722, by which the National Air Museum was established August 12, 1946, authorized the Smithsonian Institution to accept as a gift from George H. Stephenson, of Philadelphia, Pa., an appropriate statue of Brig. Gen. William Mitchell. Mr. Stephenson died on July 17, 1949, leaving a bequest of \$15,000 to the Smithsonian for the proposed memorial. This has been accepted following a feasible interpretation of the bequest under agreement between the Smithsonian and the executors of the Stephenson Estate, with approval of the Orphan's Court of Philadelphia County. Toward the close of this fiscal year, the bequest was received, and plans for the memorial were initiated.

CURATORIAL ACTIVITIES

The curator, Paul E. Garber, reports on the year's work as follows: In an effort to alleviate the crowded condition of the aeronautical displays, provide space for the bureau's laboratory and shop, and permit the exhibition of some of the new and timely accessions, many exhibits were moved and rearranged this year. In addition, several important items in the collections were removed from exhibition and carefully stored.

Since its organization, the workshop facilities of the bureau had been contained in small rooms in two buildings. Operations were hampered, and it was decided to convert a portion of the exhibition area in the Aircraft Building into a single laboratory. Some of the exhibition space lost by this transaction was regained by the construction of display cases recessed into the exterior walls of the new shop, and the condition of the bureau's reference files and library was improved by extending these units into one of the old shops. Another major readjustment was the concentration of all aircraft engines in "engine row" along the north side of the Aircraft Building. The engines have been chronologically arranged and provided with improved exhibition stands, better labeling, and a protective railing. This concentration provided floor space for the display of a portion of a full-sized fuselage of a current United States Air Force fighter, the Republic F-84 thunderjet, a type now in service in Korea.

The installation of the Bell supersonic X-1 was a major project. Unlike aircraft generally, the X-1 was built as an integral structure without the usual attachments and fittings that permit assembly or disassembly. As its size did not permit its movement into the museum's exhibition hall through existing entrances, a 30-foot length of wall was removed from the side of the Aircraft Building to allow the X-1 to be placed inside the building. In this undertaking the bureau had the cooperation of United States Air Force personnel and equipment and of the Bell Aircraft Corp.

Two of the full-sized aircraft—the Spad XIII, World War I fighter, and the F-5-L, World War I Naval patrol bomber—received extensive repairs. The exhibition of the Wright Brothers' Wind Tunnel was improved by adding a copy of the bench grinder, fan, and belt, which provided the wind current, and the small truck used to launch the original *Kitty Hawk*.

ACCESSIONS AND EVENTS

The outstanding accession of the year was the Bell supersonic airplane X-1 noted above. This was formally presented to the Air Museum by Gen. Hoyt S. Vandenberg on behalf of the United States Air Force and accepted by Dr. Alexander Wetmore, Secretary of the Smithsonian, on August 26, 1951, at Logan Airport, Boston, Mass., during the National Air Fair. Participating in the ceremony were Lawrence D. Bell, president of Bell Aircraft Corp. which constructed the airplane, Lovell Lawrence, Jr., president of Reaction Motors, Inc., makers of the rocket engine which powered the X-1, and Capt. Charles E. Yeager, United States Air Force, who first piloted the X-1 through the sonic barrier on October 14, 1947.

A second accession of note was a duplicate of the first ram-jet engine to achieve thrust over drag and attain supersonic speed. This type of jet engine was developed for the United States Navy by the Johns Hopkins University Applied Physics Laboratory, Silver Spring, Md. The first successful demonstration occurred on June 13, 1945, when a speed of about 1,500 miles an hour was attained. The original engine was lost in the ocean off Island Beach, N. J., where the experiment took place, but a duplicate composed of original parts, sectioned to show construction and operation details, was prepared for the National Air Museum. Its presentation was made at a ceremony held in the Aircraft Building on November 29, 1951, in which Rear Adm. A. G. Nobel, Chief of the Bureau of Ordnance, United States Navy, Dr. R. E. Gibson, Director of the Laboratory, and his associate, Dr. Wilbur H. Goss, participated. Carl W. Mitman, Assistant to the Secretary for the National Air Museum, accepted the gift.

An outstanding aeronautical event celebrated during the year was the fortieth anniversary of Naval Airplane Carrier Operations. Such operations were instituted on January 18, 1911, by Eugene Ely, an associate of Glenn H. Curtiss, pioneer aircraft manufacturer, when he landed upon and took off from a special deck platform constructed on the U. S. S. *Pennsylvania* anchored in San Francisco Harbor. That successful experiment demonstrated the utility of the aircraft carrier, which proved to be such a vital factor in World War II. To mark the anniversary the Museum obtained a scale model of the old U. S. S. *Pennsylvania* and constructed on its stern deck a scale reproduction of the special landing platform and arresting gear used by Ely. Upon this a model of his airplane was placed illustrating the moment of successful landing. The Museum meanwhile had acquired by transfer from the Department of the Navy an early Curtiss airplane engine identified as the one that powered Eugene Ely's airplane on this historic occasion. The engine was procured through Don Coe, Buffalo, N. Y. These two accessions, together with a series of photographs illustrating carrier development from 1911 to the present, were combined attractively into a special exhibit which, for the anniversary, was placed first in the foyer of the Navy Department and later exhibited in the Pentagon. The exhibit is now permanently incorporated in the Museum's collections.

Three full-sized aircraft of historical or technical significance were added to the collections, in addition to the Bell X-1. They are the trans-Isthmian tractor airplane, designed, constructed, and flown across Panamá in 1913 by the renowned pilot Robert C. Fowler; the Northrop F-61 of World War II origin believed to be the first type of American fighter designed specifically for night operations; and the McDonnell helicopter *Whirlaway*, the first twin-engined helicopter and prototype of the heavy lift designs now under development. These three aircraft are in storage until a museum building is provided.

Among the aircraft engines added, the original Pratt & Whitney Wasp engine No. 1, which in 1925 laid the foundation for that company's development of radial engines, is outstanding. In addition, two sectionalized and operating Wright radial engines of World War II era, received from the Navy, help both student and layman to understand the workings of this complicated type of internal-combustion engine. Guided missiles, also received from the Navy, not only furnish important examples of both German and American types, but also provide, in their engines, forms of jet propulsion that supplement the types shown in the Museum's engine display. A series of miniature engines as used on model airplanes is of particular interest to younger flyers. A unique addition to the propeller collec-

tion was received from Stanford University, namely, the experimental test model of a controllable pitch propeller embodying features developed in 1918 by Dr. W. F. Durand and his associate, Dr. E. P. Lesley. Dr. Durand has made many important contributions to aeronautics.

Other accessions worthy of note are an original oil portrait of Wilbur Wright done from life by J. A. Herve Mathe, received from Gen. Frank P. Lahm, U. S. A. (ret.), and his sister, Mrs. Frank Parker; and the Harmon Trophy established by Clifford B. Harmon in memory of the Lafayette Escadrille of World War I and awarded for outstanding accomplishments in aeronautics. The Air Museum is recognized as a logical repository for renowned trophies.

A full list of the year's accessions is presented at the close of this report.

STORAGE

With more than two-thirds of the collection of full-sized aircraft in storage because of the lack of an adequate building, storage-facility operations loom large in the bureau's management. The principal storage facility during 1951, as in the previous 2 years, was the former Douglas DC-4 plant at Park Ridge, Ill. The program of operations there concerns the guarding, preservation, and cataloging of aircraft, engines, and components, and their preparation for eventual shipment to Washington. Other programs include evaluation of specimens, screening and salvaging of material, research on design details of aeronautical items, and special informational services. All operations were advanced during the year with the result that of the 82 full-sized aircraft on a retained status, 33 had been boxed for shipment, 11 had been disassembled for boxing, 27 were ready for disassembly, and 11 were assembled and made flyable. Of the 106 engines only 5 remained unboxed. About 5,000 components are now boxed, but many of the containers require repair.

Technical research by the staff resulted in the selection and segregation of a number of details of aircraft construction which are being prepared for display. These include samples of Japanese wing-rib stitching, a German rocker box hold-down fitting, a German saw-toothed entering edge from an He-177 wing for severing cables of barrage balloons, a German cable clamp, German pulley, and other items believed in each instance to incorporate features that are of interest to designers and engineers.

Informational service included furnishing data on aircraft details to pilots and mechanics servicing airplanes of types similar to those in the collection, guided tours of the collection for groups of United States Air Force personnel studying design features of foreign aircraft, loans of significant specimens for official educational and re-

cruciating displays, and preparation of special exhibitions for Armed Forces Day.

To record historical and design details of specimens, the staff devised and installed a special card-index system, and by the close of the year cards had been prepared for all aircraft, engines, parachutes, and flight clothing. This information will expedite the preparation of permanent records at the Washington office. The operation of the storage facility this year was under the immediate supervision of the associate curator, Walter Male. His staff consisted of two clerks, three mechanics, two carpenters, and four guards. Space occupied by the stored collections, office, and shop at Park Ridge remained at 147,600 square feet throughout the year.

Naval aircraft being retained for the Museum are stored at the Naval Base, Norfolk, Va. Additions during the year included several engines and the McDonnell *Whirlaway* helicopter. Donors who are assisting the Museum by storage of significant aircraft include Howard Hughes with his transcontinental record holder of 1937, and Stanley Hiller with one of his early coaxial helicopters. During the year, storage at Washington was relieved by shipping to Park Ridge two aircraft, six engines, and a quantity of components, models, and other items which had been removed from exhibition to relieve congestion.

COOPERATIVE PROJECTS AND INFORMATIONAL SERVICES

Assistance to other Government departments included: for the State Department, furnishing historical data on rigid airships; and for the Department of Justice, tracing development of various types of connectors and handles used in parachute harnesses, and checking cockpit installations as adapted to blind-flying operations. This research was in connection with patent priority investigations. The Museum provided and assisted in posing models of aircraft and items of insignia and flight clothing for a motion picture being prepared for the Air Force. The use of identifying marks and insignia on aircraft was traced for the heraldic office of the Air Force, and one of its historical-research analysts was assisted in preparation of data on the Wright Brothers. At the request of Kirtland Air Force Base, a Japanese fighter airplane, *Oscar*, was made available from the excess examples stored at Park Ridge.

The Department of the Navy consulted the Museum to determine details of one of its early Curtiss aircraft—the *Triad* of 1911. This information was supplied from photographs and texts in the Faurote collection of Curtiss data acquired several years ago. The Naval Bureau of Ordnance Laboratory was lent a scale model of the Curtiss SB2C for use in preparing a larger model, and the Bureau of Navigation was assisted in identifying an early bubble sextant adapted

for aerial navigation. The Navy's research workers investigating rocket propulsion were given information regarding some of the basic work performed by Robert Goddard by reference to the collection of Goddard rockets and apparatus in the Museum.

The spectacular employment of helicopters in the Korean war was the subject of a meeting called by the Public Relations Office of the Navy's Bureau of Aeronautics at which the curator furnished data on types and assisted in planning a display and flight program held later in the year in Washington under the direction of the Aviation Industries Association. The National Advisory Committee for Aeronautics received assistance in editing articles on the scientific aspects of the Wright Brothers' accomplishments. One of the flight projects being conducted by that Committee required the use of an F-61 Northrop *Black Widow*, a night fighter developed during World War II. Use of the Museum's example was requested; it was flight-conditioned and lent to the N. A. C. A. for this important purpose.

Both the Air Force and the Navy were aided in the preparation of educational exhibits for Armed Forces Day displays involving use of Museum material. The Naval Historical Foundation was assisted in the preparation of a Naval aviation historical exhibit at the Truxtun-Decatur Naval Museum in Washington. Two airlines—United and Capital—celebrated anniversaries this year and requested assistance from the Museum in planning their programs and displays. Pratt & Whitney Aircraft required basic information on cooling of aircraft engines and were gratified to find helpful examples in Museum material; this company was also assisted in making available to the Museum of Science in Boston an early example of their Wasp engine. The compilers of the Aircraft Year Book again called upon the Museum while preparing their review of the year's accomplishments, and many authors, artists, and modelmakers were helped in various projects.

The National Aeronautic Association again appointed the curator a member of their committee that selected the annual recipient of the Brewer Trophy, awarded for advancing the interests of air youth education; the recipient was Lt. Comdr. John Burton. The Institute of Aeronautical Sciences was lent one of the rockets from the Robert Goddard collection, with approval of the Daniel and Florence Guggenheim Foundation, which prepared the original exhibition.

During the year the curator by request lectured on the history of aeronautics before several church, school, Boy Scout, and business organizations; and he and other members of the staff conducted a number of special tours of the collection for special groups including four large units of Air Force and Naval officers studying aeronautical history, structural characteristics, and aircraft recognition features.

ACKNOWLEDGMENTS

Each year the Air Museum receives, in addition to its accessions, very helpful assistance from many sources. Particular acknowledgment this year is accorded to the United States Air Force for transporting the X-1 supersonic airplane from Boston to Washington; to the Bell Aircraft Corp. for preparing this plane for exhibition; and to the National Advisory Committee for Aeronautics for furnishing data on its flights. The United States Air Force also supplied a crew to assist the Museum's exhibits workers in dismantling the DeHavilland-4 to make room for the X-1. The United States Air Force and Republic Aviation cooperated in preparing for exhibition the cockpit and nose portion of the F-84 thunderjet previously mentioned. The Navy furnished a crew to move the F9C-2 *Akron* fighter airplane and to move, repair, and paint the hull of the transatlantic NC-4. William B. Stout, Advisory Board member, constructed a replica of his Sky Car fuselage and fitted it to the existing units of this famous plane previously in the Museum's custody, thus restoring it to its original appearance.

The reference files, which constitute a valuable source of information used in preparation of labels for specimens, for research by the staff, and in answering inquiries from visitors and correspondents, were greatly improved during the year by important donations. The Consolidated Vultee Aircraft Corp. gave a collection of 44 framed photographs of aircraft produced by this company and its associates; Mr. and Mrs. W. S. Clime, of Old Lyme, Conn., presented photographs, articles, and clippings relative to the flights at Fort Myer, Va., in 1908-09 by the Wright Brothers; Joseph M. Gwinn, Jr., of Buffalo, N. Y., forwarded data on the Gwinn Aircar of 1937; Miss Elsa Needham, of Washington, D. C., gave photographs of lighter-than-aircraft; R. M. Kinderman, of Hazlet, N. J., 1,744 items, mainly aeronautical journals dating from 1911 to 1940 including several complete volumes; Benjamin Kohn, of Washington, D. C., photographs of the first World Flight, 1924, and the Good Will Flight to Latin America in 1926-27; Alois Schlachter, of Fort Lauderdale, Fla., photographs of prominent aeronautical personages, and material associated with Zeppelin airship operations; Mrs. Clara Studer, of Elmhurst, N. Y., author of "Sky Storming Yankee," the source material used in writing this biography of Glenn Hammond Curtiss; and from other sources, photographs, scrapbooks, trade journals, books, and reference items to expand this very useful fund of aeronautical knowledge.

SURVEY

The Air Museum's survey for potential aeronautical material was pursued as in former years and included the following trips:

- North Merritt, L. I., August 21, by Stephen L. Beers, associate curator, to check authenticity of a Thomas Morse S4C advanced trainer of World War I.
- Dayton, Ohio, September 4-9, by Robert C. Strobell, associate curator, to examine Air Force material at Wright Patterson Field.
- St. Louis, Mo., October 28, by Paul E. Garber, curator, to examine airship parts offered by Mrs. Hazel Jelinek.
- Annapolis, Md., December 1, by Paul E. Garber, curator, to inspect aircraft engines and training aids available at the Naval Academy.
- Quantico, Va., November 9, by Paul E. Garber, curator, to inspect jet engines available at the Marine Corps Air Base.
- Hazlet, N. J., January 27-28, by Robert C. Strobell, associate curator, to inspect and procure reference material.
- Pine Orchard, Conn., May 14-16, by Paul E. Garber, curator, to examine papers and drawings on Gallaudet aircraft.
- Wilkes-Barre-Scranton Airport, Pa., June 1, by Robert C. Strobell, associate curator, to check condition of a Curtiss P-40 *Warhawk*.
- Dayton, Ohio, June 5-8, by Robert C. Strobell, associate curator, to inspect aircraft equipment at Wright Patterson Field.

LIST OF ACCESSIONS

During the year, 99 specimens were recorded from 30 sources. Those received from other Government departments were acquired by transfer; all others, except those identified as loans in the following list, were gifts:

- AGRICULTURE, DEPARTMENT OF, Washington D. C.: Two 2-bladed wooden airplane propellers of the World War I era, embodying experimental use of adhesives developed by the Forest Products Laboratory (N. A. M. 701).
- AIR FORCE, DEPARTMENT OF, Washington, D. C.: The Bell X-1 rocket-propelled airplane, first man-carrying aircraft to achieve supersonic flight, Capt. Charles Yeager, pilot, October 14, 1947 (N. A. M. 697); a Northrop F-61-C *Black Widow* airplane developed during World War II as a night fighter (N. A. M. 703); (through Col. Frank Kurtz) a large framed map of the Pacific area and the Americas, showing the flights of the Boeing B-17-D bomber *Swoose* (N. A. M. 716).
- AIR FORCE, 65TH FIGHTER SQUADRON, 57TH FIGHTER GROUP, Shaw Air Force Base, Sumter, S. C.: (Through Maj. James C. Hare, U. S. A. F.) An insignia panel "bar front" inscribed with names of airmen and their victories attained with this unit in World War II (N. A. M. 696).
- AMERICAN LEGION AUXILIARY, New York City: (Through Mrs. Willis Reed, Mrs. Harold Taylor, and Miss Felicity Buranelli). The original bronze plaque of Amelia Earhart, sculptured for the Medal-of-the-Month Club by Brenda Putnam (N. A. M. 714).
- CLIME, MR. AND MRS. WINFIELD SCOTT, Old Lyme, Conn.: An American flag flown from Wright Brothers' 1908 military plane (N. A. M. 699).

- CODDING, LT. G. E., U. S. A. F., c/o 634th AC&W Sqdn., Paine Field, Everett, Wash.: A collection of model aircraft engines and propellers (N. A. M. 702, loan).
- DELTA UNIFORMS, New York City: (Through Howard Zeimer) A pilot's cap of the type worn by personnel of commercial airlines, U. S., 1950 (N. A. M. 706).
- ELLIS, FRANK H., Hollyburn P. O., West Vancouver, British Columbia: Three models of pioneer airplanes built and flown in Canada, 1910-14 (N. A. M. 711).
- FOWLER, ROBERT C., San Jose, Calif.: Fowler airplane, 1913, built and flown by donor on first flight across Isthmus of Panama (N. A. M. 694).
- GRUMMAN AIRCRAFT ENGINEERING CORP., Bethpage, L. I., N. Y.: Three models (1:16) of Grumman airplanes participating in the Korean war (N. A. M. 709).
- HARMON INTERNATIONAL TROPHIES, New York, N. Y.: (Through Clifford B. Harmon Trust) An annual award trophy for the most outstanding contributions to the science of flying during the preceding year (N. A. M. 700).
- JELINEK, MRS. HAZEL SHAW, St. Louis, Mo.: Airship parts from a dirigible of about 1907 (N. A. M. 719).
- JOHNS HOPKINS UNIVERSITY APPLIED PHYSICS LABORATORY, Silver Spring, Md.: A duplicate example of world's first successful supersonic ram-jet engine and its rocket booster (N. A. M. 698).
- LAYM, BRIG. GEN. FRANK P., U. S. A. (RET.), AND MRS. FRANK PARKER, LaJolla, Calif.: A life-size oil portrait of Wilbur Wright painted during life in 1908 by J. A. Herve Mathe (N. A. M. 691, loan).
- LOCKHEED AIRCRAFT CORP., Burbank, Calif.: (Through Robert E. Gross, president) A model of Lockheed F-80 *Shooting Star* of type flown by Lt. Russell E. Brown, U. S. A. F., in winning first jet airplane combat, Korea, 1950 (N. A. M. 715).
- MCDONNELL AIRCRAFT CORP., St. Louis, Mo.: The twin-engined helicopter XHJD *Whirlaway* (N. A. M. 718).
- MEREDITH, CAPT. SPENCER B., Arlington, Va.: An original German ribbon parachute test model and a German engine injector, World War II (N. A. M. 717).
- NAVY, DEPARTMENT OF, BUREAU OF AERONAUTICS, Washington, D. C.: Two early Curtiss aircraft engines; one used by Eugene Ely in his landing on and take off from the U. S. S. *Pennsylvania*, 1911; the other from a Curtiss flying boat of 1912 (N. A. M. 710); the original Pratt & Whitney Wasp engine No. 1 developed in 1925 (N. A. M. 720); four guided missiles: 2 U. S. Naval—a KAN-2 *Little Joe* and KUZN-1 *Gorgon*—and 2 German of World War II—an HS-298 and an X-4, and 12 component parts for guided missiles (N. A. M. 712).
- NAVY, DEPARTMENT OF, UNITED STATES NAVAL ACADEMY, Annapolis, Md.: Six Naval training devices comprising cutaway examples of Wright aeronautical engines, types R2600 and R3350, and panels showing details of auxiliary equipment (N. A. M. 704).
- REPUBLIC AVIATION CORP., Farmingdale, L. I., N. Y.: Model (1:58) of a U. S. Air Force Republic F-84 thunderjet single-seat jet fighter, 1947 (N. A. M. 707).
- ROBINSON, MRS. PEARLE T., Washington, D. C.: A sterling-silver trophy awarded by the Washington Air Derby Association for outstanding contributions to the cause of private flying in the District of Columbia area (N. A. M. 693, loan).
- STANFORD UNIVERSITY, Stanford, Calif.: (Through Lr. W. F. Durand and Dr. Elliott G. Reid) An early test model of an adjustable pitch propeller incorporating the features developed by Profs. W. F. Durand and E. P. Lesley at Stanford University in 1918 (N. A. M. 705).
- SHORT, V. ROXOR, Westbrook, Conn.: Model (1:24) Sikorsky XR-4 helicopter, 1942, and a pattern model (1:72) of a Spitfire, British World War II fighter (N. A. M. 708).

UNITED STATES NATIONAL MUSEUM, Washington, D. C.: Scale exhibition model of the U.S.S. *Pennsylvania*, which was used in the first airplane carrier operation, San Francisco Bay, January 18, 1911 (modified in National Air Museum shop to show stern landing platform and scale model of Ely's Curtiss airplane) (N. A. M. 713).

WAITE, H. ROY, Washington, D. C.: An aviation poster printed in 1912, advertising flights by the donor at Florence, S. C., in a Burgess-Wright aeroplane (N. A. M. 695).

WRIGLEY, PHILIP K., Chicago, Ill.: A model (1:16) of the Verville flying boat, 1915, used for training and reconnaissance service at Great Lakes Naval Training Station during World War I (N. A. M. 692).

Respectfully submitted.

CARL W. MITMAN,

Assistant to the Secretary for the National Air Museum.

Dr. A. WETMORE,

Secretary, Smithsonian Institution.

APPENDIX 10

Report on the Canal Zone Biological Area

SIR: It gives me pleasure to present herewith the annual report on the Canal Zone Biological Area for the fiscal year ended June 30, 1951.

IMPROVEMENTS

A contract was awarded for the construction of a new 2-story building to provide much-needed space for laboratory expansion. Two of the eight rooms on the ground floor will be used for photographic work; another will be a general dry room provided with heaters; and the others will be for laboratory work, toilets, and showers. The eight upper-floor rooms will house the library, herbarium, card-index records, laboratory glassware, microscopes, incubators, chemicals, and other scientific apparatus. With each room a unit by itself, it will be easier to control humidity and temperature, and most of the rooms will have dehumidifiers. The roof, an inverted-V type, will be of aluminum and will have gutters to collect the rain water and direct its flow into a large concrete water-storage tank, to be constructed. This reservoir is urgently needed because the other large one, of creosoted timber, is badly deteriorated.

During the year the new addition to the building for deterioration and corrosion tests, started last year, was completed, and the interior was remodeled. The building for the resident manager and the foreman's former building (now a dormitory) were thoroughly bat-proofed.

All the trails were inspected to determine their general condition and to note any markers that might be missing. Four students from Cristóbal—Larry Cox, Andrew Bleakley, Jr., John Delaney, and Don Smith, Jr.—were recommended for this task by Scout Master Richard D. Cox, and to them was entrusted this important job, which they did extremely well. In addition, they kept a record of the animals they saw. A number of markers and posts will have to be replaced, but on the whole the trails are in excellent condition.

CONDITION OF BUILDINGS

The main laboratory building remains in satisfactory condition, but eventually should be converted into one with less fire hazard. The

Haskins library building is in excellent condition, but should have better humidity controls.

The resident manager's house is in excellent condition, and the Barbour cottage, the Z-M-A house below the main building, and the house formerly occupied by the foreman are all in satisfactory condition for the present. They should be provided with dry closets, but our present supply of electric current is not sufficient for this.

The kitchen and storeroom, though somewhat small for present needs, are in good shape but still remain a fire hazard. It is proposed to rebuild this unit of concrete blocks. The two buildings for the cook and laborers are serviceable.

All the generators are in bad shape and cannot be operated on a 24-hour basis. This is a serious handicap to our food refrigeration.

The floating equipment is in good condition.

MOST URGENT NEED

The generation of electric current on the island is not only expensive, but it is impossible to insure an adequate and constant supply. To the high cost of the necessary daily attention to the generators, the constant hauling of fuel, and periodic overhaul and repairs must be added the loss incurred by spoilage of food, damage to books, and deterioration of scientific equipment due to a drop in the voltage or complete failure of the supply of current. Also, because of the deterioration and corrosion caused by the high humidity in the Tropics, the life of a generator on the island is, at best, only 8 or 9 years. The present installation is urgently in need of new units; but new generators will not solve the problem, as the high operating cost will continue, and in 8 years new units will again be required.

A very careful study of the problem has been made, in consultation with electrical engineers of the Panama Canal and the armed forces. The logical solution would be to tap the transmission line of the Panama Canal, install transformers at Frijoles, lay an underwater cable to the island, and there install transformers to step down the voltage to 115-230. This would insure the island an adequate and dependable supply of electricity at a cost of 2 cents for the first 100 kilowatts and 1½ cents for each additional 100 kilowatts. At this very substantial reduction in the cost of current, the system would pay for itself in 10 or 12 years.

SCIENTISTS AND THEIR STUDIES

During the year 33 scientists came to the island. High cost of transportation to the Canal Zone still deters many from coming to the Area.

Dr. A. M. Chickering, chairman of the division of science and mathematics at Albion College, Michigan, continued his research on spiders, collecting a large series for further study. This is his fifth visit to the island for this purpose. In *Turtlox News* for May 1951 Dr. Chickering published an interesting account of his explorations in the Canal Zone and Panamá, particularly on Barro Colorado Island. His estimate of 1,200 species of spiders on the island is indicative of the variety of species in other groups that may be expected to exist. During the past 12 years he has published 15 papers on the spiders of this general area, one on the Salticidae covering 474 pages.

Dr. Eugene Eisenmann, of New York City, returned again to resume his studies of the birds of the island. He prepared an annotated list of the birds definitely known to inhabit the island, covering 306 species, which is to be published by the Smithsonian Institution. In this he includes reference to the many other scientists who have studied the bird life of the island. This will be the first published list of birds of the Area to bring together all available records. The obvious gaps should stimulate interest and further study.

Dr. Frank A. Hartman, research professor of physiology, Ohio State University, a recognized authority on the adrenals of vertebrates, returned for a more extended stay. With the aid of his assistants, Harry Beckman, a graduate-school assistant, and Ratibor and Armageddon Hartmann from Chiriquí, he collected and preserved what is probably the most extensive and comprehensive series of adrenals ever brought together. Half of the total of 1,447, from birds, mammals, reptiles, and amphibians, are from the Canal Zone, and the rest from the Volcán area of Chiriquí Province. About 200 skins, as well as whole animals in formaldehyde, were prepared, the former for identification and the latter for future anatomical studies. Careful drawings were made of the adrenals and also of the thyroids of birds. The preserved adrenals and thyroids will be used for extensive histological and cytological studies. The bird skins will be placed in the U. S. National Museum.

Dr. Bernard Lowy, of the botany department of the State University of Iowa, spent several months on the island studying principally the fungi, making large collections and many observations and taking many notes and photographs (more and more essential in mycology). Of Myxomycetes and Phycomycetes he collected more than 70 species and made a thorough study of his specialty, the Auricularias. He also collected much material from the Ascomycetes, the Basidiomycetes, and the Fungi Imperfecti, as well as lichens, mosses, and liverworts—the last two groups being exceptionally prolific. Of the Meliiales more than a hundred species have been de-

scribed from the island. Dr. Lowy was most fortunate in obtaining excellent specimens of Cordiceps. He was not limited by his special interest in the fungi, but collected also many of the higher plants, and obtained rich material and notes particularly on the unique saprophyte *Ophiomeris panamensis* and the very rare achloriferous *Apodanthes flacourtiæ* of the family Rafflesiaceae, known only from the island, growing on *Xylosoma*.

Dr. Nicholas E. Collias, of the zoology department of the University of Wisconsin, spent several months studying the population density and social organization of the island's howler-monkey clans, for comparison with the studies made 18 years ago by Dr. Carpenter. He had with him as collaborator Charles Southwick, graduate student of the University of Wisconsin, Department of Wild Life Management. The study showed significant changes in the number of individuals, location and size of the clans, reduced sex ratio, and proportion of young in each clan. Detailed studies of the daily locations and movements of the Lutz clan were made over an extended period, preliminary to the census. The task was much greater than it would seem at first, and suggests the desirability of asking scientists who are on the island, with time to do so, to make similar observations of this particular clan. These data should, over a period of years, yield information that may explain why there are such significant changes.

During his stay Dr. Collias also definitely identified 123 species of birds, including several new to the island list. Charles Southwick, who assisted Dr. Collias, made significant observations on many of the other mammals. In this work the two covered the entire island.

Dr. Lorus J. Milne, professor of zoology, and Dr. Margery Milne, assistant professor of zoology, of the University of New Hampshire, came to the island to study the light-sensitive structures of animals, particularly the invertebrates. While on the island and in its vicinity, they exposed more than 3,000 feet of 16-mm. Kodachrome movies, and a large number of 35-mm. color stills and 4-x-5 black and whites, which comprised a well-documented account of the plants and animals of this part of the American humid Tropics. They also had the opportunity to study in great detail the rare *Peripatus*.

Dr. Hazel R. Ellis, head of the biology department of Keuka College, Keuka Park, N. Y., spent considerable time on the island studying the bird life, particularly nesting habits and songs. Although she noted 76 species, her interest was not in the number of different kinds of birds, but rather in observing how they live and behave. In detail she studied the fruit crow (*Querula purpurata*), of whose habits little is known. She also made lengthy notes on the nests of the tinamou, Hicks's seedeater, the double-toothed kite, the boat-tailed flycatcher, the tityra, the spotted antbird, and the Nicaraguan hermit hummingbird. Dr. Ellis also made observations on most of the more common

mammals and on the plants, particularly those that are used by birds.

Robert M. Laughlin, student at Princeton University, came for an extended stay and made many interesting observations. He discovered the nest of the double-toothed kite not previously noted. Also, he added the second-known record of the red-thighed dacnis. During his stay he identified 96 species of birds. He also made observations on eight of the mammals and took back with him about 500 moths and other insects for further study.

Dr. Serge Korff, professor of physics, New York University, and Mrs. Korff, revisited the island, on their return from the Fifth South American Congress of Chemistry, to continue their observations on plants and animals.

Robert Lewis Cumming, student at the University of Florida, spent considerable time on the island during which he made a very thorough study of the dragonflies and damselflies, increasing the number of species previously recorded to 38, including a number new to science. He made careful notes on the ecology of the Odonata. In addition he added valuable data on the mammals and birds.

Dr. Carl Koford, of the Museum of Vertebrate Zoology, University of California, and Mrs. Koford spent a week on the island en route to Perú, where they will spend about a year in research work. Dr. Koford was interested mainly in the vultures, and Mrs. Koford specialized on the bats.

Dr. John H. Davis, professor of botany, University of Florida, returning from New Zealand, visited the island to acquaint himself with the flora of the humid American Tropics, particularly its ecological aspects. He was so impressed with the plant life, and with the facilities the island offers for study, that he plans to make it possible for students of his university to study there. While at Barro Colorado, he made a good collection of plants.

Ross Robbins, botanist at the Auckland University, on transfer to a similar post in the University College of the West Indies, in Jamaica, accompanied Dr. Davis, to observe the tropical flora and, in particular, to make a good collection of mosses, which are his special field. Both he and Dr. Davis were greatly impressed with the opportunities for research offered by the island.

Dr. Francis J. Ryan, associate professor of zoology, Columbia University, and Mrs. Ryan, spent a short time on the island while en route to the Fifth International Congress on Microbiology at Rio de Janeiro. Their objective was to get acquainted with the plant and animal life of the humid Tropics preparatory to a return later for more extended research.

Ledlie I. Laughlin, associate director of admissions to Princeton University, came, with his son Robert, to observe the birds and mammals of the Tropics in their natural environment.

Dr. R. T. Scholes, of the medical staff of Gorgas Hospital, and Mrs. Scholes, spent considerable time on the island studying the bird life and added many valuable records which will be incorporated in Dr. Eisenmann's list of the birds. They took a splendid series of Kodachrome photographs, part of them with a long-range telephoto lens.

M. François Edmond-Blanc and Mme. M. C. Brot, from France, visited the island to study at close range the birds peculiar to the American humid Tropics.

Dr. C. C. Soper, director of the Tropical Research Laboratory of Eastman Kodak Co., continued and expanded this firm's exposure tests, assisted by Paul Hermle, physicist, and Ismael Olivares, microbiologist. The results are most gratifying and emphasize the need of such tests to study the rate of deterioration and corrosion. After 10 years, the importance of this work is more and more evident, and Barro Colorado Island is particularly well suited for these studies and for the evaluation of biocides.

Dr. Walter F. Clark, of the Research Laboratories of Eastman Kodak Co. at Rochester, and an authority on infrared photography, revisited the island for his annual inspection and conferences connected with the tests under way. He also did considerable experimental color photography, particularly under difficult conditions.

Dr. Alexander Wetmore, Secretary of the Smithsonian Institution, revisited the island and held conferences with the resident manager on plans for the future of the Area, proposed improvements, and details of the new building, and solution of the problem of an adequate supply of electricity. As in the past, W. M. Perrygo, of the U.S. National Museum, accompanied him.

John E. Graf, Assistant Secretary of the Smithsonian Institution, likewise revisited the island and held conferences with the resident manager, particularly regarding the plans for the new building and the matter of electricity. He held conferences with electrical engineers of the Panama Canal, with Dr. Soper of the Tropical Research Laboratory of Eastman Kodak Co., and others, and made a thorough inspection of the island installations and facilities, discussed operations, and worked on plans for further improvements and expansion.

Thomas F. Clark, administrative accountant of the Smithsonian Institution, made a special trip to the island to establish the required procedure to be followed in advertising for bids for the new building, the inclusion of additional provisos in the specifications, the opening of the bids, the awarding of the contract, the various bonds required, and other details.

The resident manager continued his special research problems, particularly the long-term termite-resistance tests, and completed his forty-third report. He also continued the fruit-fly studies, particu-

larly in regard to population, fluctuations, and host-fruit relations. The new building just erected embodies the very latest improvements in termite protection, bat-proofing, and (with a more dependable and adequate supply of electricity) humidity-temperature control for the protection of the library, herbarium, microscopes, balances, and other delicate laboratory apparatus. In addition he made a detailed study of the problem of electricity sources, evaluating the pros and cons of generators on the island, both Diesel and others, and the use of current from the Panama Canal line—the logical and economical solution, as set forth earlier in this report. The Bureau of Entomology and Plant Quarantine tests with soil poisons were continued. The large Berlese funnel was kept in operation and yielded an abundance of rare insects, mites, and other forms difficult to find in any other way.

The following quotation from a letter from the late Dr. Thomas Barbour to President Hopkins of Dartmouth College, June 17, 1931, aptly defines the general purpose of the Canal Zone Biological Area:

“I don't think I have ever received a letter that warmed the cockles of my heart more immediately than did your letter of June 15th * * *. No man ever goes to Barro Colorado Island without being a more inspiring teacher on his return. This remark has been made to me by men connected with over a dozen institutions. I emphasize this feature because so much has been said of the opportunities for research that I sometimes feel that the opportunity for just the plain broadening of man's mental horizon has not always been sufficiently emphasized.”

VISITORS

There were fewer visitors this year than the year before. Among numerous others were the following: The Honorable John M. Vorys, Member of Congress from Ohio and a Regent of the Smithsonian Institution, with his family; Col. Standley Carpenter, in charge of the army malaria work on the Isthmus; Marvin Keenan, in charge of the army's sanitation; The Honorable Monett Davis, Ambassador to Panamá, with his family; several Boy Scout and Girl Scout troops with their leaders, and also a large group of these leaders; Irving Johnson and members of the *Yankee*; students from LaSalle College and Miramar College of Panamá, with their professors; Frank E. Masland, Jr., and family; members of the Balboa Camera Club; Dr. John B. Chadwick of Gorgas Hospital; several groups of high-school students from Panamá and their teachers; Dr. J. Russell Smith, of Columbia University; Dr. Norman Elton, director of the Gorgas Board of Health Laboratory and members of his staff; a large group from the Cristóbal High School; William E. Lundy of Balboa, Don Biery

and other members of the Institute of Inter-American Affairs, and members of the staff of the United States Embassy; Ambassador Mariani of Italy with his family; Dr. David Potter, of Clark University; members of the student class of the Balboa Junior College under the leadership of Prof. George O. Lee; and William Burgoyne.

The outstanding scientific event of the year was the week-long Conference on Corrosion and Deterioration, in which the island participated, and which was attended by a host of delegates from the United States. More than 40 of the delegates visited the island as part of the program.

RAINFALL

In 1950, during the dry season, rains of 0.01 inch or more fell on 30 days (84 hours), and during the wet season (8 months) on 207 days (947 hours); a total for the year of 237 days (1,031 hours). Rainfall was 7.44 inches above the 26-year station average. November and December were the rainiest months (54 days, 352 hours), 41.64 inches, 36.3 percent of the year's total. The dry season, while below average, was considerably wetter than that of 1949.

TABLE 1.—*Annual rainfall, Barro Colorado Island, C. Z.*

<i>Year</i>	<i>Total inches</i>	<i>Station average</i>
1925-----	104. 37	-----
1926-----	118. 22	113. 56
1927-----	116. 36	114. 68
1928-----	101. 52	111. 35
1929-----	87. 84	106. 56
1930-----	76. 57	101. 51
1931-----	123. 30	104. 69
1932-----	113. 52	105. 76
1933-----	101. 73	105. 32
1934-----	122. 42	107. 04
1935-----	143. 42	110. 35
1936-----	93. 88	108. 98
1937-----	124. 13	110. 12
1938-----	117. 09	110. 62
1939-----	115. 47	110. 94
1940-----	86. 51	109. 43
1941-----	91. 82	108. 41
1942-----	111. 10	108. 55
1943-----	120. 29	109. 20
1944-----	111. 96	109. 30
1945-----	120. 42	109. 84
1946-----	87. 38	108. 81
1947-----	77. 92	107. 49
1948-----	83. 16	106. 43
1949-----	114. 86	106. 76
1950-----	114. 51	107. 07

TABLE 2.—Comparison of 1949 and 1950 rainfall, Barro Colorado Island, C. Z. (inches)

Month	Total		Station average	Years of record	Excess or deficiency	Accumulated excess or deficiency
	1949	1950				
January.....	0.70	0.20	1.73	25	-1.53	-1.53
February.....	.07	1.87	1.20	25	+.67	-.86
March.....	.11	.48	1.28	25	-.80	-1.66
April.....	.90	2.73	2.73	26	-----	-1.66
May.....	11.97	7.86	10.78	26	-2.92	-4.58
June.....	15.57	14.66	11.41	26	+3.25	-1.33
July.....	13.38	12.37	11.71	26	+.66	-.67
August.....	9.99	11.48	12.31	26	-.83	-1.50
September.....	7.11	7.20	10.03	26	-2.83	-4.33
October.....	14.45	14.02	13.16	26	+0.86	-3.47
November.....	32.76	24.19	19.58	26	+4.61	+1.14
December.....	7.85	17.45	11.15	26	+6.30	+7.44
Year.....	114.86	114.51	107.07	-----	-----	+7.44
Dry season.....	1.78	5.28	6.94	-----	-----	-1.66
Wet season.....	113.08	109.23	100.13	-----	-----	+9.10

FISCAL REPORT

During the fiscal year 1951, \$10,781.87 in trust funds was available. Of this amount \$10,555.97 was spent, leaving a balance of \$225.90. In addition to this, \$583.30 is still on deposit, representing local collections.

The following items are paid out of trust funds: Food, freight, and express, salaries and wages, office expenses, parts and repairs to automobile, parts and repairs to floating equipment and to generators, and sundry bills for general upkeep. Food represented 32.5 percent of the total expended, and salaries and wages 57.4 percent.

During the year \$868.50 was collected as fees from scientists, \$126.50 more than the previous year.

Despite the rising costs of food, wages, and other items, which were higher than the previous year, the laboratory has not yet increased its per-diem charge to scientists for meals and lodging and has continued to give a 25-percent discount to those who come from institutions that sustain table subscriptions.

The following institutions continued their support to the laboratory through the payment of table subscriptions:

Eastman Kodak Co.....	\$1,000.00
New York Zoological Society.....	300.00
American Museum of Natural History.....	300.00
Smithsonian Institution.....	300.00

It is most gratifying to again record donations from Dr. Eugene Eisenmann of New York.

In addition to its table subscription, the Smithsonian Institution contributed \$5,500 from its private funds, which is included in the \$10,781.87 in trust funds, mentioned above. Other expenditures amounting to \$1,341.38, made from Washington, bring the total Smithsonian contribution from private funds to \$7,141.38.

The Smithsonian Institution further allotted \$18,000 from Government-appropriated funds, of which the sum of \$13,100 was expended for the new permanent building.

ACKNOWLEDGMENTS

We wish to express our appreciation for the whole-hearted cooperation of the various units of the Panama Canal and the Panama Railroad Co., to become united at the start of the new fiscal year as the Panama Canal Company, a corporation. We look forward to the same cordial relations with the new organization. We also wish to acknowledge especially the assistance of the Governor of the Panama Canal, Brig. Gen. F. K. Newcomer and his staff; Alton White and his Dredging Division; the various units of the Commissary Division; the Panama Railroad officials and employees; the Municipal Engineer; and Maj. George Herman, Chief of the Police Division and the able men under him. The police have cooperated regularly in the suppression of poaching, which is always a problem, though this trespass on the island is not so great as might be expected.

Respectfully submitted.

JAMES ZETEK, *Resident Manager.*

Dr. A. WETMORE,

Secretary, Smithsonian Institution.

APPENDIX 11

Report on the Library

SIR: I have the honor to submit the following report on the activities of the Smithsonian Library for the fiscal year ended June 30, 1951:

The 52,685 publications received in the library during the year came from 91 foreign countries, dominions, colonies, and protectorates, as well as from the United States. Access to this world-wide literary coverage of scientific and cultural progress in its own special subject fields, so important to the work of all branches of the Smithsonian Institution, is made possible largely by the cordial exchange relations maintained between the Institution and the academies and learned societies, the universities, museums, art galleries, observatories, and other scientific and cultural organizations both at home and abroad. This year 465 new exchanges were arranged, and 8,227 books, pamphlets, and periodical parts were received as the gratifying result of 576 special requests sent to issuing agencies for publications needed to fill gaps in our collections.

Although the larger number of the library's acquisitions were exchange publications, gifts were also numerous, and 9,552 volumes, pamphlets, and periodicals came from many generous friends both in and outside the Institution. The largest single gift of the year, a collection of some 500 books and periodicals on philately, presented by Malcolm Macgregor, of Bronxville, N. Y., is an especially noteworthy addition to the philatelic sectional library in the Department of History.

Most of the 2,111 volumes purchased during the year were recent publications, but a few were some of the older out-of-print works needed for reference in the Museum and the Bureau of American Ethnology, which fortunately came into the market at reasonable prices. Subscriptions for 348 periodicals not obtainable by exchange were also purchased.

The grand total of 19,016 publications transferred to the Library of Congress included 5,321 currently received volumes and periodicals recorded and marked as permanent additions to the Smithsonian Deposit there. Others were 1,526 doctoral dissertations mostly from foreign universities, and 12,169 documents and miscellaneous publications on subjects having no immediate bearing on the work of the Institution.

Noteworthy publications among the 3,859 transferred to other scientific libraries of the Government were 604 medical dissertations sent to the Army Medical Library.

Cataloging and entry of current accessions of books and periodicals were kept up, but with difficulty under the serious handicap of understaffing.

The number of volumes cataloged was 6,991, and 29,981 cards were filed in catalogs and shelflists. Periodical entries numbered 17,854.

There was little opportunity to continue the much-needed work of correlating and unifying entries in the periodical records with those in the catalog, but some progress was made in the last quarter toward completing this project.

An important piece of work completed by the staff was the checking of Smithsonian serial holdings for inclusion in the forthcoming Supplement to the Union List of Serials in Libraries of the United States and Canada, consisting mostly of new titles published in the years 1944-49. The library reported holdings of 473 of the titles listed in the checking edition, and added 19 new titles not appearing in the checklist. This cooperative undertaking on the part of the principal libraries of this country and Canada results in the continuation of one of the library's most useful and time-saving bibliographical tools.

Small withdrawals were frequently made from the collection of duplicates, and 2,415 pieces from among the titles specially wanted by participating libraries of the United States Book Exchange were sent to the stockpile at that center for exchange credit.

With funds allotted for binding, 1,250 volumes, mostly periodicals, were prepared for binding and sent to the Government Printing Office. In the Museum library, 1,300 old books and pamphlets, some of them irreplaceable, were repaired. There continues to be a large backlog of binding and repair.

The library's service to readers and research workers, both in and outside the Institution, its primary reason for being, is so full of intangibles that statistics of circulation and such other countable records as it is possible to keep, where there are so many decentralized units without immediate library supervision, can do little more than suggest the actual work and time required to produce the right publication or to answer a question accurately.

The reference use of the library was increasingly heavy in all its branches, and answers to 17,688 reference questions were given, many of them requiring hours of painstaking research among out-of-the-way sources.

Loan-desk records show that 11,869 publications were borrowed by members of the staff of the Institution and by 101 different Govern-

ment, university, and other libraries throughout the country to which 1,493 books and periodicals were sent as interlibrary loans.

The library, in turn, borrowed 1,398 books from the Library of Congress, many of which were Smithsonian Deposit copies, and 297 publications were borrowed from other libraries, chiefly from the Geological Survey, the Department of Agriculture, and the Army Medical Library.

Overcrowding and understaffing continue to be the library's most serious unsolved problems. To find shelf room for new books in stacks, branches, and sectional libraries already taxed beyond their normal capacity requires continuous contrivance of makeshift arrangements and rearrangements.

SUMMARIZED STATISTICS

Accessions

	<i>Volumes</i>	<i>Total recorded volumes June 30, 1951</i>
Astrophysical Observatory (including Radiation and Organisms).....	248	13, 821
Bureau of American Ethnology.....	123	34, 961
National Air Museum.....	84	210
National Collection of Fine Arts.....	280	12, 455
National Museum.....	3, 430	249, 831
National Zoological Park.....	3	4, 199
Smithsonian Deposit at the Library of Congress.....	1, 195	583, 475
Smithsonian Office.....	340	33, 788
Total.....	5, 703	932, 740

Neither incomplete volumes of serial publications, nor separates and reprints from serial publications are included in these figures.

Exchanges

New exchanges arranged.....	465
178 of these were assigned to the Smithsonian Deposit in the Library of Congress.	
Specially requested publications received.....	8, 227
991 of these were obtained to fill gaps in Smithsonian Deposit sets.	

Cataloging

Volumes and pamphlets cataloged.....	6, 992
Cards added to catalogs and shelflists.....	29, 981

Periodicals

Periodical parts entered.....	17, 854
-------------------------------	---------

Circulation

Loans of books and periodicals.....	11, 869
Circulation of books and periodicals in the sectional libraries of the Museum is not counted except in the Division of Insects.	

Binding

Volumes sent to the bindery-----	1,250
Volumes repaired in the Museum-----	1,300

Respectfully submitted.

LEILA F. CLARK, *Librarian.*

Dr. A. WETMORE,

Secretary, Smithsonian Institution.

APPENDIX 12

Report on Publications

SIR: I have the honor to submit the following report on the publications of the Smithsonian Institution and its branches for the year ended June 30, 1951:

The Institution published during the year 6 papers in the Smithsonian Miscellaneous Collections, 1 Annual Report of the Board of Regents and pamphlet copies of 16 articles in the Report appendix, 1 Annual Report of the Secretary, and 2 special publications.

The United States National Museum issued 1 Annual Report, 19 Proceedings papers, 4 Bulletins, and 2 Contributions from the United States National Herbarium.

The Bureau of American Ethnology issued 1 Annual Report, 2 Bulletins, and 2 Publications of the Institute of Social Anthropology.

The Freer Gallery of Art issued 2 Occasional Papers and 2 special publications.

Of the publications there were distributed 123,401 copies, which included 8 volumes and separates of Smithsonian Contributions to Knowledge, 13,237 volumes and separates of Smithsonian Miscellaneous Collections, 21,972 volumes and separates of Smithsonian Annual Reports, 2,907 War Background Studies, 4,829 Smithsonian special publications, 31 reports and 190 sets of pictures of the Harriman Alaska Expedition, 52,876 volumes and separates of National Museum publications, 16,560 publications of the Bureau of American Ethnology, 5,817 publications of the Institute of Social Anthropology, 26 catalogs of the National Collection of Fine Arts, 1,985 volumes and pamphlets of the Freer Gallery of Art, 8 Annals of the Astrophysical Observatory, 2,452 reports of the American Historical Association, and 503 miscellaneous publications not published by the Smithsonian Institution (mostly Survival Manuals).

In addition, 28,427 picture pamphlets, 76,193 guide books, 24,566 natural-history and art post cards, 29,342 sets of photo cards and picture post cards, 46 sets of North American Wild Flowers, and 6 volumes of Pitcher Plants were distributed.

SMITHSONIAN MISCELLANEOUS COLLECTIONS

In this series there were issued 1 paper in volume 111 and title page and table of contents to the volume, and 4 papers in volume 116, as follows:

VOLUME 111

- No. 18. Tree growth and rainfall—a study of correlation and methods, by **Waldo S. Glock**. 47 pp., 7 figs. (Publ. 4016.) Oct. 25, 1950.
 Title page and table of contents. (Publ. 4023.) Dec. 18, 1950.

VOLUME 116

- No. 1. Comparative studies on the jaws of mandibulate arthropods, by **R. E. Snodgrass**. 85 pp., 25 figs. (Publ. 4018.) Nov. 16, 1950.
 No. 2. Remains of land mammals from the Miocene of the Chesapeake Bay region, by **C. Lewis Gazin** and **R. Lee Collins**. 21 pp., 7 figs. (Publ. 4019.) Oct. 12, 1950.
 No. 4. Precipitation and temperature in Washington, D. C., for 1950 and 1951, by **C. G. Abbot**. 6 pp., 2 figs. (Publ. 4045.) Mar. 1, 1951.
 No. 6. A new species of the Jurassic brachiopod genus *Septirhynchia*, by **Helen M. Muir-Wood** and **G. Arthur Cooper**. 6 pp., 2 pls. (Publ. 4047.) June 5, 1951.

SMITHSONIAN ANNUAL REPORT

Report for 1949.—The complete volume of the Annual Report of the Board of Regents for 1949 was received from the Public Printer on August 24, 1950:

Annual Report of the Board of Regents of the Smithsonian Institution showing the operations, expenditures, and condition of the Institution for the year ended June 30, 1949. ix+422 pp., 82 pls., 24 figs. (Publ. 3996.)

The general appendix contained the following papers (Publs. 3997–4012):

- The formation of stars, by **Lyman Spitzer, Jr.**
 The origin of the earth, by **Thornton Page**.
 The 200-inch Hale telescope and some problems it may solve, by **Edwin Hubble**.
 The determination of precise time, by **Sir Harold Spencer Jones**.
 The elementary particles of physics, by **Carl D. Anderson**.
 Recent advances in virus research, by **Wendell M. Stanley**.
 Ground-water investigations in the United States, by **A. N. Sayre**.
 Modern soil science, by **Charles E. Kellogg**.
 Time in evolution, by **F. E. Zeuner**.
 More about animal behavior, by **Ernest P. Walker**.
 The breeding habits of weaverbirds: a study in the biology of behavior patterns, by **Herbert Friedmann**.
 New Zealand, a botanist's paradise, by **Egbert H. Walker**.
 The archeological importance of Guatemala, by **A. V. Kidder**.
 Excavations at the prehistoric rock-shelter of La Colombière, by **Hallam L. Movius, Jr.**
 Ronne Antarctic research expedition, 1946–1948, by **Commander Finn Ronne**.
 The state of science, by **Karl T. Compton**.

Report for 1950.—The Report of the Secretary, which included the financial report of the executive committee of the Board of Regents, and which will form part of the Annual Report of the Board of Regents to Congress, was issued January 8, 1951:

Report of the Secretary of the Smithsonian Institution and financial report of the executive committee of the Board of Regents for the year ended June 30, 1950. ix+161 pp., 2 pls. (Publ. 4020.)

SPECIAL PUBLICATIONS

Brief guide to the Smithsonian Institution. 8th edition. 80 pp., illus. [Mar. 1, 1951.]

The Smithsonian Institution: A description of its work. 166 pp. January 1951.

PUBLICATIONS OF THE UNITED STATES NATIONAL MUSEUM

John S. Lea was appointed editor of the National Museum on November 13, 1950. The Museum issued during the year 1 Annual Report, 19 Proceedings papers, 4 Bulletins, and 2 papers in the Contributions from the United States National Herbarium, as follows:

ANNUAL REPORT

Report on the progress and condition of the United States National Museum for the year ended June 30, 1950. iii+141 pp. Jan. 10, 1951.

PROCEEDINGS: VOLUME 98

Title page, table of contents, list of illustrations, and index. Pp. i-xi, 523-553. Apr. 17, 1951.

PROCEEDINGS: VOLUME 100

No. 3269. Some new gastropods of the family Clausiliidae from the Philippine Islands and Siam, by F. J. Loosjes. Pp. 539-545, figs. 51-53. Nov. 13, 1950.

No. 3270. Three new species of fishes of the genus *Cirrhitus* (family Cirrhitidae) from the Indo-Pacific, by Leonard P. Schultz. Pp. 547-552, pl. 13. July 25, 1950.

PROCEEDINGS: VOLUME 101

No. 3271. A revision of the beetles of the genus *Myochrous*, by Doris Holmes Blake. Pp. 1-64, pls. 1-8. Dec. 27, 1950.

No. 3272. The oceanic crabs of the genera *Planes* and *Pachygrapsus*, by Fenner A. Chace, Jr. Pp. 65-103, figs. 1-8. Jan. 30, 1951.

No. 3273. New marine isopods, chiefly from northern California, with notes on related forms, by Robert J. Menzies. Pp. 105-156, figs. 9-33. Feb. 13, 1951.

No. 3274. The helminth parasites of birds, III: Dicrocoeliid trematodes from North American birds, by J. Fred Denton and Elon E. Byrd. Pp. 157-202, figs. 34-40. Mar. 6, 1951.

No. 3275. The mites of the subfamily Haemogamasinae (Acari: Laelaptidae), by Hugh L. Keegan. Pp. 203-268, figs. 41-55. Feb. 2, 1951.

No. 3276. A new Caribbean coral of the genus *Chrysogorgia*, by Frederick M. Bayer. Pp. 269-273, figs. 56, 57, pl. 9. Feb. 13, 1951.

No. 3277. Revision of the North American grasshoppers of the *Conalcaea* complex, by Ashley B. Gurney. Pp. 275-304, figs. 58-65, pls. 10, 11. Feb. 2, 1951.

No. 3278. Fleas from the Upper Sonoran zone near Albuquerque, N. Mex., by Lelia Ann Williams and C. Clayton Hoff. Pp. 305-313, fig. 66. Jan. 22, 1951.

No. 3279. Some digenetic trematodes, including eight new species, from ma-

rine fishes of La Jolla, Calif., by Harold W. Manter and Harley J. Van Cleave. Pp. 315-340, pls. 12, 13. Mar. 28, 1951.

No. 3280. Parasitic Crustacea from Bimini, Bahamas, by A. S. Pearse. Pp. 341-372, figs. 67-77. Feb. 2, 1951.

No. 3281. New and little-known bees of the family Andrenidae from California, by P. H. Timberlake. Pp. 373-414. Apr. 23, 1951.

No. 3282. The actinian fauna of the Gulf of California, by Oskar Carlgren. Pp. 415-449, figs. 78-84, pl. 14. May 17, 1951.

No. 3283. Notes on chrysomelid beetles of the subfamily Chlamisinae, with descriptions of new species, by F. Monrós. Pp. 451-463, figs. 85-90. June 5, 1951.

No. 3284. Notes on a herpetological collection from Oaxaca and other localities in Mexico, by Frederick A. Shannon. Pp. 465-484, figs. 91-93. May 17, 1951.

No. 3285. *Chaetodon tinkeri*, a new species of butterflyfish (Chaetodontidae) from the Hawaiian Islands, by Leonard P. Schultz. Pp. 485-488, fig. 94, pl. 15. June 15, 1951.

No. 3286. Moths of the genus *Paramulona* Hampson, by William D. Field. Pp. 489-496, figs. 95-96. May 17, 1951.

BULLETINS

50, part 11. Birds of North and Middle America. Families Cathartidae, Accipitridae, Pandionidae, Falconidae, by Herbert Friedmann. Pp. i-xiii, 1-793, 51 figs. Sept. 29, 1950.

82. A monograph of the existing crinoids. Volume 1, The comatulids. Part 4c.—Superfamily Tropiometrida (the families Thalassometridae and Charitometridae), by Austin Hobart Clark. Pp. i-vi, 1-383, 32 pls. Aug. 16, 1950.

100, volume 14, part 4. Copepods gathered by the United States fisheries steamer *Albatross* from 1887 to 1909, chiefly in the Pacific Ocean, by Charles Branch Wilson. Pp. i-ix, 141-441, pls. 2-36. Oct. 17, 1950.

199. An annotated checklist and key to the reptiles of Mexico exclusive of the snakes, by Hobart M. Smith and Edward H. Taylor. Pp. 1-v, 1-253. Oct. 16, 1950.

CONTRIBUTIONS FROM THE UNITED STATES NATIONAL HERBARIUM

VOLUME 29

Part 10. Studies in the Bromeliaceae, XVI, by Lyman B. Smith. Pp. i-viii, 429-520, figs. 37-76. June 20, 1951.

VOLUME 31

Part 1. The Acanthaceae of Colombia, I, by Emery C. Leonard. Pp. i-vi, 1-117, figs. 1-40. June 8, 1951.

PUBLICATIONS OF THE BUREAU OF AMERICAN ETHNOLOGY

The editorial work of the Bureau continued under the immediate direction of the editor, M. Helen Palmer. During the year there were issued 1 Annual Report, 2 Bulletins, and 2 Publications of the Institute of Social Anthropology, as follows:

ANNUAL REPORT

Sixty-seventh Annual Report of the Bureau of American Ethnology, 1949-50. ii+25 pp. 1951.

BULLETINS

143. Handbook of South American Indians. Julian H. Steward, editor. Volume 6, Physical anthropology, linguistics, and cultural geography of South American Indians. xiii+715 pp., 47 pls., 3 figs., 18 maps. 1950.

144. The northern and central Nootkan tribes, by Philip Drucker. ix+480 pp., 5 pls., 28 figs., 8 maps. 1951.

PUBLICATIONS OF THE INSTITUTE OF SOCIAL ANTHROPOLOGY

No. 11. Quiroga: A Mexican municipio, by Donald D. Brand, assisted by José Corona Núñez. v+242 pp., 35 pls., 4 maps. 1951.

No. 12. Cruz das Almas: A Brazilian village, by Donald Pierson, with the assistance of Levi Cruz, Mirtes Brandão Lopes, Helen Batchelor Pierson, Carlos Borges Teixeira, and others. x+226 pp., 20 pls., 13 figs., 2 maps. 1951.

PUBLICATIONS OF THE FREER GALLERY OF ART

OCCASIONAL PAPERS: VOLUME 1

No. 2. Studies in Muslim Iconography. I. The unicorn, by Richard Ettinghausen. 209 pp., 49 pls., 5 figs. (Publ. 3993.) [Sept. 13], 1950.

No. 5. A royal head from ancient Egypt, by George Steindorff. 30 pp., 29 pls. (Publ. 4022.) [Feb. 23], 1951.

SPECIAL PUBLICATIONS

The Peacock Room. 22 pp., 8 pls. (Publ. 4024.) [Apr. 24], 1951.

The Freer Gallery of Art of the Smithsonian Institution. 16 pp., illus. [Sept. 5], 1950.

REPORT OF THE AMERICAN HISTORICAL ASSOCIATION

The annual reports of the American Historical Association are transmitted by the Association to the Secretary of the Smithsonian Institution and are by him communicated to Congress, as provided by the act of incorporation of the Association. The following report volume was issued this year:

Annual Report of the American Historical Association for 1949. Vol. 1, Proceedings (including list of members). [Feb. 23], 1951.

REPORT OF THE NATIONAL SOCIETY, DAUGHTERS OF THE AMERICAN REVOLUTION

The manuscript of the Fifty-third Annual Report of the National Society, Daughters of the American Revolution, was transmitted to Congress, in accordance with law, February 16, 1951.

APPROPRIATION FOR PRINTING AND BINDING

The congressional appropriation for printing and binding for the past year was entirely obligated at the close of the year. The appropriation for the coming fiscal year ending June 30, 1952, totals \$103,000, allotted as follows:

General administration (Annual Report of the Board of Regents; Annual Report of the Secretary)-----	\$18,500
National Museum-----	41,700
Bureau of American Ethnology-----	16,000
National Air Museum-----	500
Service divisions (Annual Report of the American Historical Association; blank forms; binding; Museum print shop)-----	26,300
Total -----	103,000

Respectfully submitted.

PAUL H. OEHISER, *Chief, Editorial Division.*

Dr. A. WETMORE,

Secretary, Smithsonian Institution.

Report of the Executive Committee of the Board of Regents of the Smithsonian Institution

For the Year Ended June 30, 1951

To the Board of Regents of the Smithsonian Institution:

Your executive committee respectively submits the following report in relation to the funds of the Smithsonian Institution, together with a statement of the appropriations by Congress for the Government bureaus in the administrative charge of the Institution.

SMITHSONIAN ENDOWMENT FUND

The original bequest of James Smithson was £104,960 8s. 6d.—\$508,318.46. Refunds of money expended in prosecution of the claim, freights, insurance, and other incidental expenses, together with payment into the fund of the sum of £5,015, which had been withheld during the lifetime of Madame de la Batut, brought the fund to the amount of \$550,000.

Since the original bequest, the Institution has received gifts from various sources, the income from which may be used for the general work of the Institution. These, including the original bequest, plus savings, are listed below, together with the income for the present year.

ENDOWMENT FUNDS

(Income for the unrestricted use of the Institution)

Partly deposited in the United States Treasury at 6 percent and partly invested in stocks, bonds, and other holdings

Fund	Investment	Income present year
Parent fund (original Smithson bequest, plus accumulated savings).....	\$728,892.35	\$43,723.84
Subsequent bequests, gifts, and other funds, partly deposited in the U. S. Treasury and partly invested in the consolidated fund:		
Avery, Robert S., and Lydia, bequest fund.....	54,519.88	2,957.51
Endowment fund.....	357,056.42	18,143.43
Habel, Dr. S., bequest fund.....	500.00	30.00
Hachenberg, George P. and Caroline, bequest fund.....	4,125.69	215.60
Hamilton, James, bequest fund.....	2,914.11	171.64
Henry, Caroline, bequest fund.....	1,240.69	64.84
Hodgkins, Thomas G. (general gift).....	146,757.84	8,567.35
Porter, Henry Kirke, memorial fund.....	293,703.61	15,353.23
Rhees, William Jones, bequest fund.....	1,075.30	60.80
Sanford, George H., memorial fund.....	2,013.22	113.72
Witherspoon, Thomas A., memorial fund.....	132,384.70	6,918.23
Special fund, stock in reorganized closed banks.....	2,280.00	160.00
Total.....	998,661.46	52,756.35
Grand total.....	1,727,553.81	96,480.19

The Institution holds also a number of endowment gifts, the income of each being restricted to specific use. These, plus accretions to date, are listed below, together with income for the present year.

Fund	Investment	Income present year
Abbott, William L., fund, for investigations in biology	\$102,000.03	\$5,454.18
Arthur, James, fund, for investigations and study of the sun and annual lecture on same	41,026.74	2,128.28
Bacon, Virginia Purdy, fund, for traveling scholarship to investigate fauna of countries other than the United States	51,395.43	2,696.19
Baird, Lucy H., fund, for creating a memorial to Secretary Baird	24,698.96	1,281.28
Barney, Alice Pike, memorial fund, for collecting of paintings and pastels and for encouragement of American artistic endeavor	15,003.00	194.68
Barstow, Frederick D., fund, for purchase of animals for National Zoological Park	1,025.61	53.24
Canfield Collection fund, for increase and care of the Canfield collection of minerals	39,235.36	2,035.36
Casey, Thomas L., fund, for maintenance of the Casey collection and promotion of researches relating to Coleoptera	10,409.93	540.03
Chamberlain, Francis Lea, fund, for increase and promotion of Isaac Lea collection of gems and mollusks	28,888.18	1,498.58
Eickemeyer, Florence Brevoort, fund, for preservation and exhibition of the photographic collection of Rudolph Eickemeyer, Jr.	11,005.19	570.90
Hillyer, Virgil, fund, for increase and care of Virgil Hillyer collection of lighting objects	6,742.03	349.75
Hitchcock, Albert S., library fund, for care of the Hitchcock Agrostological Library	1,618.69	83.98
Hodgkins fund, specific, for increase and diffusion of more exact knowledge in regard to nature and properties of atmospheric air	100,000.00	6,000.00
Hrdlička, Aleš and Marie, fund, to further researches in physical anthropology and publication in connection therewith	29,507.97	1,454.72
Hughes, Bruce, fund, to found Hughes alcove	19,635.92	1,018.64
Long, Annette and Edith C., fund, for upkeep and preservation of Long collection of embroideries, laces, and textiles	557.02	28.92
Maxwell, Mary E., fund, for care and exhibition of Maxwell collection	20,121.36	1,043.81
Myer, Catherine Walden, fund, for purchase of first class works of art for use and benefit of the National Collection of Fine Arts	19,445.54	1,008.75
Pell, Cornelia Livingston, fund, for maintenance of Alfred Duane Pell collection	7,604.00	394.47
Poore, Lucy T. and George W., fund, for general use of the Institution when principal amounts to \$250,000	133,628.36	6,873.21
Rathbun, Richard, memorial fund, for use of division of U. S. National Museum containing Crustacea	10,910.80	565.99
Reid, Addison T., fund, for founding chair in biology, in memory of Asher Tunis	30,428.58	1,659.43
Roebling Collection fund, for care, improvement, and increase of Roebling collection of minerals	123,806.84	6,422.58
Rollins, Miriam and William, fund, for investigations in physics and chemistry	96,323.74	5,002.23
Smithsonian employees' retirement fund	31,068.11	1,709.97
Springer, Frank, fund, for care and increase of Springer collection and library	18,396.23	954.32
Strong, Julia D., bequest fund, for benefit of the National Collection of Fine Arts	10,256.81	532.08
Walcott, Charles D. and Mary Vaux, research fund, for development of geological and paleontological studies and publishing results thereof	379,146.59	21,055.94
Younger, Helen Walcott, fund, held in trust	46,611.40	3,061.10
Zerbee, Frances Brinckle, fund, for endowment of aquaria	973.07	50.48
Total	1,411,471.49	75,693.09

FREER GALLERY OF ART FUND

Early in 1906, by deed of gift, Charles L. Freer, of Detroit, gave to the Institution his collection of Chinese and other Oriental objects of art, as well as paintings, etchings, and other works of art by Whistler, Thayer, Dewing, and other artists. Later he also gave funds for construction of a building to house the collection, and finally in his will, probated November 6, 1919, he provided stock and securities to the estimated value of \$1,958,591.42, as an endowment fund for the operation of the Gallery.

The above fund of Mr. Freer was almost entirely represented by 20,465 shares of stock in Parke, Davis & Co. As this stock advanced in value, much of it was sold and the proceeds reinvested so that the fund now amounts to \$6,613,510.49 in selected securities.

SUMMARY OF ENDOWMENTS

Invested endowment for general purposes.....	\$1, 727, 553. 81
Invested endowment for specific purposes other than Freer endowment.....	1, 411, 471. 49
Total invested endowment other than Freer endowment..	3, 139, 025. 30
Freer invested endowment for specific purposes.....	6, 613, 510. 49
Total invested endowment for all purposes.....	9, 752, 535. 79

CLASSIFICATION OF INVESTMENTS

Deposited in the U. S. Treasury at 6 percent per annum, as authorized in the U. S. Revised Statutes, sec. 5591.....	\$1, 000, 000. 00
Investments other than Freer endowment (cost or market value at date acquired):	
Bonds.....	\$753, 835. 36
Stocks.....	1, 331, 894. 91
Real estate and first-mortgage notes.....	15, 735. 87
Uninvested capital.....	37, 559. 16
	2, 139, 025. 30
Total investments other than Freer endowment.....	3, 139, 025. 30
Investments of Freer endowment (cost or market value at date acquired):	
Bonds.....	\$3, 771, 391. 04
Stocks.....	2, 744, 854. 10
Uninvested capital.....	97, 265. 35
	6, 613, 510. 49
Total investments.....	9, 752, 535. 79

CASH BALANCES, RECEIPTS, AND DISBURSEMENTS DURING FISCAL YEAR 1951¹

Cash balance on hand June 30, 1950.....	\$379, 650. 13
Receipts, other than Freer endowment:	
Income from investments.....	\$181, 228. 23
Gifts and contributions.....	105, 577. 76
Sales of publications.....	54, 417. 31
Miscellaneous.....	7, 929. 79
Proceeds from real-estate holdings.....	31, 780. 02
U. S. Government and other contracts (net).....	11, 156. 48
Payroll withholdings and refunds of advances (net).....	2, 409. 60
Total receipts other than Freer endowment.....	394, 499. 19

¹ This statement does not include Government appropriations under the administrative charge of the Institution.

Receipts from Freer endowment:

Purchase and sale of securities.....	\$69, 513. 78
Income from investments.....	307, 957. 19
Other receipts.....	3, 236. 03

Total receipts from Freer endowment..... \$380, 707. 00

Total..... 1, 154, 856. 32

Disbursements other than Freer endowment:

Administration.....	\$64, 209. 68
Publications.....	17, 624. 45
Library.....	542. 40
Custodian fees and similar incidentals.....	3, 000. 32
Miscellaneous.....	1, 808. 52
Researches.....	140, 267. 09
S. I. Retirement System.....	3, 617. 40
Purchase and sale of securities (net).....	85, 079. 40

Total disbursements other than Freer endowment..... 316, 149. 26

Disbursements from Freer endowment:

Salaries.....	\$92, 049. 03
Purchases for collections.....	158, 600. 00
Custodian fees and similar incidentals.....	12, 081. 06
Miscellaneous.....	39, 021. 19

Total disbursements from Freer endowment..... 301, 751. 28

Investment of current funds in U. S. bonds..... 746. 76

Total disbursements..... 618, 647. 30

Cash balance June 30, 1951..... 536, 209. 02

Total..... 1, 154, 856. 32

ASSETS

Cash:

United States Treasury current account.....	\$407, 159. 91
In banks and on hand.....	129, 049. 11

536, 209. 02

Less uninvested endowment funds..... 134, 824. 51

\$401, 384. 51

Travel and other advances..... 11, 798. 34

Cash invested (U. S. Treasury notes)..... 600, 778. 01

\$1, 013, 60. 866

Investments—at book value:

Endowment funds:

Freer Gallery of Art:

Stocks and bonds..	\$6, 516, 245. 14
Uninvested capital..	97, 265. 35

6, 613, 510. 49

Investments at book value other than Freer:

Stocks and bonds.....	\$2,085,730.27	
Real-estate and mortgage notes.....	15,735.87	
Uninvested capital.....	37,559.16	
Special deposit in U. S. Treasury at 6 percent interest.....	1,000,000.00	
	<u>3,139,025.30</u>	\$9,752,535.79
		<u>10,766,496.65</u>

UNEXPENDED FUNDS AND ENDOWMENTS

Unexpended funds:

Income from Freer Gallery of Art endowment.....		\$411,474.66
Income from other endowments:		
Restricted.....	\$206,749.64	
General.....	124,014.09	
	<u>330,763.73</u>	
Gifts and grants.....		271,722.47
		<u>1,013,960.86</u>

Endowment funds:

Freer Gallery of Art.....	\$6,613,510.49	
Other:		
Restricted.....	\$1,411,471.49	
General.....	1,727,553.81	
	<u>3,139,025.30</u>	9,752,535.79
		<u>10,766,496.65</u>

The practice of maintaining savings accounts in several of the Washington banks and trust companies has been continued during the past year, and interest on those deposits amounted to \$637.64.

In many instances, deposits are made in banks for convenience in collection of checks, and later such funds are withdrawn and deposited in the United States Treasury. Disbursement of funds is made by check signed by the Secretary of the Institution and drawn on the United States Treasury.

The foregoing report relates only to the private funds of the Institution.

The Institution gratefully acknowledges gifts from the following:

Laura D. Barney, to establish Alice Pike Barney Memorial Fund, for the maintenance and increase of the Alice Pike Barney collection of paintings and pastels and for the encouragement of American artistic endeavor.

Estate of George H. Stephenson, for securing bust of Brig. Gen. William L. Mitchell.

National Geographic Society, additional funds for expedition to western Panamá.
Neosho Grant, for Research in Material Culture, to be used for describing and analyzing Blackfoot ceremonial objects in the Denver Art Museum and to obtain additional data from the Indians on the Blood Reservation in Alberta, Canada.

Research Corporation, to cover costs of publication of an edition of the Spenceley 23-place logarithmic tables.

Rockefeller Foundation, Institute of Social Anthropology—São Paulo Fund, toward support of the Institution's joint program with the Escola Livre de Sociologia e Política de São Paulo, in research, training, publications, and translations in the social sciences.

Rockefeller Foundation, for mounting mites on slides for classification and filing.

The following appropriations were made by Congress for the Government bureaus under the administrative charge of the Smithsonian Institution for the fiscal year 1951:

Salaries and expenses.....	\$2, 700,000. 00
National Zoological Park.....	634, 000. 00

In addition, funds were transferred from other departments of the Government for expenditure under the direction of the Smithsonian Institution as follows:

International Information and Educational Activities (transferred to the Smithsonian Institution from the State Department).....	\$92, 740. 00
Working Fund, transferred from the National Park Service, Interior Department, for archeological investigations in river basins throughout the United States.....	174, 375. 00

The Institution also administers a trust fund for partial support of the Canal Zone Biological Area, located on Barro Colorado Island in the Canal Zone.

The report of the audit of the Smithsonian private funds follows:

WASHINGTON, D. C., *September 7, 1951*

TO THE BOARD OF REGENTS,

SMITHSONIAN INSTITUTION,

Washington 25, D. C.

We have examined the accounts of the Smithsonian Institution relative to its private endowment funds and gifts (but excluding the National Gallery of Art and other departments, bureaus or operations administered by the Institution under Federal appropriations) for the year ended June 30, 1951. Our examination was made in accordance with generally accepted auditing standards, and accordingly included such tests of the accounting records and such other auditing procedures as we considered necessary in the circumstances.

The Institution maintains its accounts on a cash basis and does not accrue income and expenses. Land, buildings, furniture, equipment, works of art, living and other specimens and certain sundry property are not included in the accounts of the Institution.

In our opinion, the accompanying financial statements present fairly the position of the private funds and the cash investments thereof of the Smithsonian Institution at June 30, 1951 (excluding the National Gallery of Art and other

departments, bureaus or operations administered by the Institution under the Federal appropriations) and the cash receipts and disbursements for the year ended, in conformity with generally accepted accounting principles applied on a basis consistent with that of the preceding year.

Respectfully submitted.

PEAT, MARWICK, MITCHELL & Co.

ROBERT V. FLEMING,
VANNEVAR BUSH,
CLARENCE CANNON,
Executive Committee.

GENERAL APPENDIX
to the
SMITHSONIAN REPORT FOR 1951

ADVERTISEMENT

The object of the **GENERAL APPENDIX** to the Annual Report of the Smithsonian Institution is to furnish brief accounts of scientific discovery in particular directions; reports of investigations made by staff members and collaborators of the Institution; and memoirs of a general character or on special topics that are of interest or value to the numerous correspondents of the Institution.

It has been a prominent object of the Board of Regents of the Smithsonian Institution from a very early date to enrich the annual report required of them by law with memoirs illustrating the more remarkable and important developments in physical and biological discovery, as well as showing the general character of the operations of the Institution; and, during the greater part of its history, this purpose has been carried out largely by the publication of such papers as would possess an interest to all attracted by scientific progress.

In 1880, induced in part by the discontinuance of an annual summary of progress which for 30 years previously had been issued by well-known private publishing firms, the Secretary had a series of abstracts prepared by competent collaborators, showing concisely the prominent features of recent scientific progress in astronomy, geology, meteorology, physics, chemistry, mineralogy, botany, zoology, and anthropology. This latter plan was continued, though not altogether satisfactorily, down to and including the year 1888.

In the report of 1889, a return was made to the earlier method of presenting a miscellaneous selection of papers (some of them original) embracing a considerable range of scientific investigation and discussion. This method has been continued in the present report for 1951.

Stormy Weather on the Sun¹

By WALTER ORR ROBERTS

Superintendent of the High Altitude Observatory, Boulder, Colo.

[With 2 plates]

ASTRONOMY has come a long way from the heyday of ancient Greece when Socrates admonished the astronomers to stick to their proper business, the calendar, and advised them that "speculators on the universe and on the laws of heavenly bodies are no better than madmen." Instruments to observe the sun, likewise, have progressed far beyond the simple pinhole viewer with which Fabricius watched the sunspots.

But for all our progress, the sun worries us yet with the many unsolved riddles of its behavior. We no longer hold, with Aristotle, that the sun and moon are living beings. But we are still at a loss to explain many features of its behavior, such as the fact that the sun's equator rotates faster than its higher latitudes.

To solve these diverse problems, many of our greatest astronomers from Galileo's day to the present have devoted major portions of their scientific careers to the study of the sun and the features of its atmosphere. The growth of our knowledge has been vastly encouraged by such people as C. G. Abbot of the Smithsonian Institution, G. E. Hale of Mount Wilson Observatory, Father Secchi of the Vatican, Sir Norman Lockyer, Robert R. McMath, L. d'Azambuja, C. E. Saint-John, Bernard Lyot, and many others. And in the course of their work astronomers have given the name of the sun to a whole class of new astronomical instruments, such as helioscopes, pyrheliometers, spectroheliographs, heliometers, heliostats, coronagraphs. As the years pass, increasingly powerful tools of modern science are brought to bear upon the sun. And the riddles of its behavior are gradually yielding to analysis.

The clues to a great number of the mysteries of solar behavior seem to be locked up in the sun's atmosphere—in the phenomena that become spectacularly visible during total solar eclipse. And it is

¹ Eighteenth James Arthur lecture, given under the auspices of the Smithsonian Institution on March 22, 1951.

for this reason that astronomers trek to distant parts of the globe from solar eclipse to solar eclipse, and from year to year. From time immemorial eclipses have interested men. In ancient times they were greeted by mystic rites, and engendered fear and uncertainty in the people visited by them.

As with the products of modern science, the results of the ancient science of eclipse prediction gave to its users information of vast political significance. And so it was, according to Prof. S. A. Mitchell in his book *Eclipses of the Sun*, that an ancient Chinese imperial edict charged the court astronomers with the responsibility for predicting all solar eclipses. It appears, however, that in approximately 2000 B. C. the astronomers Hsi and Ho let their calendars fall into disorder, became dead drunk, and then were caught unawares by the occurrence of a solar eclipse. For this it seems that the unfortunate royal astronomers were put to death. Modern astronomers, happily, have an easier time. They predict their eclipses with automatic calculators, and, furthermore, have devised many types of astronomical instruments with which to observe the eclipse features of the sun by artificial means.

At a total eclipse, features of the sun that are normally invisible show up spectacularly. By extensive study of these eclipse features, modern astronomers are making great progress in attacking the unsolved problems of the sun. But let me turn first to a discussion of some of the basic facts about the sun.

The sun interests astronomers particularly because it is the nearest star to earth. It is the only star close enough for them to study in great detail. All other stars in the sky appear as mere pinpoints of light, even in the most powerful telescopes. But on the sun, individual features are readily distinguishable, and we can gain a relatively intimate view of what goes on in a rather typical star.

As far as we on earth are concerned, the sun is distinguished primarily by proximity. By comparison with the other stars, it is a rather undistinguished body. It is neither extremely large nor strikingly small. It is midway within our realm of experience as to brightness, color, chemical composition, and many other characteristics. Fortunately for us it is also a very stable star, not partaking of the violent excursions that characterize some of the stars we have studied in detail. The sun is a mere 93 million miles away. The nearest other star we know of is more than 200,000 times farther from us. Its proximity makes the sun by far the most important source of energy available to man. This tremendous available reserve of heat, light, and other radiations provides a climate and environment favorable for life as we know it here on the earth.

The sun is an enormously large sphere of gas. Nowhere within it do we know of solids or liquids. Its diameter is approximately 864,000 miles. The visible surface or "photosphere" glows with an intense yellow-white light. The temperature of the photosphere, according to several independent methods of estimation, is about $6,000^{\circ}$ K. (centigrade absolute). But as you go down toward the center of the enormous sphere of gas, the temperature mounts rapidly; probably near the center it reaches values as high as $25,000,000^{\circ}$ K. There near the nucleus the pressures reach perhaps to tens of millions of tons per square inch, and the gaseous material is compressed till its density is probably more than 10 times that of a bar of iron. Our knowledge of the interior conditions depends upon theoretical researches of the very highest quality carried out by such people as Lane, Eddington, Jeans, Russell, and Chandrasekhar, just to mention a few of the many who have worked profitably in this field of analysis. It is here in the depths that the atomic energy derived from nuclear fusion supplies the sun with its heat. It is here in the depths that the fuel hydrogen is "burned" by atomic fusion, leaving the ash, helium, as the end product.

Lying directly on the surface, and cooled by processes as yet not fully understood, are the giant sunspots. These huge, dark, irregular spots fluctuate in size and number with the also-mysterious 11-year solar cycle. They are the focus of extensive and intense magnetic fields from which are emitted potent corpuscular streams that fly out into space. Perhaps even cosmic rays are born in or near these giant blemishes on the sun's smooth face.

The transition layer between the spotted surface of the sun and the solar atmosphere has many interesting properties. It may seem queer that a body like the sun, which is entirely gaseous, can have a sharply defined edge, so that it shows up in a telescope just as clearly as though it were the edge of the moon. Yet this is the way the edge of the sun looks. The theory of this behavior and of the rapid transitions of the opacity of the sun's gases near the surface layers has been studied by many investigators, including E. A. Milne of England, who recently died after a brilliant and useful scientific career. At the edge of the sun, a mere 20 miles or so carries us from regions where the gases are nearly opaque out to the tenuous and transparent gases that characterize the solar atmosphere. This short distance carries us from the dense regions, where the spectrum of the sun consists of a continuum of light of all colors, out to the region where the gases show the bright line spectrum that is characteristic of tenuous gases. Much of the success of modern solar astrophysics depends upon observations of the spectrum lines of the nearly transparent atmosphere, and also of the absorption spectrum formed just above the opaque surface of the sun by the rela-

tively cool gases of the transitional layer to which we ascribe the term "reversing layer."

It is the transparent gaseous region above the opaque photospheric surface that shows so spectacularly at eclipses. The radiating gases of this zone, shining both by faint continuous light and by intense monochromatic light, form one of the principal realms of study for modern astrophysical devices, and comprise the objective of most of the work of astronomers who travel to distant lands to be present at the brief moments of total eclipse.

The intercession of the moon between the earth and the sun at a total eclipse gives us a unique opportunity to observe the faint atmospheric gases above the sun without the overpoweringly distracting effects of the light of the photosphere. Normally, the light from the face of the sun so intensely illuminates the atmosphere of the earth that the gases above the surface of the sun make no impression at all upon our viewing instruments. But at eclipse we are unhindered by this normal handicap, and are able to take photographs and spectrograms that reveal the very remarkable characteristics of the sun's atmosphere.

The very transparency of the atmosphere makes it accessible to study. We can see through it, and thus we can study what goes on in it. By virtue of the fact that its light is radiated, for the most part, in discrete lines of the spectrum, we can study any one constituent of its gaseous atmosphere quite independently from the others. The interior workings of the sun are screened off from view by the very opacity of the photosphere of the sun, so that we cannot glimpse beneath the superficial markings of the sunspots and the other surface features, such as the faculae, and the granulations. To be sure, we study the surface markings in all possible detail, and have learned many remarkable things from these studies—as, for example, the completely unexplained equatorial acceleration discovered many years ago by the English astronomer Carrington. This baffling acceleration causes the sun's equator to turn a full revolution in a shorter time than do the higher solar latitudes. People in the path of a total eclipse become acutely aware in the final minutes before totality of the rapid diminution of the brightness of the sunlight illuminating the landscape. But the truly spectacular phenomena do not appear until the final climax, known technically as "second contact," when the moon finally cuts out all the light from the photosphere, leaving only the atmosphere in view. The first thing that one sees is the striking effect of the "Baily's Beads," which result from the tiny portions of the bright photosphere that shine through the depressions of the moon's surface where there are craters with low areas in the line of sight. Then immediately following comes the brilliant "chromospheric flash."

This brilliant flash of light was first described in detail by a Captain Stannyan, who traveled to an eclipse in Berne, Switzerland, around the year 1700. For some time astronomers believed it to be a glow in the lunar atmosphere. Many years later, Sir Norman Lockyer, at the suggestion of his friend, Dr. Sharpey, attached the name "chromosphere" to this solar layer, because, in his words, "it is the region in which all the various and beautiful color phenomena are seen." The flash of red light results from the bright emission of the spectral line $H\alpha$ of hydrogen glowing intensely in the thin layer of incandescent gases of the chromosphere.

This chromosphere, transparent in some colors, opaque in others, is one of the principal objects of modern solar research. In it are tied up many of the problems of the definition and evaluation of solar temperatures. Because of it and the need to understand its physical properties, large radio receivers of special design operating at radar frequencies and designed to pick up the radio emanations of the chromosphere, will, for example, travel to Khartoum in the Anglo-Egyptian Sudan, for the eclipse of February 25, 1952, just as they traveled to Attu Island in 1950. With these receivers, scientists from the Naval Research Laboratory will make temperature determinations for comparison with optical measurements that will be made simultaneously at the eclipse. In the past there have been great discrepancies between optical temperature determinations and those made from radio observations. This shows that we have here a major problem worthy of careful study.

The chromospheric flash lasts a mere 2 or 3 seconds. After that, the chromosphere gases remain obscured until just a second or two before the end of totality. Then all the phenomena appear again in reverse order. During the totality, which may last from a few seconds to nearly 8 minutes, many other features of the sun's atmosphere can be studied. The principal of these are the solar prominences and corona. They differ greatly in appearance and physical composition.

The prominences are huge clouds of solar atmospheric gases, extending high above the photosphere. They exhibit fascinating, jagged, irregular shapes that change rapidly but that display regularities that astrophysicists look upon today as revealing clues to their explanation. They, like the chromosphere, shine with an intense rosy color—characteristic of the $H\alpha$ line of the spectrum of incandescent hydrogen, one of their principal chemical constituents. Plate 1, figure 1, shows a typical solar prominence of large dimension at the southwest limb of the sun on June 4, 1946. The prominences consist of gases probably nearly identical in composition with the chromosphere, even though the proportions of the various constituents probably differ.

The giant prominence clouds are supported in delicate equilibrium against the powerful forces of gravitation, more than 25 times as potent as terrestrial gravitation. What holds the prominences up has long been a matter of major astronomical concern. Now it seems that we can say, thanks to the recent work of Donald H. Menzel, of the Harvard College Observatory, that they are supported in large part by the magnetic fields of the sun. We can also say that the thousands of tons of gaseous hydrogen, helium, and other gases in the prominences are constrained to move generally parallel to the lines of force of the magnetic fields of the solar atmosphere. Menzel's work indicates that prominences probably become luminescent as they are affected by powerful compressive forces generated in the presence of streams of prominence gases. The reason for the very complex shape and appearance of the prominences is to be found, according to the new theory, in the complex structure of the magnetic fields surrounding sunspots. Initial deformities in the magnetic fields may be further aggravated by the gravitational and other forces that also affect prominences, once they come into being. Menzel's new theories have resulted in part from his extensive studies of prominence motion pictures, most of them photographed at our High Altitude Observatory station at Climax, Colo.

The corona, on the other hand, surrounds the eclipsed sun like a giant halo; it radiates a soft pearly-white light. Today we know that the corona is no simple phenomenon, but that it consists of several components. Recent work has carried us far toward understanding the different constituents of the corona, while, on the other hand, spectroscopic studies have told much in detail about the elements from which originate the bright-line spectrum that makes up a significant part of the corona's light.

It was a mere 11 years ago that the distinguished Swedish astronomer Bengt Edlén first succeeded in establishing that the long-known lines of the coronal spectrum arise from gaseous iron, nickel, and calcium, at fantastically high temperatures. The story of the identification of these lines of the spectrum, long believed due to some mysterious nonterrestrial element called "coronium," is a fascinating one, but too long for telling here.

The coronal gases described above form one of the three principal components of the corona, but they do not explain its soft pearly-white light. That, in turn, is not simple either. Researches of the postwar years have succeeded in identifying it as consisting of at least two components, the so-called "electron corona" and the "dust corona." One of these is not solar, in the strictest sense. The former is made of streams of electrons in the sun's atmosphere which are so numerous as to scatter the brilliant sunlight that passes through them,

so that even though the bright face of the sun is obscured, some of its light is scattered toward us from the clouds of electrons near the sun. The electrons move so fast that the well-known absorption lines of the spectrum of sunlight are smoothed away by the Doppler effect. Also the light scattered by the electrons is polarized, in exact and gratifying accordance with optical theory.

The "dust corona," on the other hand, has recently been deduced independently by van de Hulst of Holland and Allen of Australia. These two astrophysicists agree in attributing it to particles between the sun and the earth. Of course, they cannot be too near the sun, because there the particles would all be vaporized by the heat. The dust corona, then, is not really a part of the sun at all. It is a sort of dust halo only apparently radiating from the sun and is perfectly symmetrical, unlike the electron corona, which exhibits pronounced streamers in some directions and which changes in shape with changes in solar activity as the electron streams change their density.

Measurement of the absolute brightness, the spectrum, the intensity changes, the brightness in different colors, the relations of coronal structure to surface features—these and many other important scientific problems provide the incentives for eclipse research.

But eclipses are rare events, and their locations often difficult to reach. Weather vagaries increase the hazards of eclipse observing. On the average, less than one total eclipse a year takes place on the earth, and even then it lasts for just a few minutes at any given location. It is expensive and risky, however valuable, to travel to eclipses for scientific studies.

Thus, it is no wonder that many famous astronomers have traditionally directed their efforts to observing the atmosphere of the sun without total eclipses. The first real success came in Guntoor, India, on August 19, 1868, when P. C. Jules Janssen, of France, the day after a famous solar eclipse that he had gone to India to observe, first placed the slit of a powerful spectroscope at the very edge of the sun and looked successfully for the appearance of the lines of the spectrum of solar prominences at the sun's edge. Today many observatories operate spectroheliographs that are the direct descendants of Janssen's experiment. Most notable are those at the McMath-Hulbert Observatory in Michigan, at Mount Wilson in California, at Greenwich in England, at Meudon in France, and at Kodaikanal in India.

Nor is it any wonder that the success of Janssen, soon duplicated independently by Lockyer of England, stimulated others to try to observe the coronal spectrum by similar means. Today we know why the corona did not yield to the same method but withheld its feeble light from noneclipse research until the brilliant efforts of Bernard Lyot of France were crowned with success in 1930.

Lyot invented an entirely new type of solar telescope—the Lyot coronagraph. It permits the unwanted light from the sun's face to be excluded from the final viewing eyepiece or film of the telescope, but allows the light from the corona to come through undiminished. The photographs of solar phenomena illustrating this article are all taken with the Lyot-type coronagraph of the High Altitude Observatory of Harvard University and the University of Colorado at Climax, Colo. Figure 1 illustrates the principles of the coronagraph and explains in brief terms why it works. The coronagraph is one of the most important new research instruments developed during our century, and it ranks in importance with the classic work of Lockyer and Janssen.

Today, scattered throughout the world, are coronagraphs of the Lyot type. These permit their users to photograph prominences and corona on all suitably clear days. I say "suitably" because the standards of clarity are stringent. Coronagraphs have to be located at high elevations in the mountains, and the slightest trace of atmospheric dust or smoke blanks out their operation.

But what of the results from the operation of the instruments derived from the pioneering of Janssen and of Lyot? The results make up a major part of our knowledge of the sun and its variability. Let me touch briefly on a few of these areas of knowledge.

First of all, perhaps, in potential practical importance for man is our growing knowledge of the influences of the sun on the weather. At the Smithsonian Institution, for example, pioneering work has long gone on. Other groups as well have devoted much effort to the problem. Not only have C. G. Abbot, H. H. Clayton, H. C. Willett, and others worked intensively on these problems, but the more recent work of a man-and-wife team, the Duells, has uncovered a most unexpected direct relationship between certain outbursts of solar activity and the trend of barometric pressures at terrestrial stations. This problem has just been made the subject of over a year of most intensive study by Richard A. Craig, of the Harvard College Observatory, working closely with us at the High Altitude Observatory. In spite of the fact that the field of solar-terrestrial correlation studies is one filled with pitfalls, Craig seems to have demonstrated beyond question the reality of the fact that solar activity tends to have a direct and statistically significant effect on terrestrial atmospheric pressure changes.

We have long known, from the pioneering studies of A. E. Douglass of Arizona, the relationship between tree-growth rings and sunspot activity. In fact, the relationship now gives us one of the main methods of dating the wood of Indian pueblo ruins. The cause? Still unknown. And, of course, the relation between sunspot activity

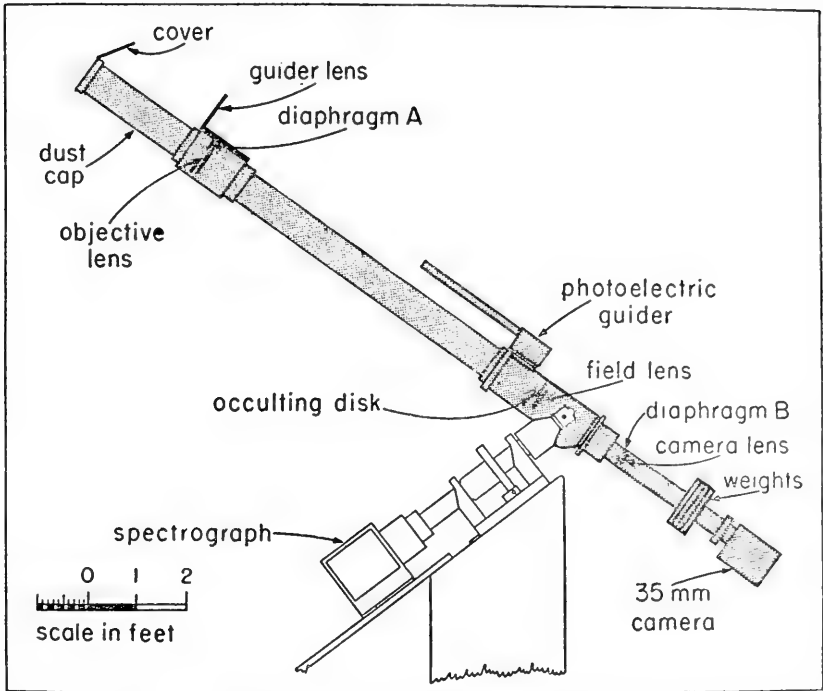

FIGURE 1.—The operating principles of the coronagraph are illustrated in this schematic diagram of the High Altitude Observatory coronagraph. Lyot, inventor of the coronagraph, found that sunlight scattered into the image of an ordinary telescope from the following sources rendered such telescopes useless for artificial eclipse photography:

- (1) Diffraction of light from the edges of the objective lens cell.
- (2) Reflection from the second face of the objective lens to the first, and then a second reflection back into the instrument.
- (3) Diffraction around dust particles and imperfections of the objective lens.

Any one of the three sources is enough, usually, to render an ordinary telescope useless for coronal photography. The first two may be eliminated completely and simply. The third may be reduced by employing the very highest skill in making the telescope objective and in cleaning it. Diffraction at the edges of the objective lens can be eliminated by placing a diaphragm (A) with a sharp edge in front of the objective, and by means of the field lens focusing an image of this diaphragm (thus focusing the diffracted light) on diaphragm B, just in front of the camera lens. If diaphragm B is slightly smaller than the image of diaphragm A, all scattered light from the first source will be eliminated. The multiple reflections from the objective form a small image of the sun very near the objective lens. This small image, since it lies near diaphragm A, will then be focused by the field lens at a position near diaphragm B. If a small opaque screen is placed on the camera lens, at its center, the small solar image formed by multiple reflections will be focused upon it by the field lens, and thus prevented from reaching the 35-mm. camera film.

In normal operation the coronagraph, thus, works as follows: The objective lens images the sun and its corona at the position of the occulting disk; at that point the light from the face of the sun is blocked by the occulting disk. The camera lens then images the artificially eclipsed sun on the 35-mm. camera film. In an alternative arrangement, a mirror located beyond the field lens can be used to direct the image into the spectrograph.

and the outbreak of "northern lights," as well as erratic disturbances to the aiming of delicate compasses, has been a matter of widespread knowledge for perhaps a century or more. With the advent of radio we have learned that the passage of a large spot group past the central meridian of the sun generally heralds by about one day the onset of poor long-distance radio reception. In recent years the origin of many seemingly cyclical phenomena have been blamed on the sunspots. Such things, for example, as business cycles and the quality of wines have been suspected of cyclical variations in phase with the sunspot changes. Most of these speculative suspected correlations I regard as inadequately substantiated.

More recently we have gained undeniable evidence of a whole gamut of new and unexpected influences of sun on earth. Theory tells us that these new influences ought to be intimately associated with the solar atmosphere, even though our observational studies have not yet revealed the clues that allow us to explain what we observe. The work of the Australian radio-scientists Pawsey, Yabsley, Payne-Scott, Wild, and others, supplemented by work in England by Ryle, in France by Denisse, in the United States by Reber, Burrows, Hagen, and by still others, has indicated to us that the sun is, at times, a powerful transmitter of very short-wave radio pulses, sometimes thousands of times as powerful as we seem to be able to explain. Here is one of the most fertile new fields of research. And it has potential significance of a most practical sort. One scientist, Kiepenheuer of the Fraunhofer Institute in Germany, even goes so far as to speculate tentatively that substantial effects on the rate of growth of plants and animals may occur when the solar radiations at radio wavelengths of about 1 meter grow abnormally intense.

The known effects on radio reception have given birth to a whole science of radio-propagation prediction and analysis. Work of this sort makes up one of the main tasks of the Central Radio Propagation Laboratory of the National Bureau of Standards in Washington. The activity of the sun is the principal sustaining source not only of the radio-reflecting layers so intensively studied at that laboratory but also of the day-to-day and hour-to-hour changes in the character of those layers predicted at the National Bureau of Standards. The sun, according to the studies done there, behaves in a far more complex fashion than a simple luminous sphere of gas at the established solar surface temperature of 6,000° Kelvin. Brilliant prominences known as "solar flares" for example, can send radiation to the earth with the velocity of light that in turn can cause a complete blackout of long-distance radio communications on the entire sunlit hemisphere of the earth—the well-known "Dellinger effect" first noted by the pioneer in radio propagation analysis, J. H. Dellinger.

The coronagraph of the High Altitude Observatory has been operated at Climax ever since it was first established there in 1940 by Donald H. Menzel. This instrument has played a modest but important role in our study of the sun. For example, work conducted jointly by Alan Shapley, then of the Department of Terrestrial Magnetism of the Carnegie Institution of Washington, and myself in the years of the last war, led us to uncover a new relationship between the bright regions of the sun's coronal emission as determined from spectra of the sun's limb (see pl. 1, fig. 2) and the behavior of magnetic storms, with their associated aurorae, erratic compass-aiming, and the related disturbances of radio communications. We found that during the years of minimum sunspot activity, whenever a region of very bright coronal emission passed the east edge of the sun, moved along by the 27-day rotation of the sun, it tended to produce magnetic storms 2 or 3 days later. These storms thus occurred when the coronal emission presumably responsible for the disturbance was still located in the east half of the sun's face. So far, we are at a loss to explain why the corona should be in this preferred location on the sun at the time of producing its maximum effects.

Another discovery made with the Climax coronagraph was that of the tiny chromospheric spicules. These spicules are tiny jetlike prominences of very short lifetime and very simple structure. I first noted these tiny prominences in 1942, and found them to be most pronounced in the regions of the poles of the sun, where the normal prominence activity is very minor. The spicules seemed to be consistently directed outward, along radii from the center of the sun. A typical spicule, like that shown in plate 2, forms as a little bubble which then bursts and jets outward to a height of perhaps 10,000 miles. The entire lifetime of a spicule lasts only something like 4 minutes on the average. The spicules seem the only major evidence of prominence activity that transports mechanical energy consistently in the outward direction through the solar surface to the atmosphere of the sun. We think that perhaps their role in the heating of the sun's corona may be significant. Also from the Climax coronagraph have come many thousands of feet of motion-picture films of prominences. These films, similar to the excellent pictures taken with the spectroheliograph at the McMath-Hulbert Observatory, and taken by means of the motion-picture technique developed by McMath, show very graphically the violence of the behavior of the gigantic solar "storms" that characterize solar "weather." These motion-picture films, as I have already stated, form the main body of observational material used by Menzel in deriving his new theories for the activity of the stormy atmosphere of the sun.

And finally, just to mention a few of the major new fields of work with the Climax coronagraph, we are paying great attention to the regions from which a still-unidentified line of the sun's corona comes. This unidentified line is the yellow coronal line at 5694 Å. This is the only major line of the coronal spectrum that is still not certainly identified. Edlén has stated that it may be calcium in a very high state of ionization. If Edlén's identification is correct, it demands the highest temperature of all the lines of the sun's corona, up in the millions of degrees Kelvin. But the remarkable thing that our spectrograms show, and that is also confirmed in the observations of Waldmeier with the coronagraph in Switzerland, is that the yellow coronal line is excited in close association with certain very intensely active and rapidly moving prominences. These prominences associated with the yellow coronal line are invariably of special form known as the "sunspot" type. It seems highly likely that the excitation of the yellow coronal line is in some way related to the formation of the explosive solar flares that produce instantaneous and drastic influences on long-distance radio communications over the entire sunlit hemisphere of the earth whenever they are very large. At the present time we have a program of work under way that should lead us to definite conclusions about this strange relationship between the sun's corona and the activity of its prominences. Just where this work will finally take us we do not yet know.

For the astronomer, the basic science of the physical conditions of the solar atmosphere is fully as interesting as the applications. And so today a host of people work daily at the study of the temperatures, pressures, gas densities, and other physical conditions of the sun's chromosphere, corona, and prominences. From their research will come ever-expanding knowledge. No matter how improbable it may seem today, this knowledge will rapidly find practical application in some new activity of importance to man. If only we can stabilize sufficiently the political affairs of our planet, we have a long and profitable time ahead of us for the exploration of the nearest star, our sun.

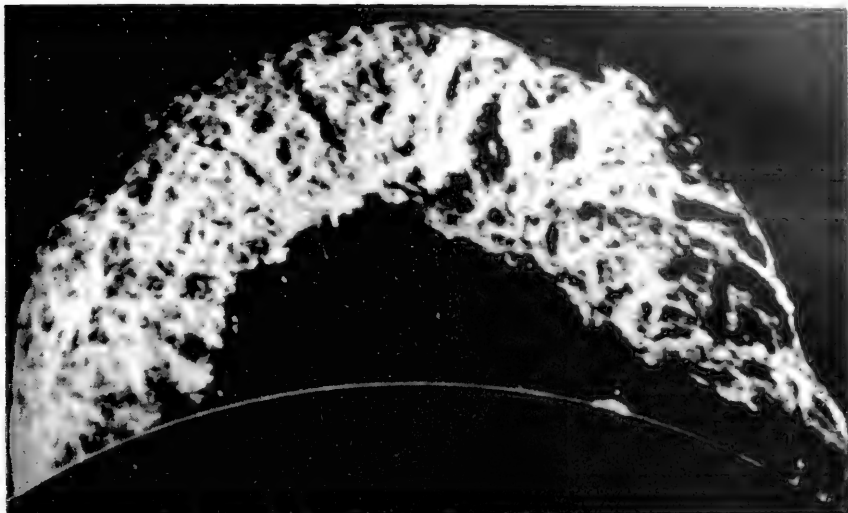

1. Large eruptive prominence of June 4, 1946, photographed in hydrogen light, 6563 Å. The prominence is shown rising in an enormous arch above the edge of the artificially eclipsed sun. The immense cloud of hydrogen rose to a height of hundreds of thousands of miles in less than 2 hours.

SPECTRUM OF WEST LIMB

12 FEBRUARY 1947

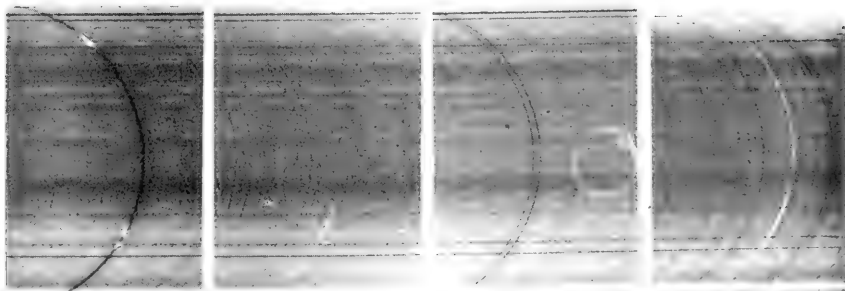

H_α
6563 Å

PROM.

Fe X
6374 Å

COR.

D₃ He
5876 Å

PROM.

Fe XIV
5303 Å

COR.

2. Sections from a spectrogram of the limb of the sun showing emission lines of the corona and of prominences. The emission spectra at the bottom of the plate are from an intensely disturbed region of the sun's surface. The region displays a bright emission from the red coronal line (6374 Å) as well as spectra from a high prominence associated with a sunspot group.

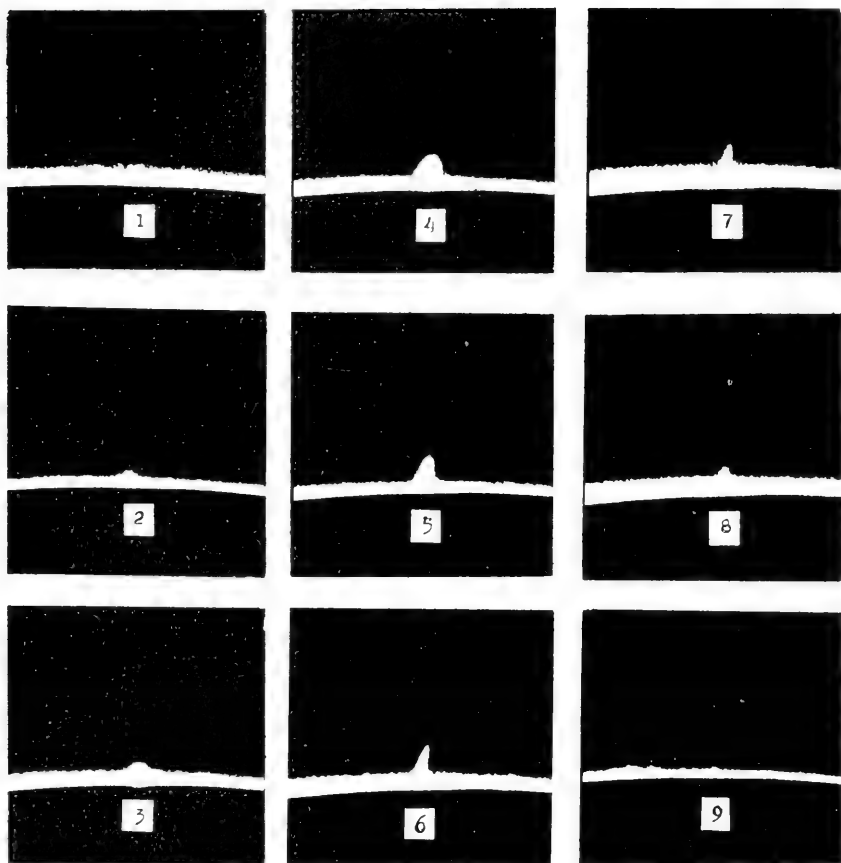

Typical behavior of a single chromospheric spicule. The total lifetime is shown in pictures 1 through 9. The average spicule passes through all these stages in but 4 or 5 minutes. A spicule usually is brightest in its early development, at about frame 4. The spicule shown here is larger and longer-lived than average. The actual elapsed times of the successive frames shown are, in minutes, 0, 2, 3, 5, 7, 9, 11, 13, 17.

An Appraisal of Cloud Seeding as a Means of Increasing Precipitation¹

By HENRY G. HOUGHTON

Massachusetts Institute of Technology

THE tremendous economic implications of the artificial control of rainfall have led to overoptimistic statements in the public press and to ill-advised commercial applications of rain-making techniques by persons who do not possess the necessary technical qualifications. These events have been viewed with concern by all responsible meteorologists. It is unfortunate that much of the money which has been spent by public and private agencies in an effort to increase precipitation in specific areas has contributed so little to our scientific understanding of the processes involved. Without adequate scientific information it is impossible to determine, with any assurance, the economic value of cloud seeding or to prescribe the most favorable conditions and procedures.

As in the case of all scientific research, the several groups and individuals who are working in this field have criticized one another's experiments and interpretations. This normal scientific interchange has been unduly accentuated by the glare of publicity which has caused some of those concerned to be more dogmatic than is justifiable in view of the present incomplete information. In the view of the public the meteorological world has been divided into believers and non-believers. This is an unfortunate and ridiculous concept. The fact is simply that the information at hand is not sufficient to permit an unequivocal conclusion regarding the possibilities of the artificial control of precipitation.

It is the purpose of this paper to assess the seeding techniques for stimulating precipitation on the basis of present scientific information and to point out the more significant gaps in our knowledge. The writer has not been associated with any of the research groups in this field but has kept himself informed through the literature and personal contact with many of the active investigators. For the sake of

¹ Reprinted by permission from the Bulletin of the American Meteorological Society, vol. 32, No. 2, February 1951.

brevity and continuity no specific references will be made to papers and reports describing the results of seeding experiments. The summary of the results as required for the present discussion is well known to most readers. Those who wish to read the original accounts are referred to the excellent bibliography recently published (1).² It is not the intent of the writer to attempt to refute or support specific claims of individuals; rather it is proposed to survey the subject as impersonally as possible. Lack of complete information makes the inclusion of certain personal opinions of the writer inevitable.

METHODS AND RESULTS

Modern rain making owes its origin to the discovery by Schaefer (2) that the insertion of dry ice or any object colder than about -40° C. into a supercooled water-drop cloud converts the cloud to ice crystals. Later Vonnegut (3) showed that the same result could be obtained by introducing tiny crystals of silver iodide, which are presumed to act as sublimation nuclei because of the dimensional similarity of the crystal lattices of silver iodide and ice. The mechanism by which dry ice forms ice crystals is still in debate, as is the whole problem of sublimation nuclei, but it is a demonstrable fact that either agent will convert a supercooled cloud to an ice cloud. Knowledge of the mechanism of ice-crystal formation is desirable, however, for an estimate of the number of ice crystals created by a known amount of the nucleating agent.

The application of the nucleating agents to rain making is based on the Bergeron-Findeisen ice-crystal theory of precipitation. According to this theory, all moderate to heavy precipitation is initiated by the appearance of a few ice crystals in a supercooled cloud. By virtue of the fact that the vapor pressure over ice is less than that over water at temperatures below freezing, the ice crystals grow by sublimation at the expense of the supercooled water drops. If the number of ice crystals is very small compared to the number of water drops, the ice crystals will become large enough to fall. After further growth by sublimation and collision they leave the cloud as precipitation elements. It was suggested that many natural supercooled clouds do not release precipitation because of a failure by nature to provide ice crystals. The use of the newly discovered methods for producing ice crystals in a supercooled cloud to initiate precipitation in such clouds was a logical step.

The reported results of cloud-seeding experiments have been quite diverse. In a vast majority of the tests there has been visible evidence of the transformation of supercooled clouds to ice crystals. It seems safe to conclude that the occasional absence of such effects has been

² Numbers in parentheses refer to bibliography at end of this article.

due to poor observing conditions or to the choice of a cloud which either was not sufficiently supercooled or was already composed of ice crystals. Nucleation of stratiform clouds often leads to the production of "valleys" or "canyons" and occasionally to the formation of holes through which the ground may be seen. Holes seem to occur most often when the cloud deck is relatively thin. The effect of the seeding is observed to progress laterally from the seeding line, often reaching a width of 1 to 2 miles in 30 to 50 minutes. Precipitation in the form of virga is a common observation, but only rarely does any precipitation reach the surface from stratiform clouds.

The observational evidence on the effects of seeding cumulus clouds is extremely varied. Again there is evidence that seeding converts the supercooled portions to ice crystals, but observation is much more difficult. It appears that some cumulus clouds dissipate when seeded, some are little affected, and, occasionally, accelerated vertical development results. Reports on precipitation range from none to very heavy. It is extremely difficult to say whether the precipitation results from seeding or from natural processes independent of the seeding. Observations made in a few cases of the elapsed time between seeding and the appearance of the precipitation are reasonably consistent, suggesting a cause-and-effect relationship. The data suggest that small cumulus clouds are usually partially or completely dissipated by seeding. It appears that the seeding of more active cumulus clouds often results in virga or light precipitation and, very occasionally, in heavier precipitation. Claims have been made that the seeding of large cumulus clouds under proper conditions may lead to the development of widespread precipitation. Very few cases of this type have been reported.

Langmuir (4) has suggested that "warm" clouds, in which the ice nuclei can have no effect, may be induced to precipitate by seeding them with water. The injected water drops grow as they fall by colliding with the cloud drops. If the cloud is deep and wet with strong updrafts the drops may grow to such size that they will rupture. The broken portions might then be carried up in the updraft so that the process would become self-sustaining. The conditions requisite for the operation of this process are likely to be those that lead to natural precipitation. A few tests of water seeding have been made but results are still inconclusive. There is little question that injected water drops will grow by collision and fall out as rain but there is reason to doubt that the continuing process visualized by Langmuir can operate except in clouds that are ready to release precipitation from natural causes. Because of the lack of adequate tests of this method and the more widespread interest in seeding with ice nuclei, no further discussion of the water-seeding process will be undertaken here.

ARTIFICIAL NUCLEI

Taken by itself the observational evidence, reviewed very briefly above, does not constitute an adequate basis for a sound appraisal of the potentialities of the cloud-seeding techniques. It is the purpose of this paper to amplify and supplement the observational evidence with the aid of existing knowledge of cloud physics and synoptic meteorology. It is considered that both the laboratory and flight experiments prove beyond any reasonable doubt that dry ice and silver iodide will both convert a supercooled water cloud to an ice-crystal cloud. The only necessary condition is that the cloud temperature be a few degrees below the freezing point. For silver iodide, Vonnegut (5) states that the maximum temperature is near -4° C.; dry ice has been shown to cause ice crystals to appear at -0.7° C. (6), but the temperature should be low enough to allow an appreciable difference between the vapor pressures over water and ice. There is no reason to doubt that ice crystals will grow in a supercooled cloud. The size attained by the crystals is dependent on their number, the initial liquid water content of the cloud, the temperature and the depth of the supercooled portion of the cloud. It is an essential feature of the Bergeron-Findeisen precipitation theory that the number of ice crystals be small compared to the number of supercooled drops; otherwise the terminal size of the ice crystals would be of the same order as that of the cloud drops and no precipitation would ensue. There is no satisfactory information on the number of ice crystals produced by dry ice. The estimate of Langmuir (7) that one pellet of dry ice forms 10^{16} ice nuclei would imply concentrations of the order of 10^3 nuclei/cm³ even if the nuclei produced by a few pounds of dry ice were distributed through several cubic miles of cloud. Quantitative estimates of the number of nuclei produced by silver-iodide generators have been made, but it is nearly impossible to estimate their concentration in the cloud after release. Atmospheric seeding experiments have resulted in the formation of precipitation elements with a wide range of seeding rates. The inference is either that a much smaller number of nuclei is formed than has been estimated or that there is a marked selective action such that only a small fraction of the nuclei become ice crystals. If the latter is true, the situation would be analogous to natural condensation in which only a small fraction of the total number of condensation nuclei become cloud drops. It is not intended to imply that overseeding is impossible, but it appears that this has seldom been an important factor in the seeding experiments which have been reported. When dry-ice pellets are dropped the initial seeding is in a vertical plane from which the ice crystals appear to diffuse laterally. It would be expected that the concentration of "seeds" would be a maximum at the center and would decrease rapidly on either side. If

overseeding occurs anywhere it should be found along the seeding line. There is no convincing evidence of overseeding in this region.

It may be concluded that it is often possible to release some precipitation from supercooled clouds by seeding them. The pertinent question is how much precipitation can be released in this way which would not fall from natural causes. If the answer to this is unfavorable, it is still important to know whether the time of release of precipitation and the total precipitation can be altered by seeding.

Unless the seeded cloud is replenished, the upper limit to the precipitation is determined by the total liquid water contained in a vertical column through the cloud. Measurements indicate that a liquid water content of 1 g/m^3 is rather a high value. If all the water in a cloud 10,000 feet deep of this water content were deposited as rain, the total rainfall would be about one-eighth of an inch. This is clearly an overestimate, since it is not likely that all the water could be precipitated and some would evaporate before reaching the ground. Most clouds would contain less water than has been assumed in this example. It is concluded that, unless the cloud is continuously replenished, the precipitation released by seeding will be very light and the cloud will be partially or completely dissipated by the removal of its water. Stratiform clouds have released practically no precipitation when seeded, as would be expected in view of their small total water content.

THERMODYNAMIC EFFECTS

It is next in order to consider the ways in which seeding might stimulate the growth and replenishment of the cloud. The phase transformation induced by the seeding releases the latent heat of fusion and the latent heat of sublimation of the water vapor which sublimates as a result of the lower equilibrium vapor pressure over ice. The exact value of the resultant temperature rise of the air depends on the initial temperature, the air density, and the liquid water content, but for a typical case it is of the order of 1°C . It is important to note that this heating occurs only in the supercooled portion of the cloud and that the temperature rise ordinarily increases with elevation. To be really effective the heating should occur in the lower part of the cloud and below the cloud base. Unless there is a temperature inversion of 1°C . or more, the heating will produce accelerated vertical motion in the supercooled portion with a maximum near the cloud top. As a consequence, there will be horizontal inflow above the freezing level. It is probable that a small pressure fall will ensue with a correspondingly small horizontal inflow into the column below the freezing level. None of these effects will induce additional vertical motion below the freezing level since they do not

provide buoyancy forces in the lower levels. Air cannot be "sucked" up but must be driven up by a force applied to each element of the air column. There will be a tendency for the supercooled portion of the cloud to separate from the portion below the freezing level. Unless the environment above this level is very moist and the lapse rate steep, it is doubtful that there will be any marked growth of the upper portion of the cloud. If there is to be an acceleration of the cloud development as a result of the heat released by seeding, a natural convective circulation must be active in the lower layers. If this natural convection has been terminated somewhere above the freezing level by a small inversion or a slightly stable lapse rate, the heat released by seeding may extend the convective activity upward. This requires rather special conditions. It may be remarked that a temperature rise of 1° C. in the upper portion of a cloud is not very impressive when viewed on an adiabatic chart. The evaporation of the solid carbon-dioxide pellets will cause the cooling of the air through which they pass. This will cause localized subsidence, but in view of the small amounts of carbon dioxide used this cooling will have little effect after the first few seconds.

An effect similar to the heating discussed above will result if the liquid water of the supercooled cloud is caused to precipitate. This removal of mass will result in an upward acceleration. It is easy to show that the removal of 1 g of water per cubic meter will cause the same vertical acceleration as a temperature rise of about 0.3° C. Note, however, that the falling precipitation will impose a downward acceleration on the lower levels of the cloud. This downward acceleration will increase as the precipitation elements grow in their fall through the cloud. It is believed that this downward force of the precipitation is partly responsible for the downdraft in a mature thunderstorm. The convective circulation in a thunderstorm is strong enough to maintain an upward motion in part of the cloud in spite of the downdraft. It is hard to see how the release of precipitation from a seeded cloud can increase the convective circulation.

It is reasonable to conclude that seeding only rarely will stimulate the vertical development of a cloud. In the vast majority of cases dissipative effects are to be expected. These conclusions seem to be borne out by the results of cloud-seeding tests.

ARTIFICIAL VERSUS NATURAL NUCLEI

The basic premise of the method for the release of precipitation by seeding is that there is often an insufficient number of natural nuclei of sublimation or crystallization present in supercooled clouds to initiate precipitation by the Bergeron-Findeisen mechanism. The regular existence of supercooled clouds in the atmosphere supports this as-

sumption. Present knowledge of the concentration and properties of natural nuclei of crystallization and sublimation is incomplete. Supercooled clouds are much more frequent than ice-crystal clouds down to about -10° to -15° C. At lower temperature ice-crystal clouds become more and more frequent although supercooled clouds have been reported at temperatures at least as low as -35° C. Measurements of the number of ice crystals appearing in an expansion chamber by Findeisen and Schultz (8) have indicated that the first crystals appear in the neighborhood of -7° C. The number of crystals formed was found to increase slowly as the temperature was lowered. At a temperature variously reported to be from -32° to -42° C. a very large increase in the number of crystals occurs. Thus, this experimental evidence is in general accordance with the observed temperature distribution of supercooled clouds. The nuclei introduced by seeding are active at temperatures of about -5° C. and below. It is well to point out here that it is not at all certain that ice crystals are a necessary prerequisite for natural precipitation. Moderate rain often falls from tropical clouds that do not extend to the freezing level. The mechanism responsible for such precipitation presumably can operate also in a supercooled cloud although the ice-crystal mechanism is more effective if the ice crystals are present.

The vertical development of convective clouds is often terminated by an inversion. If the temperature at the top of such a cloud were below -5° C. but still not low enough to activate the natural ice nuclei, seeding might release rain that otherwise would not fall. From the prior discussion it is evident that the precipitation could be substantial only if the cloud were also deep and in active development. This is the most interesting case considered so far. It is difficult to estimate the frequency of occurrence of the requisite combination of conditions from the data that are available. Certainly many convective clouds are topped by inversions at a temperature level of between, say, -5° and -20° C. but how many of them remain in active development after they reach the inversion and in how many cases is there a lack of natural freezing nuclei? Even though it might not be possible to secure data on the freezing nuclei, a well-designed observational program should help to answer these questions.

It is of interest to consider whether continuous seeding would be required to maintain precipitation in the case discussed above. It has been suggested that when snow crystals are once formed they shed tiny splinters as they fall, which then serve as very effective sublimation nuclei. If this happens, the process would tend to be self-perpetuating, after the initial seeding, as long as the circulation was such as to carry the splinters into the updrafts. Information on splintering is very incomplete and no definite conclusions can be drawn. It

seems probable that the effectiveness of this process depends on the form of the snow crystals; the dendritic (feathery) type would appear to be a much better source of splinters than the columnar and tabular forms. It has been stated that natural snow often appears to fall from below the -10° C. level, thus suggesting that something like the splintering process is active. A more careful study of this might yield some useful clues, particularly if samples of the snow crystals could be obtained. If splintering does not occur, continuous seeding would be required.

SEEDING OF PRECIPITATING CLOUDS

It is next in order to consider the possibility that seeding will alter the timing or the total amount of precipitation that falls from a cloud which is about to release precipitation from natural causes. It is almost impossible to answer this by means of individual seeding experiments. An objective answer might be obtained by seeding all potential rain clouds over a well-defined area for a long period of time (a year or more) and then comparing the precipitation in the area to that in similar control areas. Even here, there are pitfalls and the experiment should be very carefully designed in advance by a competent statistician-meteorologist team.

Evidence has been presented above that the activation temperatures of the artificially introduced ice nuclei are higher than those of most of the natural ice nuclei. If an active cloud, which is about to release precipitation by natural processes, is seeded, the onset of precipitation may be advanced by the time interval which would be required for the cloud to grow from the temperature level corresponding to the activation of the artificial seeds to that of the natural ice nuclei. The vertical distance between these levels might be of the order of 2 km. The corresponding time interval might range from say 20 minutes for an active cumulus to a few hours for frontal cloud systems. This might provide a means for increasing the precipitation in a selected area from a given cloud even though the total precipitation from the cloud were not changed. The net increase of precipitation in a given area from a large number of clouds would be small because only a few of them would be in the proper stage of development as they approached the area. It is possible that the seeding would decrease the precipitation from the cloud by causing the precipitation elements to form at a lower level, thus decreasing the total water condensed in the cloud. It may be concluded that although the time of precipitation may be advanced it would be difficult to obtain any practical advantage from this prospect except under very special circumstances.

Because of inadequate knowledge of natural precipitation processes it is not possible to make an unequivocal statement as to whether or

not it is possible to increase the rainfall from a precipitating cloud by seeding it. Precipitation requires vertical motion and the consequent condensation of water vapor followed by a process which converts the condensed water vapor into larger elements which can fall to the ground. A "precipitation efficiency" might be defined as the ratio of the rainfall to the mass of water vapor in the rising current. An efficiency of 100 percent could be achieved only if all the water vapor were condensed and all the condensate were converted to precipitation. The "precipitation efficiency" can be considered as the product of a "condensation efficiency" and the efficiency with which the condensate is converted to precipitation elements. The condensation efficiency is determined primarily by how far the water vapor is lifted. The efficiency of conversion of the condensate to precipitation depends on the temperature at which the ice nuclei operate and on their number. The condensate which is not converted to precipitation finds its way into the downward circulation required by continuity and is evaporated. Seeding provides ice nuclei which are active at a lower elevation (higher temperature) than the natural ice nuclei. If there is an insufficient number of natural ice nuclei which are active at or above the lowest temperature in the cloud, seeding might increase the precipitation by reducing the amount of condensate which would otherwise be lost in the descending branch of the circulation (increase in the efficiency or conversion). On the other hand, if there is a sufficient number of natural ice nuclei which are active at temperatures found within the cloud, seeding may reduce the precipitation by causing the precipitation mechanism to operate at a lower level in the cloud where less of the water vapor will have been condensed (decrease of the condensation efficiency). Finally, if the splintering mechanism is a regular and effective natural means of nucleating clouds once precipitation has started, seeding will have no effect since splinters of ice are the best possible ice nuclei. Lack of knowledge on the number and type of natural ice nuclei and on the importance of the splintering effect leaves the answer in doubt. It is the opinion of the writer that a significant fraction of the condensed cloud water is often lost by evaporation in the downward branches of the circulation. If true, this suggests that the precipitation can be increased by seeding if the proper number of nuclei can be introduced in the right place.

It has been suggested that silver-iodide nuclei may be effective at a considerable distance from the point of release. There is no doubt that the particles can be transported for considerable distances by the winds. The particles will diffuse laterally and vertically, thus infecting an increasing volume of air with a corresponding decrease in concentration. It is not known with certainty how long the silver-

iodide particles will retain their nucleating ability. The chance that the nuclei will encounter the proper conditions is evidently increased by permitting them to diffuse and cover considerable areas. On the other hand, this makes the task of assessing the results exceedingly difficult. There is little to gain from this technique at least until more adequate information is available on the effects of seeding individual clouds under carefully determined meteorological conditions.

LARGE-SCALE EFFECTS

The general conclusion reached so far is that seeding may induce significant amounts of precipitation only under rather special conditions which are very close to or identical with those that lead to natural precipitation. Suppose that these conditions are met and the cloud or clouds are seeded. Under the most ideal conditions the seeding may result in enhanced convective activity and the release of precipitation. The amount of precipitation is limited by the large-scale horizontal transport of water vapor into the area. This can be increased only by the creation or intensification of a circulation the size of a cyclone. There is no evidence that local convective activity will lead to cyclogenesis. In fact, widespread convective activity often breaks out in an area characterized by flat pressure gradients without any subsequent effect on the pressure distribution. It must be admitted that knowledge of the causes and mechanism of cyclogenesis is incomplete but there is evidence that changes in the upper troposphere and stratosphere are important. It is difficult to imagine any influence of seeding at these heights. This is consistent with other evidence which strongly suggests that the location of cyclogenetical areas is largely determined by the large-scale hemispheric circulation patterns rather than by local effects. If seeding increases the amount of precipitation it will also result in a proportionate increase in the latent heat released. If a substantial increase in precipitation could be produced over a large area the latent energy released would doubtless have an effect on the circulation pattern though not necessarily in the region of increased rainfall. Natural precipitation anomalies are much larger than those which might conceivably be produced by seeding, but even in such cases the effect of the release of latent energy on the circulation is not clear. In any discussion of a net increase of rainfall over large areas it is important to remember that precipitation is only one segment of the hydrologic cycle. An increase in rainfall requires increased evaporation and a greater transport of water vapor. It may be concluded that there is little prospect that cloud seeding will produce large-scale effects in the atmosphere.

The hope that large-scale effects might result from seeding is based in part on the assumption that large segments of the atmosphere are often in a metastable condition such that a small impulse will suffice to release the instability. A logical corollary of this theory is that the point at which the activity will start spontaneously is indeterminate, but that a small artificial impulse may be sufficient to initiate the release of the instability at a predetermined point. If this principle of indeterminacy is correct, it sets a basic limit on the precision with which it is possible to forecast weather. Most meteorologists will agree that this principle often seems to hold in the development of such small-scale phenomena as thunderstorms and tornadoes. This may be due, of course, to the fact that the scale of these phenomena is small compared to the spacing of the observations. In the case of large-scale phenomena there is no real evidence in favor of the indeterminacy principle. To be sure, many errors are made in forecasts, but these appear to be explicable in retrospect when adequate data are available. The motion of such disturbances seems to be continuous without the erratic behavior to be expected from the indeterminacy principle. Studies of the motion and development of cyclones strongly suggests a dependence on the large-scale fields of motion and temperature. These large-scale variations appear to be of much more importance than any small-scale, accidental differences.

SUMMARY AND CONCLUSIONS

The principal conclusions reached in this paper may be summarized as follows:

1. Seeding of supercooled clouds with dry ice or silver iodide will convert the clouds to ice-crystal clouds if the temperature is below about -5°C .
2. Seeding of an inactive cloud will not induce an important amount of precipitation.
3. Seeding a cloud will not accelerate the growth of the cloud unless there is active vertical motion below the freezing level and the environment above the freezing level is moist and only slightly stable. Partial or complete dissipation is more likely due to the lifting-off and drying-out of the top of the cloud and the downward force exerted by the falling hydrometeors.
4. Seeding of an active cloud which does not quite reach the activation temperature of the natural ice nuclei may release useful precipitation.
5. It appears possible to advance the onset of precipitation from a cloud that is about to precipitate from natural causes by seeding it.
6. The possibility of increasing precipitation initiated by natural processes by seeding cannot be determined because of incomplete

information about natural precipitation processes. There is at least some possibility that the precipitation can be increased in certain cases.

7. The conditions under which it appears possible that seeding might cause, or increase, precipitation are almost or exactly the same as those required for the natural release of precipitation.

8. Inasmuch as the most favorable conditions for the augmentation of precipitation by seeding are almost or exactly the same as those requisite for natural precipitation, definitive results cannot be expected from isolated seeding experiments.

9. On the basis of present physical knowledge and synoptic experience there appears to be no prospect that large-scale effects can be produced by seeding.

In view of the above conclusions it is considered that attempts at the practical application of cloud-seeding techniques to increase natural rainfall are premature. The entire problem is still in the research stage, and any funds available should be devoted to research on the basic mechanisms involved. Useful research results cannot be expected from personnel without extensive training and experience in cloud physics and synoptic meteorology.

It is the opinion of the writer that not enough attention has been paid to the meteorological factors in most of the past cloud-seeding experiments. It is believed that this omission is in large part responsible for some of the diametrically opposed conclusions of certain workers in this field.

There are two general approaches to further research in this field: full-scale experimentation with a properly designed experimental plan and adequate meteorological data; and detailed studies of cloud physics, both in the laboratory and in the free atmosphere. If possible, both approaches should be prosecuted simultaneously. The second plan is less expensive than the first and promises more fundamental results. However, the full-scale experimental trials must be made in the end since a complete knowledge of cloud physics would still leave out some important meteorological factors.

In some quarters it is argued that cloud seeding has been a failure and that further experimentation is unwarranted in view of the high cost. It must be admitted that the high hopes of weather control proclaimed by the popular press have not been realized. Nevertheless, the demonstration that several cubic miles of supercooled cloud can be converted to ice crystals with a few ounces or pounds of suitable material is extremely spectacular in the light of previous efforts to control meteorological processes. This should be sufficient to stimulate further investigation. It is quite possible that further fundamental discoveries lie ahead which will not be uncovered unless the

research is allowed to proceed. It is indeed unfortunate that publicity and argument have clouded the immediate issue, but this must not be allowed to obscure the long-range scientific view.

REFERENCES

1. METEOROLOGICAL ABSTRACTS AND BIBLIOGRAPHY.
1950. Vol. 1, pp. 175-205. (The most important papers listed therein appear to be: C-121, C-122, C-129, C-131, C-140, C-147, C-148, C-149, C-150, C-161, C-165, C-171, C-172, C-173, C-176, C-183, C-189, C-190, C-196, and C-204.)
2. SCHAEFER, V. J.
1946. The production of ice crystals in a cloud of supercooled water droplets. *Science*, vol. 104, pp. 457-459, Nov. 15.
3. VONNEGUT, B.
1947. The nucleation of ice formation by silver iodide. *Journ. Appl. Phys.*, vol. 18, pp. 593-595, July.
4. LANGMUIR, I.
1948. The production of rain by a chain reaction in cumulus clouds at temperatures above freezing. *Journ. Meteorol.*, vol. 5, pp. 175-192, October.
5. VONNEGUT, B.
1950. Experiments with silver iodide smokes in the natural atmosphere. *Bull. Amer. Meteorol. Soc.*, vol. 31, pp. 151-157, May.
6. SQUIRES, P., and SMITH, E. J.
1949. The artificial stimulation of precipitation by means of dry ice. *Australian Journ. Sci. Res., A. Phys. Sci.*, vol. 2, pp. 232-245.
7. LANGMUIR, I.
1946. Memorandum on introduction of ice nuclei into clouds. General Electric Res. Lab., Schenectady, N. Y., Aug. 16.
8. FINDEISEN, W., and SCHULTZ, G.
1944. Experimentelle Untersuchungen über die atmosphärische Eisteilchenbildung I. *Forsch. u. Erfarhrb. Reichs. Wetterd.*, Ser. A, No. 27, Berlin.

On Einstein's New Theory¹

By LEOPOLD INFELD

Physics Institute, Warsaw, Poland

IN 1905, when our century was still young, Einstein was 26 and a clerk in the Swiss patent office. In that year he wrote a paper that changed the face of science. It contained the basic ideas of Special Relativity Theory and revolutionized the concepts of space and time. Einstein was the first man on our planet to deduce the relation between mass and energy—a simple but fundamental relation that, 40 years later, led to the discovery and utilization of atomic energy. Thus, 45 years ago, the first Einstein revolution in science was accomplished.

If Einstein had done nothing since then, his name would live for centuries in the history of science. Yet only 10 years later, around 1915, Einstein finished his work on General Relativity Theory. Here, for the first time since Newton, a new theory of gravitation was formulated. This theory explains how the earth attracts the moon, how the planets move around each other; it explains the structure of our universe. As a logical system, Einstein's theory of gravitation is superior to Newton's old theory. Whenever the conclusions of Newton's and Einstein's theories differ, observation—the supreme judge of all physical theories—seems to favor Einstein's. Thus, 35 years ago, the second Einstein revolution in science was accomplished.

The characteristic feature of Einstein's genius is his complete independence of mind. He accepts no man's dogma; he thinks for himself, always and about everything. From 1918 to 1949, for over 30 years, he has worked on one of the deepest and most difficult problems in science: to find a theory that would embrace the large-scale phenomena (as his old theory of gravitation did) and, at the same time, the small-scale phenomena concerning the elementary particles of which atoms are built. Many scientists believed (and still believe) that so ambitious a plan can never be realized—that the

¹ Reprinted by permission from the *American Scholar*, Autumn 1950. At the time this article was written Dr. Infeld was Professor of Applied Mathematics at the University of Toronto.

laws that govern the suns and the nebulae are different from those that govern the electrons in the atom, that no unifying principle embracing both is, or ever will be, possible. Yet on this very problem, Einstein has thought incessantly, finding solutions and rejecting them because they did not satisfy his high standards of logical simplicity and beauty. While discussing a theory, Einstein would often remark to me: "Could God have created the world this way?" A good physical theory, Einstein feels, must reflect the beauty and the glory of the universe.

In 1949, Einstein was 70 years old. In this year, he believes, he found the solution for which he strove for 30 years. The results of his last two decisive steps appeared, one in the *Canadian Journal of Mathematics* (published for the Canadian Mathematical Congress by the University of Toronto Press), the other in a third edition of "The Meaning of Relativity" (published by the Princeton University Press).

Did Einstein solve the great problem of finding one law for the large- and small-scale phenomena? It may be a long time before mathematical analysis and observation pronounce their verdict—before we find the treasures hidden in Einstein's new equations. No one yet knows whether the third Einstein revolution in science has been accomplished.

THE ELECTROMAGNETIC FIELD

To understand, even in general terms, the problem on which Einstein has worked for 30 years, we must go back to the nineteenth century, to the times of James Clerk Maxwell, who was the first to create a successful field theory.

From the broadcasting antenna to my radio receiver, the radio wave—that is, the electromagnetic wave—spreads with the velocity of light. From the atoms in a neon tube to my eye, optical rays—that is, an electromagnetic wave—spread with the velocity of light. Radio and optical waves are governed by the same laws, expressed by Maxwell's equations. They tell us how the electromagnetic wave, or, as we say nowadays, the electromagnetic field, changes in space and time and what its physical properties are. Maxwell's theory is a field theory because it considers changes in time and in our three-dimensional space. It is very different from a mechanical theory that deals with such problems as the motion of the moon around the earth. In a mechanical theory, the particles and their motion are important; in a field theory, the important factors are changes of a field in space and time.

If we analyze a piece of gossip we may be interested in the speed with which this gossip spreads and how far it penetrates. These

would be the "field" aspects of the "gossip phenomenon." On the other hand, we may be interested in the men who carry the gossip and in the mechanics of their actions. These would be the "mechanical" aspects of the gossip phenomenon.

Yet, in describing the electromagnetic phenomena in the nineteenth and early twentieth centuries, we did not use the field concepts alone. Electrons—that is, negatively charged particles—produce an electromagnetic field while in motion. Thus, in Maxwell's theory, and later in Lorentz's theory, we still find a mixture of the field and particle aspects. Particles (electrons) move in an electromagnetic field and influence the field by their motion. Yet it is the field aspect that is the new and predominant feature of Maxwell's theory.

The electromagnetic field is characterized at each point of space by two arrows or vectors. One of these represents the electric field, the other the magnetic field. But an arrow can be described by its three projections upon three mutually perpendicular axes. (An arrow in a plane is characterized by two projections, in a three-dimensional space by three.) Thus the field at each point (remember that there are two arrows) is represented by six numbers, three denoting the electric and three denoting the magnetic field. These numbers change from one point to another. These two arrows, and therefore the six numbers, change at the same point from one moment to another. Maxwell's equations tell us the laws of this change. Or: the electromagnetic field is characterized by six functions of space and time. Maxwell's equations tell us how these functions change in space and time.

THE GRAVITATIONAL FIELD

We can now characterize in general terms at least one aspect of Einstein's second revolution: it did for gravitational phenomena what Maxwell's theory did for electromagnetic phenomena.

Newton's theory of gravitation follows the mechanical pattern. Particles (moon, earth) are attracted by other particles (earth, sun). In it there is no place for the concept of field, the scenery of which is all of space. There is no place for a gravitational field spreading through space in time.

Einstein's theory of gravitation is not an improved version of Newton's theory; it is an entirely new theory based upon new assumptions, logically more satisfactory than those of Newton. Yet, the results, which can be tested by observation, are very similar in the two theories. There is a great area of agreement and a small area of disagreement. The most famous new phenomenon, predicted by Einstein's theory only, is that of light rays bending while passing near the edge of the sun. Indeed, it was this phenomenon, discovered during a solar

eclipse, when one can see stars near the darkened sun, that started the great fame of the Relativity Theory and its creator. Another difference between the two theories concerns the motion of planets around the sun. The discrepancy between results deduced by the two theories is small, yet detectable in the case of Mercury, the planet nearest the sun. Whenever such disagreement exists, and whenever experiment can pronounce its verdict, it seems (to put it cautiously) to favor Einstein's theory of gravitation. But the importance of Einstein's achievement lies rather in the beauty and simplicity of his theory than in the discovery of new phenomena.

The gravitational field in Einstein's theory is characterized by 10 functions changing in space and time. They play a role similar to that of the six functions in Maxwell's theory. Einstein's gravitational equations tell us how these functions change in space and time.

We remember that in the electromagnetic theory, we have a mixture of field and particle concepts. The field is produced by the electrons and their motion. Similarly, in Einstein's original theory, the gravitational field is produced by the bodies (stars and nebulae) and their motion. Thus, comparing Maxwell's and Einstein's theories, we have the following analogy:

Electromagnetic field	↔	Gravitational field
Charged particles	↔	Gravitational masses
Motion of charged particles	↔	Motion of gravitational masses

Our analogy is not complete, and in some respects even misleading. We must now mention one novel feature of Einstein's field equations. The appearance of any form of energy is accompanied by a gravitational field. The gravitational field is influenced not only by the moving gravitational masses but also by the electromagnetic field itself, because such a field represents energy. Thus the sources of a gravitational field lie in moving masses, in moving charges, and in the electromagnetic field. A pure gravitational field can exist without an electromagnetic field. But a pure electromagnetic field cannot exist without a gravitational field.

PHYSICS AND GEOMETRY

Let us now adopt the view of 1920 (when the structure of Relativity Theory was finished), without which we cannot understand what happened later. We see one essential difference between the gravitational and the electromagnetic field: the gravitational field is a geometrical field; the electromagnetic field is a physical field.

The understanding of the gravitational field as a geometric field is the result of one of the greatest and most revolutionary ideas that

ever entered physics. It is impossible to grasp the importance of Einstein's achievement without being aware of this point. We know the properties of a Euclidean space from our high-school days: through a point outside a line, we can draw one, and only one, line parallel to the given one. But since the nineteenth century we know that Euclidean geometry is only one of the many possible geometries. The simplest case of a non-Euclidean geometry would be, for example, the one experienced by two-dimensional creatures living on the surface of a sphere. They would find that a journey "straight ahead" (that is, along a great circle for you) leads them to their point of departure; that the ratio of the circumference of a circle to its diameter is smaller than π .

The background of our physical events is a four-dimensional world. There is nothing mysterious about it. Every event, like the death of Julius Caesar, is characterized by the "place" and time in which it took place. The "place" of an event is characterized by three numbers; hence, together with time, we have four. The totality of all possible events forms one four-dimensional world. All this has been known and successfully applied since 1908 when the great mathematician H. Minkowski gave the beautiful four-dimensional mathematical form to Einstein's Special Relativity Theory.

Yet General Relativity Theory goes one important step farther. We ask: Is our four-dimensional world flat, like the plane in two dimensions? Or is it curved, like a curved surface of two dimensions? The difficulty with these questions is that, whereas we can easily visualize a two-dimensional flat or curved space, it is difficult to do so if the space is four-dimensional. But where our intuition stops, mathematics does not. Even before Einstein's time, the mathematics describing many-dimensional curved space was known, though it developed fully only under the impetus of relativity. The development of this branch of mathematics is connected with the names of Gauss, Lobachevski, Bolyai, Riemann, Ricci, Levi-Civita, and others. Let us say here only that a four-dimensional space is characterized by 10 functions; that, once we know these functions, we know the geometry of such a space; we know whether such a space is curved and how its geometry changes from point to point.

In my room I can characterize the position of the end of my pencil by quoting its distances from the ceiling and two perpendicular walls. Or, generally, the position of a point is designated by three numbers in a given coordinate system. In a town, the names of streets and house numbers form two coordinates denoting with sufficient accuracy the positions of its inhabitants on a piece of a surface (at least when they stay at home). Similarly, in our four-dimensional world of events, we must have a coordinate system so as to name the four

coordinate numbers that denote an event. But besides these, we need 10 functions that tell us whether the world we describe (in a given but arbitrary coordinate system) is flat or not flat, or, as we often say, Euclidean or Riemannian.

We can now formulate Einstein's great and new idea: The 10 functions that characterize the geometry of our four-dimensional world are the same 10 functions that characterize the gravitational field. A world without masses, without electrons, without an electromagnetic field, is an empty world. Such an empty world is flat. But if masses appear, if charged particles appear, if an electromagnetic field appears, then a gravitational field appears too. If the gravitational field appears, then our world becomes curved. Its geometry is Riemannian—that is, non-Euclidean.

Thus the same 10 functions characterize the metric and the gravitational field. The word "metric" indicates the connection between these 10 functions and the geometry of our world. The word "gravitational" indicates that the same 10 functions describe the gravitational phenomena of our world. The fact that we can use either or both of these words indicates that the physical gravitational field has its geometric counterpart. Physics—as far as the gravitational field is concerned—is reflected as geometry. The geometry of our world and the gravitational field are shaped, formed, by moving masses, moving electric charges, and by the electromagnetic field. Thus the connection

Physics \longleftrightarrow Geometry

exists only for the gravitational field. We repeat: The gravitational field is a geometric field too; the electromagnetic field is a purely physical field.

About 1920, General Relativity Theory presented a curious mixture of geometry and physics. To understand Einstein's later endeavors, we must understand his reason for dissatisfaction with the structure of field theories as they were then known. Thus, in Maxwell's equations we have:

Given: Charges and their motion
Unknown: The electromagnetic field

In Einstein's relativity theory, we have:

Given: Masses and their motion
Unknown: The gravitational or metrical field

In relativity theory, the given and unknown form a strange mixture. Mass, energy has no geometrical counterpart. But the field has!

THE TWO SINS

General Relativity Theory was born because of Einstein's dissatisfaction with the classical theory of gravitation. The new theory was

born because of his dissatisfaction with General Relativity Theory, a weak point of which was the artificial mixture of geometric and physical concepts. But another weak point is perhaps still more important. Both the electromagnetic and the gravitational theories are dualistic theories. In both of these theories, we have sources of the field (charges, particles) and the field itself. Thus we see in both theories a mixture of two concepts: matter and field. It would be philosophically much more satisfactory if we were able to build a unitary theory based on only one of these concepts. The triumphs of field theory were too great to allow us to abandon the field concept. Hence, Einstein's aim was to build a pure field theory. In such a theory we would have only field concepts and equations of the field.

But we could argue: How can we be satisfied with field equations alone? We know that matter is as real as the stone on which we stumble. The supporter of the unitary field view would say that the existence of what is known as matter should be deduced from the field equations alone. What is regarded as matter is situated in regions in which the field is especially strong. Motion of matter means that the regions in which the field is especially strong change with time. Hence, a resting electron has to be represented in a unitary electromagnetic theory by a small region, inside which the field is very strong, and outside which it dies out quickly. Such a region, with a strong but finite field, represents concentrated energy—that is, matter.

A good field theory describes and interprets matter in terms of strong fields. Hence, from the point of view of logical simplicity, great progress would be achieved if both Maxwell's theory and General Relativity Theory were to change into a pure field theory. Such a theory would deal only with the concepts of the electromagnetic field, characterized by 6 functions, and of the gravitational field, characterized by 10 functions. But the laws of these fields would have to be changed. Unlike Maxwell's theory and General Relativity Theory, such new theories would have to admit solutions representing matter. The old theories failed to do that.

But even if we were to succeed in formulating a pure field theory, such a theory would still be tainted with another fault. We saw, in the old theories, that the gravitational field was a geometrical field too, but the electromagnetic field was a purely physical field. This division is again artificial, and, according to Einstein, a satisfactory theory ought to have the following features:

1. It ought to be a pure field theory.
2. In it, electromagnetic and gravitational fields ought to be treated on the same footing—that is, both should characterize the geometry of our universe.

So Einstein tried to remove the fault of a double dualism from our theories; the dualism of field-matter and the dualism of physics-geometry—that is, the dualism of electromagnetic versus gravitational field. He believed that a search for a simple geometry of our universe, but more general than that of Riemannian geometry, would lead us to pure field equations that describe electromagnetic and gravitational phenomena. More than that, such a theory, if successful, should disclose to us the properties of elementary particles from which atoms are built, and at the same time explain the motion of planets, stars, and galaxies.

THE END OF THE SEARCH?

Einstein believes that he may have solved this great problem. Indeed, his new theory is fully a unitary theory. In it only the field appears, no sources of the field. The existence of matter will have to be deduced from the field equations by finding solutions that represent great concentrations of the field. The new theory is a purely geometrical theory. Whereas the electromagnetic field is characterized, in Maxwell's theory, by 6 functions; whereas the gravitational field is characterized in Einstein's old theory by 10 functions—in the new theory, the metrical field is characterized by 16 ($10+6$) functions. To put this in technical language: the electromagnetic field is characterized by an antisymmetric tensor with 6 components, the gravitational field by a symmetric tensor with 10 components, and the geometry of the new Einstein world by a general tensor of the second order with 16 ($6+10$) components.

In General Relativity Theory, the Einstein field equations characterized the Riemannian geometry of our world. But the geometry of our world, according to Einstein's new theory, is a non-Riemannian geometry, and Einstein's new field equations characterize this new non-Riemannian geometry of our world. Every concept that appears in the new theory has its geometrical image. The distinction between purely physical concepts and those with a geometrical interpretation is gone. The distinction between matter and field is gone too. There is only the field that is both geometrical and physical. There are only the field equations that represent the geometry of our world and the laws of physics.

THE TEST OF THE NEW THEORY

For weak fields, we regain from the new theory the laws of the old theories—that is, Maxwell's and the gravitational equations. This must be so, because every new theory must explain the phenomena that the abandoned theory explained. As always, so here, the discarded theory appears as a first approximation to the new one.

Although Einstein's new theory has many attractive features, we do not yet know whether it is a successful unitary field theory; we do not know whether it contains solutions that can be interpreted as elementary particles. We know that the old Maxwell and Einstein theories did not give solutions of field equations that could be regarded as particles. In the old theories, the existence of matter had to be assumed independently. Will the new theory succeed where the old theories failed? This is a crucial question, and we do not as yet know the answer.

But the situation is still more complicated. The modern development of physics concerns quantum laws which are valid inside the atom. It is not clear whether, and in what way, such laws could be deduced from Einstein's field theory. Yet one should not be too skeptical. Einstein's work has always met temporarily with skepticism because his genius was ahead of his times. This happened twice, and it may have happened again at the turn of our half-century.



Some Results in the Field of High-Pressure Physics¹

By P. W. BRIDGMAN

Department of Physics, Harvard University

IN THIS article I shall describe some of the physical phenomena that are produced in various materials when exposed to high hydrostatic pressures. Pressure is not usually thought of as having any important effect on the properties of materials, and indeed under the ordinary conditions in which human beings live it does not. The effect of temperature is usually far more important for us, for temperature changes may produce such important results as the conversion of ordinary liquid water to solid ice or gaseous steam. One reason for the comparative unimportance of pressure is that the variations of pressure that we can easily produce are, so far as the molecules are concerned, not large. Under pressures that are large for the molecules, changes may be produced quite as drastic as those brought about by changes of temperature. For example, water may not only be frozen solid by the application of pressure alone, but pressure is capable of producing seven different kinds of ice, something that mere alteration of temperature is unable to accomplish.

The pressures that are large enough to affect molecules are in general of the order of thousands of atmospheres, and it is with such pressures that we shall be concerned here. To set the scale, a thousand atmospheres, or some 15,000 pounds per square inch, is approximately the pressure at the deepest part of the ocean, produced by a column of water 6 miles high. Two thousand atmospheres is approximately the pressure in the explosion chamber of a large gun. From the cosmic point of view, the importance of understanding the effects of pressures of this magnitude is obvious, because all except a small fraction of 1 percent of the matter in the universe exists under pressures greater than 1,000 atmospheres.

In extending scientific measurements into the realm of pressures of this magnitude, various technological problems are encountered. There is in the first place the problem of preventing leakage of the liquid by which pressure is transmitted. This problem may be solved

¹ Reprinted by permission from *Endeavour*, vol. 10, No. 38, April 1951.

by designing the packing in such a way that the pressure in it is maintained automatically, by the liquid pressure itself, at a level higher by a fixed percentage than that in the liquid. The principle will be clear from figure 1, which illustrates the packing on the end of a piston by which pressure is generated. A piston packed in this way

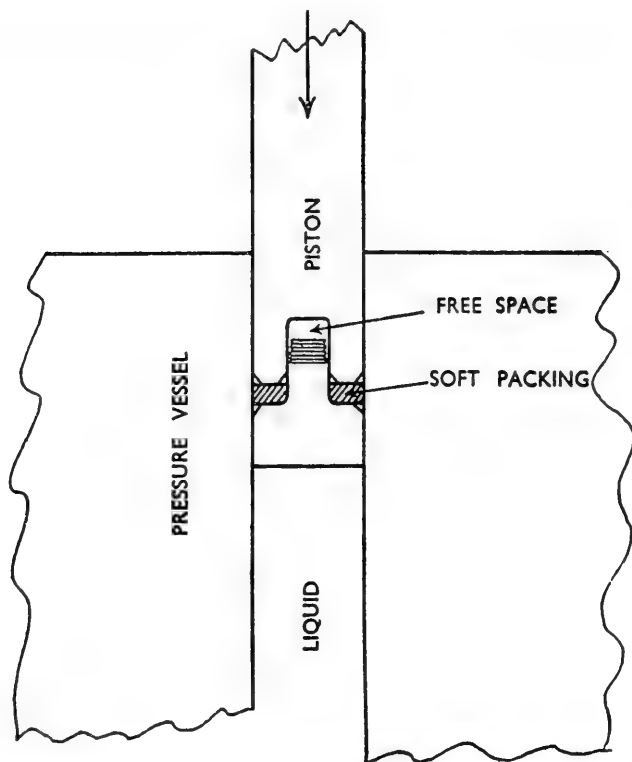

FIGURE 1.—Application to a piston of the principle by which the pressure in the packing is automatically maintained at a pressure greater by a fixed percentage than the pressure in the liquid. Leaks therefore cannot occur.

cannot leak, so that all one needs to do to produce any desired pressure is to push the piston into the pressure vessel with the necessary force. The force driving the piston is most advantageously obtained from a hydraulic press or some other form of hydraulic intensifier.

“Any desired pressure” is, however, obviously subject to several limitations, in particular the strength of the containing vessel and of the piston. It might perhaps be thought at first that the strength of the containing vessel could be increased indefinitely, merely by making the walls of the vessel of unlimited thickness. This unfortunately is not so, for even an infinitely thick vessel has only a finite strength. The reason for this is that stress and strain are concentrated at the inner parts, so that the outer parts do not do their

proportionate share in supporting the pressure. In practice it turns out that the limit for heavy cylinders of the best heat-treated steels is about 15,000 atmospheres; this may be increased for brief operations to 20,000 or more. Still higher pressures can perhaps be achieved by shrinking hoops onto the vessel, as in a well-known method of gun construction, but even with such vessels the upper limit yet reached, in some experiments by Newitt, is in the neighborhood of 30,000 atmospheres. While the pressure vessel is reaching its limit the piston also is reaching its limit, the upper limit for the compressive strength of any steel now available being also in the neighborhood of 30,000 atmospheres.

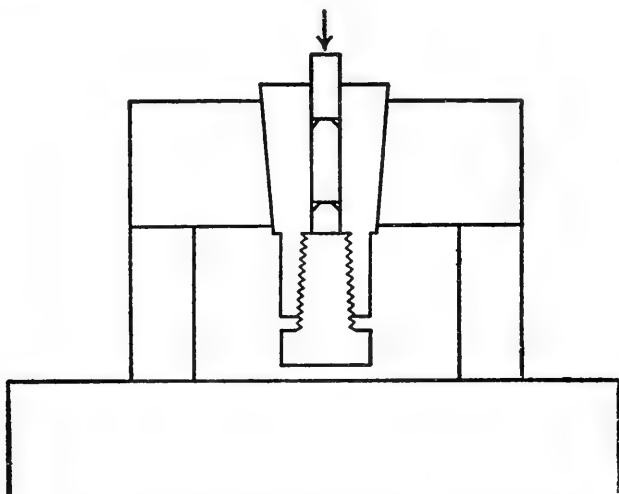

FIGURE 2.—Simple method of giving external support to a pressure vessel by using the thrust on the piston, which produces internal pressure to push the whole vessel into a supporting conical sleeve.

To reach higher pressures, a radical change in design is necessary. For the piston, however, it is sufficient to change the material of which it is made to carboloy, which has a compressive strength more than twice that of the best steels. Carboloy is a product of powder metallurgy, and is a sintered aggregate of tungsten carbide cemented with a small amount of cobalt as binder. To obtain greater strength in the pressure vessels more elaborate methods are necessary. In all my experiments it has involved giving the pressure vessel some sort of external support to counteract the effect of the internal pressure. The simplest way of doing this is to make the vessel conical on the outside surface and to push the entire pressure vessel into a conical supporting sleeve as internal pressure increases. The vessel may be pushed into its sleeve in various ways. The simplest is to let the thrust that drives the piston drive the vessel also into its sleeve; a method of doing this

is indicated in figure 2. Alternatively, the pressure vessel may be forced into its sleeve by an independent hydraulic press coupled in the proper ratio to the press which produces the internal pressure. The choice of method depends on the size of the apparatus, and is determined by various factors such as friction, which we cannot discuss here. The limit to the pressures that have been used in the laboratory in apparatus constructed with conical external support has been about 50,000 atmospheres. At this pressure a new limiting effect appears: this is the incipient extrusion of the pressure vessel through the supporting sleeve by the thrust, or some other sort of fracture of the vessel due to the thrust.

To reach yet higher pressures, the vessel must receive still more effective support. This may be given by immersing the pressure vessel in a liquid which is itself exposed to high hydrostatic pressure. In this way the pressure vessel receives complete support over its entire external surface. This proves effective enough to extend the range from 50,000 to 100,000 atmospheres. The external supporting pressure necessary for this extension may be between 25,000 and 30,000 atmospheres.

So large an extension of range, from 50,000 to 100,000 atmospheres, by a supporting pressure of only 25,000 atmospheres, would not be possible if it were not for the change in the properties of steel and carbonyl produced by a pressure of 25,000 atmospheres. Under this pressure, steel becomes much more ductile and also stronger. Carbonyl becomes stronger in compression and loses its brittleness, so that carbonyl pistons can be subjected to pressures of 100,000 atmospheres or even more. Carbonyl also increases in tensile strength, so that the pressure vessel itself may be constructed of this material, supported on the outside by a shrunk-on steel jacket. The apparatus is indicated schematically in figure 3; it is in fact an arrangement of one pressure vessel inside another. Theoretically, any extension whatever of the pressure range would be possible by this method, by making a nest of pressure vessels, each one containing a successively higher pressure supporting the vessels within. Although theoretically possible, no feasible method of constructing more than the first apparatus in such a series has been found.

It may appear paradoxical that at these very high pressures the problem which at first restricted experiments, namely the problem of preventing leak of the pressure-transmitting medium, has entirely disappeared. The reason for this is that at these pressures fluids no longer exist; all normal liquids or gases are frozen solid by the pressure. All the elements ordinarily gaseous, except helium, have been solidified at 50,000 atmospheres, and there is good reason to think that at 100,000 atmospheres helium, too, freezes solid. In this region, pres-

pressures have to be transmitted by soft solids and can be only approximately hydrostatic. Fortunately there are soft solids, such as tin or preferably indium, of which the plastic shearing strength is low, so that pressure fails to be hydrostatic by only a few percent. It is,

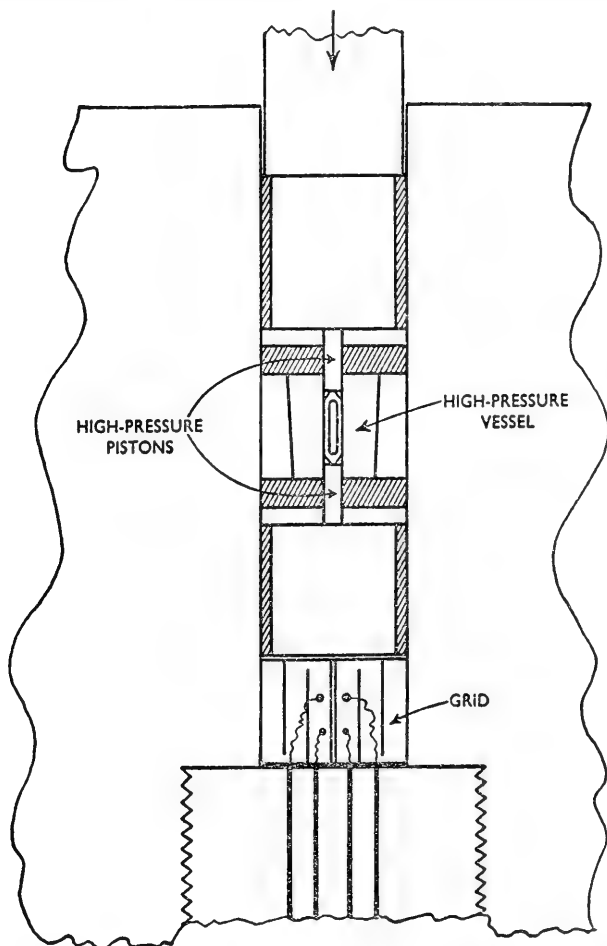

FIGURE 3.—Diagram of apparatus by which pressures of 100,000 atmospheres can be realized. The high-pressure vessel is completely immersed in a liquid (shaded), which is itself subjected to pressure and thus supports it. The thrust on the high-pressure pistons is determined by measuring the change of electrical resistance of the "grid" which receives the thrust.

however, not so easy to find a solid insulator which is sufficiently yielding at 100,000 atmospheres to be also a good pressure transmitter.

For every successive increase in the pressure range a price has to be paid in a diminution in the size of apparatus, which in turn limits the sort of experiment that can be made. The vessel in which a

pressure of 100,000 atmospheres is generated is, on the inside, only 1.6 mm. in diameter and 8.0 mm. long. In this apparatus, volume changes can be measured with fair precision, and the volume changes of a large number of substances have been determined. Still higher pressures can be reached, but, at this stage, on a scale so small that little research of scientific value has been done. The principle by which these higher pressures may be reached is that used in making hardness measurements by pressing a Brinell ball or a diamond cone into the material being tested. Stresses very much higher than normal may be supported over small areas if the surrounding material is unstressed and so can support the highly stressed region. With an arrangement of this sort, in which a short carboloy cone is pressed against a flat carboloy block, the whole combination being mounted within a chamber at 30,000 atmospheres so that there is additional support by hydrostatic pressure, pressures in excess of 400,000 atmospheres have been realized at the point of contact of the cone. However, not much use can be made of these very high pressures, except to achieve the negative result of showing that certain transformations that might perhaps be expected are not in fact produced. In particular, graphite is not transformed into diamond by such a pressure at room temperature, although it is the thermodynamically stable form.

All the pressures mentioned so far have been static pressures. Dynamically, as in the explosion of shaped charges, it is possible to reach very much higher pressures, measured in millions of atmospheres. This is doubtless the ultimate method of getting high pressures (except by the use of atomic bombs), and a beginning is now being made. The difficulties, however, to say nothing of the expense, are immense, and progress will probably be slow. The problem of measuring the pressures and temperatures reached by such methods is itself an exceedingly formidable one, and for the present the only method seems to be to extrapolate results obtained by static methods in lower ranges. Thus the results that can be obtained by the static methods outlined above will probably continue to have their usefulness for some considerable time.

Having now discussed the various methods of achieving high pressures we may turn to a consideration of some of the effects produced. The simplest of these effects, although by no means the simplest to measure, is the diminution of volume which all substances suffer under pressure. A general feature of the volume changes produced by hydrostatic pressure is that they are reversible, so that when pressure is released the volume recovers its original value. In other words, there is no elastic limit or fracture point. This is strikingly different from what happens when change of shape is produced by

the application of powerful forces other than hydrostatic pressure. Most apparent exceptions can be explained by the closing of flaws in the materials. There are some other apparent exceptions, due to a phase of greater thermodynamic stability than the original being produced by pressure. In such cases, however, the new phase created shows no permanent change when pressure is again applied and released. The reason for the failure of hydrostatic pressure to produce permanent changes is to be sought in the atomic constitution of matter. The specific volume of a substance depends only on the nature of the atoms (or molecules) of which it is composed; neglecting isotopes, there is only one kind of iron atom, for example, not one kind before it has been compressed and another kind afterward. This suggests that if pressures could be applied which were high enough to change the atoms themselves we might expect permanent changes of volume. Ordinarily, however, atomic transmutation is not brought about by pressure only, and we therefore have perfect volume elasticity.

In the realm of terrestrial pressures, within which the atoms remain unaltered, at least three classes of effect must be considered. In the first place there is the gaseous range. Here compressibilities are very high, volume being approximately inversely proportional to pressure. The mechanism is a kinetic one, pressure being exerted by the collision of the molecules with the walls of the container. Pressure is twice as high at half the volume because there are approximately twice as many collisions per unit area of the walls. This effect cannot, however, persist over any considerable range of pressure, because eventually the molecules begin to interfere with each other through being pushed too closely together. When this happens a new effect occurs. Increasing pressure now pushes the molecules progressively more closely together until all the empty spaces between them are squeezed out and the molecules are effectively in contact. This is the sort of thing that occurs in the compression of liquids under ordinary conditions, or in the compression of gases under such high pressures that their density approaches that of liquids. This effect is characterized by a compressibility that falls off rapidly with decreasing volume, for at first the empty spaces can be squeezed smaller with comparative ease, but when the molecules are nearly in complete contact this possibility is greatly reduced. The third effect now begins, namely, the deformation of the molecules or atoms themselves after they have been squeezed into effective contact. It is with this that we are primarily concerned in the compression of solids. Modern knowledge of the atom as a system of electrons and nucleus, depicting the atom as consisting almost entirely of empty space pervaded by an intense field of force, makes comprehensible a high degree of deformability under pressure in the atom it-

self. According to this picture, atoms with the most complicated electronic structures should be capable of a higher degree of compression than those with less complicated structures. This is exactly what is found. For example, nitrogen, in the region in which interference between the molecules begins and the ideal gas laws lose their validity, loses its compressibility much more rapidly than does helium, because the molecules of nitrogen are larger and are more quickly brought into contact. At still higher pressures, however, when the vacant spaces between molecules have been largely squeezed out, nitrogen becomes more compressible than helium, because the molecule of nitrogen is larger and more complex than that of helium, and therefore possesses the possibility of undergoing a greater degree of compression.

It is, of course, to be understood that there is no sharp dividing line between these three mechanisms by which a substance responds to an external pressure by losing volume; at any instant all three mechanisms are present together. It is the relative importance of the three mechanisms which changes with increasing pressure. It has already been suggested that at still higher pressures the atoms themselves may begin to break. As a result of its complex structure an atom may conceivably break in many ways. It is quite possible that what happens may not be anything like as catastrophic and irreversible as the change we ordinarily associate with breaking; it may merely be a rearrangement of the electrons in their orbits, and there is no reason why such a rearrangement should not be reversible. At pressures higher than those yet reached in the laboratory, amounting perhaps to several millions of atmospheres, we may expect all sorts of detailed changes of this kind to be produced in atoms. In the laboratory, two instances have already been found of an inner rearrangement presumably due to pressure. The element cesium, which is the most compressible of the metals, undergoes an abrupt change of volume at 45,000 atmospheres. This change is large—17 percent—and there seems to be no explanation for it in terms of the ordinary lattice structure of the metal, because it is highly probable that below 45,000 atmospheres the lattice is already in the close-packed, face-centered cubic arrangement. It would seem that pressure could not make a more closely packed arrangement than one which is already close-packed. The explanation seems to be that a rearrangement of the electronic orbits within the atoms is brought about by pressure. The details have been worked out in a recent paper by Sternheimer; he shows that an electronic transition from a $6s$ zone to a $5d$ zone exactly accounts for all the experimental facts. Metallic cerium is doubtless a similar case; it shows an abrupt volume change at 7,000 atmospheres, of the same order of magnitude as that which occurs in cesium. In the case of cerium it has been shown by ingenious experiments at the University of Chicago that both above and

below the discontinuity the lattice arrangement is the same face-centered, close-packed arrangement. The presumption is therefore again that there must be an inner electronic change, although the theoretical details have not yet been worked out.

In figure 4 the volume changes of some of the ordinary solid elements are shown as a function of pressure in the range up to 100,000 atmospheres. There is a great variability in compressibility. The most

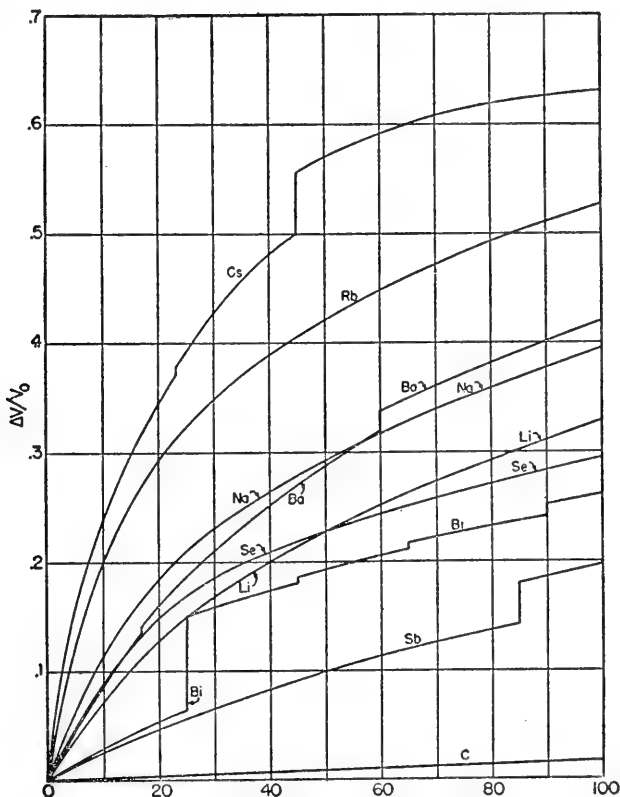

FIGURE 4.—The change of relative volume of a number of substances shown as a function of pressure up to 100,000 kg./cm.² (metric atmospheres).

compressible element shown in the diagram is cesium, which at 100,000 atmospheres is compressed to 37 percent of its initial volume. The least compressible substance is probably carbon in the form of diamond, which under the same pressure is compressed only to 98.2 percent of its initial volume. The diagram indicates that for most substances the loss of volume is far from being linearly related to the pressure; the lines are strongly curved, showing that the compressibility drops off with increasing pressure. This is the same effect as we noted for liquids, but it is on a different and much more exten-

sive scale. It must mean that inside the atom there is some sort of mutual interference between the electronic orbits, analogous to the interference between atoms or molecules that occurs in liquids. The necessity for the nonlinearity in the relation between pressure and volume is obvious, for, if it were not so, volumes would eventually become negative at sufficiently high pressure. Thus it can be calculated that if the compressibility of cesium continued at its initial rate, the metal would be squeezed out of existence altogether by a pressure of only 14,000 atmospheres.

Although every volume-pressure curve must eventually be convex toward the pressure axis, there may be an opposite curvature over considerable pressure ranges. There is no mechanical or thermodynamical reason why compressibility should not in some circumstances increase with increasing pressure. Examples of this are in fact known; the most striking is perhaps quartz glass. Its compressibility increases with pressure over a wide range. Such behavior cannot, however, continue indefinitely, and sooner or later there must be a reversal. Experiment shows that the reversal occurs at a pressure of 35,000 atmospheres, where the volume is still far above zero, being in fact 89.3 percent of its initial value. Above 35,000, compressibility decreases in the normal way with rising pressure. The abnormality ceases so abruptly at 35,000 that there is a cusp on the pressure-volume curve. It is as if there were some special mechanism responsible for the abnormality, which abruptly goes out of action at 35,000 atmospheres. A plausible mechanism would assume something in the nature of lenticular cavities in the structure, which are squeezed flat at 35,000 atmospheres.

The pressure-volume curves in figure 4 contain several examples of discontinuities. These are due to transitions of one kind or another. In most cases they are ordinary polymorphic transitions resulting from a change in the crystal lattice. The proof that they represent transitions of this sort is usually indirect and presumptive, but in some instances direct proof can be given. One method is by X-ray analysis of the new phase while it is under pressure. Another is to follow the transition to atmospheric pressure by suitably changing the temperature, and then to establish the nature of the transition at atmospheric pressure by some convenient method not subject to the limitations of high-pressure measurements.

It will be seen from figure 4 that in some cases a substance may show more than one discontinuity. One of the most interesting of such substances is bismuth. At atmospheric pressure, bismuth is abnormal in many ways; in particular it is one of the few substances which, like water, expand when they freeze. Thermodynamics demands that for substances of this sort the effect of pressure should be

to lower the melting point. This effect was found for water comparatively early; the agreement between the experimentally determined and the theoretically calculated lowering of the freezing point was in fact one of the early triumphs of the then young science of thermodynamics. Much later, I found that the melting point of bismuth is similarly lowered by application of pressure, as would be expected. What, it may be asked, can we expect to be the ultimate course of the freezing curve of water as we raise pressure indefinitely? In the case of water, it is found experimentally that, at first, increasing pressure only accentuates the effect, for at higher pressures the abnormal increase of volume on freezing becomes larger, and therefore the melting point is depressed at a continually accelerating rate. One would expect that this could not continue indefinitely, and in fact it does not. It was Tammann who first found how water extricates itself from its dilemma. At -22° C. and 2,200 atmospheres ordinary ice abruptly gives up the unequal struggle and collapses into a new kind of ice, a very large decrease of volume occurring at the same time. In fact, the decrease of volume is so large that the new solid has a smaller volume than the liquid from which it freezes. This means that the melting point of the new form of ice increases with rising pressure. Not only this, but, as the pressure continues to rise, the new ice discovered by Tammann eventually becomes unstable in its turn and is replaced by a succession of others, with still smaller volumes and more rapidly rising melting points. In all, seven kinds of ice have so far been discovered. The last of these may be heated without melting to the temperature of melting solder, provided a pressure of 45,000 atmospheres is applied.

By analogy, it was expected that a new kind of bismuth would appear at high pressures to replace the ordinary abnormal bismuth, and that the melting point of the new bismuth would rise with pressure. Search for this hypothetical bismuth was diligently made by workers in the high-pressure field, but for a long time with no success. Eventually the new modification was found, but at a pressure considerably higher than had been anticipated, namely at 25,000 atmospheres, more than 10 times the pressure which produces the analogous transition in ice. Furthermore, there are still other transitions of bismuth at even higher pressures, as there are for ice. Figure 4 shows transitions at 45,000, 65,000, and 90,000 atmospheres, in addition to the one already mentioned at 25,000 atmospheres. In reality, the transition at 25,000 is double, there being two transitions so close together—within a thousand atmospheres of each other—that it would have been confusing to try to separate them in the diagram. Thus altogether there are five known transitions of bismuth, or six polymorphic modifications of the solid. This is the same as the known

number of stable modifications of ice, so that the two substances would seem to be quite closely parallel.

There are two other fairly well-known elements which, like bismuth, are abnormal in that they expand on freezing. These are antimony and gallium. The same question arises with respect to them: will they also have other modifications under pressure, and will the melting-point curve of the new modification rise instead of fall? Of these two substances antimony is in many respects much like bismuth: chemically it is closely related, and it crystallizes in the same system. Figure 4 shows that it, too, has a transition under pressure but at a pressure more than three times that of bismuth—85,000 atmospheres instead of 25,000. It may well be, therefore, that bismuth and antimony are analogous in their polymorphic behavior. Proof of this must, however, wait until higher pressures can be commanded in the laboratory for it would appear that the pressure scale of the phenomena in antimony is more than three times as great as the scale for bismuth. Also the melting point of antimony is much higher than that of bismuth, so that it has not been possible to find experimentally whether the melting point of the new antimony is raised by pressure.

The other abnormal element, gallium, proves to fall into line as well, and here the pressure scale is fortunately smaller. A new gallium appears at a pressure of about 12,000 atmospheres, and the melting point rises with pressure. Gallium and water are parallel in that gallium has a high-pressure modification which is totally unstable thermodynamically with respect to the other modifications; similarly there is a totally unstable form of ice that appears at temperatures below 0° C. and at pressures above 4,000 atmospheres.

Considering all three substances—water, bismuth, and gallium—it would thus appear that pressure ultimately wipes out the ordinary abnormal forms and they become normal, at least to the extent that their melting point rises with increasing pressure.

Figure 4 shows another example of polymorphism induced by pressure; barium possesses two transitions and three modifications. Polymorphism is indeed a phenomenon commonly encountered in high-pressure research. Among the several hundred substances that I have examined, about one-third show polymorphic transitions. The phase diagrams of most of these substances have been examined, and it is possible to show how the pressure at which a transition occurs changes with temperature. Study of these phase diagrams reveals that many of the modifications found under pressure are quite new, in that they do not occur at atmospheric pressure at any temperature. Furthermore, there seems to be no tendency for the phenomenon to exhaust itself as the pressure range is increased; on a statistical basis, the probability that pressure will produce a new modification in an un-

known substance is proportional to the pressure. The significance of this in geophysics is obvious; it means that the probability is that the materials in the earth's crust occur there in forms with which we are not familiar in the laboratory, and therefore have unfamiliar physical properties. This implies that it is hazardous to infer the composition of the earth's crust from such evidence about its properties as is given by the velocity of propagation of seismic disturbances. Uncertainty with regard to inferences of this sort can be removed only by specific and detailed knowledge.

The transitions discussed thus far have been characterized by thermodynamic reversibility; when the pressure is removed the substance reverts to its original condition, unless by chance it is hindered at comparatively low temperatures by internal viscosity. In addition to these reversible transitions there are a few examples known of essentially irreversible transitions produced by pressure. Here the substance is converted into a new form by the application of pressure; this new form is then permanently retained and is thermodynamically stable when the pressure is removed. The transformation of yellow phosphorus into black by a pressure of 12,000 atmospheres at 200° C. is an example that has been known for a long time. The same transition may be made to occur at room temperature by 30,000 or 40,000 atmospheres. At still higher pressures—60,000 atmospheres or so—the more stable red or violet phosphorus may be transformed into the same black variety. Another example is carbon disulfide. This substance, ordinarily a highly volatile liquid, is slowly transformed at 175° C. and 40,000 atmospheres into a permanent black solid, denser than the elements from which it is constructed.

The theory of these irreversible transitions is even less well understood than that of the reversible polymorphic transitions, and indeed, as far as I know, no example has ever been worked out theoretically. Until we have some theoretical basis for knowing what to expect, we must contemplate the possibility that any of the materials of daily life can, by sufficient pressure, be pushed over a potential hill into some entirely unknown form possessing new, and perhaps desirable, properties.

Ultrasonics¹

By ARTHUR R. LAUFER

Assistant Professor of Physics, University of Missouri

[With 3 plates]

SOME 3,000 years ago, according to the Old Testament, Joshua, the son of Nun, led the Israelites over the river Jordan into the promised land. And then, once each day for 6 days, seven priests carrying seven trumpets made of rams' horns circled the walled city of Jericho. And on the seventh day the priests circled the walls seven times, and on the seventh time the priests blew a loud blast on the trumpets, and the Israelites shouted a loud shout, and the walls of Jericho fell down flat. Thus must history reach back into antiquity to find the first allusion to the use of sound energy for a purpose other than hearing.

Thirty centuries later, in the field of ultrasonics, spectacular use is again being made of "sound" energy. Although inaudible to the human ear, ultrasonic "sound" waves have all the physical properties of audible sound waves, differing only in frequency. But it is this difference in frequency, and the consequent concentration of energy, which lead to the very different effects obtainable with ultrasonic waves.

Audible sounds, or sonic waves, range in frequency from about 20 cycles per second to about 20 kilocycles per second. Ultrasonic waves are defined as vibrational or "sound" waves which have a frequency higher than 20 kilocycles. Whether inaudible vibrational waves should be called sound waves is a debatable issue, depending for its resolution on the definition of sound on a physical or on a psychological basis. Not many years ago the waves now known as ultrasonic went under the name of supersonic. This latter name left a lasting impression in the field of radio. Although radio waves are electromagnetic rather than sound waves, the intermediate frequency used in the most popular type of radio receiver was in the "supersonic" frequency range and led to the designation of this receiver as a supersonic heterodyne, or, more briefly, a superheterodyne receiver. When the

¹ Reprinted by permission from *Physics Today*, vol. 3, No. 8, August 1950.

aviation industry appropriated the word supersonic to refer to velocities greater than that of sound, physicists were forced to devise the word ultrasonic for frequencies higher than those of audible sound. To retain its original meaning the superheterodyne receiver should today be called ultraheterodyne!

PROPERTIES

The properties which give rise to the unusual effects of ultrasonic waves follow from principles common to all wave phenomena. In a given medium the wavelength of a wave is inversely proportional to the frequency, so a high frequency implies a short wavelength. Furthermore, the directional character of wave propagation is a function of the wavelength. Suppose that a vibrating circular piston is used to generate sound waves. If the frequency is low the waves spread out from the source in all directions and bend around corners. As the frequency is raised the waves begin to assume directional characteristics, that is, more of the wave energy is propagated in certain directions than in others and bending becomes less pronounced. At high frequencies most of the wave energy is concentrated in a truncated cone. The angle of the cone is a function of the ratio of the wavelength of the wave to the diameter of the piston source; the smaller the ratio, the smaller the angle of the cone. Waves of high frequency, or short wavelength, will therefore be propagated essentially in a given direction with negligible bending. Ultrasonic waves have been generated at frequencies as high as 500 megacycles, corresponding to a wavelength in air equal to that of visible red light. Such ultrasonic radiation has all the directional properties of a beam of light. Unfortunately, the attenuation of the radiation is also proportional to the frequency, or rather to the square of the frequency, so that sharply defined beams cannot be propagated over long distances. Nevertheless, even at frequencies as low as 20 kilocycles, beams of ultrasonic waves are well enough defined to be used in submarine detection.

The intensity of radiation being defined as the energy passing through a unit area per unit time, it is apparent that the concentration of ultrasonic radiation into a cone makes it possible to produce beams of very high intensity. During the past decade ultrasonic sources have been made to generate as much as 50 watts per square centimeter, and beams of radiation have been focused to yield intensities as high as 5,000 watts per square centimeter. These magnitudes become impressive when compared with the intensities of familiar audible sounds. At a distance of 2 meters from a trumpeter the sound intensity is about one-millionth of a watt per square centimeter. If all the sound energy generated by a full symphony orchestra could be concen-

trated in a point source, at a distance of 2 meters the intensity would be about 1 ten-thousandth of a watt per square centimeter which is the threshold of pain for the human ear. If all the residents of New York City (population about 7 million) were to speak at the same time, the total power they would generate would be just about enough to light a 60-watt lamp. Obviously, the intensities attainable with ultrasonic waves are enormous in comparison with those in the audible range. The phenomena discovered in the field of ultrasonics are the direct result of the short wavelength and the concomitant high intensity of ultrasonic waves.

EARLY GENERATORS

The first man-made generator of sustained ultrasonic waves was designed as long ago as 1883, when a forced-air whistle reached the frequency of 25 kilocycles. Nature, however, anticipated the work of man by endowing the bat with an ultrasonic generator of its own. Using the vocal cords in its larynx, the bat generates and emits sound waves in pulses of 2-milliseconds duration at a rate of about 30 per second. The frequency in each pulse ranges from about 30 to 100 kilocycles. Reflections received by the bat's ears indicate the location of obstacles, and, in this radarlike manner, ultrasonic radiation is used by the bat to guide itself in flight.

Following the forced-air whistle, a tuning fork with tines only several millimeters in length was developed near the end of the last century, with a frequency ranging as high as 90 kilocycles. Both the whistle and the fork, however, yielded frequencies which could not be controlled accurately and output powers which were relatively small. There was but little further progress in the development of ultrasonic generators until the first World War when Prof. Paul Langevin, director of the School of Physics and Chemistry in Paris, was requested by the French Government to devise some method of detecting submarines to combat the U-boat menace.

A few years earlier, following the *Titanic* disaster, an Englishman named L. F. Richardson suggested that a hydraulic whistle be used to locate underwater navigational hazards such as icebergs through the echo of a narrow beam of ultrasonic waves, but experiment proved his apparatus to be ineffective. Then, in 1915, a Russian engineer named Chilowski proposed that ultrasonic vibrations be excited in a mica condenser by a Poulsen arc and that the radiation from the vibrating condenser be used for underwater detection. Prof. Langevin tested and then developed Chilowski's idea to such an extent that a transmission range of 2,000 yards in the Seine River was attained early in 1916, despite the fact that the frequency stability and power output of the generator still left much to be desired. Shortly there-

after, two unrelated scientific discoveries were combined by Langevin to provide for the first time a dependable source of ultrasonic waves of controllable frequency and intensity. To replace the inherently unstable Poulsen arc, Langevin chose the newly developed and far more stable vacuum-tube oscillator. To replace the mica condenser he chose a piezoelectric crystal.

Previously, the piezoelectric effect had had no practical application. A French apothecary, Pierre de la Seignette, of La Rochelle, in 1672 discovered the crystal known as Rochelle salt. In 1880, Pierre and Jacques Curie found that mechanical stresses produced electric charges on the faces of a Rochelle-salt crystal. The inverse of this piezoelectric (pressure electricity) effect was theoretically predicted by Lippmann in 1881 and experimentally verified by the Curies the following year—a voltage applied across the crystal produced a change in the thickness of the crystal. Although it was later discovered that many other crystals, including quartz, had this same property, the piezoelectric effect remained nothing more than a scientific curiosity until 1917. In that year Langevin, who became acquainted with the effect while a student in the laboratory of the Curie brothers, applied the output of a vacuum-tube oscillator across a quartz crystal to produce the first stable, powerful generator of ultrasonic waves.

Today Langevin's generator, with relatively minor improvements, remains the best source of ultrasonic radiation of precisely controllable frequency and intensity. The high-frequency voltage output of a vacuum-tube oscillator is applied to electrodes on opposite faces of a properly cut crystal. When the oscillator frequency is adjusted to the natural resonant frequency of the crystal, powerful mechanical vibrations result, and a beam of ultrasonic waves is radiated through the medium surrounding the crystal. In addition to quartz and Rochelle salt, a number of other natural and synthetic crystals may be employed to serve particular applications.

LATER GENERATORS

During the decade following the first World War, progress in ultrasonics again slowed to a snail's pace except for certain classified military developments in underwater signaling and the development of the magnetostriction oscillator in 1925 by G. W. Pierce. Pierce used a ferrous-metal rod as the core of a solenoid which was energized by an alternating current. As the result of magnetostriction, the ferrous rod periodically changed its length in the alternating magnetic field and a beam of ultrasonic waves was radiated from the end of the vibrating rod. This magnetostriction generator is widely used today, but is limited in the range of frequencies it can generate. For high frequencies the length of the ferrous rod required for resonance

becomes too short for practical use, limiting the output of this generator to a maximum frequency of about 60 kilocycles. For higher frequencies the piezoelectric generator has no contender.

It was not until 1930 that nonmilitary ultrasonic research received its first real impetus as the result of the work of R. W. Wood and A. L. Loomis. Wood, who attributed his interest in the subject to the demonstrations he witnessed in Langevin's laboratory at Toulon, imbued Loomis with his own enthusiasm. Alfred Loomis, a wealthy amateur (in the French sense of the word) in the physical sciences, helped Wood set up an elaborate laboratory at Tuxedo Park, N. Y., where they undertook the first serious, comprehensive study of the physical and biological effects of ultrasonic radiation.

Their apparatus consisted of a disk of quartz resting upon a lead plate at the bottom of a shallow dish filled with transformer oil. The upper surface of the quartz was covered by a thin metal foil, and the foil and the lead plate were connected to the output of a 2-kilowatt vacuum-tube oscillator. The oscillator was an imposing affair indeed! Consisting of two huge Pliotron tubes, a huge bank of oil condensers, a variable condenser 6 feet high and 2 feet in diameter, and an induction coil, it delivered upwards of 50,000 alternating volts to the quartz transducer.

When the quartz was excited near its resonant frequency, a mound of oil was raised several centimeters above the oil level in the dish and appeared to be in violent agitation. A thermometer immersed in the oil showed only a moderate rise in temperature, but a finger immersed in the oil experienced a scalding pain of considerable severity. When a test tube containing paraffin and water was held in the oil bath, a rapid dispersion of the paraffin in the water took place, yielding a suspension of unusual permanence. Blood corpuscles and other cells of animal or vegetable tissues immersed in a bath in contact with the oil were violently disrupted, and frogs and small fish were quickly killed. A tapering glass rod, half a millimeter in diameter at the tip, with its butt immersed in the oil, transmitted ultrasonic vibrations of such intensity that a chip of wood smoked and emitted sparks when pressed against the tip, the rod burning its way rapidly through the wood. If a glass plate was substituted for the wood, the rod drilled its way through the plate throwing out the displaced material in the form of a fine powder or minute fused globules of glass. The heating occurred only at the point of contact, the remainder of the glass rod being quite cold. These and a host of other new and interesting effects discovered by Wood and Loomis pointed out the path which has since led into fields of the most surprising variety, interest, and practical importance.

A TOOL FOR RESEARCH

A discovery of particular importance was made in 1932 at the Massachusetts Institute of Technology. During the course of a lecture, Prof. Peter Debye discussed Brillouin's theory of the dispersion of light and X-rays by heat motion treated as a system of elastic waves at which Bragg reflections take place. Debye predicted that the periodic variations in density in a liquid traversed by ultrasonic waves would give rise to the diffraction of light traversing the ultrasonic field. Prof. F. W. Sears, who happened to be in the audience, immediately thereafter set up the experiment. He immersed a quartz plate with metallic electrodes in a glass trough, of rectangular cross section, filled with carbon tetrachloride, and applied a radio-frequency voltage to the crystal, thus sending a train of ultrasonic waves down the trough. A source of monochromatic light, a slit, and a lens were so arranged that a parallel beam of light was sent through the liquid perpendicular to the path of the sound waves. After passage through the trough the light was gathered by another lens and, true to the prediction of Debye, formed, instead of a single image of the slit, a beautiful series of its diffraction images. Thus was born the Debye-Sears effect.

The ultrasonic waves in the liquid set up regions of strong compression and rarefaction with different indices of refraction of light. These regions act like a phase grating (echelon) to produce the various diffraction images. From the spacing of the images and the wavelength of the light the sound wavelength can be determined, which, together with the frequency of the sound, permits the determination of the velocity of the sound in the liquid. The measurement of the velocity of ultrasonic waves in a given medium by this method, and by interferometric and pulse methods, permits the determination of various molecular properties which are of interest to both the physicist and the chemist. For example, these measurements permit the determination of the adiabatic compressibility, which, in turn, permits the computation of the specific heat at constant volume, otherwise calculable only by means of complicated thermodynamic relations. From such measurements the relation between the compressibility and the concentration of solutions was determined, permitting the test of a number of interesting questions in the modern theory of electrolytes. Theory predicted that the molar compressibility of electrolytes should vary as the square root of the molar concentration, a prediction that was confirmed by these ultrasonic methods. The measured variation of the velocity of sound with frequency, not predicted by classical theory, leads to a determination, via quantum statistics, of the lifetimes of the excited vibrational states of various atoms and the collision efficiency for excitation.

Ultrasonic waves are also used to set up space transmission gratings in transparent solids, which then scatter light in the way that crystal atoms scatter X-rays, resulting in diffraction patterns similar to those of X-ray Laue patterns. Measurements made on these patterns permit the evaluation of the longitudinal and shear velocities of sound in the solid, and hence of the elastic constants of the medium. Similar measurements permit the determination of the photoelastic constants of the material with greater precision and far less work than was entailed in the older interferometric methods. It should be clear from the foregoing that ultrasonic research can be expected to be of use to the molecular physicist, who ordinarily relies upon light or intense electric and magnetic fields to produce disturbances which he can measure. In ultrasonics he has a new agent, a mechanical one, with which to work.

As the intensity of the ultrasonic waves in the liquid-diffraction cell is increased, more and more light is forced from the zero order into the diffracted images, and at a certain sound intensity all the light is removed from the zero order. If a slit is used to permit only the zero order light to pass, the amount of light passing through the slit can be controlled by the intensity of the ultrasonic waves. Ultrasonic cells, which thus act as light valves, have been used as the light-modulating element in sound-on-film recording systems and in the British Scophony system of television. Furthermore, if stationary ultrasonic waves are set up in the cell by reflection, the diffraction effect is intermittent, with double the frequency of the sound, the sound-wave grating being created and destroyed twice each cycle. Light passing through the exit slit is then modulated with this frequency and can be used to give stroboscopic illumination with considerably better light output, simpler construction, and lower electrical losses than the widely used Kerr cell. A drawback, however, is the fact that the modulation frequency depends upon the resonant frequency of the particular crystal used and hence is not continuously variable. Still another slight change in the optical system, the addition of a lens to focus the central plane of the cell on a screen, permits the actual shape of the sound beam to be made visible. Very clear photographs of the reflection, refraction, and interference of ultrasonic waves can thus be obtained.

A FEW APPLICATIONS

Since the pioneer work of Wood and Loomis, each year has seen new progress in ultrasonics. University and industrial laboratories investigated the potentialities of the new field from various directions. Navy interest in sonar also stimulated ultrasonic research, and both the Navy and the Army Signal Corps sponsored investigations of the properties and effects of high-frequency sound. The results of these investigations indicate the unusually wide applicability of ultrasonics.

A pulse technique has been developed for the location of flaws in metals and other solid materials. A crystal is used to send a short pulse of ultrasonic waves into the object to be tested. The same crystal is used (through the direct piezoelectric effect) to receive reflections of the primary pulse. The amplified electrical output of the crystal, portrayed on the screen of a cathode-ray oscilloscope, depicts the primary pulse and all reflected pulses. Reflections caused by flaws permit the presence and location of imperfections to be detected. This technique possesses advantages over X-ray testing in that the equipment is portable, and far greater depths of material can be penetrated. Masses of raw materials can be tested to avoid the machining of defective material, and periodic fatigue checks can easily be made on parts which are under strain as they work without the dismantling of the machinery. One major rubber company tests its entire output of tires by such ultrasonic methods.

The violent agitation produced by high-intensity sound waves has a marked dispersive effect on solids and liquids in liquids, producing true colloidal solutions and fine emulsions. By means of ultrasonic irradiation while in the molten state, alloys can be produced of metals such as iron and lead which are ordinarily not miscible in the liquid state. New bearing materials have been made in this way. By such means it has also been possible to produce photographic emulsions of improved homogeneity, stability, and sensitivity. The homogenization of milk through ultrasonic irradiation is today an industrial process. The coarse crystals of sulfathiazole have been broken down by ultrasonics to form a creamy emulsion which can be injected through fine hypodermic needles, a technique which was previously impossible.

In spite of the fact that ultrasonic waves have this strong dispersive effect on hydrosols, their effect on aerosols is exactly the opposite—namely, coagulation. Irradiation by intense high-frequency sound causes almost immediate agglomeration and precipitation of the solid and liquid particles in mist and smoke. At an installation in Kingsmill, Tex., this technique is used to recover carbon black from a smokestack. At the Naval Landing Aids Experiment Station, Arcata, Calif., intense sound has been used in this way to turn heavy fog to rain.

Chemical reactions can also be influenced by ultrasonic irradiation. Certain reactions are accelerated, and even depolymerization can be brought about. The chain molecule of starch has been broken down into several fragments to produce dextrine, and gum arabic and gelatine have been decomposed. The aging of whiskey by ultrasonics has been proposed, inasmuch as in the aging process there is a gradual change in the structure of complex molecules, a change which perhaps could be accomplished much more rapidly by sound irradiation.

The biological effects of ultrasonic waves are of particular interest. In several cases the radiation has produced marked diminution in the virulence of bacteria. Yeast cells lose their power of reproduction, luminous bacteria lose their luminosity, and the mosaic virus of tobacco is powerfully deactivated. However, the growth of colon bacilli cannot be influenced even by long exposure to high-intensity sound. The bacteria in milk can be destroyed, permitting pasteurization at low temperatures. Experiments undertaken by sugar refiners show that the enzymes in sugar syrup can be destroyed to retard the inversion of sucrose into glucose. Food decay has been halted for as much as several weeks, indicating the possibility of sterilization of canned foods through ultrasonics. The time required for the germination of seeds has been changed, genes have been made to mature at abnormally fast rates, and in some cases genes have been altered to yield unusual mutations.

At the Pennsylvania State College Acoustical Laboratory an ultrasiren was used to kill roaches, mosquitoes, and mice. Laboratory workers who were exposed to the sound reported unusual fatigue, occasional loss of equilibrium even when wearing ear protectors, and a disagreeable tickling sensation in the mouth and nose. At another university, an attempt is being made to focus ultrasonic waves inside living tissue in order to produce the destruction of cells in localized regions. The treatment of deep-seated tumors with X-rays irradiates not only the tumor but the intervening tissues as well. Focused ultrasonic radiation may possibly avoid the over-all destructiveness of X-rays. Only further research can show whether this technique is feasible.

Whereas the field of ultrasonics is a logical extension of low-frequency acoustics, the higher-frequency range provides a new tool which can bring new aspects of nature into view. It is rare for a physical phenomenon to have found within a few decades such wide application in science and industry. In a broad survey such as the foregoing, it is manifestly impossible to portray the great variety of detail which has been developed in ultrasonic research, and only a few of the interesting problems and applications have been mentioned. Nonmilitary research in this field is still in its infancy, and many of the observed effects have as yet no adequate explanation. Ultrasonics today, a broad and beckoning field for research, holds forth the promise of exciting new discoveries just beyond the horizon.

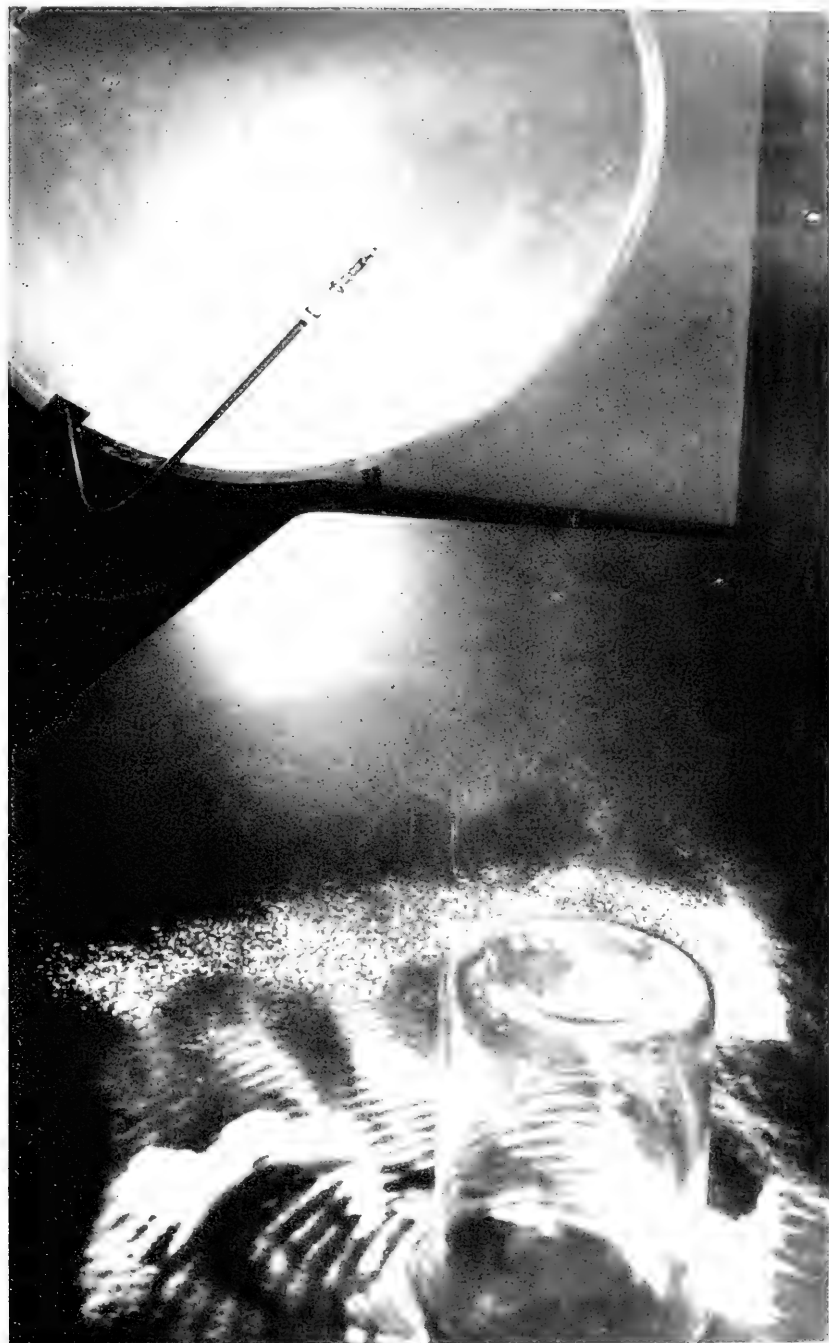

Ultrasonic waves, coming from the tiny whistle, are reflected onto the table by the concave metal disk. The ripples, formed in the water, show the standing waves formed by reflections from the table top and water. C. General Electric Co.

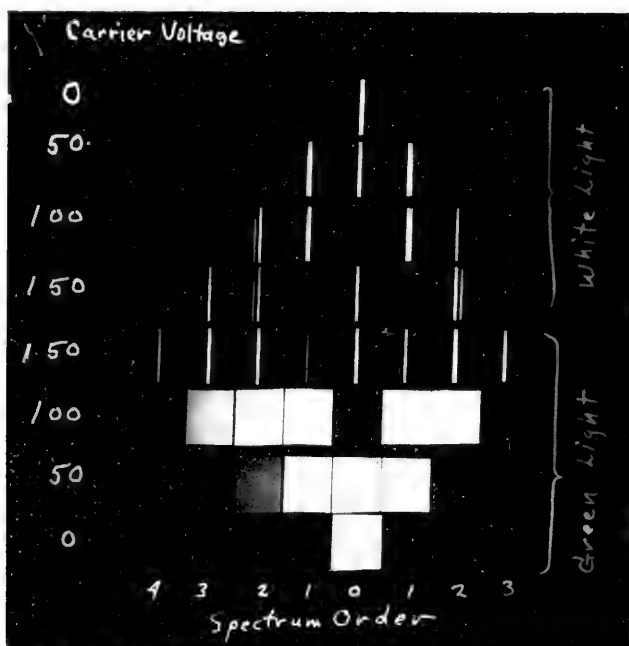

The Debye-Sears light-diffraction effect. Parallel light is beamed at right angles through a cell containing a liquid in which standing ultrasonic waves have been formed by a vibrating crystal. The alternate regions of compression and expansion form a kind of diffraction grating, but the extent to which light is passed to each of the various orders depends on the amplitude of the standing waves and hence on the voltage applied to the crystal. This photograph shows the diffraction spectra produced by ten megacycle waves in water. The upper narrow-line spectra are obtained by using a narrow-slit aperture for the light which crosses the cell. The lower broad spectra are made with a very wide slit which is used in light valving. Note that at 100 volts little or no light is left in the center (or zero) order. Courtesy *Bell Laboratories Record*.

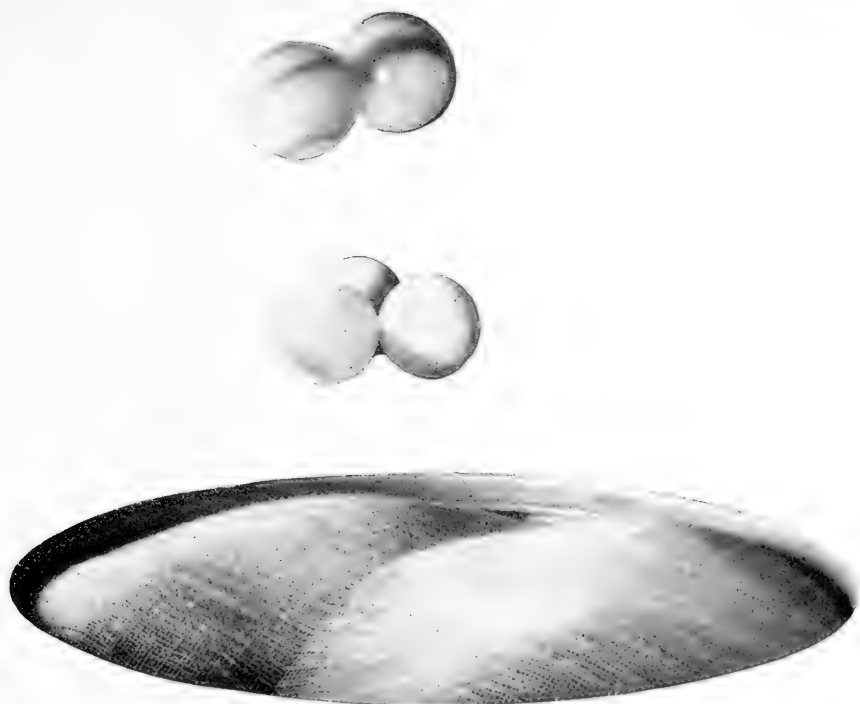

1. Five solid glass marbles suspended in space by sound waves from a high-intensity ultrasonic siren which are beamed against a reflecting board. Courtesy Harold K. Schilling, Pennsylvania State College.

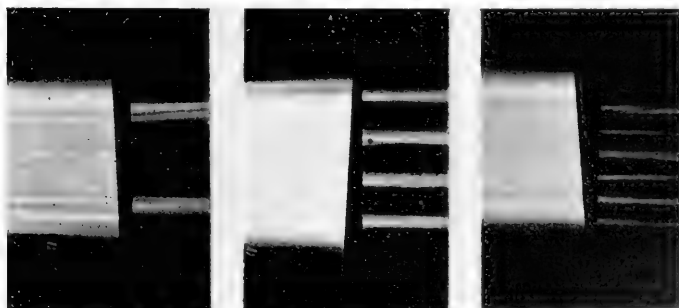

2. Transmission of a wide ultrasonic beam through aluminum wedges of increasing taper. Transmission occurs only where the wedge thickness is such as to give internal resonance. Courtesy *Bell Laboratories Record*.

The Industrial Applications of Atomic Energy¹

By M. L. OLIPHANT

Professor of Physics, University of Birmingham, England ²

ANY attempt to forecast the ways in which atomic energy will be applied for the good of mankind is as unreal as to prophesy the future of a 5-year-old child. It is certain that the new source of power will be applied in ways that cannot now be envisaged. It is possible that a scientist who has spent his life in the study of nuclear physics and the unexpected and monstrous child to which it gave birth after 50 years as a purely academic discipline, is as much entitled as anyone to guess how it will develop in the years ahead, but, as a parent of a "problem" child, he is as unlikely to guess correctly. Fortunately for me the blanket of secrecy that covers some aspects of development in this field has been pulled aside, by official declassification of information, by the reports and news releases of the United States Atomic Energy Commission, and by the statements of American senators, sufficiently for a picture of the general lines of thinking and experimenting to be available.

ARTIFICIALLY RADIOACTIVE SUBSTANCES

In the early days of public knowledge of atomic energy much was said and written about the great value of the radioactive byproducts in medicine, agriculture, chemistry, and other branches of scientific investigation. The advances in our knowledge of natural processes which can be gained in this way are very real, and scientists all over the world are using the materials made available through the American and British atomic-energy projects. However, the total amount of radioactive material required to satisfy all needs is so trivial in relation to what can be produced that it can provide no economic justification for the development of atomic energy. All the radio-

¹ Trueman Wood Lecture, delivered at the meeting of the Royal Society of Arts, Wednesday, March 8, 1950. Reprinted by permission from the Journal of the Royal Society of Arts, vol. 98, No. 4819, April 21, 1950.

² Now at the Australian National University, Canberra, Australia.

active materials needed could be produced at a very small fraction of the cost by means of cyclotrons and other tools of nuclear physics; and their use in research was widespread and growing long before they were made available from atomic-energy reactors. Probably scientists were apt to stress the importance of these substances because their consciences were uneasy after Hiroshima and Nagasaki, and they welcomed an aspect of atomic energy, the humane and intellectual implications of which would offset some of the horrors of atomic warfare. Official releases of information used the facts about them because they were nonsecret and made a good story. These materials, which were available more than 10 years before the realization of the release of atomic energy, cannot justify the development of the atomic bomb or the colossal sums spent on atomic energy. Justification must, and I believe will, come from applications of atomic energy of immensely greater economic and industrial significance.

INDUSTRIAL POWER

The most obvious and the most important application of atomic energy that we can envisage at the moment is the production of industrial power. The tactical or strategic applications of atomic energy in warfare, some of which have received attention in the press, form no part of this lecture, for they are anything but economic and represent merely a diversion of effort from development of greater and more permanent human value. Accordingly, I shall not discuss such special problems as the use of atomic energy for the propulsion of submarines or for the acceleration away from the earth of the so-called "space ships" with which some enthusiasts propose to develop luxury holiday traffic between the planets. I propose to confine myself to the possibility of generating, in large fixed reactors, industrial power which is distributed as electrical energy.

I want to emphasize that the users of industrial power in factory, office, or home, will notice no difference whatever from their present use of electricity derived from water power or coal. Atomic-energy reactors will merely replace the furnaces of power stations burning coal. The most noticeable difference at the generating station will be the absence of coal dumps, coal-handling equipment, coal wagons or barges, ash-disposal systems, and smoking chimneys. The boilers and steam turbines, the electric generators and other equipment will remain, though the boilers and turbines might later be replaced by heat exchangers and gas turbines. Thus the successful application of atomic energy will pass almost unnoticed by most people except that there may be fewer interruptions of supply; restrictions on the use of electricity may be replaced by a positive urge to use it, and electric clocks will really tell the time.

It seems to me that all industrial power should be distributed as electrical energy, except for some special purposes where gas is essential, and that there is no excuse whatever for the use of solid fuel in the home. The average efficiency of domestic appliances burning coal does not approach the over-all efficiency of generation and distribution of electric power, and there are important reasons why efficiency should not be the only criterion of choice. Anyone who has considered the dirt and grime created by the distribution of coal and its use in the home, the domestic drudgery it causes, and the fog that it brings in winter, must agree that from the viewpoint of the housewife without domestic help, the all-electric house is essential, if she is to share the 40-hour week of her husband. Those who advocate the use of solid fuel in central-heating systems or in open fires are either well supplied with domestic servants or oblivious to the elementary rights of womenfolk.

The cost of coal for the generation of electricity is only part of the cost of electric power. Where industrial power costs one penny for a kilowatt-hour, the coal will cost about one-third of a penny and the cost of generation and distribution will account for the other two-thirds. If the coal were free, the cost of electric power would be reduced by less than 30 percent. Distribution costs fall rapidly as the average load on a system increases. That is why electricity is cheaper in towns than it is in the country. Thus, the complete electrification of the country and the abolition of domestic heating by solid fuel would so increase the load factor on the distribution system that the cost of electricity would fall. If atomic fuel proves cheaper than coal, and we will see that this may well be the case, the price of electricity would be appreciably reduced still further.

WHAT IS ATOMIC ENERGY?

The name "atomic energy" is a misnomer. The energy obtained from burning coal or other fuel is more properly called atomic energy since it arises from the combination of the atoms of carbon and hydrogen in the fuel with atoms of oxygen in the air. This chemical energy results from the hooking together of atoms of carbon or hydrogen and atoms of oxygen, to produce carbon dioxide or water. The "hooks," or chemical bonds, arise from the interaction of the outermost electrons (negative charges of electricity), which form the relatively soft and tenuous "skin" of the atoms. The energy set free when coal is burnt is considerable, 1 pound of coal liberating 3-4 kilowatt-hours of heat which, by use of steam turbines in an electrical-generating station, will produce about 1 kilowatt-hour of electricity, i. e., $1\frac{1}{3}$ horsepower for an hour. Approximately two-thirds of the heat produced in burning coal in a power station is wasted, mainly to warm the water from the

river or cooling tower, owing to the unfortunate inefficiency of the heat engines.

Heat energy is simply violent agitation of the atoms of which substances are made. These heat motions are random in direction and amount and can only be converted into organized motion, such as the rotation of machinery, i. e., into useful power, by means of heat engines. It is an immutable law of nature that the transformation of heat into useful power can be carried out only by processes that waste the larger part of the heat energy.

The inner parts of atoms are the seat of forces far greater in magnitude than those associated with the outer "chemical" part. An atom is similar to a solar system, with a minute sun, or nucleus, at the center, surrounded by satellite electrons. Approximately 100 million atoms placed side by side measure 1 inch, and the nucleus of an atom is so small that 1 million million nuclei placed side by side are needed to measure 1 inch. Yet this minute nucleus contains all the positive electric charge and practically the whole of the mass of the atom. Despite its small size, physical science has gained, by indirect methods, a great deal of information about its properties and structure. The existence of the nucleus was discovered by Lord Rutherford when he held the Chair of Physics in Manchester, and its properties were unraveled by him and his collaborators in Manchester and Cambridge. In fact, nuclear physics, the study of this minute world, is a peculiarly British creation, and remained so until the successful release of nuclear energy and the colossal expenditure necessary to provide the equipment for research in this field, moved the center of achievement to the United States. Those of us who worked in this fruitful field of human intellectual endeavor harbor nostalgic feelings for the days when it was of purely academic interest and work was stimulated by the knowledge of the structure of matter which it brought, rather than by the desire to make bigger and better atomic bombs or to provide the world with a new source of power.

We believe the nucleus to be built up from entities to which we give the name "elementary" or "fundamental" particles, because, at the present time, we are unable to demonstrate that they possess any sign of structure. This belief may be as mistaken as the idea of the Victorian scientist that atoms themselves were elementary particles that had existed as hard, round billiard balls ever since they were created. The elementary particles in the nucleus are protons, which carry a positive charge of electricity, and neutrons, which have no electric charge. The forces holding these particles together are very large indeed, many orders of magnitude greater than the forces holding together the atoms of ordinary matter. If the atoms in a spider web were held together as strongly as the component parts of the nucleus, a single thread would support a battleship. The number of protons

present in a nucleus determines its positive electric charge and hence the number of electrons which must rotate about it in order that the atom, as a whole, may be electrically neutral. Thus the number of protons determines what the atom is—if 1, the atom is hydrogen; if 8, oxygen; if 92, uranium. The number of neutrons varies, so that there may be several kinds of atoms of a given substance, called isotopes. For example, hydrogen has 3 isotopes, the nuclei of which contain 1 proton with 0, 1, or 2 neutrons, while uranium has 2 principle isotopes of mass 235 and 238 times the mass of elementary hydrogen, consisting of 92 protons with 143 or 146 neutrons.

The protons and neutrons in a nucleus may be altered in number by bombarding with energetic charged particles, which can penetrate inside against the repulsive forces due to the electric charge, or neutrons may be added with greater ease since these do not experience electrical repulsion. If the number of protons is changed, the atom transforms into some other substance, and modern methods of alchemy, using cyclotrons and other accelerators to produce atomic projectiles, enable us to change one substance into another at will, though not yet in commercial quantities.

Since the nuclear constituents are so tightly bound together, addition of particles to a nucleus leads, in general, to a release of energy corresponding to this binding force. The energy released for every atom undergoing a nuclear transformation is a million or more times greater than the energy released in chemical combination. Thus, if the nuclei of 4 atoms of hydrogen could be made to combine to produce the nucleus of a helium atom, the energy released by 1 pound of hydrogen undergoing the reaction would be equivalent to 100 million kilowatt-hours, as compared with 3 or 4 kilowatt-hours produced by burning 1 pound of coal. We shall return to this possibility later.

The element uranium is the heaviest and most complex of the substances existing in the earth. Elements with more than 92 protons in the nucleus are too unstable to have survived since the earth cooled down about 3,000 million years ago. When a neutron is captured by one of the two isotopes of uranium, the transformations which take place differ from these occurring in other elements. The rarer isotope of mass 235 undergoes a process that is called fission, splitting into two large fragments which separate with great velocity, the energy released being about 10 million kilowatt-hours for 1 pound of U^{235} undergoing fission.

The U^{235} atom, after absorption of a neutron, splits into two atoms of simpler structure and smaller mass, which separate with high velocity, their energy being dissipated as heat in the surrounding atoms with which they collide. In addition, several neutrons are set free, and if the surrounding material is also U^{235} , these neutrons will be absorbed and will produce several fresh fissions. Thus it is clear that

in a mass of U^{235} large enough to absorb the neutrons from a fission process taking place at the center, a chain process can build up, and since the neutrons are moving with high velocity, the number of fission processes taking place multiplies with great rapidity. A mass of U^{235} in which this chain process will just take place is said to be of critical size, and the greater the extent to which the mass exceeds the critical size, the more rapid is the multiplication, so that if the critical size is exceeded appreciably an atomic explosion takes place. The critical mass for U^{235} is officially stated to be between 2 and 400 pounds, and since it is a very dense substance this corresponds with a sphere of metal less than 12 inches in diameter. Since the neutrons released with high velocity in the fission process are absorbed directly, a nuclear chain reaction of this type is called a fast fission process.

THE FAST NEUTRON REACTOR

If the mass of uranium 235 consists of two pieces, either of which alone is smaller than the critical mass, and these are brought together slowly and cautiously, it is possible to find a position where the system is so little above the critical size that the energy release builds up very slowly. The two pieces of uranium metal will then be heated and we can arrange an automatic mechanism that pulls them apart if they get too hot or brings them together if they cool off, so maintaining them in a red-hot condition. The heat given off can be transferred to water or to gas and can be converted into useful power in a heat engine. This is the simplest type of nuclear reactor that can give useful power. However, there are a number of difficulties.

Uranium 235 can be separated from natural uranium, of which it forms 1 part in 140, only by very elaborate and expensive physical processes. Uranium metal is very active chemically and must be protected from attack by the cooling water or gas. Very large numbers of neutrons escape from the outer surface of the uranium, together with a quantity of radiation, akin to X-rays. These must be absorbed in thick shields of concrete to prevent lethal danger to living things in the neighborhood. The amount of heat that can be abstracted from pieces of metal with so small a surface is small, and in practice it is necessary to increase the cooling area greatly and use a larger mass of fissionable material. The problems of control must be solved in such a way as to eliminate all risk of explosion. The charge of U^{235} must be removed periodically and treated chemically to remove the accumulated fission products and to add fresh U^{235} , and this involves serious problems of engineering and of handling the highly radioactive material.

PLUTONIUM

The principal isotope of uranium, U^{238} , behaves in a different way when it absorbs a neutron. Instead of undergoing fission it changes,

by a process involving the radioactive emission of two negative electrons, into a new chemical element, with 94 protons in the nucleus, which has been called plutonium. This substance, which does not exist in the natural state, is a metal that undergoes slowly a radioactive change into U^{235} , but this change is so slow, requiring 10,000 years or more to be half completed, that for all practical purposes plutonium is a normal metal. It undergoes fission when it absorbs a neutron of any energy and hence can replace U^{235} as a nuclear fuel.

SLOW NEUTRON REACTORS

The capture of neutrons by the much more plentiful U^{238} prevents the establishment of a chain process with natural uranium. There is, however, an ingenious way out of this difficulty, which enables reacting systems to be built using natural uranium. U^{238} does not capture neutrons that are moving with less than a certain minimum velocity. Neutrons can be slowed down by passage through materials like pure carbon or heavy water, which do not absorb neutrons at all readily. The particles then make collisions with atoms of carbon or of heavy hydrogen, handing over to the struck atom at each collision a part of their energy. By placing rods of uranium in a geometrical pattern, which can be calculated, in a mass of pure graphite, it is possible to arrange that fission neutrons escaping from the relatively thin rods without appreciable absorption wander around in the graphite for a considerable time, making many collisions and losing most of their velocity. When they do again wander into a uranium rod they are, in general, moving too slowly to be absorbed by the U^{238} , and hence ignore it. However, they are very readily captured by the rarer U^{235} atoms, giving rise to fission.

In order that a chain reaction may be produced, a slow neutron reactor of this type must also be above a certain critical size, where the number of neutrons lost from the outer surface is less than half the number generated within the pile by the chain reaction. The critical size is large and even a small slow neutron reactor will contain many tons of uranium and hundreds or thousands of tons of carbon as pure graphite. The many neutrons escaping from the outer surface are, to some extent, reflected back by a thick layer of graphite placed around the reactor, while the remainder, together with the accompanying X-rays, which are so harmful to living matter, must be absorbed in the walls of a massive concrete enclosure. The energy set free in the fission process in the uranium rods appears as heat, which can be removed by passing gas or water over them. Here again it is necessary to coat the uranium with a protective layer of corrosion-resistant metal that does not absorb neutrons readily, aluminum being employed at present in the absence of a better material.

The slow neutron reactor has some advantages over the fast neutron reactor, but it suffers also from severe limitations which are not present in the fast reactor. The large mass and surface of the uranium allows very large quantities of heat to be extracted, so that the total power output of a large reactor can be of the order of 1 million kilowatts of heat. However, it is not yet practicable to remove this heat at a temperature high enough for efficient heat engines to be operated from the steam or gas which carries away the energy. This is due to the limited corrosion resistance of aluminum. The development of coatings of beryllium, or the use of less reactive gases such as helium, for cooling, would permit the production of useful power, but no reactor is yet operating under these conditions. There are also other grave difficulties due to the changes in the properties of materials under the action of fast neutrons. These technological problems will be solved, but they take time and great effort to achieve a completely satisfactory answer. A far more serious problem is that in a slow neutron reactor it is possible to use only a small fraction of the U^{235} present in the rods. Inevitable impurities in the materials and the accumulated products of fission "poison" the reaction by absorbing neutrons. The former set a lower limit to the concentration of U^{235} in the rods at which the reactor will operate, and this is only slightly less than the concentration in natural uranium. The uranium must be removed periodically and be subjected to an elaborate and costly chemical process involving solution of the rods in acid, chemical purification, and reduction to metal again. The whole of the initial chemical operations must be carried out by remote control in concrete or lead enclosures which absorb the harmful radiations coming from the highly radioactive fission products. These fission products, equivalent in activity to many tons of radium, must be disposed of in some way, and this is one of the most difficult problems of all. If they are thrown down a disused mine or buried they may reappear in the underground water supply with disastrous results. The uncertainty of ocean currents renders it hazardous to dump them into the sea, even into the deep sea when sealed in containers. The radioactivity decays away in time, some of it relatively quickly, some much more slowly, so that if the fission products are stored in vats underground they will, in the course of a generation or two, become harmless. However, the storage capacity required to deal with the radioactive waste products of a large reactor is so huge that provision of the necessary underground vats becomes an immense undertaking.

All these difficulties are very real and must not be underestimated. However, they are technological difficulties with which modern applied science is accustomed to deal, and are none of them insuperable. Their solution is certain if the necessary effort is made, and many of

them are being attacked vigorously in both America and Great Britain, though, in the present state of international tension, they must take a position subordinate to the development and manufacture of atomic weapons.

CONTROL OF NUCLEAR REACTORS

If a nuclear reactor is operating at a constant power level the number of fissions taking place each second must be constant. In the systems we have considered so far the number of fissions taking place in 1 second must increase rapidly. We have indicated that a fast neutron reaction can be controlled by moving the component parts so that more or less of the neutrons escape from the surface. This control is rendered easier because some of the neutrons set free escape a fraction of a second after the fission process itself. This means that if the system is just larger than the critical size, the multiplication proceeds rather slowly. The component parts of a slow neutron reactor are too large and bulky to be moved in this way, so the system is controlled by pushing into the interior of the reactor rods of cadmium or of boron, which have the property of absorbing neutrons readily, so robbing the chain process of the number of neutrons required to keep it going. There is no difficulty about controlling completely the rate of energy release in a reactor, so that the chance of the process running away and giving rise to an explosion is so small as to be entirely ruled out. Very elaborate precautions are taken to prevent the escape of radioactive materials or of harmful radiations, and workers in an atomic-energy plant and those who live in the neighborhood are not subjected to any abnormal risks.

“BREEDER” REACTORS

The picture of the production of atomic energy for industrial purposes that we have drawn so far is not encouraging. The fast neutron reactors require rather concentrated fissile material as atomic fuel, and this is very difficult and expensive to produce. The slow neutron reactors utilize only a very small fraction of the rarer isotope of uranium and produce about the same quantity of plutonium. Much more than this must be achieved if atomic energy is to compete successfully with coal as a source of power. Fortunately the way out is clear, though it has not yet been achieved in practice, and the solution brings with it the possibility of using thorium, as well as uranium, as a nuclear fuel.

On the average a fission process releases several neutrons, say three. If it is assumed that there are in the reactor no impurities or materials of construction (other than uranium) that absorb neutrons, the three fission neutrons can be utilized in the following way. At constant power output one of these neutrons must produce a fresh fission by absorption into the nucleus of another fissile atom. A second neutron

can be captured by uranium of mass 238 to produce an atom of plutonium, thus replacing the atom of fuel that has been used. The third neutron can be absorbed by a second U^{238} atom giving another plutonium atom. Thus a reactor operating in this way should produce more nuclear fuel than is burnt and is called a "breeding" reactor. The breeding process should make it possible to utilize the whole of the uranium, the plentiful U^{238} as well as the scarce U^{235} . If the excess neutrons are absorbed in thorium instead of U^{238} , a new fissile material which can replace U^{235} or plutonium is produced by a process very similar to that which produces plutonium. We can represent this process by the nuclear equation

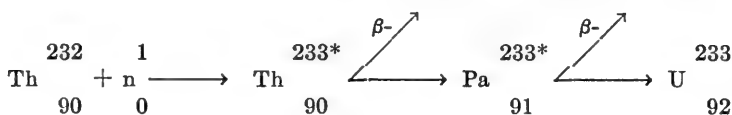

The thorium nucleus absorbs a neutron producing a radioactive isotope of thorium of mass 233. This emits a negative electron, or β -particle, transforming into a radioactive form of protoactinium, which emits a further β -particle to give an isotope of uranium of mass 233. U^{233} is a fissile substance which can be used as a fuel in nuclear reactors. Thus, in time, it should be possible to change over from uranium to the more plentiful thorium as fuel for the production of nuclear power.

The design of a successful breeding reactor depends upon the elimination from the reactor of materials that capture an appreciable fraction of the neutrons without contributing to the production of power or of fresh fissile material. There are reasons why this may prove to be more practicable with the fast neutron reactors than with those using slow neutrons, partly because the smaller mass of fissile material in the reactor can be prepared in a state of higher purity, partly because there is no moderator, but principally because the essential materials of mechanical construction and the cooling fluid which can be used in a fast neutron reactor are not so restricted in properties. The most important of the factors to which answers have yet to be found is the extent to which the materials in the reactor retain their physical properties of strength, etc., when the atoms of which they consist are continually stirred up and knocked out of place by collisions with fast neutrons.



EXPERIMENTAL PROGRAM IN U. S. A.

The Atomic Energy Commission in the United States has announced the construction of two types of experimental breeding reactor and a materials-testing reactor. The first of these is designed to test the practical feasibility of breeding with fast neutrons and to investigate

the application of liquid metals to the removal of fission-produced heat at high temperatures. The second will produce significant amounts of electric power from a reactor using neutrons in the intermediate range of energies, and at the same time will determine whether breeding is possible under these conditions. The heat will be removed with liquid metal, and power will be generated from this by conventional means. These breeder reactors, together with the materials-testing reactor, are estimated to cost about 70 million dollars. The Ministry of Supply has not yet announced plans in Britain for work on breeder reactors upon which the future of atomic energy for useful purposes clearly depends.

ECONOMIC COST OF NUCLEAR POWER

It is not easy to estimate, as yet, the economic cost of nuclear power. The energy derived from 1 pound of uranium, completely utilized in a breeder reactor, is equivalent to that produced by burning 1,500 tons of coal. The cost of uranium is about 1,000 times the cost of coal. This leaves a factor of about 3,000 to cover the cost of converting the uranium to a form suitable for use in a reactor and the greater cost of a nuclear reactor over a coal furnace. In the absence of precise data it is possible only to guess the ultimate answer. You will find that many British scientists and engineers of repute believe that the cost will always be too great for atomic energy to compete with coal as a source of power, and that the new form of energy is of purely military and scientific interest. I do not share this view. I feel confident that atomic energy has a very important part to play in the production of industrial power and that the cost will ultimately be found to be competitive with, and probably much less than, the cost of power from other sources. The time required to reach this stage of development is unlikely to be less than 10 to 15 years and clearly it depends on the relative efforts devoted to the military and industrial objectives. Uranium is more widespread in occurrence than was thought to be the case and, with the development of methods for extracting it from low-grade ores, there should be sufficient available to provide a great contribution to the power resources of the world if it is not used for the manufacture of military weapons.

HYDROGEN AS A NUCLEAR FUEL

Finally, we must consider the possibility that industrial power may one day be produced from hydrogen. Long before the discovery of the fission process it was realized that under conditions of extremely high temperature and pressure, such as exist in the interior of the sun and stars, hydrogen nuclei, or protons, might combine to give nuclei of heavier elements, and that because the component parts of heavier

nuclei are very tightly bound together, sufficient energy would be released to maintain the temperature of the star. If it were possible to find a method by which heavier atoms could be synthesized from hydrogen at will and under controlled conditions, very large amounts of energy would be available. Thus, if four atoms of hydrogen condense to form an atom of helium, the energy set free is about 5 million times as great as that produced when an atom of carbon is burnt. In other words, 1 pound of hydrogen transformed into helium would produce about 100 million kilowatt-hours of heat energy, or about 130 million horsepower for an hour. Thus hydrogen as nuclear fuel would be about 10 times as good, weight for weight, as uranium. There are possible ways in which an explosive reaction of this type can be produced by utilizing the very high temperature and pressures developed in the explosion of an atomic bomb, but so far there is no clue to a method for bringing about the reaction in a controllable way. However, it is interesting to speculate on the possibility that nuclear scientists may discover how to do this in the future.

There is enough hydrogen in the sea, if it were all converted into helium, to raise the temperature of the whole earth to at least $1,000,000^{\circ}$ C., i.e., over 100 times the temperature of the surface of the sun. Fortunately for us the possibility of bringing about such an explosion can be ruled out, if for no other reason than that if it were possible it would have happened in the past history of the earth. However, if we accept as the desirable power level for civilization that every individual should utilize, on the average, 1 kilowatt of power continuously, we can calculate that 3,000 million inhabitants of the earth could be supplied with power from the hydrogen of the sea for 1,000 million million years, or for about a million times the age of the earth itself. Thus, if this remote possibility is realized, mankind would have no need to look elsewhere than to the sea for all the power he can conceivably use in the lifetime of the solar system.

In conclusion I would emphasize that industrial power from uranium is on the doorstep and will almost certainly be used successfully, while power from hydrogen is only a remote possibility in the light of existing knowledge. In any case, the probability is small that any nuclear power will be available for useful purposes unless the problems of war can be solved, and that is a question for all mankind and not for the scientist alone. There is danger in all knowledge of nature. Scientific information can always yield guns as well as butter. It is a source of great regret to men of science that their work is made the basis of the indiscriminate destruction of man and his civilization, instead of contributing to the well-being of all.

Some Prospects in the Field of Electronics¹

By V. K. ZWORYKIN

Radio Corporation of America

[With 4 plates]

THE boundaries of the field of electronics, like those of almost any branch of technology, are vague. Enclosing within them everything in which the electron plays a vital function would certainly take in too much territory, yet restricting the domain of electronics to devices involving the employment of free electrons only would leave out such items as crystal triodes and diodes which, by reason of their function, have been quite generally claimed by workers in electronics.

It must be recognized, however, that until recently the free electron has been responsible for the role which electronics has come to play in the modern world. Its extraordinarily large specific charge makes it possible to impart to it high velocities with the aid of modern electric fields and to deflect its path with ease by either electric or magnetic forces. This is the reason for its effective use for the amplification of rapidly varying currents or voltages and the generation of high-frequency oscillations in the vacuum tube, for the indication of voltage and current variations in the oscillograph, and for the generation of picture signals in the television camera and the reconstruction of the televised scene in the viewing tube. The same property proves valuable in the detection and measurement of light by phototubes and in the generation of X-rays in X-ray tubes. Finally, in the electron microscope the scattering properties of matter for fast electrons, the nature of their interaction with magnetic and electric fields, and their wave characteristics combine to permit the use of free electrons to extend the recognition of microscopic detail by two orders of magnitude.

The history of electronics can conveniently be divided into four overlapping periods. In the first, ushered in by DeForest's invention of the audion and terminated, approximately, by the First World War, electron currents were controlled in vacuum tubes in much the same manner as a steam valve controls the flow of steam in a pipe. No more

¹ Reprinted by permission from the *Journal of the Franklin Institute*, vol. 251, No. 1, January 1951.

attention was paid to the behavior of the individual electrons in the tube than is customarily expended on the motion of the individual steam molecules in the valve. The English designation "electron valve" is singularly fitting for this period.

In the succeeding period, taking up much of the twenties and thirties, the directed, rather than random, character of electron motion in vacuum was applied in the cathode-ray tube and for improving the efficiency of amplifier and oscillator tubes by proper shaping and aligning of electrodes. The electrostatic secondary-emission multiplier phototube, in which secondary electrons are guided from one electrode to the next by a careful adjustment of electrode shapes, is a typical product of this epoch.

The third period, beginning some time before the Second World War, further subdivided the beams of electrons into groups and dealt primarily with the latter. This subdivision was either on the basis of time, the electrons being bunched at certain phases of an applied high-frequency field as in the klystron or magnetron, or of space, as in image-forming devices; the electron microscope and the image tube are typical representatives of this group. A somewhat different form of group selection, on the basis of time and place of injection, occurs in the betatron.

The fourth period in the development of electronics, in which we find ourselves at present, is concerned with the control of electrons within solids. Here, with crystal diodes, transistors, photoconductive pick-up tubes, etc., we have barely made a beginning. However, in large part with the aid of the typical products of the preceding periods, which are at the same time undergoing continuous further development, this period should prove at least as productive as any of the earlier ones.

Let us visualize some of the trends in the evolution of the electronic art in the near future. We may distinguish here between the development of new devices and the extension of their practical application. In the field of amplifying tubes and oscillators we can safely predict that the stress will continue to be placed more and more on types suitable for the very-short-wavelength region of the radio spectrum, where the time of travel of the electrons can no longer be neglected in comparison with a period of oscillation. In oscillators and narrow-band amplifiers the tube geometry will, as now, for example, in magnetrons and klystrons, be determined in large part by the frequency of the oscillation generated or amplified. At the same time, wide-band amplifying tubes will increasingly be provided by devices in which energy is exchanged between electron streams and traveling wave fields, as in the traveling-wave tube, the double-stream tube, and others. Similar techniques of energy interchange, in reverse direction, serve to provide high-energy electron beams in linear accelerators.

Concurrently, there will unquestionably be a continued great increase in the application of electronic components in all departments of life. In heavy industry case-hardening and annealing of metal parts by radio-frequency currents already plays a large role. Gluing of plywood, heat detonation of explosive rivets, sealing of metal tubes, welding of plastic sheet, and dehydration of antibiotics are other effective uses of radio-frequency heating. In the food industry the same technique may be employed for the sterilization of packaged foods and liquids, the blanching of vegetables, and specialized cooking operations. Food sterilization by bombardment with electrons in the million-electron-volt range also appears to be a promising field. In medicine radio-frequency fields may not only be employed for certain types of therapy but, in addition, the "radio knife," which seals the capillaries severed in an incision, is a valuable aid in surgery.

Up to this point we have considered the power output of electronic devices; of quite as great importance is their employment for analytical and diagnostic purposes. The use of very-high-energy X-rays for the detection of flaws in machine parts, facilitated by electron image amplifiers, will become increasingly standard practice. Similarly, spectroanalysis of the alloys used for machines and manufactured products with the aid of automatic recording equipment employing multiplier phototubes will be much more general than it is at present. Isotope tracer methods in chemical and metallurgical studies will call for scintillation counters and other electronic equipment in increasing numbers.

The same devices will find extended use for diagnosis, therapy, and research in medicine and biology. Many time-consuming routine operations, such as the making of blood counts, can certainly be carried out more speedily and accurately by electronic methods. Television techniques applied to the study of the variation in skin potential distribution already hold much promise for the rapid diagnosis of brain tumors and heart conditions, yielding information in much more readily interpreted form than that supplied by the conventional electroencephalograph and electrocardiograph. There can be little question that the measurement of body potentials and their variation, made possible by amplifying equipment of high sensitivity, will prove of increasing value in many other areas of medical diagnosis and biological research.

The electron microscope, also, is likely to find not only increasing use as a research tool in biology, chemistry, and metallurgy, but, on the basis of research findings, as a diagnostic aid as well. The introduction of smaller, more compact models of the electron microscope, supplementing the larger research instrument, should prove particularly valuable here, just as in routine chemical tests. At the same time, fundamental research probing into basic life processes, the

growth mechanism of crystals, and innumerable other frontier regions of knowledge will find the electron microscope indispensable.

Even broader in its applications than the electron microscope is the electronic computing machine. It not only supplies quantitative answers to problems in fields governed by known laws, however involved their application may be; it also greatly accelerates the discovery of laws governing physical phenomena through the rapid comparison of the predictions of a hypothesis with actual measurements.

There are two types of electronic computing machines: the analogue computer and the digital computing machine. In the former the variables in the equation to be solved are represented by electrical quantities, such as current or voltage, and the operations occurring in it, by the characteristics of the circuit and tube elements making up the computer. Both in principle and in function, the electronic analogue computer is closely related to the mechanical analogue calculating device, which, in the form of Bush's differential analyzer, ushered in the era of large-scale computing machines.

Examples of electronic analogue computers are MacNee's differential analyzer for the solution of ordinary differential equations (1)²; Goldberg and Brown's simultaneous equation solver (2); and the numerous auxiliary circuits employed, in radar technique and elsewhere, to simplify the presentation of data. By its very nature the application of the analogue computer tends to be specialized, its accuracy limited.³ Even so, it has proved its usefulness in countless ways, in a saving of time and effort and the elimination of human error.

By contrast, the digital computing machines are quite universal in their application and their accuracy is only limited by the number of significant figures that can be entered on them. As the name implies, the digital computer deals with numbers represented by a sequence of digits. The primary difference between the electronic digital computer and the familiar mechanical computing machine is a difference in the speed with which the electronic machine can perform the elementary arithmetical operations. This quantitative difference, however, leads to important qualitative differences: if the time in which the elementary arithmetical operations are performed is measured in microseconds, the basic advantage of the high speed of the machine is lost unless the time of transfer from one operation to the next also is measured in microseconds. This necessarily eliminates the role of a human operator from all intermediate operations and even prohibits the employment of mechanical devices in the major portion of

² Numbers in parentheses refer to references at the end of this paper.

³ Eventually, as in the simultaneous equation solver, a rapidly converging process of iteration may be employed to achieve results of arbitrary accuracy.

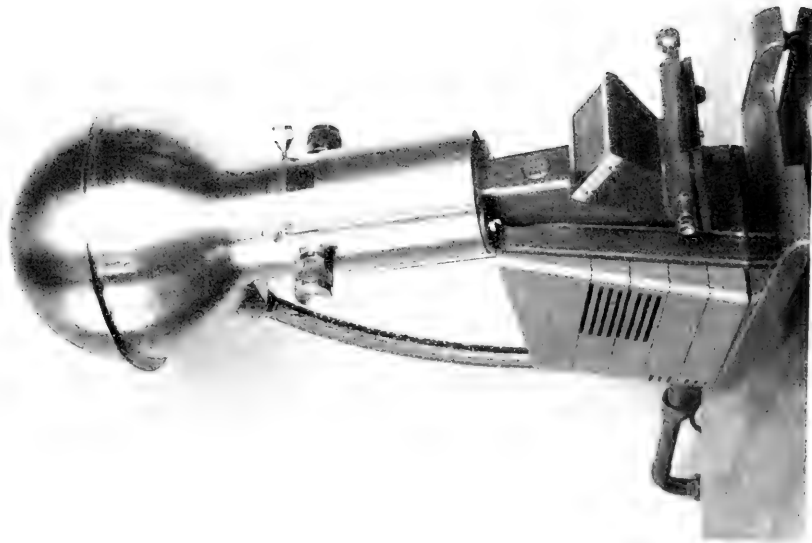

1. A MODERN DESIK-TYPE ELECTRON MICROSCOPE

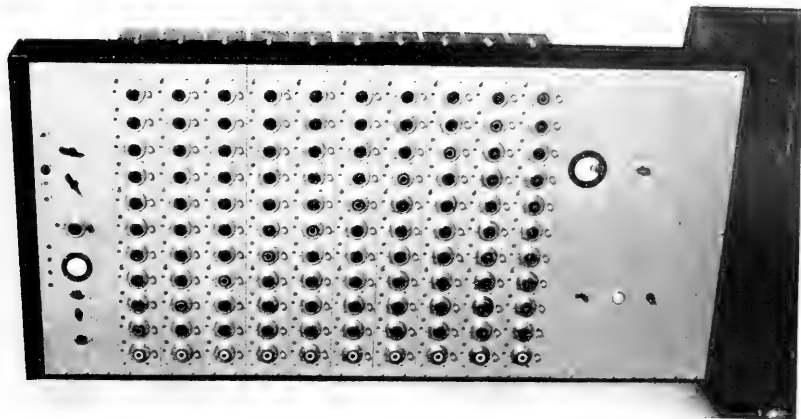

2. AN ELECTRONIC ANALOGUE COMPUTER THE SIM III —
TANEUS EQUATION SOLVER

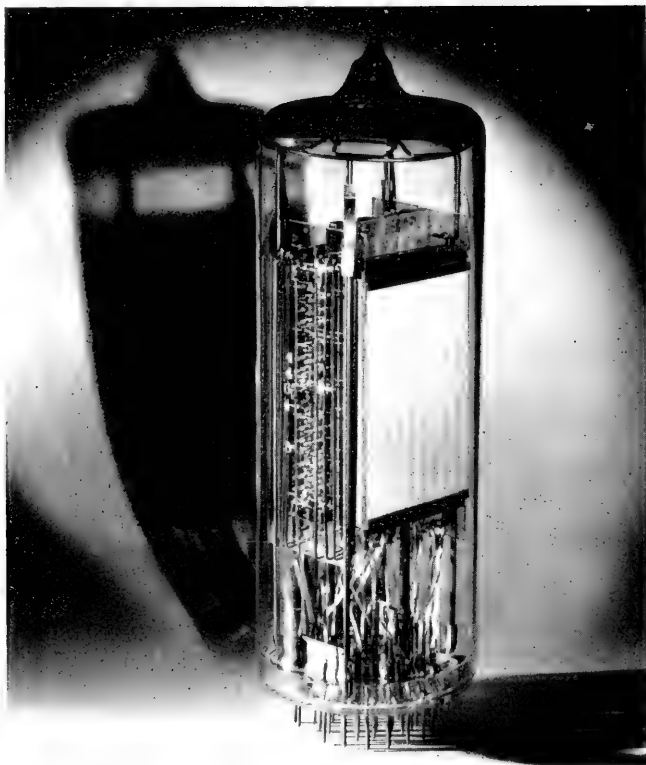

1. THE SB-256 TUBE, AN EFFICIENT ELECTRONIC MEMORY



2. SIZE REDUCTION AND SIMPLIFICATION IN TELEVISION PICK-UP TUBES: THE IMAGE ORTHICON AND THE VIDICON

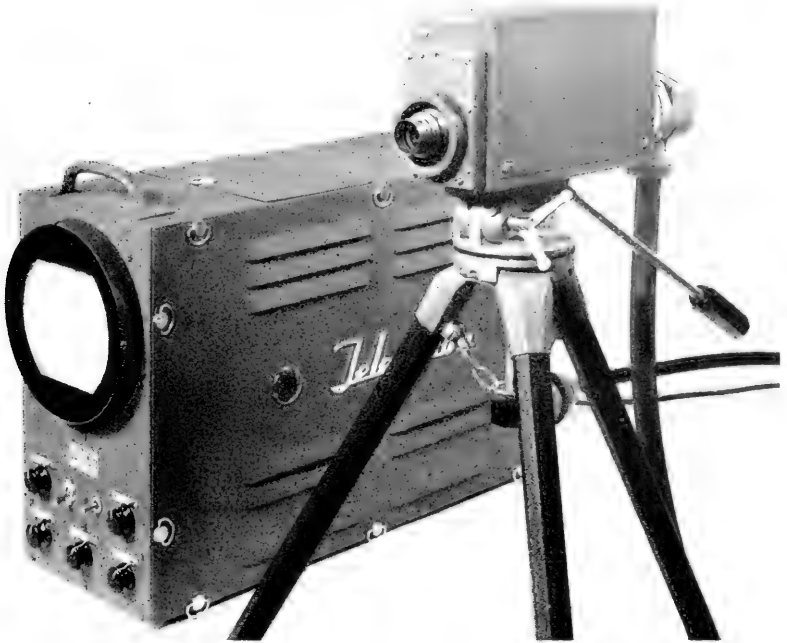

1. AN INDUSTRIAL TELEVISION SYSTEM: CAMERA AND CONTROL UNIT

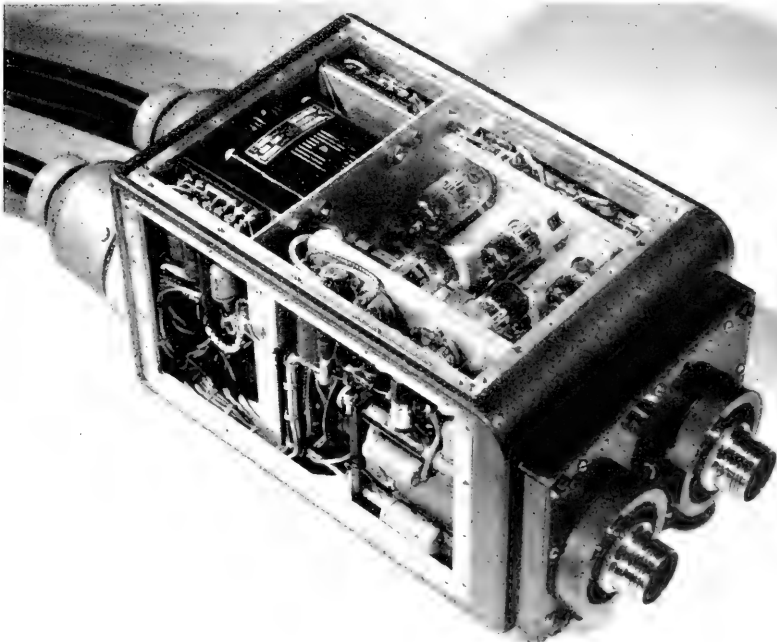

2. STEREOTELEVISION CAMERA FOR CONVEYING THREE-DIMENSIONAL IMAGES

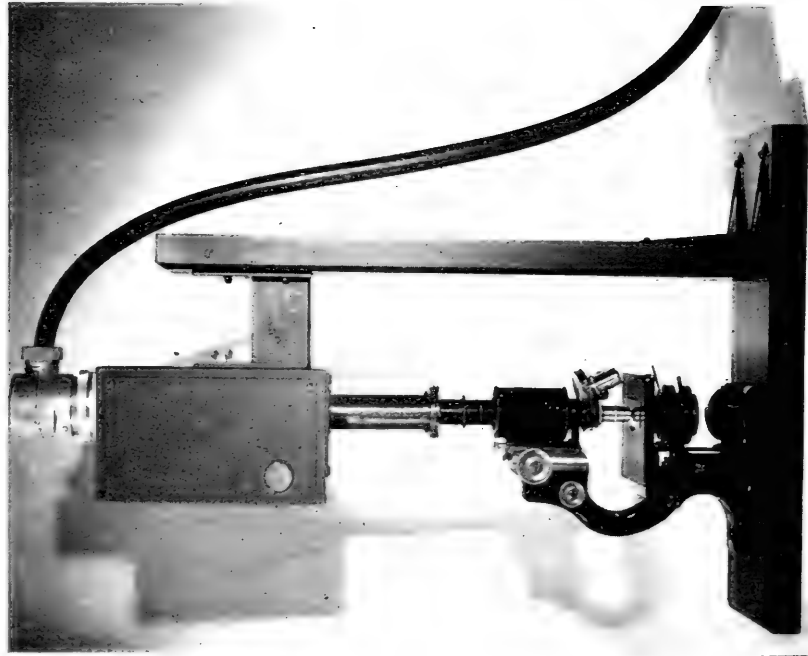

1. TELEVISION FOR THE CLASSROOM: INDUSTRIAL TELEVISION CAMERA MOUNTED ON A MICROSCOPE

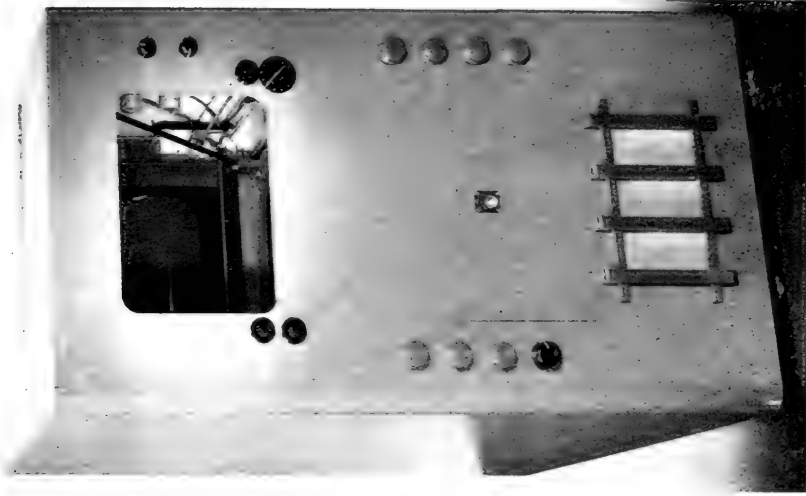

2. STEREOTELEVISION RECEIVER: POLAROID SCREENS IN FRONT OF THE TWO VIEWING TUBES AND IN FRONT OF THE EYES OF THE OBSERVER MAKE ONE IMAGE VISIBLE TO EACH EYE

the computation process. The human operator only enters in the setting up of the machine for a given calculation and the reading of the final results.

To perform its function effectively the electronic digital computer hence requires, in addition to a group of electronic computing units, a set of "fast" electronic memories, in which an intermediate result can be stored until needed for a later operation, as well as a command system on which the complete sequence of operations to be performed by the machine may be recorded. Additional "slow" memories, in the form of magnetic or punched tape, can be employed, furthermore, for the storage of large quantities of information, such as tables of functions, which may be fed into the fast electronic memories on order.

Much ingenuity has been expended in devising satisfactory electronic memories. The essential feature of all electronic memory devices is the presence of elements with two alternative stable states which are maintained indefinitely unless subjected to new electrical "writing" impulses. The Eccles-Jordan trigger circuit, containing two vacuum tubes so connected that, in equilibrium, one tube conducts while the other is cut off, constitutes such a single element of memory. More recent devices, such as the cathode-ray tube memory of F. C. Williams (3) and the SB-256 tube of Rajchman (4) by comparison, utilize the properties of the secondary emission of insulators to provide several hundred such elements (corresponding to the storage of an equal number of binary digits) in a single envelope.

The last few years have seen great advances in the magnitude, scope, and organization of digital computing machines. These will unquestionably continue and further expand the role of electronic methods in science and in our economic organization. It may well be, however, that electronic computation will achieve its greatest triumphs through the integration of analogue computing devices, with their ability to short-circuit extensive numerical calculations in specific applications, in digital computing systems. In fact, it seems scarcely thinkable that effective headway can be made with extremely complex problems such as are encountered in weather prediction unless all available techniques are combined to best advantage.

Possibly the most striking demonstration of the power of electronics to the average man has occurred in the field of television. The development of this new industry has far outstripped the predictions of the most extravagant prophets of a few years ago. It requires little imagination today to foresee for the television set a universality comparable to that of the kitchen range or the refrigerator. Numerous articles have dealt with the probable effect of this new factor on education, social patterns, and the economy, and I shall make no attempt to add anything to their conclusions. Technically, also, the

pattern for the future has in large part been established for broadcast television, with the creation of a sound basis for the smooth change-over or side-by-side existence of color and black-and-white television (5). Nevertheless, a host of interesting engineering problems, whose solution will lead to the simplification and improvement of different phases of television equipment and television service, remain to be solved and, to judge by the recent past, will be solved in original fashion.

There is another aspect of television development that has not received, and probably will not receive, nearly as much attention as broadcast television and that may yet, eventually, turn out to be of even greater significance. This is industrial television—the utilization of television techniques in industry, research, education, commerce—in short, in all fields apart from broadcasting. The basic industrial television system, in the form of a self-contained, cable-connected link incorporating a television camera and a combined viewing and control unit, enables the observer to transfer his vantage point to dangerous and inaccessible locations; to view simultaneously several spatially widely separated scenes; or to share an intimate view with a large number of other observers without mutual interference. The first condition is realized, for example, in the watching of carefully shielded radioactive reactions from a protected point, the checking of engine performance by a camera mounted on the underside of an automobile chassis, or the observation of the proper filling of the scoops in strip mining by a camera placed directly above the scoop; the second, by the simultaneous observation of indicating instruments at a number of substations from a central station; and the third, in the watching of surgical operations on television receivers linked to a camera mounted above the operating table or the presentation of microslides at high magnification to groups of students; in the last instance the microscope image is projected directly on the target of the pick-up tube in the television camera and the enlarged image is either viewed directly on a home receiver or projected on a screen by a theater projector.

In all these instances compactness and simplicity of the television camera are essential requirements. A great step forward in this direction has been the recent development of the vidicon (6), a highly sensitive television pick-up tube with a photoconductive target. This tube, though only 1 inch in diameter, is capable of transmitting high-quality television images at moderate light levels. Furthermore, the extraordinary simplicity of the vidicon simplifies control of the camera from a distance. In a typical example of present industrial television equipment (7), the control unit incorporating a monitoring kinescope is connected by a 500-foot cable to the camera. This cable

not only transmits the video signals from the camera to the kinescope, but, in the opposite direction, transmits electric power and centering, focusing, and deflection signals from the control unit to the camera.

The small dimensions of the new camera tubes also lend themselves well to their employment in color-television cameras transmitting simultaneously picture signals for the three primary-color components of the picture. Perhaps of even greater value in many practical applications is the observation of objects in three dimensions, made possible by the employment of a stereotelevision camera. Here two vidicon tubes, with a pair of objectives controlled by a single focusing movement, are mounted side by side. In viewing the stereoreceiver linked to the camera, the eyes of the observer are in effect translated to the position of the two stereocamera objectives, and, at the same time, endowed with the greatly increased focusing range or "accommodation" of the latter.

An example where such three-dimensional observation is particularly valuable is the presentation of surgical operations to medical students. Here the relative spatial position of the surgeon's tools, the incision, and the organs on which the operation is performed is of primary importance. The same also applies, of course, wherever television is employed for instruction in mechanical operations. The immediacy and flexibility of television demonstrations as compared, for example, with demonstrations by means of motion-picture film should render them an exceedingly effective aid in the process of education.

In the development of networks of television broadcasting stations we have witnessed the use of microwave links paralleling that of coaxial cables. In industrial television, too, situations arise which can only be met by the use of such links, even though this materially complicates control problems. Examples are the transfer of visual information from the ground to aircraft and vice versa, for example, as an aid to navigation, the transmission of scientific data from rockets, and the sending of astronomical information from balloon-mounted telescopes at a sufficiently high altitude to escape major atmospheric disturbances. The extraordinary range of applications of television is best realized when it is recognized that television does for the sense of sight what radio and the telephone have done for the sense of hearing. Insofar as the amount of intelligence acquired by the average person through vision is incomparably greater than that acquired through hearing, we can safely predict that the revolution wrought in our lives by television in its various forms may materially exceed that brought about by the development of means for auditory communication.

As I have already mentioned, the most recently developed television pick-up tube, the vidicon, employs a target consisting of a photoconductive material, that is, a material which conducts electric current under the influence of light. Employed in a simple photosensitive cell, such a material does not emit free electrons into space and hence does not fit into the realm of "electronics" in the narrower sense. Yet, materials from the larger family of the semiconductors, to which it belongs, are playing an increasing role in electronic apparatus—not only as components of tubes utilizing electron beams, such as the vidicon, but also quite apart from vacuum devices: in the form of the crystal rectifier and the transistor they fulfill certain requirements previously met only by vacuum tubes.

Whereas, at present, there is little reason for expecting wholesale replacement of vacuum tubes by their semiconductor equivalents—certain basic shortcomings of the latter militate against this eventuality—the crystal elements will not only find increasing use in specialized apparatus where compactness is of primary importance but will also be incorporated more and more into the design of more conventional electronic equipment. Here also the trend is toward compactness, as exemplified by the increasing use of printed circuits. In this connection the crystal diodes and triodes represent but one phase of a constant search for improved components for electronic apparatus. From another point of view, the intensive preoccupation with the properties of the solid state, which has led to their discovery and development, is creating a fund of knowledge that has already borne rich fruit in the development of efficient phosphors, ferromagnetic materials, and crystal counters. This is bound to contribute materially not only to the electronic industry, but all other industries as well, and to supply effective new tools for scientific investigation. Whatever the future of electronics may be in the ensuing half century, it is certain to profit from fundamental research as it has in the past and to repay its debt generously in the form of instruments and methods to carry out the tasks of research.

In the past half century electronics has demonstrated its ability to annihilate distance for both sound and sight. In countless ways it has aided human safety and relieved man of routine efforts. To the scientist it has proved itself an indispensable aid in research. No prophet is needed to state that, in the future, the application of electronics in these fields will be even wider, its usefulness even greater; more than that, as the past amply shows, no prophet can have sufficient imagination to predict, at the present time, just what forms these further applications, this increased usefulness may take. Yet one thing is certain: in the future as in the recent past electronics will

cooperate with the other branches of science and technology to achieve the satisfaction of physical needs, the extension of human knowledge, and the freeing of man's spirit for creative effort.

REFERENCES

1. **MACNEE, A. B.**
1948. An electronic differential analyzer. Massachusetts Inst. Techn. Res. Lab. Electronics, Techn. Rep. No. 90. Cambridge.
2. **GOLDBERG, E. A., and BROWN, G. W.**
1948. An electronic simultaneous equation solver. Journ. Appl. Phys., vol. 19, pp. 339-345.
3. **WILLIAMS, F. C.**
1949. A storage system for use with binary-digital computing machines. Journ. Inst. Electr. Eng., vol. 96, No. 3, pp. 81-100.
4. **RAJCHMAN, J. A.**
The SB-256 memory tube. (To be published in RCA Review.)
5. **RCA LABORATORIES DIVISION.**
1949. A six-megacycle compatible high-definition color television system. RCA Rev., vol. 10, pp. 504-524.
6. **WEIMER, P. K., FORGUE, S. V., and GOODRICH, R. R.**
1950. Vidicon—photoconductive camera tube. Electronics, vol. 23, pp. 70-73, May.
7. **WEBB, R. C., and MORGAN, J. M.**
1950. Simplified television for industry. Electronics, vol. 23, pp. 70-73, June.

The New Chemical Elements¹

By SAUL DUSHMAN

Research Consultant, General Electric Research Laboratory, Schenectady, N. Y.

ALL matter, mineral and organic, is made up of combinations or mixtures of elementary substances known as chemical elements. Before 1937 about 88 such elements had been found. About 30 of these elements occur on the earth, in the free or chemically uncombined state. Examples of such elements are: the gases hydrogen, oxygen, nitrogen, and argon, which occur in the atmosphere; the metals gold, platinum, silver, copper, and mercury; and the nonmetals carbon and sulfur. Each chemical element is made up of infinitesimally small corpuscles, which were originally designated atoms, because they were assumed to be indivisible. The atoms of any one element are the same in size, mass, and chemical properties. If we assign to the atom of the lightest element (that is, hydrogen) the atomic weight 1, then the atomic weight of uranium—until 1940 the heaviest known element—is 238. The diameters of atoms of the different elements vary from about one hundred-millionth of an inch to about three times that value.

About 50 years ago it was discovered that white-hot metals, when negatively charged, emit electrons. These have been shown to be extremely small particles each of which carries a unit charge of negative electricity and has a mass about 2,000 times smaller than that of the hydrogen atom. The diameter of the electron is about one hundred-thousandth of that of an atom. Also, at about the same time, the phenomenon of radioactivity was discovered; that is, it was observed that certain high-atomic-weight elements disintegrate spontaneously into elements of lower atomic weight. Thus it was recognized during the first decade of the present century that the atom is not a simple, spherically shaped little mass, without structure, but must be composed of still more elementary particles, which govern the observed chemical and physical properties of the different chemical elements.

¹ Talk presented at the General Electric Science Forum broadcast on December 27, 1950. Reprinted by permission from *General Electric Review*, vol. 54, No. 4, April 1951, with some revision by the author.

A first approximation to the solution of the problem regarding the structure of the atom was given, in 1911, by the late Sir Ernest Rutherford. As a result of a brilliant series of investigations, he reached the conclusion that the atom consists of a positively charged nucleus (or core) surrounded by as many electrons as the number of unit positive charges on the nucleus. This number is known as the atomic number of an element, and an element of atomic number X will be referred to in this article as element X . This number varies in value from 1 for hydrogen to 92 for uranium. Thus the uranium atom consists of a nucleus having 92 units of positive electricity and 92 electrons, revolving in orbits about the nucleus. Since the mass of even 92 electrons is about one-fiftieth of 1 percent of the mass of the uranium atom, it follows that nearly the whole mass of the atom is concentrated in the nucleus. And yet, since the diameter of the nucleus is only about one hundred-thousandth of that of the atom, we must conceive of the atom as an extremely miniature solarlike system in which most of the volume is just empty space.

The electrons external to the nucleus are arranged in shells or groups in a manner somewhat similar to the concentric crystal spheres in which, according to the medieval astronomers, the stars, sun, and planets were supposed to revolve about the earth as the center of the universe. With increase in atomic number, that is the charge on the nucleus, the electrons fill up first the innermost shells, and then the outer shells. There is a periodicity with increasing atomic number in the distribution of the electrons which corresponds to the periodicity in chemical and physical properties of the elements that had been previously observed in the latter half of the nineteenth century. Thus hydrogen consists of a nucleus of unit +ve charge and an electron located in the innermost shell. When one more +ve charge is added to the nucleus, the second electron which is required to neutralize the added +ve charge on the nucleus goes into the same shell as that occupied by the electron in the hydrogen atom and thus forms the atom of helium. With the addition of a third unit of positive charge to the nucleus the third electron enters into a second shell and we have the atom of lithium which is atomic number 3. As more positive charges are added to the nucleus the corresponding number of electrons enter into the same shell until we reach the atom of atomic number 10. This element is neon, which is chemically inert like He. This atom has two electrons in the innermost shell and eight electrons in the next outer shell. If we add eight more positive units to the nucleus the added eight electrons fill up a third shell, and the element of atomic number 18 is argon, which is a chemically inert gas similar to neon and helium. This periodicity of eight leads to groups of chemically similar elements. Thus the

elements lithium (atomic number 3), sodium (atomic number 11), and potassium (atomic number 19) all belong to the alkali metal group.

The next members of the group of inert gases are krypton (atomic number 36) and xenon (atomic number 54). Cesium of atomic number 55 (that is, 37+18) is a member of the alkali metals group. The periodicity of 18 is succeeded by a period of 32 elements, so that radon (radium emanation) of atomic number 86 is the next and last member of the group of inert gases.

Group	I		II		III		IV		V		VI		VII		VIII	O										
	a	b	a	b	b	a	b	a	b	a	b	a	b	a												
Period 1	H 1												H 1			He 2										
Period 2	Li 3		Be 4		B 5		C 6		N 7		O 8		F 9			Ne 10										
Period 3	Na 11		Mg 12		Al 13		Si 14		P 15		S 16		Cl 17			A 18										
Period 4	K 19		Ca 20		Sc 21		Ti 22		V 23		Cr 24		Mn 25		Fe 26		Co 27		Ni 28		Kr 36					
Period 5	Rb 37		Sr 38		Y 39		Zr 40		Nb 41		Mo 42		Tc 43		Ru 44		Rh 45		Pd 46		Xe 54					
Period 6	Cs 55		Ba 56		La-Lu 57-71		Hf 72		Ta 73		W 74		Re 75		Os 76		Ir 77		Pt 78		Rn 86					
Period 7	Fr 87		Ra 88																							
<u>ACTINIDE SERIES:</u>					Ac 89		Th 90		Pa 91		U 92		Np 93		Pu 94		Am 95		Cm 96		Bk 97		Cf 98		--(103)	
<u>LANTHANIDE SERIES:</u>					La 57		Ce 58		Pr 59		Nd 60		Pm 61		Sm 62		Eu 63		Gd 64							
<u>(RARE EARTHS)</u>					Tb 65		Dy 66		Ho 67		Er 68		Tm 69		Yb 70		Lu 71									

FIGURE 1.—Periodic arrangement of elements.

This periodicity in the distribution of the electrons in shells corresponds to a periodicity in chemical and physical properties of the elements when these elements are arranged in order of increasing atomic number, as shown in the periodic arrangement of elements, figure 1.² Thus we find that the elements fall into eight groups, with chemically similar elements in each group.

Such an arrangement was first suggested in 1870 by the Russian chemist Mendeléeff and was based on the arrangement of the elements in order of increasing atomic weight. With further discovery of new elements and more accurate determinations of atomic weights

²From *Fundamentals of Atomic Physics*, by S. Dushman. New York, 1951.

it became evident that for some of the elements the order based on atomic weights did not agree with the order predicted on the basis of chemical properties. The reason for this discrepancy came after Rutherford's suggestion of the nuclear structure of the atom and as a result of a series of investigations by Moseley and others on the X-ray spectra of the elements.

Turning now to a consideration of the structure of the nucleus, it was discovered, in 1934, that besides the electron, and the proton, which is the nucleus of the hydrogen atom, there also exists in all the nuclei another elementary particle, the neutron. This particle has zero charge and a very slightly higher mass than that of the proton. Our present view, therefore, based on this discovery and a larger number of observations, is that the nucleus contains both neutrons and protons. The number of protons is the same as the atomic number (that is, the number of extranuclear electrons) and the number of neutrons is equal to the difference between the atomic mass and the number of protons.

Since the chemical properties of an element are governed solely by the atomic number (that is, the number of protons), it is possible to have two or more kinds of atoms which are chemically inseparable, but which have different atomic masses. This is because of differences in the number of neutrons in the nucleus. Such atoms are known as isotopes. Thus, the nucleus of ordinary hydrogen is designated the proton; but there is also an isotope of hydrogen of mass 2, the nucleus of which consists of a proton and a neutron. This nucleus is designated the deuteron; and while it has the same charge as the proton, it has about twice the mass of the proton. A large number of the elements have two or more isotopes, and in the case of the heavier nuclei, these are radioactive; that is, they decay spontaneously with emission of high-speed electrons, or gamma rays, or α particles. The latter are the nuclei of helium atoms and consists of two protons and two neutrons. Now the very important discovery has been made that it is possible to transmute nuclei of a radioactive element number X into nuclei of an element number $X+1$ or $X+2$ by bombardment with protons, deuterons, or helium ions. Since protons and deuterons have a nuclear charge of one positive unit and alpha particles have a nuclear charge of two positive units, these particles may be accelerated to very high velocities by means of high voltage in much the same manner as electrons are speeded up by high voltage in an X-ray tube. The velocities thus acquired by the positively charged particles are of the order of one-tenth to one-half of the velocity of light. Under these conditions, the particles gain sufficient energy to enable them to penetrate and combine with the nucleus of a bombarded atom of element number X . The result is an atom of element number $X+1$ or element number $X+2$, depending upon whether singly-charged

particles or doubly-charged particles are used as bombarding projectiles. That is, an atom of the bombarded element (number X) is transmitted into an atom of a totally different chemical element, of higher atomic number.

It is in this manner that the four elements previously missing below uranium, and also elements of higher atomic number than uranium, have been synthesized in recent years.

The first of the elements to be synthesized in this manner (in 1937) was number 43. Molybdenum is number 42, and by bombarding this element in a cyclotron with deuterons, the new element, number 43, was obtained. Since it was the first element produced artificially or technically, it was designated technetium (Tc). Chemical tests showed it to be an element chemically similar to manganese, as had been expected.

In 1938, element number 61 was produced by bombarding neodymium, element number 60, with deuterons. It corresponds to a long-sought-for element, hitherto missing in the series of 15 rare-earth elements which occur in the periodic arrangement between barium (number 56) and hafnium (number 72). This newly discovered element has been designated promethium (Pm).

In 1940, element 85 was produced by bombardment of bismuth, which is number 83, with high-speed helium ions. The new element was identified as a member of the same chemical group as chlorine, bromine, and iodine. Accordingly, it was designated astatine (At), signifying "unstable."

Francium (Fr, atomic number 87) was discovered in 1939, as a short-lived radioactive form that occurs in the decay of other radioactive elements such as uranium and radium. It corresponds, chemically, to the long-sought-for element "eka-caesium," which belongs to the same alkali group as caesium.

With the synthesis of these four elements all the 92 places in the periodic arrangement of the elements, beginning with hydrogen and ending with uranium, were completed. But in the course of the investigations on the fission of uranium, four new transuranic elements (that is, elements beyond number 92) were discovered. The first of these, number 93, was produced in 1940 by irradiating uranium with deuterons and was designated neptunium (Np), by analogy with the planet Neptune, which is beyond Uranus.

Element 94 was produced, later in 1940, by bombarding uranium with α particles. Again, by analogy with Pluto, the outermost of the planets, this new element was designated plutonium (Pu). Both neptunium and plutonium are produced in the atomic pile as a result of the emission of neutrons by the isotope of uranium, of mass 235.

By irradiating plutonium with helium ions, element 96 was synthesized in 1944 and designated curium (Cm). In 1945 the element

95 was discovered by a group of investigators engaged on the Plutonium Project and designated americium (Am), by analogy with europium, number 63, which is a member of the rare-earth series. Theoretically, this new element could be synthesized by bombarding plutonium with deuterons. Finally, early in 1950, it was announced by a group associated with Dr. Seaborg, working at the University of California, in Berkeley, that two elements of still higher atomic numbers had been synthesized. Element 97 was produced by bombarding americium, number 95, with 30- to 35-million-volt energy helium ions. To this element the name berkelium (Bk) has been assigned. Element 98 was synthesized, in the same manner, by bombarding curium (number 96) with high-speed helium ions, and this new transmutation product has been designated californium (Cf).

A list of the elements discovered since 1901 is given in the accompanying table.³

Elements discovered since 1901

Name	Chemical symbol	Atomic number	Date of discovery
Lutetium.....	Lu	71	1907-08
Protactinium.....	Pa	91	1917-18
Hafnium.....	Hf	72	1922
Rhenium.....	Re	75	1925
Promethium.....	Pm	61	1937
Astatine.....	At	85	1940
Francium.....	Fr	87	1940
Neptunium.....	Np	93	1940
Plutonium.....	Pu	94	1940
Curium.....	Cm	96	1944
Americium.....	Am	95	1945
Berkelium.....	Bk	97	1950
Californium.....	Cf	98	1950

In the periodic arrangement of elements (fig. 1) it will be observed that between Ba (atomic number 56) and Hf (atomic number 72) there is interposed a group of elements, which are chemically very similar and are known as the "rare earths" or lanthanide series. The reason for the occurrence of 15 such chemically similar elements was deduced from a study of the permissible electron configurations of the elements. The same reasoning also leads to the prediction of the existence of the actinide series consisting of elements of atomic numbers 89 to 103, inclusive. That is, we should discover elements chemically similar to Bk and Cf of still higher atomic number.

³ From *Fundamentals of Atomic Physics*, loc. cit.

Whether any such elements will be discovered of still higher atomic number is problematical, since all the elements beyond uranium are unstable—that is, they disintegrate rapidly. The main fact revealed by the syntheses of the new chemical elements is that the atoms of the different elements are not really the elemental particles of nature. Rather, the atoms themselves are constituted of three still more elementary particles, namely, electrons, protons, and neutrons. We know, in fact, that in the hottest stars, in which the temperature near the center is about $100,000,000^{\circ}$ C., some of the atoms themselves have been decomposed into these three elementary particles. Of course, other particles have been observed, but whether they are essentially elementary remains to be discovered.

This is certainly not the last word on the whole subject. However, whatever the future may reveal, we believe that we have made one more step forward in acquiring some knowledge of that great universe about us, of which we can be only reverent observers and humble interpreters.

The Insides of Metals¹

By CARL A. ZAPFFE

Metallurgist, Baltimore, Md.

[With 4 plates]

Lost in antiquity are the origins of many methods used for examining metals, but the epochal discovery of the optical microscope a few hundred years ago originated the study of metals at high magnification. In its early stages, investigation with the microscope was limited to an exploration of surfaces. This was uninformative because the principle service of metals lies in their strength, hence in their internal constitution. The French scientist de Réaumur in 1722 and Sweden's Swedenborg in 1734 advanced the application of the microscope somewhat by studying the surfaces of fractures of metals, which disclosed some information regarding the manner in which metals are constituted. However, the difficulty of bringing the microscope lens close to the jagged surface of a fracture discouraged, for more than two centuries, these and all later scientists from developing such an application.

Among students of minerals, the microscope became a tool—and a great one—principally through the discovery in 1849 by Henry Clifton Sorby that minerals could be examined by transmitted light if they were sliced sufficiently thin. This introduced the thin-section technique, which is the bulwark of the science of petrography and mineralogy today.

Metals, in considerable contrast to most minerals, are completely opaque and do not submit to such thin-section study. Gold leaf has been beaten so thin that it transmits some light, but this is an exception which contributes nothing to the problem. It was at the close of the last century that metallurgists in Europe discovered the method of polishing and etching the surface of sections cut through metals to disclose their inner structure, and this has been the means of providing almost the entire body of technical information on the microscopic constitution of metals to date.

¹ Reprinted by permission from *Physics Today*, vol. 3, No. 9, September 1950.

POLISH-ETCH METHOD

According to this method, a metal or alloy is simply cut with a saw through some section intended for study. The saw-cut surface is then ground flat and further polished with increasingly fine emery papers and buffing cloths until the polishing scratches are so minute as to be no longer visible at even relatively high magnification. Such treatment produces, of course, a superficial layer of highly distorted metal which completely conceals the true internal formations. This layer is then removed by carefully selected chemical reagents, determined through much research to provide certain characteristic effects depending upon the microscopic structure of the metal.

The reagent eats off the thin and disorganized superficial layer and then attacks the underlying metal—but to a degree dependent upon subtle differences in composition and structure. The result is a differentiated mottling, whose pattern is characteristic for the condition and hence is metallurgically informative. This is shown in plate 1, figure 1, for an alloy of equal parts of bismuth and antimony, at a magnification of 225 diameters. The specimen was cut with a saw, ground, polished, and etched with a solution of iron chloride in hydrochloric acid. The superficial layer was entirely removed, and the underlying metal was attacked in the elaborate manner shown. The peculiar light-colored skeletons are known as dendrites because of their tree-like form, the word coming from the Greek “dendron,” meaning tree.

Dendrites express a uniform peculiarity in the growth of crystals which causes them to grow from the fluid state in the form of branching growths. When an alloy—which is a mixture of two or more metals—solidifies from its liquid, the first solid to construct the dendrite is richer in the metal having the higher melting point. The remaining liquid is relatively rich in the metal of low melting point, and it is this that fills in between the branches of the dendrite. When an etching reagent is chosen which attacks one of the metals more than the other, the difference between the trunk and the interbranch material of the dendrite is made visible by the difference in chemical attack.

FRACTOGRAPHIC TECHNIQUE

While the polish-etch method has yielded a tremendous amount of information on the constitution of metals, it also has important limitations. For example, the remarks that have just been given will make it clear that the polish-etch technique would supply relatively little information for a pure metal. No constitutional differences exist, and attack by a chemical reagent would accordingly be uniform. About the only exception is a preferential attack at the boundaries of the individual grains and the fact that the separate grains are distin-

guished. Peculiarities existing within the grain itself, however, become for the most part unobservable.

About 10 years ago, the centuries-old method of de Réaumur and Swedenborg was tried again, this time with a fresh attack and with the benefit of modern improvements in the construction of the microscope. A special fractographic stage was designed which allowed the investigator to study nascent fracture surfaces, although this time not by exploring the general appearance of the fracture, but by exploring detail within the individual fractured grain. Metals are vast composites of minute crystals, called grains, and the older technique had done little other than view the surface of the entire assemblage. With modern fractography it is not the forest but the individual tree that is being observed.

For the past 4 years fractography has been the subject of a special study in the author's laboratory, principally under the sponsorship of the Office of Naval Research, and the research from which this review stems has been largely conducted by F. K. Landgraf and C. O. Worden. Many fascinating new features of metals, also other crystals, have been discovered. Just a few of these will now be given to show the astonishing elaboration to be found within the boundaries of the microscopic grain itself, and the many significant research fields inviting further exploration with this new tool.

In plate 1, figure 2, a fractograph of pure metallic bismuth is shown. The entire field of the photograph belongs to a single grain, as is proved by the fact that its markings have a common geometric relationship. If this specimen had been polished and etched, nothing would appear but a more or less blank surface, the grain boundary lying outside the field of observation.

On the other hand, one finds in the fractograph a wide assortment of markings. The most prominent of these are bands which are placed at exactly 60° with one another, forming equilateral triangles where all three directions appear. These are now known to be "twins," which means that the atoms throughout the region of the twin band have been forced into a certain special relationship with one another by the impact which fractured the metal. The fact that these twin bands lie at exactly 60° to one another is highly significant, for it reveals that the fracture has traveled along a special plane in the bismuth crystal—a crystal face that is the weakest link. This plane is the so-called basal plane, and is similar to the prominent cleavage plane that characterizes crystalline graphite, also mica. It has further been determined that the twin bands are intersections of three sloping crystallographic planes that form a low pyramid on the basal cleavage plane.

Lastly, close observation will show some sharp cleavage edges, representing profiles of fractures on other crystal planes. The most prominent of these has been found to be a set also forming a pyramid, like the twins, but about twice as high. The story of deformation and fracture for this metal is thus written into the subtle markings on its fracture facets.

THE FRACTURE OF STEEL SHIPS

From such observations of the path of fracture through the individual grains in a metal all these deductions can be made, and many more. A particularly important instance has to do with a problem involving both the loss of material and human lives.

During the recent war, more than 40 of the welded steel ships made in this country fractured completely in two, and there were more than 4,000 reported cases of lesser fractures. The problem is one of an elusive property, simply called toughness, whose identification remains a great challenge in current metallurgical research.

Two steels, identical in virtually every respect so far as common analysis is concerned, will behave so differently when placed in service, such as that of deck plate, as to cause shipwreck in one case and no trouble whatsoever in the other. Extensive researches conducted in many laboratories about the country, principally under sponsorship of the United States Navy, are now showing that the temperature range in which this change occurs is radically different for different steels. The fundamental reason for this difference remains unknown.

Nevertheless, fractographic study—as a new tool applied to the problem—has recently been shown to disclose a clear distinction between steel that will fail and steel that will not fail in service in a given range of temperature. Plate 2, figure 1, is a fractograph of a steel that is known to be tough. At a magnification of 1,000 diameters, an individual grain shows a pattern reminiscent of coral. The grain itself is very small—only a tiny fraction of the size of the bismuth crystal in the previous plate 1, figure 2—and there is no flatness anywhere in the fracture field. When this steel fractured, here due to a hammer blow at -196° C., the separation was continually impeded by the observed minute roughness as it traveled through the metal. The fractograph shows this pattern of roughness visually, which can therefore be interpreted as a pattern of toughness.

A sharply contrasting fracture facet is shown in plate 2, figure 2, for steel that is of similar composition to that shown in the previous figure, but is known by much mechanical testing to be inferior with respect to toughness. The magnification is the same as before, 1,000 diameters; and the facets are seen to be about equal in size. A marked difference, however, lies in the comparative smoothness of

the pattern in plate 2, figure 2, which gives visual evidence for the fact that fracture has traversed the grains in this steel without the consistent interruption experienced in the tougher steel.

While it is too early to point to useful application of this discovery with respect to the ship-plate problem, the contribution still being in the research stage, its promise is indicated by the fact that the contrast between plate 2, figure 1, and plate 2, figure 2, is outstanding, whereas previous microscopic methods have revealed no detectable changes. In addition, the application of mechanical testing to this problem has involved the construction of huge testing machines at great cost, and much of the steel is destroyed in its testing. Fractography requires only a fractured chip and a microscope, and there is good reason to believe that the information obtained from the chip serves as well for the entire heat of perhaps 100 tons of steel.

METALS FOR SERVICE AT HIGH TEMPERATURES

In the new and important field of metals for service at very high temperatures—gas turbines, rockets—there is an application of fractography that can already be described.

A pattern appears in plate 3, figure 1, which has some aspects of a good detective story, and has proved of great importance in the production of molybdenum metal. Molybdenum has one of the highest known melting points for any metal in the periodic system. At temperatures of white heat, where the strongest steel has not only melted, but begins to boil, molybdenum scarcely begins to melt. This fact simultaneously makes the metal a very attractive one for special services at high temperature, but one difficult to produce. A special furnace was finally designed a few years ago which melted molybdenum in vacuum by means of an electric arc. Castings of promising size and solidity resulted, but when they were subjected to the difficult forging operations they would often fracture.

To shorten a long research story, the metallurgists at the Climax Molybdenum Corp. in Detroit found that fractographic examination of a small chip broken from the casting with a hammer always reflected one of two characteristic patterns. The first was feathery in its appearance and connoted forgeable metal. The second was pearly and granular and always meant nonforgeable metal. Depending upon the presence of one or the other of these patterns, determined by a brief and simple fractographic examination, the processing of the ingots was directed either toward forging or remelting.

In the upper portion of the field in plate 3, figure 1, the "feathery" constituent is clearly visible. These small markings, resembling oat-heads, are now known to be molybdenum carbide. In the lower half of this same field is a weedy-looking growth of the fine granular

material now known to be molybdenum oxide. Both of these intruding constituents form in the boundaries of the individual grains—the carbide increasing cohesion, and the oxide destroying it. Here one is accordingly looking, as a special case, at the external surface of an individual internal grain—not its internal surface as in previous figures—and under the remarkable circumstance of finding both of the counteractive phases present. The carbide and oxide react, of course, to form carbon oxide gas, which is removed by the vacuum treatment. Here one can actually visualize the oxide caught in the act of invading a region of carbide feathers, destroying them as it advances.

THE MICELLAR THEORY

While such discoveries as the preceding readily lead to practical applications, a matter of far greater scope and interest is highlighted by fractographic patterns.

A century and a half ago, a great French mineralogist and crystallographer, Haüy, established what is now known as the Law of Rational Indices in crystallography and laid down a description for the physical constitution of crystals which endured for many years. Haüy spoke of the “*molécules intégrantes*,” which were presumed to be minute building blocks—perfect microscopic crystals—which fitted together to comprise the macroscopic crystal. Virtually every scientist of that period accepted the theory that crystals were built of tiny crystallite units. The impact of atomic theory and space-lattice theory in the latter nineteenth century, and particularly X-ray diffraction in 1912, temporarily shattered this picture to replace it with a conventional concept of regular atomic structure extending from the atom individual up to the boundary of the crystal or grain.

Nevertheless, in the past several decades, this picture of the homogeneous atomic lattice has come under sharp criticism from many angles of research in which crystalline substances persist in showing a markedly subdivided structure on a scale far more minute than the individual grain, yet much greater than the atom. Many theories have been advanced to explain this anomaly, and these can be reviewed in most current textbooks on physics. It is now becoming widely agreed that most crystals, if not all, have a finely subdivided structure. The nature and the origin of that structure, however, constitute one of the most hotly argued problems in metallurgy and physics today.

Briefly, the principal contention rests upon the question whether the subdivision results from imperfections and accidental submicroscopic cracking, or whether it is a fundamental result of the surfaces of previous submicroscopic units that come together at the time of freezing to form the solid.

For the first concept, "dislocations" currently provide the most popular picture. These are the result of vacant or improperly filled atomic positions in an otherwise regular lattice; and their propagation and motion throughout the body of the crystal are believed to develop the observed subdivided structure.

For both concepts, the term "mosaic" has been widely used, expressing a picture of a gross form built from small fragments, the misfits of the mosaic blocks creating the subdivisions in question. The mosaic block is usually pictured as the result of microcracking, but it has also been related to a preexistence in the liquid.

Recently a theory has been proposed by the author in which the mosaic block is described as a *micelle* specifically originating in the liquid and having fundamental thermodynamic reasons for its separate existence. This word is borrowed from the organic chemists, and means a small repetitive arrangement of a given atomic or molecular species, having the form of a tiny crystallite. Such clusters are believed to be present, according to the micellar theory, in the liquid and even in the gaseous phase prior to solidification. The theory particularly postulates their existence within single homogeneous phases, such as that of a pure metal. A phenomenon of this type is known in colloid chemistry, the liquid being called an isocolloid.

As early as 1907, one of the founding scientists of colloid chemistry, P. P. von Weimarn, proposed a somewhat similar concept, and it has since been discussed by Alexander in America, Klyatchko in Russia, and Yoshida in Japan. The present micellar theory, published in 1949, differs in certain respects from those earlier described. It was designed specifically to explain the problem of imperfection structure in the solid state.

Without going into any of its technical details, the theory can be described as postulating the formation of clusters of atoms (or molecules) in the homogeneous liquid state as the result of a balance among four principal thermodynamic variables: 1, temperature; 2, pressure; 3, composition; and 4, surface tension. The net result is the production of a liquid which in effect is a mass of tiny solid particles swimming in their own debris. The size and form of the particles are determined by thermodynamic and crystallographic factors. When the temperature is reduced to what is known as the freezing point, these minute crystallites attach to one another, orienting their own atomic alignments with respect to one another as far as allowed by the freezing conditions, and thus form the solid. The mosaic block is now the micelle; and the subdivisional structure is the result of the persisting micelle boundaries.

Returning to fractography, plate 3, figure 2, shows the pattern of a fracture which passed through a grain of cast molybdenum—in

contrast to plate 3, figure 1, where it traversed the boundary. This elaborate pattern is believed to represent a frozen record of the growth pattern during the time that the micelles of the liquid state were orienting and transfixing to form the solid. The roughly parallel bands are believed to result from pulsations in the solidifying front. This metal was cast—it will be recalled from earlier description—under the conditions of an electric arc at extremely high temperature, and it solidified in a water-cooled copper crucible. These are violent freezing conditions for a metal melting near 2620° C. (4750° F.). The story of solidification read from the fractograph in plate 3, figure 2, would show this grain to have formed from the upper left corner toward the lower right, the micelles rotating and orienting with one another sufficiently to produce a single crystal, but remaining slightly displaced from one another and misfitted sufficiently to set up a special pattern of weakness, which then showed itself fractographically by deflection of the fracture traverse in accord with the pattern misfit.

Finally, in plate 4, a pair of fractographs adds further description to the micellar concept, and in addition shows an unusual application of the fractographic technique. A specimen of plain iron (Armco ingot iron) was annealed at 1250° C. for 2 hours and slowly cooled in the furnace to remove effects of previous mechanical strain and to increase the grain size. The metal was then embrittled by forcing atomic hydrogen into its structure. This was accomplished by making the specimen the cathode (negative electrode) in an electrolytic cell. Iron absorbs hydrogen, but only atomic hydrogen; and, on the surface of the cathode, protonic or atomic hydrogen is deposited by the electric current passing through the solution—here 10 percent sodium hydroxide. It is known from extensive research that this atomic hydrogen enters among the atoms of the iron, probably diffusing through interatomic interstices, and then later precipitates at certain well-defined places within the body of the grain—the intermicellar boundaries, according to the micellar theory. The result is a marked loss of ductility; and it is said that the metal is suffering from hydrogen embrittlement.

The iron in plate 4 was fractured while embrittled with hydrogen. The two fractured halves of the metal were separately mounted on the microscope, and a fractograph was taken of the same facet on the two matching halves of the fracture. These two fractographs are mounted facing each other in plate 4, constituting obverse and reverse views of the fracture traverse through the single grain. Thus, one can follow the various markings as they appear to either side of the fracture. Most markings appear on both sides, but some do not; and there are provided some informative differences.

However, particular attention is called here to other matters. First is the fact that the outstanding markings are at exactly 90° to one another. This is because iron fractures on a crystal plane that can be described as the face of a cube. Just as the hexagonal-rhombohedral bismuth crystal in plate 1, figure 2, displayed equilateral triangles, so the cubic iron shows squares and rectangles. Here intersecting cleavages provide the cubic symmetry, rather than twins. Even the meandering markings will break down on close observation to show themselves as minute stepwise composites of 90° markings. The whole pattern, and particularly these tiny stepwise markings, give strong expression to an elaborate architecture existing within a single grain; and they certainly stand as impressive evidence in the favor of a general micellar theory. Little wonder that Haüy hypothesized his "molécules intégrantes." The grain is visually composed of tiny sub-grains, or micelles, and without them it would be difficult to explain the pattern.

A NEW ERA OF ENGINEERING MATERIALS?

Many things must be left unsaid in a brief review of so vast a subject; but one particular issue follows from all this work which holds extravagant promise for future developments in engineering and hence in civilization itself. This is the fact that calculations, using many different approaches, all agree that the atoms of metals actually cohere with strengths of the order of several millions of pounds per square inch. Today the greatest achievement in engineering materials is of the order of two or three hundred thousand pounds per square inch. The reason that the observed strengths of materials are so vastly inferior to the theoretical atomic cohesion is generally agreed to be the subdivisional structure within the grain. The only thing not yet agreed upon is the nature and the origin of that substructure. The type of microscopic study here described greatly increases the information on this prize problem of solid-state physics.

For a better understanding of the problem, the micellar theory has been offered. Right or wrong, the solution is certainly nearer; and, when the answer is found, it will bring with it a definite possibility of utilizing a new order of cohesive forces in developing the full theoretical strength of metals and perhaps other engineering materials.



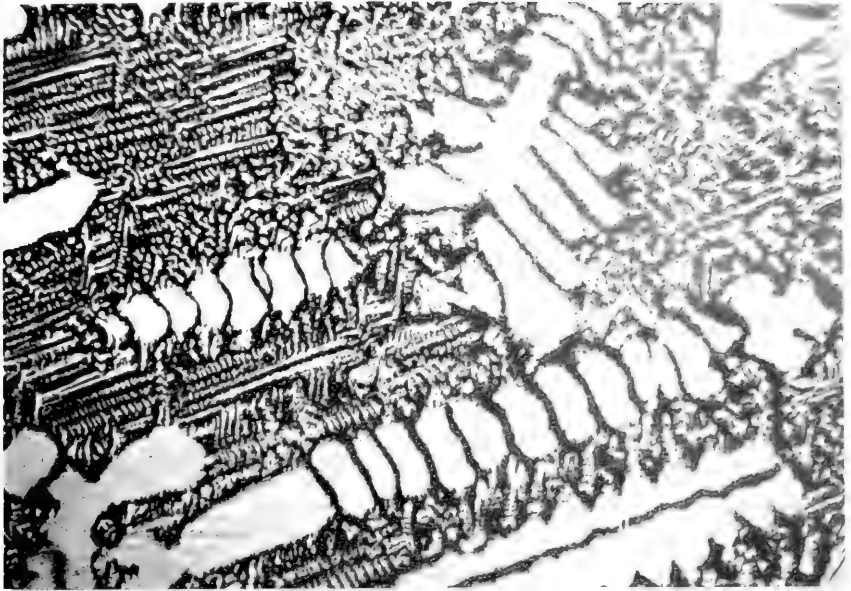

1. Photomicrograph of 50:50 antimony-bismuth alloy after sawing, polishing, and etching with a chloride solution. The white skeletonlike forms are dendrites, representing a phenomenon of growth generally characteristic of all organized matter, from crystals to plant and animal life. They contain excess antimony and resist chemical attack. Magnified 225 times.

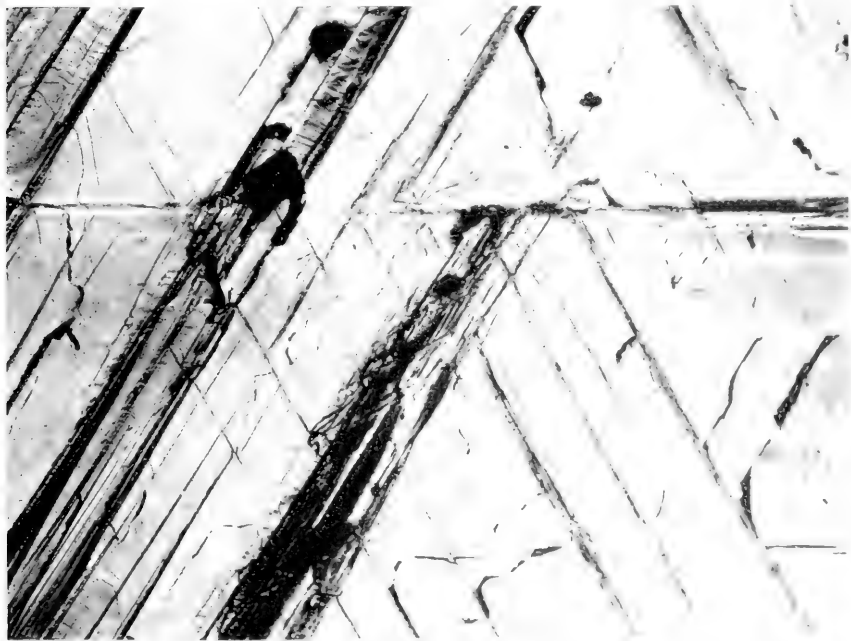

2. Fractograph or photomicrograph of an unpolished surface of metallic bismuth, showing geometric markings and fracture. Magnified 35 times.

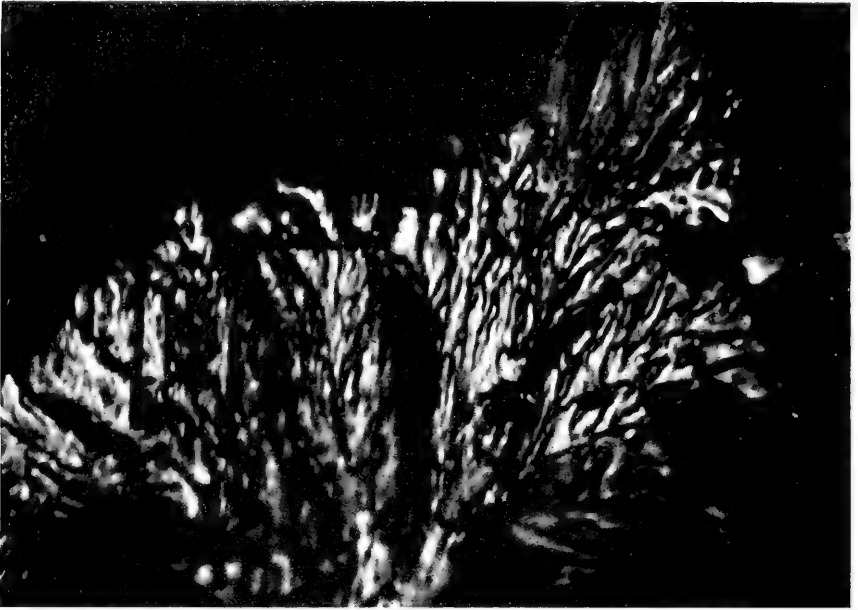

1. Fractograph of a tough steel suitable for such construction as ship plate. The individual grain is very small, causing fracture to change its path much more frequently as it jumps from grain to grain; and the microscopic path through the grain itself is rough and tortuous, as illustrated visually by this coral-like pattern of toughness. Magnified 1,000 times.

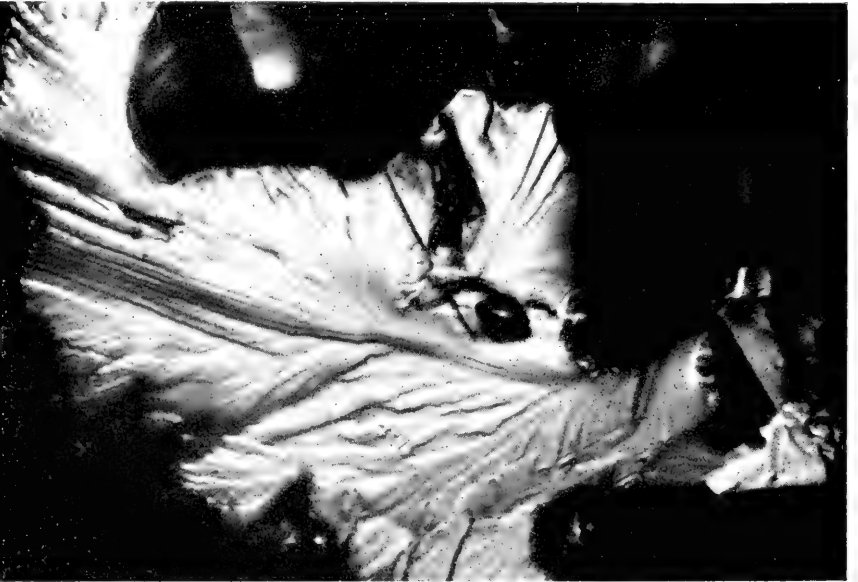

2. Fractograph of a steel which, in contrast to that in figure 1 above, lacks toughness and is unsuited for such applications as ship plate. The facet of this individual grain is comparatively smooth, showing much less interruption of the progress of fracture than in the previous figure. Magnified 1,000 times.

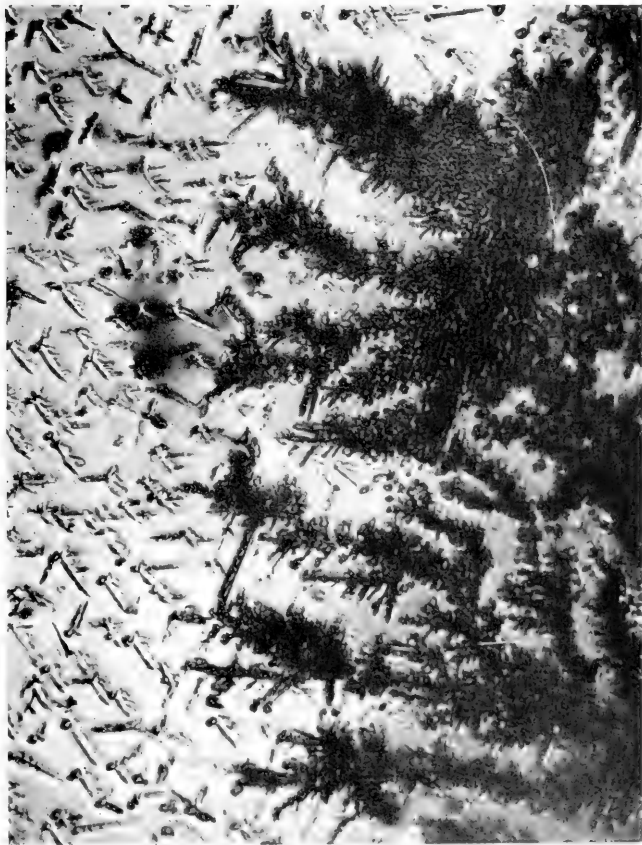
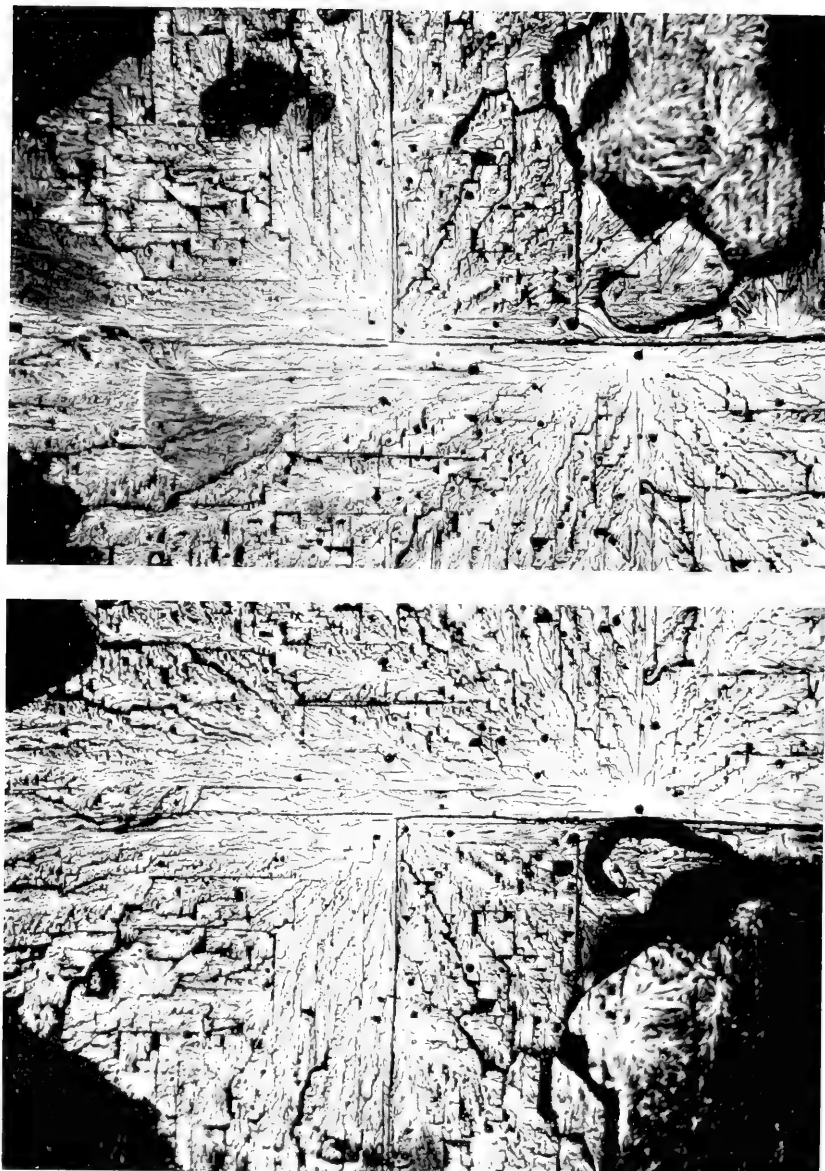

FIG. 1. Fractograph of metal, showing the external surface of a grain (grain boundaries). Oxide was deposited on growths which strongly affect the forgeability. The growths are in the form of thin plates which are carbides, the essential factor for forgeability. The growths are in the form of thin plates which are carbides, the essential factor for forgeability. The growths are in the form of thin plates which are carbides, the essential factor for forgeability. The oxide was removed by the vacuum treatment. The oxide was removed by the vacuum treatment. The oxide was removed by the vacuum treatment. Magnified 385 times.



FIG. 2. Fracture surface of metal, showing the external surface of a grain (grain boundaries). Oxide was deposited on growths which strongly affect the forgeability. The growths are in the form of thin plates which are carbides, the essential factor for forgeability. The oxide was removed by the vacuum treatment. The oxide was removed by the vacuum treatment. The oxide was removed by the vacuum treatment. Magnified 385 times.



Obverse and reverse fractographs showing both matching faces of a fracture traverse through a single grain of iron. The sharp 90° angles prove this to be a cubic cleavage. The markings display an elaborate architecture within the grain, and their variations on the opposite surfaces are informative. Magnified 100 times.

Atomic Weapons Against Cancer¹

By E. N. LOCKARD

ALL over the United States today there is the feeling that the dread disease of cancer may not remain dreadful much longer, that in 5, 10, 20, or 50 years the ever-increasing number of projects engaged in cancer research will win the war that has been waged for centuries. The encouraging signs are many—large budgets, enlistment of civilians, discoveries, publicity, special buildings, pooling or coordination of resources, new techniques, and devoted research. The fighters on this front, like resourceful warriors on the battlefield, recognize that they cannot safely place sole reliance upon any one device, but that they must attack with every possible weapon at every possible point, that now and at every other moment they must work with every approach that looks even a little promising. But though they continue to explore all possible means of control, the one factor that has done most to inspire new hopes of success is the use of radioactive isotopes. By means of these, atomic energy is being brought into action as a new weapon in what has been hitherto a losing battle.

We can understand the potential use of radioactive isotopes best if first we recall some of the things we know about cancer. It now ranks second only to heart disease as a killer of men and on the basis of present mortality rates could be expected to kill 19 million Americans now alive—or 13 out of 100.

Yet when we attempt to explain the causes of cancer, we are forced to admit that we do not know why, when, or how the cancer cells start multiplying out of or among other cells. Radiation, irritation, chemical compounds, viruses, parasites, and heredity are all concerned; yet we do not quite know how. But on the affirmative side we do know that cancer is a growth, and we know that the units of this growth are cancer cells, which retain many of the characteristics of normal cells. We know further that cancer is wild, luxuriant, and proliferating in its growth, not subject to the mechanism of increase that regulates the multiplication of normal cells, that it invades with-

¹ Reprinted by permission from *The Yale Review*, vol. 40, No. 1, Autumn 1950 (copyright Yale University Press), with minor revisions by Dr. Seymour Wollman, National Cancer Institute.

out warning or permission, and that it enjoys an irresponsible, black-sheep existence among the other cells. Also we know that cancer is metastatic (changing in its location)—perhaps the most dreadful fact of all; it is local at first but it spreads; a surgeon may cut it out in one place and years later find it in half a dozen other places, metastases of the original site.

The elusiveness of the cancer cell itself, the difficulty of determining where it resides in the body, and the inability of scientists to detect what substances of the body are necessary to its growth are factors that have so far prevented successful control. Moreover, the seeming impossibility of destroying malignant cells without also destroying normal cells has obstructed effective treatment of cancer where it is known to exist.

It is precisely in connection with these factors that the use of radioactive isotopes—radioisotopes—is so important and encouraging.

The word “isotope” means having the same place, and its use in this discussion comes from the fact that there are two kinds of atoms which have the same place in the periodic table used by chemists. One kind of atom is stable, the other is radioactive.

In order to understand the difference between the two, one must know a little about present-day nuclear theory. According to this theory, an atom of an element is like the solar system; it is composed of a sun (the nucleus) and a group of planets (electrons). But the nucleus is not quite so simple as the analogy to the sun would suggest, for it, in turn, is made up of protons and neutrons. So the atom is composed of—

I, the nucleus (sun), containing

(Ia), protons (which bear a positive electrical charge), and

(Ib), neutrons (which bear no electrical charge), and

II, the electrons (planets), which bear a negative electrical charge.

In all atoms the number of electrons (II) equals the number of protons (Ia). This number determines the place of the atom on the periodic table and is referred to as the “atomic number” of the element. Where one isotope differs from another is in the number of neutrons (Ib). Since variation in the number of neutrons results in variation in the weight of the atom, isotopes of the same element have different atomic weights, though always having the same atomic number.

Carbon provides a good example. There are five known isotopes of carbon, but the atomic number for all is the same: 6: This means that each contains six protons in the nucleus (Ia) and six electrons outside (II) and that they are all found in the same place in the periodic table. They differ only in the number of neutrons (Ib) and consequently in atomic weight. They are written C^{10} , C^{11} , C^{12} , C^{13} , and C^{14} . Here the atomic number is omitted as being understood;

otherwise we would write ${}_6\text{C}^{10}$, ${}_6\text{C}^{11}$, and so on. The first isotope has 4 neutrons (the difference between 6 and 10), the second 5, and so on. Of these 5 isotopes 2 happen to be stable (C^{12} and C^{13}) and 3 radioactive—that is, constantly disintegrating by giving off rays or particles. (As it happens, C^{14} is so useful that when one speaks of radioactive carbon one means C^{14} and not C^{10} or C^{11} .)

The radioisotopes are chiefly useful in cancer research and diagnosis because of the way they can be detected in the body. As they decay, their radiation ionizes gases, changes the charge on electrodes, or creates electrical pulses. These pulses, to take one example, can be counted by a Geiger counter or other kinds of counters. Thus, radioisotopes can be used to tag a substance before it is introduced into the body, and when the substance is tagged it can be traced. This tracer use of radioisotopes has become so famous that it has been called the most useful research tool since the microscope.

As tracers, the radioisotopes permit both qualitative and quantitative biological analysis. In the former, the compound containing the radioisotope can be followed wherever it goes no matter what chemical form it takes; in the latter, the amount of the tagged compound can be measured.

One of the most important problems in cancer research is to determine what substances of the body are necessary to the growth of malignant tissue. In this research various compounds are being tagged with radioisotopes and their uptake by the several kinds of tumors measured and studied. For example, after radioactive carbon has been synthesized with cancer-producing hydrocarbons its route can be traced, by means of the carbon 14, as it creates cancer in the body of a laboratory animal.

Such tracing experiments make use not only of the detectability of radioisotopes but also of two other characteristics. One of these is that a little of a radioisotope goes a long way, so its use involves no danger of injurious radiation. One gram of carbon 14, for example, can be diluted one million million times before it is impossible to detect; and one million billionth of an ounce of radiophosphorus is detectable. Laboratory studies are nevertheless being made to discover the limits of safe dosage for radioisotopes both in tracing and in therapy. The other characteristic is that, since the radioisotope is chemically like the stable isotope, the body accepts the one with the other. The study of the uptake of tracer doses of radioiodine by the thyroid gland, for example, is possible because neither animal nor human organism can tell the isotopes of iodine apart; so the radioisotope enters and leaves the thyroid gland just as the stable isotope does. By adding radioactive iodine to stable iodine, consequently, and using a Geiger counter against the skin to count the pulses from

the gamma rays emitted by it, research workers have found that iodine is concentrated by the thyroid gland. They have also found how much iodine is absorbed and excreted and at what rate.

Radioisotopes can also produce cancer. This is turned to account in cancer research by using some of them, strontium 89, for example, to induce cancer in experimental animals for studies that may throw light upon cancer in human beings.

In addition to their usefulness in research directed toward increasing our knowledge of cancer and the tissues it destroys, radioisotopes are being employed in diagnosis, to detect and locate cancer. It has been difficult, in the past, to estimate the exact location of a brain tumor by means of external signs on the patient's body or by X-ray studies. Now, by injecting radioactive phosphorus in tracer amounts and relying on the tumor in its rapid growth to take up more of it than the slow-growing normal tissues surrounding it do, a physician, using a counter, can compare the radioactivity in different parts of the brain and locate the tumor more precisely than before.

The final use of radioisotopes is in therapy, to inhibit or destroy cancer. A somewhat complex case at the Montefiore Hospital, New York, involving the use of radioactive iodine, will illustrate both diagnosis and therapy. In 1923 the patient had his cancerous thyroid gland removed by surgery. For the 16 years following he was well. Then he reported to Montefiore with a tumor in his back which, after surgical removal, turned out to be a metastatic cancer of the thyroid. The cancerous thyroid gland that had been removed 16 years before had spread before its removal and was now showing up in another locality. In the next 4 years it showed up in still other places, metastases that X-ray therapy could not control. By means of tracer doses of radioiodine, the metastases in skull, lung, ribs, spine, pelvis, and femur were revealed to be getting worse. Therapeutic doses of radioiodine were then resorted to. The patient got better and is still well today, 5 years after the first radioactive therapy. The radioiodine saved, or at least prolonged, the patient's life; it is only fair to add that most cases are not so fortunate.

In this case, as in all the previous ones mentioned, radioisotopes were used because of their characteristic behavior as tracers. But in the therapy of this case, two other characteristics come into play. One is that radiation has uneven effects upon various kinds of tissue, and cancerous tissue is generally more susceptible to radiation than normal tissue. The other is a characteristic which radioisotopes share with stable isotopes; certain ones have, as elements, an affinity for certain tissues—phosphorus for bone and iodine for thyroid are examples. These traits have led to the hope of finding a substance that will have such an affinity for cancerous tissue that enough of it, radioactively impregnated, can be deposited in the cancer to kill it. So

far no substance with true specific localization in cancerous tissue has been discovered, but the localization with radioisotopes is so much greater than with the older sources of radiation, X-rays, and radium which is dangerous to deposit internally, that the administration, orally or directly into the cancerous tissue, of radioisotopes is now a recognized method of radiotherapy—and in some few instances, the most efficacious one.

Today, radioiodine and radiophosphorus have been proved effective in treating the noncancerous conditions of hyperthyroidism and polycythemia (abnormality of the blood-forming tissues), respectively; less effective in treating cancer of the thyroid and leukemia (cancer of the blood-forming tissues), also respectively. Nor are these the only elements that can be used; therapy is also possible with radiocobalt and radiogold.

The chief value of radiocobalt results from the fact that it resembles radium, the old standby in the treatment of cancer by radiation, in that it emits gamma rays; but at the same time it has several advantageous qualities that radium lacks. One important advantage is price. Whereas radium is so expensive (it costs between \$15,000 and \$20,000 a gram) that smaller hospitals borrow it from larger ones, cobalt 60 is manufactured abundantly enough for free supply to cancer-research workers and for sale at a low price to paying patients. Another advantage is application; while radium is contained in nonpliable tubes, radiocobalt can be made up in pliable shapes. The most interesting advantage is the ease with which radiocobalt can be manufactured and stored: ordinary cobalt can be fabricated, before irradiation, into cobalt wire; after irradiation it can be stored like thread on a spool; and like thread it can be snipped off in any length needed. In addition, radiocobalt, if accidentally set free in the body, does not lodge in the bone as radium does but is quickly excreted. It can, finally, be handled more safely and with less shielding than radium.

Radiogold, like radiocobalt, has several advantages over the traditional types of radiation. In the first place, radiogold can be injected directly into the malignant tissue; X-rays cannot. And second, because of a half-life of only 2.7 days, radiogold need not be removed, as radium needles must.

In order to improve therapy with radioisotopes, scientists are studying the selective pick-up by cancerous tissues of various compounds that can be synthesized with the radioisotopes of a number of elements. Cancer is frequent in the organs controlled by sex hormones—the uterus, the breast, and the prostate gland. Since these organs depend upon known chemical compounds, some sex hormones containing radioisotopes have been synthesized. Unfortunately, so far no target

organs have shown sufficient concentrating power to make radioactive hormones look promising.

Where does medical science get these radioisotopes on which it increasingly relies? The first source was the cyclotron, or atom-smashing machine, but this source has now been reduced to a very minor position by the nuclear reactor, or pile. In certain very limited respects, the cyclotron can do things which the pile cannot do. It can use different types of bombarding particles, and because of this variety in projectiles and diversity in energy, it can make some radioisotopes that the pile cannot (sodium 22 and arsenic 74 are examples), and it can also produce a few radioisotopes better than the pile can produce them—radioisotopes with a higher specific activity, which is the ratio of the radioactive atoms to the stable isotopic atoms with which they are mixed, and carrier-free radioisotopes (isolated from the stable isotopes). But some of its products are inferior to those of the pile. For instance, where the pile produces iodine 131 with a half-life of 8 days, the cyclotron produced iodine 130 with a half-life of only 12 hours. In terms of research this meant that unless the research laboratory was near the cyclotron, the iodine 130 would have radiated away by the time it arrived. But this deficiency was negligible as compared with the one great drawback of the cyclotron—its limited capacity for production. Atom-smashing cyclotrons have always been few and far between, and their products few and expensive. A great deal of research which was being planned by medical and biological men throughout the country had to be held up until something came along that could produce the desired isotopes in sufficient abundance to make them cheap enough to buy and available to all who could use them.

On December 2, 1942, this something appeared when the first self-sustaining chain reaction was achieved at the University of Chicago and nuclear fission became a reality. Nuclear reactors were built, of course, not to produce isotopes, but to provide fissionable material for the atom bomb and related research. For a time, therefore, cancer research men could not draw on this potential source of isotopes. But since the end of World War II, the Atomic Energy Commission has moved to make its facilities available and has created for the first time an adequate supply of isotopes. Today, 70 percent of the radioisotope production schedule at Oak Ridge is directed toward the study of cancer, with more than 250 research groups using the products. The reason for the excellent production is that the nuclear reactor has proved to be capable of turning out radioisotopes abundantly and cheaply. The emphasis is on abundantly; the cheapness follows from that. The abundance is well illustrated by the fact that only about 1 kilogram of radium had been produced from its discovery

in 1896 to 1941, whereas since atomic energy was developed we have had the equivalent in radioactivity of thousands of tons of it.

It so happens, fortunately, that not only can the pile produce in great quantity but it can also make all the most important radioisotopes, including those most helpful in cancer, though the cyclotron still retains important secondary values as a producer.

The pile can produce a thousand to a million times as great a quantity of isotopes as the cyclotron can; in contrast to the cyclotron, which uses different types of bombarding particles, even neutrons, the pile is exclusively a neutron machine. It uses neutrons in two ways to manufacture radioactive isotopes. The first way is nuclear fission—the actual splitting of nuclei. Each nucleus of the target element, uranium, that is hit by one of the bombarding slow neutrons splits (fissions) into two or more fragments, in many different ways; thus many different fission products result. They are radioactive (unstable), which means that they will give off energy by the emission of one kind of particle or another until they reach a stable isotope or are used up. Strontium 89 is produced in this way and so is iodine 131. But another practical way of producing iodine 131 is by causing non-fissionable nuclei to absorb additional neutrons, and this is the second way of making radioisotopes.

There are three kinds of neutron absorption—simple absorption, absorption followed by decay into a daughter element, and transmutation. In all three, special target material is inserted into the nuclear reactor, which is already in operation with fission of uranium by neutrons. If, for example, ordinary cobalt ($_{27}\text{Co}^{59}$) is inserted into the pile, it absorbs one of the neutrons flying about and, while remaining cobalt (the number of protons and electrons does not change), becomes cobalt 60, which is radioactive. This is simple neutron absorption. The product realized is always isotopic with the target material.

In the second kind of neutron absorption, the material put into the reactor to be irradiated is not isotopic with the product wanted in the result, but a different element. A practical method of producing radioiodine comes here. A stable isotope of tellurium ($_{52}\text{Te}^{130}$) is inserted into the reactor; when it absorbs a neutron it becomes $_{52}\text{Te}^{131}$, which, being unstable, decays by emitting a beta ray; the emission of the beta ray involves first the conversion of a neutron into a proton and an electron and second the ejection of the electron (beta ray and electron mean the same thing) with the proton staying in the nucleus; thus the atomic number changes from 52 to 53 (since there is a gain of the proton) and the atomic weight stays the same (since the loss of the neutron is balanced by the gain of the proton; and so $_{52}\text{Te}^{131}$ by beta decay becomes $_{53}\text{I}^{131}$, a daughter element.

In the third kind of neutron absorption, called neutron transmutation, again a target element nonisotopic to the radioactive element desired is inserted into the operating reactor. A good example is carbon 14, which is produced in practical quantities by neutron transmutation. Ordinary nitrogen (${}^7\text{N}^{14}$) is the target material; absorbing a neutron, it emits a proton; the loss of the proton drops the atomic number one place and therefore changes the element; the gain of the neutron keeps the atomic weight the same; thus ${}^7\text{N}^{14}$ is transmuted into ${}^6\text{C}^{14}$. Similar transmutations are possible with the emission of alpha particles instead of protons.

This is not the whole story of the production of radioisotopes in the nuclear reactor by means of neutron bombardment. How the radioisotope desired is separated from the other fission products or from stable isotopes is also, to name one aspect, a part of the complete story. Additional points to remember, however, are that any common element can be irradiated in the reactor, that what radioisotopes the reactor cannot make the cyclotron can, and that between them they account for more than 500 induced radioactivities—every one of the 96 elements has at least one known radioisotope. One point more and an important one for cancer research is that both the cyclotron and the reactor, because they use different means and therefore accomplish different ends, are needed in the constant experiments being carried on for new isotopes and for isotopes of varying specific activities, half-lives, and energies.

The facilities which need to be brought together in order to provide maximum effectiveness in cancer research are varied indeed. In the research center itself many kinds of experts are needed—radiological physicists, biologists, and medical experts who know the effect of radioactivity on living things and how to safeguard health; chemists who can separate cancer-useful products from the other products of the reactors and can synthesize radioactive chemicals and drugs into chemically useful compounds; and experimental nuclear physicists who can select materials for insertion into the reactors. The equipment for producing radioisotopes should also be near at hand, so that the laboratories will receive quickly those radioisotopes that are so short-lived that transportation over a distance is impractical. Such equipment must, of course, include a cyclotron, for the sake of its distinctive products, and a nuclear reactor or pile.

Here the Atomic Energy Commission is vitally involved, for the pile is primarily a producer of fissionable materials, and in the words of the Atomic Energy Act, "all right, title, and interest within or under the jurisdiction of the United States, in or to any fissionable material, now or hereafter produced, shall be the property of the Commission" and "the Commission * * * shall be the exclusive

owner of all facilities for the production of fissionable material * * * ” Since all fissionable material is produced at the Commission's national laboratories (Oak Ridge, Brookhaven, and the Argonne Laboratory in Chicago) or at other laboratories that execute the program of the Commission (e. g., Los Alamos and the University of California), the availability of isotopes depends upon the policy of the Commission. There is, furthermore, the explicit injunction in the Atomic Energy Act that the Commission “exercise its powers in such manner as to insure the continued conduct of research and development activities” in, among several fields, the “utilization of fissionable and radioactive materials for medical, biological, health, or military purposes.” In obedience to this provision and in recognition of the scientific need for its products, the Atomic Energy Commission is engaged in a cancer program, one part of a huge program in biology and medicine that is costing several millions of dollars a year.

This cancer program in general can be divided into four activities. In the first place, there is free distribution by the AEC of radioisotopes to hospitals, medical schools, and clinics. Because the cost of radioisotopes has held back cancer research, the AEC is making available to qualified cancer-research workers in this country without cost, save for a small handling charge, all radioisotopes on the public market. At first the Commission made a free distribution of three radioisotopes for cancer work: radioactive iodine (I^{131}), radioactive phosphorus (P^{32}), and radioactive sodium (Na^{24}), the first two especially valuable. Among the radioisotopes recently declared free, those most valuable in cancer research or therapy are radioactive carbon (C^{14}), radioactive cobalt (Co^{60}), and radioactive gold (Au^{198}).

Secondly, the Commission gives financial and scientific support to certain research projects outside its own laboratories. In April of 1949 there were 78 such research studies in biology and medicine.

In the third place, the Commission, through one of its agencies, is studying the incidence and types of cancer in the survivors of the bombing of Hiroshima and Nagasaki. So far the studies have not shown any increase in cancer or in abnormal children, stillbirths, or miscarriages.

And fourth, the Commission is committed to providing facilities at its own installations for clinical research in cancer. One such facility, now being established at the University of Chicago, is part of what may be described as the first complete and self-sufficing center for cancer research.

Never until recently have all these necessary elements—the research laboratory, the cyclotron, and the pile—been brought into

their ideal relationship, but the Chicago development will unite them all, and will constitute a unique combination of weapons to increase the assault on cancer. Physically, four buildings will make up this center. One of these is the Ion Accelerator Building, which contains the university's new 170-inch synchrocyclotron. A second is the Goldblatt Hospital, named for one of the department-store Goldblatt brothers who died of cancer; it will make use of, among many things, the products turned out by the university's cyclotron. The other two buildings are to be government-owned but university-operated, and they are the Argonne National Laboratory (located just outside Chicago), which contains nuclear reactors, and the Argonne Cancer Research Hospital, which will make use of the products turned out by the Laboratory. But the important point is that since the university will operate all four, since three of them are on the university campus and the fourth only 40 minutes away, since two of them are exclusively concerned with cancer, and since the staff members of all four will help each other on common problems, the University of Chicago and the Atomic Energy Commission in combination will have an installation for attacking cancer such as exists nowhere else in the world.

Today cancer is being fought on longer fronts and more fronts than ever before. No one knows by whom or in what research project the discoveries so long sought after will be made; no one *knows* even that they will be made. But men and women all over the country, in biology, in physics, in chemistry, in medicine, in surgery, in atomic energy, and in nontechnical capacities, are devoting their time and money to the chance that they will be made. It hardly seems too much to hope that in this fight atomic weapons will play an important—perhaps a decisive—part.

Enzymes: Machine Tools of the Cellular Factory¹

By B. A. KILBY

Department of Biochemistry, The School of Medicine, University of Leeds, England

[With 1 plate]

THE first half of the present century has seen biochemistry develop from a humble servant of physiology into a master science in its own right. Its vast field of study is the chemistry of all forms of life, from the simplest bacteria to the higher plants and animals, and in this study it calls upon the services of almost every other branch of science. Much attention has been paid to the elucidation of the structure of the compounds which make up the living cell, and in recent years an increasing emphasis has been placed on studying how the cell functions. Much is known of the nature of the raw material entering the factory of the cell and of the products made there, and now the interest has switched to finding out more about the intricate machinery and processes which take place inside the factory. The machine tools of the cell are its enzymes or ferments which enable it to carry out the remarkable range of chemical reactions that make life possible.

There was a very vigorous discussion during the nineteenth century concerning the nature of fermentation. Why, it was asked, did insipid grape juice turn apparently spontaneously into wine—why did wort change into beer? What was the nature of the scum or sediment, the yeast, which appeared at the same time? In France, a prize equal in value to a kilogram of gold was offered in 1800 for the best answer to the question “What distinguishes substances which act as ferments from the materials they are capable of fermenting?” Although the prize was never awarded, its offer did much to stimulate discussion and controversy, as yeast was considered at that time to be a chemical byproduct of fermentation, and it was widely believed that it played no essential part in the process.

About 1837, three workers claimed independently to have shown that yeast was a living organism and was responsible for fermenta-

¹ Reprinted by permission from *Discovery*, March 1951.

tion. This revolutionary view was received with scorn by orthodox chemists. Berzelius, the outstanding chemist of the day, reviewed this work scathingly in his chemical journal, while Wöhler wrote a sarcastic skit on the whole business which was published by Liebig in his *Annalen*. In this, yeast was described as consisting of eggs which hatched out into minute animals shaped like a distillation apparatus, into which sugar was taken as food and converted into alcohol and carbon dioxide, and the whole process could be observed quite easily under the microscope! Soon after this, Liebig set out his views on the nature of fermentation. Yeast played no part in his purely chemical theory which came to be widely held and was taught for many years afterward. According to Liebig, the nitrogenous material in fruit juice was a ferment, unstable in the presence of air, which caused it to undergo a progressive change. While this change was in progress, the ferment communicated its instability to the sugar, which then broke down into alcohol and carbon dioxide. Liebig was able to produce chemical analogies for this; for example, silver is dissolved readily by nitric acid, but platinum is quite unaffected, yet an alloy of the two dissolved quite easily and completely. This was, he said, because the silver, in dissolving, communicated its instability to the platinum. Louis Pasteur, on the other hand, strongly opposed these nonvitalistic ideas, and developed his thesis of no fermentation without life. He said that alcoholic fermentation never occurred "without the simultaneous organization, development, multiplication of cells or the continued life of cells already formed." It was true that Pasteur had to distinguish between what he called the "organized ferments" as in yeast, and the "unorganized ferments" (such as pepsin which is secreted into the stomach or ptyalin of saliva, which breaks down starch), since such unorganized ferments could be shown to act in a test tube.

After prolonged discussion, during which no new decisive experimental evidence was obtained, the Pasteur-Liebig controversy was suddenly settled by a fortuitous and lucky observation of Hans and Eduard Buchner in 1897. This discovery is one of the notable milestones in the long path of physiological chemistry, and many regard it as marking the beginning of modern biochemistry. The Buchners had previously found that the cells of bacteria could be disrupted by grinding with sand, and they extended their technique to yeast cells. The macerated product obtained in this manner contained much cell debris and it was very difficult to separate liquid from it, so they modified the method by adding kieselguhr, an inert and porous earth, to the yeast cells and sand. After grinding, a mass that had the consistency of dough was obtained; this was wrapped in cloth and submitted to a pressure of about 1,500 pounds to the

square inch in a hydraulic press. An opalescent brownish-yellow juice was obtained which was free from yeast cells, and this was used for a number of animal experiments. It was not altogether satisfactory, for it soon putrefied. The nature of the experiments excluded the addition of the usual antiseptics, and so the Buchners decided to add sugar as a preservative. To their surprise, fermentation began immediately, the sugar being converted into alcohol in spite of the complete absence of living yeast cells.

Pasteur's thesis was thus disproved. But closer consideration shows that both Pasteur and Liebig were partly right and partly wrong. Fermentation could take place in the absence of living organisms, and it was chemical in nature but not in the way Liebig had thought. Certain ferments were produced by the living yeast and normally functioned inside the cell to cause the breakdown of the sugar which was serving as a food for the yeast. The nature of the yeast used in making active juice is rather important. Some strains, such as Munich "bottom" yeast (which rapidly settles to the bottom of fermentation vats) gives active juices, whereas others, including some Parisian and English "top" yeasts (which form a thick scum on the surface), give quite inactive juices. It is possible that Pasteur may have experimented with such a "top" yeast and been unable to prepare any active extracts. A more fortunate selection might have enabled him to anticipate the Buchners by more than 30 years.

The production of this active juice meant that it was no longer necessary to consider the possibility of some mysterious vital force as being concerned in fermentation. The mystery should be explicable in purely chemical terms. The juice could be easily made in quantity, and an immense amount of work has since been done on its properties. Its activity was originally ascribed to the presence of a ferment called zymase, but it is now known that the break-down of sugar into alcohol involves at least 15 separate and successive stages, and almost as many ferments or enzymes. The unraveling of the intricacies of alcoholic fermentation and the isolation of many of the intermediate compounds and separate enzymes are among the great triumphs of biochemistry. In 1925, Meyerhof published a method for preparing a juice from muscle which would convert in a test tube glycogen (the animal analog of starch) into lactic acid, a change that is known to occur in living muscle and to provide the energy for contraction. This conversion also has been found to take place in about 15 stages, which, except for the initial and final ones, are identical with those in yeast. This is a good example of the essential unity of biochemistry, where living organisms of widely different character are found to involve the same biochemical processes, with slight modifications to suit their particular needs.

When evidence has been obtained for the existence of some interesting new natural product, one of the first aims of the research worker is to try and isolate it in the pure state. Stage by stage, inert matter is removed from the crude product, and the progress of purification can often be followed by observing an increase in a particular biological activity per unit weight. If the worker is lucky, he may eventually obtain the pure material which shows a constant and maximum biological activity, unchanged after going through the motions of a further purification. The research worker is most happy if his product turns out to be a crystalline solid, as purification by recrystallization is often one of the easiest techniques, especially if it becomes necessary to work on a small scale because of scarcity of material. Crystals usually have well-defined physical properties which are valuable criteria of purity. As soon as it was realized that biological material, such as yeast juice or gastric juice from the stomach, probably owed its activities to the presence of specific enzymes, efforts were made to isolate these for precise examination. For many years, the final products obtained were noncrystalline solids, and it was suspected that they were still impure, in spite of showing very high enzymatic activity. These products consisted largely of protein material, and it has always been rather difficult to resolve mixtures that contain proteins into pure components. However, so consistently was high enzymatic activity in these final products associated with protein material, that many workers believed that the enzymes were themselves proteins. A German school, on the other hand, held that the enzyme was really a relatively simple chemical substance which was absorbed onto the protein material which acted as an inert carrier. However, in 1926, the first enzyme was obtained as crystals and found to be a pure protein. The method used in this particular case was remarkably simple. There is an enzyme, urease, which breaks down urea into ammonia, water, and carbon dioxide. This enzyme is fairly widespread in nature; soya beans are quite a good source, but the best is the seeds of the jack bean (*Canavalia ensiformis*). The ground beans from which the fat has been extracted are available commercially as a source of urease, under the name of jack-bean meal. The American chemist Sumner extracted the meal with 31.6 percent aqueous acetone and filtered the solution in a cold room. After standing overnight, very small octahedral crystals separated out, which were about 730 times as active as the original meal in splitting urea.

CRYSTALLINE ENZYMES

Since that time about 20 other enzymes have been obtained in crystalline form by various workers, but usually only by more elaborate and more lengthy methods. Attempts to crystallize many other en-

zymes have not yet been successful, but this is not a serious handicap to the biochemist, as he can obtain a great deal of information about the properties of an enzyme without having the pure material. A solution or suspension containing a particular enzyme can often be made quite readily from a suitable source and used to investigate what changes the enzyme can bring about, how it is affected by heat, different acidities, poisons, and so on. The biochemist has a wide range of biological material from which to select a convenient and rich source of the particular enzyme which interests him; typical examples of the materials employed are red blood cells, meal worms, mushrooms, bacteria, pigeon breast muscle, rat liver, beef pancreas, and horseradish.

All the zymes that have been obtained pure and crystalline have shown the properties of proteins, and it would appear that each pure enzyme is a quite definite chemical compound, a protein with characteristic and constant properties. Some enzymes have a purely protein structure, but others have, in addition, some relatively simple unit of a different nature built into the structure as an essential part.

CO-ENZYMES

Other enzymes can function only if certain compounds, called co-enzymes, are also present. If yeast juice, for example, is placed in a cellophane bag and washed in a current of water, the co-enzyme passes through the cellophane because it has a small molecule and is washed away, while the large protein enzymes are left in the bag. This residual juice will be found to have lost its power to cause fermentation. If another sample of yeast juice is boiled, the enzymes are destroyed but not the heat-stable co-enzyme. This solution is also inactive, but if the two preparations are mixed, then the combination shows biological activity again as both enzyme and co-enzyme are present.

A slightly different co-enzyme has been found in red blood cells, and in 1935 both co-enzymes were shown to contain the substance nicotinamide built into their structures. Almost exactly at the same time, Elvehjem and his associates discovered that nicotinamide was the vitamin present in diets that would prevent and cure human pellagra. Thus a memorable link-up occurred between two of the major lines of biochemical study—of vitamins and nutrition on the one hand and of enzymology on the other—to their mutual advantage. It became possible to ascribe a definite biochemical function to a vitamin, and new light could be thrown on possible chemical mechanisms of enzyme systems by a study of the chemical properties of the vitamins.

Another example of a vitamin associated with an enzyme is afforded by vitamin B₁, or aneurin, which prevents beri-beri. In combination with phosphoric acid this vitamin acts as the co-enzyme for an oxidase,

an enzyme which breaks down pyruvic acid. If this vitamin is deficient in the diet, the oxidase cannot function and pyruvic acid accumulates in the tissues, a change which can be used in the clinical diagnosis of vitamin B₁ deficiency. If the vitamin is supplied in the diet, the pyruvic acid soon disappears.

Several other vitamins have now been identified as parts of the structure of different co-enzymes or of the nonprotein part of enzymes, but not all vitamins have yet been associated with specific enzyme systems and it is probable that some may function in other ways.

A LITTLE GOES A LONG WAY

A little enzyme goes a long way—for instance, one part of rennin is capable of clotting 10 million times its weight of milk—so that the absolute amounts of enzymes required for the smooth running of the body may be quite small, and only small amounts of vitamins will be required for building new enzymes and co-enzymes to make good the small but continuous loss through general wear and tear. The body cannot make the vitamins itself and without them some enzyme systems cannot function. The requirements of vitamins are thus small but essential, and if not met, the machinery of the whole body may get disorganized and death may eventually take place.

The substance that is transformed in the presence of an enzyme is called the substrate. Some enzymes can bring about changes with a large range of different but related compounds; some lipases, for example, will bring about the splitting of many different fats. Other enzymes, such as urease, may be so selective that they will transform only a single kind of substrate. It is believed that in general before an enzyme can bring about a reaction, a complex must first be formed between the enzyme and the substrate. This theory is based largely upon mathematical analysis of the shapes of reaction-time curves, but in a few cases, direct experimental evidence to support it has been obtained. The enzyme peroxidase brings about the oxidation of certain compounds by hydrogen peroxide. A sharp change in color of peroxidase occurs when hydrogen peroxide is added to it indicating the formation of a complex; if a suitable substrate is now added, oxidation takes place, the hydrogen peroxide is used up, and the original color of the peroxidase reappears. It is generally accepted also that this combination with the substrate can only take place at a special point in the enzyme structure, called the active center. Successful formation of a complex may depend on the degree to which the shapes of the active center and substrate are complementary. Emil Fischer used the analogy of a lock and key to illustrate this point. Many substances exist in two forms whose molecular structures are mirror images of each other (rather like a pair of gloves),

and in such cases it is nearly always found that only one form will work with the enzyme. The two forms of lactic acid are shown in figure 1, and the enzyme lactic dehydrogenase which removes two hydrogen atoms to convert lactic acid into pyruvic acid will function with the naturally occurring form, but not with the other, its mirror image. The active center might be thought of as a hand and the lactic acid as a glove, when only one glove of the pair will fit the hand.

When an enzyme reaction takes place, one may picture the substrate molecule colliding with the active center, forming a complex, reaction occurring and the products then leaving the center which is then free for another cycle to take place. The enzyme molecule (if it has a single active center) can thus deal only with a single

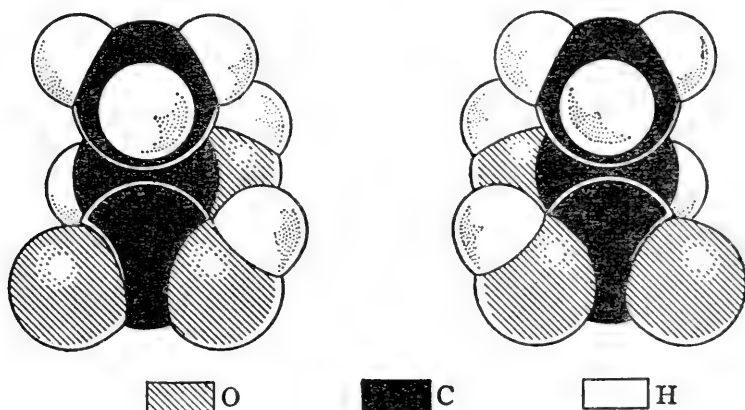

FIGURE 1.—Models of the two forms of lactic acid, $\text{CH}_3\text{CH}(\text{OH})\text{COOH}$, which are mirror images. These models give the best representation that is possible of the actual shape of molecules. (From *Organic Chemistry*, by L. F. and M. Fieser.)

molecule of substrate at a time, but the cycle may be repeated very rapidly; a single molecule of catalase, for instance, can break up at least 5 million molecules of hydrogen peroxide in a minute. When measurements are made of the speed of an enzyme reaction in the presence of increasing amounts of substrate, a curve of the type shown in figure 2 is usually obtained. This has the form of a rectangular hyperbola. If there is ample substrate, the enzyme is working full out all the time and increasing the concentration of substrate has little effect as at A. At low concentrations of substrate, as at B, the active centers are unoccupied for much of the time, and so increasing the amount of substrate has a direct and proportional effect on the speed.

As an analogy, one might consider a crowd of football fans waiting to enter a football ground. The individual fans are the mole-

cules of the substrate, and the turnstiles are the active centers of the enzyme which transform fans into spectators one at a time. As long as there are enough people to keep the turnstiles going at full speed, the rate of change of fans into spectators will be constant and independent of the length of the queues; but if only a few people approach, they will go in without waiting and the rate of conversion of fans will be directly proportional to the number arriving at the ground. One might extend the analogy by comparing certain vitamins to the oil necessary to lubricate the turnstile mechanism. If this is lacking, the turnstile will seize up and chaos result.

The number of different enzymes already known is very large, and new ones are constantly being found. The discovery of penicillin

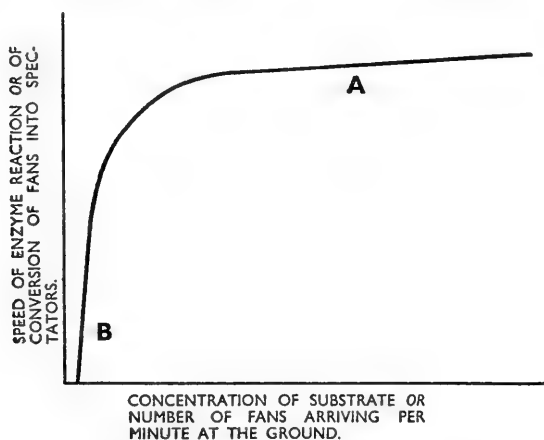

FIGURE 2.—Relationship between rate of enzymatic reaction and the substrate concentration. A similar curve would be obtained by plotting the rate of the "football crowd" reaction and rate of arrival of fans mentioned in the text.

was followed very quickly by the discovery of penicillinase, the enzyme which destroys it.

Every species of plant and animal seems to possess its own set of enzymes which do not correspond exactly to similar enzymes present in other species, so that the total number of individual enzymes may run into many millions. Innumerable compounds occur naturally in plants and animals and for each there must exist enzymes which can make and break it down. Enzymes enable living organisms to carry out a great variety of reactions in dilute aqueous solution at temperatures between freezing point and blood heat; there is no need for extremes of acidity or alkalinity. Without using enzymes, the organic chemist can carry out only some of these changes, and then often he may have to use higher temperatures, corrosive reagents and concentrated reagents, and sometimes to exclude water completely.

THEORIES OF ENZYME ACTION

In short, life as we know it could not exist without enzymes.

Various theories have been proposed to try and explain how enzymes can so modify chemical reactions that they will occur under such mild conditions. The general idea of the most widely held theory is as follows: Suppose a molecule, say A-B, is too firmly bound together for breakage of the bond between A and B to occur easily, then if complex formation takes place with an enzyme, the forces holding the complex together may lead to a redistribution of forces within A-B such that the linkage is so weakened that fission can occur and A and B are formed. This idea is shown pictorially in figure 3, but it must not be taken too literally.

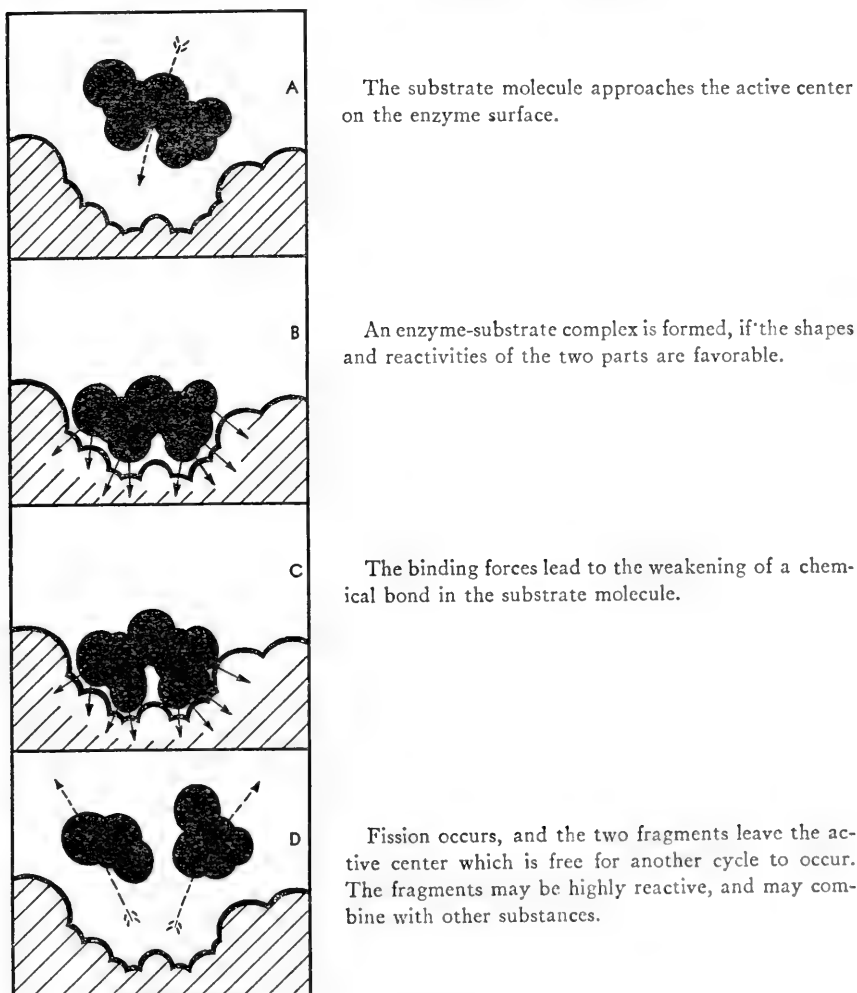

FIGURE 3.

Anything that can inhibit or stop vital enzymes from functioning smoothly in the organism may lead to its death. The absence of certain vitamins is one example already mentioned. Heat and ultraviolet light may produce irreversible changes in the protein molecule, and if this protein is an enzyme, loss of activity results. Another way in which an enzyme may be inhibited is by some compound reacting chemically with it or forming a stable complex at the active center, which is then blocked and cannot fulfill its normal role any longer. One fat man firmly wedged in the turnstile might stop the "football crowd" reaction.

The highly poisonous nature of some compounds has been correlated with their ability to "knock out" certain important enzymes, so that only a small amount of such poisons may be necessary to produce very serious effects on the well-being of the whole organism. One part of mercuric chloride in 200 million parts of solution will reduce by half the efficiency of the enzyme catalase. Cyanide is very efficient at stopping the working of some of the enzymes concerned with oxidation while some of the highly toxic phosphorus insecticides are extremely potent inhibitors of cholinesterases (enzymes that play an essential part in the working of the nervous system of higher animals, and probably also of insects).

The existence of antienzymes in living systems has been demonstrated. One of the best examples is shown by the roundworm, *Ascaris*, which lives in the animal intestine and escapes being digested by the enzymes present by producing specific enzymes that neutralize the effect of specific digestive enzymes. However, if the worms are placed in dilute solutions of digestive enzymes from plants (such as ficin from the latex of certain fig trees), they are digested alive as they lack specific inhibitors to these unfamiliar enzymes.

An intriguing problem is why digestive enzymes do not attack and digest the glands producing them, or the intestinal tract into which they are secreted. One reason may be that such enzymes are usually secreted in an inactive form, and the active center is "uncovered" later. The pancreas secretes trypsinogen, which is inactive but is converted into active trypsin in the intestines. The stomach secretes a mucilage that coats its walls and probably protects them from the action of the digestive juice.

When biochemical processes are examined in detail, it is often found that a change, such as the fermentation of sugar or the oxidation of acetic acid to carbon dioxide and water, is not achieved by a single enzyme but by a whole battery of them. There may be a dozen or more stages, each brought about by a separate enzyme. The substrate has therefore to move from one enzyme to another, and at each stage

some modification in structure occurs. It is difficult to see how this could take place smoothly and efficiently in the cell if all the enzymes in a battery were scattered throughout the volume of a cell. One might suspect that they would be found to be arranged in an orderly sequence, like the machine tools along the production line of a factory, so that the material undergoing transformation can pass easily from one enzyme in the series to the next. Recent discoveries have indicated that this may sometimes be the case. Various small granules called mitochondria exist in the cytoplasm of cells (the cytoplasm is the part of a cell outside the nucleus) and most of the enzymes concerned with oxidation appear to be concentrated in these granules, which may be thought of as the powerhouses of the cell, since the principal purpose of oxidation is to release energy. Not a great deal is known yet about the structure of mitochondria, or how they are reproduced or of the arrangement of enzymes in them. Handcuffed together, as it were, the enzymes act as a group and their collective behavior may differ from the sum of that previously observed for the individual enzymes that the biochemist has obtained after destruction of the unit. The study of enzymes began with the living cell and then progressed to the isolated enzyme. The main aim of this phase, the classical period of enzyme biochemistry, has been to separate an enzyme from all others that accompany it; the isolation of crystalline enzymes marks the triumph of this technique. This phase is so productive of results that it will be developed for a long time yet, but at the same time another approach is being fostered. The aim of this is not the separation of enzymes from each other but the avoidance of this in order to obtain intact teams of enzymes and study the activity of the team.

The activities of enzymes are not the concern merely of the academic biochemist or the brewer, for enzymes are involved in many aspects of everyday life. The housewife makes junkets by using rennet, a preparation containing rennin which converts caseinogen, a soluble protein of milk, into casein, whose insoluble calcium salts separate out as the curds. The natural function of this enzyme (which occurs naturally in the fourth stomach of the calf) is probably to delay the emptying of the stomach by converting liquid milk into a jellylike mass.

Meat is hung to make it tender, as animal tissues after death undergo self-digestion owing to the presence of enzymes which partly degrade some of the structural material of the tissues. The oxidizing agents added by millers to flour as "improvers" and in order to bleach it, inhibit the proteinases of the wheat which, if left active, would alter the proteins present in the flour and give rise to a less

satisfactory bread. The rising of dough is due to the action of enzymes in the flour and added yeast; these cause break-down of starch into sugars which the yeast ferments to produce carbon dioxide, the gas which makes the dough rise, as well as a little alcohol, some organic acids and materials with pleasing flavors. It is enzymes that make apples and potatoes go brown after cutting, a change due to the enzymatic oxidation in air of certain colorless compounds present to form pigmented substances. Many industrial processes are based on enzymatic action; usually living organisms such as yeast, molds or fungi, are used, as, for example, in the manufacture of malt vinegar, penicillin, citric acid, and so on; a discussion of these is rather outside the scope of the present article.

Two examples can, however, be mentioned of industrial processes that use special enzyme preparations, as opposed to living organisms. When fruit juices are being manufactured, pectins, which form a part of the structure of plant cells, may separate out from solution as gelatinous precipitates and make filtration difficult or spoil the appearance of the product. (If pectins are present in sufficient amount, a fairly rigid jelly may result, as in successful jam making.) Clarification of fruit-juice drinks is now achieved usually by adding pectinases, enzymes that degrade pectins to soluble products. The enzyme preparations used are made from certain molds grown for the purpose. At one stage in leather manufacture, it is necessary to remove degraded products of hair, glands, and certain tissue proteins from the hides. This used to be a secret process that involved soaking the hides in a warm suspension of dog dung. The same result is now achieved more pleasantly by using enzymes prepared from large-scale cultures of suitable strains of bacteria.

Human life begins with an enzymatic reaction. Spermatozoa liberate hyaluronidase, an enzyme that attacks the envelope around the egg and allows a single spermatozoon to enter and fertilize it. Enzymes keep the flame of life burning until death, when enzymatic decomposition returns the building material to the great store from which fresh life can draw its raw materials to be assimilated and rebuilt into new life forms.

The living cell may be pictured as a remarkable factory, which not only makes a vast range of different products simultaneously, but also builds its own extensions, does its own repairs and makes its own machine tools. Changes in the nature of the raw materials available or sudden demands for material for new tissue building do not change the smooth-running efficiency of this factory. An elaborate control system must be operating that regulates the speed at which the different machine tools are working and thus which departments

must speed up production, and which slow it down. The chemical regulators of the body are its hormones, and these must almost certainly act by controlling key enzyme reactions. The first indications that this may be so have been obtained, and it may well be that the major development in biochemistry during the next half century will be a greater understanding of the mechanism of hormone action in terms of enzyme reactions. Much has been achieved in enzymology, but very much yet remains to be done. It would be an overconfident biochemist who would consider himself worthy of the kilogram of gold.





1. Photomicrograph of pepsin crystals, $\times 80$.
(From *Enzymes*, by Sumner and Somers.)

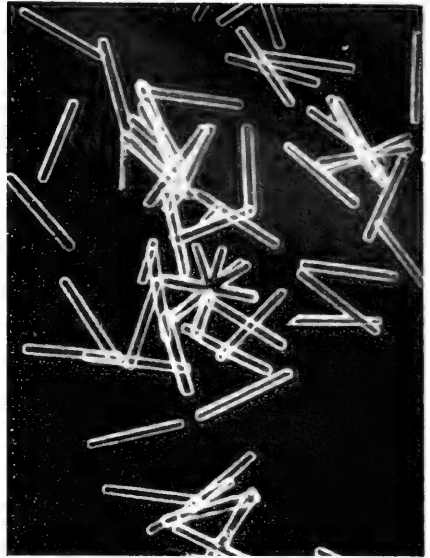

2. Photomicrograph of trypsin crystals, $\times 250$. (From *Crystalline Enzymes*, by Northrop, Kunitz, and Herriott.)



3. Photomicrograph of trypsinogen, $\times 250$. This is the inactive precursor of the digestive enzyme trypsin. (From *Crystalline Enzymes*, by Northrop, Kunitz, and Herriott.)

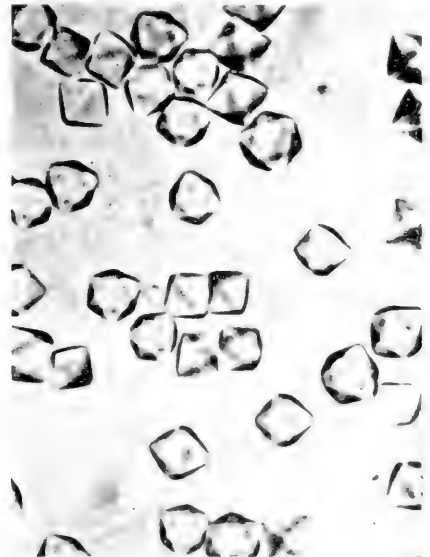

4. Photomicrograph of amylase crystals, $\times 800$. This enzyme was the first one to be obtained as crystals. (From *Enzymes*, by Sumner and Somers.)

The Fauna of America¹

By AUSTIN H. CLARK

Associate in Zoology, U. S. National Museum

[With 8 plates]

EUROPEANS seeing North America for the first time when the forests were untouched and game was plentiful found many types of animals familiar to them in Europe, together with others wholly new and strange. In the South, and especially the Southwest, they saw fewer familiar creatures and many more unfamiliar ones. To the early Spanish and Portuguese explorers and conquistadores South America was a wonderland in every way. The wealth of silver and gold in the western mountains was matched by the incredible wealth of strange mammals, queer fishes, and unusual and brilliantly colored birds and butterflies. Sloths, armadillos, anteaters, opossums, tapirs, hummingbirds, toucans, the giant condor, macaws, the large vivid blue morpho butterflies, the domesticated llama, alpaca, guinea pig, and Muscovy duck, and many other types were wholly different from anything they had seen in Europe or in Africa.

GEOLOGICAL HISTORY OF AMERICA

The characteristic features of the American fauna can be understood and appreciated only in the light of its geological and geographical background. Many millions of years ago in Cretaceous time North America was broadly connected with northeastern Asia, and in the south it was joined through Central America with northwestern South America. A narrow sea extended from the region of the Mackenzie River Delta in the north to the Gulf of Mexico in the south, covering Yucatán, most of the Gulf States, southern Georgia, northern Florida, and the Coastal Plain as far as Cape Cod. Early in the Eocene the connection with South America was interrupted, and the sea connecting the Gulf of Mexico with the Arctic Ocean disappeared. In the Miocene, North America became separated from Asia. Later, in the Pliocene, the connection with South America was reestablished. In

¹ Reprinted in somewhat extended form, by permission of the editors, from three articles published (in Hebrew) in the *Encyclopaedia Hebraica*, Jerusalem, 1951.

the late Pliocene conditions were essentially as they are today, but Newfoundland was still united with North America and most of Florida was submerged. In the Pleistocene, Alaska was again broadly connected with Asia, and Newfoundland became separated from the mainland.

In spite of relatively minor changes in the relation of sea and land, North America has always been essentially an integral part of the great permanent land mass of the Northern Hemisphere, the nursery of the world's land fauna from which at various times in the past the different animal types spread southward. There is no geological evidence of any fundamental changes in the relation between the oceans and the land masses.

A glance at a physical map of the Americas shows that from Guatemala to northern Venezuela, including the West Indies, the general trend of the highlands is east and west in marked contrast to the mountains of North and South America, which run approximately north and south. Judged solely on the basis of the Recent fauna, Central America may be defined as the region from the southern end of the Mexican Plateau to northern Venezuela, including the West Indies. But there is no geological or paleontological evidence that Central America was ever a geographical entity apart from tropical America as a whole. The concept of a hypothetical Antilia including the Central or Middle American area which, in one form or another, has been widely used to explain the differentiation and distribution of animal life in this region has no foundation in fact. Islands now separate were joined with each other, or with the mainland, but there was never a large and continuous land mass in the region between North and South America.

From the uniqueness of its fauna, it is evident that South America was for a long time wholly or in part isolated from the rest of the world, and this isolation is emphasized especially by the abundance in the past of large and bizarre mammals now known only as fossils. It is generally agreed that the eastern highlands of the Guianas and Brazil have been above the sea since the Trias, and that at some time or other in the Tertiary there was an oceanic interconnection along the Amazon Valley, or a long gulf extending inward from the Atlantic or Pacific, probably the latter. It is believed that Chile and the Patagonian Andes, which are quite distinct from the more northern Andes, have been land since very early times, and most students agree that southern South America was joined through Antarctica with New Zealand and Australia, at least until the Cretaceous. In the early Eocene, South America was cut off from North America. Between the late Eocene and the Pliocene there were various islands between the two. In the late Pliocene they were again joined, and a considerable interchange of faunas followed.

GEOLOGY AND ZOOLOGY

These geological changes were accompanied by more or less extensive changes in climate over the areas affected. Most important of these changes were the climatic variations in North America. Before and during the Tertiary a large part of North America was subtropical or tropical, and the southern part remained tropical until at least the late Tertiary. This gradual change from a subtropical and tropical to a temperate climate had the effect of restricting to the south, or eliminating completely, many of the elements in the original North American fauna, a number of which are now found only in tropical America. With the geographical and climatic changes, various major and minor centers of evolution appeared throughout the Americas, giving rise to more or less distinctive types which spread to other areas, became progressively restricted in their distribution, or disappeared.

The geological history of the different vertebrate groups must be considered in connection with their present distribution. First to appear were the fishes, known from the Ordovician; amphibians are first found in the Upper Devonian, reptiles in the Pennsylvanian, and mammals probably in the Upper Triassic. The first known birds are from the Jurassic. Although the genetic rate of evolution may be independent of environment, an important factor in the evolution of animal types is the relative stability or instability of the habitat and its effect on natural selection. The basic ecology of the several vertebrate groups varies to a greater or lesser degree, though there is much overlapping, particularly in specialized forms. Aquatic habitats are the least variable, and so the fresh-water fishes, especially in the Tropics, have the most generalized distribution with the nearest approach to their distribution in the far-distant past. The distribution of the amphibians is, in general, parallel with that of the fishes. As a result of the great variability of terrestrial conditions—diurnal and seasonal—at different times in the past, the distribution of the reptiles and especially of the mammals reflects present conditions much more closely than does that of the aquatic and amphibious groups. In the reptiles, birds, and mammals those types that feed entirely, or almost entirely, in water are in general more widely and generally distributed than those that are entirely terrestrial.

Worthy of special mention in the present fauna of America are such very ancient types as the ganoid fishes of North America, the lungfishes and osteoglossids of South America, various frogs of South America, and the ribbed or tailed frog (*Ascaphus*) of our Northwest related to *Liopelma* of New Zealand, and among invertebrates the onychophores (*Peripatus* and its relatives) of Central and South America and the West Indies. In North America the paddlefish (*Polyodon*) and the alligator, each with a single relative in China; the hellbender

(*Cryptobranchus*) related to the giant salamander of Japan; the shovel-nosed sturgeon (*Scaphirhynchus*) with relatives in central Asia; and the mud puppies (*Necturus*) and mud minnows (*Umbra*) with relatives in southeastern Europe are localized remnants of types that in the distant past were widely and generally distributed.

As examples of an animal type abundant and widespread but now greatly reduced in range and numbers, the camels may be mentioned. Camels originated in western North America where they were formerly abundant and diversified. From this center they spread to South America and Asia. They have now disappeared except for four forms in South America and two in Asia, one of which has been introduced into Africa. Two of the South American species and both the Asiatic are known only as domesticated animals.

PRESENT-DAY GEOGRAPHY

In Alaska the Arctic barrens of Asia are continued and range eastward to Ungava and Labrador, increasing in extent eastward, beyond the mouth of the Mackenzie River, and reaching Churchill on the western shore of Hudson Bay and nearly to James Bay on the southeastern shore. The mountains of Alaska run east and west continuing those of northeastern Asia (the Anadyr and Kolyma ranges), but in southeastern Alaska and Yukon they turn southeastward, maintaining the same direction to the Guatemalan highlands. The eastern highlands of North America run from the Gulf of St. Lawrence to northern Georgia in a southwesterly direction. In the western mountains arctic, or at least boreal, conditions occur at increasingly high altitudes to southern California, Arizona, and New Mexico. In the east less extreme but still northern conditions range southward in the mountains to northeastern Georgia.

From the Arctic Ocean to the Gulf of Mexico the central part of North America is low with no natural barriers, so the grasslands, and in the west the deserts, extend from Mexico and the Gulf far northward into Canada. This absence of barriers facilitates the northern or southern extension of the ranges of animals so that the distributional picture over most of the area in certain respects suggests that of Africa or Australia rather than that of Europe or Asia. Except for the Rio Grande, the rivers and lakes of North America are all cold, or at least cool. Nearly all are northern. The Mississippi River with its tributaries drain an area that is cool to very cold in winter so that its waters are not suitable for the types of fishes inhabiting the warm lowland rivers of southern Asia or the fresh waters of Africa or South America.

Continental Central America is remarkable for the diversity of its physical conditions. The land includes extensive low areas near sea

level and diversified highlands up to 14,000 feet in Guatemala. Arid regions with cactus grade into dense tropical forests, and these into pine forests. The islands also are greatly diversified. Some, like the Bahamas, Antigua, and Barbados, are low and flat, chiefly of coral formation, but most of the others consist largely or mainly of heavily forested mountains rising to 9,000 feet in Haiti and more than 7,000 feet in Jamaica.

Most of South America is low. The great chain of the Andes, with an average height of 11,000 to 12,000 feet, runs close to the western border with an eastward spur along the Caribbean coast. The Guiana highlands separate most of the Orinoco Valley from that of the Amazon, and in eastern Brazil are the extensive Brazilian highlands. The lowlands vary from dry and partly barren through areas covered with rank herbage, permanently or seasonally, to the dense forests of the Amazon Valley, especially the western half. These forests are unique in being canopy forests consisting of vast masses of vegetation tied together with vines and supported by tree trunks, with sparse undergrowth, in many areas flooded during the rainy season.

FAUNA OF NORTH AMERICA

In the treeless high Arctic zone, the southern limits of which are sometimes north and sometimes south of the Arctic Circle, the animals of North America are almost wholly circumpolar, as the caribou (reindeer), polar bear, Arctic wolf, fox, hare, lemmings, and weasels. Most characteristic of the mammals of the American Arctic is the musk ox, now extinct in the Old World, living in the far north from east of the Mackenzie River to northern Greenland. Of the 65 genera of birds 60 are circumpolar, including the ptarmigan, gyrfalcon, snowy owl, snow bunting, and many others. Fresh-water fishes are few—only some trout; the three-spined stickleback; and the Alaska blackfish (*Dallia*) of Alaska and Siberia, which is frozen in the ice for a considerable part of each year. There are no reptiles or amphibians. The insects are mostly circumpolar, and as in all regions where conditions are unfavorable for animal life, the Diptera, or two-winged flies, predominate. Biting flies, especially mosquitoes and black flies (*Simulium*), are especially abundant. The butterflies are all familiar Old World types.

Farther south in the region of the forests there is a marked increase in animal life. Distinctively American types now appear, there is a considerable difference between east and west, and in the western mountains there is a continuation into America of Old World mountain or alpine forms. Old World animals of general distribution are represented by the moose, caribou, wolf, foxes, bears, lynxes, wolverines, martens, weasels, otters, the varying hare, squirrels, and other rodents,

and shrews, and by the widespread swallowtail butterfly *Papilio machaon*. In the western mountains there are wild sheep, the mountain goat, bears, and the conspicuous large white butterfly *Parnassius*. Among American types are the puma, raccoon, skunks, tree porcupines, American squirrels and other rodents, and the American (Virginia) type of deer, and, among strictly North American animals, the coyote.

Among the birds of Old World affinities there are in the boreal region, of general distribution, many ducks, loons, the golden eagle, raven, crow, Canada jay, hawk-owl, several hawks and falcons, cross-bills, nuthatches, the magpie, the Bohemian waxwing, and various smaller species. Among the birds confined to the far northwest, in Alaska, Cassin's bullfinch, the red-spotted bluethroat, yellow wagtail, and willow warbler migrate south in winter through Asia, not through America.

Distinctively American types of general distribution are the Canada goose and its varieties, snow geese, the blue goose, ruddy and other ducks, the little brown crane, several owls, the bald eagle, and many small birds. Confined to the west are the emperor goose, black brant, bristle-thighed curlew, wandering tattler, surfbird, and many small birds. In the central part of the continent are the whooping crane, Wilson's phalarope, and some other species. Special mention must be made of two large families of birds peculiar to America that reach the boreal region, the American warblers (Parulidae), many of which breed in the northern forests, and the hummingbirds (Trochilidae), of which one, the rufous hummingbird, reaches Alaska, and another, the ruby-throated hummingbird, is found from Saskatchewan to Cape Breton and southward. Many of these strictly American birds breed far to the northward, but all migrate south in winter.

On Newfoundland many of the animals differ more or less widely from those on the continent, and some of the characteristic continental types, such as the moose, elk, and many smaller species, are lacking. A number of animals on the Labrador peninsula differ from their relatives west of Hudson Bay or farther south.

Frogs and toads are represented from Alaska to Hudson Bay. A few snakes, turtles (including the soft-shelled turtle), and salamanders reach the boreal region in southern Canada. Fishes are abundant, though not very diversified, with a number of Old World types such as trout, grayling (*Thymallus*), whitefish (*Coregonus*), and pike (*Esox*), and some American such as the black bass (*Micropterus*), darters (Etheostomidae), and suckers (Catostomidae). In the streams of the north Atlantic coast lives the Atlantic salmon, now becoming rare, and in those of the Pacific coast (and of eastern Asia as well) occur the five species of Pacific salmon (*Onchorhynchus*), which, in contrast to the Atlantic salmon, breed only once and die.

The insects have increased greatly in variety. Many are from the Old World, but many are typically American, particularly toward the south. These last include two types of swallowtail butterflies of strictly North American groups, *Papilio glaucus* and its relatives, and *P. troilus*.

South of southeastern Canada, the Great Lakes region, and New England many additional animal types appear. With Old World affinities are the pikas and badgers in the west and the generally distributed moles; strictly American are the opossum and various small hares in the east, the large jack rabbits, prairie dogs, ground squirrels, kangaroo rats, and other rodents in the west. Strictly North American are the pronghorn (*Antilocapra*) of the Western Plains, the gray fox (*Urocyon*), and in the northwestern United States the sewellel (*Aplodontia*). Still farther south are the generally distributed spotted skunks, and in the Southwest the tropical armadillo, peccary, jaguar, ocelot, and cacomixl (*Bassariscus*), in addition to most of the types found farther north.

Among the birds a number of northern kinds range down to Georgia in the mountains in the east and to Mexico in the west, and some in the lowlands to Florida and the Gulf. Many other bird types appear, chiefly in the lowlands, such as various rails, the white pelican (in the west), egrets, herons, doves and pigeons, burrowing owls, pileated and other woodpeckers, cuckoos, including the western roadrunner (*Geococcyx*), numerous wrens, the cardinal, towhee, grosbeaks, the indigobird and other finches, some brilliantly colored, swifts, whip-poorwills and other goatsuckers, and especially representatives of the exclusively American families Odontophoridae (American quails), Meleagrididae (turkeys), Cathartidae (American vultures, including the giant California condor), Icteridae (American orioles and blackbirds and the meadowlarks, bobolink, and parasitic cowbirds), Thraupidae (tanagers), Vireonidae (vireos), Mimidae (mockingbird, thrashers, and catbird), and Tyrannidae (American kingbirds and flycatchers). Farther south are additional types—the wood ibis (*Mycteria*), the only American stork, snakebird (*Anhinga*), brown pelican, more finches; in the west several hummingbirds; and the American family Aramididae (wood rails or courlans). In the extreme south are a few tropical types such as the white ibis, roseate spoonbill, caracaras, kites, and some tropical terns.

Toward the south the reptiles increase rapidly in number, first the snakes and the turtles, later the lizards, the last especially in the west. The reptiles are quite different from those of Europe and northern Asia and largely different from those of South America. Most noteworthy are the snapping turtles, the common snapper reaching 75 pounds and the more southern alligator snapper 150 pounds; the rattle-

snakes, one of which, the southern diamondback, reaches more than 8 feet in length; the coral snakes of the south; and the iguanoid lizards, including the curiously flat and broad horned toads, which squirt a drop of blood from above the eye when alarmed. In the southeast lives the alligator, and in the extreme south the American crocodile.

Amphibians, especially frogs, tree frogs, toads, and in the mountains salamanders, become abundant. Worthy of mention are the bull frog, 8 inches long; among the salamanders in the east the hellbender, 2 feet long; several mud puppies, also up to 2 feet long; the congo snakes (*Amphiuma*) with rudimentary legs, up to 3 feet long; and the mud eels (*Siren*) with no hind legs, also 3 feet long. North America is the richest part of the world in salamanders, as South America is in frogs.

Fishes are very numerous, largely of endemic types such as the nest-building Centrarchidae, the gars (*Lepidosteus*), and the bowfin (*Amia*). Especially interesting are the cave fishes (Amblyopsidae), of which four genera with seven blind and colorless species occur in the subterranean waters in the eastern half of the Mississippi Valley, and one genus with two normally colored species with fully developed eyes inhabits the coastal swamps from Virginia to Georgia. These are evidently the remnants of a once numerous and widespread group. The North American catfishes (Ameiuridae) and the suckers (Cato-stomidae) are almost wholly North American, but both families have a representative or two in eastern Asia.

Insects are exceedingly numerous and diversified; many are of tropical American types, though some are endemic. There are about 700 different kinds of butterflies, many of which are large and handsome. One small butterfly (*Feniseca*) with African and Asiatic relatives is carnivorous in the early stages. Of other invertebrates, the fresh-water mussels (Unionidae) are more numerous and diversified in North America than elsewhere.

FAUNA OF CENTRAL AMERICA

The fauna of the mainland of Central America is predominantly South American with an admixture of North American types, especially in the highlands, and a few Antillean forms. It reflects the diversity of the geographical features, and minor local variants of both South and North American animals are abundant. The fauna of the West Indies is scanty and is composed of types at present largely unrepresented, or but poorly represented, on the mainland.

Among the mammals of Central America are two species of tapirs that are quite distinct from all other living tapirs though related to fossils found in North America, one ranging from Panama to Mexico, the other found in Guatemala, Nicaragua, and Costa Rica. Spider



1. TWO YOUNG BULL ELKS ON REFUGE, JACKSON, WYO.



2. TWO BUCK MULE DEER, NATIONAL BISOI RANGE, MOIESE, MONT.
Photographs by E. P. Haddon, courtesy U. S. Fish and Wildlife Service.



1. MOUNTAIN SHEEP, YELLOWSTONE PARK, WYO.

Photograph by M. P. Skinner, courtesy U. S. Fish and Wildlife Service.



2. MOUNTAIN GOAT (*Oreamnos americanus*), ALASKA

This is really a mountain antelope, closely related to the European chamois. It occurs from Alaska south to Montana and Idaho in the Rockies and the Coast Range. Photograph by C. Rhode, courtesy U. S. Fish and Wildlife Service.



MOOSE, HARVEY LAKE, ALASKA

Photograph by J. Malcolm Greany, courtesy U. S. Fish and Wildlife Service.



NORMAL-COLOR BISON AND ALBINO BISON, MISSION VALLEY, MONTANA, MONT.

Photograph by E. P. Haddon, courtesy U. S. Fish and Wildlife Service.



1. WILD TURKEY GOBBLER. WICHITA MOUNTAINS WILDLIFE REFUGE. OKLA.
Photograph by Leo K. Couch, courtesy U. S. Fish and Wildlife Service.



2. CANADA GESE. LOWER SOURIS MIGRATORY WATERFOWL REFUGE. N DAK
Photograph by C. J. Henry, courtesy U. S. Fish and Wildlife Service.



Hundreds of thousands of blue geese and snow geese concentrate on the Gulf coast of Louisiana and eastern Texas each winter. They remain there until about the first of March when they start their return journey to their Arctic nesting grounds. Photograph by John J. Lynch, courtesy U. S. Fish and Wildlife Service.



1. ARMADILLO

Courtesy National Zoological Park.



2. MANED WOLF

Courtesy National Zoological Park.



BRAZILIAN TAPIR
Courtesy National Zoological Park.

monkeys range north to Mexico, howlers to Guatemala, and several other types, including marmosets, to Costa Rica. Sloths range north to Mexico. Other mammals now characteristic of South America are the jaguar, ocelot and other cats, peccary, armadillo, coati, kinkajou, prehensile-tailed porcupine, agouti and numerous other rodents, and many bats, including the small blood-feeding vampires. Of very wide distribution are the puma and otter. Mammals of northern affinities, chiefly in Mexico, are the wolf, coyote, deer, raccoon, badger, hare, squirrel, cacomixl, pouched rat (gopher or quachil) and some other rodents, and insectivores.

Among the interesting fossil mammals of the West Indies are a ground sloth (*Megalonyx*), as large as a small bear, from Cuba, and a very large rodent of the same size (*Amblyrhiza*) from the very small islands of Anguilla and St. Martins. These indicate a connection at some time with continental Central or South America. There are no fossil mammals known from the West Indies of greater age than the Pleistocene. Most interesting of the living mammals of the West Indies are the two species of *Solenodon*, one on Cuba and one on Haiti. These are large insectivores with the body about a foot long with fossil relatives in the Oligocene of North America and living relatives chiefly in Madagascar, with a few in west Africa.

Confined to the Greater Antilles are the large ratlike mammals called hutias. The genus *Plagiodontia* lives only on Haiti. Species of *Capromys* with short tails are found in the Bahamas, on Jamaica, and on Swan Island north of Honduras. Three species with long tails live on Cuba. A related but distinct type (*Procapromys*) is said to occur in the mountains of northern Venezuela. Raccoons occur, or did occur until recently, on New Providence, Bahamas, Guadeloupe, and Barbados. The rice rat of Jamaica (*Orizomys*) is an island representative of one on the Honduras Peninsula. Of the 31 genera of bats living in the West Indies no less than 10 are peculiar to the islands, 7 confined to the Greater Antilles, including the Bahamas, and 3 of general distribution.

Very distinct from the fauna of the Greater Antilles with its Central and North American affinities is that of the Lesser Antilles, related most closely to that of South America. The fauna of Trinidad is that of adjacent Venezuela. The fauna of Tobago resembles that of Trinidad and includes a peccary, opossum, mouse opossum (*Marmosa*), small armadillo, paca, agouti, squirrel, spiny rat, and muskrat (*Megalomys*). On Grenada, the southernmost of the Lesser Antilles properly speaking, there is only the opossum (extensively introduced into the northern islands), mouse opossum (which ranges into the Grenadines), agouti, and the small armadillo. There is an introduced African monkey on Grenada, and another African species on Barbados

and St. Kitts. Agoutis occur, or did until recently, on practically all the islands as far as St. Thomas. Musk rats (*Megalomys*) are found only on Tobago, St. Lucia, and Martinique, with a fossil species on Barbados. The rice rat in the Lesser Antilles is related to one in adjacent South America. There is a spiny rat (*Loncheres*) on Martinique. Manatees, once common in suitable localities along the coasts and about the larger islands, including Guadeloupe, are now rare. The West Indian seal, a close relative of the Mediterranean seal, formerly common and widely distributed, is now found only on some small islands off Yucatán. Many West Indian mammals have wholly disappeared since the settlement of the islands by Europeans.

The birds of Central America are very numerous. Nearly all are of types now found in South America, but there is an extraordinary number of endemic genera in almost all groups, especially in the hummingbirds, finches, and flycatchers. The best-known bird confined to Central America and found chiefly in Costa Rica is the quetzal, the most magnificent of all the colorful trogons. There is a marked zonal distribution in Central America and, chiefly at the higher altitudes, several North American birds occur, such as evening grosbeaks, crossbills, goldfinches, and others. Very many North American species pass the winter in Central America and the West Indies and farther south.

In the West Indies there are 32 genera of birds confined to the Greater Antilles and 8 to the Lesser. Two distinct families are wholly West Indian, the palm chats (*Dulidae*) of Haiti and the todies (*Todidae*) of Cuba, Isle of Pines, Jamaica, Puerto Rico, and Haiti. Zonal distribution is found only on Haiti where the white-winged crossbill, Andean sparrow, and Antillean goldfinch occur at the higher altitudes. Some characteristic West Indian birds live on the islands off the Yucatán coast, on Curaçao, Aruba, and Bonaire, and on Tobago. Among the more interesting West Indian birds are Princess Helen's hummingbird of Cuba, smallest of all birds, $2\frac{3}{8}$ inches in total length; two genera of Lesser Antillean hummingbirds (*Eulampis* and *Sericotes*) in which both sexes are similarly colored and equally brilliant; a cotinga on Jamaica; endemic types of trogons on Cuba and Haiti; and very distinctive large parrots on St. Vincent and Dominica; other parrots live on St. Lucia, Dominica, and in the Greater Antilles. In former times distinctive macaws occurred on Cuba, Jamaica, Guadeloupe, Dominica, and Martinique, and probably on Haiti. In addition to these, other West Indian birds have disappeared since the coming of Europeans.

The reptiles of Central America and the West Indies are numerous. The turtles are all North American. The family Dermatemydidae, now confined to Guatemala and adjacent areas, is found as a fossil in

North America. Snapping turtles occur in Mexico, Guatemala, and Ecuador. The large crocodile found in the extreme south of North America lives on the Central American coast and about the larger West Indian islands, and there is a small one in Cuba and another in Central America where caimans also occur in the rivers. Lizards are numerous and diversified with a number of local genera, especially in the Greater Antilles. Most of them belong to the family Iguanidae. Some of the herbivorous iguanas reach a length of 5 feet or more. Snakes are numerous and diversified, with a number of endemic types. The very poisonous fer-de-lance is found on Martinique and St. Lucia. Largest of the Central American snakes is the boa constrictor, up to 12 feet long, though seldom more than 7 feet. Frogs are numerous and varied with several endemic types. Salamanders are found in Central America and one lives on Haiti. There are no coccilians.

The fishes of Central America are mainly South American, but several characteristic South American types are absent. Trout range south to Durango, Mexico, and a few other North American fishes extend to Guatemala. Among the more interesting fishes are three ganoids, the North American *Lepidosteus osseus* in northeastern Mexico, *L. tropicus* ranging from Mexico to Panama, and *L. tristoechus*, the great alligator gar, found in Mexico and Cuba as well as in the southern United States. Of the more than 100 species of Cichlidae 17 are confined to Lakes Nicaragua and Managua, 6 to Cuba, and 1 to Barbados. In Lake Nicaragua there are a shark and a sawfish (*Pristis*). In the caves of Cuba there are two blindfishes (*Lucifuga*) belonging to a family (Brotulidae) chiefly represented in the oceanic abysses.

Land snails are extremely varied, and their abundance is one of the main features of the West Indian fauna. Many endemic types occur, especially in the Greater Antilles. Those of Cuba are unexcelled for variety and beauty.

The very numerous butterflies are mostly South American with some familiar northern types, especially in the Central American highlands. There are several endemic genera, some confined to the Greater Antilles. One genus of curious large butterflies (*Anelia*) is confined to Haiti, Cuba, and Central America.

The Onychophora are well represented, with four genera and seven species in Panama. One genus (*Peripatus*) occurs on almost every island from St. Vincent and Barbados to the Virgin Islands, Puerto Rico, Haiti, and Jamaica, and also in northern Venezuela, Panama, and Costa Rica. *Plicatoperipatus* is confined to Jamaica. The South and Central American genus *Epiperipatus* lives on Trinidad, Tobago, and Grenada; and *Macroperipatus*, which ranges north to Veracruz, Mexico, is represented on Trinidad and Haiti. The Andean *Oroperi-*

patus occurs at Panama and ranges northward to Tepic, Mexico. There are no Onychophora on Cuba. These curious wormlike animals belong to a very ancient group known as fossils in the Middle Cambrian of British Columbia.

THE FAUNA OF SOUTH AMERICA

The fauna of South America reflects its very early connection with North America, its later long isolation during which many strange endemic types developed, now largely extinct, and its reunion with North America in the Pliocene, permitting the introduction of North American types of relatively recent origin. In the south it retains many animal types, especially in the fresh-water fishes and invertebrates, that are relics of a very old connection with New Zealand and Australia and are quite different from any found farther north.

The fauna of South America has essentially the appearance of the fauna of a large tropical island, the long isolation of which resulted in the development from generalized stock of a large number of endemic types, merged with the fauna of a southern land mass including New Zealand and Australia, with an intrusion of animal forms that have arrived from North America since the Pliocene. In spite of very marked affinities with Africa seen in the aquatic and amphibious animals especially, there is no necessity for assuming a direct union with Africa at any time, though there may have been such a union. The similarity to Africa is most probably due to the conservation of ancient types once generally distributed which in the northern land masses have been superseded by others better suited to present conditions that have been prevented by certain barriers from reaching the southern continents. Also it is probable that in Africa and especially South America climatic and meteorological changes have been less extreme, particularly in the fresh waters, than in the great land masses of the north, which would favor the persistence of many ancient types.

Perhaps the most characteristic feature of South America is the canopy forest. Here animals live largely high above the ground. To keep from falling from the canopy many mammals of widely different kinds, as opossums, an anteater, porcupines, kinkajous, and some monkeys, have developed prehensile tails, and the sloths have enormous claws. There are no gliding animals, such as we see in the northern and Old World forests, in Australia, and especially in the Malayan region. Birds and butterflies are especially numerous and varied. In the deep shade of the forests live many butterflies with largely transparent wings and others with vivid colors on the under side but dull above. A striking feature of the birds and butterflies is the extraordinary prevalence of brilliant and often flashing colors, especially blue. Some of the numerous frogs are also brightly colored.

It is in the western Amazonian region and the eastern Andes that animal life is most highly diversified. The lowlands are curious in lacking the herds of large herbivorous mammals so characteristic of Europe, Asia, North America, and especially Africa. There are no grazing mammals, and the terrestrial browsers are represented only by a few small deer. The place of the hoofed animals is taken by a great variety of rodents, as it is in Australia by kangaroos. Except in the northwest, bears and insectivores are absent. The place of arboreal insectivores is taken chiefly by marmosets, and that of terrestrial insectivores, as in Australia, by opossums and mice.

Unique among living mammals and confined to tropical America are the three types of sloths; the uncommon terrestrial giant anteater 4 feet long, the smaller terrestrial anteater, and the arboreal anteaters; and the various armadillos ranging in size from the little woolly armadillo (*Chlamydomorphus*) 5 inches long to the rare giant armadillo (*Priodontes*) 3 feet long. Exclusively tropical American except for one species in southern North America are the opossums, varying from the size of a mouse to that of a large cat. One has webbed feet and is aquatic. Quite a different type of marsupial is *Caenolestes* of Ecuador and adjacent Colombia related to the Australian phalangers.

The American monkeys, especially numerous in Brazil, are quite different from the Old World monkeys. They are less diversified and smaller. Some have prehensile tails. The chief types are the spider monkeys, woolly monkeys, sapajous, and the sluggish howlers, largest of American monkeys with a stupendous voice; sakis, short-tailed monkeys, night monkeys with enormous eyes, squirrel monkeys, and marmosets, smallest of monkeys—some smaller than a rat. One of the howlers is curious in having the males black, the females straw yellow.

Very characteristic of South America are the four camels, the guanaco, vicuña, llama, and alpaca, the two last known only as domestic animals. As a group they range from the extreme south to, in the Andes, Peru and Ecuador. Nearly as characteristic as the camels are the two tapirs, one in the forests and lowlands of Brazil and Paraguay, the other in the Andes. These are related to another in the Malay region, Sumatra, and Borneo.

Largest of the American cats, with a body length of about 4 to 5 feet, is the jaguar, thick-set, powerful, and dangerous, which ranges from Patagonia to Texas. Nearly as large, but with longer limbs, not so heavy, and generally tawny in color without distinctive markings, is the puma, found from Tierra del Fuego to latitude 60° N. in Canada. There are various smaller cats, some handsomely spotted or striped, others plain, but no lynxes.

Dogs are represented by several wolflike foxes, one very large, and the curious little bush dogs with short legs and tail. The raccoon family is represented by a raccoon, the coati, and the kinkajou, and the pigs by the collared and white-lipped peccaries. The deer are all of the American (Virginia deer) type, mostly small with simple antlers. One, the pudu of Ecuador, is no larger than a big hare and has spikelike antlers. The spectacled bear ranges in the Andes from Colombia to northwestern Argentina. It is more closely related to the Malayan bear than to any of those now living in North America. Mustelids (weasels, otters, skunks, and others) are numerous. In addition to many insectivorous and fruit-eating types the bats include the blood-feeding vampires and the fish-catching bats, largest of American bats, with an expanse of 26 inches or more. The fish-eating bats have the toes and claws on the hind feet greatly compressed laterally so as to minimize the resistance of the water when scooping up small fishes.

Especially characteristic of South America are the extraordinarily numerous and diversified rodents, including many types not found elsewhere. Worthy of special mention are the prehensile-tailed porcupines, caviés (guinea pigs), chinchillas, coypus, pacas, agoutis, the subterranean tucutucus, squirrels, the capybara, largest of living rodents, about 4 feet long weighing more than 100 pounds, and others. Of aquatic mammals the most interesting are the manatees of the large rivers (also in Africa) and the river dolphins of the upper Amazon and the estuary of the La Plata (other species occur in China and India).

Unusually numerous and varied are the birds, of about 2,500 species, including, besides representatives of families of wide distribution, about 30 families confined to America, mostly to the Tropics. Among these are the hummingbirds, toucans, jacamars, woodhewers, cotingas, manikins, plant-cutters, tanagers, screamers, New World vultures, including the king vulture and the great Andean condor, curassows and guans, hoatzins, trumpeters, cariamas, oilbirds, motmots, rheas, and tinamous. The tinamous are related to the rheas but are very much smaller and have fully developed wings. Besides these there are many interesting species in other groups, such as the macaws and many brightly colored parrots, the powerful harpy eagle, the black-necked swan, the Muscovy duck, and the flightless steamer duck.

Among the reptiles there are five caimans and three crocodiles. Most of these are small, but one caiman reaches 20 feet in length and one crocodile 25 feet. Turtles are represented by snake-necked turtles (elsewhere only in Australia) of which the most noteworthy is the curious matamata; the family Pelomedusidae (elsewhere only in Africa) including the economically important river turtle (*Pod-*

ocnemis), two land tortoises, a snapping turtle in the northwest, and a few others. There are no soft-shelled turtles. Lizards are numerous and varied, most of them belonging to the family Iguanidae, wholly American except for one iguana in Fiji and two in Madagascar. One of the iguanas, living on the Galápagos Islands, spends most of the time on land but feeds in the sea on seaweeds. Snakes are numerous and diversified, about as many as in the Indian region though less varied. Largest are the anacondas, some of which reach nearly or quite 40 feet in length, and the smaller boas. The poisonous snakes are the pit vipers, including the rattlesnakes and the dreaded bush-master, up to 10 feet long, and the brilliant coral snakes related to the Old World cobras. Burrowing snakes are also found.

The frogs outnumber those of any other region; their affinities are mainly African. Like the birds they include many bizarre types such as the horned frogs (*Ceratophrys*), the Surinam toad (*Pipa*) which raises its young in the skin of its back, and many brightly colored tree frogs, some of which are poisonous, with curious reproductive habits. Salamanders occur only in the northwest. Snake-like burrowing coecilians are found, chiefly in Ecuador. Toads are common. One, the giant toad (*Bufo marinus*), reaches 5 pounds in weight. I have seen this toad, which looks somewhat like a large stone, snap up young chickens as smaller toads do insects.

As far as fishes are concerned, no two regions could be more unlike than South and North America. In number of species the South American fish fauna is the richest in the world although less than a quarter of the fresh-water groups are represented. The affinities are predominantly with Africa. As in India there is a specialized alpine fish fauna. The extreme south agrees with New Zealand and Tasmania. Among the endemic South American types are the Gymnotidae, including the dreaded electric eel up to 6 feet long, the most powerful of electric fishes. The only other electric fish in fresh water is a catfish in Africa. The lungfish of the swamps (*Lepidosiren*) is related to others in Africa, and more remotely to two in Australia. There are two osteoglossids, one of which, the arapaima, is said to reach 15 feet in length with a weight of 400 pounds. This is the largest fresh-water fish in America and, with the possible exception of the European catfish and a Chinese fish (*Psephurus*), the largest in the world. It is unusual among fishes in being a vegetarian.

The characinids, otherwise African, are numerous and diversified. Among these are the ferocious piranhas or cannibal fishes (*Serrasalmo*), perhaps the most dangerous of all fishes. Catfishes are abundant and varied, and many are heavily armored. The largest reach 9 feet in length. Some very small species, scarcely an inch long, live as parasites in the gill chambers of larger ones. One urinophilous

species sometimes causes trouble by crawling into the urethra of bathers. The curious four-eyed fishes have the eyes divided into an upper and a lower half for simultaneous vision in the air and under water. There are two small fresh-water flyingfishes, not related to the marine flyingfishes, and in the rivers formidable sting rays.

The insects and other invertebrates are as diversified as the vertebrates. Rather more than a third of all known butterflies, including many endemic groups, are tropical American. Among these an extraordinarily large number are vividly colored, the most spectacular being the great metallic blue morphos; but the largest morphos are dull in color. Then there are the huge owl butterflies (*Caligo*) and the noisy whip-crackers (*Hamadryas* or *Ageronia*). In the southern Andes there is a satyrid or wood nymph almost wholly metallic silver on both surfaces, and a skipper brilliant gold on the under side. Among other invertebrates the giant bird-catching spider 8 inches across should be mentioned, together with the giant wasps (*Pepsis*) that feed on it and its relatives. The curious onychophores are especially numerous in Central and South America. Those in the Tropics belong to a group elsewhere represented only in tropical Africa, while those in southern South America are related to others in New Zealand and Australia.

There are many other interesting features connected with the fauna of the Americas—its origin, diversification at different periods in the past and in response to present conditions, and the fundamental changes that have come about since the settlement by Europeans, and are continuing today with increasing speed. This brief survey, however, will suffice to bring out the similarities to, and contrasts with, the corresponding faunas of Eurasia and Africa.

The Mechanics of Snakes¹

By ALFRED LEUTSCHER

British Museum (Natural History)

[With 3 plates]

A FRIEND of mine once tried to get through the customs a snake he was bringing back with him from the Continent. Four-footed animals, such as the rabbit and squirrel which he also had with his baggage, were passed by the customs officer without comment. But no matter how my friend attempted to trace the ancestry of his reptile pet in terms of lost legs, it had none just then, so that was that.

That serpents are of quadruped descent is not an easy matter to prove. Their lack of legs was formerly sufficient, even among scientific circles, to link them with other limbless creatures, such as those amphibians with scales in their skins, called coecilians, and certain limbless lizards like our native slowworm. There is even no tangible evidence to show that they ever possessed functional limbs.

Snakes have been claimed from Cretaceous rocks, but such occurrence is doubtful. Later fossils from the lower Eocene in America approach the lizard type in bone structure. Viperlike snakes are known from the Miocene of France and Germany. More recent snakes from Egypt are boalike and appear to have been monsters, probably growing to 60 feet in length. All the above were snakes—that is, without functional limbs.

There is no “story of the horse” flavor to show for a snake’s evolution, which is understandable since the skeletons of these creatures are too delicate and brittle to fossilize well, and the full story of how the snakes evolved may remain forever a secret.

Circumstantial evidence and comparative anatomy of snakes, however, indicate that they are undoubted reptiles which, as a class, are derived from land quadrupeds. A faint clue to the origin of snakes may be seen in the skeleton of the largest living species, which are of the more primitive kind. One familiar member of this family (the Boiidae), the python, retains a curious relic of the past in the shape of certain bones lying near the base of the tail. They consist of what are

¹ Reprinted by permission from *Discovery*, December 1950.

thought to be traces of a pelvis and hind limbs. Attached to each femur there is on the surface of the body a conical, clawlike spur. These spurs are larger in the male python and no longer function as limbs but serve as excitor organs when scraped against the female during the act of mating. We see a somewhat similar parallel in the vestigial hind limbs of certain whales, undoubted mammals which live entirely in water and whose quadruped ancestors are as much a mystery as those of snakes.

Serpents superficially resemble worms, for which they may be mistaken, but a true worm has no bony jaws, tongue, or well-developed eyes and is classed with the animals that have no backbone. The wormlike snakes vary greatly in length, from a 4-inch species like *Gluconia dissimilis* to a 30-foot giant like the Malay python (*Python reticulatus*). Their body may be long and slender, or short and fat, according to the species.

The backbone of a snake is composed of numerous vertebrae which are of two kinds—those of the body, which carry each a pair of ribs, and those of the short tail, which have instead long transverse processes. The vertebrae are connected by “ball-and-socket” joints which allow for great flexibility. At the same time, because of certain projections on each vertebra that lock with the adjacent ones in a kind of dovetailed joint, a snake’s body possesses a rigidity that is remarkable for such a delicate mechanism. The slightest blow will fracture or dislocate a snake’s backbone, yet the animal can twist and rear into positions impossible in other vertebrates. Many a pet snake owes its escape from captivity to the strength and suppleness of its backbone.

The dovetailed jointing to some extent limits the body movements in the vertical plane but does not interfere with the extensive lateral play typical of a snake in movement. Illustrations by early naturalists and modern cartoonists often depict the progress of snakes and “sea serpents” in vertical undulations. Such movement is entirely foreign to snakes and to reptiles in general; it is, in fact, quite impossible, because of the way the backbone is constructed.

The numerous curved ribs which are joined in pairs to the trunk vertebrae are capable of certain movements. Lateral movement is seen under certain circumstances, as when the snake is flattening the body in the sunning attitude or when allowing passage of a meal, which can be detected as a bulge along the body. No breastbone exists in snakes to hamper their movements. The movement of the ribs backward and forward was at one time thought to play an important part in locomotion, but this has recently been questioned. Locomotion is now thought to operate under muscle action which is visible to the eye in the movement of the body surface, especially on the lower side.

In climbing or creeping at a slow pace some snakes are capable of moving forward in a perfectly straight line. A wave action on the lower sides of the body, which moves forward in a series of steps, is caused by successive contractions and relaxations of the muscles underneath. Attached to the ribs, these muscles operate on the lower body surface, which in most snakes is covered by a series of broad, transverse scales, known as shields. These shields correspond in number to the vertebrae and overlap like roofing slates along their hind edges. The free borders of the shields grip onto any rough surface or irregularity over which the snake happens to be passing, and this action is most apparent along those parts of the body that are in contact with the ground, rock, or branch. This rectilinear movement has been compared with that of an earthworm and has often been described as "a snake walking on its ribs." Actually, one gets a better analogy when one visualizes the rowing of a boat. The oar blade which grips the water corresponds to the ventral shield, the oar is the lever of rib and muscle, and the ground is the fulcrum. Such movement is in common use in ground snakes, such as our native adder, and arboreal snakes such as the Aesculapian snake (*Elaphe longissima*) of south Europe (pl. 1, fig. 1). This latter, like many of its relatives, has overlapping belly shields which bend at a sharp angle along their shorter sides. This forms a sharp keel which gives an extra grip on the smallest irregularities on bark or rock over which it climbs.

The feats of climbing displayed by a pet Aesculapian snake in my collection reveal the high degree of specialization achieved by snakes. This specimen will climb over the furniture or crawl along the picture rail in my study, never missing its hold or making a false move. It can cling by its tail or any part of the body to the buttons of one's waistcoat, or hang from a projecting pen fixed into a pocket. When seeking a new perch it will stretch out its slender body in a horizontal plane to a third of its length, unsupported in the air, as it reaches over a gap to secure a fresh hold. The rest of the body, and in particular the prehensile tail, meanwhile retains a secure grip which it refuses to relax until the next foothold is secured. If I attempt to pull it free the grip is tightened. If I stand nearby it may attempt to bridge the gap in order to reach an arm or shoulder. Should I move slightly it draws back, remaining on its former perch. This is strongly reminiscent of an experienced mountaineer who always makes sure of his next step before he releases a previous foothold.

Along a tightened rope this snake will hang its body in loops over each side, edging itself along slowly in a remarkable display of coordinated muscle action in order to maintain its balance. Its "star turn" is the grip it can maintain when hanging onto an electric-light switch set into a wall. Here, on the only projection, less than half an inch,

on a flat, vertical surface of many square feet, it will remain for over an hour, never relaxing its grip.

A similar grip is used by this pet snake in constricting prey, a habit best known among boas and pythons. (It is indeed possible for a large boa or python to constrict and even kill a man, but there is no cause for alarm when a tamed python is coiled around one's neck or arm and commences to exert pressure; it is merely securing a firmer hold in order to prevent a fall.)

Rectilinear movement takes place at leisurely speed. At moderate or high speed a snake displays the typical serpentine movement, as it is called, wherein the body undulates in lateral curves and can thereby brace itself against projecting obstacles in its path. Without such projections a snake cannot proceed, as may be shown by placing it on a highly polished surface.

Where the flow of curves is restricted, as in a narrow tunnel, a snake may resort to yet a third locomotion called the concertina movement. At intervals along its body are stationary curves that press firmly against the sides of the tunnel acting as anchors toward which and away from which the parts in between can be moved. In this way

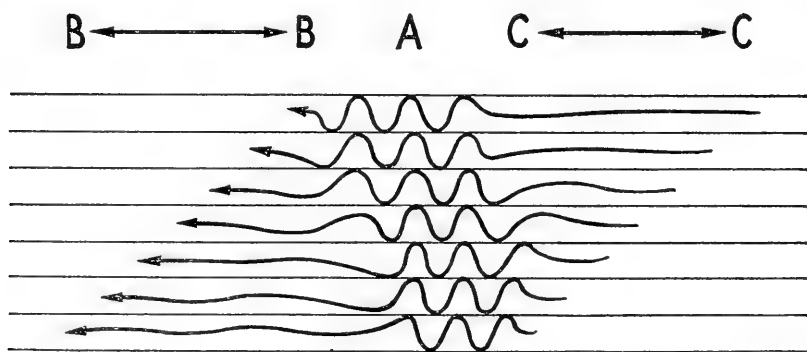

FIGURE 1.—Stages, from top to bottom, of concertina movement in a snake moving along a tunnel. A, Body at rest where it touches the tunnel walls. B, Body in front moving forward. C, Body behind being drawn up.

it progresses in steps along the tunnel (fig. 1). Frequently a mixture of both this and rectilinear movement takes place in which the belly shields at the stationary points along the body grip the underlying surface.

In some snakes, especially certain vipers and rattlesnakes, a curious sideways progression occurs. One North American rattlesnake (*Crotalus cerastes*), in fact, is named after this peculiarity. It is called the sidewinder. When side winding a snake proceeds in a direc-

tion that is at an angle to that in which it is facing. The body does not follow the course of the head but, as it were, tacks away from a base line.

In burrowing snakes, of which *Typhlops* is a typical example, there are no broad belly shields, and the body is uniformly covered with polished and closely united scales of more or less equal size. This is also found in the slowworm, a legless lizard that is fond of burrowing. There is no risk of earth particles becoming caught up in the skin, and the scales play no part in locomotion. Instead, the body twists and turns in all directions, pushing its curves against resisting bodies, such as stones, plants, and the walls of burrows to propel itself forward. In some burrowing snakes (e. g., *Uropeltis*) the short tail ends abruptly in a broadened oblique surface, which is covered with large scales, and this operates somewhat like a digging implement.

The highly poisonous sea snakes, which constitute the subfamily Hydrophiinae (these are the only "sea serpents" at present recognized by science), are entirely divorced from the land, being viviparous and adapted for swimming. They have strongly compressed bodies and oarlike tails which present a broad surface to the water as they progress with lateral undulations. This compares with the movement of fishes and is thought to be a relic of their fish ancestry. Even a land snake, such as the grass snake, will swim in this manner over a pond—and for that matter "swim" through the grass.

Yet another remarkable feat of some serpents is to be seen in the action of a "flying" snake. This is much more in the nature of a glide but is nonetheless extraordinary. The ventral surface can be pulled in to form a deep concavity, accompanied by a slight flattening of the body, the kind of flattening one would find if the body were squashed by a pressure applied above and below. The hollow under surface gives the snake the necessary buoyancy in the air for its parachutelike descent into a lower branch, in a glide of some considerable distance.

In general, snakes that are well able to take care of themselves, such as the poisonous kinds and the large constrictors, are by nature sluggish, and many have squat clumsy bodies. They may even possess peculiar mechanical devices that are used to warn away enemies. There is, for instance the "hood" of certain cobras produced by the flattening of the ribs behind the head when the animal is annoyed. Then there is the warning "rattle" of the American pit viper, or rattlesnake; the rattle is composed of a series of rounded, horny sheaths at the end of the tail which is added to with each successive molt of the skin, and vibrates at high speeds to produce a whirring sound intimidating to its enemies.

Defenseless snakes, burrowers and tree-climbers, on the other hand, are usually slender and built for speed. The record is probably held by the American black racer (*Coluber constrictor*), which is said to attain the speed of a running man.

The fastest of all snake movements, however, may be claimed by the vipers. Otherwise sluggish, and apt to stand their ground when attacked, they strike at lightning speed. When time permits, the rattlesnake or viper will coil the forequarters into the shape of a watch spring with the head in the center. This can then be shot forward for about a third, even a half, the length of the body to produce one of the fastest movements in the reptile world. Only a few animals, such as the mongoose and some birds, are able to avoid it, and even these are not always quick enough to avoid the strike (pl. 1, fig. 2).

This brings us to another part of the snake's unique machinery, the jaws. In birds and mammals, man included, there is only one articulation of the skull bones, the point at which the lower jaw hinges onto the cranium. In a snake's skull the bones of the jaws function as prehensile organs and do not masticate the food. They are attached to one another and to the cranium by elastic ligamentous tissue, which permits much distortion and wide expansion of the mouth. This, together with the expansion of ribs and body wall, allows for the passage of a prey that far exceeds in cross section the size of the head.

The focal point of the jaw action is at the point where, at the back of the skull, the two bones called the quadrate and pterygoid meet the lower jaw (see pl. 2). As the quadrate bone is levered forward by muscle action a thrust is transmitted to both the upper and lower series of jawbones which possess teeth. These slide over the meal, hooking on farther forward as the prey is worked down the gullet. The most noticeable movement is in the lower jaw, the two halves of which can separate widely at the tips, where normally they are held in place by elastic ligament. This allows for enormous expansion of a mouth with normally wide gape that extends to well beyond the eyes.

Each half of the jaw has independent movement and is pushed forward alternately to its neighbor in a chewing action as the owner literally pulls itself over its prey. A copious flow of saliva in the mouth helps to lubricate the passage of the prey along the gullet. It is a slow and laborious process, painful to watch. Once the prey is past the teeth, swallowing is speeded up as the muscles in the body wall take over, and the meal travels as a visible bulge into the stomach. Prey of large size is usually swallowed head first. By the mechanized means described above, which is peculiar to snakes, a

python can swallow a fair-sized deer and a grass snake can engulf a frog that is twice the diameter of its own head (pl. 3).

The egg-eating snake (*Dasypeltis*) is capable of tackling a hen's egg, which is eaten whole. Certain of its vertebrae have enameled tips projecting into the gullet. These crush the egg in its passage toward the stomach. The contents are swallowed and the eggshell regurgitated as a pellet.

A typical snake's tooth in its layer of enamel is recurved and sharply pointed. It is used only for gripping food. Having no socket, an ordinary tooth is easily broken off but soon replaced; reserve teeth grow from the gums lining the inner side of the jaw and move into position after each accident.

In some serpents certain teeth are modified into poison fangs. These are larger than the normal teeth but retain the general pattern of prehensile teeth. They are used, however, for injecting the poison, which is produced in one or other of the modified salivary glands. As with normal teeth they easily break off, and one method of defanging a snake is to allow it to strike at a cloth, which is then jerked away from the closed mouth. But again, a reserve tooth can grow into position and replace a fang that has been lost.

In the venomous snakes of the large family Colubridae, in which the long maxillary bone is fixed, the fangs may lie at the rear end of this; hence the name of their division, the Opisthoglypha. The fangs are usually too far back in the mouth and the poison too weak to make these snakes a real danger to man. The Montpellier snake (*Malpolon monspessulanus*) is of this kind. A specimen that once bit me on the bare arm caused no further discomfort than the pain of the lacerated skin. On the other hand, one of similar length, about 2 feet, bit and killed a grass snake in my reptiliary.

It is among their cousins, the division Proteroglypha, or front-fanged snakes, that we meet the killers. Such are the cobras, kraits, and mambas. Many of them bite with a bull-dog tenacity; they tend to hang on and force their fangs into the flesh with a chewing action. The result is often a severe laceration, and this may be accompanied by much loss of poison as it leaks out of the wound. Both groups, front-fanged or back-fanged, have permanently erect fangs in the fixed maxillary bones.

The whole operation is in many cases a clumsy affair and not always as swift as one imagines. A rearing cobra may look a fearsome sight, yet some people will approach and tease it with impunity.

Far more efficient and less wasteful is the poison mechanism of the family Viperidae, which include the Old World vipers and the New World rattlesnakes. Here the maxillary bones are short and so placed that they can rotate on their front axes where they join the prefrontal

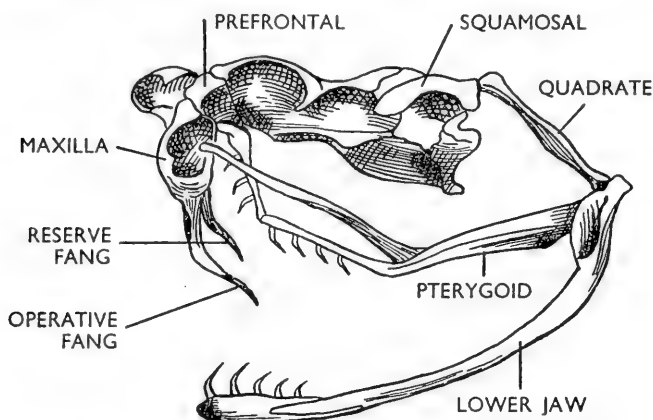

FIGURE 2.—Skull of rattlesnake, showing the mechanism of the jaw bones in operating the poison fangs.

bones of the cranium (see fig. 2). At rest the maxillaries are so placed that the fangs, which are firmly fixed to them, point backward and lie along the roof of the mouth. Protected in this way when not in use, they may grow to considerable length, sometimes not far short of 3 inches, as in the Gabun viper of Africa.

With the mouth open the viper or rattlesnake brings into operation a set of muscles that puts the highly mobile jawbones through a series of lever actions, in such a way that the short maxillary bones are rotated through an angle of about 90° . This brings the fangs into position for the lightning thrust that follows (fig. 4).

The erection of a viper's fangs is an independent action, not necessarily used only during striking. I have watched an adder yawn to ease its facial muscles, slowly raising each fang in turn, where no

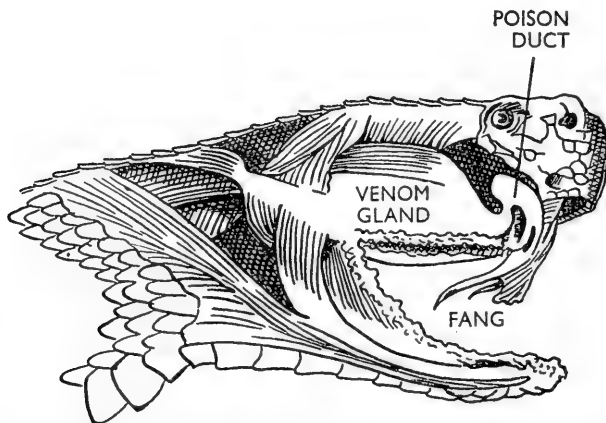
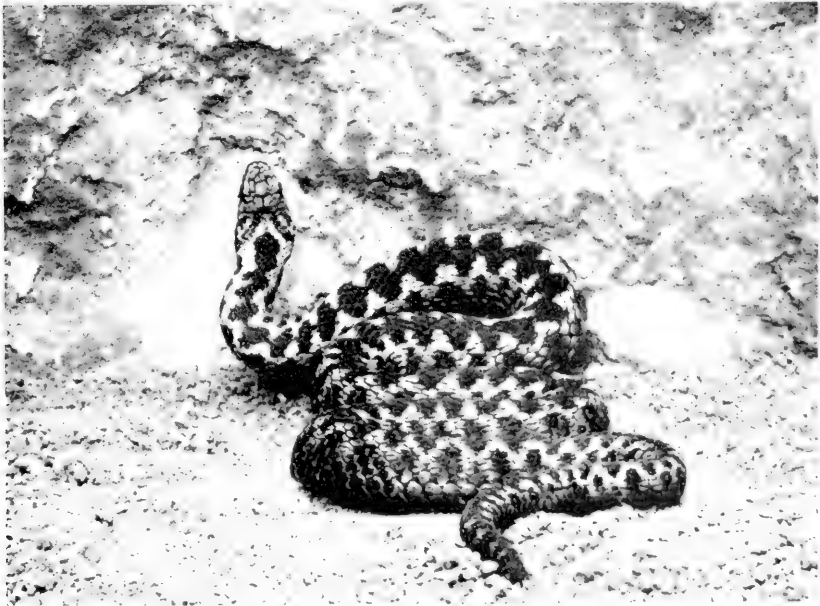

FIGURE 3.—Sketch of partly dissected head of rattlesnake, showing the poison apparatus. (After Boulenger.)



1. The Aesculapian snake, named after Aesculapius, the Greek god of healing. A tree-climbing constrictor, it is at rest along a branch. This specimen is 3 feet long, but the species can attain a length of 6 feet. The keels at the edges of the ventral shields are clearly shown. (Photograph by Lionel Day, F. R. P. S.)



2. Northern viper or adder in a defensive attitude preparatory to striking at an object waved above its head. (Photograph by Lionel Day, F. R. P. S.)

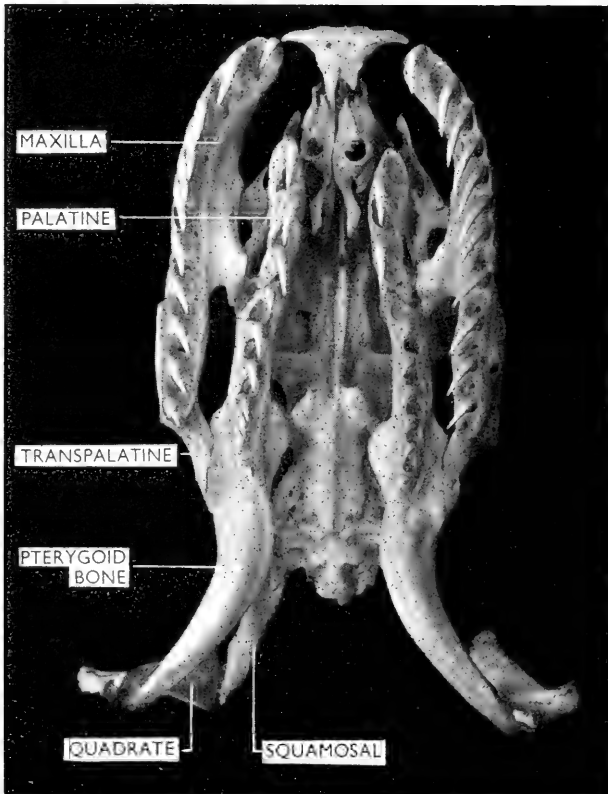
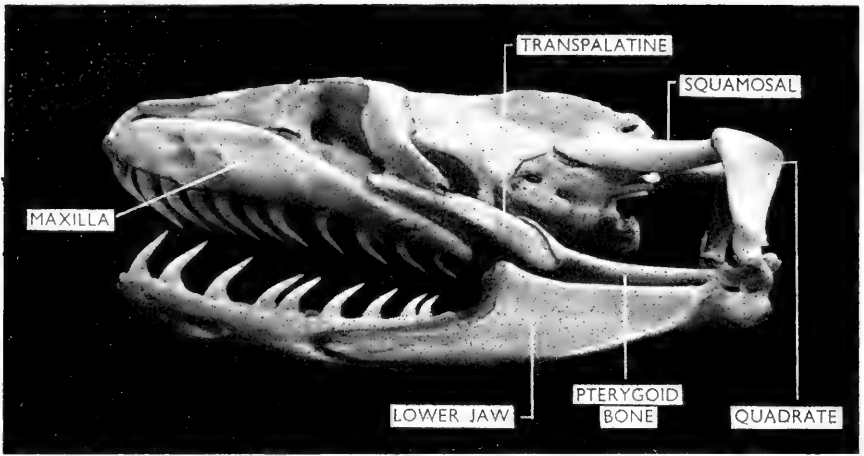

Side (upper) and under view of skull of an anaconda. (Photographs by Lionel Day, F. R. P. S.)

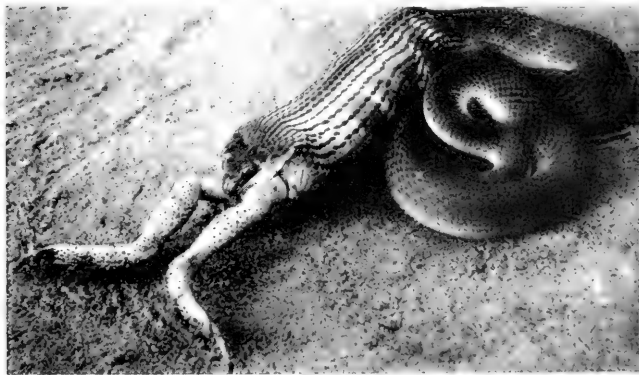
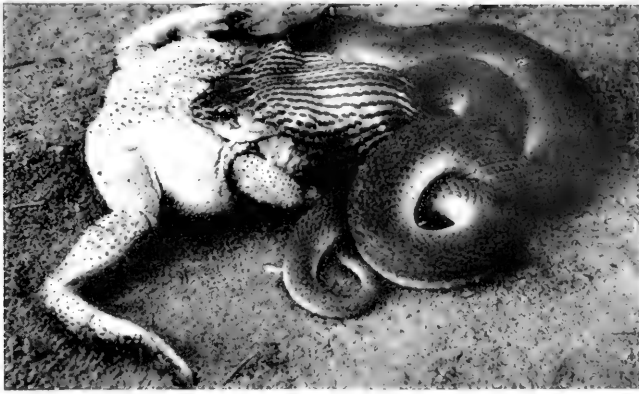

A toad in process of being swallowed by a green grass snake (otherwise known as the green keelback, *Macropisthodon plumbicolor*). The snake alternately advances the right and left sides of its upper jaw, obtains a purchase with its teeth and draws the toad into itself, or, rather, slips itself over the toad. The swallowing occupies about an hour, and digestion has probably begun on the head before the hind legs disappear. (Photographs by O. C. Edwards, A. R. P. S.)



attempt was made to strike. It once took and swallowed a lizard alive, in which act the fangs remained in the resting position.

The groove along the front edge of the fang, as seen in cobras, is completed into an internal canal in the Viperidae. In such a canalized tooth there is an inner opening which appears as a slit at the base of the fang on the posterior side. This communicates with a duct leading to the poison sac, which in the viper is a modified salivary gland lying in the roof of the mouth just below the eye. The outer opening

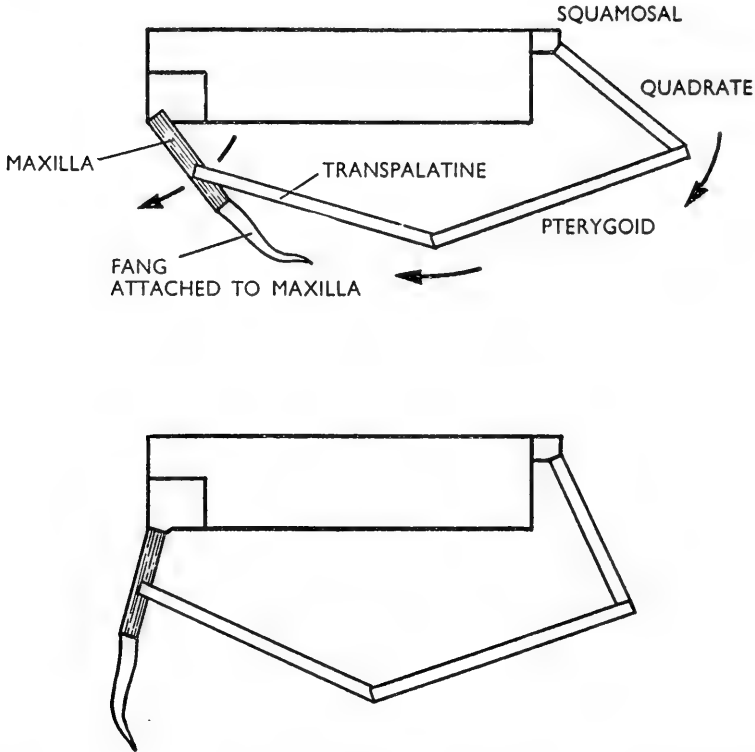

FIGURE 4.—Erection of fang caused by rotation of the maxilla and the chain of bones connected to it.

of the fang is set just behind the tip, whose needle sharpness is thereby not impaired. Venom is stored in the spaces within the sac, upon which pressure is brought to bear by the flexion of the facial muscles. These are in close relation with the venom sac, which is squeezed by the muscles in a kind of wringing action. Venom passes via the duct that lies over the maxillary bone, into the hollow fang which is protected by a thick, mucous sheath, and so into the wound. Not a single drop need be wasted (fig. 3).

In some cases poison is actually thrown from the fang some distance from its target. In some of the "spitting cobras" the poison may be

ejected with considerable accuracy to a distance of up to 8 feet. Whether the aim is deliberate is not fully understood. Boulenger makes the suggestion that the poison is mixed with the snake's normal saliva and squirted through an opening in the membranes lining the mouth which act as lips. If so, then this action would entitle this cobra to its popular name.

A snake's fang is a mechanical masterpiece and nature's parallel to the hypodermic needle. Like the surgical instrument it is only used when necessary, for most snakes strike only as a means of defense or to kill prey. Hair-raising stories of vicious serpents that pursue and leap at their victims, in other words make a deliberate onslaught, are usually figments of the imagination. Deliberate attack as opposed to defense is a rare thing.

The above remarks will make it appear that the life of the lowly serpent is a matter for compensation, for "what it loses on the roundabouts it gains on the swings." It cannot masticate its food, so it swallows it whole; in this it can put a healthy human appetite to shame, yet it can, if forced to, starve for over a year. Limbs as such are missing, so it "walks" on its ribs, swims and grips with its tail, and climbs on its scales. The outer skin does not grow, so from time to time is peeled off neatly, even to the scales over the eyes. Taste is poor, but this is compensated for by a strong sense of smell, in which the harmless tongue assists by catching the smell particles from the air. In hearing it is proverbially deaf, but may receive ample warning of danger from vibrations through solid objects, which reach its sensitive skin more swiftly than sound can travel through air. Prey it can tackle and kill with a choice of two methods, poisoning or constriction, or it can merely swallow it alive.

The customs official, indeed many of us, may well puzzle over this "limbless quadruped" of the herpetologist, but would no doubt agree with all the fame and notoriety that it enjoys. It holds a position unique among animals in being able to attract yet at the same time repel the observer. Symbol of healing or of evil, feared in one place and worshiped in another, it is steeped in legend and folklore.

Enemy of man and persecuted unmercifully, the serpent may yet hold its own in a hostile world for many years to come, owing its survival to the unique machinery of its skeleton with which, as Sir Richard Owen once said, "it can out-climb the monkey, out-swim the fish, out-leap the jerboa, and out-wrestle the athlete."

Hormones and the Metamorphosis of Insects¹

By V. B. WIGGLESWORTH

Department of Zoology, University of Cambridge, England

[With 4 plates]

“Those strange and mystical transmigrations that I have observed in Silk-worms,” wrote Sir Thomas Browne, “turned my Philosophy into Divinity. There is in these works of nature, which seem to puzzle reason, something Divine, and bath more in it than the eye of a common spectator doth discover.” Who, indeed, he says, can fail to wonder “at the operation of two Souls in those little Bodies?”

THE contemplation of the metamorphosis of insects has always evoked feelings of mystery. When regarded more closely through the eyes of the anatomist and the experimental biologist, the superficial mystery is dispelled—to be replaced by deeper mysteries.

Even in that extreme example, metamorphosis in the Lepidoptera, where the caterpillar is transformed into the chrysalis and the butterfly, the rudiments of the organs of the adult or imago—the wings and legs and so forth—are already present in the young larva as clusters of undifferentiated cells, the so-called imaginal disks. Throughout the larval life of these insects (the “endopterygote” insects) the wing germs grow inward and do not become apparent until they are everted at pupation.

The fact remains, however, that the strictly adult structures play no functional part in larval life. Whereas the form of the caterpillar becomes fully differentiated before it hatches from the egg, the adult insect persists in an embryonic state until the growth of the caterpillar is complete and metamorphosis takes place. Indeed, the caterpillar is not a walking embryo, as some authors have contended, but a fully differentiated organism which contains within it, in an embryonic state, the adult butterfly. Metamorphosis consists in the dissolution of

¹ Reprinted by permission from *Endeavour*, vol. 10, No. 37, January 1951.

the organism of the caterpillar and the simultaneous differentiation and realization of the latent organism of the butterfly which supercedes it.

In the development of animals, the stage of visible differentiation of the parts is preceded by a stage of "determination," at which, although all parts outwardly look alike, each is in fact already committed or determined to form some particular component of the organism that is to be produced. Development is then said to have reached the mosaic stage. Determination of the main parts of the insect body occurs very early in the development of the egg. In some insects, the fruit fly *Drosophila* (4)² for example, the mosaic state is already attained in the germ plasma on the surface of the egg at the time of laying; that is, before the single nucleus of the egg has even started to divide. In other insects this may not happen until after the germ band has formed. If, when the mosaic state is reached, a part of the determined area is destroyed by burning or by irradiation with ultraviolet light, the corresponding part of the insect will be lacking when visible differentiation and development are complete.

The interesting fact about these insects is that, even at this early stage of development, the larval organism and the adult organism are distinct. Elimination of restricted areas of the newly laid egg of *Drosophila* results in corresponding deficiencies in the resulting larva—but the adult fly, when it appears, is perfectly normal. At this stage the egg is a mosaic in respect of larval characters, but is still undetermined in respect of the adult characters. But within 7 hours after laying, imaginal determination has taken place; the egg is now a mosaic in respect of adult characters also, and injuries to restricted areas at this time become apparent in the adult fly. Indeed, if they affect organs, such as legs or wings, that are not present in the larva, the results of these injuries are not visible at all until after metamorphosis. The same thing is seen in the clothes moth *Tineola* (5); by irradiation at the appropriate moment it is sometimes possible to obtain a clothes moth with normal limbs developing from a larva in which one or more legs were completely absent.

Thus, metamorphosis consists in the realization of all those adult or imaginal characters that remain latent throughout larval life; the physiological study of metamorphosis consists in the analysis of the factors by which the manifestation of these imaginal characters is controlled.

Many diverse hypotheses have been put forward in the past; but in recent years evidence has accumulated that control is exercised by means of hormones. For the purpose of experiment it proved convenient, in the first instance, to use a hemimetabolic insect; that

² Numbers in parentheses indicate references at end of article.

is, an insect which does not show the extreme degree of transformation from caterpillar to butterfly, but one in which the young stages are not very unlike the adult, and in which metamorphosis consists in the development of wings and genital organs and other structural changes, accomplished without the necessity for an intermediate pupal stage.

The blood-sucking South American bug *Rhodnius*, a creature about 2 centimeters in length when fully grown, has proved a most useful experimental animal (8, 9, 10, 11). All insects grow by undergoing a series of molts, during which the epidermis detaches itself from the old cuticle, lays down a new and larger cuticle, and then casts off the old. Like the small bedbug *Cimex*, *Rhodnius* molts five times; in each of its molting stages it requires only one gigantic meal of blood. It is at the fifth molt that it undergoes metamorphosis and becomes adult (pl. 1, figs. 1-3).

Molting in *Rhodnius* is preceded by growth, reorganization, and the deposition of the cuticle for the next stage. This whole elaborate process is set in motion by a secretion from certain large modified nerve cells (neurosecretory cells) situated in the dorsal surface of the brain. If the bug is decapitated within one day after its great meal of blood, it fails to molt—although such headless bugs have remained alive for more than a year (pl. 1, fig. 4). If, however, the region of the brain containing the secretory cells is transplanted into the abdomen of one of these decapitated insects it will duly molt; and surprisingly enough, even if it is a young insect at an early stage of development, it will undergo metamorphosis and develop into a diminutive adult. We shall come back to this matter later.

Thus the brain appears to secrete a molting hormone. In *Rhodnius* this was believed supposed to act directly upon the growing organs, but in the caterpillars and chrysalids of moths the process is more complicated. The pupal brain of the silkmoth (14) contains two groups of cells, apparently producing two different secretions, both of which must be present if molting is to occur. These secretions do not act directly upon the tissues but upon another secretory organ, the prothoracic gland, which in turn produces the secretion that is necessary for growth and molting. A similar gland activated by the secretion from the brain has recently been found in *Rhodnius* (13). The nature of these substances is not known. There are demonstrable changes in the blood of insects at the time of molting and pupation, e. g., increases in the amounts of cytochrome oxidase and cythochrome C in the pupae of the large silkmoths (14), and the activation of tyrosinase in the blood of pupating larve of blowflies (2). Whether any of these substances is to be identified with the hormone itself, or whether they are merely to be counted among the consequences of its activity, remains to be decided.

The implantation of the cells of the brain, which produce the molting hormone, into the abdomen of the decapitated *Rhodnius*, results, as we have seen, in the occurrence of metamorphosis—even in the young insect whose growth is far from complete. This result suggests that the head produces a second factor which normally prevents metamorphosis in the young stages. That such a factor exists has been proved. It has been termed the juvenile hormone, and it is secreted by a special gland of internal secretion named the corpus allatum. The corpus allatum lies just behind the brain; it shows some remarkable resemblances to the glandular part of the pituitary gland in mammals.

Rhodnius, as we have seen, has five larval stages before it becomes adult. If the corpus allatum is removed from one of the young stages and implanted into the abdomen of a fifth-stage larva, when this molts it turns into a giant or sixth-stage larva instead of undergoing metamorphosis to an adult (pl. 2, fig. 3). Even a seventh-stage larva has been produced in this way, and some of the sixth-stage larvae have transformed successfully into giant adults (pl. 2, fig. 1, and cf. pl. 2, fig. 2).

Conversely, removal of the head of a young *Rhodnius* when molting is just beginning causes the body to undergo a precocious metamorphosis. It has not been possible to remove the corpus allatum in the living *Rhodnius* without undue injury to the head and brain. This has, however, proved possible in other insects, and the results obtained in *Rhodnius* have been amply confirmed. Stick insects, *Dixippus* (6), treated in this way begin to lay eggs while still quite small. Cockroaches (7) become prematurely adult. Silkworms (1, 3) turn into tiny pupae which will give rise to tiny moths (pl. 3, figs. 1-3).

The juvenile hormone is secreted throughout the first four larval stages of *Rhodnius*. During the fifth stage it is no longer secreted; the corpus allatum of the fifth stage implanted into the abdomen of another fifth stage does not prevent metamorphosis. In the adult insect, however, this hormone is once more produced. Here it is necessary for the ripening of the eggs. If the adult female is decapitated after feeding, no eggs are developed; they are developed normally if the corpus allatum is implanted in the abdomen. If the corpus allatum of the mature adult is transferred to the abdomen of the fifth-stage larva, metamorphosis is prevented and a sixth stage is produced.

It is evident that these hormones serve only to control the manifestation of characters that are latent within the cells. It is therefore not surprising to find that they are not limited in their action to the insect species from which they have been derived. The blood of a molting *Rhodnius* will induce molting in a decapitated larva of the related

genus *Triatoma* (pl. 4, fig. 1, and cf. pl. 2, fig. 4), or even in the bedbug *Cimex*. The fifth-stage larva of the bedbug can be prevented from becoming adult if it is transfused with the blood from a young larva of *Rhodnius* containing the juvenile hormone.

Normal development of an insect, with the restraint of metamorphosis until growth is complete, and then, at the appropriate moment, the activation of imaginal differentiation, clearly demands a very nice timing of events. The hormones must be released at the correct time and in the correct amounts. If these conditions are not satisfied, as may happen, for example, in some experiments when a corpus allatum from a young *Rhodnius* is transplanted into a fifth-stage larva, and the amount of juvenile hormone present is too small or is produced too late, metamorphosis is incomplete, and creatures intermediate between larvae and adults are produced (pl. 4, figs. 2, 3). Errors of this kind are not uncommon in nature. Caterpillars with wing lobes and antennae like half-formed pupae may occur; or pupae may have parts of the body resembling larvae. Such abnormalities are most liable to appear in hybrids resulting from the crossing of different species. There can be little doubt that they result from errors in the timing or the concentration of hormone secretions.

It would seem that the cells of the young insect contain two systems, one capable of producing the adult insect, the other producing the larval insect. In the presence of the molting hormone alone, the adult system is activated and metamorphosis occurs. In the presence of both molting hormone and juvenile hormone, the larval system is activated and metamorphosis is suppressed. Or perhaps we have to do with a single system whose activities are modified in alternative directions depending on the presence or absence of the juvenile hormone. In the last analysis, the nature of the constituent elements, and the mode of interaction between the hormones and the potential organism latent in the tissue cells, are biochemical problems. For the moment we can define them only in biological terms.

Once the insect has reached the adult state it does not molt again, save in the most primitive forms. The adult *Rhodnius* can be induced to do so if it is joined to a young molting insect so that the blood flows from one to the other. If at the same time it is provided with a supply of juvenile hormone by the implantation of corpora allata, it develops on its abdomen a type of cuticle which shows unmistakable larval characters. There has been a partial reversal of metamorphosis, a partial recovery of youth.

The future of this subject, which is being actively studied in institutions in many parts of the world, clearly lies with the chemist. It should not prove an insuperable task to discover the nature of the growth-controlling hormones of insects, and to define the conditions

of their action. To discover the nature of the substrate upon which they act, the integrated germ of the organism carried by the living cells (12), is a problem that touches upon the nature of life itself, and may well tax the ingenuity of the biochemist for some time to come.

REFERENCES

1. BOUNHIOL, J. J. *Biol. Bull., Suppl.*, vol. 24, p. 1, 1938.
2. DENNELL, R. *Proc. Roy. Soc., ser. B*, vol. 136, p. 94, 1949.
3. FUKUDA, S. *Journ. Fac. Sci. Tokyo Imp. Univ.*, 4, vol. 6, p. 477, 1944.
4. GEIGY, R. *Rev. Suisse Zool.*, vol. 48, p. 483, 1941.
5. LUESCHER, M. *Rev. Suisse Zool.*, vol. 51, p. 531, 1944.
6. PFLUGFELDER, O. *Zeitschr. Wiss. Zool.*, vol. 149, p. 477, 1937.
7. SCHARRER, B. *Endocrinology*, vol. 38, p. 35, 1946.
8. WIGGLESWORTH, V. B. *Quart. Journ. Micr. Sci.*, vol. 77, p. 191, 1934.
9. WIGGLESWORTH, V. B. *Ibid.*, vol. 79, p. 91, 1936.
10. WIGGLESWORTH, V. B. *Journ. Exp. Biol.*, vol. 17, p. 201, 1940.
11. WIGGLESWORTH, V. B. *Ibid.*, vol. 25, p. 1, 1948.
12. WIGGLESWORTH, V. B. *Symposia Soc. Exp. Biol.*, vol. 2, p. 1, 1948.
13. WIGGLESWORTH, V. B. *Nature*, vol. 168, p. 558, 1951.
14. WILLIAMS, C. M. *Growth Symposium*, vol. 12, p. 61, 1948.

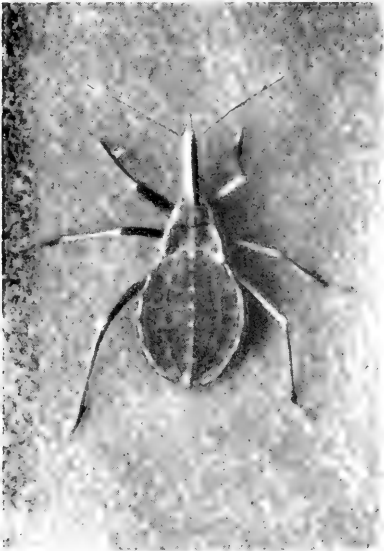

FIGURE 1.—*Rhodnius* larva in the 4th stage, $\times 4$.



FIGURE 2.—*Rhodnius* larva in the 5th stage, $\times 3$.

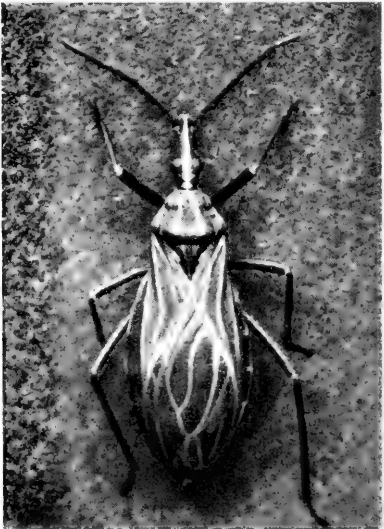

FIGURE 3.—*Rhodnius* adult with fully developed wings after metamorphosis from the 5th-stage larva, $\times 2.5$.



FIGURE 4.—5th-stage larva of *Rhodnius* still alive more than 11 months after decapitation, $\times 2$.

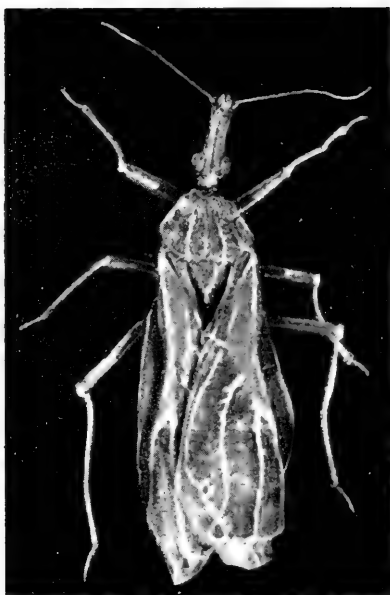

FIGURE 1.—Giant adult of *Rhodnius* resulting from the metamorphosis of a 6th-stage larva, $\times 2$.

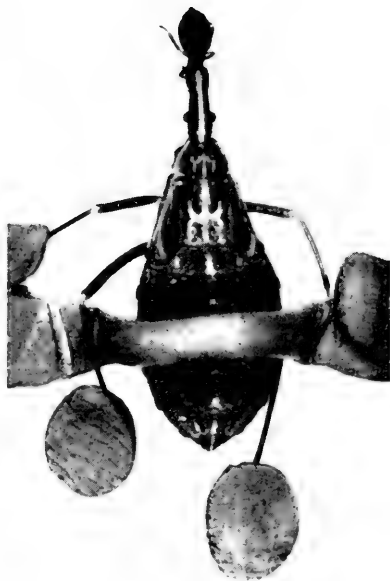

FIGURE 2.—1st-stage *Rhodnius* joined by neck to 5th-stage larva, causing dwarf adult, $\times 3$.



FIGURE 3.—Giant or 6th-stage larva of *Rhodnius* resulting from implantation of the corpus allatum of a young larva (secreting juvenile hormone). The site of implantation appears as a scar on the abdomen. $\times 2.5$.

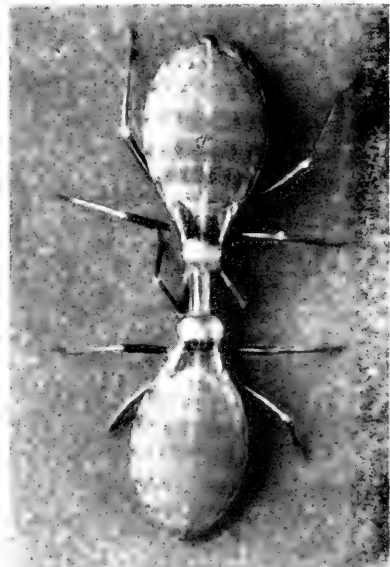

FIGURE 4.—*Rhodnius* larva in 4th stage decapitated 1 week after feeding and connected by means of a capillary tube with another 4th-stage larva decapitated 24 hours after feeding. The molting hormone from the first insect causes the second to molt. $\times 3$.



FIGURE 1.—Pupae of the silkworm. *a*, From larvae in which the corpora allata were extirpated in the 3d stage; *b*, from larvae similarly treated in the 4th stage; *c*, from normal larvae pupating after the 5th stage. $\times 1.5$. (After Fukuda.)

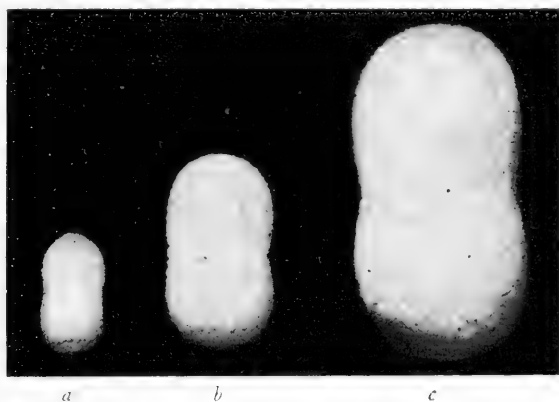

FIGURE 2.—Cocoons of silk containing the three pupae shown in figure 1 (above). $\times 1.5$. (After Fukuda.)



FIGURE 3.—Silkmoths derived from the three pupae shown in figure 1 (above). Natural size. (After Fukuda.)

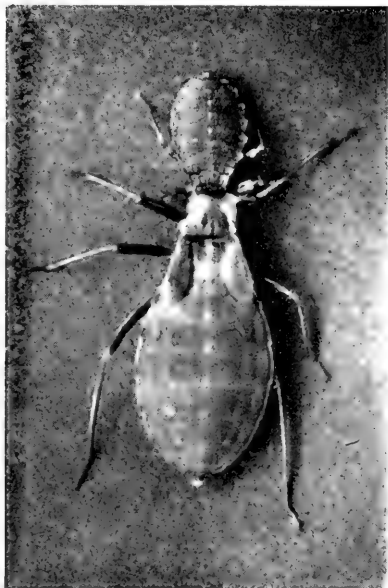

FIGURE 1.—Young larva of *Triatoma* (above) decapitated 24 hours after feeding and caused to molt by joining it to a 5th-stage larva of *Rhodnius* decapitated 10 days after feeding. $\times 3$.

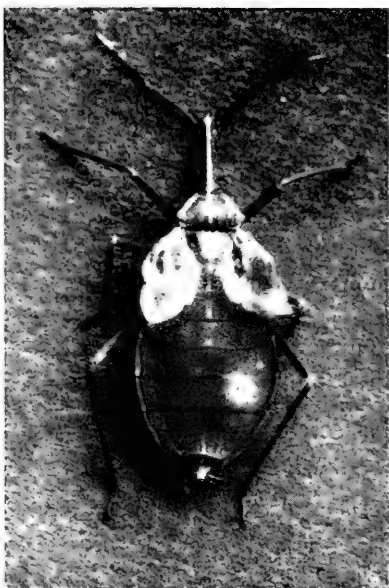

FIGURE 2.—*Rhodnius* with characters intermediate between larva and adult produced by implanting corpus allatum of young larva into abdomen of 5th-stage larva (cf. pl. 2, fig. 3). $\times 2.5$.

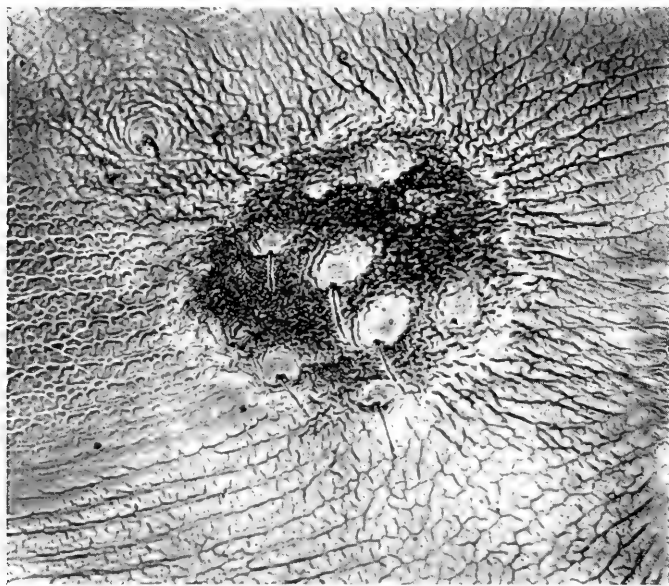

FIGURE 3.—Cuticle of abdomen of an adult *Rhodnius* which had been treated during the 5th stage like the insects shown in plate 2, figure 3, and figure 2 above. It has turned into a normal adult, but there is a tiny patch of cuticle of larval type, less than 1 mm. in diameter, overlying the site of implantation of the corpus allatum. $\times 70$.

Utilizing Our Soil Resources For Greater Production¹

By ROBERT M. SALTER²

[With 1 plate]

IN SOME quarters there is concern as to whether the nation's soil resources can support the United States in a position of world leadership. Our soils are capable. We can be confident of that. The problem is to manage our soils so as (1) to yield enough crops to meet current increasing demands, (2) while doing it, to increase soil productivity enough to support even higher production on a sustained basis, and (3) to provide farm families with a high standard of living.

Some popular opinion holds these to be conflicting objectives. I do not. There is an abundance of scientific evidence, backed by practical application on farms, to conclude that we can make our soils produce enough to meet current needs and also to provide for the long pull. Modern measures for improved soils management contribute toward both goals simultaneously. The job is to get such measures into general use on farms—a job that will take much “doing.”

As a backdrop for discussing the various factors involved in this concept of soil utilization, we need to consider the size of the production job, trends in crop production, and the nature of our soil resources.

HOW MUCH PRODUCTION?

No one can predict accurately the production requirements for world leadership. We do know that the demand for agricultural products has been increasing at a rapid rate since the summer of 1950 when the free world took a firm stand in resisting Red aggression. We also know that food is a potent instrument for winning and retaining friendship with other free nations. In many instances, food can do what bombs and bullets cannot accomplish.

¹ Reprinted by permission from the *Annals of the American Academy of Political and Social Science*, November 1951.

² At the time this article was written, Dr. Salter was Chief of the Bureau of Plant Industry, Soils, and Agricultural Engineering, U. S. Department of Agriculture. He is now Chief of the Soil Conservation Service in the same department.

Military mobilization itself stimulates the rate of crop consumption. Also, special military needs must be met. Castor oil, for instance, has become essential to the operation of much modern military equipment. Already thousands of acres are being diverted to the production of castor beans, a crop new to American agriculture.

This nation's huge industrial machine, the greatest in the world, is leaning more and more on agriculture as a source for raw materials. Soybeans, for example, are the raw material for more than four hundred manufactured products, ranging from plastics to printing inks. As industrial production continues to expand, so will the requirements for agricultural production to support it.

The population of the United States is increasing at the most rapid rate in this century. We now number 150 million. Population trends indicate that our numbers may swell to 200 million within a quarter-century, making 50 million more mouths to feed and backs to clothe.

Nutritional standards for a large segment of our population are still too low for good health. Recent surveys show that to meet the minimum dietary standards established by the National Research Council, 40 percent of the families need more calcium, 20 percent need more vitamin C and some of the B vitamins, and 10 percent need more protein and iron. To meet these needs would require increased production of fruits, vegetables, milk, eggs, and meat.

Obviously, the future requirements from agriculture will greatly exceed current production; and demand will grow progressively over the years.

PRODUCTION TREND IS UP

Already the requirements from agriculture are high. Demand has increased at a rapid rate during recent years, and production has kept pace. Farmers are now producing at a record level. Output is running about 40 percent higher than in 1935-39. Production per hour of farm worker has increased about 50 percent during the last decade. Per-acre crop yields have increased 30 percent above prewar.

There is good reason to believe that the present rising trend in crop production will continue for an indefinite period, because the forces behind it still have unexpended power. Furthermore, agricultural science is busy developing more new technology.

But let there be no misunderstanding. So far, the biggest contributing factors to the upward trend have been mechanization, improved crop varieties, crop-pest control, and better cultural measures. Soil improvement, too, has helped on some farms, but hardly enough to offset soil deterioration on other farms. On many farms soil fertility is still on the downgrade. On our most productive lands in the Midwest and the Great Plains, for example, exploitive systems

of farming have been followed on most farms since the very beginning of American agriculture. The inherent productivity of the soil has declined continuously, and is still going down. Gains from programs for soil conservation and from increased use of chemical fertilizer have not offset losses from soil deterioration.

Reversing the downward trend in soil productivity would give another sharp rise in crop production. Herein lies one of our greatest opportunities for expanding the capacity of American agriculture to produce.

SOIL IS A RENEWABLE RESOURCE

No longer do we consider soil as simple, dead, and sterile matter. Our modern concept is founded on the understanding that soil undergoes continuous change—some natural and some man-made.

Soil is made up largely of small mineral particles. Yet chemical changes are continually in process. Soil contains roots of living plants, small animals, and billions of microorganisms (bacteria and fungi). It is made up of a combination of solid inorganic matter, dead organic matter, living organic matter, water, soluble salts, and air. Also, climate, vegetation, and topography make for different patterns of soils. Thousands of different soil types have been identified. Wide variations occur within a country, and usually the soil pattern varies on individual farms. Also, there is great variation in the kinds of crops that different types of soil will grow—and in their response to management.

Some soils are highly productive in their natural state, while other virgin soils are relatively unproductive. The degree of inherent productivity of any soil depends on the natural processes that build it. In the Midwest, for example, the natural building process stocked most soils with an abundant supply of organic matter and mineral elements, leaving them highly productive. In the Southeast, on the other hand, soils were developed under forests in a humid climate with little freezing and much leaching, leaving the majority of them acid in reaction, low in organic matter and mineral fertility, and relatively unproductive.

From our modern understanding of the natural processes that build and change soils, two points of great significance are evolving:

1. Some soils naturally infertile can be made highly productive. Many fields once considered "worn out" are yielding crops abundantly, and some where soil fertility was naturally too low for economic production are being cropped profitably. In the eastern part of the United States, the soil is much better today on many farms than it ever was under natural conditions.

2. Naturally fertile soils that have lost productivity through use and abuse often can be rejuvenated. While the practical level of

productivity for economic sustained production on such soils is somewhat lower than in the virgin state, high levels of productivity can be maintained. Already, productivity is on the "come-back" on many farms where yields were falling off because of declining soil fertility.

The job we face is one of bringing the greater portion of the land now in use—both naturally fertile and infertile soils—to a high level of economic production on a sustained basis. We need to offset soil deterioration, and on many soils go even further—build them up to higher levels of productivity.

HOW SOILS DETERIORATE

Soils deteriorate through numerous changes, many of which are not readily visible. Deterioration can be classified into two basic types, both important but varying as to conditions. The first is actual removal of soil by erosion—by wind or water. The second includes changes within the soil itself under cropping—changes hard to detect on sight. Both processes often go on simultaneously and affect each other.

Erosion.—The physical removal of soil by erosion or wind blowing may in extreme cases render the soil totally unsuited to cultivation, as where severe gulying occurs. The more usual damage, however, is that resulting from loss of surface soil. In removing the surface soil, erosion usually exposes soil layers that are more compact and less favorable for root growth than the original topsoil. Erosion—even sheet erosion—causes serious fertility losses far greater than the weight of soil removed might indicate. In most agricultural soils the plant nutrients—nitrogen and phosphorus particularly—are concentrated in the surface layers. Losses due to erosion are especially serious for those two nutrients.

Damage to cultivated land by erosion is a serious problem in much of the country. Not all soils, however, are subject to erosion, which naturally is related to the kind of soil and the slope of the land. For those that are, it is often necessary to check cropping losses and increase fertility before erosion losses can be checked. In any given instance the relative importance of the factors contributing to erosion depends upon the type of soil, especially the character of the several layers or horizons and slopes, the crops grown and their culture, and the climate.

Cropping.—Soil deterioration through cropping is at least as serious as losses resulting from erosion. The majority of people, however, are more fully aware of the damage from erosion. They do not realize that on an acre of fertile soil growing a cultivated crop such as corn, the productivity decline from cropping may equal the loss of 20 tons of topsoil through erosion.

Any agricultural soil, under any cropping system, is undergoing both improving and depleting processes at the same time. Even under natural conditions both downgrade and upgrade processes go on, but they tend to reach a unique equilibrium for each level of natural environment.

When placed under cultivation, a new environment is created. Usually the downgrade changes are accelerated, and the soil deteriorates. Mineral elements are removed by both crops and drainage, often faster than new supplies are made available. The annual plant nutrient removal from United States soils by crops is about three million tons of potash, nearly two million tons of phosphate, and over three million tons of nitrogen. Except for phosphate, not nearly that much is returned. We need to put back much more to build up responsive soils to a high level of productivity.

Mineral nutrient removals represent only a part of the soil deterioration resulting from cropping. Loss of organic matter is even more serious. Organic matter is highly important to inherent soil productivity. The superiority of most productive soils is largely the result of organic matter. Stable soil humus is a reservoir for about 98 percent of all soil nitrogen, about 50 percent of the phosphorus in surface soil, and smaller amounts of other nutrients. It makes for good soil structure essential to proper movement of air and water in the soil.

The importance of organic matter—and the seriousness of its loss—is better understood when we realize that in the fertile soils of the Corn Belt each 1 percent of soil organic matter adds about 10 bushels to the acre-yield of corn. Thus, in soil with 3 percent organic matter, inherent productivity will account for a yield of about 30 bushels of corn per acre; while in soil with 6 percent organic matter, inherent productivity will account for a yield of about 60 bushels per acre.

Organic matter is destroyed through the activity of bacteria and other microorganisms in the soil. The process is essentially one of oxidation, and requires air. Each time the soil is stirred, air is introduced and the rate of organic decomposition is speeded up. Nitrogen and other nutrients are then released to the crop, or made subject to leaching. This explains why destruction goes on so fast under inter-tilled crops such as corn.

Organic matter also functions as a binding agent to promote good aggregation and porosity. As organic matter is depleted, soils become more compact; porosity is less, which means that the soils become less permeable to air and water; and the soil becomes more and more susceptible to erosion.

BUILDING SOIL PRODUCTIVITY

If we are to reverse the declining trend on the majority of our soils, we need to determine for each farm the optimum combinations of

practices to achieve both conservation and high production—and get them into use. It is important to understand that most of the steps required to increase crop yields tend to lessen the effect of soil deterioration from cropping and reduce the erosion hazard.

Seldom can our goal be achieved by a single practice. Instead, in nearly all areas, a sound program of land use will include a combination of such practices as adequate liming to control soil reaction, adequate acreage of legumes and grasses in the cropping system, return of adequate quantities of plant residues, including the proper conservation and use of animal manures, use of adequate amounts of mineral fertilizer, improved treatment and management of pastures, and special erosion-control and water-conservation measures. Cropping systems and management practices must be adjusted to the capabilities and needs of local soil types.

Lime.—On most soils east of the Great Plains lime is a basic factor in building soil productivity. By far the most effective method for overcoming soil deterioration, brought about by erosion or due to chemical and biological forces, consists in expanding the acreage devoted to the soil-building sod legumes. The successful establishment of these legume crops requires a fair abundance of lime in the soil. Only by liming acid soils can they be made to grow the more efficient soil-improving legumes.

Despite large increases in the use of liming materials, especially since the introduction of the Agricultural Conservation Program, the annual return of lime to soils in the humid area is still far short of that needed to offset removals by crops and drainage. Farmers are now applying lime at an annual rate ranging from 25 to 30 million tons, which is eight to ten times as much as they were applying 15 years ago. Yet, it still falls far short of needs. Most acid soils need a substantial application of lime every four or five years. Profitable use can be made of two to three times the amount now being applied.

Limestone resources of the United States are ample to supply liming materials at such high levels for hundreds of years.

Legumes and grasses.—The values from including grasses and legumes, especially deep-rooted legumes, in crop rotations have long been recognized. They are our best antidote for the destructive effects of row-crop cultivation. Yet too few farmers use enough of them.

Long-time field experiments have revealed that each time a full-season cultivated crop is grown without return of residues, the soil loses through biological oxidation about 2 percent of its organic matter and nitrogen. (Erosion frequently causes additional loss.) Under small grain, the annual loss is about half as great—or 1 percent.

These experiments also show that growing legume sod crops in the rotation will offset these losses. Gains from a crop of red clover, even

with the hay removed, about offset the losses from a crop of corn. Alfalfa and sweet clover are even more effective in contributing organic matter and nitrogen to the soil. They will almost offset losses from a crop of both corn and small grain.

Deep-rooted crops are the major factor in maintaining structural stability and permeability, aeration, and drainage in the deeper soil layers. In addition to the physical effects, deep-rooted crops feed not only in the topsoil, but also in the subsoil. An active root system is about the best defense against nutrient-leaching losses. Decomposition of root and crop residues of such plants releases into the surface soil nutrients that come from deeper layers.

On sloping soil subject to erosion, legume and grass mixtures are better than either legumes or grasses alone. Legumes furnish needed nitrogen while grass holds the soil from eroding between the crowns of legume plants.

Grown alone or in combination with grasses, deep-rooted legumes leave large residues of organic matter and nitrogen within the soil even when the tops are removed as hay or pasture. They improve soil tilth and drainage and effectively protect the soil from the erosive impact of rain. Plowing down a good two-year stand of alfalfa, for example, will leave in the soil more than 3,000 pounds of dry weight of roots and 80 pounds of nitrogen per acre.

Critics of this system maintain that it takes too long. They say that by following this route for building soil productivity we shall need to sacrifice some immediate production, and that farmer income will be impaired. Recent research findings suggest otherwise, provided the cropping system for a farm is planned for an extended period, such as 5 to 10 years. While the cost of shifting often requires a temporary economic sacrifice, the new system soon becomes more profitable than the old.

For example, in a four-year rotation of corn, wheat, alfalfa, alfalfa, in Ohio, with the use of only moderate levels of mineral fertilizer over a 13-year period, corn produced an average yield of 68 bushels per acre, wheat 41.8 bushels, and alfalfa averaged three tons of hay each year. At current farm prices this would permit realizing a gross return of more than \$100 per acre during each year of the rotation. With liberal applications of fertilizer, yields were substantially higher. A farmer following such a system certainly is not sacrificing farm income. And he is maintaining soil productivity while producing at a high level.

In straight corn-small-grain rotations, substantial gains can be realized from the use of legumes as a catch crop with small grain, to be plowed under the following spring before planting to corn. Increases in corn yields as much as 35 bushels per acre are possible under

a well-managed plan. Many Corn Belt farmers already follow this practice, but not all of them. Even many who do, fail to realize the full potentials from the system. Recent experimental evidence strongly indicates that on many soil types, use of adequate amounts of mineral nutrients will give a substantial boost to the system.

In the Corn Belt there are at least 7 or 8 million acres of small grain planted each year without an accompanying legume—where a legume could be used. Probably on another 7 or 8 million acres, legume stands are poor or fail because of inadequate fertilization or for other reasons that could be corrected. In total there are between 10 and 15 million acres of small grain where potentialities from a legume catch crop are not being realized. Increases in corn yields resulting from this practice would vary, but a conservative estimate would be from 12 to 15 bushels per acre.

If all such small-grain acreage in the Corn Belt is properly fertilized and seeded with a legume crop for 1952 and is plowed under as green manure in the spring of 1953, it can easily increase corn production by 200 million bushels in 1953. Such a system certainly is not sacrificing immediate production. And the legume crop in such a rotation, accompanied with the use of adequate fertilization, would about offset the losses in soil productivity from both the corn and small-grain crops.

Similar gains could be realized from other uses of legumes and grasses. Recent experiments have shown, for example, that on much land, improved meadows and pastures can be made to produce as much total digestible nutrients per acre as high-yielding corn crops, and at less cost and with less labor.

Animal manures and crop residues.—The return of crop residues, including animal manures, is a highly important factor in building soil productivity. Much crop residue is now being returned to the soil, but we are not realizing the full potential from animal manures—nowhere near it.

One billion tons of manure, the annual product of livestock on American farms, if completely recovered, carefully preserved, and efficiently used, should produce six billion dollars' worth of increase in crop production. The potential value of this agricultural resource is three times that of the nation's wheat crop. The organic-matter content is twice the soil organic matter destroyed in the growing of the nation's grain and cotton crops.

Not more than one-fourth to one-third of the potential crop-producing and soil-conserving value of animal-manure resources of the country is now realized on harvested crops. That it is economically feasible to prevent much of this loss has been conclusively demonstrated both experimentally and by farmers in Europe and in this country.

Animal manure is valuable in several ways. It increases the size of crops, tends to lessen the effect of destructive crops, and increases the

effect of accumulative crops. Manure also contributes directly to the humus content of the soil, since it supplies both organic matter and nitrogen. For a given amount of plant nutrient supplied, manure adds about twice as much to the humus content of the soil as do chemical fertilizers. About half of the conservation effect of manure arises from increased residues from the larger crops grown, whereas the other half represents the direct contribution from the organic matter supplied in the manure itself. Eight tons of manure per acre has half as much effect on soil productivity as a crop of clover.

I can think of no single improvement in farming practice that would yield as big dividends in soil conservation and improved soil productivity as the general adoption of practical and effective measures for the preservation and use of animal manures.

Chemical fertilizers.—The use of chemical fertilizers in farming is already making a substantial contribution to our productive capacity. During the last 10 years fertilizer use has increased two and a half times. Consumption in 1949 totaled 18,542,000 tons compared with 7,912,000 tons in 1939. Fertilizer now accounts for about 25 percent of the total United States production.

Recent experimental findings suggest hundreds of new opportunities for increasing crop yields through greater use of fertilizers. Usually the opportunities are greatest when fertilizer is used in adequate quantities in combination with several other improved practices. The greatest returns from the use of green-manure legumes, for instance, come when higher rates of phosphate and potash fertilizers are applied to the green-manure crop.

Evidence from east of the Great Plains and irrigated areas clearly indicates that the use of balanced fertilizers on grasslands, in conjunction with other improved practices, could easily double forage production on 250 million acres of grasslands. Other experiments show that on intensively cultivated crops such as cotton, tobacco, and potatoes, where heavy applications of phosphate and potash have been used over a long period of years, these elements have accumulated in some soils to a level where continued heavy usage is uneconomical. On much other land, however, use or heavier use of these elements would increase yields.

More extensive use of nitrogen fertilizer on crops holds the greatest of all potentialities among the various fertilizer elements, provided that nitrogen is not used as a substitute for legumes, manure, and other sources of organic matter, or to overcultivate sloping erosive soils. We are just beginning to appreciate the values that can be gained from heavy applications of nitrogen fertilizers. Agronomists in general are raising their sights as to the quantities that can be used efficiently.

In the Southeast, for example, we have found that with heavy applications of nitrogen in combination with the use of adapted corn hybrids, closer plant spacing, and improved cultural practices, corn can be made to produce yields comparable to those produced in the Corn Belt. Farmers in Virginia and North Carolina have doubled their average corn yields during the past five years under this system. And many farmers have not yet put it into use.

In my opinion, these States have so far realized only about half of the gains possible from this system. If the system were applied to all the present corn acreage in southeastern States, corn production in that area could be increased at least 250 million bushels annually. This would require the use of about 325,000 tons more of fertilizer nitrogen. Increased use of nitrogen fertilizer would also build up soil productivity. At best, crops recover no more than 60 percent of applied nitrogen. Some not recovered is lost through leaching, but much of it becomes fixed in soil humus. This is evident from the fact that farmers harvest bigger crops of oats following corn from fields where nitrogen fertilizer has been applied.

Our current production of fertilizer nitrogen falls far short of supplying the element in quantities needed for more widespread use. That situation, however, can be corrected. Since synthetic nitrogen can be manufactured by fixation of nitrogen from the atmosphere, supplies are limited only by the capacity of chemical plants to produce it.

With phosphate and potash, on the other hand, we must depend on natural deposits to fill our needs. These resources, however, are adequate. If the present world consumption of phosphates were 8 times greater, the known world reserves would last more than 2,000 years. If the present consumption of potash were 18 times greater, the known world reserves would last 500 years. And the world has not been thoroughly explored for these minerals. Here in this country, for example, we have huge deposits of potash—more difficult to process than those now being used—that are not now being worked simply because they cannot be exploited in competition with current sources.

Conserving water and controlling erosion.—Recently we have acquired much new knowledge about soil-crop-moisture relationships. Although no successful way has yet been found to produce rain, methods are being devised to make better use of what nature hands out. Experiments with various crops have consistently demonstrated that soil moisture and soil fertility must go hand in hand for the most effective production. Higher yields, which result from improved soil and crop practices, place a heavier drain on soil moisture. Practices that conserve water as well as soil have the greatest bearing on production.

There are real opportunities in making more efficient use of the rain water that falls on the land. In the humid area—east of the Mississippi—we are losing about one-third of the annual rainfall through runoff, which underscores the importance of soil and crop practices that conserve moisture and make more efficient use of it. Numerous improved tillage and terracing practices that conserve moisture are already in use. Other practices that will serve this end are now being developed. Extensive use of such measures can do much to increase production and reduce losses from erosion.

Farming on the contour, for example, can reduce water runoff and erosion losses and increase crop yields on millions of acres of sloping land where contouring is not now being practiced. The Soil Conservation Service in cooperation with State experiment stations has gathered much evidence on this point. Reports from Iowa show that contour farming cuts soil losses in half and raises corn yields as much as 7.4 bushels per acre. Reports from Illinois show that corn yields 7 bushels per acre more on contoured fields than on fields cultivated up and down the slope. Work in Illinois, Iowa, and Missouri, showed between 11 and 12 percent increase in soybean yields from contouring. Evidence from 10 States shows that average wheat yields were increased 20 percent by contouring.

Of course, the greatest value from conservation practices results when they are used in combination, as demonstrated by studies in Indiana. Here, adequate fertilization, liming, return of crop residues, and contouring in a four-year rotation of corn, soybeans, wheat, and grass-legume meadow resulted in 34 bushels more corn, 7 bushels more soybeans, 7 bushels more wheat, and an extra ton of hay, per acre. Without conservation farming, the soil lost 12.6 percent of the rainfall during the growing season. Runoff under the conservation treatment amounts to only 5.1 percent. Thus, the improved measures saved 7.5 percent more rainfall during the growing season.

There is good opportunity, too, for materially increasing the potentialities of some soils to hold water and grow crops by deepening the zone of soil in which roots can grow. Most productive soils are characterized by deep friable surface layers. In this country we have lost much topsoil through erosion. Furthermore, the soils over a large area have naturally shallow surface layers.

We are exploring the possibilities of improving the structure and nutritional qualities of the subsoil as a means of expanding the rooting zone for plants. Remarkable increases in crop production have been produced in this way on some soil types. It is not unreasonable to expect that we could substantially deepen the root zone in many soils and make available to crops increased quantities of both plant nutrients and water through the use of deep-rooted legumes in cropping

systems, deep tillage, and the incorporation of lime and fertilizer in the deep soil layers.

We need to make much more extensive use of winter cover crops on intertilled land. Leaving the ground bare over the winter promotes loss by erosion. For the South in general, adequate cover crops are available. Still, more than 80 percent of the cultivated land goes through the winter unprotected. For years we have taken for granted the bare fields with brown cotton stalks and broom sedge all the way from Virginia to east Texas. Now, with practices developed during the last 20 years, fields could be green with growing crops the year around. Here the agricultural plant can work on a 12-month basis, contributing to both soil conservation and increased production.

SOIL PRODUCTIVITY CONDITIONS BY REGIONS

Again I want to emphasize that no single practice will accomplish the combined goal of increased production and soil conservation. The goal can be met only by balanced application of known soil and crop management techniques in accordance with specific soil characteristics and needs. The complexity of the problem is apparent when we examine the types of soil and how they deteriorate in various parts of the United States.

Far West.—The prevention of saline and alkali soil conditions is one important factor in the conservation of soil productivity in western irrigation lands. Accumulation of salts in the soil is one of the most difficult problems. In many instances, salt-laden water is the only source available for irrigation.

Also, the structure of heavy soils is deteriorating under certain irrigation and cropping systems, making it difficult to get irrigation water into the soil. There is increasing evidence, too, that continued soil productivity will require the maintenance of considerably higher levels of nitrogen. The use of phosphorus fertilizers is also increasing under irrigation. But for many years to come, the maintenance of proper salt balance and the conservation of good soil physical properties must be the most important criteria of good land use in this area.

Great Plains.—In the Great Plains, moisture rather than plant nutrients has been the primary factor limiting the productive capacity of the soils. Subsurface tillage, fallowing, and other cultural practices designed to leave crop residues on the soil surface are used to conserve both soil and water. Protection against soil blowing is a particularly important step in sound land use here.

Despite improvements in mulching and subsurface tillage, land use in this area has been primarily exploitive in nature. Although cropping has not yet generally depleted soil fertility reserves to

limiting values, it is only a matter of time until it will. Continued cropping to wheat combined with fallowing and row-crop cultivation has already resulted in the loss of one-third or more of the organic matter and nitrogen originally present in these rich soils.

So far we have not been able to develop a system that will maintain soil organic matter and nitrogen in this area. We still do not have a legume crop adapted to the 200 million acres of dry land in the semihumid regions. Productivity cannot be maintained under our present system. From the standpoint of long-time food and feed supplies in this country, the problem of maintaining the soils in the dry-land area is one of the most serious we face.

Northeast and north central.—In the northeastern and north central States soil deterioration is widely varied. In the Northeast, where soils were naturally infertile, soil productivity is now on the upgrade on hundreds of thousands of farms. In the Midwest, however, prevailing farm practices have led to a progressive decline in the organic matter and nitrogen content of the soil. In places this loss has amounted to as much as one-third to one-half of the original content. And the decline is still going on at rates estimated as high as 1 percent per year in the middle Corn Belt.

This has the effect of impairing drainage, water infiltration, soil aeration, and ability of soil to yield up nutrients to crops. Crops seem to suffer more in dry weather. Many farmers have found it necessary to install additional tile lines on land that once drained satisfactorily. On sloping soils, erosion is taking a heavier toll, as compaction slows intake of water and increases runoff.

Here we know how to manage soils so as to maintain organic matter and nitrogen. The problem is to get these management practices into widespread use.

Southeast.—In the southeastern States, conservation and rehabilitation of soil resources probably offer as great a challenge—and opportunity—as anywhere in the country. Soils here were already highly leached before they were put to agricultural production. High rainfall and temperatures continued to favor rapid organic-matter decomposition and loss of soil minerals by leaching and erosion.

It has been estimated that in the Piedmont region, two-thirds of the land that has been cultivated has lost part or all of its topsoil, and in many cases some of the subsoil. Erosion and gullying have been so severe that thousands of acres have been abandoned for crop production.

Most of these soils, however, are very responsive to fertilization and other good management practices. They can serve as excellent media for plant growth. Climatic conditions that have made these soils what they are also offer unusual opportunities for increasing levels of productivity.

RESOURCES ARE ADEQUATE

The soil, water, and fertilizer resources of the United States are ample to meet all foreseeable requirements of world leadership. In fact, they are more than ample—provided we use them intelligently.

Farmers are now using 405 million acres of land for the production of crops. Also, 70 million acres of pasture land are cropped occasionally in long-time rotations. An additional 642 million acres of open grassland and 350 million acres of woodland are used for livestock grazing. Over most of this area we can realize both increased production and soil conservation through the application of available knowledge.

In addition, there are big opportunities for expanding production by bringing idle or unproductive land into use. Along the east coast and Gulf States there is a huge area of swampland that could be drained and put into production. With modern engineering devices, the water table could be lowered and controlled on much of this area. Some government and private projects are already under way. There is every reason to believe that these soils would be highly productive.

On hundreds of thousands of farms throughout the country there are corners or patches of idle wet land, often several acres in size, that could be drained and made productive. All they need may be a short drainage ditch, a tile line, some weed or brush killer, fertilizer or manure, or a few hours with a bulldozer. The production capacity of many farms can be increased by putting such idle land to work.

There are thousands of farms in the humid States where water is available and where the necessary investment in irrigation might pay. The medium and large rivers and streams in eastern United States that flow continuously the year around number well over one hundred. There are millions of acres of well-drained land adjacent to these streams. Modern engineering would permit tapping these streams to apply water from them for supplemental irrigation without damming them up. The opportunities for using river water to supplement rainfall on the rich valley lands of eastern United States are enormous.

In the arid west, large areas could be freed or kept free from salts, irrigated from available water supplies, and brought into production. In the Columbia River Basin, for instance, irrigation farming with water from Grand Coulee Dam will get under way in 1952. During the next few years a million new acres are expected to be brought into production in this project alone. The Bureau of Reclamation estimates that there are 16,839,000 acres of irrigable new land in the western States.

Also, in the Southeast, little if anything is being produced on millions of acres of poor grazing land, unproductive woodland, and low-

yielding cropland. While effective use of this land is a problem of long standing, recent discoveries suggest tremendous opportunities for using much of it in the production of milk, beef, and other livestock products. Through the introduction and creation of new and better legumes and grasses and the development of improved fertilizer and soil-management practices for efficient forage production, much of this land could be used for efficient livestock production. In Florida, for example, thousands of acres of flatland originally growing pine and palmetto have been cleared, limed, fertilized, and seeded, and are now producing beef cattle profitably. Here alone, several million acres could be brought into production.

Obviously, there are sizable opportunities for expanding production through the development of idle or unproductive land. There can be no question. Our soil resources are adequate. The job is to use them intelligently for sustained production with conservation. This involves two important areas of action: (1) continued and increased effort in crop and soil research to provide additional improved technology and to give greater precision to our recommendations; (2) continued and increased effort to coordinate and unify educational and service programs concerned with production and conservation to reduce lost motion and to speed adoption of balanced programs for efficient, abundant, and sustained production on individual farms.



1. Applying fertilizer to a prepared field. Productive grasses and legumes demand plenty of plant food. The fertilizer should be applied after the old sod is torn up so that it can be worked into the seed bed. From *New Pastures for Old*, by Malcolm H. McViekar, 1950.



2. Louisiana white Dutch clover grown on Florida flatwoods soil of a Leon type. Two tons of ground limestone, 500 pounds of 0-10-10 fertilizer per acre were used. Photograph taken at Florida Agricultural Experiment Station, Gainesville, Fla.

The Carbon-14 Method of Age Determination¹

By FRANK H. H. ROBERTS, Jr.

Associate Director, Bureau of American Ethnology

DURING the period immediately following World War II an important byproduct of research on cosmic rays was the development of a method whereby the age of certain objects can be determined by laboratory tests. The latter are based on the carbon-14 content of the objects, and their results undoubtedly will be extremely useful in archeology, several branches of geology, oceanography, meteorology, and related fields where chronology is essential to the solving of many problems. Previous types of "calendars," such as tree-ring dating, pollen analysis, and glacial varves, were helpful in restricted areas but were not universally applicable. This latest method of age determination does not suffer from that handicap. For the first time it now appears that prehistoric dates that are virtually precise can be obtained from samples from any region in the world. The method has some limitations and an occasional test goes awry, but as the techniques are improved the age determinations unquestionably will become more accurate.

Carbon 14, a radioactive heavy form of carbon with an atomic weight of 14 in contrast to the normal, stable carbon atomic weight of 12, is continually being formed in the upper atmosphere of the earth. It results from the bombardment of nitrogen-14 atoms by cosmic rays, streams of neutrons flowing toward the earth from outer space. The new carbon-14 atoms thus formed, commonly called radiocarbon, begin an immediate spontaneous disintegration but enough remain to combine with oxygen to form carbon dioxide which eventually mixes, in the air that surrounds the earth, with the much larger proportion of carbon dioxide containing ordinary carbon. All living things which absorb carbon dioxide from the atmosphere take in some of the carbon 14 as well as the carbon 12. The proportions between the two

¹ Revised by permission, with the addition of new material, from the article "Carbon 14 Dates and Archeology," in *Transactions of the American Geophysical Union*, vol. 33, No. 2, pp. 170-174, 1952.

have been shown experimentally to be constant in all living matter. The radiocarbon constantly disintegrates, but it is continually replaced through the life processes which are in exchange with the atmosphere. When an animal or a plant dies there is no further replacement of carbon 14. That remaining, however, continues to disintegrate at a rate that is the same everywhere. For that reason the amount of radiocarbon still present is in direct proportion to the time that has elapsed since death occurred, and by measuring the constantly diminishing rate of disintegration it is possible to calculate the age of an organic sample.

It is not possible in an article of this nature to explain and discuss in detail the scientific processes involved in radiocarbon dating, but the main features in the development of the method should be mentioned. In 1934, not long after the discovery of artificial radioactivity, Dr. A. V. Grosse suggested that the existence of radioactive elements produced by cosmic rays would be established (Grosse, 1934). Some 10 years later Dr. W. F. Libby, of the Institute of Nuclear Studies of the University of Chicago, predicted that living matter would be found to contain natural or "cosmic" carbon 14 (Libby, 1946). The next year he and Dr. Grosse tested methane gas derived from sewage and found the expected amount of carbon 14 (Grosse and Libby, 1947). Dr. Libby and his associates then proceeded to demonstrate experimentally that carbon 14 occurs in the same concentration in all living matter. In doing this they tested living material from many parts of the world—from different latitudes, altitudes, and different geographical situations (Libby, Anderson, and Arnold, 1949). The materials consisted of wood from Chicago, Mount Wilson, New Mexico, Bolivia, Ceylon, Tierra del Fuego, Panama, Palestine, Sweden, New South Wales, and North Africa; sea shells from Florida; and seal oil from the Antarctic.

In the course of the various studies it had been determined that the half-life of carbon 14 is about $5,568 \pm 30$ years, which means that one ounce of the material is reduced by decay to half an ounce during the 5,568-year period and that half of the remainder decays during the next 5,568 years leaving a quarter of an ounce, etc. (Engelkemeir and Libby, 1950; Jones, 1948; Miller et al., 1950). Because of this, Dr. Libby was convinced that the amount of carbon 14 present in any particular object would be an indication of the age of that object and proceeded to develop a method for measuring it. This involved the perfection of a specially constructed and extremely sensitive screen wall counter, a form of Geiger counter, which would measure the rate of atomic disintegration of natural carbon 14 without the use of a thermal diffusion column. The problem also included the development of a complicated chemical separation unit to reduce the carbon 14 to its

purest form. In running tests the samples to be dated are burned, treated in the separation unit, and then measured in the radiation counter. The measurements are given on the basis of the carbon-14 disintegrations per minute per gram of carbon. For present-day living samples the specific activity is 15.3, for samples 5,568 years old it is 7.65, and for samples 11,136 years old it is 3.83. The disintegration rate is such, however, that the proportion of radiocarbon remaining after 20,000 years is so small that accurate counting is very difficult and the effective range may be considered somewhat less than that age. There is a method for enriching samples which may make possible the obtaining of dates as far back as 30,000 years, but that at present appears to be the maximum. The errors in the dates now being obtained are considered to range from 5 to 10 percent.

When the laboratory equipment was ready Dr. Libby and his associate, Dr. James R. Arnold, ran a series of tests on samples whose ages had been fairly accurately established by other means but which were unknown to them. Material, ranging in age from 1,300 to 4,600 years, from Egyptian tombs, from archeological sites in our own Southwest, and from redwood trees was provided by different museums, and it was found that the carbon-14 dates obtained for them agreed with the known ages within the calculated error of the method. In making the preliminary tests it was found that the most useful materials are plant fibers and wood, charcoal, antler, burned bone, shell, dung, and peat.

Arrangements were then made with a committee representing the American Anthropological Association and the Geological Society of America to obtain samples for testing and a grant was made by the Wenner-Gren Foundation for Anthropological Research (the Viking Fund) to assist in the support of the program. Archeologists and geologists began sending in the necessary materials and the series of tests got under way in the spring of 1949. Announcements of the dates obtained were made informally from time to time, but it was not until October 1950 that a lengthy series was made public. That list was printed in February 1951 in *Science*, vol. 113, No. 2927, pp. 111-120. An additional list appeared in the same journal, vol. 114, No. 2960, pp. 291-296 in September of that year. Most of the information contained in those articles was also published, with discussions of its significance, in the *Memoirs of the Society for American Archeology*, *American Antiquity*, vol. 17, No. 1, pt. 2, 1951.

The method developed by Dr. Libby and the results obtained indicated so many potential applications for radiocarbon dating that new laboratories for making carbon-14 measurements have been established at Yale University, the University of Michigan, Columbia University, and the United States Geological Survey. Others are

contemplated and perhaps even now are under way. The first series of measurements by the Lamont Geological Observatory at Columbia University was announced in *Science*, vol. 114, No. 2970, in November 1951.

From the standpoint of archeology, most of the dates reported thus far have been fairly satisfactory, but in a number of instances there appears to be a contradiction between the archeological evidence and the age obtained from the carbon-14 tests. One factor to be considered in this connection is that the older material appears to be more consistent than that of relatively recent times, and even though the error in the method may make a difference of several hundred years in the actual chronology, the results are very helpful and will aid materially in making the syntheses of cultural relationships and developments that are essential to an understanding of past history. For many people greatest interest probably attaches to the archeological remains that fall within what may be called geologic time. The results in this Early Man category are in some respects as surprising as a few of those in other fields, but on the whole they are reasonably satisfactory.

In the United States the age of the well-known Folsom complex caused considerable comment when the figure pertaining to the type site was released. As a matter of fact, that discussion has continued actively to the present. Unfortunately many of the arguments it produced were not necessary because the announced date was not that of the culture-bearing horizon of the Folsom complex but that of a fire pit in the fill of a secondary channel that had cut through the original deposit of bison bones and artifacts. Such was known at the time when the first announcement was made, but unfortunately the explanation accompanying the date was not clear. If, as the geologists who have examined this site maintained, the cultural stratum was of very late Pleistocene or early Recent age (Brown, 1929; Bryan, 1937), the date of $4,283 \pm 250$ ² years obviously was wrong or else the geologists were greatly mistaken in their identification of the deposits. Subsequently material from a Folsom horizon at Lubbock, Tex., was tested and a carbon-14 date of $9,883 \pm 350$ years was obtained. The latter more closely approximates the magnitude estimated for Folsom on geologic evidence. The deposits at Lubbock, in the opinion of Dr. E. H. Sellards of the Texas Memorial Museum and his associates, correlate closely with those at the site in the Black Water Draw near Clovis, N. Mex., which Dr. Ernst Antevs has identified as belonging to a pluvial period which he believes corresponds to the end of the Pleistocene and has estimated the age as being from 10,000 to 13,000

²The errors indicated for all dates are standard deviations based solely on the error of counting random events. Other errors probably are involved and the true error will be somewhat greater.

years (Antevs, 1949). It is possible, of course, that some of the material at Clovis is older than the Lubbock site, because the Folsom culture undoubtedly lasted over a reasonably long period. Also, certain faunal differences suggest a greater age for some of the Clovis manifestations. The difference between the carbon-14 date and Dr. Antevs' estimate is not too great, however, and it seems a fair assumption that the general idea that the Folsom complex is about 10,000 years old is not far out of line.

The late Dr. Kirk Bryan and Dr. Louis L. Ray, after completing their studies at the Lindenmeier site in northern Colorado, another Folsom location, estimated its age as from 10,000 to 25,000 years, with the statement that they believed it nearer the latter than the former (Bryan and Ray, 1940). Thus far it has not been possible to obtain charcoal or other material suitable for carbon-14 tests from the cultural level at that location and it is not known if the estimate is too great or if perhaps the occupation there was earlier than at the similar sites farther south. Geologically the age appears to be somewhat older. Bryan and Ray concluded that the occupation at the Lindenmeier site was in Wisconsin III times or late Mankato. Of interest in this connection is the fact that some early sites on Lime Creek in western Nebraska have been correlated with the Mankato (Schultz and Frankfurter, 1949) and carbon-14 dates of $9,524 \pm 450$, and $10,493 \pm 1,500$ have been announced for them. The cultural material is not Folsom, but projectile points of the types found there have been collected elsewhere at sites where the characteristically fluted Folsom type occurs in a lower and older stratum. Dates for the Mankato, based on materials from other localities, have consistently run between 11,000 and 12,000, or an average age of 11,400 years before the present.

Other archeological remains of about the same age on the basis of carbon-14 dates are Gypsum Cave in Nevada, with an average of $10,455 \pm 340$ for the 6-foot 4-inch level and an average of $8,527 \pm 250$ for the 2-foot 6-inch level; the Fort Rock Cave in Oregon, $9,053 \pm 350$; and Palli Aike Cave at the tip of South America, with $8,639 \pm 450$. The deposits in Gypsum Cave where the oldest artifacts were found have been correlated with a dry period immediately following the Provo Pluvial and the age estimate was placed from 7,000 to 9,000 years ago (Antevs, 1948). In that particular case it appears that the estimated and the carbon-14 dates are in fairly close agreement. Archeologically such an age would not be unreasonable, although there is still some question as to the contemporaneity of the associated wooden objects and the sloth dung from which the date was obtained. In connection with the Gypsum Cave dates it might be noted that the accumulation of material between the 6-foot 4-inch level and the

2-foot 6-inch level, a depth of a little less than 4 feet, represents approximately 2,300 years.

The Fort Rock Cave in Oregon is particularly interesting as well as somewhat puzzling. At that location a large number of fiber sandals and some basketry were recovered from beneath a layer of pumice which has been identified with the Newberry eruption that presumably followed that of the Mount Mazama eruption which produced Crater Lake (Cressman, Williams, and Kreiger, 1940). The sandals were tested and were found to have an average age of $9,053 \pm 350$, the oldest actual artifacts thus far dated. If the assumption that the Newberry eruption followed that of Mount Mazama is correct, it appears that there was a considerable interval between the time the sandals were left on the floor of the cave and when they were covered by the pumice. The Mount Mazama eruption has been dated by a carbon-14 test of charcoal from a tree killed by the eruption and the age $6,453 \pm 250$ was obtained. Williams (1942) had previously estimated it to be between 4,000 and 7,000, Allison (1946) had placed it at 12,000 to 14,000, and Hansen (1946), on the basis of pollen stratigraphy, suggested 12,500 or somewhat later. The maximum, under the circumstances, for the Newberry would appear to be somewhat less than the $6,453 \pm 250$ of the Mount Mazama and it may well have been considerably later. The date for the sandals, of course, is not that for the overlying pumice but it is rather difficult to explain how they remained on the surface of a cave floor for several millennia without alteration and then were charred by the heat from the Newberry pumice (Cressman et al., 1940, p. 68; Cressman, 1942, p. 52; 1943, p. 239). When first announced, the date for the sandals was thought to indicate a reverse order for the volcanic eruptions. That is not now considered to be the case however. A subsequent statement to the effect that the dated sandals came from some distance below the pumice (Cressman, 1951, p. 308) bolsters that opinion. Archeologically, as well as geologically, the Mount Mazama pumice is an important feature in Oregon in that it forms a line of demarcation for dating deposits occurring beneath and above it. Once the age of the Newberry pumice, or pumices (since the presence of four cones in the crater and others along the eastern base of the volcano suggest there may have been several eruptions), has been established it also will be equally helpful. Hansen estimates the Newberry eruption at between 7,500 and 9,500 and Allison places it at from 11,000 to 12,000, but in view of the Mount Mazama results it would seem that the carbon-14 date will prove to be considerably less. If the date for the sandals is correct, it is extremely significant because it shows that the inhabitants of North America at that time had not only developed a fine technique in the manufacture of protection for the feet but that

they also were making a highly artistic form of basketry decorated with a false embroidery. It is possible, of course, that when perishable materials belonging in the complex of some of the other cultures of this period are found an equally high kind of industry will be revealed.

What may well prove to be one of the most important archeological sites thus far found in North America from the standpoint of the sequence and dating of cultures, as well as geologic data, is Danger Cave near Wendover, Utah. The cultural debris there reaches a depth of about 14 feet. The midden rests on an old beach of glacial Lake Stansbury. The beach consists of two feet of sand deposited on cemented gravels. Charcoal, wood, and mountain-sheep dung were found in the sand layer. Radiocarbon tests of the dung gave an age of $11,453 \pm 600$, while the wood ran $11,151 \pm 570$. Thus far no results have been announced for the cultural material and it must be considered as being an unknown number of years later than the beach, although the initial occupation may not have been long delayed after the receding water opened the cave to habitation. The date of the latter, however, will be extremely useful in geologic studies of the area. This is particularly so in view of the fact that bat guano mixed with the gravels of an old beach of Lake Lahontan in the Leonard rock shelter near Lovelock, Nev., gave a carbon-14 date of $11,199 \pm 570$.

The close correlation between the beach levels in the two caves is important in showing that climatic conditions then were such that there was a pronounced shrinkage in the two lakes. A similar phenomenon is noted for ancient Lake Texcoco in Mexico where radiocarbon tests indicate that the late Pleistocene shrinkage apparently started approximately $11,003 \pm 500$ years before the present.

In South America two caves in Tierra del Fuego near the eastern end of the Strait of Magellan yielded material that has given dates of $10,832 \pm 400$ and $8,639 \pm 450$ years. The older of the two dates was obtained from sloth dung and there apparently were no cultural associations. The date is important, however, because it has a bearing on the last ice advance in the area and also the survival of the giant sloth. It is interesting to note that the date agrees very closely with the $10,455 \pm 340$ obtained from similar material from Gypsum Cave in Nevada. The date for the other cave, called Palli Aike, which contained archeological deposits, was obtained from charred sloth, horse, and guanaco bones. It is not only important in indicating that man was present there at a reasonably early time but is also significant because the material came from hearths on the surface of a layer of volcanic ash, and as the occupation of the cave apparently followed closely after the eruption which deposited the ash the date probably is approximately that for the last major eruption in the adjacent

group of small volcanoes along the Chilean-Argentine boundary. Furthermore, it helps to place a land rise of $42\frac{1}{2}$ feet east of the first narrows of the Strait and recession of a large glacial lake which exposed the rock shelters that were soon occupied by people. In addition, the date substantiates an estimated age for volcanic ash distributions in Tierra del Fuego and Patagonia based on pollen analysis (Bird, 1951).

As is to be expected, dates for archeological sites attributable to prehistoric man in the Old World are somewhat older than those in the Western Hemisphere. Charcoal from the famous Lascaux Cave, considered one of the world's oldest and most remarkable art galleries, on the Vézère River near Montignac (Dordogne), France, tested $15,516 \pm 900$. The charcoal came from occupational deposits in the northwestern portion of the cave and is thought to represent a Magdalenian level. Thus far, however, it has not been possible to correlate the radiocarbon date with any of the seven or eight art styles in the magnificent murals on the wall of the cave (Movius, 1951). Another upper Paleolithic site of Magdalenian times at La Garenne, St. Marcel (Indre), France, has an interesting series of dates. One sample consisting of an ashy material mixed with sand, charcoal, and burned bones tested $15,847 \pm 1,200$, burned bone collected in and around a hearth dated $11,109 \pm 480$, while burned bone from the same horizon but outside the hearth gave $12,986 \pm 560$. Of comparable antiquity is a site at Mufo, Angola, Portuguese West Africa, where a stone blade associated with carbonized wood was found in a late upper Pleistocene deposit. Tests made on the wood yielded $11,189 \pm 490$ years. Not quite so old, but still of considerable age, are two dwellings in Denmark belonging to the late boreal, pollen zone VI. Hazelnuts from one of them gave an average of $9,929 \pm 350$ years, while birchwood from the other tested $9,425 \pm 540$. Materials from a cave located five miles west of Behshahr at the southeast corner of the Caspian Sea, in Iran, show dates ranging from $8,545 \pm 500$ to $10,560 \pm 1,200$. The deposits in the cave contain Bronze Age, late Neolithic, Neolithic, late Mesolithic, and Mesolithic. The earlier date presumably is that of the Mesolithic, while the later was from a zone containing upper Mesolithic artifacts.

In the United States there is a somewhat younger group of cultures which are represented at various places in the West and Southwest. They may represent developments out of the older remains previously mentioned, but on the other hand they may indicate subsequent migrations to the area. That is a problem which still needs to be solved by the archeologists. Nevertheless there is some significance in the carbon-14 indications.

Associated with Folsom materials at sites where artifacts were picked up from the surface were types of points which were given the

name Yuma. The latter became somewhat of a catch-all designation for points that could not otherwise be identified and has more or less been replaced by specific site names. The first points of this type were believed to be contemporaneous with Folsom, but subsequent work showed that their contemporaneity at best was a very late one and that they more likely actually represented a subsequent horizon. In this category are specimens such as those found by Dr. G. L. Jepsen, of Princeton University, at Sage Creek in Wyoming. The average date for that material, derived from partially burned bison bones, is $6,876 \pm 250$. Other specimens falling in the same category were found in a site at the Angostura Reservoir in South Dakota. Charcoal found at the occupation level tested $7,715 \pm 740$, while similar material taken from an oval-shaped unprepared hearth dated $7,073 \pm 300$. Geologic studies at both of those locations have not yet been completed so it is not known what the conclusions are with respect to their geologic age.

Caves in the Humboldt Valley in Nevada have furnished specimens that have been dated $7,038 \pm 350$ years, $5,737 \pm 250$ years, and $2,482 \pm 260$ years. These dates were obtained from bat guano and archeological artifacts. In the cave containing the oldest objects, the guano layer below the artifact-bearing stratum rested on Pleistocene gravels and, as previously mentioned, material from the contact tested $11,199 \pm 570$. Briefly, the evidence there shows that man was present in that district by 5000 B. C. and that the region was occupied during the dry Altithermal Period of 4000 B. C. After approximately 1,500 years' occupation the region apparently was abandoned until about 500 B. C. from which time there is an unbroken archeological record to the present day. The oldest date thus far for California is $4,052 \pm 160$, but since *Olivella biplicata* shell beads were found at the 7,000-year-old level in one of the caves in Nevada, it seems evident that there must have been people along the Pacific coast at that time (Heizer, 1951).

In southeastern Arizona a series of cultural horizons designated the Cochise yielded carbon-14 dates of $7,756 \pm 370$ and $6,210 \pm 450$ for the oldest stage. The next or second stage yielded dates from $4,508 \pm 680$ to $4,006 \pm 270$, while the third stage gave $2,463 \pm 310$. From these dates it is obvious that the sequence of the three stages which was established on geologic and typological evidence was sound. The dates themselves, however, are somewhat lower than previous estimates based on climatological studies, particularly in the case of the first period which is about 2,000 years younger (Sayles and Antevs, 1941). The carbon-14 figures indicate that, contrary to the opinion of many, the Cochise peoples had not moved into that area prior to the appearance of hunting peoples of the Folsom type in the region

immediately to the east. In that connection it may be pointed out that the fire pit with a date of $4,283 \pm 250$ years at Folsom was roughly contemporaneous with the second stage of the Cochise in Arizona and the Early Horizon culture in California. In the same category is a fire pit in the secondary channel fill at the Lindenmeier site with its $5,020 \pm 300$. Furthermore, the date falls in the same general horizon as some of the Archaic remains in the eastern part of the United States, as that of the site of the much-debated Tepexpan Man in Mexico with its $4,118 \pm 300$, and of the Huaca Prieta Mound No. 3 in Peru with $4,044 \pm 300$.

Bat Cave in Catron County, N. Mex., with dates from $5,931 \pm 310$ to $1,752 \pm 250$, falls into this same general period. In some ways the archeological material from it may not be as important as that found at other sites, but there is an excellent sequence of artifact types characteristic of different geographical areas and several projectile points similar to the second stage of the Cochise were found there. The main significance of Bat Cave is in the light that it throws on the botanical problem of the development of maize or Indian corn. From the six feet of accumulated refuse in the cave a series of shelled cobs, loose kernels, and various fragments of husks, leaf sheaths, and tassels was recovered. The specimens from the bottom level to the top show a distinct evolutionary sequence. The corn from the bottom level is a primitive variety which was both a popcorn and a form of pod corn, while that at the top is an essentially modern form. The evolutionary period required for such changes thus appears to be far shorter than previously supposed. The sequence also indicates that there were important factors bearing on the evolutionary process; namely, that there was a marked reduction in the pressure of natural selection, that there were mutations from the more to the less extreme forms of pod corn, that contamination by teosinte modified the corn, and that crossing produced a high degree of hybridity (Mangelsdorf, 1950).

In the eastern United States the Archaic at Frontenac Island, N. Y., gave a date of $4,930 \pm 260$. A site at Lamoka Lake, N. Y., produced charcoal which tested $5,383 \pm 250$, while shell mounds in Kentucky yielded dates from $4,900 \pm 250$ to $5,149 \pm 300$. Geological determinations have not played a particularly important part in the studies of those sites, although such investigations as were made there would indicate that there was some expectation of reasonable antiquity. Probably somewhat younger but still falling within that period is the fishweir at Boston where peat from the Boylston Street site gave a carbon-14 date of $5,717 \pm 500$ for the lower peat underlying the weir. A second date was obtained from a fragment of coniferous wood which was taken from marine silt overlying the lower peat and the weir. It was $3,851 \pm 390$. The weir itself presumably should be younger than the oldest date but older than the later one. On the basis of climatolog-

ical evidence it had been estimated that the weir was in use just prior to 2000 B. C. (Antevs, 1943). Hence it appears that the people who built and used the weir may have been contemporaneous with those who lived at the Frontenac Lake, Lamoka, and Kentucky sites. These dates from the eastern United States are somewhat older than had been anticipated and show that migration to that area was relatively early.

There are some generally comparable dates for the Old World and as the testing continues there undoubtedly will be more. Wheat and barley grain from a pit in the Neolithic Fayum A Period in Egypt gave the age $6,095 \pm 250$, which is about 1,000 years later than originally estimated by archeologists for the remains found there. Charcoal from house floors at El-Omari, near Cairo, Egypt, tested $5,256 \pm 230$, the period represented being tentatively identified as Middle Predynastic. A slab of wood from a roof beam of the tomb of Vizier Hemaka of the First Dynasty, at Sakkara, Egypt, ran an average of $4,883 \pm 200$ which is in the previously accepted range of 4,700 to 5,100 years for that dynasty. A cypress beam from the tomb of Sneferu at Meydum, Egypt, tested an average $4,802 \pm 210$ which is within the range of error for the age determined from archeological evidence and the Egyptian calendar. There are other dates of lesser magnitude for Egypt as well and they agree rather closely with the radiocarbon results (Braidwood et al., 1951). Fairly well-preserved land-snail shells from basal levels at Jarmo, Iraq, a Kurdish hill-country site lying on the flanks of the "Fertile Crescent" north and east of classic Mesopotamia, tested $6,707 \pm 320$ years. That site has been considered, on typological grounds, to be the earliest village remains thus far excavated in western Asia. The carbon-14 age is about 2,000 years younger than had been estimated by archeological reasoning. A piece of charred wood from a Neolithic lakeside settlement at Ehenside Tarn, England, showed a carbon-14 age of $4,964 \pm 300$. The conventional dating for such remains has been 4,000 years. Charcoal from a feature considered to be late Neolithic and to belong to the first phase of the monument at Stonehenge, England, tested $3,798 \pm 275$. On the other side of the world charcoal from part of the structural remains of a house found in the bottom levels of the Ubayama shell mound, about 10 miles west of Tokyo, Japan, had an average age of $4,564 \pm 220$. That is supposed to be the oldest house site in Japan. Charcoal from a higher level at the same mound showed $4,513 \pm 300$.

Curiously enough, Alaska, which should give the oldest archeological dates in the Western Hemisphere if the migration theory for the populating of the New World from northeast Asia is correct, thus far has shown nothing older than $5,993 \pm 280$ for a habitation site. That date was obtained from charcoal and willows from the bottom level of a cave containing evidence of at least two different cultures. Arti-

facts from the same level consist of diagonally chipped blades, stone and bone arrow points, microlithic side-blades, and decorated and slotted bone. The side-blades and the bone suggest a Mesolithic tradition. The other cultural materials, separated from the former by more than a meter of debris, are of a type that elsewhere in Alaska has been found to be approximately 1,000 years old. A base log from a Paleo-Eskimo house at Cape Denbigh tested $2,016 \pm 250$, while charred wood from the middle levels of the same site showed $1,460 \pm 200$. Spruce wood from a site at Gambell, St. Lawrence Island, yielded $2,258 \pm 230$. The dates for the Alaskan remains, however, do differ from archeological conceptions as to their age and as yet there is no satisfactory explanation for the discrepancy.

There is one interesting series of dates covering a long sequence of cultures in the Chicama Valley, Peru (Bird, 1951). The range is from $4,424 \pm 104$ to $2,211 \pm 200$ and so far as the archeological evidence is concerned there is nothing which would throw doubt on the validity of the radiocarbon determinations. The same cannot be said, however, for dates for certain remains in the United States. The latter are much younger than many of those in Peru and involve the so-called Hopewell and Adena cultures. Archeologists had generally agreed that the Adena and its typologically related cultures preceded the Hopewell. When three different kinds of organic material comprising six samples from Hopewell sites were tested they were found to be $1,951 \pm 200$, $2,044 \pm 250$, $2,285 \pm 210$, and $2,336 \pm 250$. The Adena materials, on the other hand, range from $1,168 \pm 150$ to $1,509 \pm 250$, and the related cultures from 633 ± 150 to $1,233 \pm 250$, and $1,158 \pm 250$ to $1,276 \pm 150$. Generally speaking radiocarbon shows that Hopewell is not only older than Adena but antedates it by 1,000 years (Griffin, 1951). Since this is so contrary to the accepted archeological chronology, the the results have been sharply questioned. The discrepancy probably cannot be attributed to the method itself because all the dates are within the range of carbon-14 determinations that were checked by samples of known age. Consequently it would seem that either the archeological concepts need to be changed or the specimens used in the tests were contaminated.

There are various other dates of anthropological significance now available but space will permit the consideration of only two more. They are of particular interest for other than strictly archeological reasons. A test was made of a sample from a carved wooden lintel from a building at the ruined Mayan city of Tikal in northern Guatemala. The building is believed to have been the sacerdotal palace or residence for the priests serving a nearby temple. The lintel in question formerly spanned an interior doorway and was composed of five sapote beams. The complete lintel was decorated with an inscription giving the Maya date 9.15.10.0.0 3 Ahau 3 Mol. The correlation of

the Mayan and Gregorian calendars has long been a source of dispute and there have been two principal schools of thought in the matter with a difference of about 260 years in the results obtained. According to the Goodman-Martínez Hernández-Thompson correlation the date was June 30, A. D. 741, while in the Spinden correlation it was August 30, A. D. 481. The radiocarbon age based on the average of two runs was $1,470 \pm 120$. The expected result on the basis of the first correlation method should have been 1,210–1,240. For the second it should have been 1,470–1,500. As far as this particular sample is concerned, it appears that the Spinden correlation is the correct one (Kulp et al., 1951). The other object of special interest to many people that was subjected to the carbon-14 method was the Book of Isaiah, the Dead Sea scrolls found in a cave near Ain Fashkha in Palestine. History and tradition placed the age of the book in the first or second century before Christ. The linen wrappings that enclosed the scrolls were used for the radiocarbon sample and gave $1,917 \pm 200$ as their age. The scrolls probably are somewhat older and the date of their wrappings may well be that of the time when they were cached in the cave.

The results from carbon 14 as far as geology is concerned are spotty because of the difficulty in obtaining suitable material for testing and because in many instances their stratigraphic position is questionable. However, certain things are apparent from the work done thus far. The dates do fall roughly into the same order as the stratigraphic sequence of the deposits from which the specimens for testing were collected and their relative chronology is acceptable. On the other hand, they are for the most part more recent than many geologists believed would be the case. For example, the Mankato substage of the Wisconsin glaciation is shown to have gotten under way about 11,400 years ago with the maximum being reached at approximately 11,000. This is somewhat less than half the age previously assumed for the Mankato and if correct will require considerable revision of ideas on the part of some students of geochronology. It is interesting to note that radiocarbon dating has confirmed the conclusion, based on pollen studies, that a series of deposits in Germany, England, and Ireland were correlated and belonged to the same interval, the Alleröd. Furthermore, they appear to be correlatives of the Two Creeks bog in Wisconsin and to show that there was contemporaneous climatic fluctuation in Europe and North America (Flint, 1951, a, b). The European dates are: Peat from Wallensen in Hills, northwest Germany, $11,044 \pm 500$; lake mud from Neasham, near Darlington in the extreme north of England, $10,851 \pm 630$; peat from Hawks Tor, Cornwall, England, $9,861 \pm 500$; and lake mud from Knocknacran, County Monaghan, Ireland, $11,310 \pm 720$.

There are older dates for geologic material than those above. Wood from a peat bed in the Dranse Valley, south of Lake Geneva in France, is reported as at least 19,000 years old. Wood and peat samples collected between Chambéry and Grenoble in southeastern France are considered at least 21,000. Wood samples from the Lake Kickapoo deposits at Wedron, Ill., from the Camden Moraine south of Dayton, Ohio, from a bank of Skunk Creek in Polk County, Iowa, and from Vermilion County, Ill., have been reported as older than 17,000 years. Coaly peat from an exposure along Eagle River north of Anchorage, Alaska, ran $14,300 \pm 600$. Partially lignitized wood from the shore of Tustermana Lake, Kenai Peninsula, Alaska, gave the date $15,800 \pm 400$. Wood from a depth of 30 to 60 feet along Fairbanks Creek, Alaska, and associated with extinct mammal bones, dated $12,622 \pm 750$. A fossil cedar log dredged from St. Georges Harbor, Bermuda, and representative of the extensive forest that once flourished there but has long been extinct, tested $11,500 \pm 700$.

Dates derived from pollen analysis and the radiocarbon determinations show a general consistency, but there are some disagreements which suggest that the stratigraphic position of some of the samples was not determined properly. Also it seems that there may be a possible source of error in a postdepositional replacement of carbon 14 by carbon 12. Several dates from bogs were mentioned in a previous paragraph. The results from a series of samples reflecting tree growth in the eastern United States are interesting in that they show that the pine phase was reached in West Virginia $9,423 \pm 840$ years ago at a time when that region was definitely outside the glaciated area. The same stage was reached at $8,323 \pm 400$ in Connecticut, and $7,988 \pm 420$ in Minnesota in the region south of the limits reached by the ice sheet during the Mankato substage. In northern Minnesota the phase dated $7,128 \pm 300$. It was still later when similar conditions prevailed in northern Maine, as the radiocarbon test on material from Plissey Pond gave the result $5,962 \pm 320$ (Deevey, 1951). On the basis of these figures it is easy to visualize the slow spread of pine growth from south to north during the relatively dry climatic conditions following the retreating ice sheet.

Work on ocean samples has not progressed as far as that in other lines of research, but what has been done indicates that useful information will be forthcoming not only with respect to deposits at the bottom of the sea but also pertaining to the age and movements of subsurface currents. Unquestionably as more laboratories are established and the techniques are perfected other fields will be found where radiocarbon age determinations will have a definite place. There are, of course, various aspects of the problem that still need clarification. For example, it is not known what effect different climatic conditions may have on samples, whether the carbon-14 content is consistent in

wet and dry areas, or if perhaps the rate of disintegration may be accelerated or decreased by the nature of the deposits where the object to be tested was found. However, the results thus far indicate that the carbon-14 method is valid and, bearing in mind the expectable error, that a majority of the dates obtained are reasonably accurate. Improved methods for collecting samples and greater care in avoiding subsequent contamination probably will sharply reduce the number of unacceptable determinations.

REFERENCES

- ALLISON, I. S.
1946. Early Man in Oregon: Pluvial lakes and pumice. *Sci. Month.*, vol. 62, pp. 63-65.
- ANDERSON, E. C., and LIBBY, W. F.
1951. World-wide distribution of natural radiocarbon. *Phys. Rev.*, vol. 81, No. 1, pp. 64-69.
- ANTEVS, ERNST.
1943. Review of the Boylston Street fishweir by Frederick Johnson et al. *Amer. Antiq.*, vol. 8, No. 3, p. 304.
1948. The Great Basin, with emphasis on glacial and post-glacial times; climatic changes and pre-white man. *Univ. Utah Bull.*, vol. 33, No. 20, pp. 168-181.
1949. Geology of the Clovis sites. Appendix to *Ancient man in North America*, by H. M. Wormington. *Denver Mus. Nat. Hist.*, pop. ser. No. 4, 3d ed., revised.
- ARNOLD, J. R., and LIBBY, W. F.
1951. Radiocarbon dates. *Science*, vol. 113, No. 2927, pp. 111-120.
- BIRD, JUNIUS.
1951. South American radiocarbon dates. *Amer. Antiq.*, vol. 17, No. 1, pt. 2, pp. 37-49.
- BRAIDWOOD, ROBERT J., JACOBSEN, T., PARKER, R. A., and WEINBERG, S.
1951. Radiocarbon dates and their implications in the near and middle eastern areas. *Amer. Antiq.*, vol. 17, No. 1, pt. 2, pp. 52-53.
- BROWN, BARNUM.
1929. Folsom culture and its age, with discussion by Kirk Bryan. *Geol. Soc. Amer. Bull.* 40, pp. 128-129.
- BRYAN, KIRK.
1937. Geology of the Folsom deposits, in *Early Man*, pp. 140-43. Philadelphia.
- BRYAN, KIRK, and RAY, LOUIS L.
1940. Geologic antiquity of the Lindenmeier site in Colorado. *Smithsonian Misc. Coll.*, vol. 99, No. 2.
- CRESSMAN, L. S.
1942. Archaeological researches in the northern Great Basin. *Carnegie Inst. Washington Publ.* 53S.
1943. Results of recent archeological research in the northern Great Basin region of south-central Oregon. *Proc. Amer. Philos. Soc.*, vol. 86, No. 2, pp. 236-246.
1951. Western prehistory in the light of carbon 14 dating. *Southwestern Journ. Anthrop.*, vol. 7, No. 3, pp. 289-313.
- CRESSMAN, L. S., WILLIAMS, H., and KRIEGER, A. D.
1940. *Early Man in Oregon: Archaeological studies in the northern Great Basin.* *Univ. Oregon Monogr., Studies in Anthropology*, No. 3.

DEEVEY, EDWARD S., Jr.

1951. Discussion of the relation of some radiocarbon dates to pollen chronology. *Amer. Antiq.*, vol. 17, No. 1, pt. 2, pp. 56-57.

ENGELKEMEIR, A. G., and LIBBY, W. F.

1950. End and wall corrections for absolute beta counting in gas counters. *Rev. Sci. Instr.*, vol. 21, p. 550.

FLINT, RICHARD FOSTER.

1951a. Discussion of the geologic material dated by radiocarbon, a brief. *Amer. Antiq.*, vol. 17, No. 1, pt. 2, pp. 54-55.

1951b. Pin-pointing the past with the cosmic clock. *Nat. Hist.*, vol. 60, No. 5, pp. 200-206.

GRIFFIN, JAMES B.

1951. Some Adena and Hopewell radiocarbon dates. *Amer. Antiq.*, vol. 17, No. 1, pt. 2, pp. 26-29.

GROSSE, A. V.

1934. An unknown radioactivity. *Journ. Amer. Chem. Soc.*, vol. 56, No. 9, pp. 1922-24.

GROSSE, A. V., and LIBBY, W. F.

1947. Cosmic radiocarbon and natural radioactivity of living matter. *Science*, vol. 106, No. 2743, pp. 88-89.

HANSEN, H. P.

1946. Early Man in Oregon: Stratigraphic evidence. *Sci. Month.*, vol. 62, pp. 43-51.

HEIZER, ROBERT F.

1951. An assessment of certain Nevada, California, and Oregon radiocarbon dates. *Amer. Antiq.*, vol. 17, No. 1, pt. 2, pp. 23-25.

JONES, W. M.

1948. A determination of the half-life of carbon 14. *Phys. Rev.*, vol. 76, p. 885.

KULP, J. LAWRENCE, FEELY, H. W., and TRYON, LANSING E.

1951. Lamont natural radiocarbon measurements, I. *Science*, vol. 114, No. 2970, pp. 565-568.

LIBBY, W. F.

1946. Atmospheric helium 3 and radiocarbon from cosmic radiation. *Phys. Rev.*, vol. 69, Nos. 11-12, pp. 671-72.

LIBBY, W. F., ANDERSON, E. C., and ARNOLD, J. R.

1949. Age determination by radiocarbon content: World-wide assay of natural radiocarbon. *Science*, vol. 109, No. 2827, pp. 227-228.

MANGELSDORF, PAUL C.

1950. The mystery of corn. *Sci. Amer.*, vol. 183, No. 1, pp. 20-24, July.

MILLER, W. W., BALLENTINE, R., BERNSTEIN, W. FRIEDMAN, L., NIER, A. O., and EVANS, R. D.

1950. The half-life of carbon 14 and a comparison of gas phase counter methods. *Phys. Rev.*, vol. 77, p. 714.

MOVIUS, HALLAM L.

1951. The Lascaux Cave. *Amer. Antiq.*, vol. 17, No. 1, pt. 2, pp. 50-51.

SAYLES, E. B., and ANTEVS, ERNST.

1941. The Cochise Culture. *Medallion Pap. No. 24*, Gila Pueblo, Globe, Ariz.

SCHULTZ, C. BERTRAND, and FRANKFURTER, W. D.

1949. The Lime Creek sites, in *Proc. 5th Plains Conference for Archeology*, pp. 132-34. Lincoln.

WILLIAMS, H.

1942. The geology of Crater Lake National Forest, Oregon. *Carnegie Inst. Washington Publ. No. 540*.

River Basin Surveys: The First Five Years of the Inter-Agency Archeological and Paleontological Salvage Program

By FRANK H. H. ROBERTS, Jr.

*Associate Director, Bureau of American Ethnology
Director, River Basin Surveys*

[With 10 plates]

LATE in the autumn of 1944, archeologists throughout the United States began to realize that the development and expansion of a nation-wide program for flood control, irrigation, hydroelectric, and navigation projects by the Federal Government would eventually destroy many archeological sites in areas where virtually no investigations had been made, and that whole chapters covering thousands of years of the aboriginal history of North America would be lost unless some steps were taken to save them. As a result of suggestions stemming from various sources, an exploratory meeting of some of the members of the Committee on Basic Needs in American Archeology and archeologists stationed in Washington, D. C., was held at the National Research Council in January 1945. At that time various plans were suggested for starting a program for the salvaging of materials from areas which would be involved. No definite action was taken then, but as an outgrowth of the discussions an independent committee, the Committee for the Recovery of Archeological Remains, composed of representatives from the Society for American Archaeology, the American Anthropological Association, and the American Council of Learned Societies, was organized in April of the same year and undertook a careful study of the problem. Concurrently, members of the staff of the Smithsonian Institution were working on a tentative program and discussed the situation with officials in various agencies interested in the development of river-basin projects. During approximately the same period interbureau agreements were completed between the National Park Service, the Bureau of Reclamation, and the Corps of Engineers for a survey of the recreational

resources of proposed reservoir areas. Since the National Park Service is the Federal bureau specifically charged by law with responsibility for the preservation of historical and archeological sites, it interpreted the agreements for the study of recreational resources to mean that archeological and paleontological remains should be included and was making preliminary preparations for studying them.

Late in the spring of 1945 the Smithsonian Institution and the National Park Service, through the work of the Committee for the Recovery of Archeological Remains, were made aware of the common goal toward which both were striving. This resulted in a series of conferences which made it apparent that the National Park Service and the Smithsonian Institution were prepared to cooperate fully in any general program for the survey and recovery of archeological and paleontological remains and that the Smithsonian Institution was prepared to take scientific responsibility for the work to be done. Eventually a Memorandum of Understanding between the two agencies was prepared and signed, providing in part that the National Park Service would call to the attention of the Smithsonian Institution the locations of all the proposed dams and reservoirs and that the Smithsonian Institution would advise the National Park Service as to the number and importance of the known archeological or paleontological sites located within such areas and would recommend such surveys in the field as might be indicated. The National Park Service was to inform the respective agencies responsible for the construction of the proposed reservoirs as to the nature and extent of the remains that would be lost if thorough investigation and excavation was not undertaken sufficiently in advance of the flooding of the reservoir. This was the genesis of the Inter-Agency Archeological and Paleontological Salvage Program.

To carry out its part of the Memorandum of Understanding, the Smithsonian Institution in the fall of 1945 instituted the River Basin Surveys which was organized as a unit of the Bureau of American Ethnology. The National Park Service then furnished the River Basin Surveys with lists of Bureau of Reclamation and Corps of Engineers projects. On the basis of information available in published reports, from correspondence with local societies, museums, colleges, universities, and interested laymen, areas where surveys should be started were determined. It was apparent that in many regions the operations would be a race against time, but because of its size, the fact that 105 projects had already been authorized and in many cases were under construction there, because of its importance to American archeology in general, and since very little was known about its broader manifestations, the Missouri Basin was chosen as the first scene of operations. Officials of the National Park Service

presented the case for the Missouri Basin to the Bureau of Reclamation. A preliminary allotment of funds to begin the work was made by that agency and was transferred through the National Park Service to the Smithsonian Institution. The funds were for use in both Bureau of Reclamation and Corps of Engineers projects.

BEGINNING OF THE WORK

The first actual field work got under way in July 1946, when a field office was established at Lincoln, Nebr., in quarters provided by the University of Nebraska, and three parties of two men each made a rapid reconnaissance covering more than 13,000 miles, visiting 28 top-priority Bureau of Reclamation projects and 5 Corps of Engineers reservoirs. In September of the same year the Corps of Engineers transferred funds through the National Park Service for surveys to be made outside the Missouri Basin, and field parties were started in Georgia, Virginia, Texas, and California. The money provided by the Corps of Engineers was for use in their projects only. The Bureau of Reclamation supplied additional funds in March 1947 for surveys at its projects in the Columbia-Snake Basin, and work got under way there the following June. In addition, both agencies contributed in no small degree to the successful start of the surveys through their cooperation in other ways. Bureau of Reclamation personnel and division and district engineers did much to facilitate the work of the men in the field. In some areas transportation was provided, in others necessary labor was furnished to aid in emergency excavations, and elsewhere temporary office space and storage facilities were made available at project headquarters. In the fall of 1947 the Bureau of the Budget ruled that thereafter all requests for appropriations for the archeological and paleontological program should appear in the Interior Department budget. As a consequence, Missouri Basin funds for all types of projects are carried in the Bureau of Reclamation item, while those for other areas are provided by the National Park Service. Furthermore, it was stipulated that the investigations need not be restricted to Bureau of Reclamation and Corps of Engineers projects but could also be carried on in those sponsored by other Federal agencies and by the several States. Even after it was decided that all the necessary funds were to be provided through the Interior Department, the Corps of Engineers continued to contribute to the effort through the loan of equipment, office space, and transportation.

In subsequent years the program was expanded to cover more and more areas throughout the country. Field headquarters for the Pacific coast region were set up at Eugene, Oreg., in space made available by the University of Oregon, and at Austin, Tex., where the Univer-

sity of Texas provided office and laboratory room. A field base was also made available at Athens, Ga., by the University of Georgia. By July 1951, after the program of field work had been going for 5 years, surveys had been completed in 225 reservoir areas situated in 25 States. One lock project and four canal areas were also investigated. Some 2,894 archeological sites were located and recorded and of that number 545 have been recommended for excavation or limited testing. The initial phase of the program called for preliminary surveys to locate remains with such testing as might be necessary to determine which of the sites were of prime importance. The next step was that of extended excavation at those sites which promised particularly informative results in relation to the archeology of neighboring districts and of the particular area as a whole. Because of the fact that the program was late in starting, it took the greater part of the first 3 years to catch up with the necessary survey work. In some cases the construction of dams was so far advanced that they were completed and were impounding water before survey parties could reach them. In others surveys were made, but the area went under water before any digging could be done. As more and more of the regions were surveyed, however, it became possible to start actual digging and by the end of the 5-year period there were more excavations than surveys in progress. Digging had been done or was continuing in 33 reservoir projects in 10 river basins scattered over 15 States. While detailed analyses of the data and materials from the excavations have not been completed, it is evident that considerable new knowledge has been obtained and that a much better understanding of aboriginal activities in the various areas will be forthcoming.

In carrying out the program, the River Basin Surveys was aided in no small degree by State and local organizations which in some instances actually joined forces with the Surveys' reconnaissance or excavation parties and in others assumed full responsibility for specific projects. During the first 3 years the cost of such assistance was borne by the cooperating institutions. In the last 2 years of the period, however, there was a change of policy and a number of local institutions signed agreements with the National Park Service whereby they were furnished some funds and excavated sites that had been chosen in accordance with recommendations of the Smithsonian Institution.

The sites located by the survey parties represent the whole range of such remains known throughout the United States. There are localities attributable to occupation by some of the early hunting, food-gathering peoples, camping places intermittently occupied by later Indian groups, quarries, bluff and rock shelters, caves giving indications of inhabitation, villages, artificial mounds, burial grounds, ossuaries and cairns, and even battlefields. In association with many of

the various kinds of sites are groups of petroglyphs pecked into or painted on the surface of adjacent large boulders or the faces of neighboring cliffs. The surveys did not confine their efforts to the locating of strictly aboriginal sites but also noted and recorded places of historic interest such as early trading posts, pioneer forts, and Colonial and pioneer villages. In many cases there is a definite correlation between Indian remains and those of the white man, and study of them undoubtedly will throw considerable light on acculturation problems and the effects of an advanced civilization on primitive cultures. After the investigations have been completed and the results are available there should be a fairly comprehensive story of the history of the aboriginal United States from the closing days of the last Ice Age down to the Indian wars in the Plains area in the late sixties and early seventies. For the late periods there is, of course, considerable documentary material containing valuable information, but archeological evidence in many cases will augment and clarify the written records.

OLD REMAINS UNCOVERED

Excavations have been carried on at several locations where it appears that some of the older Indian groups were present. Along a small tributary of the Columbia River near Cold Springs, Oreg., indications of a cultural layer lying beneath a strip of wind-blown volcanic ash were found in the stream bank. Excavations at that location uncovered traces of a single occupation by a group of Indians having a simple culture and, except for the projectile points, very crude tools. There were no indications of any type of habitation. The people presumably built their fires and cooked their food in the open. Large numbers of animal bones, many of which were burned, and many mussel shells were present in the debris. It is apparent that the people depended about equally on fishing and hunting for their subsistence. The artifacts consisted largely of hammerstones and choppers with a fair showing of projectile points. The projectile points are leaf-shaped with a concave base. They do not have the side notches or stems such as are common in many parts of the area. The projectile point represents one of the older types but thus far has not been definitely correlated with some of the better-known varieties. The cultural remains probably represent a fairly early stage in the occupation of the Columbia Basin, but their proper place in the sequence for the area will not be known definitely until the volcanic ash that covered them has been correlated with one of the known eruptions in that region or until a carbon-14 test has been made on the burned bones.

Another location where relatively old remains were found was in the Tiber Reservoir area along the Marias River in Montana. Two

different sites were excavated there and were found to contain occupation levels indicative of a simple hunting culture. The materials obtained from the digging consisted of a small series of artifacts in association with bones from bison, deer, and smaller mammals. There were no indications of any form of habitation and the cooking fires apparently were built for the most part in simple basins in the surface of the ground, although an example of a rock-ringed hearth was found. There was nothing to indicate a chronological age for the remains, but the artifact assemblage suggests that the culture was reasonably old and that it may well fall within the period that previously has been considered to constitute a gap between the Paleo-Indians such as are represented by the Folsom and similar complexes and the later Indian groups. At one of the Tiber sites there were several occupation levels, the lowest of which was $7\frac{1}{2}$ feet below the present surface. The strata at that location are such that careful study of their characteristics may produce helpful data pertaining to the rate of deposition in that region.

EXCAVATIONS IN ANGOSTURA BASIN

Perhaps the most significant of the early sites excavated by the River Basin Surveys during the course of the current program is that in the Angostura Reservoir basin in South Dakota. The Long site, as it is called, contained deeply buried fireplaces with associated artifacts. The projectile points in the artifact assemblage show certain similarities to types belonging to relatively early horizons in other regions. Some suggest one of the so-called Yuma forms, others the Plainview type, and others some of those found in the Pinto Basin in the Mohave Desert. There are also examples comparable to some found in the Agate Basin district in eastern Wyoming not far west from the Angostura site. Probably because of the high gypsum content of the soil at the Long site, very little has been found to indicate the type of food used by the people who made the artifacts. Bone is virtually nonexistent, but the artifact complex bespeaks a heavy reliance on hunting, although there may have been some use of ground seeds and nuts. The cultures containing the implements to which those of the Long site bear closest resemblance definitely were based on a hunting form of economy, and it seems logical that such would be true for the people who roamed the Angostura Basin at the time the Long site was inhabited. Charcoal from fire pits at the site has given carbon-14 dates of 7073 ± 300 and 7715 ± 740 years before the present (Roberts, 1951, p. 21).

Three extremely significant sites belonging to the early period were found and excavated in the Medicine Creek Reservoir basin in western Nebraska by the State Museum of Nebraska in cooperation with the

general program. One of them, the Allen site, was located on Medicine Creek, while the other two were on Lime Creek in the same drainage. At the Allen site there were two occupation levels occurring in the base of a terrace that was provisionally correlated with the Mankato Substage of the Wisconsin Glacial Stage. The cultural material began some 20 feet below the present surface and occurred in a band from $2\frac{1}{2}$ to 3 feet thick. The two levels were separated by an intermediate zone about $1\frac{1}{2}$ feet thick, which contained only a small amount of cultural material. The lowest level was characterized by the remains of small camp fires, which had been built on the old surface, large numbers of broken and disarticulated animal bones, and scattered artifacts consisting of knives, scrapers, blades, abrading stones, hammerstones, projectile points, and bone implements. The upper level showed little change in the nature of the artifacts, but there was a distinct difference in the character of the animal bones associated with the fireplaces and artifacts which possibly indicates a significant change in the fauna of the area, possibly as a result of some change in climatic conditions. The nearest similarities to groups of elements from the complex at the Allen site thus far noted are with those from Dead Man Cave in northeastern Utah. Charcoal obtained from the earliest occupation at the Allen site gave a carbon-14 date of $10,493 \pm 1,500$ years, while some from the upper layer gave a date of $5,256 \pm 350$. A tentative geological dating from Dead Man Cave has placed its first occupancy at approximately 4,000 years ago, which gives grounds for interesting speculations pertaining to the similarities between the two cultures (Holder and Wike, 1949).

At the original "Lime Creek discovery" eight cultural horizons have been located, but in only one has an adequate series of artifacts been found. The general indications are that the culture is related to that which produced the Plainview-type points found in western Texas and other localities throughout the Plains area. The evidence at Angostura for the association of a Plainview variant with the materials there, and the date of approximately 7,000 years for that assemblage, give a good indication of the age period to which the Lime Creek points may belong. The other Lime Creek site, some distance downstream from the first, is one where animal bones and artifacts occur in a dark gray stratum $47\frac{1}{2}$ feet below the surface of the present terrace. The so-called Scottsbluff Yuma-type projectile point is reported to have been found in situ there together with knives, numerous flakes, end scrapers, leaf-shaped and other blades, and considerable quantities of chippers' debris. The animal bones represent some 17 mammalian forms as well as those of birds, reptiles, and amphibians (Schultz and Frankforter, 1948, 1949). When the carbon-14 age of 9524 ± 450 years for the site was first announced it was

received with some incredulity by archeologists because it suggested that the Scottsbluff Yuma-type point was much older than most had supposed since it was found in other localities whose dates are considerably younger. Undoubtedly some implement forms persisted over long periods of time but in the present instance the span seemed too long. Subsequently, however, it was learned that the sample of charcoal tested came from log fragments found one to two feet below the level of the cultural material. Hence the artifacts must be an undetermined number of years younger than the announced date.

Excavations in camp sites were made in a number of reservoir areas. In most cases the information obtained was not as extensive as might be desired but does reveal something of the mode of life and habits of the people who formerly occupied them. The scarcity of material at such locations is probably attributable to the fact that only temporary shelters—perhaps brush or other highly perishable structures—were used and there are no traces of dwellings or habitations. In most cases such an area is characterized by unprepared basin-shaped hearths containing charcoal and ashes, midden deposits with chopped and broken animal bones, chipped-stone debris, and other refuse. Occasionally potsherds and even restorable vessels are found, but they are not so common as at the sites of more permanent villages. Because such camping places were occupied only for short periods, or intermittently, by hunting parties, the amount of material left is small in comparison with that usually found where substantial villages were erected. Several sites of that type were examined in the Angostura Reservoir basin in South Dakota and in the Boysen Reservoir area in Wyoming. Most of them appeared to belong to late prehistoric times, but in one instance in the Boysen basin an early contact period was represented, as trade beads and bits of iron were present. No correlations have been made as yet with Indian tribes known to have been in that portion of the Plains, but when studies are completed it may be possible to attribute at least some of the sites to a particular group. The cultural material from them gives a good idea of the kinds of tools and implements being made just before or at the time when the first white men reached the area. Furthermore, the information is a contribution because prior to the River Basin Surveys no systematic investigations had been made in the Angostura and Boysen regions.

Associated with or adjacent to some of the camping sites are features that usually are referred to as tipi rings. The latter are indicated by circles of stones on the surface of the ground. The general supposition is that the stones were used to hold down the edges of skin tents or tipis. There has been disagreement over that interpretation, however, as some ethnologists insist that the later Indians

did not anchor their tents in that fashion, and a few archeologists have reported that there was nothing within the circles to indicate occupation. In an effort to determine the actual status of such manifestations, a number were excavated in various localities. It was expected that a hearth or fire pit would be present near the center of the circles if tents had actually been placed there. In the Boysen area those investigated gave no indication of fires and the question still remains as to whether or not tipis actually stood there. Evidence elsewhere substantiates the tipi-ring concept in that fire basins were found near the centers of the circles of stones. Occasional unexcavated examples may be seen with a small circle of stones outlining a hearth still showing on the surface. An explanation is still to be found for those where evidence of occupation is lacking.

ROCK SHELTERS

Rock shelters have been dug in several areas. At the Whitney Reservoir on the Brazos River in Texas three such sites were investigated. One of them, locally known as Pictograph Cave, showed that it had been lived in during at least two different periods, the first being prior to approximately A. D. 1200 and the second occurring subsequent to that time but also pre-Columbian in age. There was a well-defined cultural stratigraphy in the shelter, and good data were obtained pertaining to changes in diet and population density during the two periods. The early occupation is comparable in many respects to the Round Rock Focus of the central Texas region but the second has not yet been correlated with other known remains. Although Pictograph Cave was a dry shelter and vegetal remains were preserved in all levels, basketry, matting, cord, or other perishable artifacts were not found. That was a curious situation, and its significance is not altogether clear. According to what is known about the Indians in the general area, it would seem that such objects should have been a part of the material culture. The second location, known as Buzzard Shelter, is not far distant from the first and the digging revealed that there also had been two periods of occupation with considerable general similarity between the cultural sequences. However, there were specific differences in artifact types, and it would appear that the material in the second location represents slightly different cultural groups. The lower level at Buzzard Shelter produced specimens that apparently are attributable to a rather early complex. The upper level correlates fairly well with what is called the Toyah Focus in central Texas. The third location, known as Sheep Cave, was much larger but the cultural sequences seem to follow the pattern of the other two. Five flexed burials were found there, however, and study of the physical type

represented should throw some light on the relationships of the people. Examination of the bones has not yet been completed so no conclusions are possible at this time. The material in general, however, does give a much better understanding of the archeology of that portion of Texas and when correlated with the results of other excavations in the Whitney basin should round out the story in a satisfactory manner.

In the Boysen Reservoir area in Wyoming, Birdshhead Cave was found to contain stratified deposits representing seven with possibly one or two more periods of occupation. There were six district levels seemingly covering a wide range in time. Differences in faunal material suggest that climatic conditions prevailing in the district during the first occupation were not the same as in subsequent times. Later levels show varying degrees of change leading to present-day conditions. The artifact yield from the cave was small, but such specimens as were collected show changes in projectile-point types from top to bottom. There also was evidence for a shift in the economy through the several occupations. In the lower levels it appears that the people were largely dependent upon plant foods supplemented by small game such as rabbits, squirrels, and conies. In the later levels the economy was definitely based on the hunting of large herbivorous animals as is indicated by the presence of bones from antelope, deer, bighorn sheep, and possibly bison. The presence of steatite vessel fragments, rabbit-hair cloth, fiber cordage, and pieces of basketry in the upper levels suggests that there was a late prehistoric occupancy of the cave by Indians from the Great Basin to the west rather than by peoples from the Plains lying to the east. This has raised an interesting set of problems pertaining to the long-term interrelationships between two distinct modes of life in the Western Plains. If the artifacts from the various levels in the cave can be correlated with those from single-occupation sites, it may be possible to determine the sequence for the open sites in the Boysen Reservoir and the Wind River basin as a whole. Studies of the material from the various sites have not progressed sufficiently to establish a relative chronology as yet (Bliss, 1950).

An interesting rock shelter was investigated at the Equalizing Reservoir basin southwest of the town of Grand Coulee, Wash. The excavations were handicapped by the fact that large blocks of stone had fallen from the ceiling of the cave and it was necessary to dig around and beneath them to unearth the archeological remains. The evidence obtained there indicated that the place was not lived in continuously but was one where small groups probably camped from time to time. Three distinct levels of occupation were found, but it did not appear that there were lengthy intervals between the periods when

people stayed there. The artifacts suggest that the same cultural group was involved from first to last. A considerable amount of dry material such as is rarely present in open sites was obtained. There are pieces of cordage, sections from arrow and spear shafts, fragments from bow staves, portions of textiles, matting, and bits of basketry. Among the objects made from more durable materials are stone projectile points, bone implements and beads, and shell beads. Study of the specimens made from perishable materials should throw considerable light on that phase of the arts and industries of the people in the area. On the basis of the artifact collection as a whole, it would seem that the shelter probably was occupied by either the Nespelim or their eastern neighbors, the Sanpoil. There were objects of white manufacture on the surface in the cave attributable to picnic parties held there by modern residents of the region. No such material was found beneath the surface, yet it is difficult to assign the aboriginal objects either to historic or pre-Columbian times.

VILLAGE REMAINS

A major part of the excavation program has been concerned with village remains. In the Columbia Basin digging has been carried on at village sites in the McNary, O'Sullivan, and Chief Joseph Reservoir projects. At each of the locations the activities were directed toward the clearing of house pits and the excavation of midden deposits. The house remains show that many of the structures were circular to oval in form, with diameters ranging from 25 to 40 feet, and were grouped in clusters along the terraces above the river. Because of the scarcity of timber, the Indians apparently took the main supports from the structures with them when they moved from place to place. As a consequence there is little to indicate the type of superstructure. It probably consisted of a framework of poles to which branches or mats were lashed. The poles were not embedded in the earth, but some stability was obtained by heaping dirt against the outside of the walls. The floors were 2 to 3 feet below the surface near the center and sloped gradually upward to about the ground level at the rim. The village patterns were very simple. At most sites the houses were strung along the river without any particular attempt at formal placement, although in several instances there apparently was a twofold division, with one group of dwellings being located at one end of the site and the second group at the other. Where such arrangements were noted one cluster of house pits generally was smaller than the other. What significance there may be, if any, to that situation has not been determined.

At a number of the sites the remains of long, oval, or rectangular "mat houses" were found. The latter apparently represent a later

stage of house building than the structures with circular or oval floors. The "mat house" was a popular form of multifamily dwelling during the historic period in that area and the oval form found in the McNary basin agrees closely with the descriptions of such houses obtained by ethnological investigators working among the Umatilla Indians in previous years. Most of the villages dug along the Columbia were occupied just prior to the coming of the white man in that region or represent the contact period. None of the latter appear to have been inhabited long after the visit of the Lewis and Clark expedition. The excavations also have shown that in many cases hunting actually played a larger part in the economy than previously supposed. The basic source of food, of course, was fishing, but that activity did not provide the entire subsistence. Another interesting fact gained from the excavations was that the circular form of dwelling persisted into more recent times than had commonly been supposed. At several locations the excavations were carried on as cooperative projects of the River Basin Surveys, the University of Oregon, the University of Washington, and the Washington State College. In the spring of 1951 materials from the McNary Reservoir diggings were processed at a laboratory provided by the University of Washington.

The remains of an interesting small village were uncovered in the Terminus Reservoir area on the Kaweah River in Tulare County, Calif. The community had consisted of 14 houses and 3 distinct milling places. It was located on a well-drained knoll adjacent to the river. The house remains—with one exception—were found to consist of roughly circular floors varying from 8 to 16 feet in diameter. The differing structure was oval in form with diameters of approximately 50 and 20 feet. In the floors of the houses were unprepared hearths consisting of lens-shaped deposits of wood ash. The floors themselves did not give evidence of having been specially prepared but probably were compacted through use. The upper parts of the houses were found to have consisted of pole and thatch superstructures covered with a layer of clay plastering. The fact that the houses had burned and that the clay was fired sufficiently to preserve the imprints of the twigs and grass showed the type of construction. At three different locations adjacent to the village the exposed bedrock provided places where the women had ground the acorns and other seeds used for food. At those milling places there were groups of mortar pits varying in depth from 1 to 9 inches and from 4 to 10 inches in diameter. The pestles used in the mortars were not present at the milling places although a few were found in the course of excavation in the village. The regular cemetery for the village was not located but the remains of eight individuals

were found in the village area. Six of them had been buried, while two had been cremated. Apparently it was not customary to make funerary offerings as in only one questionable case was an object found associated with the human remains.

Evidence pertaining to the economy of the people suggests that they were primarily dependent upon vegetal food although animal bones found in the middens indicate that occasional deer, elk, hares, and rabbits probably supplemented the diet. The people had both pottery and steatite vessels. The potsherds indicate that the common ware was that known from ethnographic sources of the Yokuts and Mono Indians. The fragments of steatite vessels from the site are from a form that previously has only been reported from the Santa Barbara coast. Numerous shell beads were found as well as some made of steatite. The latter material was also used for making pendants of a variety of forms. In addition there was some trade material showing contact with the whites. A few glass beads and a fragment of glazed pottery, probably of Mexican origin, as well as steel prongs from a fish spear, make it possible to date the village as having been occupied until about 1850.

The results of the excavation are important because they provide an opportunity to study the material culture left by a group of people who occupied the region in historic times and concerning whom there is an unusually complete ethnographic record. Correlations of the data from both the ethnological and archeological sources of information will throw considerable light on the function and significance of the artifacts and various features of the site. Items of the material cultural previously known only through tradition are now represented by actual objects. The lower end of the Kaweah Canyon was formerly occupied by a small band of the Yokut Indians and it seems extremely probable that the village was inhabited by some of the same or a closely related people. Information on other village types was obtained elsewhere in California as the Archeological Survey of the University of California at Berkeley dug some village sites in the Pine Flat and Isabella Reservoir areas as a cooperative project.

At the Medicine Creek Reservoir in western Nebraska a party from the River Basin Surveys excavated in eight village sites. Six of them belonged to what archeologically is known as the Upper Republican Aspect, while two were a variant of the Woodland. Evidence at the Upper Republican sites was that the houses generally were built in clusters of two to four structures with considerable distance frequently separating the groups. Because of that fact there is some question as to whether they should be called villages or simply family communities. In some cases it would be difficult to determine where

one village left off and another started. However, there are examples showing that villages sometimes might contain as many as 18 to 35 or 40 houses. The houses were of the earth-lodge type. The floors sometimes were on or slightly below the original surface of the ground, while in other instances they had been excavated to a depth of 6 to 20 inches. They were roughly rectangular in form. The superstructure was supported by four to six large posts set at approximately equal distances from the single central fireplace. The outer walls consisted of a series of smaller posts set in the ground around the periphery of the floor. Rafters probably extended from the outer walls to the smoke hole above the fireplace. Brush, grass, and sod were then placed as a roof cover. The outer walls probably were enclosed by interwoven willows and grass and seemingly were banked around the outside with earth. The houses had entranceways extending outward 8 to 10 feet from a point near the center of one wall. The entranceways were 2 to 4 feet in width, and their floors usually were on the same general level as that of the house. Occasionally, however, the floor of the entrance was excavated below the general level to facilitate drainage. The entranceways usually opened to the south but examples were found where they faced the east, southeast, or southwest. Midden or refuse areas generally were located at the end and around either side of the entranceway. Outside storage pits were also dug near the entrances, but a more common place for them was beneath the house floors. After such pits had served their purpose for the storage of vegetal products they frequently were used as dumping places for refuse.

Artifacts associated with such houses consist of potsherds, stone and bone implements, objects of antler, and a limited number of shell ornaments. The storage pits yielded charred kernels of corn, corn-cobs, sunflower seeds, charred nuts, and mellow or squash seeds; also bison bones, fish bones, crayfish, and shells from fresh-water mussels. The economy obviously was one based primarily on agriculture with hunting a secondary feature. During the period that the River Basin Surveys' work was being done the Nebraska State Historical Society excavated 14 house remains in 6 Upper Republican village sites in the Medicine Creek basin, and the material and information obtained from them is being correlated with that from the other locations.

Evidence from the two village sites where the Woodland variant occurred shows that the house type was much less developed than that of the Upper Republican. The dwellings were of the semisubterranean type, with the floors 12 to 18 inches below the ground level. The superstructure, while fairly permanent, was rather flimsy and probably had a roof of brush with a grass and bark or skin covering. The houses were grouped rather closely with a maximum of four to six

in a cluster. The houses did not have a well-defined fireplace basin, and there was no particular pattern to the location of middens or pits throughout the general village area. The pottery occurring at such sites is not plentiful and for the most part represents a rather simple type. The artifacts also do not show as much variety as those from Upper Republican sites and for the most part appear to be implements used for hunting and gathering. Bone beads were very common and there were other objects made of bone. Shell was also used for the manufacture of ornaments. The economy was mainly based on hunting and food gathering. Deer and antelope bones are plentiful, and while there are some from bison they are not so common. Large numbers of bird bones indicate considerable dependence upon small game. In general the Woodland sites do not indicate as permanent an occupancy as those of the Upper Republican Aspect. While no definite stratigraphic evidence was obtained, the general feeling is that the Woodland sites are older. It is not possible at this time to correlate the Upper Republican remains with any of the known tribes such as the Dakota, Pawnee, or Comanche, but this may be done later. Remains of that culture are believed to date from about A. D. 1200 to 1500. Because of the seeming affinities of the sites which are considered a Woodland variant, they have been dated tentatively as belonging to the general period A. D. 500 to 1200 (Kivett, 1949).

At another location in the Missouri Basin, the Oahe Dam site just north of Pierre, S. Dak., the remains of an extremely significant village were excavated. The village, called the Dodd site, lay in the path of the approach channel for the dam, and it was necessary to make investigations there early in the construction program. The excavations at that locality constitute the largest project thus far completed along the main stem of the Missouri River. The remains of 21 earth lodges, 27 cache pits, and 16 miscellaneous features were uncovered there. Unexpectedly three types of houses were found, with definite stratigraphic evidence for a sequence of the various forms. There were circular earth lodges and two types of rectangular earth lodges. The latest structures at the site unquestionably were the circular ones. The oldest of the rectangular lodges apparently were the smaller examples which had a somewhat different pole arrangement from the larger ones. It has not been definitely established as yet, but it appears fairly certain that the circular houses are attributable to the Arikara. The rectangular ones have not been tribally identified. Numerous cache pits were found in association with the various house remains and from the refuse which many contained several thousand specimens were recovered. Artifacts were also found on the floors of many of the structures. The material consists of potsherds and stone, bone, shell, and metal artifacts. Analysis of the specimens as well as

of the various animal, bird, and fish bones and vegetable products from the middens should give a clear picture of the material culture of the groups that lived there and undoubtedly will make a definite contribution to the knowledge of the area.

FORTIFIED VILLAGES

A short distance downstream from the Dodd site on the same side of the river in the construction area for the dam was another known as the Phillips Ranch site. It consisted of the remains of a fortified village, of which there were a number along the Missouri River in late prehistoric and early historic times. The excavations there traced the moat and palisade that enclosed the village, uncovered the floors of 10 earth lodges, cleared some 90 cache pits, and examined a large section of the area lying between the houses and the surrounding ditch. The houses had been circular in form and in many respects were similar to those of the last period of occupation at the Dodd site. One of the structures possibly was a "community house." It was 50 feet in diameter, and the outer wall had consisted of a double row of posts instead of the usual single row. The entrance was to the east, and on the opposite side of the fire pit against the west wall there was an earth altar.

The artifacts found at the village include a large number of potsherds and numerous objects of bone, shell, stone, glass, and metal, and a few fragments of basketry. In general it appears that the Phillips Ranch village represents the stage following the last period at the Dodd village and belongs to the final occupation of the region by the sedentary peoples. When the data from the excavations have been fully analyzed they should give a good picture of the early contact period. As in the case of the Dodd site, it is evident that the basic economy of the people was agricultural but that hunting contributed an important part of the diet; fish from the nearby river also seem to have been utilized. Work at other fortified village sites in the Oahe Reservoir and in the Fort Randall Reservoir area farther south has been started but has not progressed sufficiently to warrant discussion at this time.

In addition to the excavation of village remains in the Missouri Basin by parties representing the River Basin Surveys, the University of South Dakota carried on investigations in the Fort Randall area at the Swanson site on the east side of the Missouri River north of Chamberlain, at the Scalp Creek site on the south side of the Missouri about 5 miles downstream from the Wheeler Bridge, and in the Oahe Reservoir area at the Thomas Riggs site on the east bank of the river approximately 10 miles above the site of the dam. The State Historical Society of North Dakota investigated the remains of the historic Fort Berthold Indian village in the Garrison Reservoir area.

The University of Montana also excavated in the Garrison Reservoir. The University of Wyoming dug sites in both the Boysen and Keyhole Reservoirs in that State. The Nebraska Historical Society carried on investigations in the Medicine Creek and Swanson Lake reservoir areas in Nebraska and in the Fort Randall Reservoir in South Dakota. The Laboratory of Anthropology at the University of Nebraska excavated a large village at the Harlan County Reservoir in southern Nebraska. The University of Kansas carried on investigations in the Kanopolis Reservoir in Kansas and in the Fort Randall Reservoir in South Dakota (see Champe, 1949; Hurt, 1951; Meleen, 1949).

At the Whitney Reservoir on the Brazos River in Texas a historic Indian village known as the Stansbury site yielded interesting data on mid-eighteenth- and early nineteenth-century Indian life in that region. House patterns with compact floor, post holes, central fire hearth, and bell-shaped cache pits were found. Material from it includes trade items of French, English, and American origin. At another location in Texas in the Lavon Reservoir area on the East Fork of the Trinity River digging was done in the remains of a village where there was a large circular pit. There are 11 extensive village sites in that district, and each of them is characterized by a similar pit. Such pits are a feature peculiar to the area, and their real purpose is in question. In an effort to determine their original function, one of the pits was excavated. It was found to have had an original diameter of 65 feet and a depth of 10 feet. The dirt from the original digging had been piled around the periphery, forming a rim with a diameter of 90 feet from crest to crest. The floor was slightly concave and there was nothing to indicate that any type of structure had been erected over it. A burial area was found along the east rim of the pit and on the inner slope at the south side there was a grave containing the skeleton of a wolf. The animal had been intentionally interred and must either have been a village pet or have had some totemic significance. Until more detailed studies have been made of the data obtained during the investigations it is not possible to tell whether the burial area was an integral part of the pit feature or was incidental to it. It is clear, however, that the pit correlates with the earliest period of the village and that it remained in use throughout the occupation of the site. There is no question that the village antedates any European influence in the area and potsherds found there suggest that its age probably falls within the period A. D. 1200 to 1500. An interesting fact about the potsherds is that all represent trade wares. Apparently there was no local ceramic industry.

EXCAVATIONS IN OKLAHOMA AND GEORGIA

At the Tenkiller Ferry Reservoir on the Illinois River in Oklahoma a River Basin Surveys party excavated in a village area called the Cookson site. Two stages of occupation were found there. One was characterized by rectangular houses with four center posts and trench entrances. The other also had rectangular houses but with only two center posts and no evidence of entranceways. The second houses also appeared to have had some form of bench or similar feature along the north wall. The artifacts associated with the first type of house, which apparently was the older, consisted of thick, heavy, single-faced hand grinding stones made from water-worn cobbles; pitted stones which seemed to have been used as a kind of muller; slate hoes; chipped double-bitted axes; and large and heavy projectile points. A small number of potsherds from a thick clay-tempered ware was associated with the artifact complex. The materials found in and associated with the other form of house consisted of thin, two-faced hand grinding stones; the same type of muller as occurred in the first instance; and small, light arrow points. Slate hoes and double-bitted axes were missing from the later horizon. The potsherds accompanying the other artifacts were from a shell-tempered type of ware which for the most part was undecorated. The first stage represents a complex that culturally is probably fairly early. The stone artifacts attributed to it fall within the range that is considered typical of the so-called Archaic and early Woodland remains in the Southeast. They also are common in sites in north-eastern Oklahoma that represent a prepottery culture and have been designated the Grove Focus. The second stage is thought to correlate with what has been termed the Fort Coffee Focus but certain of its traits indicate that it probably would warrant being set up as a separate focus.

The first type of house corresponds to that which is considered typical of the early Spiro component in the area of the famous Spiro Mounds which were located on the Arkansas River southeast from the Tenkiller Ferry area, and the second type of house is considered similar to one of those in the late Spiro component. Four graves were found in the village area, and all apparently belonged to the early period. The cemetery for the later horizon was not located. The University of Oklahoma carried on a series of excavations at other sites in the Tenkiller Ferry area subsequent to the digging done by the River Basin Surveys party, and when all the results have been correlated there should be considerable information about aboriginal developments in that district. The University of Oklahoma also excavated in village remains in the Fort Gibson and Eufaula Reservoir areas and salvaged considerable material at both locations.

The Allatoona Reservoir on the Etowah River near Cartersville, Ga., constitutes one of the most complete units thus far studied by the River Basin Surveys. Following a preliminary reconnaissance of the area to be flooded by the reservoir, a series of excavations was started at a number of village sites. In some cases the villages were well-developed communities, but in a few instances appeared to have been of a more rudimentary nature. During the course of the work 11 sites were excavated and 19 were tested. On the basis of the results from both the surveys and the digging it was possible to outline a sequence of cultural stages in the Etowah River area. At least 10 and probably 11 different periods were identified. They extended from the historic Cherokee of about 1755 back to a prepottery phase when hunting and food gathering comprised the basic sustenance of the people. The various periods that were determined by the investigations have been named Galt, which is that of the historic Cherokee; Brewster and Lamar, which may represent occupations by the Creeks; Savannah and Etowah, which probably are attributable to the same Muskogean stock but which have not yet been identified so far as the specific tribes are concerned; and the Woodstock, which still remains to be correlated with a definite group but which is significant because it was characterized by a fortified village with a circular double palisade and bastions. Fortified villages in this part of the country appeared at a much earlier date than in the Missouri Basin. The Woodstock is the first period where there is evidence for the growing of corn. The preceding period, which is identified by a distinctive type of stamped pottery decoration and indications that the people had become at least semisedentary, has been called the Cartersville. Preceding the Cartersville stage was one that has been called Acworth. It was represented by the remains of a village containing some 60 round structures of varying sizes, a number of storage and midden pits, and a few graves. Definite indications of Hopewellian influences were present in that horizon. Stone napkin-ring-type ear spools were found in a grave of that period. Graves were carefully prepared and bark was placed over and under the dead. The pottery was a plain, well-polished ware that preceded the introduction of stamped wares in the area. Preceding the Acworth was a period that is known as the Kellogg. It was characterized by a semisedentary hunting and gathering culture. There was considerable use of storage pits and a variety of acorns and nuts were recovered from them. It seems that the bow and arrow first appeared in the Allatoona region during that period. Prior to the Kellogg was a period represented only by a certain type of projectile point and scattered finds of potsherds from a fiber-tempered kind of pottery. That period has been designated Stallings because the points and potsherds are similar to those occurring on Stallings Island in the Savannah River farther east. The

oldest of the sequences, which tentatively has been designated Prepottery, preceded the Stallings. The Prepottery stage may represent several periods and cover a long duration of time. Throughout that stage the people made no pottery, did not have pipes, practiced no agriculture, and possibly had no houses. At least no evidence was found to indicate any type of structure. The economy probably was basically hunting and gathering and the main weapon may have been a javelin hurled with a spear thrower (Caldwell, 1948).

The University of Georgia dug one site in the Allatoona area and uncovered the remains of a square earth-covered structure. Rich midden deposits were found on the floor of the structure and in the surrounding area outside. Three levels were recognized in the refuse accumulations. They represented successive groups attributable to the Lamar, Savannah, and Etowah periods. Considerable information was obtained pertaining to the various pottery types for the different stages and the data make the ceramic picture for the area much clearer. Originally the site was thought to be one containing a mound. The excavations, however, showed that to be an erroneous idea as the feature that had been so identified turned out to be the remains of the large earth lodge with its associated midden deposits. The extensive and well-known Etowah Mounds lie some distance below the Allatoona Dam and were not involved in any of the work connected with the construction of the reservoir (Sears, 1950).

MOUND EXCAVATIONS

The excavation of large artificial mounds has not been attempted to any extent thus far. Projects of that nature require such large crews of workmen and so extensive a program of operations that it has not been possible to undertake that type of investigation with the funds available. Some digging has been done in mounds, however. At the Fort Gibson Reservoir on the Grand (Neosho) River near Waggoner, Okla., two mounds out of a group of six remained at the Norman site. Four of the mounds had been investigated by the University of Oklahoma several years prior to the starting of the River Basin Surveys. One of the two remaining mounds was the largest at the site and was connected to an adjacent low mound by a ramp. Small test excavations had been made in the low mound, but the large one was virtually intact. It represented a stage in cultural florescence in the southern United States about which very little is known, and it was thought that it might be comparable to the famous Spiro mounds located in an adjacent county, which were destroyed by treasure hunters about 20 years ago. For that reason thorough excavation of the remaining mounds and the surrounding village area had been recommended by the survey party that examined the site.

While the question of funds for doing the work was still under consideration, a University of Oklahoma summer field party went to the Norman site and found that nearly all the village area and all mounds with the exception of the largest double unit had been removed by the bulldozers of the construction contractor. Even the large double unit had been damaged. The western periphery of the large mound had been cut away and several feet of the smaller mound had been removed. With the assistance of the resident and district engineers of the Corps of Engineers, the University of Oklahoma was able to have the operations stopped until some archeological work could be done. The University of Oklahoma field party then proceeded to excavate portions of several house sites still remaining near the large mound. While this was under way cooperative arrangements were made between the River Basin Surveys and the University of Oklahoma whereby excavations were started in the large double mound.

The initial digging consisted of cutting a trench across the saddle between the two parts of the unit. The side of the trench toward the larger mound was then carried forward with the purpose of removing the entire mound by cutting a continuous vertical face. It soon became apparent, however, that time would not permit the use of such a technique and accordingly a 10-foot trench was driven through the north-south axis of the mound in order to reach its base and to obtain a complete profile of the structure. Contrary to previous ideas concerning the mound, it yielded very few specimens. It was learned, however, that its main portion was composed of six superimposed platforms, which must have been the placements for public buildings. No complete post-hole patterns were discovered on any of the platform levels, however. The top of the fifth stage above the base showed that it had been divided into two nearly equal areas by a single row of posts and there was evidence of a severe conflagration which undoubtedly had taken place in pre-Columbian times. The top level contained the remnants of four human burials. The bones were in such an advanced stage of decomposition, however, that little remained to indicate their character or the form of burial that had been followed. The top level also contained a number of glass beads which presumably indicate a historic contact during the final days of the occupation of the adjacent village. The information contained in the mound is not of particular significance in itself but when added to that obtained by earlier work at the site rounds out the body of data for the area. At the present time the top of the large mound is the only part of the Norman site that may be seen above the waters of the Fort Gibson Reservoir.

Test excavations were made in two mounds in the area to be flooded by the proposed Buford Reservoir on the Chattahoochee River in

Georgia. Both mounds were unrecorded previous to the survey made in that area. One of them gave evidence of having been erected over a small natural knoll. On its summit were the outlines of a small square house in which there had been a bench or throne at one end. The mound appears to represent a rather late and previously unknown complex which is pre-Lamar in age. The Lamar culture is considered to belong to the Temple Mound II period which is dated at approximately A. D. 1450 to 1700. Lamar is correlated with the Creek-Cherokee peoples and it may well be that the group building that particular mound were proto-Creeks.

The other mound in the Buford Reservoir may possibly be one of the oldest artificial structures thus far discovered in Georgia. Contrary to other known mounds, it apparently was not intended for burial purposes and was not accretional; that is, it was not produced by the gradual accumulation of debris over a large, continuously inhabited area. Furthermore, it does not seem to have been intended as a place for domiciliary structures or for a temple platform. All the evidence thus far tends to show that the mound probably belongs in the Forsyth Period which in the general category of southeastern cultures is known as Burial Mound I. The latter period is postulated as having occurred from A. D. 700 to 900. As far as the present mound is concerned, one explanation is that it may have been erected for ceremonial purposes even though there was no structure on its summit or the structure was so flimsy that no traces of it remained. A simple earthen platform without any form of temple on its summit would be the logical beginning for the development of that particular complex.

SMALL BURIAL MOUNDS

Some work was done in small burial mounds. Two of the latter were dug at the Wheeler Bridge mound site in the Fort Randall Reservoir area. In one of them there were 12 bundle burials, while the other contained two or possibly three of the same type. Inasmuch as there were no funerary offerings accompanying any of the burials and other material in the mounds was scarce, there was nothing to indicate possible cultural relationships for the remains. Mounds of such type are exceedingly rare along the Missouri River itself but occur in increasing numbers farther east, particularly in the James and other lesser stream valleys. The Wheeler Bridge mounds had been greatly reduced in size as the result of long cultivation. They were approximately 40 to 50 feet in diameter with circular outline and rose to a height of about 4 feet. Below each was a rectangular pit, which had been dug into the underlying surface and the disarticulated bones of several individuals were found in them. The larger mound had the suggestion of a prepared clay floor, and the pit con-

taining the bones had been covered with logs. An interesting feature in connection with the leg and arm bones of one of the bundle burials was the presence of perforations near one end. Such treatment of bones had not previously been reported from the upper Missouri and Great Plains region. Not all the individuals represented by the bones from the mounds had been buried in the pits; some presumably had been placed there later. The village where the people who built the burial mounds lived was not located (Cooper, 1949, pp. 309-310).

The University of North Dakota working in cooperation with the North Dakota State Historical Society excavated two burial mounds on the east bluff overlooking the left bank of the Sheyenne River in the Baldhill Reservoir area in North Dakota. Both mounds were roughly circular in outline and approximately 100 feet in diameter. They sloped gradually to a truncated conical shape. They were built almost entirely of top soil and rose to a height of 6 to 7 feet. Both had had a central rectangular-shaped pit roofed with oak logs and containing masses of disarticulated human bones. This feature was similar to the Wheeler Bridge mounds. In addition, in one of them there was a second and shallower grave pit adjacent to the main chamber. The second had not been covered with timbers. It contained four more or less articulated and well-preserved adult skeletons and fragments from at least two infant skeletons. The four individuals apparently were buried simultaneously and the infants may also have been a part of the same interment. In the other mound were the remains of a burial that probably was placed there long after the mound had been built. The latter represented a different culture group (Hewes, 1949).

Artifacts were not numerous in either of the two mounds, and they are of little help in determining the culture represented. One or two interesting items were found, however. One of them was a fragment from the alveolar portion of a human mandible which was ground flat at the level of the midpoint of the tooth roots. Several teeth from which the roots had been ground were found nearby. At a lower depth a complete upper dental arch and palate, made from a human maxilla, carefully cut and ground down, was recovered. The object closely resembles an artificial upper plate. What the purpose of such altered human jawbones may have been has not been determined, but they evidently served some specific function or the time and trouble necessary to make them would not have been spent. It is difficult to believe that the "upper" could have been intended as a denture, but such may have been the case. Some toothless Indian in desperation might have tried to do what European dentists of the period found a difficult task. Many of the bones from the burial pits were covered with red ocher, which probably was applied at the time they were placed there and is a good indication that secondary

burial was practiced. In general the Baldhill mounds show considerable similarity to those in that portion of North Dakota, in northern Minnesota, and in southern Manitoba. All probably belong to the same cultural complex. The actual people involved have not been identified as yet.

Burial in mounds was not the only form of interment practiced by the aborigines. One interesting form of cemetery, which has been designated "shell bead ossuary" because of the large number of beads made from fresh-water and marine shells used as mortuary offerings, appears to center in the Republican River drainage in south-central Nebraska. One such feature was excavated in the Harlan County Reservoir area by a River Basin Surveys party. The site was complex, for originally a series of pits had apparently been dug to receive individual or small groups of burials. Subsequently a large oval basin was excavated in the same area, destroying all but the bottom portions of the older pits. A large series of secondary burials was then placed in the basin. The human remains were disarticulated and scattered, with little regard for orderly arrangement, over the floor of the basin. They were not what is known as bundle burials. It is possible that the small individual pits may have been the primary depositories for remains that were later exhumed and placed in the basin, but such was not established by the evidence. The smaller pits may have had some other function. At various places in the basin there were indications that considerable burning had occurred and layers of charred twigs and timbers apparently separated the human remains. Some of the human bones and shell beads that were abundant in the fill were charred. Whether this indicates that there was some cremation or is attributable to other reasons is not clear. Since the burials were secondary and all the soft parts of the body presumably had disappeared prior to the placing of the bones there, it seems strange that an attempt at cremation would have been made. On the other hand, there is the possibility that some of the bodies had not been exposed sufficiently long to lose all the skin and flesh and that some attempt was made to remove it before the pit burial was completed. One other suggestion is that scaffold burials may have been damaged by prairie fires or had collapsed and subsequently were burned and when the bones were gathered up and placed in the pit charcoal from the timbers and grass was thrown in along with the bones. An interesting number of problems have been raised, and further work in such ossuaries will no doubt solve some of them.

In addition to the secondary burials in the basin, there was one fully articulated individual that unquestionably represented a flesh burial. It was in the deeper part of the basin and may have been one of the original undisturbed interments. The person was an adolescent and



1. Excavating a hunting-culture camp site at the Angostura project in South Dakota. The dam under construction in the background has since been completed, and the area is now flooded.



2. Digging at an early site in the Angostura Basin. It was from this location that charcoal which dated 7073 ± 300 years by the carbon-14 method was obtained.



1. The deep site on Lime Creek, Nebraska, where the remains of an early hunting culture were found. The workmen are digging at the occupation level.



2. One of the sites in the Tiber Reservoir area in Montana where manifestations of an early hunting culture occur.



1. Excavating in the mouth of Birdshhead Cave in the Boysen Reservoir, Wyoming. The basin seen in the background will eventually be flooded.



2. Starting excavations at the Terminus Reservoir in California. The locations of the house pits are shown by the dark circles on the surface of the ground.



1. Uncovering house floors at the Medicine Creek Reservoir in western Nebraska. The highway patrol, which was used to strip off the overburden, may be seen to the left of the lower house.



2. View showing both rectangular and circular house-floor patterns in the remains of a village in the Oahe Reservoir in South Dakota.



1. One of the village sites in the Allatoona Reservoir Area in Georgia. This gave evidence of numerous structures which were built there at different times. Most of the large structures were circular but a few small rectangular ones were also discovered.

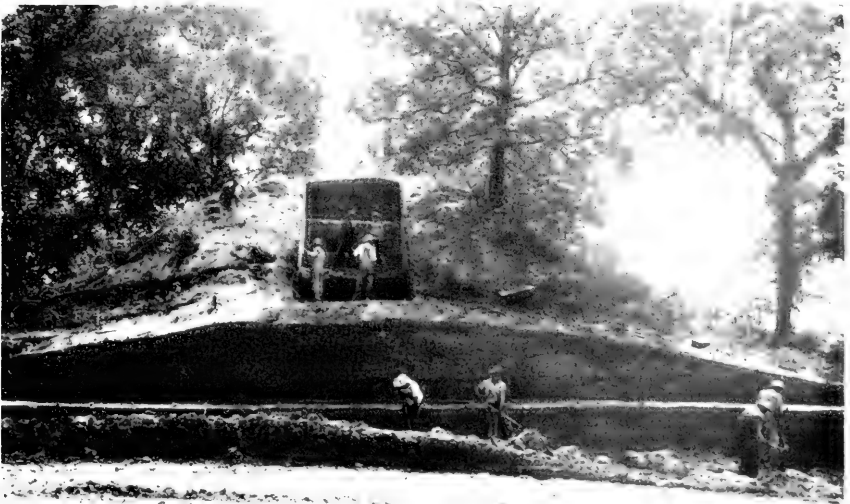

2. Starting the trench through the large mound at the Norman site in the Fort Gibson Reservoir, Oklahoma.



1. Skeleton with strings of beads found in an ossuary in the Harlan County Reservoir area, Nebraska.



2. Tracing pictographs at the Terminus Reservoir in California.



2. Series of pictographs in the Boysen Reservoir, Wyoming.



2. Using the bulldozer to remove the overburden from one of the sites in the Angostura Reservoir. The cultural layer may be seen in the wall of the trench in the right foreground.



Paleontologists removing a fossil turtle at the Boysen Reservoir, Wyoming. The specimen has been jacketed to permit handling without damage.

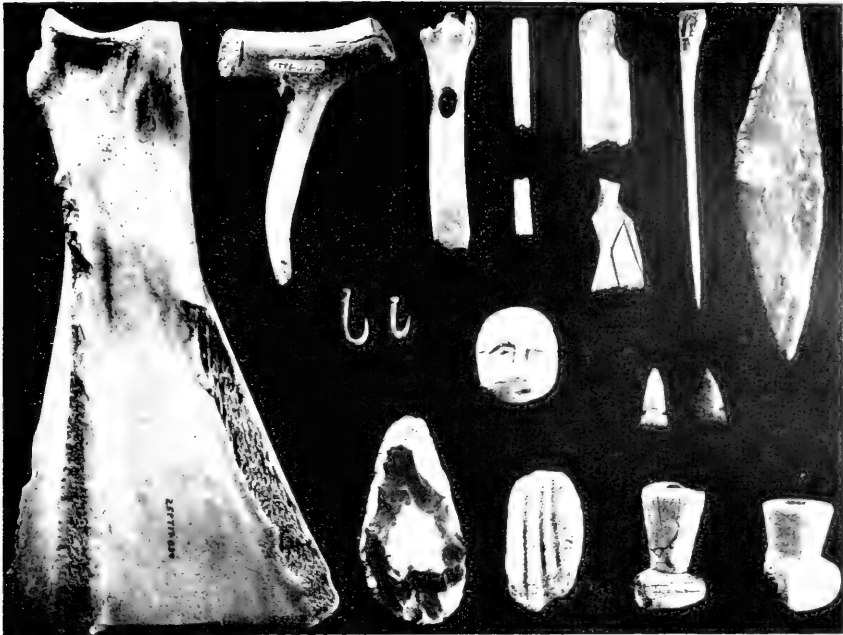

1. Artifacts found at a village site in the Medicine Creek Reservoir, Nebraska. These include bone implements, bone fishhooks, arrowheads, carved bones, and the bowls of stone pipes.



2. Pottery vessels of several characteristic forms manufactured by the pre-Columbian inhabitants of southern Virginia. In addition to those for general use, miniature forms were also made.



Bone and stone artifacts from the Buggs Island Reservoir in Virginia.

the skeleton was semiflexed, lying on its left side. Rows of shell-disk beads in alignment were around the skeleton in the pelvic area. Other rows extended up the chest and around the neck. Many of the rows consisted of beads that were well ground and evenly matched, while others contained blanks that had been perforated and strung but had not been given the final smoothing that is typical of a finished bead. Triangular shell pendants were found in the vicinity of the skull. In addition to the shell-disk beads there were worked sections from marine shells. The skeleton was removed intact in a plaster cast and has been prepared as a special exhibit of one form of burial. As far as could be determined from the scattered bones, at least 61 individuals had been placed in the basin and pits. Artifacts associated with the bones suggest that the people belonged to an early variant of the Woodland culture.

In the McNary Reservoir basin on the Columbia River two cemeteries adjacent to village sites were investigated. At one of them 50 graves were found, while at the other three were 17, as well as traces of some cremations. At the large cemetery the bodies of many of the adults were placed in plank cists, a feature that is more or less typical of the recent Plateau culture. Funerary offerings accompanying the skeletons consisted of both native artifacts and white trade goods. The presence of Colonial uniform buttons made as early as 1750 and the absence of firearms used in that area beginning in 1811 indicate that the plank cists probably fall within a period slightly after 1750 and prior to 1810. A single burial complex apparently is represented by the cemetery. The skeletal material is important because thus far sufficient remains for a study of the physical characteristics of the people living there have not been available. Furthermore, since the bones represent a single closely dated sample, they are particularly useful. In all, 57 individuals are represented by the bones from the 50 graves. Thirty-seven are adults, while the remainder are children and infants. There is not sufficient knowledge of the physical characteristics of the people of the area to permit tribal identification, but it seems certain that they belong to one of the middle Columbia Sahaptin groups. The skulls all show artificial cranial deformation. In some cases the deformation is only a flattening of the occiput, while in others the deformation is of the fronto-vertico-occipital variety. It is interesting to note that the latter occurs more frequently on the female skulls than on the male and that the female skulls are more highly deformed. A few pathological changes are indicated by the skeletons but they are confined for the most part to middle-aged or older individuals. The chief ailment from which the people appear to have suffered was of an arthritic nature. Most of the adults show considerable wearing away of the teeth but dental caries were not

common and when they were present apparently were due to the exposure of the tooth pulp through the grinding off of the enamel from the molar surfaces. Studies of the remains of the 17 individuals from the other cemetery have not been completed, but in the main they should show much the same features as the others.

Higher up the Columbia River at many village locations the main form of burial appears to have been in rock cairns. A large number of the latter were examined in several reservoir areas, but in virtually every case it was found that they had been disturbed by curio hunters and little remained of the contents. Funerary offerings had been removed and the bones scattered and broken so that they are of no value for study purposes.

At the Buggs Island Reservoir on the Roanoke River in southern Virginia a relatively large number of burials were found at two sites. The burials were not in what might properly be termed cemeteries but were scattered in and around the village areas. In some cases they were in refuse middens; in others they were found beneath floors of the houses. At one of the sites just east of Clarksville, Va., 77 burials with accompanying artifacts were exhumed. At another on Occaneechi Island not far from Clarksville 44 were found. The latter were interesting because not only were there examples of practically all forms of body placement ranging from the fully flexed to the extended, but in addition there was evidence of partial cremations. At the Occaneechi Island site a number of burials had turtle carapaces as funerary offerings. In that connection it has been suggested that they may have had totemic significance and indicated that the owners had been members of the turtle clan. If such a postulation is correct, that is the first definite evidence for attempts to designate clan affiliations in the Southeast. Study of the bones has not been completed but enough has been done on them to show that useful data will be forthcoming and that they will provide an excellent source of information on the physical types of the people living in that area in pre-Colonial times.

HISTORIC SITES

In comparison with investigations at aboriginal locations, work in historic sites was not extensive. At the Whitney Reservoir in Texas, however, studies were made at the Towash Village, the remains of an early white settlement on the Brazos River dating from the 1840's to recent times. The first dam and bridge on the Brazos River were located there, and their ruins, as well as those of the old stone store and church, were still to be seen. Measurements and photographs were taken in order to make scale drawings of the buildings. The location and general nature of the other structures pertaining to the community

were also determined, and a fairly complete record will be available for future reference. The Towash Village, as previously mentioned, was not far from the Stansbury site, a historic Indian village which also was excavated. Another historic site studied in the Whitney Reservoir basin was that of Fort Graham, a frontier post dating 1849 to 1854. The outlines of one of the buildings, as well as several other features, were located, and it was determined that the "Village of the Caddoes," which was visited by Carl Ferdinand von Roemer, the German geologist, in 1846, also had been situated there.

The Falcon Reservoir area on the Rio Grande below the village of Falcon in Starr County, Tex., contains a large variety of both historic and aboriginal sites. The historic sites, consisting of the ruins of missions, ranches, and small villages, are attributable to the Spanish, Mexican, Republic of Texas, and American periods. Some preliminary digging was done in Spanish-Mexican colonial remains, both by the University of Texas as a cooperative project with the National Park Service and by a party from the River Basin Surveys. Local tradition contains little or no information about most of the sites and no mention is made of them in the better-known histories of the area. The archives in Mexico City or perhaps in Spain may contain documents bearing on the colonial communities which once thrived there, but their former existence presumably was not known until they were found by survey parties. Preliminary digging has shown that at some of the colonial sites aboriginal and European sections of the community existed side by side but remained distinct, while in others the Indian and white groups intermingled and materials from the different cultures are mixed. Much-merited additional work in the area would undoubtedly add greatly to the knowledge of the Spanish Southwest and also would throw needed light on some acculturation problems.

Excavations in historic sites in the Missouri Basin have been confined mainly to frontier army and trading posts. In the Fort Randall Reservoir area in South Dakota digging was done at the site of Fort Hale on the west side of the river some distance above the present town of Chamberlain. Fort Hale probably was occupied during the 1870's. At that location evidence was found of a large building that probably had been a trading post and two smaller buildings that may have been part of the military establishment, and there were traces of a stockade. There also was evidence for an earlier Indian settlement. In the same general area but about 4 miles downstream on the same side of the river was the site of former Fort Lookout, which was both a military and a trading post. Work there revealed the fact that not only was it the site of Fort Lookout but that it also was the location for the earlier Fort Kiowa. Fort Kiowa was established in 1822 and abandoned in June 1825. Archeological evidence indicated that its abandonment

may well have been due to the results of fire as some of the structures unquestionably had burned. Fort Lookout was established at the same place in November of 1825, although the new post was erected several hundred feet northeast from the remains of Fort Kiowa, and was occupied until 1834, when it was abandoned. It was reoccupied 6 years later and again abandoned in 1843. Whether it was built at the same time as the new fort or somewhat later is not now known, but the trading post was placed over the ruins of a portion of Fort Kiowa. The post was discontinued when the fort was abandoned, but the American Fur Co. revived it in 1846 and continued to operate it until 1851. Digging at the site showed that the location also had been favored by the Indians. At some time previous to the historic occupation a group having affiliations with the Upper Republican culture lived there, and considerably before their tenancy other Indians with a variant form of Woodland culture had chosen the spot for one of their villages. Objects recovered during the digging include specimens of the handiwork of both whites and Indians and the results of their analysis will give an interesting story of changing cultural materials over a relatively long period of time.

About 8 miles farther downstream is the location of Lower Fort Brulé. The latter was occupied 1870 to 1884. The remains of a 2-unit structure connected by a breezeway were uncovered there, and an 18-by 12-foot cellar was cleaned of its accumulated debris. From the latter a large earthenware crock and specimens of metal were recovered. In addition, an abandoned well was excavated, and the refuse from it was found to contain some 30 "snow snakes." Some of the latter had realistic designs scratched into their surfaces, while on others the decoration was geometric in form. "Snow snakes" usually were made from the rib bones of bison and were used by the Indians in playing a rather simple game. The players would slide the objects along the frozen crust or in a rut in the snow. The main purpose was to see which of the "snakes" would come nearest to a line marked across the course or which would attain the greatest distance. Numerous objects attributable to the white occupation of the site were also found there.

Farther north along the Missouri River at the Garrison Reservoir in North Dakota digging was done at the site of Fort Stevenson. The latter was a typical Missouri River frontier post and was built both to keep the Missouri River open for navigation and to protect the Fort Berthold Indians from the Sioux. In addition, the post served as one of the main points on the overland mail route which ran from St. Paul to Montana. Although the fort was started in 1867 and was completed late in 1868 and there are considerable documentary data about it, useful new information pertinent to the actual character of

the post and certain Indian relationships was obtained in the course of the work.

While no actual digging has been attempted there as yet, the remains of Fort Charlotte were located in the Clark Hill Reservoir area along the Savannah River in South Carolina. Plans call for digging at that site. Fort Charlotte was built in 1765 as one of the Colonial defenses against the Cherokee Indians. South Carolina troops seized it on July 12, 1775, and it continued to be occupied by Colonial troops until the close of the Revolutionary War. An excavation program was planned for the site because there is lack of accurate information about the true nature of the fort and also because certain phases of its history correlate with Indian activities in that area. Materials obtained there should correlate with those from late aboriginal sites in Georgia and should provide useful information about the early Colonial influence on the native cultures.

As the program as a whole progresses, there undoubtedly will be investigations of comparable remains in other reservoir areas, but the historic aspects probably will never loom as large as those pertaining to the aboriginal peoples.

Petroglyphs and rock paintings are found in many of the areas that will be inundated. Particularly fine examples occur along the Columbia River and in the canyons of its tributaries. Various localities in California have interesting examples of that form of aboriginal art and there are numerous locations in the Missouri Basin that have their characteristic symbols. In some cases the designs and life-form figures were cut or pecked into the faces of cliffs and large boulders, while in others they were painted on the flat surfaces of the rocks. The recording of such examples of aboriginal work constitutes one of the tasks of preserving information about the Indians, and a number of methods were employed. In most cases the petroglyphs and rock paintings were photographed both in black and white and in color. Scale drawings were also made and, where possible, tracings were taken from the larger and more complicated groups of figures. In a vast majority of cases the pictographs probably have no particular meaning but an occasional symbol may represent a particular deity or refer to some specific legendary character. When studies have been completed on the mass of such material being collected, there should be better understanding of the significance of the pictographs and rock paintings.

NEW ARCHEOLOGICAL TECHNIQUES

During the progress of the surveys and excavations under the River Basin Surveys' program a number of new techniques have been developed. The most important, perhaps, from the standpoint of excavation, is the use of heavy equipment for the removal of overburden

from buried cultural layers. When digging was started at the Medicine Creek sites in western Nebraska the time available for recovering the archeological material was so short that it was deemed necessary to take rather drastic steps. As a consequence, even though mechanical aids are generally frowned upon by archeologists, bulldozers and highway-grading machinery lent by the Bureau of Reclamation were used to strip the sod and other cover from entire sites. As a result, it was possible to observe the complete village plan, to study village patterns, and to discover small features not readily determinable when the usual hand-labor methods were employed. The results at Medicine Creek demonstrated the practicability and effectiveness of heavy equipment in uncovering archeological materials with a minimum of breakage, and wherever possible the use of such machinery was extended to other projects. Bulldozers were employed in some of the digging at the Angostura and Oahe Reservoirs in South Dakota and at the Falcon and Lavon Reservoirs in Texas. Highway patrols were found to be very satisfactory in the Tenkiller Ferry Reservoir in Oklahoma as well as at the Medicine Creek sites. When the overburden is removed from a site by such means, a small crew of laborers can accomplish in a few short weeks what under older methods of excavation would require many months of effort. Furthermore, when a village area is uncovered in that way, much more is revealed than when the work is done by hand labor. In the Southeast, however, because of differences in the soil and conditions of greater moisture, heavy equipment has not fulfilled the requirements. In most cases it tends to crush the underlying material or to bog down.

PALEONTOLOGICAL STUDIES

Paleontological investigations have not played as large a part as those of an archeological nature in the River Basin Surveys' program for two reasons. In the first place, bone deposits are not restricted to the banks of streams and in many cases similar material may be found at locations which will not be flooded by the reservoirs. Secondly, such deposits as are exposed in reservoir basins are not as extensive or as numerous as the camp and village remains left by the Indians. Consequently, they do not call for as much work. The paleontologist as a rule does not sit down and spend long periods digging at a single bone bed but generally moves about from outcrop to outcrop to see what has been exposed by erosion and if the prospects seem good does some collecting. In the course of several seasons' work, he may revisit the same locality a number of times, spending only short periods in digging. In the present program, paleontological and geological studies have been carried on in a large number of reservoir basins throughout the Missouri drainage and at several

in Texas. While not spectacular in the main, the results obtained have been quite satisfactory.

In the Missouri Basin the paleontological parties have devoted considerable time to the Cretaceous and Tertiary deposits. In Lewis and Clark and Broadwater Counties in Montana where the Tertiary stratigraphy was imperfectly known from the time of its discovery in 1904 by the late Dr. Earl Douglass, the River Basin Surveys' work definitely established the presence of Lower and Middle Oligocene and Lower and Middle Miocene in the area. In North Dakota it was shown that the Cannonball Marine member of the Fort Union formation has a much greater areal distribution than previously supposed. Investigations of the Eocene deposits in the Big Horn basin in Wyoming produced evidence that confirmed previous conclusions of members of the United States Geological Survey who mapped the structure and stratigraphy of that area. Specimens collected there, although for the most part rather fragmentary, were sufficiently well preserved to establish the age of those beds as belonging to the Lost Cabin faunal zone of the Lower Eocene, a fact that had not previously been demonstrated. In the material obtained is the most nearly complete skull yet found of the primitive insectivore *Didelphodus*. Specimens collected from the Oligocene deposits in Montana consist principally of marsupials, insectivores, rodents, and small artiodactyls. One of the insectivores was found to belong to a problematical family that previously was not known in deposits later than the Upper Eocene. Furthermore, the specimen is the best preserved yet collected and adds many details of the skull and dentition to the knowledge of that group. The material obtained from the Miocene deposits consists of large oreodonts, beavers, rabbits, and small rodents. Collecting in the Upper Cretaceous Pierre shale provided specimens of complete fish, *Thrissopater*; turtles, *Archelon*; and mosasaur skulls.

Paleontological studies outside the Missouri Basin were confined chiefly to the Garza-Little Elm and Lavon Reservoirs on the Trinity River. The material from the Lavon area came mainly from the Upper Cretaceous deposits and consisted of a small mosasaur (unident) skull and the skull of a large mosasaur (*Tylosaurus?*). At the Garza-Little Elm project a small Pleistocene fauna was collected from a borrow pit near the west end of the dam. Included in the material are bison, horse, gopher, and aquatic turtle.

The University of Nebraska State Museum carried on cooperative paleontological work from the beginning of the interagency program. Considerable collecting was done in the area of the Harlan County Dam in southern Nebraska. Most of the attention of the Museum field parties was directed to the Pliocene deposits and a

good range of fossils was collected from them. Fish and reptilian remains from Cretaceous deposits were salvaged from the core trench of the dam and also from the borrow pits. The most valuable specimens, however, came from the Republican City Terrace fill and have proved to be of great assistance in terrace studies of that region. Several seasons were also spent working fossil quarries in the Medicine Creek Reservoir basin in western Nebraska. The deposits there were in the Upper Ogallala of the late Pliocene. Specimens collected consisted of the complete skull of a fossil beaver and bones of insectivores, carnivores, rhinoceroses, perissodactyls, artiodactyls, and rodents. Those forms reportedly represent the latest Pliocene assemblage found thus far in the Great Plains region and will be extremely helpful in establishing the boundary between the Pliocene and Pleistocene. Parties from the Nebraska State Museum have also visited reservoir sites in South Dakota and Wyoming and have been watching erosion areas in those districts for possible bone beds. The work of that institution has been particularly helpful to geologic studies in the Missouri Basin.

FUTURE OF THE WORK

Mention has been made of the fact that the Inter-Agency Salvage Program is shifting from mainly reconnaissance work to more excavation projects. The next few years should see an even greater trend in that direction. However, there are still areas where preliminary surveys will need to be made, and new reservoirs undoubtedly will be proposed from time to time and the basins involved will need to be investigated for archeological and paleontological manifestations. The next few years should see a marked acceleration in intensive excavation. In addition to numerous large village sites in the Missouri and Columbia Basins that should be dug, similar work will be required at some of the projects in California, Texas, Oklahoma, Arkansas, Mississippi, Georgia, and a number of States along the eastern seaboard.

The next step in the program following excavation is that of the publication of the results. This is perhaps the most important phase because it will make available to those interested in the subject the information obtained from the field researches. The third phase of the program is now getting started. Some of the detailed reports on work at specific sites are nearing completion and others will shortly follow. They should appear in print within the next year or two. Summary articles about the evidence found at some of the more significant sites in the Missouri and Columbia Basins, in California, Texas, Georgia, and Virginia, have already appeared in scientific journals and a series of papers constituting a Bulletin of the

Bureau of American Ethnology is being published. Various co-operating institutions have published reports on their investigations in bulletins issued by them.

REFERENCES

BLISS, WESLEY L.

1950. Birdshhead cave, a stratified site in Wind River Basin, Wyoming. *Amer. Antiq.*, vol. 15, No. 3, pp. 187-196.

CALDWELL, JOSEPH R.

1948. A preliminary report on excavations in the Allatoona Reservoir. *Early Georgia*, vol. 1, No. 1.

CHAMPE, JOHN L.

1949. White Cat Village. *Amer. Antiq.*, vol. 14, No. 4, pt. 1, pp. 285-292.

COOPER, PAUL L.

1949. Recent investigations in Fort Randall and Oahe Reservoirs, South Dakota. *Amer. Antiq.*, vol. 14, No. 4, pt. 1, pp. 300-310.

HEWES, GORDON W.

1949. Burial mounds in the Baldhill area, North Dakota. *Amer. Antiq.*, vol. 14, No. 4, pt. 1, pp. 322-328.

HOLDER, PRESTON, and WIKE, JOYCE.

1949. The Frontier Culture Complex, a preliminary report on a prehistoric hunters' camp in southwestern Nebraska. *Amer. Antiq.*, vol. 14, No. 4, pt. 1, pp. 260-266.

HURT, WESLEY R., Jr.

1951. Report of the investigation of the Swanson Site 39 Br 16, Brule County, South Dakota. *Archeol. Studies*, Circ. No. 3, The State Archeological Commission, Pierre, S. Dak.

KIVETT, MARVIN F.

1949. Archeological investigations in Medicine Creek Reservoir, Nebraska. *Amer. Antiq.*, vol. 14, No. 4, pt. 1, pp. 278-284.

MELEEN, E. E.

1949. A preliminary report on the Thomas Riggs village site. *Amer. Antiq.*, vol. 14, No. 4, pt. 1, pp. 310-321.

ROBERTS, F. H. H., Jr.,

1951. Radiocarbon dates and early man, pp. 20-22. *In* Radiocarbon dating, a report on the program to aid in the development of the method of dating. Assembled by Frederick Johnson. *Amer. Antiq.*, vol. 17, No. 1, pt. 2.

SCHULTZ, C. B., and FRANKFORTER, W. D.

1948. Preliminary reports on the Lime Creek sites: New evidence of early man in southwestern Nebraska. *Univ. Nebraska State Mus. Bull.*, vol. 3, No. 4, pt. 2, pp. 43-60.

1949. The Lime Creek sites. *Proc. 5th Plains Conference for Archeology*, pp. 132-134.

SEARS, WILLIAM H.

1950. Preliminary report on the excavation of an Etowah Valley Site. *Amer. Antiq.*, vol. 16, No. 2, pp. 137-142.

... ..

... ..

...

... ..

... ..

... ..

... ..

... ..

... ..

... ..

... ..

... ..

Artificial Lighting in America: 1830-1860

By C. MALCOLM WATKINS

Associate Curator, Division of Ethnology, United States National Museum

[With 8 plates]

THE THREE decades from 1830 to 1860 are of special significance in the history of artificial lighting in America. It was during this period that radical departures were made from tradition, and profuse invention paved the way to modern lighting. It was an era of trial and error, of the search for cheaper fuel and light. It bridged the gap between the primitive lamp and the mass-produced lighting device and ended with the adoption of the first refined petroleum fuel.

In its limited sphere this development reflected the larger design taking shape over the country as a whole. During these years traditional colonial patterns began to be disrupted by novel forces whose effects marked the emergence of modern America. Railroads, factories, cities, and population shifts were the outward indications, and causes as well, of enormous transformations. The boiling upsurge of the era impressed foreign visitors to America. Lady Emeline Stuart Wortley observed in 1850:

Everything in nature and art almost seems to flourish here. Schools, universities, manufactories, societies, institutions, appear spreading over the length and breadth of the land, and all seem on such a gigantic scale, too! Lakes, forests, rivers, electric telegraphs, hotels, conflagrations, inundations, rows, roads, accidents, tobacco, juleps, bowie knives, beards, pistols, &c.! moderation or littleness appear not to belong to America, where Nature herself leads the way and seems to abhor both, showing an example of leviathanism in everything, which the people appear well inclined to follow. [Wortley, 1851, p. 33.]

Frederika Bremer observed at about the same time that "to hurl mountains out of the way, to bore through them and build tunnels, to move hills into the water as a foundation for roads in places where this is necessary—all this the Americans regard as nothing at all. They have indeed the faith to move mountains." (Benson, 1924, p. 20.)

Dynamic innovation, however, was silhouetted against a background of enduring habit. Change, indeed, was as conspicuous in its absence as in its presence. The static feudal economy of the South, for exam-

ple, emphasized the opposing dynamics of the North's industrialism. Let the visiting stranger "pass into Virginia," wrote Alexander Mackay in 1847, "and the transition is as great as is the change from the activity of Lancashire, to the languor and inertness of Bavaria" (Mackay, 1849, p. 67). In New England, the Western Railroad, boldly conquering the barrier of the Berkshires, brought modern engineering techniques and industrial commerce to the very backyards of rural traditionalism. In Pennsylvania, Mennonite farmers lighted their houses with the medieval-style lamps of their Palatine ancestors, while a few miles away in Philadelphia the latest advances in household illumination were in daily use. At every hand there were evidences of two contrasting worlds.

In artificial lighting, generally, this duality was as apparent as in the larger picture. On the one hand were brilliant concentrations of gas light in theaters and music halls and museums. There were improved fuels and principles of combustion developed by scientific experiment in learned institutions. In urban homes new inventions made the household lamp a vivid contrast to its predecessors. On the other hand were steadfast marks of enduring habit, which only gradually were to yield to change and achievement. These were most evident in those places where isolation, poverty, and ignorance combined to exclude even the simplest improvements. On the frontier and in cultural backwaters the means for artificial lighting were little better than what had been available to aboriginal man. In some instances, indeed, these primitive circumstances have survived until recent times. There are persons living today who can recall seeing kitchen fat used in a saucer, with a rag for a wick, in backward sections of the country. Vance Randolph, in his study of the Ozarks, stated as late as 1931 (p. 27): "Not long ago, however, I visited a home in which the only artificial light was a 'slut'—simply a dish full of grease, with a twisted rag stuck in to serve as a wick." During the years we are considering, the Ohio settlers used crude open lamps of iron and pottery, and in parts of Alabama simple iron lamps were in use that reportedly still continue their function today.

This negative side of the characteristic duality of the period is best illustrated in remote parts of the deep South. In 1853 and 1854 Frederick Law Olmsted traveled through that region and recorded his impressions in valuable detail. Not even a "slut" was in evidence in the Tennessee slave cabin that he observed on a comparatively prosperous farm:

The negro cabins were small, dilapidated and dingy, the walls were not chinked, and there were no windows—which, indeed, would have been a superfluous luxury, for there were spaces of several inches between the logs, through which there was unobstructed vision. The furniture in the cabins was of the simplest and rudest imaginable kind, two or three beds with dirty clothing upon them, a

chest, a wooden stool or two, made with an axe, and some earthenware and cooking apparatus. Everything within the cabins was colored black by smoke . . . During the evening all the cabins were illuminated by great fires, and, looking into one of them, I saw a very picturesque family group; a man sat on the ground making a basket, a woman lounged on a chest in the chimney corner smoking a pipe, and a boy and two girls sat in a bed which had been drawn up opposite to her, completing the fireside circle. [Olmsted, 1907, p. 153.]

Such a setting was not restricted to Negroes, however. Allen Eaton, describing the early cabins of the Tennessee and North Carolina highlands (1937, p. 49) says: "The usual light for the interior of the house would be firelight from the hearth, supplemented in fair weather by daylight from the opened door or in rare cases from the so-called window." Olmsted, stopping at one meagerly furnished Alabama farmhouse, stated that his host went to bed immediately after supper and left him alone without a candle. Elsewhere, he found that candles were the usual source of light. Candlesticks to put them in, however, were apparently nonexistent. In an Alabama house of more than the usual appointments he sat in the well-furnished parlor, "alone in the evening, straining my eyes to read a wretchedly printed newspaper, till I was offered a bed . . . My host, holding a candle for me to undress by (there was no candlestick in the house), called to a boy on the outside to fasten the doors" (Olmsted, 1907, p. 188). This situation was repeated several times at subsequent stopping places. "The same Negro was called to serve me as a candlestick at bedtime. He held the candle until I got into bed," and later, "The master held a candle for me while I undressed."

Even in the rural areas of eastern Virginia, in places that had earlier known higher standards of luxury, there were instances of exactly similar conditions. Olmsted, in "A Journey in the Seaboard Slave States" (1856, pp. 77, 79, 85-86), described a remote farmhouse in the vicinity of Petersburg, where he spent the night: "It was a simple, two-story house, very much like those built by the wealthier class of people in New England villages, from fifty to a hundred years ago, except that the chimneys were carried up outside the walls." The large room on the first floor was wainscoted and had a carved mantelpiece. "The house had evidently been built for a family of some wealth, and, after having been deserted by them, had been bought at a bargain by the present resident, who either had not the capital or the inclination to furnish and occupy it appropriately." He was finally led to his bedroom to retire. He continues:

Into a large room, again, with six windows, with a fire-place, in which a few brands were smoking, with some wool spread thinly upon the floor in a corner; with a dozen small bundles of tobacco leaves; with a lady's saddle; with a deep feather-bed, covered with a bright patchwork quilt, on a maple bedstead, and without a single item of other furniture whatever. Mr. Newman asked if I wanted a candle to undress by, I said yes, if he pleased, and waited a moment

for him to set it down: as he did not do so I walked towards him, lifting my hand to take it. "No—I'll hold it," said he, and then I perceived that he had no candle-stick, but held the lean little dip in his hand: I remembered also that no candle had been brought into the "sitting-room," and that while we were at supper only one candle had stood upon the table, which had been immediately extinguished when we rose, the room being lighted only from the fire.

In these surroundings candles were, of course, homemade. In a one-room cabin in Tennessee Olmsted saw "bunches of candles [hanging] from the rafters" in the manner customary in New England farm kitchens of a century and more earlier.

Insufficiency of artificial light was not altogether confined to rural farms in the South, however. Olmsted, in the work just quoted (1856, pp. 334-336), recounts an amusing episode that occurred in a stagecoach inn at Fayetteville, N. C. It suggests that the absence of light may have been related in some cases to the general nature of things in the old South's economy and social organization, rather than to lack of access to the means of good light.

I followed the negro up to number eleven, which was a large back room, in the upper story, with four beds in it.

"Peter," said I, "I want a fire made here."

"Want a fire, sar?"

"Yes, I want you to make a fire."

"Want a fire, master, this time o' night?"

"Why, yes! I want a fire! Where are you going with the lamp?"

"Want a lamp, massa?"

"Want a lamp? Certainly, I do."

After about ten minutes, I heard a man splitting wood in the yard, and, in ten more, Peter brought in three sticks of green wood, and some chips; then, the little bed-lamp having burned out, he went into an adjoining room, where I heard him talking to some one, evidently awakened by his entrance to get a match; that failing, he went for another. By one o'clock, my fire was made.

"Peter," said I, "are you going to wait on me, while I stay here?"

"Yes, sar; I 'tends to dis room."

"Very well; take this, and when I leave, I'll give you another, if you take good care of me. Now, I want you to get me some water."

"I'll get you some water in de morning, sar."

"I want some to-night—some water and some towels; don't you think you can get them for me?"

"I reckon so, massa, if you wants 'em. Want 'em 'fore you go to bed?"

"Yes; and get another lamp."

"Want a lamp?"

"Yes, of course."

"Won't the fire do you?"

"No; bring a lamp. That one won't burn without filling; you need not try it." The water and the lamp came, after a long time.

The following evening, as it grew too cold to write in my room, I went down, and found Peter, and told him I wanted a fire again, and that he might get me a couple of candles. When he came up, he brought one of the little bed-lamps, with a capacity of oil for fifteen minutes' use. I sent him down again to the office, with a request to the proprietor that I might be furnished with

candles. He returned, and reported that there were no candles in the house.

"Then, get me a larger lamp."

"Ain't no larger lamps, nuther, sar;—none to spare."

"Then go out, and see if you can't buy me some candles, somewhere."

"Ain't no stores open, Sunday, massa, and I don't know where I can buy 'em."

"Then go down, and tell the bar-keeper, with my compliments, that I wish to write in my room, and I would be obliged to him if he would send me a light, of some sort; something that will last longer, and give more light, than these little lamps."

"He won't give you none, massa—not if you hab a fire. Can't you see by da light of da fire? When a gentleman hab a fire in his room, dey don't count he wants no more light 'n dat."

"Well, make the fire, and I'll go down and see about it."

As I reached the foot of the stairs, the bell rung, and I went in to tea. The tea-table was moderately well lighted with candles. I waited till the company had generally left it, and then said to one of the waiters:

"Here are two dimes: I want you to bring me, as soon as you can, two of these candles to number eleven; do you understand?"

"Yes, sar; I'll fotch 'em, sar."

And he did.

Most often, rude conditions in the South were attributable to geographical isolation, rather than other causes. In Pennsylvania, however, we find a different kind of isolation that likewise enforced the survival of primitive forms of lighting. This was the barrier of language, religion, and culture, all differing from that which prevailed elsewhere. There was a deep-seated traditionalism among the Pennsylvania Germans, which made the continued use of ancient forms of copper and iron crudies a congenial habit.

In Germany and Switzerland, at the time of the first German migrations to America, the prevailing lighting devices among the common people were either simple hanging lamps with slanting metal troughs to hold the wicks, or merely shallow pans for burning fat or lard. In Pennsylvania the former came to be called "betty" lamps, or "judies," or "kays," or "frog lamps." The latter, of Alpine origin, either hung from hooks or had elaborate wrought-iron standards, in which case the pans themselves took on a variety of shapes. From these prototypes the "Dutch" metalsmiths in America developed their own characteristic versions. In collections today there are many examples bearing the names of such Pennsylvania lamp makers as Peter Derr, Joseph S. Schmitz, J. Eby, Hurxthal & Co., or J. Boker. So solidly entrenched was the custom in Pennsylvania of using these ancient lamp forms that there are numerous instances of their employment late in the nineteenth century. Henry C. Mercer (1898, p. 7), indicating that the "betty" lamp had sometimes survived up to his day, gave the following directions for its use:

Thrust the point horizontally into a beam or catch the barb upon a hook, nail or log crevice, then filling the vessel with lard, light the twisted tow (later

cotton) wick, laid along the internal trough, so tilted as to allow the oil oozing from the flame to flow back into the vessel. By the light, brighter than a candle, work at the loom after dark or fry potatoes at night on the open fire, as David Getter still does (October 1897), in his log cabin in the hill country of Springfield township.

The "betty" lamp was to be found not only in Pennsylvania, but all along the course of German emigration. Among the Germans of Ohio it was probably as commonly used in the 1830-60 period as in Pennsylvania. A lamp in the United States National Museum collection of heating and lighting devices (No. 345938) is a typical Pennsylvania example but was used in Arkansas in the early days of the settlement. Other illustrations of the employment of these devices in the newly settled areas of the Midwest frequently occur.

In rural regions, not only in the South and West, but in isolated parts of the East as well, it is probable that candles more often held a foremost place. Made of tallow, they were sometimes dipped and sometimes cast in molds. Hough (1928, p. 18), stated:

In reality the molds represent a method of economy among our ancestors in that small amounts of fat could be worked up into candles with the molds when required. Generally on the plantations, where a great many candles were necessary, sufficient were made for the whole year by dipping, which was far more expeditious than by molds. Candle dipping was usually coincident with the butchering of the winter stores of meat, at which time much fat was accumulated.

Candle dipping was accomplished on a large scale by the use of revolving candle driers. These devices were especially popular in Pennsylvania, but they occurred elsewhere, as among the New England Shakers, where large quantities were produced at one time. They consisted in each instance of a series of horizontal spokes, like a rimless wheel, which revolved on an upright spindle supported on a waist-high stand. From the end of each spoke was suspended a wooden disk or square. On the bottom of this were numerous small hooks to which the candle wicks were tied. When the molten tallow or wax was prepared by heating it on the surface of a kettle of hot water, a disk was removed from the drier, the wicks were dipped in the tallow and withdrawn, and the disk hung back on the drier. The process was repeated with each drier. By the time the entire series had been dipped once, the first wicks were sufficiently hard to be dipped again. Thus, repeated coatings of tallow were allowed to accumulate until the candles reached the desired size.

Another simpler method of dipping was used in New England. Here, the wicks were suspended and dipped from long sticks or "broaches." Each stick, with a dozen or more wicks, was placed across a pair of long poles supported at the ends on the backs of two chairs. The wicks were then dipped successively and repeatedly as with the revolving drier (Earle, 1898, pp. 35-36). It was necessary, for the

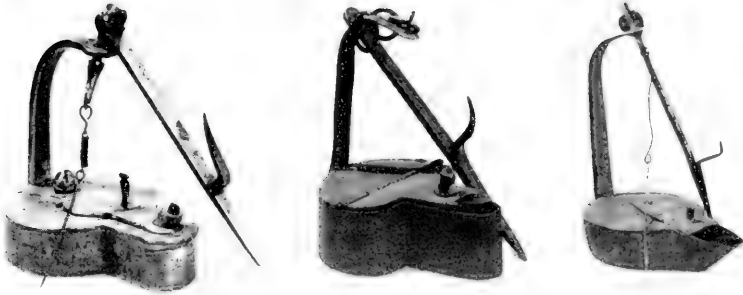

Three 19th-century iron "betty" lamps: *Left*, Stamped "E. Brown" and "1835," used in Washington, D. C. *Middle*, A typical Pennsylvania-style lamp of the midcentury, from Newkirk, Okla. *Right*, Lamp found in the stock of a Philadelphia hardware store in 1898. The harpoonlike hooks were hung on chair backs or from nails or thrust into chinks in fireplaces.

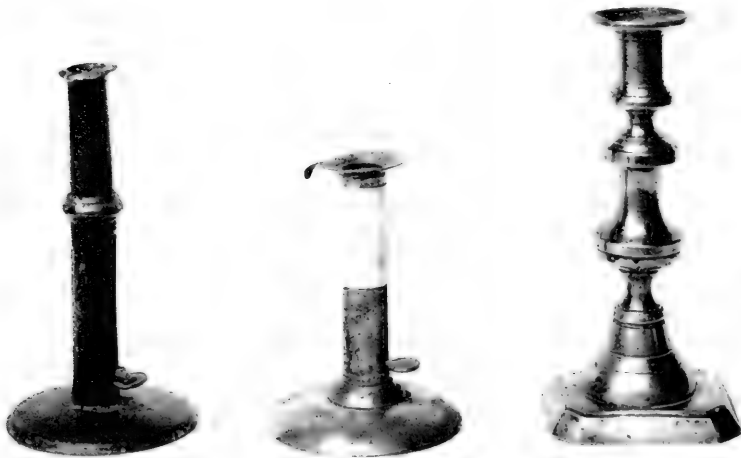

Left, Iron "hogscraper" candlestick of late 18th or early 19th century. The sharp-edged base was convenient for scraping bristles from newly slaughtered hogs. *Middle*, Patent model for "hogscraper" candlestick. Patented by Merriam, Harris, Wheeler & Merriam, of Poultney, Vt., in 1853. *Right*, Brass candlestick of style used about 1825-1840.

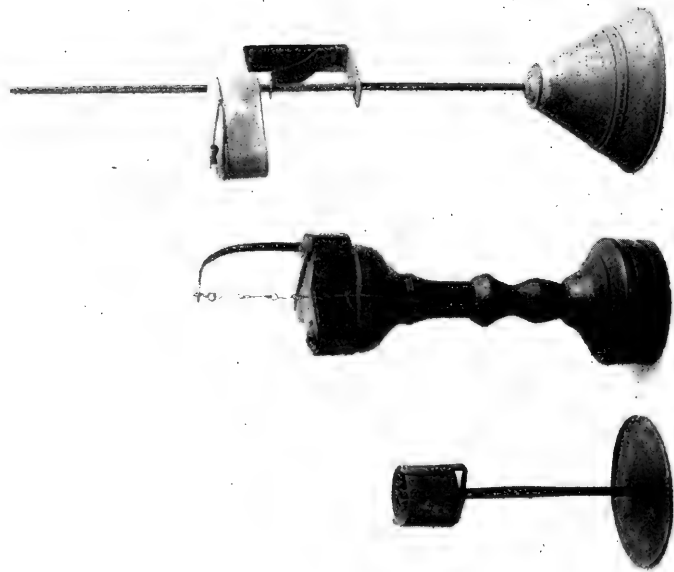

Mid-19th-century Pennsylvania lamps: *Left*, Iron lard lamp with swinging reservoir. *Middle*, Iron "betty" lamp on turned wooden stand, Bucks County. *Right*, Tin lamp designed to slide up and down on an iron rod mounted in a weighted base.

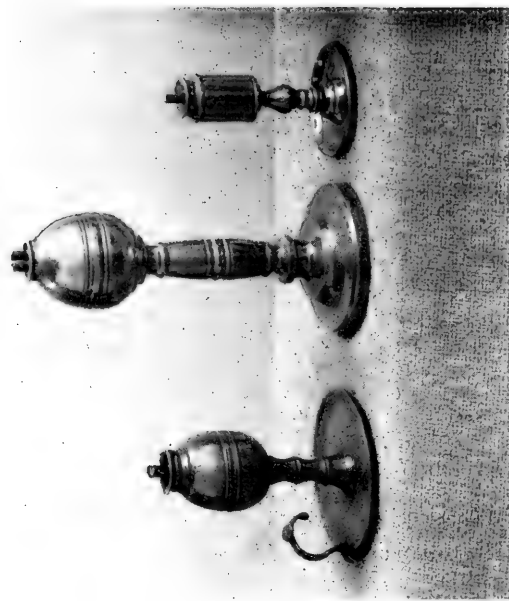

Brass whale-oil lamps of early 19th century (based on Miles's English patent of 1787 for an "agitator" lamp with enclosed reservoir): *Left*, Hand lamp, about 1800-1810. *Middle*, One of a pair of mantel lamps, about 1815-1825. *Right*, Chamber lamp.



Glass whale oil lamps with enclosed reservoirs and tight fitting burners, a series of American innovation. The earliest (like that shown at far right) were simple blown glass vessels. After the mechanical pressing of glass was introduced in 1826, lamps were made of pressed blown fonts and pressed bases. Second lamp from the left is from the Smithsonian about 1830; the others are somewhat later.



Glass lamps of about 1830-1840. Left, Lamp of the Smithsonian, fitted with a stopper-type whale-oil burner. Middle, Fluid or camphene burner, probably made at Pittsburgh about 1830. Right, Whale-oil lamp with pewter screw-type whale-oil burner.

R. W.

M. I.

R. W.

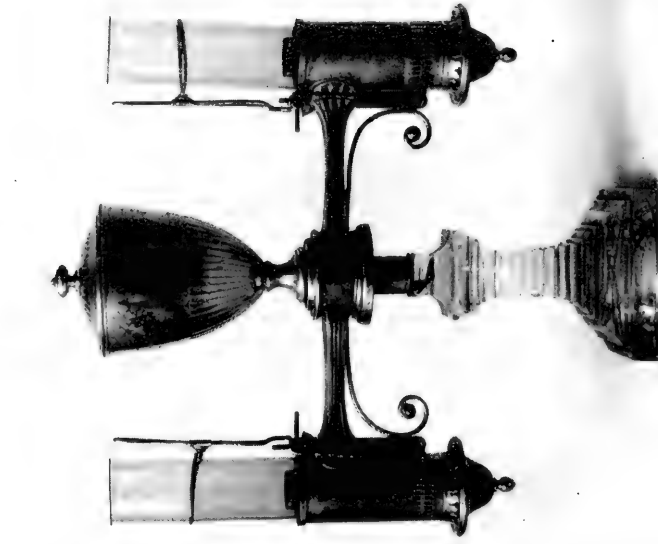

Silver Argand lamp, mounted on cut-glass base, originally owned by George Washington. The oil supply was held in central reservoir and fed to burners through the bracket arms. Air was admitted through slots at base of each burner case. Glass chimneys, an innovation of Argand's, increased the draft.

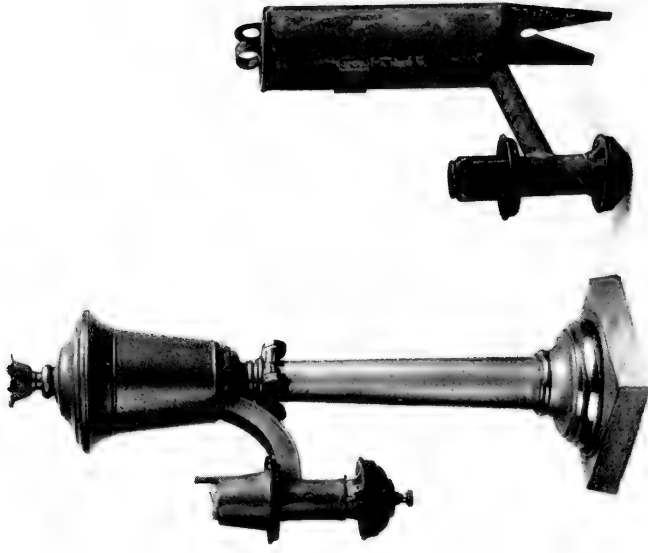

Two versions of the Argand lamp: *Left*, Patent model of Argand lamp designed to burn lard oil (patented by C. Wilhelm, April 6, 1843); glass chimney not shown. *Right*, Tin wall-type for common use; glass chimney and tin reflector missing. Early 19th century.



Three astral, or "sinumbra," lamps. These embody the Argand burner in combination with ring-shaped reservoirs (shown at right), designed to minimize amount of shadow. They were used with chimneys and glass shades of varying shapes, of which the one at left is most typical. American, about 1830-1840.

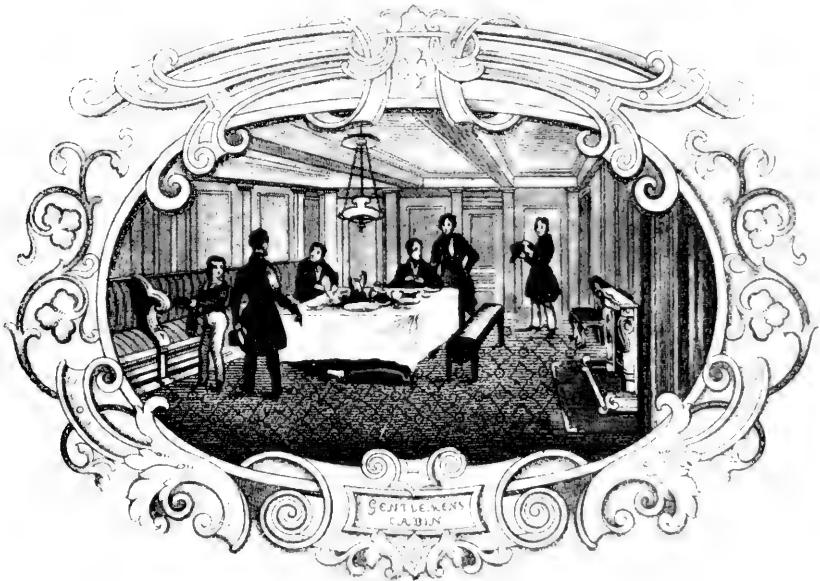

Transfer-printed scene from Staffordshire platter of the "Boston Mails Series," made by J. and T. Edwards of Burslem in 1841. A suspension-type astral lamp hangs above the table in the "gentlemen's cabin." (Courtesy Mrs. Arthur M. Greenwood.)



"A New York Interior," by Alexander Lawrie, painted about 1850. This carefully factual portrayal of a parlor in a well-to-do New York home shows an astral lamp on the table between the windows. (Courtesy of The Old Print Shop, Inc.)



Four solar lamps. Usually designed to burn lard oil, these used a modified Argand burner with a device to shade the flame into a column of light. The shades were often globular, with engraved designs. The solar lamp was economical and efficient and was especially popular in the 1840's.



Three patent models of tin lard-burning lamps: *Left*, Harvey Temlinson's patent, Geneva N. Y., September 1, 1843, embodying an Argand burner with copper air tube. *Middle*, Zebulon Warroll's patent, Chester Hill, Ohio, February 7, 1842, depending upon gravity for flow of fuel, the heat from the flame warming the lard in the reservoir. *Right*, One of several patents by Robert Cornelius, of Philadelphia, this one dated April 6, 1843. A ribbon wick with copper conductor strip is the working principle.



Patent models illustrating inventive ingenuity: *Left*, Rosin lamp, with heater underneath to keep the rosin fluid, patented by Prentice Sargent, Newburyport, Mass., March 4, 1856. *Middle*, Lard lamp patented by Silas B. Terry, Plymouth, Conn., February 24, 1843. *Right*, Fluid vapor lamp patented by C. A. Green, Philadelphia, April 21, 1857. The small burner seen at right superheated the volatile fuel in the large burner, causing it to vaporize and burn as a gas.

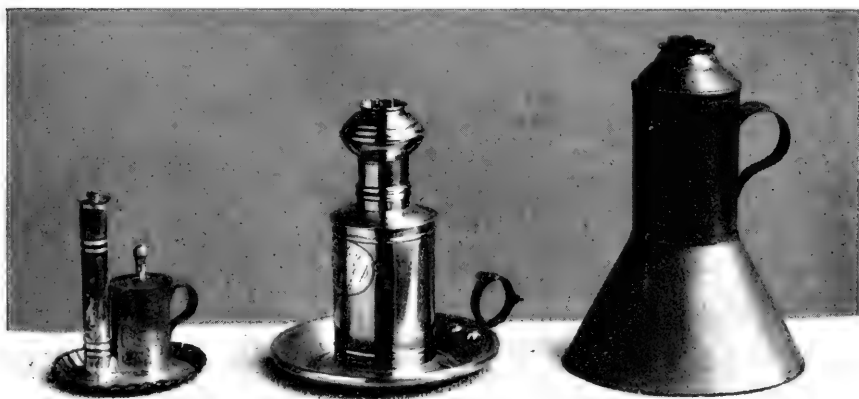

Patent models of lard lamps using pressure to feed fuel to wicks: *Left*, Tin lard lamp patented by John Grannis, Oberlin, Ohio, August 25, 1842. A plunger drives lard from secondary reservoir to primary reservoir and wick. *Middle*, Maltby and Neal's lard lamp patented by Benjamin K. Maltby, Rootstown, Ohio, May 4, 1842. The patented feature is a pair of perforated copper wick tubes to assure equal distribution of lard into wicks when pressure is applied, preventing wicks from being displaced. *Right*, Lard lamp patented by Thomas Sewell, New York, October 2, 1847. Turning the inner portion of the base forces the lard upward.

most satisfactory and economical performance, to allow the candles to dry and harden for many weeks. Bundles were suspended from the beams of the kitchen, as described by Olmsted above, or in the attic.

Candle molds were usually made of tin in a variety of sizes and combinations. Molds were easier to use, since fewer operations were involved. That they are to be found on each side of the Mississippi, in areas settled by people of both German and Anglo-Saxon stock, indicates that candles were used generally. Their continued use is attested by the fact that there were occasional inventions of candle molds during the period under discussion. In 1837 the following notice was given of a mold exhibited at the Mechanic's Fair in Boston:

E. Haywood, of Boston, has produced candle moulds, which open lengthwise, in halves, and can be curved or cast upon figured moulds, so as to yield spermaceti or wax candles of beautiful ornamented patterns. (*Boston Daily Sentinel and Gazette*, Sept. 25, 1837.)

It is apparent from this that not only the tallow candles of the rural areas but also the expensive spermaceti candles we usually associate with aristocratic eighteenth-century surroundings were still in fashion. Spermaceti is the crystalline wax from the head of the sperm whale and, though expensive, was unsurpassed as a candle illuminant.

Candlesticks ranged from crude holders of tin and iron, and even pottery, to those of pewter, brass, and silver. Elaborate electroplated examples with embossed designs were popular in "elegant" settings after 1850, while the turned types of brass sticks (essentially like their eighteenth-century predecessors, except for greater mass and less restraint) were for common use. Devices for expelling the stubs of candles were common by 1830. A popular barn and kitchen candlestick with a slide-style expeller was called a "hog-scraper" because of its sharp-edged base, adaptable to scraping bristles from newly slaughtered hogs. This remained in use throughout the century and within recent years has been sold by a large mail-order house with the candle socket omitted, its adopted function having become its primary purpose. The United States National Museum exhibits a heavy brass stick with internal expeller which is a patent model of 1840 (No. 251-722). The Franklin Institute commended an iron candlestick, exhibited in the 1832 Exhibition, as being one that "will compare with the English both in quality and price." It is significant that there were as many as 13 candlesticks patented between 1830 and 1860, as well as one design for snuffers.

In an apparently characteristic up-State New York farmhouse, brass candlesticks formed part of the decorative scheme in the best parlor. Susan Fenimore Cooper described this room in 1851 (*"A Lady,"* pp. 157-158):

It was both parlor and guest chamber at the same time. In one corner stood a maple bedstead, with a large, plump feather bed on it, and two tiny pillows in well-bleached cases at the head. The walls of the room were whitewashed, the wood-work was unpainted, but so thoroughly scoured, that it had acquired a sort of polish and oak color. Before the windows hung colored paper blinds. Between the windows was a table, and over it hung a small looking-glass, and a green and yellow drawing in water colors, the gift of a friend. On one side stood a cherry bureau. . . . The mantel-piece was ornamented with peacock's feathers, and brass candlesticks, bright as gold; in the fireplace were fresh sprigs of asparagus. An open cupboard stood on one side, containing the cups and saucers in neat array, a pretty salt cellar, with several pieces of cracked and broken crockery, of a superior quality, preserved for ornament rather than use.

But if we are to see the other side of the picture and observe the achievements of invention in lighting and that spirit of "leviathanism" which so impressed Lady Emmeline Stuart Wortley, we must remain in the cities and urbanized areas of the seaboard. Here important improvements had been introduced before the close of the eighteenth century, and some had been widely adopted in America. Contributing as much as any one individual to the development of lighting, a Swiss chemist, Ami Argand, in 1783 had invented the first lamp to be constructed on scientific principles of combustion. This embodied a hollow tube, open at both ends, which extended upward through the center of the burner. A cylindrical woven wick was fitted tightly around the tube, and an outer cylinder was placed around this. Oil from the reservoir was fed into the side of the cylindrical chamber containing the wick. The hollow tube in the center served to admit air to the center of the flame, thus increasing combustion and the amount of light as heat from the flame acted automatically to create a draft. The draft was further increased by the addition of a glass chimney. Argand is credited with the first practical use of the lamp chimney.

Well-to-do Americans, among them Washington and Jefferson, had installed Argand lamps before 1800, and after that year several modifications and adaptations of Argand's idea were adopted by city folk who could afford them. Their greatly superior light, amounting to as much as 9 candlepower, was considered revolutionary, as we shall see.

More significant from a cultural and economic standpoint, if not from a technological one, was the widespread adoption of an English weaver's invention, John Miles's "agitabile" lamp, patented in England in 1787. Although apparently but little concerned with scientific principle, Miles succeeded in designing an eminently simple device consisting of a container with a hole at the top into which a burner with one or more vertical wick tubes could be screwed or tightly fitted. Sperm oil or even common whale oil could be drawn up into the vertical wicks, and the stopper-type burners minimized the spilling

of oil. The symmetrical design permitted making handsome lamps of tin, pewter, brass, and glass, and their simplicity made them economical and easy to clean. The whaling industry, already well established, was able to provide the necessary fuel for these devices, particularly in the Northeast, their increasing popularity after 1800 having been a basic reason for the expansion of whaling. By 1830 the "common" or whale-oil lamp (as Miles's lamp came to be called) had become a standard household device in the East. A large part of the output of the glass factories in Pittsburgh, Sandwich, and Cambridge consisted of glass whale-oil lamps, while pewterers and tin-smiths welcomed the new form so admirably adapted to their skills. However, the light emitted from a whale-oil lamp with a single wick was not much greater than that of a candle. This lamp had a solid wick and rarely included a chimney. Its popular appeal was therefore attributable to economy, simplicity, and satisfactory appearance.

It is initially surprising that the most radical innovation of all, though introduced before 1830, was not widely accepted until after the Civil War. This was illuminating gas, first used for domestic lighting by David Melville, of Newport, R. I., in 1806. Although Melville's enthusiasm for gas light led him to install it in a nearby textile mill as well as in street lamps outside his house, it remained for a long time a novelty. As early as 1799 or 1800 one Mr. Henfry had demonstrated gas light in Baltimore, and in 1816 Rembrandt Peale used gas to light his museum in that city. So successful was it there that the first commercial installation of gas street lights was urged and adopted by the Baltimore citizenry within the following year. Except for street lighting in most of the larger cities, gas illumination was confined principally to theaters, museums, and other public gathering places. Elaborate technical requirements and installation problems remained as hurdles that were difficult to overcome. Gas lighting was still uncommon in 1843, when the Franklin Institute conducted experiments to prove its utility. It was concluded that gas could be credited with giving "bright and continuous light," cleanliness, and freedom from variation, smell, smoke, or care, yet "its disadvantage is that it is a fixed light, and can be used only at points previously determined upon" (*Journal*, 1843, ser. 3, vol. 5, p. 105).

The fixtures then used for gas ranged from simple brackets projecting from the wall to very elaborate chandeliers. The predominantly public use of gas during the 1830-60 period accounts largely for the latter, which are both illustrated and commented upon in contemporary literature. The Report on Lamp and Gas Fixtures in the 13th Annual Exhibit of the Franklin Institute in 1844 describes "the richly ornamented gas pendants and chandeliers finished in ormolu, the workmanship of which is exceedingly beautiful, the color faultless, and the whole such as to satisfy the most fastidious taste, and in com-

bination with the judicious arrangements of the glass ornaments produce a very brilliant effect" (Journal, ser. 3, vol. 6, p. 402).

The Cornelius firm of Philadelphia, the largest manufacturer of lighting devices in America at the time, exhibited two gas chandeliers at the London International Exhibition of 1851. The *Art Journal's* catalogue of the display comments as follows: "They stood about fifteen feet and a half high, by six feet wide, having fifteen burners with plain glass globes, and are rich brass lacquered. The design is very rich in ornament, and possesses some novelty in the succession of curves ingeniously and tastefully united: the gas keys represent bunches of fruit, thus combining beauty with utility" (1851, p. 212). Such dubious marriages between beauty and utility were to become increasingly frequent in American lighting devices as the century wore on.

Gas street lights were simple inverted truncated pyramids of glass and tin, mounted on posts and enclosing gas jets. Charles Dickens remarked upon the lights of Broadway in 1842 (p. 103): "As the eye travels down the long thoroughfare, dotted with bright jets of gas, it is reminded of Oxford Street or Piccadilly. Here and there a flight of broad stone cellar-steps appears, a painted lamp directs you to the Bowling Saloon, or Ten-Pin Alley . . . At other downward flights of steps, are other lamps, marking the whereabouts of oyster-cellars."

Public illuminations of a celebrative nature were frequent urban occurrences in the exuberant years we are considering, and the possibilities of gas light were exploited to the utmost on those occasions. Gas pipes were sometimes bent to odd shapes, and when perforated with holes for jets, were mounted on buildings and lighted with impressive effects.

At the Railroad Jubilee held in Boston in 1851 to commemorate the completion of the railroad between Boston and Montreal, an illumination "emblematic, not only of present joy, but of bright hope for the future . . . irradiated the scene," according to the official account. "The Tremont House," it was narrated, "is especially worthy of notice for the extent and splendor of its illumination. The columns of the portico were like pillars of flame. Two thousand lights were placed in the windows, besides which there were two dazzling rosettes of gas in front. The exhibition called forth the warmest encomiums of thousands." The Boston Gas Light Co. naturally made the most of its product, and we find that "in front of the office of this Company was seen the word 'Union,' in 'letters of living light,' supported by four vines, above all which blazed a single star of dazzling brilliancy" (Railroad Jubilee, 1852, p. 188 ff.).

Such public demonstrations were all the more wondrous because they were unfamiliar. In the ordinary household a meager amount

of light was the expected thing, and a greater concentration was often regarded with disfavor under normal circumstances. As early as 1804 the *Domestic Encyclopedia* had commented on the "superior utility of lamps," but "as the light emitted from them is frequently too vivid for weak or irritable eyes, we would recommend the use of a small screen" (Mease, 1804, vol. 3, p. 432). Presumably the Argand lamp, with its unprecedented candlepower, was the basis for this caution. Count Rumford had stated in 1811 that "no decayed beauty ought ever to expose her face to the direct rays of an Argand lamp." By 1847 this hostility to unusual brilliance was still expressed. The *Franklin Institute Journal* in that year (ser. 3, vol. 14, p. 410) remarked that "the unpleasant, and to many sights, painful effects of the naked flame of a candle, lamp or gas-burner, have long been known and felt." At almost the same date (August 21, 1847), the *Scientific American* observed some extraordinary precautions taken against glare: "The introduction of gas lights into private houses has been taken advantage of by the ladies, who under protest against the glare and uncomfortableness of such bright lights, deliberately spread parasols in evening soiree . . . A pink parasol judiciously held between a lady's face and a gas burner throws a tender, roseate hue over the complexion."

In commonplace surroundings, particularly outdoors, the light afforded on ordinary occasions was seldom sufficient to damage one's eyesight, all fears to the contrary notwithstanding. Alexander Mackay (1849, pp. 129, 162), looking across the Delaware River, found the lights of Philadelphia "as few and far between as are those of London and the Thames." On the "cold moist platform" of the Washington railroad station "we stood shivering by the light of one wretched lamp," while in front of his hotel there "the solitary lamp which burned over the door only made darkness visible." Dickens remarked upon the "feeble lights" of Harrisburg, which "reflected dismally from the wet ground" (1842, p. 170).

For those who traveled at night, illumination in public conveyances must have been even more dismal. John S. Kendall in "The Connecticut and Passumpsic Rivers Railroad" (1932), states: "Sperm candles were used at first for lighting the cars, giving way to oil lamps later. They gave just about light enough to keep passengers with good eyesight from falling over the seats." Mackay (1849, p. 36), traveling from Worcester to Norwich, stated, "A solitary lamp burned at one end of the car." When the Western Railroad was completed between Worcester and Springfield, Mass., in 1839, the new passenger car was equipped with a glass-encased boxlike frame beside each seat. Passengers placed their own candles in these frames at first, but because one's candles did not always fit the socket, the railroad later furnished them (Ayers, 1944).

As might be expected, the stagecoach traveler had the ultimate minimum of light. Mackay (1849, p. 213), about to ride from Mill-edgeville to Macon, Ga., attempted to examine the vehicle which was to take him "by the glimmering light of a tin lantern, which had the peculiarity of never being precisely where it was wanted."

Steamship lighting was glamorous by contrast. Lady Emmeline Stuart Wortley (1851, p. 25) voyaged up the Hudson in "a floating island of painting, marble, gilding, stained glass, velvet hangings, satin draperies, mirrors in richly carved frames, and sculptured ornaments with beautiful vases of flowers, Chinese lamps of various indescribable forms, arabesques, chandeliers—in short, you might fancy yourself in Haroun Alraschid's palace."

The lighting of churches was usually austere. Many churches had no lights at all, while others merely had a minimum of light in the form of simple sconces. The Wells Collection at Old Sturbridge Village (Sturbridge, Mass.) includes a chandelier from a Baptist meetinghouse, near Brunswick, Maine, that dates from about 1820. This consists of a turned wooden central section, radiating spidery arms of heavy iron wire which support tin candle saucers and are decorated with tin leaves. The same collection exhibits four candelabra, two in the form of a cross and two in the form of an ellipse, from a Mennonite church in Pennsylvania. The Rocky Hill Meetinghouse in Salisbury, Mass., still has three astral lamps suspended from overhead. These were probably installed about 1830, or slightly earlier. No other means of artificial light have since disturbed them.

Domestic lighting was seldom brilliant. Harriet Martineau (1838, vol. 1, p. 37), landing in New York from England in 1838, complained that in her Broadway boardinghouse bedroom the four bed posts looked "as if meant to hang gowns and bonnets upon, for there was no tester. The washstand was without tumbler, glass, soap, or brush tray. The candlestick had no snuffers." It is to be concluded that one candle was supposed to light a whole room.

The refinement of city houses was, of course, in striking contrast to the crude cabins of the frontier. Mrs. Felton (1842, pp. 36-37), said that in New York "the number of superb houses is very great. . . . They appear all to be built upon one plan; the chief feature of which is, that the dining and drawing rooms are situated on the lower floor, and so arranged, as by throwing open a large pair of folding doors, to form one splendid apartment. Their furniture is magnificent in the extreme."

The lighting for so elaborate a home as these was usually on an appropriate scale from the standpoint of the appearance of the fixtures. In function, however, even the more expensive gas or oil-burning devices left something to be desired, although they were vastly

superior to candles and whale-oil lamps. Frederika Bremer in 1849 described the evenings she spent in New York City in the well-furnished home of her American friends, Mr. and Mrs. Downing. Among her happiest hours, she said, were "those passed in the evening with my host and hostess, sitting in the little darkened parlor with book-cases and busts around us, and the fire glimmering in the large fireplace. There by the evening lamp, Downing and his wife read to me by turns from their most esteemed American poets" (Benson, 1924, p. 11). Here is a vivid picture from the home of cultured persons, where the light of one lamp was sufficient for one individual to read by, but still so dim as to leave the room "darkened." The lamps thus used for parlor tables were commonly "astral" lamps, fitted with ground-glass shades resting on ring-shaped, or "annular," reservoirs. Designed to minimize the amount of shadow cast by the reservoir, these were modifications of the Argand lamp. They were made of brass or bronze, as a rule, though sometimes their bases were of pressed glass. Like the "common" lamps that were used in the less important parts of the house, astral lamps burned sperm oil.

Miss Leslie in 1840 defined in great detail the types of lamps used in a well-to-do home, with instructions concerning their use and care. She pointed out that "lamp shades painted in bright colors are now considered in very bad taste" and also advised that a separate oil can should be used for the parlor lamps.

Besides the astral lamps, there were other types that gained favor for parlor use as inventive activity increased. One was the Carcel, or "Mechanical," lamp, invented in France in 1800 but not until considerably later adopted here. The Carcel lamp embodied an elaborate clockwork which activated a pump that in turn flooded its Argand burner with oil. It was surely very costly in comparison with other lamps, but it was by far the most efficient lamp that had yet been devised for burning viscous fuels. The Franklin Institute conducted various tests with the Carcel lamp, and the findings must have been influential in stimulating its use. Among other things, it was found that the Carcel lamp using fall-strained sperm oils burned with an intensity of more than twice that of a gas burner, and at only slightly higher cost. The *Journal* (1843, ser. 3, vol. 5, p. 105 ff.) observed: "The Carcel lamps, although from their construction, expensive, give an exceedingly steady long enduring, and bright light, and are characterized by beauty of form, and total absence of shadow."

Although the breaking of conventional shackles on illumination was not always recognizable in terms of increased light, it was manifested by a growing spate of inventions, which served progress by the trial-and-error method. Bred in the new atmosphere of mechanical and scientific advancement, approximately 500 patented inventions were

recorded in the United States Patent Office between 1830 and 1860 for lighting devices alone. Scarcely 50 had been listed between 1790 and 1830 (Hubbard, 1935). It is true that improvement upon what was already in existence was a leading motive for this inventive activity; but there were also underlying economic reasons, of which one was the state of the whaling industry. Even before the demand for whale oils had reached its height in the middle 1840's the whaling industry, while seeking to supply a growing demand, had found itself faced with diminishing returns. Whales became scarcer, voyages in search of them grew longer, and the risks of both the owners and the crews increased with each voyage. Hohman states (1928, pp. 273, 302, 330), "It was estimated that during the middle years of the nineteenth century approximately ten percent of all American whaling vessels made voyages which resulted in a net loss to their owners." Between 1846 and 1861 the whole fleet declined from 735 to 514 ships. Meanwhile, the wholesale price of sperm oil fluctuated upward in increasing peaks. In 1848, to cite an extreme contrast, the dockside price in New Bedford was 95 cents a gallon, while in 1855 it was \$1.70. Earlier than this, however, whale oils had been expensive, although they could be burned comparatively cheaply in the simple common lamp. As early as 1821 winter-strained sperm oil had cost the city of Boston \$1.07 a gallon on a contract basis. In 1843 the price of fall-strained oil was quoted by the Franklin Institute Journal (ser. 3, vol. 5, p. 105 ff.) at 90 cents a gallon, and the winter-strained variety at \$1. It is easy to see why farm folk preferred to rely on lard and tallow from their own animals.

A few of the inventors sought to improve the efficiency of lamps intended to burn sperm oil. Samuel Rust, of New York, took out several patents involving the use of ribbon wicks and chimneys to increase combustion, wick raisers to permit finer adjustments, and other modifications of the common lamp which sought to improve its function. In 1831 William Lawrence designed a hanging lamp with a reservoir in the shape of a hollow truncated cone and with slanting ribbon-wick burners enclosed in a glass shade. This provided, in theory at least, proper draft-fed combustion and a good central light. Closely related in form was Couch & Frary's lamp patented two years later.

It remained for Isaiah Jennings in 1830 to patent a new fuel and thereby make the outstanding contribution to the development of lighting prior to the discovery of kerosene. His "burning fluid" combined alcohol and spirits of turpentine in a proportion of eight to one. It was the first chemically made, volatile illuminating fuel. The Franklin Institute Journal, a regular commentator and frequently severe critic of new inventions, was enthusiastic: "We have

seen the above mixture in combination in an Argand's lamp. The flame was clear, dense, and brilliant. The light may be made greatly to exceed that from oil, without the escape of any smoke, and there is not the slightest odor of turpentine. The patentee says the mixture is as cheap as spermaceti oil, and that he is making arrangements which will enable him to afford it at less cost considerably below that material." It concluded with an afterthought: "The friends of temperance will not object to the burning of alcohol" (1831, ser. 2, vol. 7, pp. 75-76). The Journal did not then foresee the dangers inherent in the use of so explosive an agent in a common, or even an Argand, lamp. By 1834 they had reason, as we shall see, to comment on Samuel Casey's patented burning compound (one of several variants of Jennings's fluid): "The late fatal accidents resulting from the use of such ingredients in lamps will, however, probably put a final stop to the use of these mixtures, and we have no doubt that a court of law would now decide that they are not useful, within the meaning of the statute" (1834, ser. 2, vol. 14, p. 247).

Nevertheless, the cheapness of these fluids and the comparative excellence of the light afforded by them led to their gradual adoption. There were several followers in Jennings's footsteps, among them Henry Porter, of Bangor, Maine, who added camphor, rosin, and tincture of curcuma to the formula in 1835. Finally, in 1839, Augustus V. X. Webb of New York began to manufacture distilled turpentine under the name "camphine." Later (when usually spelled camphene) that became a generic term applied loosely to all the fluids.

The use of undiluted turpentine was not new with Webb, however, for only a year earlier Luther Jones had patented a lamp for burning this substance. The lamp was advertised in the Boston Transcript (November 27, 1839):

A New and Superior Lamp. Jones's Patent Reverse Lamp, for burning the oil of turpentine. For light, this lamp is without a parallel, producing more light from the same width of wick than any other. The material used in them is perfectly harmless. The lamp can be filled at any time without the least danger; it costs less than oil, and the lamp is a very excellent one for Stores, Factories, Work Shops, &c, &c . . .

The claims made here for its safety are not supported by the Franklin Institute Journal's commentator: "So far as experience may serve as a guide, the lamps for burning spirits of turpentine are not likely to supersede those for burning oil; there are serious objections to the use of the former, and amongst them is the inflammability of the fluid" (1838, ser. 2, vol. 24, p. 323).

The inflammability of the fluid was a factor that came to be reckoned with in ever-increasing degrees as these fuels grew in use. Ample evidence can be found in the periodicals of the day. The following was printed in the Scientific American for June 19, 1847: "Miss

Mary Watson was burned to death in Philadelphia last week, while attempting to fill a fluid lamp when it was burning, and the liquid taking fire caused the catastrophe. Her mother and brother, who were in the room, were also badly burned in attempting to save her." The same periodical reported on April 27, 1850, "A serious fire took place at a camphene distillery in our city on last Friday, by which several of the hands were severely burned. There is scarcely a week passes over our heads without a number of accidents from the use of camphene." The next year this state of affairs was still continuing. "Two daughters of Alderman Ramass of New Orleans were burned to death by the explosion of a camphene lamp; two others were also shockingly burned by the accident" (Gleason's Drawing Room Companion, July 7, 1851). On September 17, 1853, the Scientific American again commented with some astonishing statistics: "According to a record kept by Mrs. F. Merriam, there were, during the year ending September 1st, 1853, some thirty-three fatal explosions, mostly in the cities of New York, Brooklyn, Williamsburgh, and vicinity, in which nineteen persons were killed, twenty-three persons fatally or severely injured, three persons slightly wounded, and some three or four buildings fired. The preparations alluded to are burning fluid, camphene, spirit gas, rosin oil, etc."

Probably the first effort to obviate these dangers was to design a new burner less dangerous to use than the common whale-oil burner. This was made so that its wick tubes extended upward, away from the fuel, instead of downward. Thus less heat was conducted into the reservoir from the flame, and the flame itself was a greater distance from the fluid. Extinguisher caps obviated the dangerous necessity of blowing out the light. This burner was widely adopted, as its frequent survival in collections and antique shops indicates. It was designed to fit the same lamps that had burned whale oil, so that the difference between a whale-oil lamp and a so-called "camphene" lamp is often distinguishable only by its burner. An undated advertising card of Marsh & Company's Patent Oil Manufactory of Boston, probably printed in the 1840's, announces "New tubes fitted to Common Whale Oil Lamps, from 6¼ to 12½ Cents."

It may be concluded that the fluid burner was only a relative improvement in safety, for most of the recorded accidents occurred after the burner was in common use. The next moves were therefore toward designing a "safety" lamp that would not explode. This hoped-for goal was probably never achieved, but the efforts to do so were numerous. Perhaps the most satisfactory was the one patented by John Newell, in 1853, consisting of a cylinder of fine wire-gauze screen, which encased the wick inside the reservoir. Evidently inspired by the Davy miner's safety lamp, this was supposed to keep the flame

from backing into the fuel supply. It was exhibited at the New York Crystal Palace Exposition in 1854 and was acclaimed by such notable scientists of the day as Benjamin Silliman. Another, consisting of a glass reservoir enclosing a metal lining, was patented by Prof. E. N. Horsford, a Harvard archeologist, and James R. Nichols.

Other improvements in the use of camphene and fluids were designed to make the flame burn more brightly. One was patented by "Doctor" Michael Boyd Dyott, a flamboyant Philadelphia manufacturer of glass, patent medicines, and a burning fluid he called "pine oil." In his lamp the fluid was vaporized and burned as a gas. This was followed by several other designs which were in effect gas lamps using vaporized fuel.

The Franklin Institute's experiments of 1843, already several times alluded to, led to the conclusion that "camphene possesses a remarkable intensity and higher lighting power, with a brilliant white flame, and from its cheapness presents strong claims, on the score of economy, upon public notice. Its disadvantages are, the great inflammability of the material, the liability to annoyance from its disagreeable smell, and the injurious and unendurable smoke which proceeds from the lamp when out of order, or not properly regulated" (1843, ser. 3, vol. 5, p. 108 ff.). The brilliance attributed to camphene was, of course, a matter of comparison and degree. To one used to the single-candle-power light of a whale-oil burner the light from a fluid burner was a vast improvement. That the fluids were widely adopted, both (we may assume) on the basis of their "high lighting power" and "on the score of economy," is evident from the large number of surviving examples.

To what extent the rural population, with its conservatism reinforced by a healthy fear of fire, may have taken up the burning fluids is open to surmise. Certainly most country residents were prepared to welcome a safer substitute than camphene for traditional lighting devices. Such a substitute was provided by lard from their own hogs, used in combination with any of the scores of newly invented lard lamps. Most of the lamps designed for burning lard were crude in appearance and bizarre in function. Few were based on scientific knowledge, but almost all were concerned with overcoming the difficulties of burning a semisolid fuel. There were three basic principles employed in the lamps: (1) Conduction of heat from the flame to the fuel supply; (2) gravity, usually in combination with conduction devices; and (3) mechanical pressure.

In 1830 Stephen P. Moorehead sought a patent on a lard lamp having copper wires wound around the wick tubes and leading down into the reservoir. Thus heat from the flame would, in theory, at least, be carried down to the lard. Moorehead was not the originator of

this idea, as the *Franklin Institute Journal* rather waspishly pointed out. "The task is not an agreeable one," it commented, "to inform a person who believes he has drawn a prize, that a small mistake has been made in his number" (1830, ser. 2, vol. 6, p. 15). It went on to explain that a lamp made in Philadelphia 20 years earlier had employed the conduction principle and that another had followed. What these lamps may have been cannot now be conjectured.

Notwithstanding its lack of originality, the conduction device was used over and over again, even though the patent claim in each case was ostensibly for some other feature. Southworth's patent of 1842 is a case in point, where both a copper wick tube and copper conductor strip were employed. Even as late as the following year, a chemist named Campbell Morfit had seen fit publicly to recommend the substitution of copper wick tubes for those of tin.

In 1834 Samuel Davis designed a lard lamp that similarly included copper parts in the burner. Davis's directions made it clear that something more than a copper conductor was needed, however. "If the lard lamp be cold, and there be no warm lard to start it, hold the lamp upside down, and with a match let it burn until the burner gets hot, then set the lamp down and put a little cold lard in the lid around the wick." The implications of hardship and difficulty in the simple act of lighting a lamp—an "improved" one, at that—are most interesting to reflect upon.

Delamar Kinnear, of Circleville, Ohio, patented a lamp in 1850 on the basis of its shape. In addition to having a wide flat wick for giving light, it included also a pilot burner from which a conductor wire descended into the fuel supply. Many of Kinnear's lamps have survived, indicating that they enjoyed some degree of success.

The second group of lard lamps depended upon gravity as well as heat conduction. Dexter S. Chamberlain's patent of 1854 prescribed a tilting reservoir in which the oil supply was kept at a constant level with the wick. The patent model is in the United States National Museum collection (No. 251802). Moses Woodward's earlier patent of 1842 also utilized this principle. Its functioning was described by the *Franklin Institute Journal* (1844, ser. 3, vol. 7, p. 252): "The lard can be burned until it is nearly exhausted, for by the tilting of the body of the lamp, the lard can be brought near to the ignited part of the wick."

The lamps of the third category were probably the least attractive but the most effective. These employed mechanical pressure devices to force the lard into the wick. An early and evidently popular version was patented by Maltby & Neal, of Middlebury, Ohio, in 1842. Their handsome patent model of brass with silver name plate (No. 251795) is illustrated in plate 8. Other examples of this lamp in tin

and brass also are represented in the United States National Museum.

John Grannis's patent of the same year claimed the application of a "forcing" pump, or hand plunger, "to the construction and use of lard lamps." Very similar, but embodying a key-propelled worm shaft with piston instead of a force pump, was Smith & Stonesifer's patent of 1854. Another mechanical piston lamp had been previously patented by Williams & Tew.

Most of the foregoing were crude looking and were more suitable for use in the farm kitchen than in the city parlor. A device called the solar lamp, however, answered all the requirements of "elegance" demanded by Victorian taste. Capable of burning any viscous oil, but especially suited to lard oil, the solar lamp was a modified Argand lamp. Its burner was fitted with a convex plate having a hole in the center to direct the flame upward in a tall column of light, plus a tapering glass chimney. It was in every respect a superior lighting device. Although used for many years previously in England, it was not introduced in America until 1841. From the Franklin Institute's aforementioned experiments of 1843 it was concluded: "The solar lamp, although not so steady as the Carcel, approaches very nearly, if it does not equal, that of the Carcel, in intensity. It is comparatively cheap, simple in its construction, not liable to get out of repair, and easily cleansed" (1843, ser. 3, vol. 5, p. 105 ff.). Since its initial cost was not great, and the cost of lard oil was less than that of sperm oil, and since the appearance of the solar lamp was agreeable in "genteel" surroundings, its success was assured. It probably displaced many of the less efficient and more expensive astral lamps. The solar lamp was made by several manufacturers.

Taste in the 1830-60 period was reflected in lighting devices as in other objects of furnishing. There were to be found handsome execution of good design on the one hand and esthetic atrocity on the other. The more expensive the lamp the more ornate and meretricious the decoration. Hand lamps of pewter and glass were essentially simple, as were most of the smaller types other than patented lard lamps. Astral lamps at the beginning of the period usually reflected the rather severe classicism of the Greek Revival, bronze Ionic columns and square plinths having been favorite forms for their pedestals. After the introduction of the solar lamp the multiple-unit assembly principle led to increasingly incongruous combinations of mass-produced bases and supporting shafts. Globes for solar lamps became spheres of frosted glass, etched or engraved with Gothic arches and arabesques. The classic column gave way to cast-brass fantasies in pseudorococo, and the marble base was introduced to the lamp for a long association.

As early as 1833 the tendency of metal workers to outdo themselves in ornamental excess was already being felt. In the Eighth Exhi-

R. H. SPALDING,
 Successor to H. Porter, and sole Manufacturer of
PORTER'S PATENT
COMPOSITION BURNING FLUID;
 ALSO,
SUPERIOR CAMPHENE AND ALCOHOL.

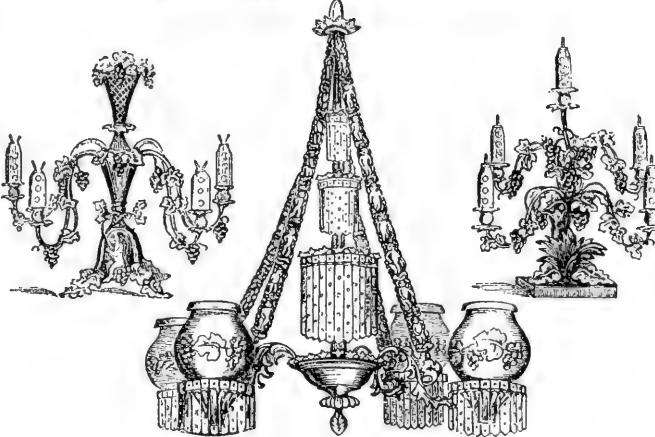

MANUFACTURER OF AND DEALER IN

Fluid and Oil Chandeliers,
 ASTRAL, SOLAR, HANGING AND SIDE LAMPS;
 PORTABLE STUDY LAMPS, OF EVERY DESCRIPTION,
 GIRANDOLES, CANDELABRAS, HALL LANTERNS;
 CHINA, TERRA-COTTA AND BOHEMIAN VASES.
 ALSO,
 GLOBES, SHADES, GLASS PRISMS, &c. &c. &c.

Wholesale and Retail.

Nos. 8 and 9 TREMONT ROW, Boston,
 OPPOSITE THE HEAD OF HANOVER STREET.

FIGURE 1.—Woodcut advertisement from the Illustrated American Biography, by A. D. Jones, vol. I, Boston, 1853.

bition of Domestic Manufacturers, sponsored by the Franklin Institute, the Committee of Judges on Lamps commented that in the mantel lamps of Cornelius & Company "the brass castings are graceful and durable, and exhibit a great richness of hue . . . The astral lamps of the same artists are remarkable for new, original, and delicate forms." The word "original" is here significant. In the same

report there is reference to an almost comic example of the *outré*: "The Committee were not less pleased with lamps of anthracite coal from the factory of J. W. and F. Kirk . . . The quantity of this article sold by the makers, indicates the public suffrage in its favour, and a confidence in its durability, which we were not prepared to expect" (1833, ser. 2, vol. 13, pp. 92-93).

In 1844, at the Thirteenth Exhibition, there was an increasing emphasis on fixtures such as "richly ornamented gas pendants in ormolu" and "silvered chandeliers and candelabra" (1844, ser. 3, vol. 6, p. 402). At about this time mantelpiece girandole candelabra were fashionable, and Starr & Co. of New York advertised a 3-unit set consisting of cast-brass human figures on marble bases supporting candle holders from which cut crystal drops were suspended.

The judges at the Thirteenth Exhibition gave due credit, however, to some of the simpler devices: "The humbler solar and lard lamps deserve more than the passing notice which they receive at the hands of the committee, and will, no doubt, serve to gratify the good taste, and aid the vision of a far greater number of our fellow citizens, than will the more showy and expensive chandeliers."

Like a tidal wave, however, a new discovery in lighting swept aside everything before it, both in form and function, at the close of the 1830-60 period. The coup de grace had actually fallen 6 years earlier, when Abraham Gesner of Williamsburg, N. Y., had patented his "new liquid hydrocarbon, which I denominate 'kerosene'." The blow was not then immediately felt, for Gesner's "kerosene" was regarded at first as merely another burning fluid. But the opening up of the Pennsylvania petroleum fields in 1859 marked the turning point by releasing an abundant source of cheap and superior fuel. Special burners were developed, and before a decade had passed the kerosene lamp, in dramatic fashion, had virtually displaced all its predecessors, except those that burned gas.

With the adoption of kerosene, as well as the increased urban use of gas, industrialism took command in the field of lighting, just as it did in so many phases of human activity. The period of 1830-60 had been one of transition between handicraft economy and mass production and distribution. It had been an era when the individual tinkerer applied his talents to inventing the mechanisms of a system which was soon to dispense with his services. Viewed from afar it appears today fresh and picturesque, with its tortuously conceived lard lamps being "teased" along in farmhouse kitchens and its naively "elegant" solar lamps symbolizing artistic progress in countless parlors. But it had been in fact an earth-shaking era, for it effected the final transition to a new material environment, not the least part of which was the conquering of darkness.

"What miraculous progress and improvement is visible on every side of the U. S.," Lady Emmeline Stuart Wortley had exclaimed. This expressed well the spirit of advance in the art of illumination, as well as of material progress in general. Every inventive step, however faltering or unguided, was in the direction of new techniques and discoveries. Every new embellishment in the decoration of lighting devices, however awful to modern eyes, represented progress in a growing estheticism. Thus the lamps of this era shone upon a stirring scene and were themselves symbols of the times, reflecting and illuminating a dynamic society.

BIBLIOGRAPHY

- "A LADY" [SUSAN FENIMORE COOPER].
1851. Rural hours. New York.
- ART JOURNAL, THE.
1851. The industry of all nations. Illustrated catalogue. London.
- AYERS, CHARLES E.
1944. A brief history of railroad passenger car lighting. *Rushlight*, vol. 10, No. 4, pp. 55-57.
- BENSON, ADOLPH P. (editor).
1924. *America of the fifties: Letters of Frederika Bremer*. London.
- BOSTON DAILY SENTINEL AND GAZETTE.
1837. [Issue of September 25.]
- BOSTON TRANSCRIPT.
1839. [Issue of November 27.]
- BRYSON, FRANCES.
1950. From the days of iron lamps. *Antiques Journ.*, vol. 6, No. 10, p. 26.
- DAVIS, SAMUEL.
1934. Directions with Davis lard lamp. *Rushlight*, vol. 1, No. 2.
- DICKENS, CHARLES.
1842. *American notes*. Leipzig.
- EARLE, ALICE MORSE.
1898. *Homelife in Colonial days*. New York.
- EATON, ALLEN H.
1937. *Handicrafts of the southern highlands*. New York.
- FELTON, MRS.
1842. *American life: A narrative of two years city and country residence in the U. S.* London.
- FORWARD, ALEXANDER.
1929. Gas supply in the United States. *Encycl. Brit.*, 14th ed., vol. 10, pp. 49-50.
- FRANKLIN INSTITUTE.
1830. *Journal*, ser. 2, vol. 6, p. 15.
1831. *Ibid.*, vol. 7, pp. 75-76.
1833. *Ibid.*, vol. 13, pp. 92-93.
1834. *Ibid.*, vol. 14, p. 247.
1838. *Ibid.*, vol. 24, p. 323.
1843. *Ibid.*, ser. 3, vol. 5, p. 105 ff.
1844a. *Ibid.*, vol. 6, p. 402.
1844b. *Ibid.*, vol. 7, p. 252.
1847. *Ibid.*, vol. 14, p. 410.

GLEASON'S DRAWING ROOM COMPANION.

1851. [Issue of July 7.]

HOHMAN, ELMO PAUL.

1928. *The American whaleman*. New York.

HOUGH, WALTER.

1928. Collection of heating and lighting utensils in the United States National Museum. U. S. Nat. Mus. Bull. 141.

HUBBARD, HOWARD G.

1935. A complete check list of household lights patented in the United States, 1792-1862.

KENDALL, JOHN S.

1932. *The Connecticut and Passumpsic Rivers Railroad*. Railway and Locomotive Hist. Soc. Bull. 49.

MACKAY, ALEXANDER.

1849. *The western world, or travels in the U. S. in 1846-47*. Ed. 2. London.

MARTINEAU, HARRIET.

1838. *Restrospect of western travel*. Vol. 1. New York.

MEASE, JAMES.

1804. *The domestic encyclopaedia*. 1st American ed.; with additions by A. F. M. Willich.

MERCER, HENRY C.

1898. *Light and fire making*. Doylestown, Pa.

OLMSTED, FREDERICK LAW.

1856. *A journey in the seaboard slave States*. New York.1907. *A journey in the back country in the winter of 1853-1854*. Ed. 2, vol. 1. New York.

RAILROAD JUBILEE, THE.

1852. *An account of the celebration commemorative of the opening of railroad communication between Boston and Canada*. Boston.

RANDOLPH, VANCE.

1931. *The Ozarks, an American survival of primitive society*. New York.

WATKINS, C. MALCOLM.

1935. *The whale-oil burner; its invention and development*. *Mag. Antiques*, vol. 28, No. 4, pp. 148-149.1936. *A lamp dealer illustrates his wares*. *Mag. Antiques*, vol. 35, No. 6, pp. 297-299.

WATKINS, LURA WOODSIDE.

1943. *Development of gas lighting*. *Rushlight*, vol. 9, No. 4, pp. 5-8.

WORTLEY, LADY EMMELINE STUART.

1851. *Travels in the U. S. . . . during 1849 and 1850*. New York.

WYANT, MAJ. L. B.

1840. *The etiquette of nineteenth century lamps*. (Quoting from Miss Leslie's *Housebook*.) *Mag. Antiques*, vol. 30, No. 3, pp. 113-117.

The Development of the Halftone Screen¹

By JACOB KAINEN

Curator of Graphic Arts, U. S. National Museum

[With 12 plates]

THE tremendous increase in the printing of pictures during the past half-century constitutes one of the most important chapters in the history of the graphic arts. While this phenomenal development in picture printing came about as a result of public demand, the fact remains that this appetite for pictures could never have been satisfied had not certain mechanical instruments of reproduction first been provided. And one of the most indispensable of such instruments was the halftone screen.

The halftone screen made it possible to translate the tonal values and gradations of a photograph into dots of varying sizes so that a plate could be prepared that would reproduce the original by relief (letterpress) printing. Carried over into lithography and gravure, the halftone screen made important contributions to these processes and played a key part in transforming them into giant industries.

The halftone screen, as it has been universally used since about 1895, is made up of two sheets of glass, each glass being ruled with parallel lines etched and filled with black pigment and cemented together at right angles so that the resulting single sheet of glass shows a series of black lines crossing each other, with transparent square openings like a fine version of a wire-mesh screen. When placed before a sensitive plate in a camera the transparent openings permit the light to pass through in proportion to the light and dark areas of the object being photographed. Where the light reflected from the object is low a small amount of light will pass through the openings, which act like a pinhole camera, and where the illumination is intense a larger number of rays will reach the sensitive plate. In this manner the tones of the object to be printed are translated into dots of varying sizes.

¹ Revised and expanded, by permission, from an article entitled "The Halftone Screen," published as a brochure by R. R. Donnelley & Sons Co., Chicago, Ill.

The halftone screen, however, did not achieve perfection overnight. Like most mechanical devices it grew slowly from the original idea, and a long series of trials and errors over a period of four decades was necessary to bring it up the ladder to practical success. It is with the more interesting of these efforts that this article is concerned.

The letterpress industry, it should be remembered, produced practically all reading matter until recent years. Yet as late as the 1880's, despite the fact that photogravure and collotype (as well as lithography to a less reliable degree) could reproduce photographs beautifully by photomechanical means, the letterpress printer still required the wood engraver to translate photographs and other toned pictures into engraved blocks. Results were slow, costly, and unreliable. They were, moreover, marked by the stylistic idiosyncrasies of the engraver. Here was letterpress, the most widely used method of printing, producing all the newspapers, books, and magazines, yet lacking any good method for producing toned pictures photomechanically to set up in the same form with type. There was good reason for inventors to work feverishly to satisfy the insistent demand for a reliable photomechanical relief halftone process. Basing their work on all that had gone before, they gradually evolved the modern halftone screen, which was perfected in principle in 1885. By 1891 the difficult business of manufacturing accurate screens was finally worked out.

In the matter of creating graduated tones, relief printing lagged considerably behind gravure from the historical standpoint. From the fifteenth century up to the latter part of the eighteenth, the old-fashioned woodcut provided the only means by which an illustration could be printed in the same form with type. This was strictly a line process, with only a rudimentary suggestion of tone. There was the chiaroscuro woodcut, of course, which employed separate blocks for tones, with a key block in line. This method, however, required several printings and moreover had but a few simple gradations of tone. Numerous methods existed in gravure, however, for creating fine lines, dots, cross-hatches, and reticulations which produced the illusion of tone. These processes, which included line-engraving, etching, mezzotint, and aquatint, involved the engraving or etching of sunken lines and dots which were filled with ink, after which the surface was wiped clean and the plates were printed on a special engravers' press which forced the dampened paper into the sunken ink-holding lines and dots. No type could be used in these processes. Consequently, when tonal pictures were required for book purposes, the only solution was to tip in plates printed by gravure. This was a costly and time-consuming procedure.

In 1784 Thomas Bewick, in England, published his illustrations in "Select Fables" and demonstrated the practicality of creating tonal

effects by engraving on the end-grain of a hard, dense wood, such as boxwood. With this innovation wood engraving came into universal use for relief printing, reaching its culmination in the last quarter of the nineteenth century. At that time, the demand for pictorial matter in books, magazines, and newspapers reached higher levels than ever before. It had been increased by developments in photogravure and collotype—and in lithography, which Alois Senefelder discovered in Germany in 1798. This process made use of slabs of Bavarian limestone, which had the property of being sensitive to both grease and water. The drawing was made on the stone with a crayon or ink containing grease and pigment and chemically treated to fix the greasy image and desensitize the remainder of the stone to grease. The stone was then covered with a thin film of water, which was rejected by the greasy image but retained by the porous stone. A greasy ink was applied by a roller and was accepted by the greasy image but rejected by the damp areas. The original drawing was therefore reconstituted in printers' ink and was susceptible of printing under a slight scraping pressure. Lithography proved to be a versatile process that offered the simplest and most direct method for printing toned pictures before the advent of photomechanical printing.

The modern halftone would not have been possible, of course, without the invention of photography. In 1839 Daguerre, in Paris, continuing the work of Niepce, announced the invention of the daguerreotype. A little later in the same year Fox Talbot in England reported on the calotype. Of the two inventions Daguerre's was the more immediately successful, although Talbot's unquestionably was the more important in the long run, since it introduced the use of transparent negatives. The daguerreotype produced only a single final silver image on a copper plate. Numerous experimenters immediately began to etch daguerreotype plates and to use electrodeposition in an effort to turn them into printable surfaces. Although these attempts produced interesting results they were basically unsatisfactory and were soon abandoned.

In 1852 Fox Talbot made another contribution of fundamental importance. It was known, from the observations of Ponton and Becquerel, that gelatin, when sensitized with a bichromate salt, has a propensity to harden under the action of light. Talbot was the first to make practical use of this phenomenon in patenting the photogravure process, or, as he called it, "photoglyphic engraving." His 1852 patent, at the same time, laid the basis for practically all future developments in printing from a photographic image.

The earliest form of the Talbot process involved coating a steel plate with a mixture of gelatin and bichromate of potash, exposing it under a positive, washing away the unhardened gelatin, and etching

with bichloride of platinum. A coating of acid-resisting resin powder, as used in the aquatint process, was also used occasionally to provide a stronger ink-holding tooth.

In his 1852 patent he mentioned the use of two or three sheets of black gauze, laid across each other obliquely to break up the photographic image, as well as a suggestion "to manufacture on purpose some pieces of more delicately woven fabrics, or to cover a sheet of glass by any convenient method with fine opaque lines to intercept the light, or with a powder adhering to the glass, consisting of distinct opaque particles, and very uniformly diffused over the surface. These things, which I believe have not been heretofore used in the fine arts, I would denominate photographic screens or veils." This was the first known proposal of the modern halftone screen. The division of graphic arts of the United States National Museum has on display a glass screen made by Talbot, a positive, in which regular circular openings appear on a dark ground. The date of this experimental screen is unknown, but it is likely that it was made about 1860, anticipating by three-quarters of a century the Grennell patent of 1935, which proposed a screen on a similar principle.

The first photomechanical halftones for relief printing (Talbot's work was primarily in gravure) were made by Paul Pretsch of Vienna in 1853 and patented in England in 1854. Pretsch exposed a glass or metal plate coated with bichromated gelatin in the camera or copying frame and washed the resulting image in cold water, which caused the gelatin to swell. Where light rays had exercised hardening action the gelatin swelled least, and where the gelatin was least exposed to light and remained softest it swelled most. In this manner a delicate relief was obtained, graduated in height and depth according to the amount of light absorbed. The reticulated gelatin was then chemically treated to create a more pronounced grain, after which an electrotype was made either directly from the swelled gelatin relief or from a gutta-percha mold. Electrotypes plates could be prepared for either relief or intaglio (gravure) printing. The gravure plates were extremely good for this early stage. Results in letterpress, while coarse and far from uniformly successful, were quite creditable as the first examples of relief printing to be achieved through the use of photography.

Pretsch's use of swelled-gelatin molds was widely adopted by succeeding practitioners in all phases of photomechanical printing up to the perfection of the modern screen. Alphonse Poitevin of Paris claimed priority in making use of a swelled reticulated gelatin mold as a printing surface although there is no evidence to show that he antedated Pretsch. Poitevin also made use of reticulated gelatin in his discovery of the collotype process in 1855.

Halftones in lithography were obtained as early as 1852, shortly after the appearance of Talbot's patent. Lemer cier, a Parisian lithographer, working with Barreswil, Davanne, and Lerebours, sensitized a lithograph stone with asphaltum, exposed it under a negative, and washed the stone with ether, which removed the unhardened areas of asphaltum. The stone was then inked and printed in the usual manner, the grain of the stone providing an ink-holding surface. Some excellent results were obtained, but the costliness of the process, together with the low light-sensitivity of asphaltum and the correspondingly long exposures required, made the process impractical.

Poitevin's 1855 patent, which described the use of bichromated solutions of gum, gelatin, and albumen (white of egg), marked a great improvement in photolithography. The sensitized stone was exposed under a negative, the image was developed under water, with the undeveloped areas washed away, and the stone was inked and printed. J. S. Petit, in his "Modern Reproductive Graphic Processes," 1884, described substantially the same process, with the exception that the stone was inked prior to washing, as the process most in use in photolithography at the time. As a matter of fact, the albumen process was universally used even after halftone screens were adopted in photolithography and is still in standard use.

The first photolithographic halftones in the United States were produced by Cutting and Bradford in 1856, although their patent was dated 1858. The stone or grained zinc was coated with a solution of gum arabic, potassium bichromate, and sugar, exposed in the camera or under a negative, and developed with a solution of soap. It was then inked and printed.

In 1857 Asser developed his photolitho transfer process, patented in 1860, and took the first forward step in the medium since Poitevin. This involved the sensitizing of sized paper with potassium-bichromate solution, exposing under a negative, developing the paper, and inking it. The image was then transferred to stone or zinc and printed. Later workers made extensive use of the transfer method, which was useful, among other things, in eliminating unnecessary handling of the heavy stones.

Developing Talbot's ideas, A. J. Berchtold suggested in 1855 and 1857 a variety of methods for producing screens. These included the interposition of a transparent paper ruled with crossed lines between the negative and the sensitized printing plate. Another interesting idea, set forth in his French patent of 1857, was to cover a glass plate with an opaque varnish and rule lines across it, which would remove the varnish at equal intervals and create a series of fine transparent parallel lines. This screen could then be placed over the photographic image and exposed for as long a time as that which produced the

image. The screen was then to be turned at right angles to the original direction of the lines and the exposure continued, with less time given for the second exposure. The screen was then to be turned diagonally and exposed for a period of still less duration, and a fourth turning on the opposite diagonal would be shortest of all. Berchtold stated that the tones in the darkest areas would be composed of four lines, the next darkest three, two, and one, supplemented as well by dots where the lines intersected. This process, he stated, would reproduce the modeling of the original photograph and could be used for work in relief or typographic printing, gravure, or lithography. Many of his suggestions, which we cannot be sure he himself ever developed, were worked out eventually by later experimenters.

The first workable halftone screen was patented in 1865 in this country by General Frederick von Egloffstein, who also founded the Heliographic Engraving Co., the first commercial establishment in the United States for producing photomechanical halftones. Only Paul Pretsch's Photogalvanographic Co. of London antedated von Egloffstein's organization in the commercial field.

In his patent of 1865 von Egloffstein described his screen, or "heliographic and photographic spectrum for producing line-engravings," as being a sheet of plate glass covered with an asphaltum ground, as used in the making of etchings. A diamond point governed by a ruling machine was then traced over the dark ground, removing the ground and creating transparent lines. A variety of patterns could be traced, running from perfect parallelism to semicircular rhythms. Von Egloffstein's typical screen, however, was a wavy single-line effect made up of minute dashes. These screens were often extremely fine, sometimes running to over 400 lines to the inch. Von Egloffstein exposed his sensitized plate under a screen. His patent describes the procedure as follows:

The spectrum is thus imprinted upon the varnish previous to its receiving the photographic image by means of a second exposure to the light. Both images are thus blended into one, the spectrum giving texture to the photographic image. Then may follow the ordinary heliographic manipulations of developing the picture. The photographic image being the last, and for a longer period exposed, overpowers the spectral image, but only so far as to preserve the delicate half-tints, the spectrum remaining sufficiently strong to serve as a means for holding printer's ink when impressions are taken from the plate.

Von Egloffstein sometimes combined two or more screens, and an examination of his halftones under a glass often reveals a complex pattern of lines, dots, and dashes. His work was exceptionally good, but because of his highly exclusive and secretive workshop practices his business did not prosper. Von Egloffstein never allowed workmen from one section of his shop to visit another section, fearing that the details of his processes would become known and that others might glean the fruits of his labors.

It is necessary here to omit mention of some transitional workers, none of whom had particularly original ideas, and to proceed to Edward and James Bullock of England, who patented a process in 1866 which was put to use in producing halftones in photolithography. The Bullocks' specifications stated:

Our process is to reticulate the negatives, which may be done by placing the copy of a reticulated or granulated surface face to face with any ordinary negative, and copying both together through the light, thus producing a transparency from which a negative must be taken, a print from which upon paper prepared by any of the bichromate and ink processes known in the trade will have the reticulated or granulated appearance aforementioned. This copy with the reticulations may be transferred to a stone or zinc plate, and any number of impressions may be printed off, each bearing the markings or reticulations of the interposed copy with the lights and shades according to the original negative, and bearing all the appearance of an engraving or lithograph.

Varying this process, the Bullocks described the use of a transfer paper, either ordinary or photographic paper, which was coated with a gelatinous solution:

Upon the paper so prepared is printed a granulated or reticulated pattern of any character, composed of dots or lines of ink of any kind or colour having the power partially or completely, according to requirements, of preventing the light acting on the paper beneath. In this case the specks of ink themselves form a medium, and by their aid excessive contrasts are avoided and half tones secured. Such picture when so obtained is passed to a lithographic stone or zinc plate, and a printed proof produced therefrom . . .

During the latter part of the 1860's most experimenters were generally acquainted with the halftone screen, realized its possibilities, and attempted to perfect it as a mechanical instrument. The first worker to produce good practical results was William A. Leggo, of Canada, who, with George E. Desbarats, patented a process in 1871 which incorporated the use of a screen in contact with a negative. Before this period, however, Leggo and Desbarats had patented in 1865 a sort of improved Pletsch method of relief halftone, which they called Leggotype, through the use of a single-line screen and the swelled-gelatin process. Later, this process was the basis for the commercially successful Moss process.

Leggo, who was the laboratory worker while Desbarats was the financial backer, made cross-lined screens through darkened collodion coatings on glass plates. By the use of these screens they made the first halftone reproductions to be printed in any periodical. The first, a portrait of H. R. H. Prince Arthur, appeared in the *Canadian Illustrated News* for October 30, 1869, and was printed by lithography. In 1873 Leggo and Desbarats founded the *New York Daily Graphic*, which became the first daily newspaper in the United States to use illustrations in the modern sense—in other words, the first daily periodical in this country to use photomechanical halftone illustra-

tions. The inside pages, bearing the illustrations, were printed lithographically, and the remainder of the paper, bearing the bulk of the text, was printed by letterpress.

It is likely that difficulties in etching the minute dot structure of relief plates made letterpress less feasible than lithography, at the time, as a medium for use with the halftone screen. However, lithographers in general lost interest in obtaining halftone results during the next two decades. There seemed to be little point in using screens, which resulted in coarse halftones, when type could not be employed at the same time. Screenless halftones in lithography could not compare with the finer products of other processes, and so lithographers concentrated mainly upon line work. After all, excellent halftones were already obtainable through the photogravure and collotype processes. The rapid development of collotype, which made use of principles similar to lithography and which produced finer textures and gradations, was probably an added factor in the decline of the photolithographic halftone in the 1870's. Moreover, the Woodbury process turned out screenless halftones that were distinguishable from photographs only because they were richer in tonal value and finer in detail. In any case the most pressing commercial need for halftone was as a replacement for wood engraving—in other words, in letterpress, where little or no progress had been made from Pretsch's time to the 1880's.

In 1866 Sir Joseph Wilson Swan patented his photomezzotint process, which he claimed was adaptable to typographic (letterpress), intaglio, and lithographic printing. Swan described a variety of procedures, but most interesting for present purposes were those in which he suggested the use of screens. One screen was made by coating a sheet of glass with an opaque etching ground, ruling through the ground to the surface of the glass, and using it as a screen for producing halftone negatives. Another process involved the use of particles of opaque matter either dusted on the negative or incorporated in a solution of gelatin coated over the negative. Of particular importance, however, was his suggestion for using a photographic negative perforated with minute holes. This negative, used as a screen, would result in a diffusion of light, intense at the center and shadowy at the periphery of the openings. This idea, the possibilities of which Swan did not realize at the time, anticipated the principle of modern halftone screens. This English scientist, who was also of pioneer importance in developing the incandescent light, made a further contribution to the diffusion of light in halftone screens in his patent of 1879, which will be discussed later.

Robert Faulkner, in 1872, made the first definite suggestion that a screen out-of-focus be used to create a finer grain structure. Faulk-

ner's English patent otherwise had very little originality, and the screens he suggested using were to be of wire, gauze, insect wings, or other textural materials, but since it did make suggestions for diffusing light, however tentatively, it is worthy of note. Faulkner suggested shading portions of the object during exposure, or throwing it (the object) "a little out of focus by inclining it more or less to the plane of the picture, or a lens may be employed which focuses part but not the whole of the object." Faulkner was concerned with obtaining a greater range of gradation in halftone, striving to create the effect of distance, transparency, and opacity as in nature, and it is this preoccupation that gives meaning to his otherwise fruitless efforts.

With the 1879 patent of Sir Joseph Wilson Swan came the first glimmerings of the modern idea of spreading light through a screen for better gradation. Swan stated, "The screen is moved periodically so that *a stronger impression of the lines* and a greater number of crossings are obtained in the shaded portion, or vice versa if a positive transparency is used." This idea marked something of a turn in the road, for, although Berchtold had spoken of turning the screen in his 1857 patent, his intention had obviously been to create a cross-grain of lines of equal thickness rather than diffuse the light to obtain lines of unequal thickness. While at first glance Swan's idea is almost identical with that of Berchtold, the fact that certain lines were to be stronger than others implies a diffusion of light to obtain heavier or lighter images of the lines on the sensitized plate. These plates, according to Swan, could be used for the swelled-gelatin process or for "photo-etching purposes," or, in other words, for etched halftone relief printing.

In 1881 Frederick E. Ives of Philadelphia patented the first really successful commercial method for creating letterpress halftones. His method, however, conceived in 1878, was slow and indirect, and it did not make use of a screen; nevertheless, it did break up the photographic image into numerous dots of varying size. The Ives process was based upon a swelled-gelatin relief that was used to make a hollowed plaster cast. A glass plate having a surface composed of elastic pyramidal projections was then inked and pressed against the white plaster. Where the swelled-gelatin impression had left the plaster deepest, the tips of the pyramids scarcely touched, and so created fine dots; and, at the other extreme, where the plaster was highest the pyramids would squeeze flat, creating heavy dots. Intermediate portions would receive dots proportionate in size to the varying levels of the plaster. The plaster cast was then photographed and reproduced as line copy. It has been said that Charles Petit of Paris patented a similar process in 1879. This is not quite

accurate—for while Petit's Similigravure was indeed based upon a plaster cast produced by the swelled-gelatin method, it employed a V-shaped graver that moved uniformly over the blackened plaster, producing white horizontal and vertical lines which in effect created black dots of varying sizes in the plaster mold. Petit's method did not work out too well in practice, while the Ives process, commercially promoted by the firm of Crosseup & West, was widely used and yielded some beautiful results.

It should be borne in mind that the mere fact of patenting an idea, however useful, did not ensure that the inventor was able to visualize the steps necessary for carrying it out successfully. Other workers, whose basic ideas were not necessarily original, were able to bring the unsuccessful ideas of others to fruition. These comments are not directed at Ives in this instance, but at George Meisenbach of Germany, who in 1882 patented his halftone process in England. Meisenbach, who has often been termed "the father of halftone" on the strength of his successful commercialization of cross-lined letterpress halftone, used single-line screens that were turned during exposure to obtain cross-lined effects. This idea, as we know, was previously proposed by Berchtold and Swan; but it is evident from the quality of his results that Meisenbach eliminated to some degree the uncertainties of focus that had previously been a barrier to reliable results. Although in point of time the Ives process antedated Meisenbach's Autotypie halftones by a year or so, the fact remains that Meisenbach's firm was probably the first to achieve commercial success with relief halftones made through the use of screens. Meisenbach's earliest work was in single-line halftone, with the screens moved slightly during exposure, and it is probable that cross-line results were not obtained until 1883.

Shifting the scene to America and reverting to an earlier date, we may note that coarse but clear letterpress halftones were made by Pennington & Co. (National Bureau of Engraving) in 1878 through the electrotyped reversals of photogravure plates. In the same year the U. S. Engraving Co. made letterpress prints from single-line screens. In 1880 Stephen H. Horgan produced a number of single-line halftones, including the much publicized Shantytown, which was made from a Leggo screen.

The Mosstype was a popular variety of halftone from about 1885 to the early 1890's. It was made by the Moss Engraving Co. of New York through the use of the swelled-gelatin process in conjunction with single-line screens, although cross-lined effects were obtained also. Since John B. Moss never divulged his methods, it is conjectured that he made an electrotype from the gelatin relief, as in the Leggotype and other variations of Pretsch's process. The dif-

ference in Moss's case was that he added numerous refinements and was able to achieve good results with a heretofore unsuccessful process.

During the 1880's greater efforts than ever before were made to perfect letterpress halftone, or at least to obtain passable results to satisfy the increasing demand for illustrations in newspapers and magazines. Among the processes that achieved a moderate degree of commercialization was the Luxotype, patented in England in 1883 by Brown, Barnes, and Bell. This process had several variations, but in its most widely used version a fine wire mesh was pressed into a moist photograph, embossing and roughening it uniformly. Under a strong oblique light the cross-lined shadows were deepest in the dark areas and lightest in the pale sections. A negative was made, intensified, and printed. The photograph was then used to make line copy. Needless to say, results were coarse but seemingly adequate for certain types of publications.

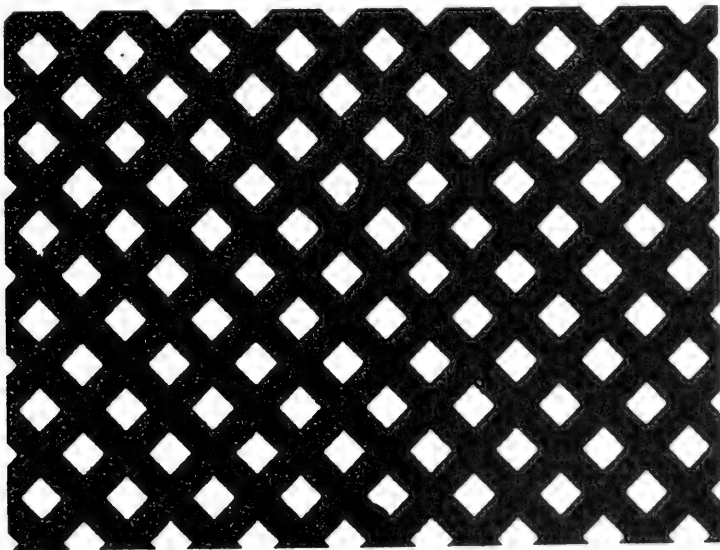

FIGURE 1.—Drawing of halftone screen, greatly enlarged.

The perfection of the halftone screen as we know it today was the result of work carried out independently but at about the same time by Frederick E. Ives and the Levy brothers, Louis and Max, in Philadelphia. Ives in 1885-86 successfully sealed two single-line screens together at right angles and worked out the relationship of screen distance and focal length. His notion of the "optical V," wherein each aperture in the screen becomes a separate lens admitting varying degrees of light, is still the foundation for modern process work. Admittedly some of his ideas were known before, but it seems incontrovertible that Ives first stated them in clear terms and made it possible

to bridge the gap between theory and practice. Garside and Borland, in their separate British patents of 1883, had suggested screens to be placed some distance away from the negative. It is evident that they had no notion that a proper focus was necessary, and nothing came of their patents.

The crowning achievement in halftone screens was the Levy product, which has been unsurpassed from about 1890 to the present day. Although Ives had cemented screens together somewhat earlier, his screens were of the old variety, ruled by a diamond point through darkened collodion coatings. It was the Levys who created a new type of screen, made of the finest optical glass, on which dark lines appeared on a transparent ground. The glass was first coated with an acid-resisting substance. An improved automatic ruling machine, invented by Max Levy, made use of a diamond point in cutting the desired number of lines to the inch on this surface. The fumes of hydrofluoric acid were then used to etch the lines in the glass. After the resist was removed, the lines were defined by filling them with a black substance. Two single-line screens were then cemented together so that the lines formed right angles, creating a cross-lined screen. This method, in its essentials, is still used today.

The Levys' first important patent was granted in 1893, although their screens had been on the market since about 1890. In any case their screens were of such fine quality, so apparently flawless in workmanship, that no other company has been able to dislodge them from their position of preeminence. During the early period, in particular, they were almost without competitors.

The matter of manufacturing halftone screens is far more difficult than it might appear. Glass does not often etch cleanly, and ruling 200 to 400 flawless lines to the inch through asphaltum coatings with a diamond point requires special knowledge and special equipment. Until recently the Levy processes were kept secret. While others tried to manufacture screens of comparable quality, they were unable for many years to do so, and Levy screens became synonymous with the finest work in halftone.

The old photogravure process, invented by Fox Talbot in 1852, had in the meantime risen to first rank among the tonal printing processes, at least from the standpoint of quality. It was universally conceded to be the most "artistic" printing process, and in fact it produced prints of an unequalled richness and beauty of tone. However, this process required more hand work than any other method, and consequently it was also the slowest and most expensive printing method. Nevertheless, it produced such magnificent results that it was widely employed, both for special plates to be tipped into publications and for reproducing paintings and other subjects for separate issue.

The most important improvement in the process was the contribution of Karl Klič, of Bohemia, who in about 1875 employed carbon tissue, a paper coated with pigmented gelatin, originally invented by Swan, which was sensitized with potassium bichromate and exposed under a positive. It was then placed face down on a copper plate coated with minute resin granules which had been made to adhere by heat, and washed with warm water to dissolve the unhardened gelatin and remove the paper backing. The image was thus fixed on the plate with various densities of bichromated gelatin corresponding to the variations of tone in the original. When placed in an acid bath the acid, generally perchloride of iron, etched through the resist to the degree that the levels of gelatin permitted. The result was a plate etched in varying depths, a photoaquatint, that when inked and printed on a copper-plate press reproduced the subject in varying depths of ink. Klič's improvement on Talbot's process was in the use of carbon tissue, which showed the image clearly in pigmented gelatin and which could be firmly fastened to the grains of resin. Klič did not patent this process, which he kept secret for a few years, but it soon became known and was generally used by gravure platemakers from that time on.

The greatest improvement in photogravure, from the standpoint of commerce, was Klič's invention of the rotogravure process so universally used today. In about 1894 Klič etched copper cylinders, probably using a variety of halftone screen and sheets of carbon tissue, which, after exposure under a positive, were squeegeed to the copper cylinder, developed, and etched. Klič's idea was to etch square dots of equal size but varying depths into the cylinder, which, when filled with ink and the surface wiped clean with a steel blade, would create tones depending upon the thicknesses of ink deposited upon the paper. Letterpress halftone, on the contrary, made use of dots of unequal size but of uniform color. In rotogravure a thin ink was used so that the paper showed through in the light tones but less and less as the ink deposits became heavier.

At a single leap rotogravure became a practical, high-speed process. It took some years for others to work out a process comparable to Klič's, which was employed by the firm he set up in England, the Rembrandt Intaglio Company. This organization was the first to make commercial use of the rotogravure process.

Although Klič kept his methods secret, his results clearly indicated the nature of his general conception of platemaking and printing. Between 1901 and 1908 Dr. Edouard Mertens, of Berlin, and Charles W. Saalburg, of East Orange, N. J., succeeded in perfecting the methods now in use. Saalburg, in 1909, patented the process, which, in its essentials, is in present use, although he originally used single-line

screens, exposed twice to create cross-lines, rather than the cross-line screens now in use. Saalburg's firm, the Van Dyck Gravure Company, also made great advances in color, preparing a four-color rotogravure page for the *Printing Art* of June 1908, which is said to be the first example of machine-printed rotogravure in full color ever used in a periodical.

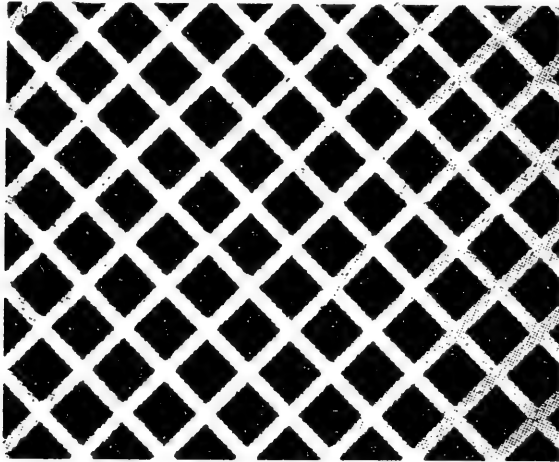
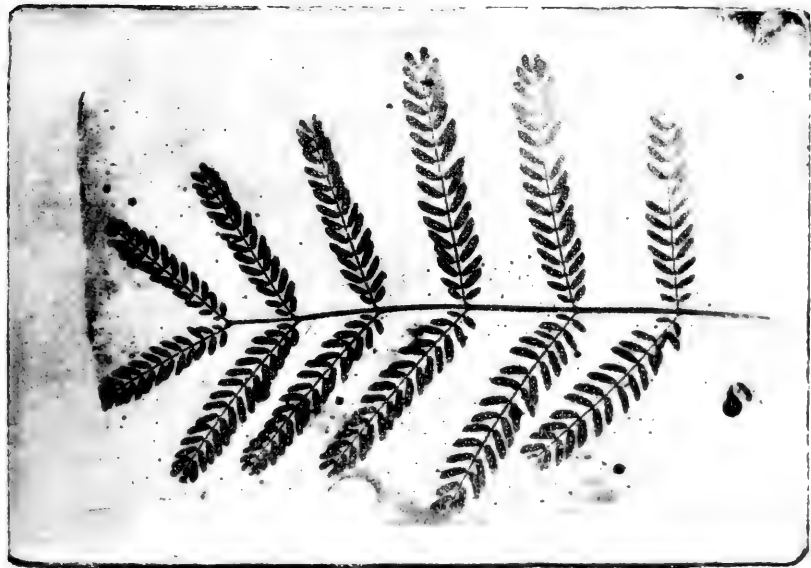

FIGURE 2.—Detail of rotogravure halftone screen, greatly enlarged.

In the rotogravure process a special halftone screen is used, one with opaque squares and transparent lines, a reversal, that is to say, of the usual screen. This screen is placed in contact with the carbon tissue, previously sensitized with potassium bichromate. Upon exposure to light the line structure of the screen is hardened on the tissue, while the dark areas, which prevent the light from reaching the gelatin, remain soft. A positive of the subject is then placed in contact with the carbon tissue and exposed again. This time the light penetrates the previously unexposed gelatin in the square areas and hardens it in proportion to the amount of light received. The tissue is then squeegeed to the copper cylinder, developed, and the unhardened areas and the tissue backing are washed away, after which the cylinder is etched through the varying levels of the gelatin. The resulting image is etched beneath the level of the cylinder to varying depths, with the hardened and unetched lines of the screen forming walls that remain level with the surface. The cylinder is rotated in a trough of thin ink, after which a flexible steel blade held in contact with the cylinder wipes the ink from the surface, allowing the ink to remain in the wells below. The cylinder rotates through the ink, the steel "doctor" blade wipes the excess from the surface, and the image is impressed on paper fed from a cylinder either in separate sheets or from a continuous web of paper. The entire picture is a



PHOTOGRAVURE BY FOX TALBOT
"Mimosa Leaf," 1852, made through the use of a halftone screen composed of several layers of gauze mesh. Right figure, detail enlargement of left.



RELIEF HALFTONE BY PAUL PRETSCH

“Scene in Caeta after the Explosion,” produced by de la Rue and Pretsch in London, 1854.



PHOTOLITHOGRAPHY BY LEMERCIER

"Gate of a Romanesque Church," photographed on stone by Lemercier, Lerchbourg, Barreswil, and Davanne and printed by Lemercier in Paris, 1852-53, using his asphaltum process.

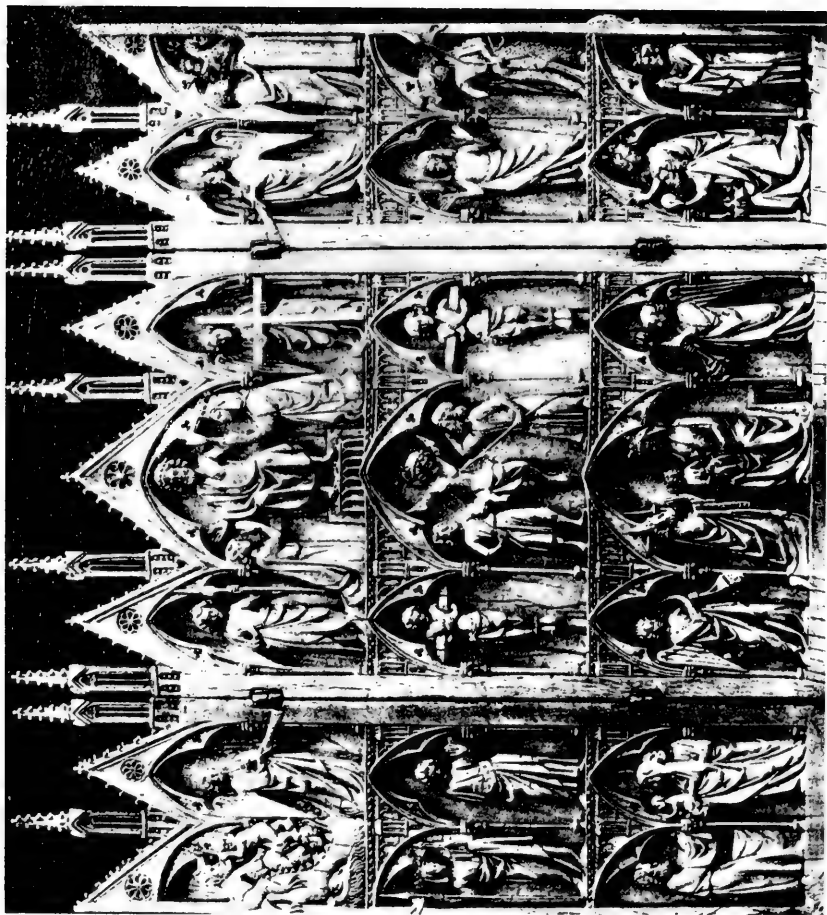

PHOTOLITHOGRAPHY BY LEMERCIER, USING POITEVIN'S PROCESS
Sculptured triptych printed by Alphonse Poitevin's albumen process. Poitevin sold his process to Lemercier in 1857.



PHOTOGRAVURE BY FREDERICK VON EGLOFFSTEIN
"Diseased Bone," made by Von Egloffstein through a
combination of wavy-line and horizontal screens in 1865.

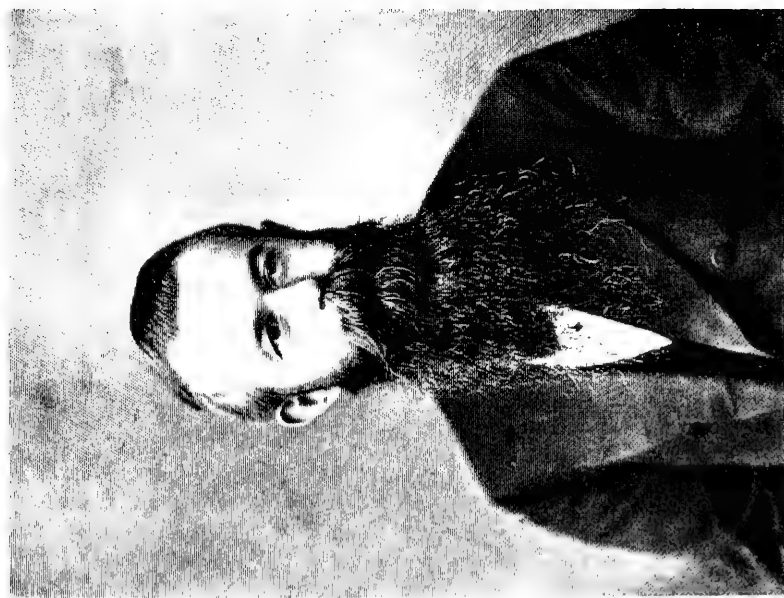

RELIEF HALFTONE BY FREDERICK E. IVES
"Edward J. Wilson," Ives Process halftone from *The
Philadelphia Photographer*, June 1881.



PHOTOLITHOGRAPHY BY WILLIAM A. LEGGO

"View of a Church," made about 1873 through a cross-line screen.



RELIEF HALFTONE BY GEORGE MEISENBACH
"Sarah Bernhardt," cross-line half-tone by
Meisenbach Co., London, from supplement
to *Photographic News*, London, November
23, 1883.



RELIEF HALFTONE BY BROWN, BARNES & BELL CO
Enlarged detail of Luxotype made in 1883 through the
use of wire-mesh screen.



ROTARY PHOTOGRAPH BY KARL KLIC

"Clorane," cross-line intaglio halftone by the Rembrandt Intaglio Printing Co., London. From supplement to *Land and Water*, January 18, 1896.

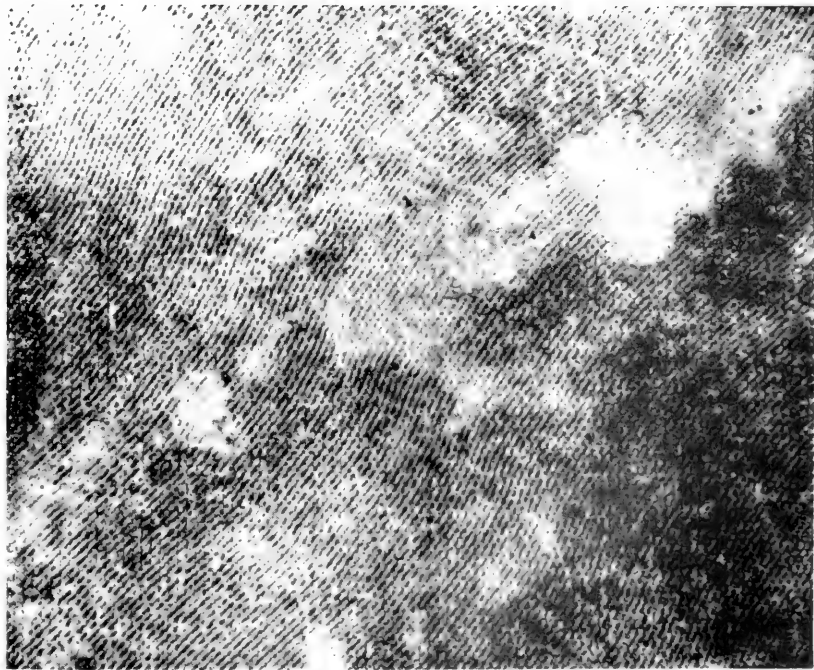

1. Photomicrograph of Frederick von Feilitzstein. Detail of plate 2, figure 2, *Journal of Polymer Science*.

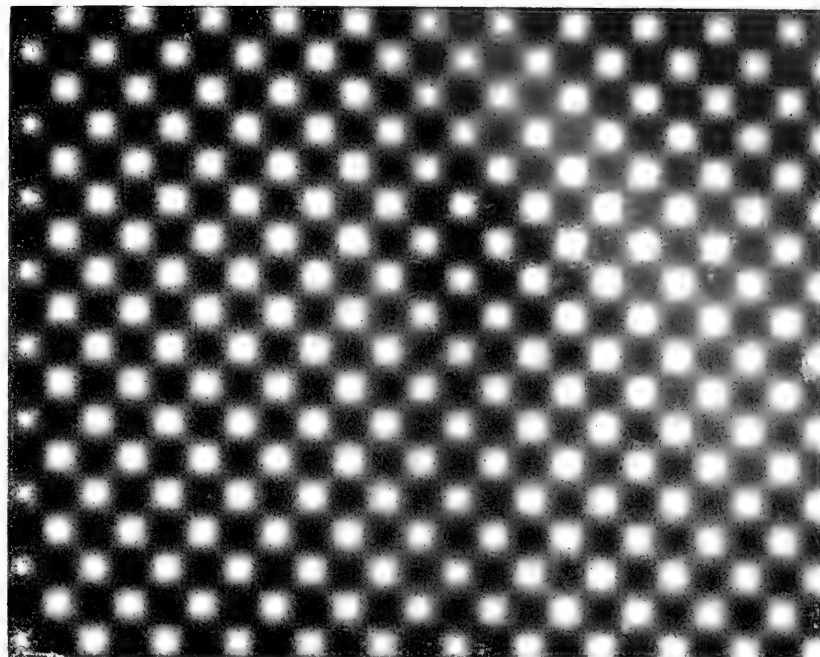

2. Photograph of Frederick von Feilitzstein. Plate 2, figure 2, *Journal of Polymer Science*.

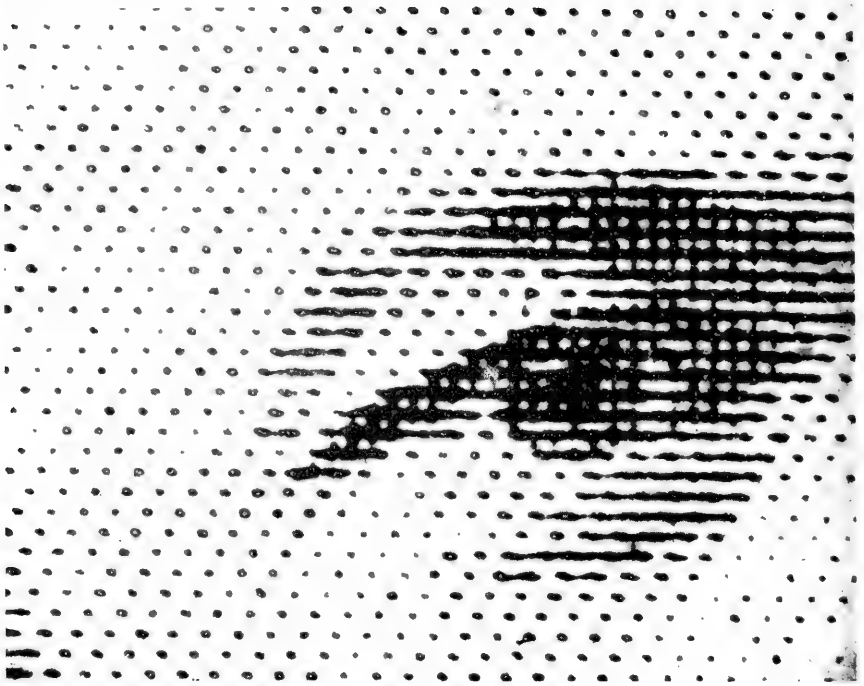

1. Relief halftone by Frederick E. Ives. Detail of plate 5, figure 1, greatly enlarged.

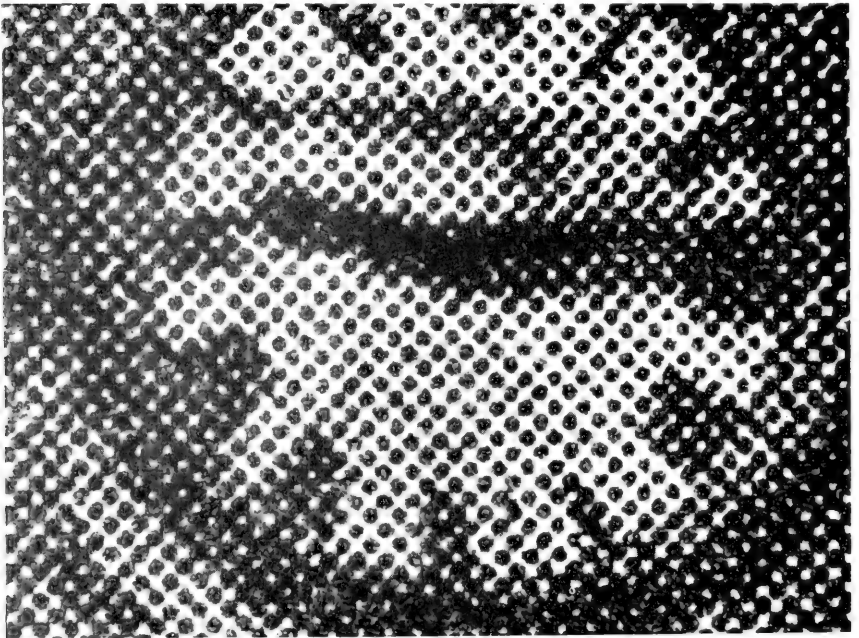

2. Photolithography by William A. Leggo. Detail of plate 6, greatly enlarged.

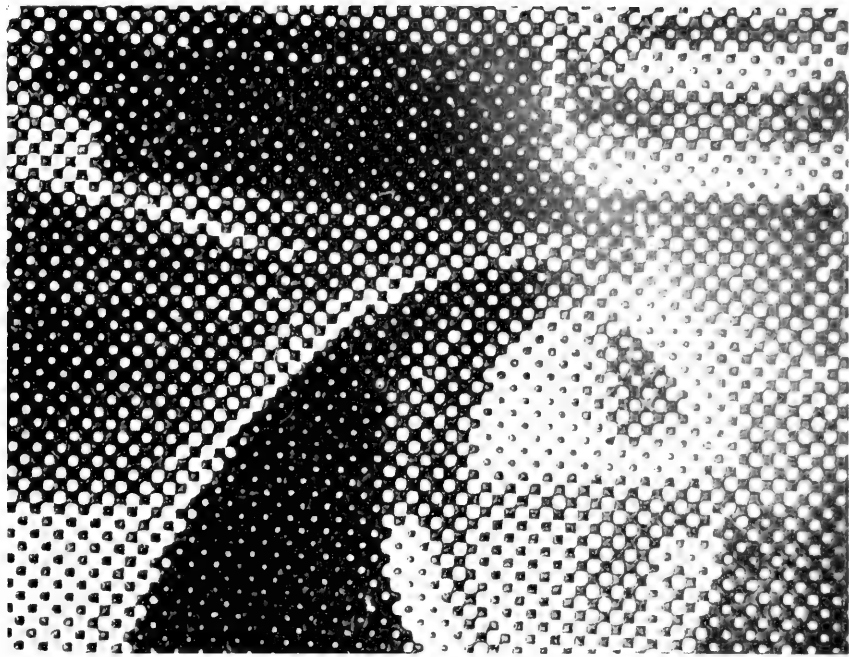

1. Modern relief halftone. Detail of plate 12, greatly enlarged, showing dots of different sizes but even intensity of color.



2. Rotary photogravure by Karl Kliç. Detail of plate 12, greatly enlarged, showing square dots of equal size but varying depths of tone. A darker area in the foreground, which contributes to a sense of depth.



Modern relief half-tonne. Cadillac gasoline automobile, 1903. From U. S. National Museum Bulletin 198, "Catalog of the Automobile and Motorcycle Collection of the Division of Engineering, U. S. National Museum," by Smith Hempstone Oliver, 1950.

continuous tone of ink, running from transparency to opacity depending upon the amount of ink in the wells, except for the fine lines of the screen, which remain without ink, having provided a surface for the "doctor" blade to wipe.

During the first quarter of the twentieth century numerous screens were suggested and developed, and many were designed to produce unusual line patterns and textural effects, but the overwhelming majority were the cross-lined halftone and rotogravure screens. Another type of screen that was popular for some years after the turn of the century was the mezzograph screen, patented by James Wheeler in England in 1897. This screen contained no pigment and resembled a sheet of frosted glass. It was made by coating a glass plate with minute drops of liquid resin, which acted as an acid resist, and etching with hydrofluoric acid. When the resin was removed the glass was uniformly pitted and composed of levels of transparency. Used as a screen in photoengraving, this glass produced a granular structure in the final printing, which, while sometimes too evident, was well suited to certain types of subjects.

In 1928 A. Ronald Trist, of England, inventor of the bimetallic Pantone process of lithographic printing, patented a screen which in principle anticipated the present variable-opacity or contact screen developed by Kodak. Trist used an electrically rotated disk in conjunction with standard screens. By this means he could produce vignettted densities in transparent celluloid-process films. The resulting screens could then be used for contact printing, being particularly serviceable in his lithographic process.

The variable-opacity or contact screen was developed to correct some of the shortcomings of the conventional cross-line screen. Contrast is often difficult to control, and tone reproduction, consequently, is often uncertain. Variable-opacity screens are intended to correct this uncertainty and in addition to take less camera time. Problems of focal length are overcome since the screens are placed in contact with the sensitized film. Gradations of light are managed by variations in dot intensity, the most opaque points being the centers of the dots, which fade out gradually to translucency at the peripheries.

Several proposed variable-opacity screens led up to the Kodagraph screens, the first of which was patented in 1942 and 1943. This earlier Kodagraph screen, orange in color, was used with a continuous-tone magenta negative placed in contact with Kodalith film. The positives obtained were composed of dots—like those produced by the Levy screen—and contrast control was secured by variation in relative amounts of orange and red light during exposure. The later improved screen, magenta in color, produced negatives rather than positives. The screen was used primarily in lithography, but screens for photoengraving are now used commercially.

The halftone plate now used in letterpress printing begins with a screen placed in the camera at a proper distance from the sensitized film. The image is photographed through the screen, the light passing through the clear squares so that the original image is broken up into minute dots of varying sizes depending upon the fineness of the screen and the amount of light reflected from the copy. The film negative is then stripped from its celluloid or glass base, placed upon a piece of clear glass, and exposed to strong light over a copper plate coated with a solution of bichromated gelatin. Light hardens the portion of the plate which will eventually become the raised or printing surface. The unhardened gelatin is washed off, exposing the bare copper for etching. The plate is then etched in several stages with perchloride of iron, the sides of the dots being dusted with an acid resist, dragon's blood, at each stage. The dots in relief, when inked and printed, recreate the original. This brief summary merely touches upon some of the most important operations in platemaking and gives no indication of the skill and care required.

Many important developments, particularly in recent times, have been omitted because of the necessity for condensation. Nevertheless, we have touched upon the high points in the growth of the halftone process, and noted how the development of a reliable screen was the main factor in finally removing the barriers to cheap, rapid, and faithful reproduction of continuous-tone pictures. The achievements were not confined to letterpress, as we have seen, but were carried over into lithography and gravure as well. It was letterpress, however, the last major process to obtain photomechanical halftones, that began the era of modern high-speed printing of halftone subjects.

From this beginning sprang great industries, trades, more rapid means of communication, clearer and more efficient means of education, and other technical advances that have done so much to give our civilization its distinctive character. Our modern conception of advertising, for example, with its stimulus to business, leans very heavily upon the use of the halftone screen. The present wide use of color printing, with its added attractiveness and veracity, would not have been possible without the perfection of the halftone screen. It has made possible the popular and widely circulated picture magazines through which much entertainment and educational matter is given mass circulation. It serves as an indispensable tool in recording scenes and events for immediate use in newspapers and in news periodicals. It is indispensable in preparing such printed advertising as mail-order catalogs, which serve the public as pictorial department stores. Technical books, art books, children's books, posters, calendars, greeting cards, house organs, fiction and home magazines—these and publications of a hundred other kinds all derive a great part of their beauty and effectiveness from the use of halftones.

It is possible that the halftone screen will eventually be superseded by other, more efficient, instrumentalities for obtaining toned pictures in the printing press. The rise of electronics is already responsible for a device, in successful although limited commercial use, for obtaining coarse and moderately fine halftones without the use of a screen. The Fairchild Photo-Electric Engraver, the Fairchild brochure states, "is an electro-mechanical device for producing halftone engravings on plastic material without recourse to photography or the use of chemicals." It makes use of an amplifier system by means of which the tonal details of the photograph to be reproduced are transmitted from the electronic scanning assembly to the engraving assembly. Fine dots are burned into the plastic plate by a heated stylus. Halftones can be made corresponding to 65-, 85-, and 120-line screens. At present the Fairchild machine is used chiefly in newspaper work, where the comparative speed and simplicity of the process is a great advantage. In any case, whatever the future may hold, the halftone screen has played and is playing its part in creating a ceaseless flow of pictorial material for a worldwide public. This piece of glass marked by intersecting lines—this delicate screen to which the halftone owes its existence—has proved to be one of the truly important contributions to industry and culture in the modern world.



The Artist and the Atom¹

By PETER BLANC

Art Department, American University

[With 5 plates]

It is a commonplace of contemporary thought that the period of the last hundred years has been preeminently an age of science. All fields of intellectual endeavor exhibit signs of the infiltration and influence of the scientific attitude, and all display scars, indeed open and still bleeding wounds, inflicted by the penetration of the new and shocking discoveries, theories, and conceptions of modern science. The plastic arts have been no exception, and critics and art historians are at one in perceiving a connection between science and modern art from the impressionists to date. But the particular aspects of scientific thought which appear in modern painting and sculpture have not been analyzed. It is the purpose of this article to establish that the connection between modern science and modern art lies predominantly in that field of scientific thought which is the most disturbing, and by the same token the most enlightening, to the philosophical thinker: the field of research into the basic composition of the universe and all that it contains—the theory of atomic matter.

In the early years of the nineteenth century the scientific center of the world was Paris. In France during the eighteenth century science had permeated literature—Fontenelle, Voltaire, Buffon—and this connection between science and literature was maintained during the early nineteenth century largely owing to the constitution of the Académie des Sciences as part of the Institut. In Germany, on the other hand, science was merely the handmaiden of philosophy, and science courses at the universities were taught on the basis of doubtful philosophic theories. The situation in Germany was more typical of the period than was that in France, for on the whole the scientists were then working in obscurity in the laboratory, conducting experiments and accumulating the mass of data which in the main was not to be synthesized into general principles and disclosed to the public till the last half of the century.

¹ Reprinted by permission from Magazine of Art, vol. 44, No. 4, April 1951. Copyright by the American Federation of Arts.

But at the midcentury the situation changed. The scientists came out of the laboratory and took to their writing desks. The period from 1850 to 1870 saw few new discoveries but witnessed the development and clarification of general laws and principles drawn from the data accumulated during the preceding 50 years. The principles of the conservation of matter, the law of the dissipation of energy, Dalton's atomic theory, the theory of evolution, all achieved acceptance and popularization as scientific books poured from the presses. These new and revolutionary concepts seized the imagination of the intellectuals, and the new gospel of science spread throughout Europe, breaking down the old intellectual isolation of the nations.

The new spirit manifested itself immediately in the form of "realism." In literature, the scientific method of documentation and accumulation of evidence found its reflection in the works of Zola and the Goncourts and in such books as Flaubert's "Madame Bovary" (1856). Much the same dispassionate statement of contemporary facts appears in the painting of Courbet, while the sociological intention of these writers is paralleled by the more dramatic works of Daumier. But these artists demonstrate merely the turning point of artistic expression. Their innovations were in subject matter rather than in the structural elements of composition or the manner of laying the paint on the canvas. The impact of scientific developments in these respects first appears in the work of the impressionists.

One of the main characteristics of impressionism is the laying on of the paint in small, clearly visible blobs, dots, or curlicues throughout the entire surface of the canvas. It is this continuous subdivision of the canvas surface into innumerable tiny dots and particles of paint, more than any other feature, that distinguishes impressionist painting from previous styles and it is this characteristic which most closely concerns us.

One of the few novel scientific theories that had been voiced during the first half of the nineteenth century was the theory that all forms of matter—gaseous, liquid, or solid—are composed of innumerable tiny particles of indestructible, solid, concrete matter. In gases, these particles were conceived as loosely associated, much like a swarm of bees, capable of independent movement, collision, and flight; in liquids they were more closely united, acting much in the manner of grain pouring down a chute; in solids they were linked together in the manner of a crowd of people holding hands, capable of jostling about to some degree but incapable of seriously altering their relative positions. Although numerous scientists of differing nationalities contributed to this conception, the Englishman John Dalton is generally acknowledged as the father of the theory. In his "New System of Chemical Philosophy" (1808) Dalton first advanced his theory, saying:

There are three distinctions in the kinds of bodies, or three states, which have more specifically claimed the attention of philosophical chemists, namely, those which are marked by the term elastic fluids, liquids, and solids. A very famous instance is exhibited to us in water, of a body, which, in certain circumstances, is capable of assuming all three states. In steam we recognize a perfectly elastic fluid, in water a perfect liquid, and in ice a complete solid. These observations have tacitly led us to the conclusion which seems universally adopted, that all bodies of sensible magnitude, whether liquid or solid, are constituted of a vast number of extremely small particles, or atoms of matter bound together by a force of attraction, which is more or less powerful according to circumstances. . . .

Dalton was somewhat overoptimistic about the universal adoption of his atomic theory of matter. The lack of distinction between the chemical atom (the smallest particle of matter which can enter into combination) and the physical molecule (the smallest particle which can exist in a free state and which may consist of one or more atoms) caused dire confusion and conflict among scientists until the international convention of chemists held at Karlsruhe in 1860. Only then, after a debate of fifty-odd years, did Dalton's atomic theory achieve universal recognition. It seems more than a coincidence that during the very decade in which the scientific world recognized that the universe and all that it contained was composed of tiny dots and dabs of matter, the impressionists first painted pictures composed solely of tiny dots and dabs of pigment.

The writer is not suggesting that the impressionists consciously and deliberately sought to imitate the dance of the atoms when they painted canvases composed of vibrating particles. Ostensibly their interest was in light, in the reflections of light, and even in the "reflections of reflections." But it cannot be denied that in pursuing this objective they succeeded in producing paintings which did, in fact, poetically evoke the image of the world which the scientists had created, and that they produced these paintings immediately after that image had been finally accepted by science as factually correct and had been given widespread publicity in books, articles, and lectures throughout the world. It is more than possible that a less conscious and deeper motivation joined with their consciously assumed purpose to develop the impressionist style of painting. As Pissarro wrote in 1895:

Impressionist art is still too misunderstood to be able to realize a complete synthesis . . . I remember that, although I was full of ardor, I didn't conceive, even at forty, the deeper side of the movement we followed instinctively. It was in the air! [Letters to His Son Lucien, New York, 1943.]

What was in the air in the 1860's was the atomic theory, and it cannot be seriously doubted that the impressionist painters were familiar with it, for their interest in science and their scientific studies would inevitably have brought this new development to their attention.

The scientific attitude with which the impressionists approached their art is well known; they themselves did not hesitate to acknowledge their debt to science. Their spokesman, Pissarro, in answer to a letter from de Bellio arguing that scientific research into the nature of color and light, anatomy, and the laws of optics could not help the artist, replied:

Now everything depends on how this knowledge is to be used. But surely it is clear that we could not pursue our studies of light with much assurance if we did not have as a guide the discoveries of Chevreul and other scientists. I would not have distinguished between local color and light if science had not given us the hint; the same holds true for complementary colors, etc.

The neoimpressionists, Seurat and Signac, devoted themselves to scientific research, studying Maxwell's experiments, Charles Henry's treatises, the analyses of light and color made by the American scientist N. O. Rood, and Chevreul's color theories. Until he severed his connection with the neoimpressionists, Pissarro used to refer to this group as the "scientific impressionists" as opposed to Monet, Renoir, and Sisley whom he scornfully termed the "romantic impressionists." Romantic or not, these painters were scientifically minded, too, for Monet as well as Seurat had studied the optical discoveries of Helmholtz and Chevreul. Helmholtz, who was an exponent of Dalton's atomic theory, pointed out in a work entitled "On the Relation of Optics to Painting" a relationship between the atomic theory and the appearance of certain effects of light. After stating that the turbid appearance of the earth's atmosphere is caused by fine transparent particles of varying density and refrangibility which fill the air, Helmholtz says:

But science can as yet give no explanation of the turbidity in the higher regions of the atmosphere which produces the blue of the sky; we do not know whether it arises from suspended particles of foreign substances, or whether the molecules of air themselves may not act as turbid particles in the luminous ether.

It is hard to believe that this passage could have escaped the eyes of a painter interested in Helmholtz's writings. Thus it is altogether possible that a conscious interest in the effects of light and air joined forces with a deeper and less conscious reaction to the startling facts of the atomic structure of the universe to produce the impressionist manner of painting. And indeed, when we examine the works of the impressionists, we must admit that in fact they are less expressive of light and air than they are of a world composed throughout of dense, vibrating, and homogeneous particles of matter.

At the end of the century painting began to move away from impressionism and, in fact, away from the scientific spirit generally. Gauguin, indeed, led a one-man crusade against the scientific attitude. In a letter to Charles Morice dated April 1903, he says:



1. Jackson Pollock, "No. 10, 1950." Oil 65 x 36 1/2 inches, collection Mrs. Richard Deutsch. Photograph by Hans Namuth. Courtesy Betty Parsons Gallery.

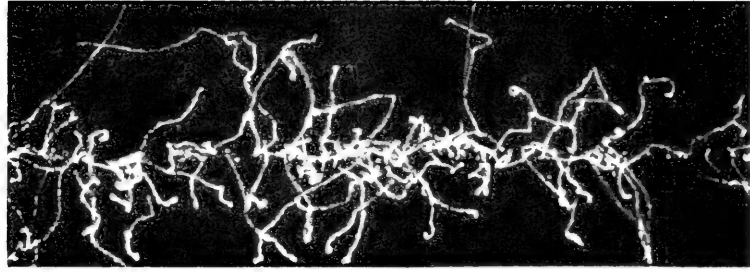

2. Traces of electrons photoelectrically ejected from molecules of air by X-rays. From G. Amaldi, *Misleri della Materia*, Milan, 1950.

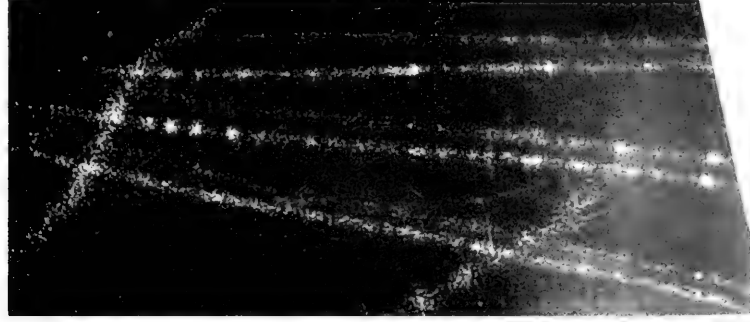

3. Cloud-chamber photograph of a particle electron shower. From Montgomery, *Cosmic Ray Physics*, Princeton, 1949. Courtesy Dr. Wayne E. Hazen.



1. Pablo Picasso, "Braque," 1909. Oil, 24 $\frac{1}{4}$ x 19 $\frac{3}{4}$ inches. Collection of Edward A. Bragaline.



2. Wassily Kandinsky, "Improvisation No. 30," 1913. Oil, 43 $\frac{1}{2}$ x 43 $\frac{3}{4}$ inches. Art Institute of Chicago.

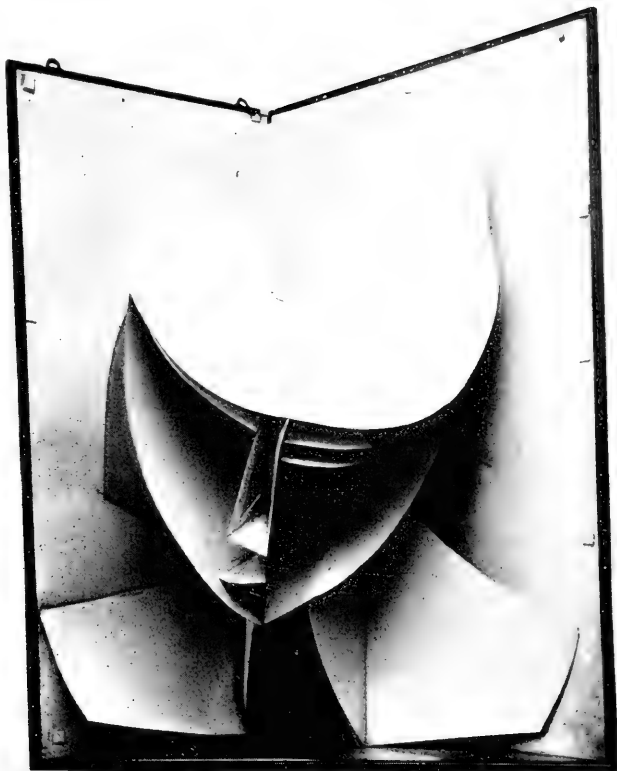

1. Naum Gabo, "Head of a Woman," c. 1926. Plastic, $24\frac{1}{2}$ x $19\frac{1}{4}$ inches. Collection of Museum of Modern Art.



2. Jack Tworikov, "Green Landscape," 1949. Oil, 36 x 42 inches. Courtesy Egan Gallery.



1. Matta, "The Vertigo of Eros," 1944. Oil, 77 x 99 inches. Museum of Modern Art.



2. Alexander Calder, "Mobile," 1939-1940. Steel wire and sheet aluminum, height 60 inches. Metropolitan Museum of Art.

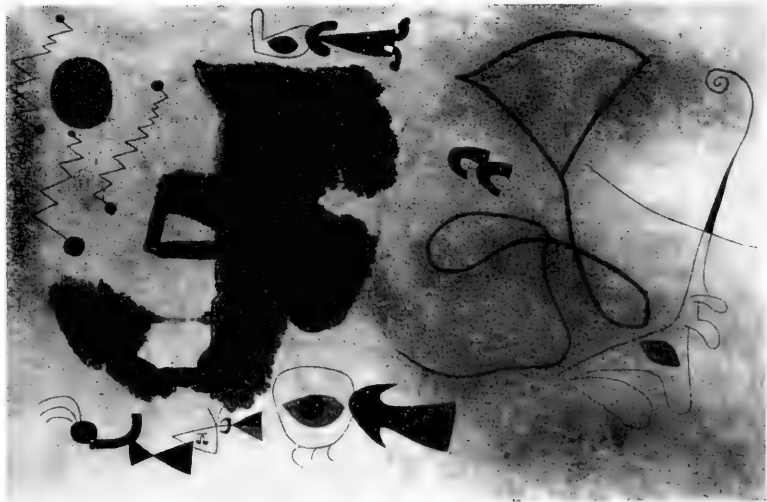

1. Joan Miró, "Sunrise," 1946. Oil, 41 $\frac{3}{4}$ x 27 $\frac{1}{2}$ inches.
Courtesy Pierre Matisse Gallery.



2. A star formed in the gas of the cloud chamber showing evidence of neutrons. After W. M. Powell. From *Montgomery, George. Rays in Physics*, Princeton, 1949.

Artists have hopelessly lost their way in recent years due to physics, chemistry, mechanics and the study of nature. Having lost their primitive force, and being out of touch with their instincts, one might say with their imaginations, they have pursued a hundred paths in search of productive elements which they lacked the strength to create themselves.

But this rebellion was doomed to failure, for already by 1903 science was well on the way to developing new "productive elements" to fire the artist's imagination.

The new development began with the work of Henri Becquerel in France in 1895. Becquerel, and later the Curies, discovered that uranium, radium, and certain other minerals emitted invisible rays which could move through space and penetrate various materials, even affecting and destroying living tissues. Experiments with these alpha, beta, and gamma rays led to the conclusion that they were actually particles of some kind, a stream of infinitesimally tiny bullets shooting through space. Further experiments led to the discovery that radiation of this sort ultimately caused the element radium to transmute itself in a series of stages to the element lead. Now to transform an element is to transform its components, i. e., its atoms. Consequently the physicists were forced to the revolutionary conclusion that the atom was not the imperishable, indivisible billiard ball, which the nineteenth century had supposed it to be, but was actually composed of multiple and divisible constituents.

Another line of research simultaneously being pursued by other scientists related to the effects of passing electrical discharges through gases. The famous X-ray was discovered by Konrad Röntgen in Germany in 1895, and during the next few years the Englishman J. J. Thompson conducted a series of experiments with cathode tubes, finally reaching the conclusion that electricity itself consisted of infinitesimal particles (now known as electrons) 1,840 times lighter than the lightest known atom, that of the element hydrogen. In 1899 Thompson published his conclusions, saying:

I regard the atom as containing a large number of smaller bodies which I will call corpuscles. . . . In the normal atom, this assemblage of corpuscles forms a system which is electrically neutral. . . . Electrification of a gas I regard as due to the splitting up of some of the atoms of the gas resulting in the detachment of a corpuscle from some of the atoms. . . . On this view, electrification essentially involves the splitting up of the atom, a part of the mass of the atom getting free and becoming detached from the original atom. [Philosophical Magazine, ser. 5, vol. 68, p. 565.]

Thus by the end of the nineteenth century these two lines of experiment had independently resulted in the conclusion that the atom was not the ultimate form of matter but was itself composed of smaller subatomic particles, although the manner in which the constituent parts of the atom were associated was still unknown.

Investigation of this problem was immediately undertaken by numerous scientists, and by 1903 Lenard in Germany had proved to his own satisfaction that cathode rays could pass through thousands of atoms without disturbing their internal organization. The conclusion he reached was that the greater part of the atom must be empty space, only about 1,000 millionths of the whole being solid matter. Lenard's experiments, however, were not accepted as conclusive, and the investigations were continued by others, finally culminating in 1911 when Rutherford published his well-supported findings that the atom was in effect constituted on a solar-system basis—tiny electrons revolving around a nucleus as the planets revolve around the sun, with the empty spaces between these elements proportionately as huge as the empty spaces of the solar system.

These dramatic and revolutionary discoveries not only shook natural science to its foundations but also aroused the greatest interest outside the narrow world of the physicists. As Eddington has expressed it in "The Nature of the Physical World":

When we compare the universe as it is now supposed to be with the universe as we had ordinarily preconceived it, the most arresting change is not the rearrangement of space and time by Einstein but the dissolution of all that we regard as most solid into tiny specks floating in void. That gives an abrupt jar to those who think that things are more or less what they seem. The revelation by modern physics of the void within the atom is more disturbing than the revelation by astronomy of the immense void of interstellar space.

The atom is as porous as the solar system. If we eliminated all the unfilled space in a man's body and collected his protons and electrons into one mass, the man would be reduced to a speck just visible with a magnifying glass.

The repercussions in the field of the plastic arts were immediate, the first parallel artistic development being analytical cubism.

In 1907, following Lenard's announcement and while Rutherford was still engaged in experimental work, Picasso painted his famous "Demoiselles d'Avignon," in which for the first time he portrayed parts of forms and objects as irregular receding and protruding angular planes. This development was continued in 1908 and 1909 by Picasso himself, and by Braque with paintings composed largely of the facets of blocklike forms. In 1908 the name "cubism" was first applied to this new manner wherein angular planes definitely suggest the projecting facets of solid sculptural cubes partially embedded in the canvas. In the portrait of Braque painted toward the end of 1909, however, this sense of solidity begins to give way. To quote Alfred Barr in "Picasso" (1946), "not only the surface is broken into facets but the facets themselves begin to slip so that the sense of solid sculptural form so clearly preserved in the 'Fernande' seems on the point of disintegration. For the first time the integrity, the unity, of the object is seriously threatened." In the "Portrait of Kahnweiler" and the "Nude" of 1910, this tendency has enormously increased. The facets

have "slipped" very definitely, opening up a complex of hollows and spaces within the object. By 1911—the year in which Rutherford announced his conclusion that the atom is in fact almost completely a void—Picasso was painting objects which, though still recognizable as familiar solids, were represented as largely composed of empty space.

Again, it is not the writer's intent to establish that the cubists deliberately and consciously sought to exploit or adapt the findings of contemporary science to their painting. Indeed Picasso has hotly denied any such intention. But the parallelism of their vision of matter and the image evoked by contemporary scientific findings, and the extraordinarily exact chronological coincidence of the developments, speak for themselves. No man can assert with assurance that his conscious actions have not been in part provoked by unconscious considerations, and it is natural to believe that sensitive artists living in the first decade of the twentieth century were at least subconsciously influenced by the profoundly disturbing revelations of contemporary science, provided that they were aware of them. And there is evidence to establish this awareness. It is the testimony of Guillaume Apollinaire, spokesman of the cubists, that current scientific developments preoccupied these artists, and that some members of the group, at any rate, pored over scientific works. Writing in 1913, while the cubist movement was still strong, Apollinaire said:

Today, scientists no longer limit themselves to the three dimensions of Euclid. The painters have been led quite naturally, one might say by intuition, to preoccupy themselves with the new possibilities of spatial measurement which, in the language of the modern studios, are designated by the term: the fourth dimension.

The criterion of pure painting: abstract space. Regarded from the plastic point of view, the fourth dimension appears to spring from the three known dimensions: it represents the immensity of space eternalizing itself in all directions at any given moment. It is space itself, the dimension of the infinite. . . . Finally, I must point out that the fourth dimension—this utopian expression should be analyzed and explained, so that nothing more than historical interest may be attached to it—has come to stand for the aspirations and premonitions of the many young artists who contemplate Egyptian, Negro, and Oceanic sculptures, meditate on various scientific works, and live in the anticipation of sublime art. [The Cubist Painters: Aesthetic Meditations.]

This preoccupation with space seems very natural in a world whose inhabitants have just been informed that all the familiar objects which they have habitually considered to be concrete and solid—including even their own persons—are chiefly constituted of empty space.

But cubism was not the only new art form to develop in this critical period. The development of nonobjective painting dates from 1912. The Russian painter Wassily Kandinsky was the first artist who deliberately sought to eliminate recognizable objects from the contents

of his paintings. Kandinsky started life as an economist and statistician. The change-over from what he called "the sciences" to art was a long and painful process. His first abstract painting appeared in 1911; a series of nonobjective etchings followed in 1912. His painting took various directions during his life, but the vast majority of his works are suggestive of objects suspended in space, reminiscent of Eddington's "specks floating in the void."

In his autobiography, written in 1913 and revised and republished in Moscow in 1918, Kandinsky gives a full account of the role played in his development by the atomic discoveries of modern science. After discussing his work at the University of Moscow in the fields of political economy, law, and ethnology, and the unsatisfied yearning to paint that plagued him during this period, he writes:

But in those early days, my artistic powers seemed to me too weak and insignificant to entitle me to abandon my other studies and lead the life of an artist . . . And at that time, when the Russian social picture was particularly somber, my studies were appreciated by many and I decided to train for a scientist. . . .

It was around that time that two events took place, both of which were to influence me strongly in my future life. The first was the exhibition of French Impressionists that was held in Moscow, one of the pictures being *The Stack of Hay* by Claude Monet. The second was the production of Wagner's *Lohengrin* at the Grand Theatre.

Up to this time I was familiar with the realistic school of painting, and—at that—chiefly with the work of the Russian painters. . . .

And then suddenly, for the first time in my life, I found myself looking at a real painting. It seemed to me that, without a catalogue in my hand, it would have been impossible to recognize what the painting was meant to represent. This irked me, and I kept thinking that no artist has the right to paint in such a manner. But at the same time, and to my surprise and confusion, I discovered that it captivated and troubled me, imprinting itself indelibly on my mind and memory down to its smallest detail. But, on the whole, I could make neither head nor tail of it, and was, therefore, quite incapable of arriving at the conclusions which later appeared so simple.

But what did become clear to me, was the previously unimagined, unrevealed and all-surpassing power of the palette. Painting showed itself to me in all its fantasy and enchantment. And deep inside of me, there was born the first faint doubt as to the importance of an object as the necessary element in a painting. . . .

It was in *Lohengrin* that I felt the supreme incarnation and interpretation of this vision through music. . . .

I could see all my colors, as they came to life before my eyes. Madly, in raging profusion, they drew themselves in my mind . . . it became totally clear to me that art in general possessed a far greater power than I ever had imagined. I also realized that painting possesses the same power as music. It was then that the impossibility of devoting myself to the seeking of these powers became an even greater torment. The temptation to do so was overwhelming. . . . And just then, one of the most formidable obstacles on the way to the realization of my wishes, crumbled and vanished by itself, all thanks to a purely scientific event. This was the disintegration of the atom.

This discovery struck me with terrific impact, comparable to that of the end of the world. In the twinkling of an eye, the mighty arches of science lay shattered before me. All things became flimsy, with no strength or certainty. I would hardly have been surprised if the stones would have risen in the air and disappeared. To me, science had been destroyed. [Quoted by Hilla Rebay, *In Memory of Wassily Kandinsky*, p. 53, New York, 1945.]

And so Kandinsky, impelled by discoveries concerning the atom, became the father of nonobjective painting.

Thus we find the two great developments of twentieth-century painting, abstraction and nonobjectivism, coming into being almost simultaneously with science's revelation of the void within the atom—abstraction achieving its first flower in the work of the analytical cubists in 1911, the very year of Rutherford's disclosures, and non-objective painting making its first appearance in the work of Kandinsky in 1912. It is hardly surprising to find that a third development, this time in the field of sculpture, followed hard upon the others.

It is generally considered that the constructivist movement in sculpture, characterized by the substitution of openwork forms in place of the closed monolithic form of the sculpture of the past, began in 1913. Boccioni, Italian painter and sculptor, declared in the futurist manifesto of 1914: "The circumscribed lines of the ordinary enclosed statue should be abolished. The figure must be opened up and fused in space." Naum Gabo, one of the earliest and best-known constructivists, has stated this even more simply: "Older sculpture was created in terms of solids; the new departure was to create in terms of space."

Although the new conception of sculpture lagged somewhat behind painting and unquestionably was derived at least in part from the cubists, whose work was familiar to both Gabo and his brother, Pevsner, another of the constructivist leaders, Gabo's own interests lay in science as well as art. He had studied mathematics, physics, chemistry, and engineering at the University of Munich in the years 1909 to 1912. Consequently there can be no doubt that he was well acquainted with the developments in atomic theory that occurred in this period. Thus it would appear that the constructivist movement in sculpture, like cubism and nonobjective painting, was carried out by artists who had access to and were interested in current scientific discoveries. Under these circumstances, even in the absence of such direct testimony as Kandinsky's, the coincidence of three most important innovations of modern art with the revelation of the Rutherford atom cannot be passed over as accidental.

The theory of atomic matter was not to stand on Rutherford's conclusions, however, for by 1925 the Rutherford solar-system atom had broken down in the light of observed phenomena. In its place

Schrödinger, Heisenberg, Dirac, Bohr, and others advanced theories supported by mathematical and experimental data which reduced even the tiny floating specks of matter left by Rutherford to insubstantiality. Their conclusion was that what the world still conceived to be material points were in fact nothing but wave systems, "storm centers of waves or ripples in an imaginary sub-ether." Matter had become synonymous with energy. Thus, after a hundred years, the last trace of Dalton's hard, solid, indestructible atom disappeared, and in the scientific world the concept of substance ceased to exist.

Even more puzzling, by 1927 it was found that although the velocity or momentum of one of the centers of energy to which the electron had been reduced could be experimentally established, and its position separately determined in independent experiments, no method of simultaneously determining position and velocity was available, nor was any method of accomplishing this conceivable. After a quarter century, science has still made no advance toward the solution of this problem. Indeed, scientists have come to believe that the association of exact position with exact momentum can never be discovered because there is no such thing in nature; and this result has been accepted as the "Principle of Uncertainty." The electron, the minutest of the old material particles, has become merely "something unknown doing we don't know what."

A similar impasse has been reached by way of Einstein's theory of relativity, in which the only meaning of matter is a region in the space-time continuum where the paths through space are curved. Today science informs us that we live in a world of shadows so abstract as to make it impossible to form any mental picture of what is really happening. Indeed, as Harvey-Gibson says in "Two Thousand Years of Science," "The further science probes into the hidden recesses of the atomic world, the more obscure and shadowy does objective reality seem, the less material and tangible does Nature appear to be."

Consequently it seems altogether natural that contemporary painting should depict a shadowy and insubstantial world in which amorphous objects hang suspended in a state of watchful expectation and uncertainty. Miro, Gorky, Baziotis, Stamos, the early Matta, Rothko, and others exhibit quite consistently an extreme state of suspension, and even in sculpture this quality is evident in such work as Calder's mobiles. Indeed, suspension in some degree is a chief characteristic of twentieth-century painting, for the solidity of the ground under one's feet is a sensation which science has proved meretricious. The only certainty left to man is that in this universe there exists some kind of mysterious activity and some even more mysterious equilibrium. In contrast to those who float and contemplate, others

resort to action, searching the void: De Kooning, Pollock, Tomlin, and Tworkov, to name but a few among many. In the works of all these painters we find a network of lines, black or white, which give the impression of darting about the canvas. They are not contours of objects, they do not model form, they are not mere decoration. Their quality is movement. More than anything they suggest the track of some moving object—the wake of a ship, the path of a rocket, the vapor trails left by an airplane. In sculpture, Lassaw's "Milky Way" is roughly analogous. There are not many such phenomena in nature. But one man-made product of the twentieth century seems closer in appearance and in spirit to these paintings than any other. It leads us back to the atom.

No man has ever seen an atom, much less an electron or any other subatomic "particle." But the movements of the "particles" through space, their collision with atoms or parts of atoms, and the explosive disintegration of the atom when a head-on collision occurs have been observed and photographed thousands and thousands of times by means of an apparatus developed by C. T. R. Wilson. This device, commonly known as the cloud chamber, is simply a box filled with moisture-saturated air and provided with a glass panel through which the interior of the box may be observed. When a stream of alpha rays or other subatomic "particles" is shot into the chamber, sooner or later one of them is bound to collide with an electron or with the nucleus of one of the millions of atoms of which the air inside the chamber is composed. The passage of the "particles" through the chamber and the consequent fragmentation of the atom produces trails of gaseous ions on which the excess moisture in the chamber deposits as a result of condensation. The paths of the "particles" and the constituents of the shattered atoms are thus defined by chains of microscopic drops, much as a cannon ball fired through a field of wheat, though never visible itself, will leave a plainly visible track.

The variety and intricacy of the cloud-chamber tracks are indescribable and far surpass any display of fireworks or any natural phenomenon of this type, and the closeness of their resemblance to the paintings of the artists mentioned above speaks for itself. The same darting quality, the same intricacy of movement and surface confusion, and the same underlying suggestion of pattern and organization appear in both.

The Wilson cloud chamber and the photographs obtained by its use have received widespread publicity for several decades, for it is perhaps the most important aid to the investigation of the atomic structure of matter that the twentieth century has developed. Such chambers were demonstrated in elementary physics courses at leading universities at least as early as 1930, and sample photographs

of cloud-chamber collisions are to be found in many modern physics textbooks. The dramatic quality of these investigations has caught the public interest, and only a few months ago the discovery of still another type of subatomic "particle" was publicized by *Life* magazine in an article that included numerous large-scale reproductions of cloud-chamber photographs. Under the circumstances, there is a reasonable presumption that some of the artists mentioned above were already familiar with the effects observable in the cloud-chamber when they began painting in this manner.

Again, it is not suggested that the paintings are a deliberate imitation of the photographs. On the contrary, they are by and large even more intricate and are freighted with a burden of human emotion totally lacking in the cloud-chamber views. But the surface similarity is far too great to be lightly dismissed, and the emotional implications in these paintings of the human mind groping for some state of equilibrium and order in a mysterious, strange, and insubstantial universe is too obviously analogous to the state of modern science to be dismissed. It is not too much to assume that an intuitive perception of the analogy between the efforts of the scientist on the physical plane to find order in his shattered world, and the perennial effort of the artist to find the spiritual order and unity which characterize the work of art, has led the artist to subconscious exploitation of remembered impressions of cloud-chamber photographs as the common symbol of this search.

Thus it appears that during the past hundred years the majority of the important innovations in the plastic arts have occurred simultaneously with, or shortly after, revolutionary changes in man's concept of the constitution of matter. In some cases the artists themselves have admitted that the new theories established by the scientists contributed to their development; others have denied any such conscious influence. But the chronological parallelism and the mutuality of concept and image form overwhelming evidence of the closeness of the relationship. Whether science influenced art or art influenced science makes very little difference; for in neither case was the influence accepted in slavish fashion. The scientist has not become an artist nor the artist a scientist. They simply share a mutual preoccupation—today, a mutual problem; and each approaches it in his habitual way and from his habitual point of view. The facts suggest that science was first to establish the new truths about the universe which were then taken into consideration by the artists. But it is well to remember that the scientists of each decade built upon the facts elaborated by their predecessors. In this sense the influences that led Rutherford to his famous conclusions were identical with the influences that led the cubists to develop their new expressions of reality.

Indeed, in the final analysis, the truth may well be that forces common to the age and still too close to permit precise identification influenced scientist and artist alike and led both in independence of each other to conceptions of the universe that have a startling correspondence.

Today some complain that modern art is incomprehensible and confusing, cold and detached, devoid of human warmth and as clinically aloof as the laboratory. This is to attribute to the artist exclusively qualities that man has in fact learned to be intrinsic in the universe. Art has become abstract only to the extent to which the world itself has become abstract. By comparison, the material universe of the nineteenth century was a comfortable and cozy environment for man. But this security did not last. The concept of the limitless space of the atom was only the first of a series of shocks which twentieth-century man was to endure. Today nothing is left of matter, and every aspect of solidity seems to have become illusion. Rocks, trees, houses, men and women, all are mere ghosts of their former selves. All that is left is energy and the void. It is not spiritual confusion, lack of humanity, or morbid preoccupation that leads the artist to face these facts of life and produce works of art that take them into account. On the contrary, it would be a cowardly evasion to ignore them and turn blindly to the past for more reassuring subject matter. It is the paradox of art today that what is still known as realism is actually an escape from reality.

The artists, like the scientists, are seeking to find the hidden order and equilibrium that must exist in this new and ominous world—different though it may be from our previous comfortable conceptions. Man may never be restored to his old position of central importance and security. His relationship with the universe may never be more intimate than the austere and semireligious acceptance of mystery which characterizes the thought of so many artists and scientists today. But scientist and artist alike must continue to scrutinize and evaluate this awesome spectacle, the one with his measurements and mathematics, the other with his intuition and imagination, until a solution has been reached.



INDEX

A

- Abbot, Charles G.**, ix, 119
Abbott, R. Tucker, vi
Accessions, 7, 8, 10, 12, 14, 27, 42, 43, 49, 94, 106, 125, 131, 144, 146
 Bureau of American Ethnology, 94
 Freer Gallery of Art, 49
 Library, 12, 144, 146
 National Air Museum, 125, 131
 National Collection of Fine Arts, 42, 43
 National Gallery of Art, 8, 27
 National Museum, 7, 14
 National Zoological Park, 10, 106
Acheson, Dean C., Secretary of State, member of the Institution, v, viii
Adams, Richard N., 90
Adams-Clement collection, opening of, 6
Air Museum. (*See* National Air Museum.)
Aldrich, Loyal B., Director, Astrophysical Observatory, ix, 117, 122
Aldrich, William T., 41
Allen, W. T., vii, 19, 22
American Ethnology. (*See* Bureau of.)
Anderson, Clinton P., regent of the Institution, v, 4
Andrews, A. J., vi
Appropriations, 5, 26, 60, 88, 142, 153, 159
 Canal Zone Biological Area, 142
 Institute of Social Anthropology, 88, 159
 National Gallery of Art, 26
 National Zoological Park, 159
 Printing and binding, 153
 River Basin Surveys, 60, 159
Arctowski, Henryk, 119
Arms, John Taylor, 41
Arthur lecture on the sun, Eighteenth annual, 6, 163
Artist and the atom, The (Peter Blanc), 427
Astrophysical Observatory, ix, 10, 117
 Division of Astrophysical Research, 117
 Division of Radiation and Organisms, 120
 Report, 117
Atom, The artist and the (Peter Blanc), 427
Atomic energy, The industrial applications of (M. L. Oliphant), 223
Atomic weapons against cancer (E. N. Lockard), 263
Avery, E. A., vii
Awl, Mrs. Aime M., vi

B

- Bailey, Edward**, 22
Barkley, Alben W., Vice President of the United States, member of the Institution, v, 4
Barney, Alice Pike, loan collection, 43
 Memorial fund, 44
Baroja, Julio Caro, 91
Bartsch, Paul, vi
Bassler, R. S., vii
Baumbhoff, Martin, 63, 64
Bayer, Frederick M., vi
Beach, Jessie G., vii
Beal, Gifford, 41
Beckman, Harry, 136
Beers, Stephen L., 131
Beggs, Thomas M., Director, National Collection of Fine Arts, viii, 41, 48
Benn, J. H., vii
Bent, Arthur C., vi
Belin, Ferdinand Lamot, Vice President, National Gallery of Art, viii, 25, 26
Bell, Lawrence D., 125
Bell, Robert E., 81
Bequests, 124
 Stephenson, George H., 124
Biery, Don, 140
Blackwelder, R. E., vi

- Blaker, Mrs. M. C., vi
 Blanc, Peter (The artist and the atom), 427
 Bleakley, Andrew, Jr., 134
 Bliss, Robert Woods, 41
 Böving, A. G., vi
 Bowsher, Arthur L., vii, 24
 Brannan, Charles F., Secretary of Agriculture, member of the Institution, v
 Bridges, William E., vii
 Bridgman, P. W. (Some results in the field of high-pressure physics), 199
 Brot, M. C., Mme., 139
 Brown, John Nicholas, 41
 Brown, Margaret W., viii
 Brown, W. L., vi
 Bruns, Franklin R., Jr., viii, 24
 Buchanan, L. L., vi
 Burcaw, G. Ellis, 74, 76, 78
 Bureau of American Ethnology, viii, 9, 56, 151
 Archives, 93
 Collections, 94
 Editorial work and publications, 91, 151
 Institute of Social Anthropology, 87
 Library, 93
 Report, 56
 River Basin Surveys, 59
 Staff, viii
 Systematic researches, 56
 Burgoyne, William, 141
 Burton, Lt. Comdr. John, 129
 Bush, Vannevar, regent of the Institution, v, 4, 160
 Byas, W. J., vi
- C
- Cairns, Huntington, Secretary-Treasurer and General Counsel, National Gallery of Art, viii, 25, 40
 Caldwell, Joseph R., 61, 62
 Campbell, John M., 65
 Canal Zone Biological Area, ix, 11, 134, 159
 Buildings, 134
 Fiscal report, 142
 Improvements, 134
 Rainfall, 141
 Report, 134
 Scientists and their studies, 135
 Visitors, 140
 Cancer, Atomic weapons against (E. N. Lockard), 263
 Cannon, Clarence, regent of the Institution, v, 4, 160
 Carbon-14 method of age determination, The (Frank H. H. Roberts, Jr.), 335
 Carey, Charles, 24
 Carpenter, Col. Standley, 140
 Carriker, M. A., Jr., 15, 21
 Cartwright, O. L., vi, 21
 Chace, F. A., Jr., vi
 Chadwick, John B., 140
 Chancellor of the Institution (Fred M. Vinson, Chief Justice of the United States), v, 4
 Chapin, Edward A., vi
 Chapman, Oscar, Secretary of the Interior, member of the Institution, v
 Chase, Agnes, vii
 Chemical elements, The new (Saul Dushman), 245
 Cheney, George A., 67
 Chickering, A. M., 136
 Clark, Austin H., vi, 23
 (The fauna of America), 287
 Clark, Mrs. Leila F., Librarian of the Institution, v, 147
 Clark, R. S., vi
 Clark, Thomas F., administrative accountant of the Institution, v, 139
 Clark, Walter F., 139
 Clarke, Gilmore D., 41
 Cloud seeding as a means of increasing precipitation, An appraisal of (Henry G. Houghton), 175
 Coale, George L., 64
 Cochran, Doris M., vi
 Collias, Nicholas E., 137
 Collins, H. B., Jr., viii, 9, 57, 58
 Combs, Rear Adm. Thomas S., ix, 124
 Commerford, L. E., chief, Division of Publications, v
 Compton, Arthur H., regent of the Institution, v, 4
 Conger, Paul S., vii
 Cooper, B. N., 22
 Cooper, Gustav A., vii, 19, 22
 Cooper, Paul L., 57, 71, 76
 Cox, E. E., regent of the Institution, v, 4
 Cox, Larry, 134
 Crile, George, Jr., 23
 Crockett, W. D., vii
 Cumming, Robert B., Jr., 71, 74, 77
 Cumming, Robert Lewis, 138
 Cushman, Robert A., vi

D

- Dale, Chester, viii, 25, 26
 Daugherty, Richard D., 66, 67
 Davis, Harvey N., regent of the Institution, v, 4
 Davis, John H., 138
 Davis, Monett, 140
 Deignan, H. G., vi
 Delaney, John, 134
 Densmore, Frances, viii, 95
 Donaldson, Jesse M., Postmaster General, member of the Institution, v
 Dunkle, D. H., vii, 19, 22
 Dushman, Saul (The new chemical elements), 245

E

- Edgell, George H., 41
 Editorial Division, chief (Paul H. Oehser), v, 153
 Edmond-Blanc, François, 139
 Einstein's new theory, On (Leopold Infeld), 189
 Eisenmann, Eugene, 136
 Elder, R. A., Jr., vi
 Electronics, Some prospects in the field of (V. K. Zworykin), 235
 Ellis, Hazel R., 137
 Ellis, Max M., vi
 Elstad, V. B., ix
 Elton, Norman, 140
 Enger, W. D., 75
 Enger, Walter D., Jr., 77
 Enzymes: Machine tools of the cellular factory (B. A. Kilby), 273
 Erasmus, Charles J., 89, 90
 Ettinghausen, Richard, viii, 54, 55
 Evans, Clifford, Jr., vi, 23
 Ewers, J. C., vi
 Executive Committee of the Board of Regents, v, 160
 Report, 154
 Appropriations, 159
 Assets, 157
 Audit, 159
 Cash balances, receipts, and disbursements, 156
 Classification of investments, 156
 Freer Gallery of Art fund, 155
 Gifts, 158
 Smithsonian endowment fund, 154
 Summary of endowments, 156

- Exhibitions, 33, 47
 National Collection of Fine Arts, 47
 National Gallery of Art, 33

F

- Fairchild, David, vii
 Farrell, Robert, 64
 Fauna of America, The (Austin H. Clark), 287
 Fenenga, Franklin, 63, 71, 77
 Fenton, W. N., viii, 9, 59
 Field, W. D., vi
 Finances, 4, 154
 Appropriations, 5
 Report of Executive Committee of the Board of Regents, 154
 Finlayson, John and Richard, 51
 Finley, David E., Director, National Gallery of Art, viii, 25, 26, 41
 Fisher, W. K., vi
 Fite, E. J., vii
 Fleming, Robert V., regent of the Institution, v, 4, 160
 Forsythe, W. E., 118
 Foshag, W. F., vii
 Foster, G. M., Jr., Director, Institute of Social Anthropology, viii, 87, 91
 Freer Gallery of Art, viii, 9, 49, 152, 155
 Attendance, 9, 53
 Changes in exhibitions, 51
 Collections, 49
 Endowment fund, 155
 Herzfeld Archive, 53
 Library, 51
 Publications, 152
 Repairs to the collection, 51
 Report, 49
 Staff, viii
 Staff activities, 53
 Friedmann, Herbert, vi, 16, 21

G

- Garber, Paul E., ix, 124, 131
 Gardner, Paul V., viii, 41, 42
 Garth, Thomas R., 74, 77
 Gazin, C. L., vii, 19, 22
 Gazin, Mrs. Elisabeth H., vi
 George, Walter F., regent of the Institution, v, 4
 Gibson, R. E., 125
 Glance, Grace E., vi
 Goodrich, Lloyd, 41
 Goss, Wilbur H., 125
 Goubaud-Carrera, Antonio, 90

- Graf, John E., Assistant Secretary of the Institution, v, 41, 139
 Graham, D. C., vi
 Grant, Maj. Gen. U. S., 3d, 7
 Greene, Charles T., vi
 Guest, Grace Dunham, viii
- H**
- Halftone screen, The development of the (Jacob Kainen), 409
 Handley, Charles O., Jr., vi, 23
 Harrington, John P., viii, 9, 58, 59
 Harrison, J. H., ix
 Hartle, Donald D., 75, 78, 83
 Hartman, Frank A., 136
 Hartmann, Armageddon, 136
 Hartmann, Ratibor, 136
 Henderson, E. P., vii
 Hermle, Paul, 139
 Hess, Frank L., vii
 High-pressure physics, Some results in the field of (P. W. Bridgman), 199
 Hiller, Stanley, 128
 Holden, F. E., vii
 Hoover, William H., ix, 118, 119
 Hormones and the metamorphosis of insects (V. B. Wigglesworth), 313
 Horowitz, Emanuel, ix
 Houghton, Henry G. (An appraisal of cloud seeding as a means of increasing precipitation), 175
 Howard, J. D., Treasurer of the Institution, v
 Howell, A. Brazier, vi
 Hughes, Howard, 128
 Humphreys, Robert H., 84
 Hunsaker, Jerome C., regent of the Institution, v, 4
- I**
- Illg, P. L., vi, 17
 Index of American Design, 38
 Infeld, Leopold (On Einstein's new theory), 189
 Insects, Hormones and the metamorphosis of (V. B. Wigglesworth), 313
 Institute of Social Anthropology, viii, 9, 87, 152, 159
 Appropriation, 88, 159
 Field work, 89
 Publications, 152
 Report, 87
 Washington office, 91
- International Exchange Service, ix, 10, 96
 Foreign depositories of governmental documents, 97
 Foreign exchange agencies, 102
 Interparliamentary exchange of the official journal, 100
 Packages received and sent, 96
 Report, 96
- J**
- James, Macgill, Assistant Director, National Gallery of Art, viii, 25
 Jelks, Edward B., 82, 84
 Jellison, W. L., vi
 Johnson, David H., vi, 21
 Johnson, Irving, 140
 Johnson, Leonard G., 80, 81
 Judd, Neil M., vi
- K**
- Kainen, Jacob, vii
 (The development of the halftone screen), 409
 Kanazawa, Robert H., vi
 Keally and Patterson, 53
 Keddy, J. L., Assistant Secretary of the Institution, v
 Keenan, Marvin, 140
 Kellogg, A. Remington, Director, National Museum, vi, 7, 24
 Kelly, Isabel T., 90
 Kestner, F. B., photographer of the Institution, v
 Ketchum, Miriam B., viii
 Kilby, B. A. (Enzymes: Machine tools of the cellular factory), 273
 Killip, E. P., vii, 23
 Knight, J. Brookes, vii, 17
 Knox, Mrs. Katherine McCook, 7
 Koford, Carl, and Mrs. Koford, 138
 Korff, Serge, and Mrs. Korff, 138
 Kramer, Andrew, ix
 Kress, Samuel H., President, National Gallery of Art, viii, 25, 26
 Krieger, H. W., vi, 20
 Kunze, Marjorie R., ix
- L**
- Lachner, E. A., vi
 Laufer, Arthur R. (Ultrasonics), 213
 Laughlin, Ledlie I., 138
 Laughlin, Robert M., 138
 Lawrence, Lovell, Jr., 125

Lea, John S., vi, 150
 Leapley, W. T., vi
 Lee, George O., 141
 Lehmer, Donald J., 72, 73, 78, 81
 Leonard, E. C., vii
 Leutscher, Alfred (The mechanics of snakes), 303
 Lewton, F. L., vii
 Libby, W. F., 72
 Library, 12, 144
 Bureau of American Ethnology, 93
 Freer Gallery of Art, 51
 National Collection of Fine Arts, 47
 National Gallery of Art, 37
 Smithsonian, 12, 144
 Accessions, 12, 144, 146
 Report, 144
 Summarized statistics, 146
 Lighting, Artificial, in America: 1830-1860 (C. Malcolm Watkins), 385
 Link, Anna M., viii
 Llano, George A., 24
 Lockard, E. N. (Atomic weapons against cancer), 263
 Loeblich, A. R., Jr., vii, 22
 Loening, Grover, ix
 Lowe, Frank O., ix
 Lowy, Bernard, 136
 Lundy, William E., 140
 Lyon, Rowland, viii

M

Male, W. M., ix, 128
 Mann, William M., Director, National Zoological Park, vi, ix, 116
 Manning, Mrs. Catherine L., 24
 Manship, Paul, 41
 Marble, J. P., vii
 Mariani, Ambassador, of Italy, 141
 Marshall, George C., Secretary of Defense, member of the Institution, v
 Marshall, W. B., vi
 Martin, G. J., viii
 Masland, Frank E., Jr., 140
 Mattes, M. J., 79
 Mattison, R. H., 79
 McBride, Harry A., Administrator, National Gallery of Art, viii, 25
 McClure, F. A., vii
 McGrath, J. Howard, Attorney General, member of the Institution, v
 Mellon, Paul, viii, 25, 26
 Members of the Institution, v
 Memorial gifts, 7

Metals, The insides of (Carl A. Zapffe), 253
 Metamorphosis of insects, Hormones and the (V. B. Wigglesworth), 313
 Metcalf, George, 71, 78
 Miller, Carl F., 61, 62, 85
 Miller, E. O., 83, 85
 Miller, Gerrit S., Jr., vi
 Milne, Lorus J., 137
 Milne, Margery, 137
 Mitman, Carl W., ix, 125, 133
 Mohr, Albert D., 63, 64
 Moore, J. Percy, vi
 Moorman, E. H., 83, 85
 Morrison, Joseph P. E., vi
 Morton C. V., vii, 17, 21, 22
 Mosher, S. M., viii
 Murray, A. C., vii
 Myer, Catherine Walden, fund, 43
 Myers, George Hewitt, 41

N

National Air Museum, ix, 11, 123
 Accessions, list of, 131
 Accessions and events, 125
 Advisory Board, ix, 123
 Cooperative projects and informational services, 128
 Curatorial activities, 124
 Highlights, 123
 Report, 123
 Staff, ix
 Stephenson bequest, 124
 Storage, 127
 Survey, 131
 National Collection of Fine Arts, viii, 8, 41
 Accessions, 42, 43
 Alice Pike Barney loan collection, 43
 Alice Pike Barney memorial fund, 44
 Catherine Walden Myer fund, 43
 Henry Ward Ranger fund, 46
 Information service, 47
 Library, 47
 Loans, 44, 45, 46
 Report, 41
 Smithsonian Art Commission, 8, 41
 Special exhibitions, 47
 Staff, viii
 Study collection, 43
 Transfers, 44
 Withdrawals by owners, 45

- National Gallery of Art, viii, 8, 25
 Accessions, 8, 27
 Acquisitions committee, 26
 Appropriations, 26
 Attendance, 8, 27
 Audit of private funds of the Gallery, 40
 Care and maintenance of the building, 38
 Construction of new galleries and offices, 38
 Construction of storage facilities, 39
 Curatorial activities, 35
 Decorative arts, 27
 Educational program, 37
 Exchange of works of art, 28
 Executive committee, 25
 Exhibitions, 33
 Finance committee, 26
 Index of American Design, 38
 Library, 37
 Loans, 28, 32, 33
 Officials, viii, 25
 Organization, 25
 Paintings, 27
 Prints and drawings, 28
 Publications, 36
 Report, 25
 Restoration and repair of works of art, 36
 Tenth anniversary celebration, 27
 Traveling exhibition, 34
 Trustees, viii, 25
- National Museum, U. S., vi, 7, 14, 150
 Accessions, 7, 14
 Buildings and equipment, 14
 Changes in organization and staff, 23
 Collections, 14
 Exploration and field work, 20
 Publications, 150
 Report, 14
 Staff, vi
 Visitors, 23
- National Zoological Park, ix, 10, 104, 159
 Accessions, 10, 106
 Appropriation, 159
 Births and hatchings, 114
 Depositors and donors and their gifts, 108
 Exhibits, 106
- National Zoological Park—Cont.
 Maintenance and improvements, 115
 Needs, 116
 Report, 104
 Staff, ix
 Visitors, 10, 104
- Neuman, R. B., 22
 Newman, Jack B., personnel officer of the Institution, v
 Newman, M. T., vi
 Nicol, David, vii
 Nobel, Rear Adm. A. G., 125
- O
- Oberg, Kalervo, 89
 Oehser, Paul H., chief, Editorial Division, v, 153
 Oliphant, M. L. (The industrial application of atomic energy), 223
 Olivares, Ismael, 139
 Oliver, L. L., superintendent of buildings and labor, v
 Oliver, S. H., vii
 Osborne, Douglas, 65, 66
- P
- Palmer, M. Helen, viii, 151
 Palmer, T. S., vi
 Parfin, Sophy, vi
 Payne, Max B., 22
 Pearce, Franklin L., vii, 12, 22
 Pearson, Mrs. Louise M., administrative assistant to the Secretary, v
 Peat, Marwick, Mitchell & Co., 160
 Peck, Stuart, 64
 Perry, K. M., vii
 Perry, Stuart H., vii, 18
 Perrygo, W. M., 15, 20, 139
 Peterson, Mrs. L. W., vi
 Peterson, Mendel I., viii, 23
 Phillips, Duncan, viii, 25, 26
 Physics, Some results in the field of high-pressure (P. W. Bridgman), 199
 Pierson, Donald, 89
 Pope, John A., viii, 53, 54, 55
 Potter, David, 141
 Price, Leonard, ix
 Price, Waterhouse & Co., 40
 Pride, Rear Adm. A. M., 124
 Publications, 11, 36, 91, 148
 American Historical Association, Report, 152

Publications—Cont.

- Appropriation for printing and binding, 153
- Bureau of American Ethnology, 91, 151
- Annual Report, 152
- Bulletins, 152
- Institute of Social Anthropology, publications, 152
- Daughters of the American Revolution, Report, 152
- Distribution, 148
- Freer Gallery of Art, 152
- Occasional Papers, 152
- Special publications, 152
- National Gallery of Art, 36
- National Museum, 150
- Annual Report, 150
- Bulletins, 151
- Contributions from the United States National Herbarium, 151
- Proceedings, 150
- Report, 148
- Smithsonian, 11, 148
- Annual Report, 149
- Miscellaneous Collections, 148
- Special publications, 150
- Tables, 12
- Publications, Division of, chief (L. E. Commerford), v
- Putt, Maj. Gen. Donald L., ix, 124

R

- Rands, Robert, 57
- Ranger, Henry Ward, fund, 46
- Reed, Fred C., 24
- Reeside, J. B., Jr., vii
- Regents, Board of, v, 3
- Annual meeting, 4
- Executive Committee, v, 160
- Members, v, 160
- Report, 154
- Members, v, 4
- Rehder, Harold A., vi
- River Basin Surveys, viii, 9, 59, 159
- Appropriation, 60, 159
- Cooperating institutions, 86
- Field work, 63
- Report, 59
- Washington office, 61
- River Basin Surveys: The first five years of the Inter-Agency Archeological and Paleontological Salvage Program (Frank H. H. Roberts, Jr.), 351
- Robbins, Ross, 138
- Roberts, Frank H. H., Jr., Associate Director, Bureau of American Ethnology; Director, River Basin Surveys, viii, 9, 57, 59, 61
- (The carbon-14 method of age determination), 335
- (River Basin Surveys: The first five years of the Inter-Agency Archeological and Paleontological Salvage Program), 351
- Roberts, Walter Orr, 6
- (Stormy weather on the sun), 163
- Rogers, Grace L., vii
- Romano, Octavio, 64
- Rudd, Velva E., vii
- Russell, J. Townsend, Jr., vi
- Ryan, Francis J., and Mrs. Ryan, 138

S

- Salter, Robert M. (Utilizing our soil resources for greater production), 319
- Saltonstall, Leverett, regent of the Institution, v, 4
- Sawyer, Charles, Secretary of Commerce, member of the Institution, v
- Schaller, W. T., vii
- Schmitt, Waldo L., vi
- Scholes, R. T., and Mrs. Scholes, 139
- Schultz, Leonard P., vi
- Schumacher, E. G., viii
- Schwartz, Benjamin, vi
- Schwartz, Douglas W., 70
- Searle, Mrs. Harriet Richardson, vi
- Secretary of the Institution (Alexander Wetmore), v, viii, 4, 7, 13, 15, 20, 25, 42, 125, 139
- Report, 1
- Adams-Clement Collection, opening of, 6
- Arthur lecture, 6
- Establishment, The, 3
- Finances, 4
- Appropriations, 5
- General statement, 1
- Library, 12
- Memorial gifts, 7
- Publications, 11
- Regents, Board of, 3
- Summary of the year's activities, 7
- Visitors, 5

Setzer, Henry W., vi, 21
 Setzler, Frank M., vi
 Shalkop, Robert L., 71
 Shaw, Winthrop S., ix
 Shepard, Donald D., 25
 Shiner, Joel L., 64, 68
 Shippee, James M., 72, 78
 Shoemaker, C. R., vi
 Simmons, Ozzie G., 89, 91
 Sinclair, Charles C., assistant superintendent of buildings and labor, v
 Sirlouis, J. R., viii
 Skinner, Morris, 80
 Smith, A. C., vii
 Smith, Don, Jr., 134
 Smith, George H., 75, 79
 Smith, J. Russell, 140
 Smith, James G., 80, 81
 Smith, Lyman B., vii
 Smith, Ray, 42
 Smithsonian Art Commission, 8, 41
 Snakes, The mechanics of (Alfred Leutscher), 303
 Snyder, John W., Secretary of the Treasury, member of the Institution, v, viii, 26
 Sohns, Ernest R., vii, 24
 Soil resources, Utilizing our, for greater production (Robert M. Salter), 319
 Solecki, Ralph S., 61, 62, 82
 Soper, C. C., 139
 Southwick, Charles, 137
 Stanton, T. W., vii
 Stephenson, Robert L., 82, 83, 84
 Stern, Harold P., viii
 Stevenson, John A., vii
 Stewart, T. Dale, vi
 Stirling, Matthew W., Director, Bureau of American Ethnology, viii, 9, 56, 95
 Stout, William B., ix
 Strobell, Robert C., ix, 131
 Stubbs, Burns A., viii
 Sun, Stormy weather on the (Walter Orr Roberts), 163
 Swallen, Jason R., vii, 23
 Swanton, John R., viii, 95
 Swingle, W. T., vii
 Switzer, George S., vii, 22

T

Talbert, D. G., ix
 Taylor, Frank A., vii
 Taylor, Walter E., 57, 58
 Taylor, W. W., Jr., vi

Thomas, G. S., vii
 Tobin, Maurice, Secretary of Labor, member of the Institution, v
 Tobin, Samuel J., 67
 Truman, Harry S., President of the United States, Presiding Officer ex officio of the Institution, v
 Tucker, Mae W., viii

U

Ultrasonics (Arthur R. Laufer), 213

V

Vandenberg, Gen. Hoyt S., 125
 Vaughan, T. W., vii
 Vinson, Fred M., Chief Justice of the United States, Chancellor of the Institution, v, viii, 4, 25
 Visitors, 5, 8, 9, 10, 27, 53, 104, 140
 Canal Zone Biological Area, 140
 Freer Gallery of Art, 9, 53
 National Gallery of Art, 8, 27
 National Zoological Park, 10, 104
 Smithsonian buildings, 5
 Vorys, John M., regent of the Institution, v, 4, 140

W

Walker, E. H., vii, 22
 Walker, Ernest P., ix
 Walker, John, Chief Curator, National Gallery of Art, viii, 25
 Waring, Antonio J., Jr., viii, 95
 Watkins, C. Malcolm, vi
 (Artificial lighting in America: 1830-1860), 385
 Watkins, W. N., vii
 Webb, William S., 70
 Wedderburn, A. J., Jr., vii
 Wedel, Waldo R., vi, 20, 73
 Weiss, Helena M., vi
 Wenley, A. G., Director, Freer Gallery of Art, viii, 41, 54, 55
 Wetmore, Alexander, Secretary of the Institution, v, vi, viii, ix, 4, 7, 13, 15, 20, 25, 41, 125, 139
 Wheeler, Richard Page, 71, 72, 78, 79
 White, Lawrence Grant, 41
 White, Theodore E., 61, 62, 75, 79, 80, 84
 Wigglesworth, V. B. (Hormones and the metamorphosis of insects), 313

- | | |
|--|--|
| <p>Wilding, Anthony W., property, supply,
and purchasing officer of the Institu-
tion, v</p> <p>Willey, Gordon R., 91</p> <p>Williams, D. G., Chief, International
Exchange Service, ix, 103</p> <p>Wilson, Mrs. Mildred S., vi</p> <p>Withrow, Alice P., ix</p> <p>Withrow, R. B., ix, 117, 120</p> <p>Wolfe, Lt. Gen. K. B., 124</p> <p>Wonderly, William, 90</p> <p>Wulf, Oliver R., 119</p> <p>Wyeth, Andrew, 41</p> | <p style="text-align: center;">Y</p> <p>Yeager, Capt. Charles E., 125</p> <p style="text-align: center;">Z</p> <p>Zapffe, Carl A. (The insides of metals),
253</p> <p>Zetek, James, Resident Manager, Canal
Zone Biological Area, ix, 17, 139, 143</p> <p>Zoological Park. (<i>See</i> National Zoolog-
ical Park.)</p> <p>Zworykin, V. K. (Some prospects in the
field of electronics), 235</p> |
|--|--|





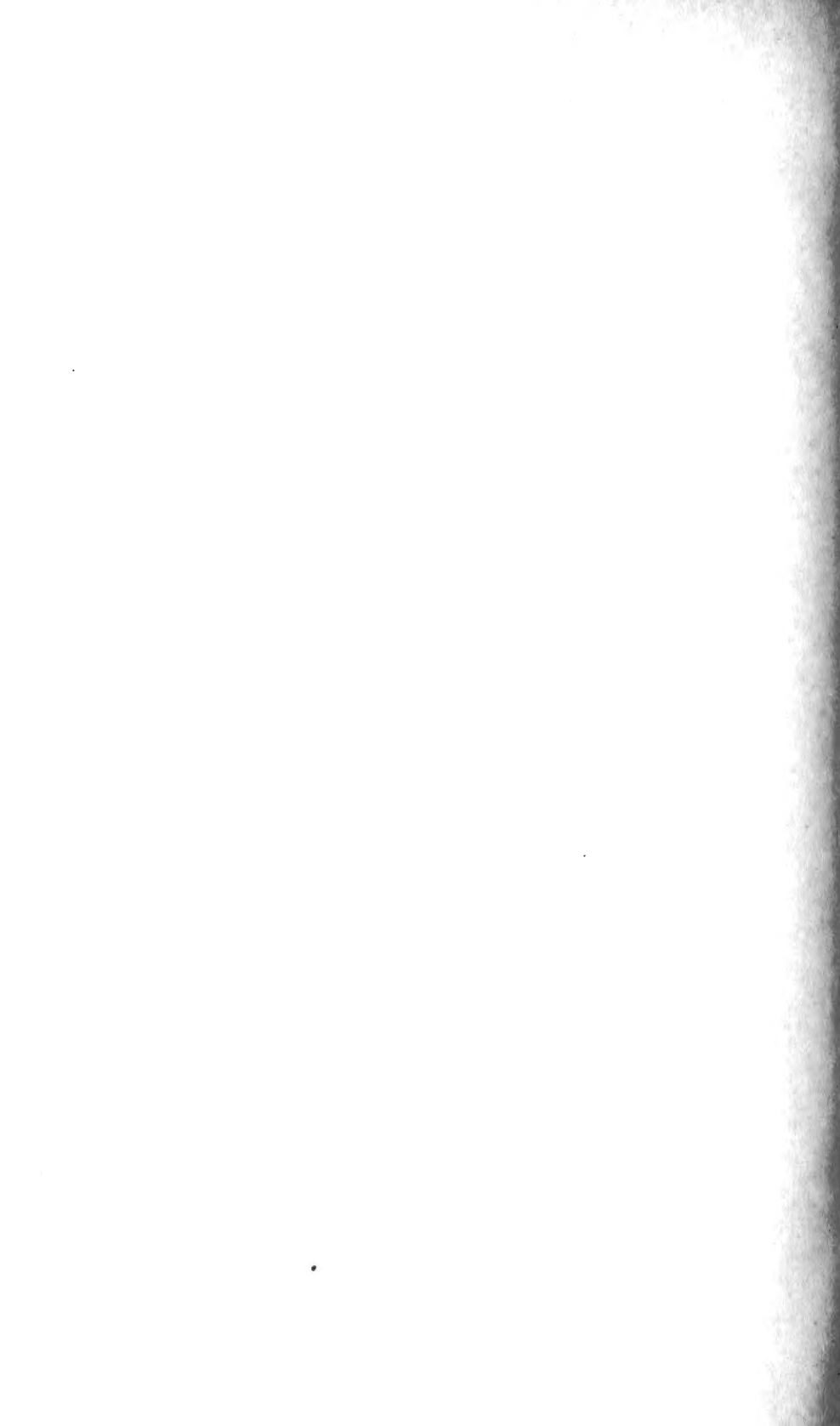

SMITHSONIAN INSTITUTION LIBRARIES



3 9088 01421 7574