



Annual Report of the Board of Regents

of the

SMITHSONIAN

INSTITUTION



PUBLICATION 4518

Showing the Operations, Expenditures, and Condition of the

Institution for the Year Ended June 30

1962

U.S. GOVERNMENT PRINTING OFFICE

WASHINGTON : 1963

Q
=

S66X
CRLSSI

LETTER OF TRANSMITTAL

SMITHSONIAN INSTITUTION,
Washington, December 28, 1962.

To the Congress of the United States:

In accordance with section 5593 of the Revised Statutes of the United States, I have the honor, on behalf of the Board of Regents, to submit to Congress the annual report of the operations, expenditures, and condition of the Smithsonian Institution for the year ended June 30, 1962.

Respectfully,

LEONARD CARMICHAEL, *Secretary.*

CONTENTS

	Page
List of officials.....	v
General statement.....	1
The Establishment.....	4
The Board of Regents.....	5
Finances.....	5
Visitors.....	6
Reports of branches of the Institution:	
United States National Museum.....	8
Bureau of American Ethnology.....	42
Astrophysical Observatory.....	71
National Collection of Fine Arts.....	94
Freer Gallery of Art.....	105
National Air Museum.....	121
National Zoological Park.....	132
Canal Zone Biological Area.....	180
International Exchange Service.....	186
National Gallery of Art.....	196
Report on the library.....	211
Report on publications.....	215
Other activities:	
Lectures.....	223
Science Information Exchange.....	223
Smithsonian Museum Service.....	224
Report of the executive committee of the Board of Regents.....	227

GENERAL APPENDIX

Aircraft propulsion: A review of the evolution of aircraft powerplants, by C. Fayette Taylor.....	245
Rocket propulsion, by Ralph S. Cooper.....	299
The early history of radar, by R. M. Page.....	315
Modern glass, by S. Donald Stookey.....	323
The great earthquakes of May 1960 in Chile, by Pierre Saint-Amand.....	337
The rim of the reef, by E. Yale Dawson.....	365
What's happening to water? by Charles J. Robinove.....	375
The opening of the Arctic Ocean, by Lt. Comdr. James T. Strong.....	391
The place of genetics in modern biology, by George W. Beadle.....	399
The shark that hibernates, by L. Harrison Matthews.....	415
Man in a world of insects, by Dwight M. DeLong.....	423
Tropical fruit-fly menace, by L. D. Christenson.....	441
The soil as a habitat for life, by Sir John Russell.....	449
The evolution of the echinoderms, by H. Barraclough Fell.....	457
Mangroves: Trees that make land, by William M. Stephens.....	491

	Page
The history and relationships of the world's cottons, by Sir Joseph Hutchinson.....	497
Some mysteries of life and existence, by R. E. Snodgrass.....	517
Civilization and the landscape, by Sylvia Crowe.....	537
How many people have ever lived on earth? by Annabelle Desmond.....	545
Bows and arrows: A chapter in the evolution of archery in America, by Paul E. Klopsteg.....	567
Scientific methods in the examination and conservation of antiquities, by A. E. A. Werner.....	593

LIST OF PLATES

	Following Page
Secretary's Report:	
Plates 1, 2.....	54
Plates 3-6.....	118
Plates 7-10.....	134
Plates 11-16.....	198
Aircraft propulsion (Taylor): Plates 1-27.....	298
Rocket propulsion (Cooper): Plate 1.....	310
Early history of radar (Page): Plates 1-4.....	318
Modern glass (Stookey): Plates 1-3.....	326
Earthquakes in Chile (Saint-Amand): Plates 1-10.....	358
Rim of the reef (Dawson): Plates 1-8.....	366
What's happening to water? (Robinove): Plate 1.....	382
Opening of the Arctic Ocean (Strong): Plates 1-4.....	394
Place of genetics in modern biology (Beadle): Plate 1.....	406
Tropical fruit-fly menace (Christenson): Plates 1-6.....	446
Soil as a habitat for life (Russell): Plates 1-5.....	454
Evolution of the echinoderms (Fell): Plates 1-3.....	470
Mangroves: Trees that make land (Stephens): Plates 1-4.....	494
Civilization and the landscape (Crowe): Plates 1-4.....	542
Bows and arrows (Klopsteg): Plates 1-5.....	582
Methods in the conservation of antiquities (Werner): Plates 1-4.....	598

THE SMITHSONIAN INSTITUTION

June 30, 1962

Presiding Officer ex officio.—JOHN F. KENNEDY, President of the United States.

Chancellor.—EARL WARREN, Chief Justice of the United States.

Members of the Institution:

JOHN F. KENNEDY, President of the United States.

LYNDON B. JOHNSON, Vice President of the United States.

EARL WARREN, Chief Justice of the United States.

DEAN RUSK, Secretary of State.

DOUGLAS DILLON, Secretary of the Treasury.

ROBERT S. MCNAMARA, Secretary of Defense.

ROBERT F. KENNEDY, Attorney General.

J. EDWARD DAY, Postmaster General.

STEWART L. UDALL, Secretary of the Interior.

ORVILLE L. FREEMAN, Secretary of Agriculture.

LUTHER H. HODGES, Secretary of Commerce.

ARTHUR J. GOLDBERG, Secretary of Labor.

ABRAHAM A. RIBICOFF, Secretary of Health, Education, and Welfare.

Regents of the Institution:

EARL WARREN, Chief Justice of the United States, Chancellor.

LYNDON B. JOHNSON, Vice President of the United States.

CLINTON P. ANDERSON, Member of the Senate.

J. WILLIAM FULBRIGHT, Member of the Senate.

LEVERETT SALTONSTALL, Member of the Senate.

FRANK T. BOW, Member of the House of Representatives.

CLARENCE CANNON, Member of the House of Representatives.

MICHAEL J. KIRWAN, Member of the House of Representatives.

JOHN NICHOLAS BROWN, citizen of Rhode Island.

ROBERT V. FLEMING, citizen of Washington, D.C.

CRAWFORD H. GREENEWALT, citizen of Delaware.

CARYL P. HASKINS, citizen of Washington, D.C.

JEROME C. HUNSAKER, citizen of Massachusetts.

Executive Committee.—ROBERT V. FLEMING, *Chairman*, CLARENCE CANNON, CARYL P. HASKINS.

Secretary.—LEONARD CARMICHAEL.

Assistant Secretaries.—A. REMINGTON KELLOGG, JAMES C. BRADLEY.

Assistant to the Secretary.—THEODORE W. TAYLOR.

Administrative assistant to the Secretary.—MRS. LOUISE M. PEARSON.

Treasurer.—EDGAR L. ROY.

Chief, editorial and publications division.—PAUL H. OEHSER.

Librarian.—RUTH E. BLANCHARD.

Curator, Smithsonian Museum Service.—G. CARROLL LINDSAY.

Buildings Manager.—ANDREW F. MICHAELS, JR.

Director of Personnel.—J. A. KENNEDY.

Chief, supply division.—A. W. WLDING.

Chief, photographic service division.—O. H. GREESON.

UNITED STATES NATIONAL MUSEUM

Director.—A. Remington Kellogg.

Registrar.—Helena M. Weiss.

MUSEUM OF NATURAL HISTORY

Director.—A. C. Smith.

Administrative officer.—Mrs. Mabel A. Byrd.

DEPARTMENT OF ANTHROPOLOGY: T. Dale Stewart, head curator; A. J. Andrews, exhibits specialist.

Division of Archeology: W. R. Wedel, curator; Clifford Evans, Jr., G. W. Van Beek, associate curators.

Division of Ethnology: S. H. Riesenbergs, curator; G. D. Gibson, E. I. Knez, W. H. Crocker, associate curators; R. A. Elder, Jr., assistant curator.

Division of Physical Anthropology: T. D. Stewart, acting curator; M. T. Newman, associate curator.

DEPARTMENT OF ZOOLOGY: H. H. Hobbs, Jr., head curator.

Division of Mammals: D. H. Johnson, curator; C. O. Handley, Jr., H. W. Setzer, associate curators.

Division of Birds: P. S. Humphrey, curator.

Division of Reptiles and Amphibians: Doris M. Cochran, curator.

Division of Fishes: L. P. Schultz, curator; E. A. Lachner, W. R. Taylor, associate curators.

Division of Insects: J. F. G. Clarke, curator; O. L. Cartwright, R. E. Crabill, Jr., W. D. Field, O. S. Flint, Jr., D. R. Davis, associate curators.

Division of Marine Invertebrates: F. A. Chace, Jr., curator; T. E. Bowman, C. E. Cutress, Jr., D. F. Squires, associate curators.

Division of Mollusks: H. A. Rehder, curator; J. P. E. Morrison, Joseph Rosewater, associate curators.

DEPARTMENT OF BOTANY (NATIONAL HERBARIUM): J. R. Swallen, head curator.

Division of Phanerogams: L. B. Smith, curator; R. S. Cowan, Velva E. Rudd, J. J. Wurdack, associate curators.

Division of Ferns: C. V. Morton, curator.

Division of Grasses: J. R. Swallen, acting curator; T. R. Soderstrom, associate curator.

Division of Cryptogams: M. E. Hale, Jr., curator; P. S. Conger, associate curator.

Division of Woods: W. L. Stern, curator.

DEPARTMENT OF GEOLOGY: G. A. Cooper, head curator.

Division of Mineralogy and Petrology: G. S. Switzer, curator; P. E. Desautels, E. P. Henderson, associate curators; R. S. Clarke, Jr., chemist.

Division of Invertebrate Paleontology and Paleobotany: R. S. Boardman, curator; P. M. Kier, Richard Cifelli, E. G. Kauffman, associate curators.

Division of Vertebrate Paleontology: C. L. Gazin, curator; Nicholas Hotton III, associate curator; F. L. Pearce, exhibits specialist.

MUSEUM OF HISTORY AND TECHNOLOGY

Director.—F. A. Taylor.

Assistant Director.—J. C. Ewers.

Administrative officer.—W. E. Boyle.

Chief exhibits specialist.—J. E. Anglim.

In charge of taxidermy.—W. M. Perrygo.

Assistant chief exhibits specialists.—B. S. Bory, B. W. Lawless, Jr., Julius Tretick.

DEPARTMENT OF SCIENCE AND TECHNOLOGY: R. P. Multhauf, head curator; Joseph E. Rudmann, assistant curator.

Division of Physical Sciences: L. C. Lewis, curator; W. F. Cannon, associate curator.

Division of Mechanical and Civil Engineering: S. A. Bedini, curator; E. A. Battison, R. M. Vogel, associate curators.

Division of Transportation: H. I. Chapelle, curator; K. M. Perry, J. H. White, Jr., associate curators.

Division of Electricity: R. P. Multhauf, acting curator.

Division of Medical Sciences: S. K. Hamarneh, associate curator in charge.

DEPARTMENT OF ARTS AND MANUFACTURES: P. W. Bishop, head curator.

Division of Textiles: Mrs. Grace R. Cooper, curator.

Division of Ceramics and Glass: P. V. Gardner, curator.

Division of Graphic Arts: Jacob Kainen, curator; F. O. Griffith, Eugene Ostroff, associate curators.

Division of Manufactures and Heavy Industries: P. W. Bishop, acting curator; C. O. Houston, Jr., associate curator.

Division of Agriculture and Forest Products: E. C. Kendall, associate curator in charge.

DEPARTMENT OF CIVIL HISTORY: Richard H. Howland, head curator; P. C. Welsh, associate curator; Doris A. Esch, assistant curator; Ellen J. Finnegan, junior curator.

Division of Political History: W. E. Washburn, curator; Mrs. Margaret Brown Klaphor, associate curator; Mrs. Anne W. Murray, H. R. Collins, K. E. Melder, assistant curators.

Division of Cultural History: C. Malcolm Watkins, curator; Rodris C. Roth, associate curator; Anthony W. Hathaway, J. N. Pearce, Cynthia L. Adams, assistant curators.

Division of Philately and Postal History: Richard H. Howland, acting curator; G. T. Turner, F. J. McCall, associate curators; C. H. Scheele, assistant curator.

Division of Numismatics: Vladimir Clain-Stefanelli, curator; Mrs. Elvira Clain-Stefanelli, associate curator.

DEPARTMENT OF ARMED FORCES HISTORY: M. L. Peterson, head curator.

Division of Military History: E. M. Howell, curator; C. R. Goins, Jr., associate curator.

Division of Naval History: P. K. Lundeberg, curator; M. H. Jackson, associate curator.

BUREAU OF AMERICAN ETHNOLOGY

Director.—F. H. H. Roberts, Jr.

Anthropologist.—H. B. Collins, Jr.

Ethnologists.—W. C. Sturtevant, W. L. Chafe.

RIVER BASIN SURVEYS.—F. H. H. Roberts, Jr., *Director*; R. L. Stephenson, *Chief, Missouri Basin Project.*

ASTROPHYSICAL OBSERVATORY

Director.—F. L. Whipple.

Assistant Director.—C. W. Tillinghast.

Astronomers.—G. Colombo, L. Goldberg, S. Hamid, I. G. Izsak, Y. Kozai, J. Slowey, F. W. Wright, P. E. Zadunaisky.

Mathematicians.—R. E. Briggs, D. A. Lautman.

Physicists.—E. Avrett, A. F. Cook, R. J. Davis, J. DeFelice, E. L. Fireman, F. Franklu, O. Gingerich, M. Grossi, P. W. Hodge, L. G. Jaccchia, W. Kalkofen, M. Krook, R. E. McCrosky, H. Mitler, T. W. Noonan, R. B. Riggs, Jr., O. P. Rustgi, A. Skalafuris, R. B. Southworth, D. Tilles, C. A. Whitney.

Geodesists.—J. Roff, G. Veis.

Geologists.—V. B. Marvin, J. Wood.

DIVISION OF RADIATION AND ORGANISMS:

Chief.—W. H. Klein.

Plant physiologists.—P. J. A. L. deLint, J. L. Edwards, V. B. Elstad, K. Mitrakos, L. Price.

Biophysicist.—W. Shropshire.

Biochemist.—M. Margulies.

Cytogeneticist.—R. L. Latterell.

Electronic Engineer.—J. H. Harrison.

Instrument engineering technician.—D. G. Talbert.

NATIONAL COLLECTION OF FINE ARTS

Director.—T. M. Beggs.

Associate curator.—Rowland Lyon.

SMITHSONIAN TRAVELING EXHIBITION SERVICE.—Mrs. Annemarie H. Pope, *Chief*.

FREER GALLERY OF ART

Director.—JOHN A. PORK.

Acting Assistant Director.—Harold P. Stern.

Head curator, Near Eastern Art.—Richard Ettinghausen.

Associate curator, Chinese Art.—James F. Cahill.

Head curator, Laboratory.—Rutherford J. Gettens.

NATIONAL AIR MUSEUM

Advisory Board:

Leonard Carmichael, *Chairman*.

Maj. Gen. Brooke E. Allen, U.S. Air Force.

Rear Adm. P. D. Stroop, U.S. Navy.

Lt. Gen. James H. Doolittle (U.S.A.F. Ret.)

Grover Loening.

Director.—P. S. Hopkins.

Head curator and historian.—P. E. Garber.

Curators.—L. S. Casey, K. E. Newland.

Curator.—R. B. Meyer.

NATIONAL ZOOLOGICAL PARK

Director.—T. H. Reed.

Associate Director.—J. L. Grimmer.

General Curator.—Waldfried T. Roth.

Zoologist.—Marion McCrane.

Veterinarian.—James F. Wright.

CANAL ZONE BIOLOGICAL AREA

Resident Naturalist.—M. H. Moynihan.

INTERNATIONAL EXCHANGE SERVICE

Chief.—J. A. Collins.

NATIONAL GALLERY OF ART

Trustees:

EARL WARREN, Chief Justice of the United States, *Chairman*.
 DEAN RUSK, Secretary of State.
 DOUGLAS DILLON, Secretary of the Treasury.
 LEONARD CARMICHAEL, Secretary of the Smithsonian Institution.
 CHESTER DALE.
 PAUL MELLON.
 RUSH H. KRESS.
 JOHN HAY WHITNEY.
 JOHN N. IRWIN II.

President.—CHESTER DALE.

Vice President.—PAUL MELLON.

Secretary-Treasurer.—HUNTINGTON CAIRNS.

Director.—JOHN WALKER.

Administrator.—ERNEST R. FEIDLER.

General Counsel.—HUNTINGTON CAIRNS.

Chief Curator.—PERRY B. COTT.

* * * *

Honorary Research Associates, Collaborators, and Fellows

OFFICE OF THE SECRETARY

John E. Graf

UNITED STATES NATIONAL MUSEUM

MUSEUM OF NATURAL HISTORY

Anthropology

J. M. Campbell, Archeology.	Betty J. Meggers, Archeology.
G. H. Cole, Archeology.	F. M. Setzler, Anthropology.
Albert Jamme, Archeology.	H. Morgan Smith, Archeology.
N. M. Judd, Archeology.	W. W. Taylor, Jr., Archeology.
H. W. Krieger, Ethnology.	W. J. Tobin, Physical Anthropology.

Zoology

Mrs. Doris H. Blake, Insects.	Allen McIntosh, Mollusks.
J. Bruce Bredin, Biology.	J. P. Moore, Marine Invertebrates.
M. A. Carriker, Insects.	C. F. W. Muesebeck, Insects.
Ailsa M. Clark, Marine Invertebrates.	W. L. Schmitt, Marine Invertebrates.
H. G. Deignan, Birds.	Benjamin Schwartz, Helminthology.
C. J. Drake, Insects.	R. E. Snodgrass, Insects.
Herbert Friedmann, Birds.	T. E. Snyder, Insects.
F. M. Hull, Insects.	Alexander Wetmore, Birds.
Laurence Irving, Birds.	Mrs. Mildred S. Wilson,
W. L. Jellison, Insects.	Copepod Crustacea.

Botany

C. R. Benjamin, Fungi.	F. A. McClure, Grasses.
Mrs. Agnes Chase, Grasses.	Kittie F. Parker, Phanerogams.
E. P. Killip, Phanerogams.	J. A. Stevenson, Fungi.
E. C. Leonard, Phanerogams.	W. N. Watkins, Woods.

Geology

C. W. Cooke, Invertebrate Paleontology.	W. P. Woodring,
W. T. Schaller, Mineralogy.	Invertebrate Paleontology.

MUSEUM OF HISTORY AND TECHNOLOGY

History

Mrs. Arthur M. Greenwood,	I. N. Hume, Cultural History.
Cultural History.	F. W. MacKay, Numismatics.
E. C. Herber, History.	

Science and Technology

D. J. Price.

Exhibits

W. L. Brown, Taxidermy.

BUREAU OF AMERICAN ETHNOLOGY

Sister M. Inez Hilger.	A. J. Waring, Jr.
M. W. Stirling.	

ASTROPHYSICAL OBSERVATORY

C. G. Abbot.

FREER GALLERY OF ART

Oleg Grabar.	Max Loehr.
Grace Dunham Guest.	Katherine N. Rhoades.

NATIONAL AIR MUSEUM

Frederick C. Crawford.	Alfred V. Verville
John J. Ide.	

NATIONAL ZOOLOGICAL PARK

E. P. Walker.

CANAL ZONE BIOLOGICAL AREA

C. C. Soper.

Report of the Secretary of the Smithsonian Institution

LEONARD CARMICHAEL

For the Year Ended June 30, 1962

To the Board of Regents of the Smithsonian Institution:

GENTLEMEN: I have the honor to submit a report showing the activities and condition of the Smithsonian Institution and its branches for the fiscal year ended June 30, 1962.

GENERAL STATEMENT

The writer of any annual report can well be accused of a want of originality if each year he begins by saying, "The twelve months covered by this report have been characterized by progress and constructive activity." Lacking in novelty as it is, this statement, however, must be made with strong emphasis about the Smithsonian Institution for the period between July 1, 1961, and June 30, 1962, for this year has indeed seen outstanding advances in many areas of the Institution's work.

There is one aspect of this year's accomplishment that is of primary importance but that cannot easily be reduced to statistics or presented on a graph. This pertains to the strengthening of the staff. During the months covered by this Report, there have been a number of retirements for age and for other reasons from the professional staff of the Institution. A number of these losses were of very distinguished scholars who can never be exactly replaced; but, on the other hand, a number of outstanding new scientists and academic specialists have come to the Institution, some of them already widely known because of their previous scholarly contributions. For many years the professional or, as it may be termed, the academic staff of the Institution has enjoyed world-wide respect because of the individual distinction of many of its members. The year's new appointments will, I am confident, strengthen this great Smithsonian tradition. It is surely important that Smithsonian experts be leaders in their varied fields if the Institution is to perform in the best possible way the specialized and in some ways unique functions assigned to it by its founder and by the Congress.

James Smithson, in leaving what was for his time a large estate to the United States, directed in his will, written almost a century and a half ago, that the institution that was always to bear his name should be devoted to "the increase and diffusion of knowledge among men." The basic legislation that created the Smithsonian was passed by the Congress and signed by President James K. Polk 116 years ago. One of the most important provisions of the act is the direction that the Institution should be faithful in the execution of the trust of James Smithson "according to the will of the liberal and enlightened donor."

The first Smithsonian Board of Regents wisely chose Joseph Henry, then possibly the greatest student of experimental science in America, as the first Secretary of the Institution. The group of men who were assembled and who worked in the then new Smithsonian Building constituted the first research organization with a full-time staff of investigators in a wide variety of scientific fields ever assembled on this continent. Particularly during the Institution's first half century, under the effective administration of Henry and of his successor, Spencer F. Baird, a staff of broad-gauge, distinguished scientists was built up. Such names come to mind as George Brown Goode, John Wesley Powell, William Healey Dall, Robert Ridgway, Frank Hamilton Cushing, W J McGee, William Henry Holmes, and Leonard Stejneger—principally naturalists, ethnologists, and explorers who brought distinction to the Smithsonian through the notable contributions to science that they made each in his field.

Since Henry's and Baird's time there has been no deviation from the policy of naming to the staff individuals who have won a recognized place as leaders in the various fields of science and scholarship that are dealt with at the Institution. The high title of "curator" at the Smithsonian thus becomes the equivalent of a research professorship in any great university.

Last year the Smithsonian published 85 titles, making available to the world the results of Smithsonian research. This brings the total number of scholarly publications of the Smithsonian to at least 10,000 since its first scientific monograph appeared in 1848. Besides these formal publications the staff of the Institution also answered over 325,000 specific requests for information during the period covered by this report.

One who knows the staff of the Institution in detail can go through the names of those who work in its bureaus and laboratories with a feeling of deep pride at the distinction of the men and women who are spending their professional lives at the Smithsonian.

In the Museum of Natural History, which is part of the United States National Museum of the Smithsonian Institution, there are

many very highly regarded scientists. For example, in the field of anthropology the Institution has distinguished archeologists, ethnologists, and students of cultural and physical anthropology. In the area of zoology there are experts on mammals, birds, reptiles, amphibians, fishes, insects, marine invertebrates, mollusks, and other fauna. In all the principal branches of botany the Institution has experts who work with the millions of specimens of plants in the United States National Herbarium of the Smithsonian Institution. The same may be said of the Smithsonian's department of geology, where scholars with expert knowledge in such fields as mineralogy, invertebrate and vertebrate paleontology, and paleobotany are at work.

The Museum of History and Technology, which also is a part of the United States National Museum, has on its staff experts in the history of the physical sciences, mechanical, electrical, civil, and other fields of engineering, and the history of transportation and of the medical sciences. Under the general heading of arts and manufactures, the Institution has experts in textiles, ceramics, glass, agricultural implements, and the processes and equipment of the so-called heavy industries. In the department of civil history the Institution has scholars who are specialists in political history, cultural history, as well as in philately and numismatics. The research staff of the Division of Military and Naval History deals in an expert way with the facts and especially of museum objects that are related to the development of the Armed Forces of the Nation.

The Bureau of American Ethnology and the Astrophysical Observatory of the Smithsonian both have staffs of distinguished scientists. In the field of art, the National Gallery of Art, the National Collection of Fine Arts, and the Freer Gallery of Art all are represented by scholarly staffs. The same may be said of the staff of the National Air Museum, the National Zoological Park, and the Canal Zone Biological Area.

This outline enumeration of these fields of expert knowledge represented at the Smithsonian demonstrates how important it is for the Institution at all times to devote its best energies to the securing of individuals for its staff who have outstanding qualifications. Today, because of increasing competition with large governmental organizations and research oriented universities, obtaining men and women of high distinction for what may be called the research faculty of the Smithsonian is not easy. The current year has, however, been one in which some truly outstanding scholars have elected to join the family of experts who make up the modern Smithsonian.

In last year's report a summary was given of the progress that had taken place in recent years in the renovation of exhibits at the Smithsonian. Work on this great program continued in an active way dur-

ing the present year. Once again it may be pointed out that as a result of the new educationally significant exhibits now on view the total attendance at the Smithsonian again reached an all-time record. In the old Smithsonian Institution buildings on the Mall, exclusive of the National Gallery of Art and the National Zoological Park, attendance this year reached 8,923,131. This is an increase of 1,819,657 visitors over the previous year. This year's attendance becomes even more dramatic when it is remembered that only 10 years ago the total attendance at these same buildings was 3,103,651.

It is important for all who are interested in the work of the Smithsonian to remember that in spite of its outstanding new exhibits the total collections of the Smithsonian contain many more objects than are on exhibition. These great study collections are utilized by hundreds of research workers from other government bureaus and from universities all over the United States each year. The total number of cataloged objects at the Smithsonian Institution now numbers nearly 56 million.

When the east and west wings of the Natural History Building are completed and opened for use and when the great new Museum of History and Technology is open, the effectiveness of the whole pattern of public display and of the use of study collections will be greatly increased.

To all who are interested in the active present programs of the Institution, it is important to point out that the high caliber of its staff, the new Smithsonian buildings, the improvements in the display of objects, and the increase of collections are all directly and indirectly related to the leadership of the Institution provided by its distinguished Board of Regents. The Secretary and all the staff members of the Institution can never express in an adequate way their deep debt of gratitude to the members of the Board of Regents for all that they do each year for the welfare of the Smithsonian Institution.

THE ESTABLISHMENT

The Smithsonian Institution was created by act of Congress in 1846, in accordance with the terms of the will of James Smithson, of England, who in 1826 bequeathed his property to the United States of America "to found at Washington, under the name of the Smithsonian Institution, an establishment for the increase and diffusion of knowledge among men." In receiving the property and accepting the trust, Congress determined that the Federal Government was without authority to administer the trust directly, and, therefore, constituted an "establishment," whose statutory members are "the President, the Vice President, the Chief Justice, and the heads of the executive departments."

THE BOARD OF REGENTS

The Institution suffered a deep loss during the year in the deaths of two of its Regents: Representative Overton Brooks on September 16, 1961; and Dr. Arthur H. Compton on March 15, 1962. Mr. Brooks had served as a Regent for over 6½ years, and Dr. Compton's length of service as a Regent (over 23 years) is exceeded by only one member of the present Board. The wisdom and counsel of these eminent and distinguished members will be greatly missed. Representative Michael J. Kirwan of Ohio was appointed by the Speaker of the House of Representatives to fill the vacancy in the congressional membership. The appointment to the vacancy in the class of Citizen Regents was pending at the end of the fiscal year covered by this report.

The roll of Regents at the close of the fiscal year was as follows: Chief Justice of the United States Earl Warren, Chancellor; Vice President Lyndon B. Johnson; members from the Senate: Clinton P. Anderson, J. William Fulbright, Leverett Saltonstall; members from the House of Representatives: Frank T. Bow, Clarence Cannon, Michael J. Kirwan; citizen members: John Nicholas Brown, Robert V. Fleming, Crawford H. Greenewalt, Caryl P. Haskins, and Jerome C. Hunsaker.

An informal dinner meeting, preceding the annual meeting, was held on the evening of January 24, 1962, in the main hall of the Smithsonian Building. Exhibits were arranged at this time from the various divisions showing some of the most recent developments in the work of the Smithsonian bureaus. Dr. Nicholas Hotton III spoke on "Mammal-like Reptiles of South Africa"; Dr. Philip K. Lundberg on "The Revolutionary War Gunboat *Philadelphia*"; Dr. Harold P. Stern on "Research and Contrast—Japanese Art in European Collections"; and Dr. Fred L. Whipple on "Dust in Space."

The annual meeting was held on January 25, 1962. The Secretary presented his published annual report on the activities of the Institution. The financial report for the fiscal year ended June 30, 1961, was presented.

In addition to the annual meeting, the Board of Regents met again on May 18, 1962. A brief report was presented on the new Museum of History and Technology Building, and the chairman of the executive and permanent committees of the Board presented a financial report. The Regents then adjourned to inspect the Air and Space Building.

FINANCES

A statement on finances, dealing particularly with Smithsonian private funds, will be found in the report of the executive committee of the Board of Regents, page 227. Funds appropriated to the Insti-

tution for its regular operations for the fiscal year ended June 30, 1962, totaled \$9,125,000. Besides this direct appropriation, the Institution received funds by transfer from other Government agencies as follows: From the District of Columbia for the National Zoological Park, \$1,387,600; from the National Park Service, Department of the Interior, for the River Basin Surveys, \$231,705.

VISITORS

Visitors to the Smithsonian group of buildings on the Mall reached a total of 8,923,131, an all-time high and 1,819,657 more than for the previous year. April 1962, with 1,490,262, was the month of largest attendance; August 1961 second, with 1,335,189; May 1962 third, with 1,160,980. Table 1 gives a summary of the attendance records for the five buildings; table 2, groups of school children. The figures are all actual counts and are not estimates. No fully satisfactory plan for an actual count of visitors to the National Zoological Park has been developed. Under the new plan of estimating, the number of visitors during the year covered by this report indicates an attendance at the Zoo of 2,035,000. When this figure is added to the figure for attendance in the Institution's buildings on the Mall, and to the 1,332,506 recorded at the National Gallery of Art, the total Smithsonian attendance for 1962 may be set at 12,290,637.

TABLE 1.—Visitors to certain Smithsonian buildings during the year ended June 30, 1962

Year and month	Smithsonian Building	Arts and Industries Building	Natural History Building	Air and Space Building	Freer Building	Total
<i>1961</i>						
July-----	158, 793	540, 436	255, 738	161, 542	13, 803	1, 130, 312
August-----	161, 689	647, 184	304, 306	208, 486	13, 524	1, 335, 189
September--	49, 403	186, 702	109, 433	58, 295	6, 008	409, 841
October-----	51, 248	174, 515	127, 271	70, 705	7, 456	431, 195
November--	56, 467	157, 901	135, 748	87, 687	7, 589	445, 392
December---	30, 480	77, 897	75, 354	51, 919	5, 625	241, 275
<i>1962</i>						
January-----	28, 268	73, 554	77, 397	48, 434	5, 430	233, 083
February---	44, 842	109, 370	105, 047	84, 112	6, 289	349, 660
March-----	70, 750	164, 641	142, 139	163, 651	11, 220	552, 401
April-----	210, 408	521, 962	302, 351	433, 612	21, 929	1, 490, 262
May-----	165, 161	424, 154	252, 709	304, 785	14, 171	1, 160, 980
June-----	194, 603	392, 734	225, 560	313, 091	17, 553	1, 143, 541
Total---	1, 222, 112	3, 471, 050	2, 113, 053	1, 986, 319	130, 597	8, 923, 131

TABLE 2.—Groups of school children visiting the Smithsonian Institution during the year ended June 30, 1962

Year and month	Number of children	Number of groups	Year and month	Number of children	Number of groups
<i>1961</i>			<i>1962</i>		
July-----	7, 441	239	January-----	9, 186	296
August-----	4, 506	175	February-----	15, 010	445
September-----	2, 521	77	March-----	39, 490	972
October-----	15, 906	384	April-----	89, 516	1, 735
November-----	27, 689	762	May-----	172, 665	3, 508
December-----	10, 335	288	June-----	66, 587	1, 579
			Total-----	460, 852	10, 460

Report on the United States National Museum

SIR: I have the honor to submit the following report on the condition and operations of the U.S. National Museum for the fiscal year ended June 30, 1962:

COLLECTIONS

During the year 854,135 specimens were added to the national collections and distributed among the eight departments as follows: Anthropology, 13,556; zoology, 480,003; botany, 32,236; geology, 115,387; science and technology, 2,363; arts and manufactures, 3,155; civil history, 205,358; and armed forces history, 2,077. The largest divisional acquisition was in the division of insects, which accessioned a total of 417,279 specimens. Most of this year's accessions were acquired as gifts from individuals or as transfers from Government departments and agencies. The complete report on the Museum, published as a separate document, includes a detailed list of the year's acquisitions, of which the more important are summarized below. Catalog entries in all departments now total 55,817,940.

Anthropology.—The division of archeology received by transfer from the River Basin Surveys 11,334 artifacts, mainly of mid-19th-century white man's manufacture, from the site of Fort Berthold, N. Dak. The following important additions to the divisional Latin American collections were also received: 24 pre-Spanish textiles from Peru, presented by the International Business Machines Corp.; a representative group of 42 stone and bone artifacts from the early cultures of the Lagoa Santa area in Minas Gerais, Brazil, presented by H. V. Walter, of Belo Horizonte; and a type collection of 290 pottery and stone artifacts from various cultural levels on the islands at the mouth of the Amazon River, collected and donated by Drs. Clifford Evans and Betty Meggers.

As a gift from the Government of India, the division of ethnology received 292 ethnological objects, including a complete assemblage of dance costumes of the Kathakali religious drama of South India, textiles of unusual quality, and representing a wide range of techniques and designs. Another fine ethnological collection, comprising native musical instruments and a large number of shadow-theater puppets, was donated by the Federation of Malaya through its National Mu-

seum in Kuala Lumpur. Obtained from Rev. Francis Lambrecht, of Baguio, Philippine Islands, and from Dr. Harold C. Conklin, of Columbia University, are 51 cultural objects of the Ifugao, one of the mountain peoples of the Philippines. Approximately 854 ethnological specimens from India, Pakistan, Northern Rhodesia, the eastern Congo, the Cook Islands, and the Solomon Islands were procured from various sources under the exhibits modernization program.

The division of physical anthropology received for the first time a good collection of prehistoric skeletal remains. The collection, assembled by Dr. Samuel K. Lothrop and donated by the Peabody Museum, Harvard University, comes from the Venado Beach site located at the Pacific end of the Panama Canal Zone. An important feature of this collection is the presence of a type of cranial deformity heretofore known mainly from Mexico. A donation of 15 prehistoric Indian skeletons from the W. R. Winslow site on the Potomac River in Montgomery County, Md., was received from the Southwestern Chapter of the Archeological Society of Maryland. Dr. Dan Morse of Peoria, Ill., added two specimens from that State to the division's outstanding collection of skeletal evidence bearing on the history of tuberculosis among the earlier American Indians.

Zoology.—Most of the accessions received in the division of mammals represent established programs of collecting and research in various parts of the world. Approximately 450 specimens were obtained by Bernard R. Feinstein from Viet Nam and Cambodia, in cooperation with the Army Medical Research and Development Command and the Bernice P. Bishop Museum. The Smithsonian Institution-Alan Collins Expedition of 1961 contributed 163 mammals from previously unworked areas in Libya and Chad, collected by Dr. Henry W. Setzer. From Panama and the Canal Zone, about 750 mammals were sent to the Museum by Vernon J. Tipton, C. M. Keenan, Carl M. Johnson, Pedro Galindo, Conrad E. Yunker, and other contributors representing agencies cooperating in the major project being conducted by Dr. C. O. Handley, Jr. Several accessions from localities in the eastern United States include specimens collected by Kyle R. Barbehenn in Maryland and New York; by John T. Banks in Virginia; by C. O. Handley, Jr., in Virginia, Georgia, and Florida; by Richard and Daniel Peacock in North Carolina and Virginia; by Daniel I. Rhymer in Virginia; and by Merlin D. Tuttle in Tennessee. Specimens of outstanding interest are 102 bats from Drotzky's Cave and vicinity, Bechuanaland Protectorate, presented by Laurence K. Marshall, and five rare dolphins, *Stenella microps*, from the west coast of Mexico, received from Dr. R. R. Whitney, of the U.S. Fish and Wildlife Service, and Dr. W. L. Klawe, of the Inter-American Tropical Tuna Commission.

Among the 1,454 specimens received in the division of birds is a series of 583 bird skins, 27 skeletons, 3 alcoholic specimens, and 14 eggs contributed by Dr. Alexander Wetmore, retired Secretary of the Smithsonian Institution. From the Republic of Panama Gorgas Memorial Laboratory, 100 bird skins were received, and by transfer from the U.S. Fish and Wildlife Service 419 bird skins, 47 skeletons, 1 alcoholic specimen, and 10 eggs were added to the national collections.

In the division of reptiles and amphibians, several accessions are noteworthy. Procured from Dr. Fred Medem, Instituto de Ciencias Naturales, Bogotá, Colombia, were 226 Colombian frogs. A gift from Dr. Coleman J. Goin, of the University of Florida, of 116 Colombian frogs, an exchange involving the receipt of 9 South American frogs, including a cotype of a Colombian arrow-poison frog, from the British Museum of Natural History, and a gift of 105 South American frogs from Dr. James R. Tamsitt, University of the Andes, Bogotá, Colombia, constitute outstanding additions to the Museum's South American holdings. By transfer from the U.S. Naval Medical Research Unit No. 2, 41 snakes from Taiwan add to the already excellent collection from that island.

The majority of the specimens received in the division of fishes was contributed by the U.S. Fish and Wildlife Service. This co-operation of another Government agency in building up the Smithsonian research collections should be credited to the following individuals: Elbert H. Ahlstrom, W. W. Anderson, Harvey R. Bullis, John R. Clark, Daniel M. Cohen, Eugene Cypert, George F. Kelly, Craig Phillips, James G. Ragan, Donald W. Strasburg, and Paul J. Struhsaker. Dr. Edward C. Raney and Dr. Bruce B. Collette gave 2,500 fishes collected by the latter in Cuba, and Dr. Robert E. Kuntz and Lt. W. H. Wells transferred 1,412 fishes collected at Taiwan by the U.S. Naval Medical Research Unit No. 2.

The largest and perhaps most important accession received in the division of insects is the A. L. Melander collection of Diptera, consisting of approximately 250,000 specimens, including 1,200 types. Through Dr. Alfred Brauer, the W. D. Funkhouser collection of Membracidae (Hemiptera) consisting of 23,855 specimens was received from the University of Kentucky. The Connecticut Agricultural Experiment Station donated, through Dr. James B. Kring, 346 type specimens, including 130 holotypes. Most of these types are Hymenoptera not previously represented in the national collections. Dr. A. Earl Pritchard presented his collection of 12,142 Diptera. N. L. H. Krauss again made a substantial gift in donating 11,572 specimens principally from the Neotropical Region. Col. Robert Traub presented more than 10,000 mites from Malaya and Thailand.

The Graham Heid collection of 2,243 specimens, chiefly Lycaenidae, from Atlanta, Ga., was also obtained. The Boyce Thompson Institute for Plant Research presented 7,966 miscellaneous insects through Dr. Albert Hartzell; O. L. Cartwright donated 7,500 Scarabaeidae from his personal collection; and Dr. C. M. Biezanko added 621 Brazilian insects. Dr. Nell B. Causey, University of Arkansas, donated 415 centipedes, most of which were collected in the southern United States. Received by transfer from the Insect Identification and Parasite Introduction Research Branch, U.S. Department of Agriculture, were 59,673 specimens retained in the course of identifications made by the combined staffs.

Outstanding among the accessions acquired by the division of marine invertebrates were 1,461 identified copepod crustaceans, including 2 holotypes, 2 allotypes, and 672 paratypes of 14 species, donated by Dr. Arthur G. Humes, of Boston University. Received from Mrs. Will Hutchins, Washington, D.C., were 2,000 slides of bryozoans representing the personal collection of her son, the late Dr. Louis W. Hutchins. Dr. Paul L. Illg, University of Washington, added 22 specimens of 10 species of notodelphyid copepod crustaceans, including holotypes of all 10 species, allotypes of 2, and paratypes of 6. From C. E. Dawson, Gulf Coast Research Laboratory, 620 miscellaneous marine invertebrates collected in the Persian Gulf were received. Dr. Arthur Loveridge, St. Helena Island, added 334 miscellaneous marine invertebrates. A gift of 208 amphipod crustaceans collected during a voyage in the Okhotsk Sea of the training ship *Hokusei Maru* was made by Dr. Sigeru Motoda, Hokkaido University. Received from the Carnegie Institution of Washington were 1,800 lots of plankton from the cruises of the *Carnegie*. Received by transfer from the U.S. Navy Hydrographic Office, through William H. Littlewood, were 360 miscellaneous marine invertebrates collected in the Ross Sea by J. Q. Tierney, from the U.S.S. *Staten Island* during the U.S. Navy Deep Freeze Expedition of 1960-61. Collections made for the Smithsonian include 1,165 miscellaneous marine invertebrates from Puerto Rico by Dr. Thomas E. Bowman and 1,512 crayfishes from Alabama, Georgia, North Carolina, Kentucky, and Tennessee by Dr. Horton H. Hobbs, Jr.

A total of 127 accessions, comprising 1,923 lots and 20,621 specimens, was received by the division of mollusks. In addition, 1,597 lots, totaling 14,980 specimens, from previously recorded accessions were added. A number of important collections of marine mollusks from areas in the Indo-Pacific region poorly represented in the study collection were received from various sources. Purchased through the Chamberlain fund was a marine collection of 702 lots containing 2,165 specimens from the Kudat area, North Borneo. Two collections

of marine mollusks from the Seychelles, totaling 195 lots, 1,041 specimens, were received as gifts from Mrs. Margot B. Banks and Barry Grogan. By exchange from the Academy of Natural Sciences of Philadelphia, 92 lots, 920 specimens, of marine mollusks from Madagascar were received. The holotypes of six species of nudibranchs were donated by the Marine Laboratory of the University of Miami through Dr. Gilbert L. Voss.

Botany.—The Gray Herbarium of Harvard University sent in exchange 873 plant specimens, largely from North America. The Herbarium Bogoriense, Bogor, Indonesia, forwarded in exchange 2,417 specimens of Indonesia. Also received in exchange were 950 plants of New Guinea and Australia from the Commonwealth Scientific and Industrial Research Organization, Canberra, Australia; 515 specimens collected in Alaska by J. E. Cantlon from Michigan State University; 300 specimens from Africa from the Istituto Botanico, Firenze, Italy; and 840 plants collected by R. M. King in Mexico from the University of Texas.

The division of woods received the Archie F. Wilson collection, comprising 4,637 wood specimens and constituting a more critically chosen group of specimens from a greater number of species than existed in the division prior to 1960. Mr. Wilson, a business executive with a keen interest in woody plants, was a research associate of the Chicago Natural History Museum for many years. In exchange 727 wood specimens from Netherlands New Guinea were received from the Division of Forest Products of the Australian Commonwealth Scientific and Industrial Research Organization. Important pollen slides received were 309 from Duke University and 642 from the Pan American Petroleum Corp., Tulsa, Okla. Dr. William L. Stern made a collection of 136 wood samples of the highly peculiar flora of the Hawaiian Islands.

Field collecting by staff members yielded the following for the department: 1,091 specimens, mostly grasses, collected in Mexico, by Dr. T. R. Soderstrom, and 1,423 specimens, collected in Oregon, Colorado, Hawaii, and the Florida Keys, by Dr. W. L. Stern. From the U.S. Geological Survey were transferred 593 specimens collected by Dr. F. R. Fosberg on the Pacific Islands, and 766 specimens from Alaska collected by H. T. Shacklette; from the Agricultural Research Service, U.S. Department of Agriculture, 325 specimens of South Africa collected by H. S. Gentry and A. S. Barclay; and from the U.S. Forest Service, 415 specimens from Puerto Rico, collected by E. L. Little.

Geology.—A total of 3,252 specimens was received in the division of mineralogy and petrology. An important gift is a very fine gem-quality crystal of emerald weighing 176.66 carats, from Muzo, Co-

lombia, from Fred C. Kennedy. New mineral species received as gifts were: chambersite, Texas, from Frank R. Beck; orthopinakiolite, Sweden, from the Naturhistoriska Riksmuseets, Stockholm, Sweden; and ferriphengite, Japan, from the University of Tokyo. Outstanding among specimens received in exchange is an extraordinary crystal of kunzite (the lavender gem variety of spodumene) weighing 5 kilograms. New species received in exchange were: birnessite, Massachusetts; rooseveltite, sigloite, and farallonite, Bolivia; kahlerite, Austria; yoshimuraite, Japan; cheralite, Malaya; sharpite and wyartite, Congo; and fleishcherite, South West Africa.

Outstanding specimens added by purchase from the Roebbling fund or by exchange are two groups of very large stibnite crystals completely altered to stibiconite, Mexico; four fine amethyst geodes, Brazil; a large single crystal of amethyst, Korea; two groups of unusually large axinite crystals, Japan; and a collection of 40 very fine wulfenite specimens from various localities in Arizona. Acquired by purchase from the Canfield fund is a very large single crystal of danburite, Mexico, and a large tourmaline crystal from Baja California.

New acquisitions to the gem collection are the following: a 423-carat sapphire, one of the largest and finest in the world, from Mrs. John Logan (the former Mrs. Rebecca Guggenheim); a large wine pourer carved in white jade, formerly a part of the Vetlesen jade collection, donated by Mrs. Mildred Taber Keally; and a female head sculptured in pink tourmaline by Oskar J. W. Hansen, given by Ray A. Graham. Gem specimens acquired by purchase from the Chamberlain fund for the Isaac Lea collection include a 45.9-carat sphalerite, Spain; a kornerupine weighing 21.58 carats, Ceylon; smoky quartz, Brazil, weighing 1,695.5 carats; a 71.05-carat brownish yellow spodumene, Madagascar; two scheelites, one weighing 37 carats from California, and the other 7.35 carats from Mexico; and a fine kunzite from Brazil weighing 63.30 carats.

A number of outstanding gems were received in exchange, including a very fine 287-carat peridot, an extraordinary 330-carat blue star sapphire, and a fine ruby spinel weighing 36.10 carats, all from Burma; and an excellent 187-carat aquamarine from Brazil.

During the year 25 different meteorites were added to the meteorite collection, including 15 new to the collection. Obtained as gifts were the following: four specimens of the Murray, Ky., meteorite having a total weight of 163 grams, donated by Dyer Observatory, Vanderbilt University; a complete stone which fell in her yard was given by Mrs. Jay Law, Garland, Utah; and a piece of a new Carbonaceous chondrite from Belle, Tex., donated by Oscar Monnig, Fort Worth, Tex.

Fourteen meteorites were obtained by exchange with the following institutions: Geological Survey of India; Committee on Meteorites, Academy of Sciences, U.S.S.R.; Universitets Mineralogiske Museum, Copenhagen, Denmark; Geological Survey of South Africa; and Victoria University, Wellington, New Zealand. Two recent falls, Ras Tamur, Saudi Arabia, and Ehole, Angola, were obtained by transfer from the Smithsonian Astrophysical Observatory.

Several large and important collections of fossil plants and invertebrates were acquired this year by the division of invertebrate paleontology and paleobotany. Funds from the income of the Walcott bequest were used to purchase the incomparable Bones collection of Eocene seeds, nuts, fruits, and wood from Oregon, consisting of over 5,000 specimens of remarkable preservation collected and prepared by Thomas J. Bones, of Vancouver, Wash., over a period of 20 years. The Walcott bequest also made possible field work which yielded 10,000 Cretaceous mollusks and 500 Foraminifera samples, collected by associate curator Erle G. Kauffman and Dr. Norman F. Sohl; and 10,000 specimens of Ordovician and Silurian invertebrates from those respective formations of Great Britain, Norway, and Sweden collected by curator Richard S. Boardman.

Donations from collectors outside of the Museum accounted for the following gifts: 1,500 Lower Paleozoic fossils from areas including Nova Scotia, Maine, Germany, and Gotland from Dr. Arthur J. Boucot, of the California Institute of Technology; 345 type specimens of Foraminifera from California and the Mississippi Delta regions from Miss Frances L. Parker, of Scripps Institution of Oceanography; 175 type specimens of planktonic Foraminifera from the Caribbean region from Dr. Pedro J. Bermudez, of Venezuela; 87 ostracod types from the early Middle Ordovician of eastern United States and 146 types from the Gubic formation of northern Alaska from Dr. F. M. Swain, Jr., University of Minnesota; 300 specimens from the Ripley formation received from the Mid-South Earth Science Club of Tennessee; 350 specimens from the Devonian of the Spanish Sahara from the Pan American Hispano Oil Co.; and 332 Mesozoic specimens from Saudi Arabia donated by the American Arabian Oil Co.

Transfer of collections from the U.S. Geological Survey includes the Hass collection of conodonts, numbering an estimated 40,000 specimens and several hundred types; 168 Middle and Upper Devonian cephalopods collected by Dr. Mackenzie Gordon in Morocco; an estimated 35,600 Bryozoa from the Lower Paleozoic of New York, West Virginia, Virginia, and Tennessee, collected by Dr. Boardman.

A collection of 189 specimens of fossil mammal-like reptiles from the Karroo, Republic of South Africa, was accessioned in the division of vertebrate paleontology. These specimens are representative of

all levels of the Beaufort series (Permo-Triassic) and document the therapsid adaptive radiation of that time and also the strong trend toward mammalian organization for which these animals are noted. The therapsids illustrate an important phase in vertebrate evolution, which has heretofore been unrepresented in the national collections. The therapsids illustrate an important phase in vertebrate evolution, which has heretofore been unrepresented in the national collections. The fossils are of high quality, consisting of about 40 complete or partial skeletons with the remainder being skulls. The collection was made by associate curator Nicholas Hotton III and by James W. Kitching, of the Bernard Price Institute for Paleontological Research, University of the Witwatersrand, Johannesburg. Noteworthy of mention also are the skulls of about 200 individuals of the Permian amphibian *Diplocaulus* collected by Dr. Sergius H. Mamay, of the U.S. Geological Survey, and Dr. Walter W. Dalquest, of Midwestern University, in terrestrial deposits of the Vale formation in Texas. Another outstanding addition to the collections is a 4-ton shipment of skeletal remains, almost all of the mammoth *Mammuthus columbi*, from a spring deposit on the ranch of Charles I. Lamb near Littleton, Colo. These were collected by a joint archeological-paleontological party under the supervision of Dr. Waldo R. Wedel and Dr. C. L. Gazin. Particular mention may be made of stratigraphically important accessions of Eocene and Paleocene mammals from new localities in the Fossil, Wind River, and Green River basins of Wyoming, and of early Oligocene mammal jaws and teeth from Pipestone Springs in Jefferson County, Mont., collected by curator C. L. Gazin and Franklin L. Pearce.

Science and technology.—Examples of the rotating mirrors used by A. A. Michelson in his experiments in the determination of the velocity of light were obtained in the division of physical sciences from Preston Bassett and from Mount Wilson and Palomar Observatories. Dr. Henry E. Paul donated telescopes representing the work of Alvan Clark and Sons and John Brashear. Two of the earliest extant examples of photographs of the sun and moon, made by the pioneer scientist and photographer John W. Draper, were obtained from New York University. A group of 12 globes painted to illustrate as many geophysical phenomena, from Prof. Rhodes W. Fairbridge, of Columbia University, was added to the geophysical collections. Gulf Research & Development Co. contributed the pendulum apparatus for relative gravity determination which was developed by them in 1929. John Kusner contributed a repeating circle of the type used in the 1830's in the first geodetic surveys in this country.

A reproduction of the celebrated clock of Giovanni de Dondi, constructed from contemporary 14th-century manuscript descriptions, was acquired in the division of mechanical and civil engineering. The original clock, which disappeared from historical account over 400

years ago, was built in Padua between 1348 and 1364. It is the earliest mechanical clock of which details survive but is in no way a primitive clock. The calendar and astronomical dials surpass by a wide margin any other known pre-Renaissance mechanism. An astronomical clock with torsion pendulum by the American inventor Aaron D. Crane was added to the timekeeping collection. This was the basis of the 400-day or anniversary clocks of modern times. An experimental model of the cesium beam atomic clock, developed at the Massachusetts Institute of Technology in 1956 by Dr. J. R. Zacharias, was also received.

A simple condensing mill steam engine built in 1819 by Thomas Holloway, of Philadelphia, was added to the collection of heavy machinery. This severely simple machine, the earliest stationary steam engine in the collection, contrasts markedly with the refinement of the Mathias Baldwin engine built in the same city only 10 years later. A model of one of the Allis-Chalmers-Westinghouse engine generators of the type built in 1904 to power New York's first subway was also added to this collection. One of the most important acquisitions of the section of tools was a multiple-spindle drill used from 1905 for the production of cash-register frames, donated by the manufacturer, the National Automatic Tool Co. Another important accession comprised a collection of tools, instruments, and documents representing the pioneering experiments in the 1920's of Prof. Orlan W. Boston, of the University of Michigan, in the investigation of metal-cutting processes.

Through the courtesy of the University of California, the division of transportation received seven important builder's half models of West coast steamers and sailing vessels built by the Dickie Yard in San Francisco. Outstanding models received were those of the Mississippi River stern-wheel steamer *Greenbrier*, the Chesapeake bay steamers *Pocomoke* and *President Warfield*, a Letter-of-Marque schooner of 1815, the ferryboat *Jersey*, South Sea Island trader *Tahiti*, Alaskan trader *Ounalaska*, a Florida shrimp trawler, and a North Carolina Sounds schooner. The two last named were received, respectively, from the Diesel Engine Sales Co. and from W. C. Matthews. The section of land transportation passed a landmark with acquisition of a full-sized example of a modern steam locomotive, No. 1401 of the Southern Railway System, which was generously donated by that company. Two important carriages were also added to the collection, a landau of 1879, from Chauncey D. Stillman, and a buckboard of 1890, from Edwin H. Arnold.

The division of electricity received from the University of Michigan 11 examples of H. N. Williams' work with the magnetron, a high-frequency oscillator, dating from the 1930's. Obtained from the Radio Corp. of America is a group of cathode-ray tubes used in the

development of television. The color television system developed in 1951 by J. M. Lafferty, of the General Electric Research Laboratory, is represented by a tube received from that company.

Individual items of importance added to the electrical collections were printing telegraphs, received from the Western Union Telegraph Co. and the Netherlands Postal Museum; a set of Pupin loading coils arranged to simulate the telephone circuit from New York to Boston, from the Armstrong Memorial Research Foundation; the Sorensen vacuum switch for power circuits, from Prof. R. W. Sorensen; and the radio sextant developed by the Collins Radio Co., transferred by the U.S. Department of the Navy.

The division of medical sciences acquired from the University of Illinois the remarkable Edward H. Angle collection of dental instruments and related material, and from Dr. Julius Lempert a collection of otological instruments representing Dr. Lempert's well-known work in that field.

Arts and manufactures.—The division of textiles received an excellent collection of 10 examples of buratto and drawnwork lace of the 16th through the 19th century, presented by Miss Harriet Winslow. Mrs. Beatrice E. Baker added a group of beautiful costume laces to this collection. Mrs. W. A. Pickens presented a "Feathered Star" quilt made by the wife of Gen. Mordicai Gist. Dr. and Mrs. Leonard Carmichael donated several interesting examples of silk embroidery on wool, used for infant wear. Three excellent needlepoint pictures, lent to the division several years ago, were bequeathed to the Museum by the late Crystal Palmer. These fine examples were made by Miss Palmer's grandmother in the mid-19th century. An interesting sewing machine, an 1859 West and Willson model, a type not previously represented, was donated by Mr. and Mrs. L. E. Isaacson.

The division of ceramics and glass received a collection of rare 18th-century porcelain, donated by Dr. and Mrs. Hans Syz, of Westport, Conn. Important pieces in this group include a Boettger tankard of red stoneware, 1712-15; a Boettger white porcelain bowl with applied decoration of rose buds and leaves, 1715; and a Viennese porcelain trembleuse cup and saucer, 1730-35. To her previous gift Mrs. W. A. Sutherland has added 25 pieces of fine porcelains, including 2 rare Bow mugs, 1760, and an unusual Chelsea dish, 1752.

A magnificent example of printing, *The Works of Geoffrey Chaucer*, printed in 1896, was presented to the division of graphic arts by the Honorable Clinton P. Anderson, a Regent of the Smithsonian Institution. Known as the *Kelmscott Chaucer*, the book is the handiwork of William Morris, whose concern with fine craftsmanship resulted in a revival of high standards in industrial design. Another impor-

tant accession is a lithograph, *Divertissement d'Espagne*, by the Spanish artist Francisco Goya. The gift of Albert H. Gordon, of New York City, through E. Weyhe, Inc., this rare and valuable print is one of a set of four bullfight subjects that is considered the first great product of lithography.

Among the important prints obtained were two separate states of the lithograph *Il tombe dans l'abime*, by the French artist Odilon Redon; three lithographs from *Campaign Sketches* by Winslow Homer, the American artist who documented the Civil War, *A Pass Time (Cavalry at Rest)*, *Foraging*, and *The Baggage Train*; two color aquatints, *Juggler* and *Ballerina*, by Georges Rouault; five rare lithographs by outstanding American contemporaries, *Brown Moons* by Helen Frankenthaler, *Poet I* by Robert Motherwell, *Last Civil War Veteran* by Larry Rivers, *Speaker* by Robert Goodnough, and *Coathanger* by Jasper Johns; two chiaroscuro woodcuts, *The Visitation* after Annibale Carracci and *Statuette of Neptune* after Giovanni da Bologna, by John Baptist Jackson, the 18th-century master of the color woodcut.

Among the fine examples of photographic equipment and prints acquired by the section of photography was a Cinematographe, invented in 1895 by Auguste and Louis Lumière of France. This was one of the earliest devices to take and project (perforated) motion-picture film. The section also acquired an important collection of apparatus invented by Frederic Eugene Ives, of Philadelphia, a pioneer in color photography. This group includes an Ives Lantern Kromskop, made about 1890, the first practical device to use 3-color separation positives for projecting full color on a screen; a group of slides for this projector; an 1894 Ives photochromoscope Kromskop stereo camera and viewer, and a large number of Kromogram slides for use in the viewer. The Kromskop System offered a method for taking color separation stereo pictures and viewing them in full color.

Of particular interest among specimens received in the division of manufactures and heavy industries are some of the first stampings of aluminum made from the first commercial production of the Hall process. These, presented by the Scovill Manufacturing Co., will shortly be shown in a special exhibit which will include the first globules of aluminum produced by Charles Martin Hall in February 1886. Another important acquisition is a Winsted machine which was built prior to 1873 and which was in active use at the American Brass Co.'s plant at Waterbury until 1961. Dr. W. L. Libby donated to the section of nuclear energy the experimental equipment used in his pioneer work to establish the dates of archeological material by carbon-14 dating. Two of the first X-ray tubes to be made in America were donated by the Catholic University of America. The section of iron

and steel obtained the first steam hammer erected in the United States, built by Nasmyth between 1851 and 1856 and in use at Taylor-Wharton Iron & Steel Co., High Ridge, N.J., until 1935. The first wide-flange universal beam mill to be erected in the United States was presented by the Bethlehem Steel Co. The United States Steel Corp. donated the pilot model of a Lorig aligner, an important innovation which speeded up the handling of strips of metal in continuous mills.

The division of agriculture and forest products acquired a water-powered sawmill including the building, waterwheel, shafting, and gearing. The mill, a fine representative of 18th- and 19th-century sawmills, operated an up-and-down saw and moved a 30-foot-long carriage against the saw. The New Holland Machine Co. gave a small portable gasoline engine of the early 20th century, used to drive machines such as grinding mills, saws, etc.

Civil history.—The division of political history received the personal memorabilia of President and Mrs. Woodrow Wilson. A black satin dress, worn by Edith Bolling Wilson the first time she dined at the White House and a white silk dress she wore at a diplomatic reception in 1916, her first appearance at a state occasion at the White House after her marriage, were among the items received from Mrs. Wilson's estate through her personal secretary, Mrs. Margaret C. Brown. Mrs. Joseph P. Kennedy donated a white silk gown decorated with gold and silver sequins worn by her when she was presented at the Court of St. James when her husband was Ambassador to Great Britain. The dress was worn again in 1961 at the Inaugural Ball of her son, President John F. Kennedy. Ralph E. Becker continued his donations from his important campaign collection. The most significant of these is a painted banner, bearing a portrait of Thomas Jefferson, celebrating his victory in 1801. An exciting silk campaign banner carried by the "Downers Grove Plough Boys," a Republican marching club of 1860, was given by Elbert A. Rogers, Downers Grove, Ill. A 3-sided transparency, containing a portrait of Abraham Lincoln and campaign mottoes of 1860, was donated by Mrs. Robert A. Hubbard, Walpole, N.H. Made of cloth and wrapped around a wooden frame, the transparency, with torch inside, was carried on a pole in political parades. Another significant acquisition was the Adelaide Johnson Collection donated by Mrs. Elizabeth Johnson Cristal, a niece of Mrs. Johnson. Adelaide Johnson, a devoted feminist, was best known as the sculptress of the Women's Rights movement. The robe worn by Charles Evans Hughes as Chief Justice of the Supreme Court was received from the New Canaan Historical Society through Dorothy Cocks, New Canaan, Conn.

Noteworthy donations to the collections of the division of cultural history include two early-19th-century blown-glass whale-oil lamps,

a 17th-century brass *couvre-feu*, and other domestic objects, from Preston R. Bassett; a set of chamfered oak bed posts of a hitherto unidentified type of 17th-century Massachusetts bedstead, the gift of Virginia Beets; five paintings, 19th-century American, by E. L. Henry and Eastman Johnson, given by Mrs. Francis P. Garvan; and five diorite door and marker stones with primitive carved designs and dates, from the site of a mansion built by Lt. Gov. William Dummer of Massachusetts in Byfield in that State, donated by Mr. and Mrs. Stephen Twaddell.

The division of philately and postal history received a specialized collection of the famous La Guaira local stamp. These issues, authorized by the Venezuelan Government, were prepared by Waterlow & Sons for the mail carried by steamship between La Guaira, Puerto Cabello, and St. Thomas beginning in 1864. L. W. Christenson, of Cleveland Heights, Ohio, gave a collection of the issues of Manchukuo and of the Ryukyu Islands, which include postal stationery, booklets, covers, and a number of reference books. James A. Farley, former Postmaster General, donated a number of new covers. Dr. Joseph H. Kler, of New Brunswick, N.J., gave an initial portion of his prize-winning topical collection of stamps pertaining to Rotary International and placed the balance on loan. In eight albums are mounted many full sheets, singles, blocks, and many covers bearing appropriate cancels and cachets. Included also are several preliminary artist's drawings, some printer's proofs, and the Monaco color-error essay.

The most outstanding additions to the numismatic collections are the original obverse and reverse dies prepared in 1861 by Robert Lovett, Jr., of Philadelphia, for the proposed striking by the Confederacy of a copper cent, an issue which never materialized. The dies, two hubs made from the original dies, and other material in connection with the restrike of the Confederate cent in 1962 were received from Robert Bashlow, of New York. A rare 1916 pattern half dollar, a gift of Benjamin M. Douglas, and a silver ingot put out by the Nevada Silver Co. in 1876, a gift of Harvey Stack, of New York City, are also notable. A collection of 436 Polish gold, silver, and copper coins and medals was donated by Christian Zabriskie, of New York. This remarkable collection was started in the 1870's by the donor's father, Andrew Zabriskie, a noted United States numismatist. To his previous donations of Russian coins and medals coming from the famous Grand Duke Mikhailovitch collection, Willis H. duPont added another significant group of 860 specimens, including many exceedingly rare pieces issued during the reigns of Czar Ivan III and Czarina Elizabeth (1740-62). An interesting group of Babylonian and Sumerian clay tablets recording commercial transactions was given by I. Snyderman, of New York. Pietro Giampaoli, chief en-

graver at the Rome Mint and one of the foremost medal engravers in the world, donated a select group of his own medals exemplifying various stages in his artistic evolution. A modern silver medal of exceptional artistic merit, issued by the Maison Carrée of Nîmes in 1961, was given by the Honorable Claiborne Pell, Senator from Rhode Island.

Armed Forces history.—A unique 1842 pattern musket and set of Ordnance Department inspectors' verifying gauges were received in the division of military history from William H. Guthman. A rare 13-inch bomb fired by the British fleet at the time of its attack on Alexandria in 1814 was received from the Department of the Army. Through the courtesy of Adm. Sir John Moore, the Victoria Cross and associated service medals awarded Private John McGovern for gallantry during the Indian Mutiny were deposited as a long-term loan from the Royal United Service Institution. Also received on loan, from David N. Rust, was a rare cavalry saber made by John Potter and formerly owned by Col. George Baylor, aide-de-camp to George Washington.

A significant addition to the Museum's extensive flag collections is the 48-star national ensign that served as the official flag of the 1960-61 Antarctic Expedition on its traverse from Byrd Station to the South Pole, presented by Rear Adm. David M. Tyree through Rear Adm. William Rea Furlong.

An important collection of objects recovered from Bermuda shipwreck sites dating from about 1621 to 1914 was added to the collections through the field work of head curator Mendel L. Peterson, in cooperation with E. B. Tucker and the Government of Bermuda.

The year's most important accession in the division of naval history is the Continental gundelo *Philadelphia*. The oldest major American naval relic of the Revolutionary War, the gundelo reached final moorings early in December 1961, when it was moved into the new Museum of History and Technology. A shot-scarred survivor of Benedict Arnold's gallant flotilla that opposed superior British invasion forces on Lake Champlain, this flat-bottomed gunboat was sunk at the Battle of Valcour Island on October 11, 1776. For nearly 159 years the *Philadelphia* lay on the muddy bottom of Valcour Bay, before it was located and raised intact in 1935 through the skillful efforts of Col. Lorenzo F. Hagglund, of New York, who donated the historic warship. Over 700 objects were recovered from the 54-foot gundelo, including her entire main battery of 9" and 12-pound guns, with their original carriages, as well as numerous other items of ship's equipage and the crew's gear. Brought to Washington with the generous assistance of the United States Coast Guard and the United States Navy, the oaken-hulled *Philadelphia* will shortly enter another episode in

her long career, that of transporting the Smithsonian Institution's visitors vividly and intimately to that precise moment in the nation's history when this shattered warship, having fired her last shot in our struggle for independence, slid quietly beneath the waters of Lake Champlain.

Notable among early 19th-century naval accessions is an oil painting by Michele Felice Corne, depicting the engagement in 1812 between the *Constitution* and the *Java*, donated by Mrs. Mabel P. Garvan. The Department of the Navy provided two early boarding pikes and a pair of mid-century gangway headboards, on indefinite loan. Valuable light on the emergence of the steam Navy and its Corps of Engineers is provided in the professional correspondence (1847-67) of Chief Engineer James M. Adams, USN, donated by his great grandson, James Adams Knowles. Submarine operations during the Civil War are represented by a superb model of the Confederate submersible *H. L. Hunley*, constructed and presented by Floyd D. Houston, of New Suffolk, N.Y.

EXPLORATION AND FIELDWORK

Dr. T. Dale Stewart, head curator of anthropology, participated in a conference on "Anthropology and the Conditions of Individual and Social Freedom," held at Glognitz, Austria, in August, and also studied specimens of particular interest to him at the Paleontological-Geological Museum at Zagreb, Yugoslavia.

A late Pleistocene bone bed with possible human associations, near Littleton, Colo., was under study last year by Dr. Waldo R. Wedel, curator of archeology, and Dr. C. Lewis Gazin, curator of vertebrate paleontology. This study was resumed in the summer of 1962. Artifacts have been found to a depth of about 40 inches, in association with bison bones. None has yet been found in the lower level where bones of camel and mammoth are more plentiful, indicating that these species may have been the characteristic fauna. The hints of stratification in the faunal remains raised the hope that some sort of cultural stratification will eventually turn up as well. The field party, in charge of George S. Metcalf, museum aide, will continue its work through the summer of 1962.

En route to a site for field work in Ecuador, Dr. Clifford Evans, associate curator of archeology, and his wife, Dr. Betty J. Meggers, honorary research associate, attended a training conference in archeological techniques at Barranquilla, Colombia, in June and early July 1961. The conference had been planned and organized in cooperation with the Pan American Union and was conducted at the Universidad del Atlántico. Young, qualified archeologists came from Argentina, Brazil, Chile, Guatemala, Mexico, Panama, Peru, Uruguay, and Vene-

zuela to participate, and a highly successful interchange of knowledge resulted.

Continuing to Ecuador, Drs. Evans and Meggers spent nearly 3 months in a continuing field study being conducted in collaboration with Emilio Estrada. Aspects of archeology investigated included pre-ceramic horizons, Valdivia culture, Jambelli culture, Mexican cultures in Ecuador, Manteño culture, and Milagro Period burials. The Smithsonian archeologists brought back 59 large boxes of specimens in addition to many notes and data on classified pottery for at least eight stratum cuts of material. Numerous developed and cataloged photographs, both black and white and in color, will be invaluable in working up the results of this expedition.

For a period of nearly 6 months, Dr. Gus W. Van Beek, associate curator of archeology, conducted archeological field work in Wadi Hadhramaut, East Aden Protectorate. He was accompanied by Dr. Glen H. Cole and Dr. Albert Jamme, and Dr. Henry W. Setzer, of the Museum's division of mammals, joined the group for 1 month to collect mammals in the Wadi Hadhramaut region. For 3½ months without interruptions the field party conducted its survey in Hadhramaut, systematically surveying the main wadi from Terim to Shibam (this portion of the wadi is approximately 40 miles long and from 1½ to 4 miles wide) and, more superficially, an additional 40 miles of the western part of the main wadi, from Shibam to Qarn Qaimah beyond Henin; they covered the major portions of all tributary wadies in the region.

Dr. Cole's work on prehistoric sites proved to be highly significant. His was the first systematic work in prehistory ever done anywhere in the Arabian Peninsula, and he should be able to provide a framework for Arabian prehistory and to draw tentative conclusions regarding the affinities of the Arabian industries with those of surrounding regions in Africa and Asia.

Dr. Van Beek discovered and recorded approximately 50 sites, of which 23 are pre-Islamic and 27 Islamic. The pre-Islamic sites range in date from about the 11th or 10th century B.C. to the 7th century A.D., and the Islamic sites from the 7th century A.D. to the present. Some of the pre-Islamic sites are extremely impressive, measuring as much as half a mile long by a quarter of a mile wide. For the most part they consist of good stone masonry, and many structures still have mud-brick walls on masonry podia. On the eroded surface of the sites are vast quantities of potsherds and many fragments of architecture, sculpture, and ancient South Arabic inscriptions in stone. Previous to the work of the expedition, the earliest known occupation of Hadhramaut was the 5th century B.C.; by discovering sites going back to the 11th or 10th centuries B.C., the party has pushed back

the date of human occupation some five or six centuries in the Hadhramaut.

Dr. Jamme copied more than 1,000 graffiti in the main wadi and in tributary wadies. Before his work, no more than 60 or 70 graffiti were known in this entire area and these were on only two rocks. The information thus gained will add enormously to our knowledge of the history of Hadhramaut in pre-Islamic times.

The material collected by Dr. Setzer is the first of its kind from Arabia in the National Museum collections. From an archeological point of view, this collection of mammals will be extremely useful for identifying bones recovered in excavations in this region.

Dr. Van Beek and other members of his party were delighted by the warm reception and excellent relations they enjoyed in Aden and Wadi Hadhramaut. The American Consulate, the British Director of Antiquities for the Colony, the Royal Air Force, the Protectorate Secretary, the Residency Staff in Mukalla and Seiyun, and the officials of the Kathiri State in Seiyun and the Qu'aiti State in Hadhramaut were all extremely cooperative.

En route to and from Aden, Dr. Van Beek visited several institutions and met archeological colleagues in England, Italy, Sudan, Ethiopia, and Jordan. Discussions were very profitable along the lines of mutual research and also in connection with the exhibits program of the Smithsonian, where a new hall of Old World archeology is in the planning stage.

For 2 months of the summer of 1961, Dr. Marshall T. Newman, associate curator of physical anthropology, continued his now nearly completed nutritional study of more than 100 schoolboys of Vicos, Peru. He was accompanied by Dr. William J. Tobin, collaborator of the Smithsonian Institution, and Mrs. Tobin. For several years Dr. Newman and Dr. Tobin have been collaborating with staff members of the Instituto de Nutrición of Lima in this project. Analyses of the data obtained are necessarily complicated, but in a preliminary way the following conclusions are now apparent: Mean weight gains as viewed longitudinally have increased 19-53 percent, depending on the school year, since the school-lunch program started. Stature increases do not appear to be similarly affected. Clinical signs of vitamin and mineral deficiencies declined grossly from 1956 to 1961, and mean hemoglobin levels are up from 13.16 to 14.24 gm/100 ml. Almost all the Vicos boys are within the normal serum calcium limits, but 21 percent are still low in vitamin A and 8 percent are low in serum carotene. An analysis of the detailed metric data is proceeding, and the bone density figures from the X-rays are expected to be available in the near future.

In April Dr. Horton H. Hobbs, Jr., head curator of zoology, under-

took a collecting trip through parts of northwestern Georgia, northern Alabama, and Tennessee. While assembling more than 1,500 specimens of crayfishes, Dr. Hobbs intensively surveyed the Hiwassee drainage system in North Carolina and Georgia, the Tennessee River system in northern Alabama, and the Cumberland in northern Tennessee. It is hoped that the materials collected in these areas will be helpful in clarifying several problems in the genus *Cambarus* that have puzzled students of crayfishes for some 60 years.

In October Dr. Henry W. Setzer, associate curator of mammals, accompanied by museum aide Gary L. Ranck, traveled to Benghazi, Libya, to begin field work on the mammals of Libya. With the aid of every courtesy and cooperation from the 64th Engineer Battalion (Base Topographic Survey), the Smithsonian field party made substantial collections in Libya. Toward the end of November Dr. Setzer went to Aden to join Dr. Van Beek in the Wadi Hadhramaut, leaving Mr. Ranck to carry on studies of the mammals of Libya, which he continued throughout the fiscal year. In Aden, Dr. Setzer spent 4 weeks collecting small mammals and attempting to obtain skeletons of larger mammals for comparative purposes, in connection with the archeological research conducted by Dr. Van Beek.

For 3 months, between January and April, Dr. Charles O. Handley, Jr., associate curator of mammals, continued his long-term study of the mammals of Panama. During this period nearly 2,000 mammals, together with their ectoparasites, as well as several hundred specimens of birds, reptiles, amphibians, fishes, and snails, were preserved. Two previously unsampled faunas were studied: in the high mountains at the southern tip of the Azuero Peninsula and in the islands off the coast of Bocas del Toro. In addition a good high-elevation collection was made in Chiriquí, and previous collections at Cerro Azul were supplemented. During this field study Dr. Handley was assisted by F. M. Greenwell, of the Smithsonian's office of exhibits. Invaluable local assistance in Panama was furnished by the Gorgas Memorial Laboratory and by military services that provided transportation facilities.

In June Dr. Handley spent a few days collecting small mammals in extreme southwestern Virginia. His particular intent was to search for the northern limits in the Appalachian region of some rodents of the Mississippi Valley which have been shown in other areas to be expanding their ranges. As an example, a specimen of the cotton-rat *Sigmodon hispidus* was collected at Ewing, Va., well north of the previously known limit of its range in Tennessee.

Field work on the survey of the geographic distribution and variation of the birdlife of the Isthmus of Panama, under Dr. Alexander Wetmore, honorary research associate and retired Secretary of the

Smithsonian Institution, covered the period from January 3 to April 5, 1962. The month of January was devoted to the valley of the Río Guánico at the southern end of the Azuero Peninsula, a region previously not studied, with shorter trips to the marsh areas in the savannas east of Pacora, and to an area between the Trans-Isthmian Highway and the eastern boundary of the Canal Zone. Early in February work continued in the lower valley of the Río Bayano, with interesting results. Following this the party moved to the Province of Coclé near the Veraguas boundary. In addition to work in the lowlands and the foothill region, one camp was made in rain forest on the Caribbean slope of the continental divide. Three hours distant by trail to the south the vegetation was brown and dry, as is normal on the Pacific slope in the height of the dry season, while at the Tigre camp rain fell daily and the forests were dense and green. Specimens taken here included a number of birds that are little known. Other collections in this region were made during a survey by Jeep of the savannas near the sea, and trips in a dugout canoe to the mangroves in the extensive swamp lands at the mouth of the Río Pocrí.

Dr. Wetmore's final field trip of the season, in the latter half of March, was a survey of the islands that lie between Isla Coiba (visited in 1956) and the Pacific coast of Veraguas and Chiriquí. The party traveled and lived on the launch *Barbara II*, handled expertly in these rough waters by Capt. George Edgington and his companion William Bailey. On this expedition it was finally possible to identify the sooty terns that come to nest on the rocky islets Frailes del Sur off Punta Mala. Collections were made also on the islands Canal de Afuera and Afuerita, and on Brincanco in the Contreras group. All are forested, rock-bound, and uninhabited, with landings possible only on a few tiny beaches. The final specimens were taken on the western end of Isla Cebaco, from an anchorage in the sheltered bay Caleta Cayman. Affinities of the few resident land birds of these islands appear to be with the peculiar forms of Isla Coiba farther at sea, rather than with the adjacent mainland. Throughout this travel Dr. Wetmore had as assistant Rudolfo Hinds, technician from the Gorgas Memorial Laboratory, who made blood smears from all specimens taken, to be checked for incidence of tropical disease.

Bernard R. Feinstein, museum aide in the division of birds, completed in September 1961 the field work that he had begun in August 1960, under the auspices of the U.S. Army Medical Research and Development Command and the Bernice P. Bishop Museum. During the period of his operations, Mr. Feinstein obtained specimens of 1,070 mammals and 1,300 birds, in addition to a number of reptiles. The vertebrate collections include much topotypical material. Areas visited included regions in Viet Nam and Cambodia.

After attending the Tenth Pacific Science Congress in Honolulu, Dr. Leonard P. Schultz, curator of fishes, spent a few days in September on the island of Hawaii, where he made ichthyological observations of the offshore waters. He was impressed by the paucity of reef fishes here in comparison with similar areas in the Pacific.

In May and June Dr. J. A. F. Garrick, research associate in the division of fishes, spent a week in the Bahamas at the invitation of the International Oceanographic Foundation examining sharks during a cooperative operation with the anglers in the Grand Bahama Bluefin Tuna Tournament. Several sharks were taken, including an adult of *Carcharhinus springeri*, which is of considerable interest because presently only juveniles of this species are available in museum collections. A complete set of measurements and vertebral counts were made on this and other specimens.

In September and October Dr. J. F. Gates Clarke, curator of insects, after attending the Tenth Pacific Science Congress in Honolulu, conducted entomological field work in the South Pacific. Although it proved impossible for Dr. Clarke to reach his principal objective, the island of Rapa, because of adverse weather conditions, he made collections of insects and other arthropods on the islands of Tahiti and Huahine. In the material thus acquired, there seem to be many species of Microlepidoptera which are new to the national collections and some of which are doubtless undescribed.

In August William D. Field, associate curator of insects, spent 2 weeks in the Great Smoky Mountains National Park primarily to obtain specimens of the genus *Rhopalocera*. Forty species of butterflies were collected, of which several were unusual and rare, including *Speyeria diana* and *Lerodea neamathla*. At the close of the fiscal year Mr. Field was engaged in field work in Maine, collecting specimens of *Rhopalocera* for the Museum and conferring with several local collectors with regard to future contributions to the Smithsonian's entomological materials.

Dr. Oliver S. Flint, Jr., associate curator of insects, made a successful collecting trip to Puerto Rico in August. As a result, the Museum collections now possess the immature stages of all species of caddisflies known to occur on the island. In addition, the lengths of the adult series were increased and several species previously unknown were collected. The trichopteran material, which contains at least 2 new genera and over 12 new species, will be studied and reported upon. A considerable collection of Odonata, both adults and naiads, was made.

At the end of the fiscal year, Dr. Donald F. Squires, associate curator of marine invertebrates, and Thomas G. Baker, of the office of exhibits, were still engaged in field work in New Caledonia. The Smithsonian

party began its work on that island early in May, continuing the acquisition of specimens and data for a coral-reef group being planned for the new Hall of Oceanic Life. They were successful in obtaining an adequate supply and variety of corals to reconstruct a typical New Caledonian reef. Other representative elements of the fauna were also obtained and shipped back to the Museum.

For approximately 9 weeks between January and April, a Smithsonian Institution party conducted field work in the interior of British Guiana for the purpose of obtaining data, specimens, and models for the construction of a rain-forest life group in the proposed Hall of Plant Life. Dr. Richard S. Cowan, associate curator of phanerogams, served as leader of the expedition and technical adviser to the group, which consisted of Dr. Thomas R. Soderstrom, associate curator of grasses; Reginald J. Sayre, of the office of exhibits; and Paul Marchand, modelmaker. In addition to a large number of collections of plant materials, 2,500 color slides were made and 5,000 feet of 16-mm. film were exposed by Dr. Soderstrom. Mr. Marchand prepared numerous life-size models of different species of plants which can be duplicated as desired for use in the life group. Mr. Sayre made field sketches and paintings of many of the items that will be used in the exhibit, as well as a scale painting of Kaieteur Falls that will serve as a guide in preparing the background of the group. Numerous plant materials were preserved to serve as specimens from which to make additional models. In the time that was available from the exhibit functions of the trip, Dr. Cowan and Dr. Soderstrom obtained ample material of about 500 species of plants for scientific purposes.

In April and May Dr. Velva E. Rudd, associate curator of phanerogams, visited museums in Trinidad, Venezuela, and Panama, in continuation of her studies of *Ormosia* and other Leguminosae. She conducted field studies at certain interesting botanical localities, including Colonia Tovar, El Avila, and Parque Nacional Henri Pittier in Venezuela, as well as the Canal Zone Biological Area in Panama.

In April Dr. John J. Wurdack, associate curator of phanerogams, began extended botanical field work in Peru. After assembling his supplies and equipment in Lima he traveled to Chachapoyas in northern Peru, headquarters for the first part of the trip. At the end of the fiscal year Dr. Wurdack reported that his work was progressing satisfactorily and that he was amassing large collections for the Smithsonian's department of botany. One of his objectives is to re-collect some of the species very inadequately known through the pioneering collection of the British botanist Mathews nearly a century ago. Many species obtained at that time have not been rediscovered, primarily because travel in the mountains of northern Peru is difficult. Dr. Wurdack will particularly emphasize research collections of his own specialty, the family Melastomataceae.

In October and November Dr. Thomas R. Soderstrom, associate curator of grasses, made extensive collections of plants in the state of Michoacán, Mexico, in collaboration with Robert King, of Texas, who is spending a large part of this year at the Smithsonian Institution. Thorough collections of the flora were made in six diverse localities in Michoacán. Special emphasis was placed on study of the grasses, and the material obtained will be incorporated in a taxonomic revision of the grasses of Mexico, upon which Dr. Soderstrom is now embarking.

In August, prior to attending the Tenth Pacific Science Congress in Honolulu, Dr. William L. Stern, curator of woods, collected wood samples and herbarium material mostly in the mountain forests of Kauai, Hawaii. It was possible to visit the poorly collected Na Pali Kona coast of Kauai, where Dr. Stern and Dr. Sherwin Carlquist, of the Rancho Santa Ana Botanic Garden, gathered specimens of the monotypic lobeloid *Brighamia insignis*, as well as other rare plants. On his return trip, Dr. Stern visited colleagues in Oregon and Colorado and spent several days in the field making collections of wood samples and herbarium vouchers. In continuation of his study of the flora of the Florida Keys, Dr. Stern spent 2 weeks in December and January making collections of wood specimens and herbarium material at Key Largo, Big Pine Key, Grassy Key, and Crawl Key.

In June and July 1961 Dr. G. Arthur Cooper, head curator of geology, and Dr. Richard E. Grant, of the U.S. Geological Survey, continued their field studies in Texas and New Mexico. In the vicinity of Marathon, Tex., much of their time was devoted to examining the lower limestone of the Word formation, which proved to be a key bed in their studies, and collecting from it at about 20 localities. Subsequently the field party spent some days at Van Horn working in the Lower Permian Huaco formation, where they collected from the Capitan limestone and its equivalents, their objective being to obtain a good representation of this fauna to use in comparative studies with their Glass Mountains fossils. This field season essentially completed the coverage of the Glass Mountains area for collecting purposes by Dr. Cooper and Dr. Grant.

In October Edward P. Henderson, associate curator of mineralogy and petrology, went to the vicinity of Henagar, Ala., to prospect for a meteorite which had first been discovered in 1959. Although the main mass of this meteorite had been removed, Mr. Henderson, using a sensitive metal detector, prospected 5 acres of ground and located one sizable piece and several smaller fragments. A second trip took Mr. Henderson to Fort Worth, Tex., to investigate reports about a meteorite that fell there on September 9, 1961. With the aid of Oscar Monnig, field work was organized, and after many hours' search the party located a small piece of the meteorite, which is now on deposit in the national collections.

In April Dr. Richard S. Boardman, curator of invertebrate paleontology and paleobotany, spent several weeks collecting bryozoans from the Simpson group of lower Middle Ordovician age in the Arbuckle Mountains of Oklahoma. The fauna of this region is largely unstudied and has the advantage of starting with the earliest known bryozoans in this country and continuing through a long period of time. This sequence should reveal evolutionary details and the origins of several genera. The faunas are abundantly represented throughout and will support many detailed population studies.

Dr. Porter M. Kier, associate curator of invertebrate paleontology and paleobotany, accompanied by Dr. Druid Wilson, of the U.S. Geological Survey, over a period of several weeks in Florida in November and December, collected fossils from formations of probable Miocene and Pliocene age. The collecting was spectacular, providing a much larger fauna than anticipated. Over 2,000 specimens were found, representing approximately 25 species, most of which are new. The results of the study of these specimens should be most helpful in determining the age of the formations. Subsequently, Dr. Kier collected and studied living sea-urchins and sea-biscuits in the vicinity of Miami. Using aqualung equipment, he spent many hours on the sea floor observing the behavior of nine species of echinoids, anticipating that these studies will permit a better understanding of the ecology of the fossil forms that are his particular interest.

In February Dr. Kier and Dr. Erle G. Kauffman, associate curator of invertebrate paleontology and paleobotany, spent several weeks in Saudi Arabia collecting fossils under the sponsorship of the Arabian American Oil Co. With the aid of officials of this company, they made extensive collections in central Saudi Arabia, where three camps especially erected for the expedition gave access to fossiliferous Lower Cretaceous, Upper Cretaceous, and Jurassic areas. The operations were extremely successful, and the Smithsonian party obtained over a ton of well-preserved Mesozoic fossils, including approximately 8,000 brachiopods, 30,000 mollusks, 1,500 echinoids, and numerous corals and sponges, many of them new to science. The material collected from carefully measured stratigraphic sections will be invaluable to Middle East biostratigraphic work and an excellent source for evolutionary studies.

In June Dr. Kier, in company with Dr. Druid Wilson, worked for a few days in the Miocene formation near Cape Fear, N.C. The scientists were fortunate in collecting sufficient echinoids and mollusks to enable them to date these beds and in turn to date the Caloosahatchee formation.

In the summer of 1961 Dr. Kauffman conducted field work in Montana, Wyoming, Utah, Colorado, and New Mexico. He collected

large suites of fossil mollusks and worked out a refined biostratigraphic zonation of the Upper Cretaceous rocks in these areas. The ultimate purpose of the project is widespread regional correlation, based on mollusk zones, of Upper Cretaceous deposits throughout the Western Interior of North America, with special emphasis placed on the role of pelecypods as time-zonal indicators. The success of the summer field season far exceeded Dr. Kauffman's expectations. Collections superior to any previously made were obtained at numerous localities and include a wealth of new species and new faunas. Refined biostratigraphic zonation of key Upper Cretaceous sections was accomplished. Regional studies in central and eastern Colorado are now near completion, making possible future expansion to Kansas, New Mexico, western and northern Colorado, and Wyoming.

In April Dr. Richard Cifelli, associate curator of invertebrate paleontology and paleobotany, joined the oceanographic vessel *R. V. Chain* of the Woods Hole Oceanographic Institution. The vessel cruised to the Nova Scotia shelf at longitude 65° W., and then proceeded due south to St. Thomas. Stations were occupied at each degree of latitude and the Gulf Stream. Collections of Foraminifera from oblique, 200-meter plankton tows were made at each station. A total of 24 samples were collected, representing excellent coverage for the western Sargasso Sea and adjoining waters.

Between July and September Dr. C. Lewis Gazin, curator of vertebrate paleontology, accompanied by Franklin L. Pearce, chief of the laboratory of vertebrate paleontology, made an extended collecting trip through several Western States. Their first stop was at Littleton, Colo., where they joined the Smithsonian group carrying on a combined paleontological-archeological excavation in a quarry south of Littleton. In subsequent field work near Shoshoni, Wyo., they made collections at Paleocene, Lysite lower Eocene, Badwater upper Eocene, and Cameron Springs lower Oligocene localities in the Wind River Basin. Also in Wyoming near Kemmerer, their work had excellent results at a new locality for Paleocene mammals in the Evanston formation, as well as at the previously discovered locality in this formation near Fossil Butte. Continuing into Montana, the party spent a fruitful period at the well-known lower Oligocene locality at Pipestone Springs. At the conclusion of this field season, Dr. Gazin and Mr. Pearce returned to Littleton, Colo., to assist in the packing and shipping to Washington of some 4 tons of fossil materials, mostly mammoth, obtained by the party working on the Littleton project.

Between February and May Dr. Gazin conducted research in Guatemala, Nicaragua, Argentina, and Brazil. In Guatemala, at the request of and with the support of the Government of Guatemala,

he visited several localities where fossil vertebrate remains had been found. Undoubtedly the most significant of these was a rather extensive area, evidently of lake-deposited volcanic ash, in and around the town of Estanzuela, near Zacapa in eastern Guatemala. Remains of mastodon and giant sloth were observed in place. During his short stay in Nicaragua Dr. Gazin examined a locality on the banks of the Río Viejo, to the north of Lake Managua, where Pleistocene mammal remains were encountered. These included teeth of horse, bison, and mastodon, and a pair of toxodon jaws. While in South America, Dr. Gazin spent extended periods at Buenos Aires, La Plata, and Rio de Janeiro, pursuing his studies of early Tertiary mammals.

Dr. Nicholas Hotton III, associate curator of vertebrate paleontology, left in February 1961 for South Africa for a collecting season in the famous Permian Karroo beds. His work extended through July 1961 and proved to be extremely successful. Accompanied by J. W. Kitching, of the Bernard Price Institute for Paleontological Research, University of the Witwatersrand, he covered more than 4,000 miles in the Karroo area. Starting from Johannesburg, the party spent some weeks on the east flank of the Drakensberg Mountains, collecting fossils from the upper part of the Beaufort series. From there they went to the classic area of the uppermost Beaufort, around Burgersdorp and Lady Frere, where they completed another 2 weeks of successful collecting. Gradually they worked their way westward across the Karroo, a course that took them downward stratigraphically. The collection consists of nearly 200 specimens, which will be added to the material of the National Museum. Many of the specimens are of exhibit quality.

The greatest importance of the collection lies in its being representative of the Permo-Triassic synapsid fauna of Africa and in its high proportion of good anatomical specimens. It is believed that excellent coverage of the Beaufort series was achieved both horizontally and vertically. The collection of *Cynognathus* zone material is particularly complete, and there are a number of relatively rare upper *Lystrosaurus*-zone theriodonts. In addition, the genera *Lystrosaurus* and *Diademodon* are represented by several individuals from a variety of stratigraphic levels and geographic locations. Further progress in understanding taxonomic and ecological relationships of the Beaufort synapsids depends upon more accurate stratigraphic data than are currently available in the literature. However, it is expected that the data obtained by Dr. Hotton and Dr. A. S. Brink, scientific officer of the Bernard Price Institute, from various sources will be valuable in marking out approaches to an ultimate solution.

In September Dr. Hotton worked several days in the vicinity of Wichita Falls, Tex., examining collections of Permian amphibians

discovered by Dr. Sergius H. Mamay, of the U.S. Geological Survey. The material in this vicinity probably represents the last vestiges of a drying pond or river waterhole, in which the amphibians were trapped and preserved. It consists of about $2\frac{1}{2}$ tons of siltstone matrix containing perhaps 150 skulls and scattered posterianal remains; the bones range all the way from impressions to complete elements. Although preservation of some of the specimens leaves something to be desired, the collection as a whole is remarkable. For obtaining much of this valuable material and shipping it to the Smithsonian Institution, credit must go to Dr. Walter W. Dalquest, of Midwestern University. The fossil locality itself is in Haskell County, about 150 miles from Wichita Falls.

During the year staff members of the Museum of History and Technology and the Office of Exhibits made many short and a few extended field trips in order to examine collections of potential usefulness in developing the new exhibit halls of the Museum. During field work of this sort, the staff members carry out essential assignments of appraising the potential of objects to the research programs in history and technology, as well as their possible value to the exhibits program. While all such trips are of importance to the development of the Museum, only a few visits to institutions outside the United States are here discussed.

In August Dr. Wilcomb E. Washburn, curator of political history, visited numerous museums and historic buildings in and near Athens, Vienna, Paris, and Rome, to familiarize himself with the latest museum exhibition techniques and the extent of the collections in these areas. He was pleased to note that some of the institutions visited have inspired a renaissance of temporary craftsmanship in their regions.

In the summer of 1961 Miss Rodris C. Roth, associate curator of cultural history, visited many museums and historic houses in England, including some in Cambridge and Brighton, in addition to the better-known institutions in and near London. She studied collections specifically in relation to research projects and problems, and generally in relation to museum practices and attitudes.

In September and October Dr. Vladimir Clain-Stefanelli, curator of numismatics, and Mrs. Clain-Stefanelli, associate curator, visited numismatic collections housed in museums in Portugal, Spain, Italy, Austria, Germany, France, Sweden, and Denmark. They were much impressed by the excellence of many of these collections. The increase in interest in numismatics is noticeable all over the western world, as evidenced by the new exhibits observed in various stages of completion. The extensive series of numismatic exhibit halls in preparation in Madrid is a good example. These will provide the world's largest display of its kind and, together with the six planned exhibit

halls in the Catalan numismatic museum in Barcelona, will give Spain a leading position in this field so far as sheer exhibit area is concerned.

Donald E. Kloster, museum aide in the division of military history, visited several military museums in Oslo, Norway, and Copenhagen, Denmark, during July and August. He studied the display techniques, conservation measures and experiments, storage systems, and reference collections of each museum and obtained considerable information on experiments and practices in preservation, especially in the fields of leather, metal, and silk.

EXHIBITIONS

On June 28, 1962, the modernized hall of the cultures of the Pacific and Asia was formally opened in the presence of ambassadors and other official representatives of several Pacific and Southeast Asian countries. In this hall 50 special exhibit units depict aspects of past and present life in the Pacific Islands, Australia, New Zealand, and the great arc of southern Asia from the Philippines to Pakistan. The cultures represented range from the Stone Age to the highly advanced cultures of India, Pakistan, Malaya, and Indonesia. The peoples of Hawaii and New Zealand are portrayed as they existed when discovered by Europeans over a century ago. Included among the exhibits are a large stone head from Easter Island, a 6½-foot piece of stone money from Yap, royal feather capes from Hawaii, and recent gifts of material culture from India and Malaya. Life groups depicting living conditions of New Guinea pygmies, an Ifugao rice harvest in the Philippines, and domestic scenes among the Maori of New Zealand and the Samoans are installed in the hall.

Construction in the adjacent hall, which will contain additional Asian exhibits and also interpret the cultures of Africa, was nearing completion at the year's end.

At the close of the year two-thirds of the exhibits in the second of two halls of North American archeology had been designed and installation was proceeding in anticipation of a fall opening. This hall will display exhibits which will interpret archeological methods and objectives and the prehistoric cultures of the United States east of the Rocky Mountains.

Staff members of the department of anthropology collaborated with the division of cultural history in the selection of musical instruments from the Congo, Polynesia, China, and Thailand for an exhibit assembled for the Eighth Congress of the International Musicological Society which met in Washington. A selection of weapons and armor from the John Oliver La Gorce collection was displayed from November 1961 to March 1962. In December 1961 and January 1962 the division of ethnology offered a special exhibition, of 80 newly cleaned

and restored oil paintings of American Indians by the artist George Catlin, which was installed in the foyer of the Natural History Building.

By the year's end the major construction of the hall of fossil reptiles was completed and several wall displays were partially or completely installed by the staff of the division of vertebrate paleontology. This hall will interpret the biological relationships among the reptiles through time and the various ways in which they met environmental demands. J. H. Matternes completed the large mural depicting an early Miocene assemblage of terrestrial mammals.

Many new and outstanding gems, including a 300-carat blue star sapphire from Burma, were added to the gem exhibit. On November 9, 1961, the 245.35-carat Jubilee diamond, the third largest in existence, was received on loan from its owner, Paul-Louis Weiller, and placed on exhibition for approximately 8 months.

Curatorial activity in the development of the hall of oceanic life, including field collecting of specimens for exhibition, the specification of models, and the writing of detailed exhibits scripts, was coordinated by Dr. Fenner A. Chace, Jr., curator of marine invertebrates. Detailed specifications for models of marine invertebrates were prepared during the year for the guidance of highly skilled modelmakers.

Construction of the new hall of cold-blooded vertebrates began early in May 1962. Displayed in this hall when completed will be representative types of fishes, amphibians, and reptiles, and exhibits interpreting their life activities, anatomical adaptations, breeding behavior, distribution, and developmental history.

Planning of the exhibits for the new hall of osteology was advanced during the year. Skeletons of mammals, birds, fishes, reptiles, and amphibians have been carefully selected to illustrate relationships, variations, specializations, and adaptations. General topics, such as the nature of bones and the interrelationships of skeletal parts, also will be presented in this hall.

The temporary exhibit of mollusks in the west hall of the second floor was removed to provide space for construction activities in the adjacent exhibit hall.

Curatorial efforts in the department of science and technology were directed toward the acquisition of specimens, the specification of models to be built, and the writing of exhibits scripts. Exhibits for five halls to be installed in the new Museum of History and Technology Building were in production during the year. Twelve new exhibits on health education and the history of medicine, pharmacy, and dentistry were installed in the gallery of medical sciences in the Arts and Industries Building. They illustrate child health, the use of X-rays in medicine, hearing aids and surgery of the ear, inhalers,

masks and machines used in anesthesia, the development of electrocardiographs, early pharmaceutical mortars and pestles, and dental drilling.

A fine collection of original machine tools was obtained and a dozen models illustrating the development of tools for mass production were completed. One of the exhibits in the hall of tools will be a reproduction of a 13th-century stained-glass panel from the Cathedral of Chartres depicting a wood turner at work.

A special case was built to exhibit a reproduction of the DeDondi clock, the earliest known mechanical clock about which details have survived. This will be one of the featured exhibits in the hall of light machinery. Construction of a series of enlarged escapement models illustrating significant clock and watch mechanisms was in progress. Designs and specifications for a full-size operating tower clock, to be installed in the horology section of the light machinery hall, have been developed.

For the hall of civil engineering eight scale models illustrating the historic development of soft-ground and hard-rock tunneling in Europe and America were completed. In the refrigeration section of the hall of heavy machinery, a number of demonstrations of the principally employed refrigeration cycles will be featured with examples of refrigeration machinery. Exhibits interpreting early physical science were completed, and additional units in both classical and applied physics were prepared.

In December 1961, the 92-foot, 280-ton Pacific-type locomotive "1401," a gift of the Southern Railway System, was the first exhibit to be installed in the new Museum of History and Technology Building.

Three vehicles which will be exhibited in the hall of automobiles and coaches in the new museum were restored. The Lawrence coach, a gift of Mrs. Richard Saltonstall, was placed on display in the Arts and Industries Building in May 1962. The Winton Bullet and Haynes automobiles were restored and returned to exhibition in the hall.

During the year an Edison incandescent lamp collection, previously in storage, and a color television set, presented by the General Electric Research Laboratory, were placed on exhibition in the Arts and Industries Building.

A change in the mechanism of the automatic quilt case was necessitated by unexpectedly heavy use by visitors. The dial electronic system of operation was replaced by a much simpler direct mechanical means of selecting quilts. Temporary exhibits of large color photographs lent by the U.S. Soil Conservation Service were continued in the farm machinery hall.

The *Kelmscott Chaucer*, a beautiful and important book printed by

William Morris, was placed on permanent display in May 1962. Housed in a specially designed case, this book is a gift of Senator Clinton P. Anderson, a Regent of the Smithsonian Institution.

The appointment by the American Petroleum Institute of a special subcommittee to assist in the location of historical material and to develop appropriate exhibits has provided a valuable means of communication with the production side of the petroleum industry. A large number of typical machines have been acquired for the hall of general manufacturing.

The division of political history installed small temporary exhibits dealing with the political campaigns of 1840 and 1896, and an exhibition of commemorative objects associated with the three assassinated presidents. The Women's Rights exhibition is being developed gradually to reflect more completely and with greater accuracy the development of this movement in the United States during the 19th and 20th centuries.

An exceptional collection of marked 17th- and 18th-century American pewter lent by Dr. Joseph H. Kler, and a New York repoussé silver 2-handled bowl, made in the early 18th century by Benjamin Wynkoop for Nicholas and Hiletje Roosevelt and lent by Mrs. Jack R. Hovey, were placed on exhibition in the present hall of everyday life in early America in the Natural History Building.

A special exhibition of rare and seldom shown musical instruments was assembled from the museum collections on the occasion of the Eighth Congress of the International Musicological Society in September 1961. On view through October, this attractive display of instruments associated with the traditional music of Europe and America, as well as instruments from Asia, Africa, and Oceania, proved of interest to the public as well as to students of music.

The cooperation of the British Crown Agents enabled the Museum to prepare a special exhibition featuring new stamps issued by Seychelles, Fiji, Tanganyika, Swaziland, and the Postal Centenary issue for the West Indies. Also displayed were original drawings and design subjects for these stamps, items seldom seen outside the British Isles.

In the numismatics hall a specially designed semiautomatic case which can display an average of 800 coins was installed on an experimental basis. It contains 40 trays, each measuring 2.5" x 44", suspended between continuous chain devices. The visitor may select for viewing any tray in which he may be interested.

Highlight of the completely restored series of World War I naval vessels was a strikingly camouflaged model of the cruiser *St. Louis*. Prominent among new Civil War models were the Union gunboat *Carondelet*, the Confederate ironclad *Fredericksburg*, and the Con-

federate submarine *H. L. Hunley*. A full-scale replica of the Curtiss A-1, first aircraft purchased by the United States Navy, was placed on exhibition with the cooperation of the National Air Museum.

A special exhibition of marine paintings and ship portraits by John W. Schmidt was shown in the rotunda of the Arts and Industries Building during December 1961 and January 1962. The division of naval history also cooperated with the Naval Historical Foundation in providing half models and other memorabilia for exhibits, on naval aviation and naval aspects of the Civil War, held in the Truxton Decatur Museum. During the annual meeting of the Company of Military Collectors and Historians, a special display of rare naval uniforms and flags of the Civil War period was exhibited.

Under the chairmanship of museum director Albert C. Smith, the committee coordinating and supervising the modernization of natural-history exhibits reviewed the planning of six additional halls in earlier stages of development.

Assistant director John C. Ewers continued to coordinate the activities of the curators and the exhibits staff engaged in planning and preparing exhibits for the Museum of History and Technology. During the year exhibits units were prepared which will be installed in 16 halls of the new building. Although some of these exhibits were placed on temporary display in the Arts and Industries Building, others were placed in storage until the museum is completed.

Exhibits chief John E. Anglim provided over-all supervision to the exhibits staff engaged in the design, production, and installation of permanent exhibits in the U.S. National Museum, and directly supervised the exhibits laboratory in the Museum of Natural History. Benjamin W. Lawless continued to supervise the design and preparation of exhibits for the Museum of History and Technology, assisted by Robert Widder in design, Bela S. Bory in production, and Robert Klinger in the model shop. Julius Tretick assisted in supervising the production and installation of exhibits in the Natural History Building. Joseph G. Weiner, with the assistance of Constance Minkin and Edna Wright, continued the editing of the curators' drafts of exhibits scripts and labels.

The design of the renovated halls in the Natural History Building was aided greatly by Richard S. Johnson, design branch chief, and John E. Morrissey, architectural branch chief, of the architectural and structural division of the Public Buildings Service, General Services Administration, and by Luther H. Flouton and Pasquale Batteselli, design architects of that agency.

DOCENT SERVICE

The Junior League of Washington continued its volunteer docent program, conducting school classes from the greater Washington area

through the Smithsonian museums. The program was carried out through the cooperation of curator G. Carroll Lindsay, Smithsonian Museum Service, with Mrs. E. Tillman Stirling, chairman of the League's docent committee, and Mrs. Vernon Knight, cochairman. Mrs. Knight will serve as chairman for the forthcoming year, with Mrs. Dickson R. Loos as cochairman.

During the 1961-62 school year 20,880 children were conducted on 720 tours, representing a 24-percent increase over the previous year's participation.

Tours were conducted in the halls of everyday life in early America, Indians of the Americas, and textiles, for grades 3 through 6, and in the halls of gems and minerals and power machinery, for grade 5 through junior high school. Four tours each day, 5 days a week, were offered every half hour from 10 through 11:30 a.m. in the halls of everyday life in early America and in Indians of the Americas. Tours in the hall of gems and minerals were conducted on Monday through Friday at 10 and 11 a.m. To meet the increasing demand for docent service in this hall, tours were occasionally offered at noon and at 1 p.m., in addition to the tours offered in the morning. Two tours daily during school days were offered in the power machinery and textile halls.

Tours were conducted from October 16, 1961, through May 25, 1962, with the exception of the month of April 1962, when tours were suspended because of the exceedingly heavy visitor traffic in all museum halls during the Easter and cherry-blossom seasons. The great number of visitors to the Smithsonian museums during the early spring so overcrowd the exhibition halls that the usual group tours cannot be satisfactorily conducted.

In addition to Mrs. Stirling and Mrs. Knight, the members of the League's docent committee were: Mrs. George Armstrong, Mrs. A. Stuart Baldwin, Miss Janet W. Barfield, Mrs. Thad H. Brown, Jr., Mrs. Thomas R. Cate, Mrs. Thomas K. Clarke, Mrs. Dean B. Cowie, Mrs. William Dixon, Mrs. Rockwood Foster, Mrs. Clark Gearhart, Mrs. George Gerber, Mrs. Robert H. Harwood, Mrs. Everett Hutchinson, Mrs. Charles J. Kelly, Jr., Mrs. J. H. Lasley, Mrs. Ralph W. Lee III, Mrs. Dickson R. Loos, Mrs. John Manfuso, Jr., Mrs. Ernest May, Mrs. William McClure, Mrs. Robert McCormick, Mrs. Arnold B. McKinnon, Mrs. Peter Macdonald, Mrs. Joseph Metcalf, Mrs. William Minshall, Jr., Mrs. L. Edgar Prina, Mrs. Robert E. Rogers, Mrs. W. James Sears, Mrs. Walter Slowinski, Mrs. Joseph Smith, Jr., Mrs. James H. Stallings, Jr., Mrs. David Toll, Mrs. John S. Voorhees, Mrs. Richard Wallis, and Mrs. Marc A. White.

The Institution deeply appreciates the able and devoted efforts of these volunteers, whose services to the schools of the Washington-area

encourage effective use of Smithsonian museum exhibits by teacher and student alike.

BUILDINGS AND EQUIPMENT

At the close of the fiscal year the contract for construction of the west wing and completion of renovation of the existing Natural History Building of the Smithsonian Institution had not been awarded. The west wing when completed will provide laboratories and workrooms as well as more adequate storage space for collections of the entire department of botany and the divisions of fishes, reptiles and amphibians, marine invertebrates, and insects. On June 26, 1962, construction of the east wing, which was started on January 3, 1961, was about 85 percent complete.

During the year construction of the building for the Museum of History and Technology reached the stage where it was deemed advisable to place two of the largest museum objects in the exhibition galleries. The large steam locomotive and tender presented by the Southern Railway System was placed on the rails in the first-floor transportation hall, and the original Revolutionary War gunboat *Philadelphia* was hoisted through a window to its display place in a third-floor military history hall. The Public Buildings Service, General Services Administration, advises that limited areas in the building should be available for occupancy commencing in October 1962, and that substantial occupancy of the entire building is estimated to be possible in March 1963. At the end of the fiscal year the construction of the building had reached 81 percent of completion.

CHANGES IN ORGANIZATION AND STAFF

In the department of zoology, Dr. Horton H. Hobbs, Jr., accepted appointment as head curator on February 1, 1962. Dr. Donald R. Davis, specialist in microlepidopteran moths, was appointed associate curator September 14, 1961, in the division of insects. A vacancy in the division of mollusks was filled October 2, 1961, by the appointment of Dr. Joseph Rosewater as associate curator. Dr. Donald F. Squires, a stony-coral specialist, entered on duty as associate curator in the division of marine invertebrates on December 18, 1961. Dr. Philip S. Humphrey was appointed curator of birds on June 1, 1962. Dr. William H. Crocker was appointed associate curator in ethnology February 12, 1962, to provide coverage of South American aboriginal material culture.

Included among the additions to the staff of the Museum of History and Technology were the appointments of Dr. Lester Clark Lewis as curator of physical sciences on February 19, 1962, and Dr. Walter F. Cannon as associate curator on February 5, 1962. In the division of

mechanical and civil engineering Silvio A. Bedini accepted an appointment of curator in charge of the section of tools on November 27, 1961. Joseph Rudmann entered on duty October 30, 1961, as assistant curator in the head curator's office, department of science and technology. Miss Doris Ann Esch entered on duty June 13, 1961, as assistant curator, and Miss Ellen Joy Finnegan as junior curator August 7, 1961, in the head curator's office, department of civil history. Keith E. Melder was appointed assistant curator of political history on September 5, 1961. In the department of armed forces history, Dr. Melvin H. Jackson entered on duty as assistant curator September 14, 1961.

Herbert G. Deignan, curator of birds, resigned January 31, 1962, after 24 years of service in the U.S. National Museum. Mr. Deignan intends to reside in Geneva, Switzerland, but plans to engage in Madagascar field ornithological studies as a member of a Museum expedition.

Dr. Frederick M. Bayer, associate curator of soft corals, division of marine invertebrates, for the past 14 years, resigned December 15, 1961, to accept the position of research associate professor, Institute of Marine Science, University of Miami, Florida.

Robert R. Ireland, Jr., assistant curator of cryptogams, resigned on December 12, 1961, to continue with graduate studies after 4 years' service in the department of botany.

On January 31, 1962, Emery C. Leonard retired as associate curator of phanerogams after 44 years' service in the department of botany. Mr. Leonard's employment by the Institution began on January 2, 1918.

Dr. Ray S. Bassler, research associate in geology since his retirement, died at Washington, D.C., on October 3, 1961. Dr. Bassler retired as head curator of the department of geology on July 31, 1948, after 47 years' service. Dr. David C. Graham, a collaborator in biology since October 19, 1931, died at Englewood, Colo., on September 15, 1961. Dr. Graham served as a missionary in Szechwan and other parts of China for many years and during this service forwarded important natural-history collections to the U.S. National Museum. A. Brazier Howell, a collaborator in mammalogy since December 11, 1926, and formerly a member of the staff of the department of anatomy of Johns Hopkins University, died at Bangor, Maine, on December 23, 1961. Dr. Roland W. Brown, a collaborator in paleobotany since December 27, 1956, died at Lehigh, Pa., on December 12, 1961.

Respectfully submitted.

REMINGTON KELLOGG, *Director.*

DR. LEONARD CARMICHAEL,
Secretary, Smithsonian Institution.

Report on the Bureau of American Ethnology

SIR: I have the honor to submit the following report on the field researches, office work, and other operations of the Bureau of American Ethnology during the fiscal year ended June 30, 1962, conducted in accordance with the act of Congress of April 10, 1928, as amended August 22, 1949, which directs the Bureau "to continue independently or in cooperation anthropological researches among the American Indians and the natives of lands under the jurisdiction or protection of the United States and the excavation and preservation of archeologic remains."

SYSTEMATIC RESEARCHES

Dr. Frank H. H. Roberts, Jr., director, devoted a portion of his time to office duties and the general supervision of the Bureau and the River Basin Surveys. In mid-July in company with Dr. Robert L. Stephenson, chief of the Missouri Basin Project of the River Basin Surveys, and Dr. John M. Corbett, archeologist for the National Park Service, he made an inspection trip to the River Basin Surveys excavating parties in the Missouri Basin and visited several local institutions which were conducting excavations in cooperation with the Inter-Agency Archeological Salvage Program. He then proceeded to the Agate Basin Site in eastern Wyoming where a joint Smithsonian Institution-National Geographic Society party under his general direction was digging in a site attributable to one of the early hunting groups in the Plains area. Dr. Roberts remained at the site until the work was terminated early in August. The immediate field work was under the direction of Dr. William M. Bass. During the course of the investigations numerous cut and split animal bones with evidence both for a kill and for a camping area were found. Associated with them were a variety of stone and bone implements. Most of the animal bones have been identified as representing bison of an extinct species, *Bison antiquus*. A few of the bones undoubtedly represent one of the Cervidae, but they are not diagnostic of species. Also, there were a few jack-rabbit bones. The artifacts in addition to projectile points include various forms of scrapers, flake knives, spoke shaves, flakes with graver's points, and a few bone tools. This assemblage of implements represents a definite contribution because it makes

possible the establishment of an Agate Basin Complex. At two places in the excavated area, objects found at a lower level indicated that Folsom Man had at least visited the area prior to the occupation by the makers of the Agate Basin type complex. One carbon-14 date obtained for the Agate Basin level indicates that the occupation was at about $9,350 \pm 400$ years before the present, and charcoal from the Folsom level has given a date of $10,375 \pm 700$ years before the present. This suggests that the basin was occupied at least at intervals over a period of about 1,000 years.

After returning to Washington from Wyoming, Dr. Roberts went to São Paulo, Brazil, where he represented the Smithsonian Institution and the United States at a conference on the origin and antiquity of man in the New World. He made three speeches at the conference and was elected one of the two vice presidents for the session. In September he went to Mesa Verde National Park in southwestern Colorado where he served as a member of the advisory group for the Wetherill Mesa Project. In November he participated in the 19th Plains Conference for Archeology at Lawton, Okla., and read a paper on the 1961 excavations at the Agate Basin Site. Later he went to Macon, Ga., as a member of an advisory group for a series of studies to be carried on at Ocmulgee National Monument. Early in June he visited the offices of the Missouri Basin Project of the River Basin Survey at Lincoln, Nebr., and assisted in sending out a number of field parties for work in Kansas, South Dakota, Wyoming, and Montana.

Dr. Henry B. Collins, anthropologist, continued his Eskimo studies and other Arctic activities. The Russian translation program—*Anthropology of the North: Translations from Russian Sources*—which he organized in 1960 continued its operation with the support of a second year's grant from the National Science Foundation. The second volume of translations, *Studies in Siberian Ethnogenesis*, edited by Henry N. Michael, was published by the University of Toronto Press for the Arctic Institute of North America in April 1962. This 313-page volume contains 17 articles by Soviet ethnologists, anthropologists, historians, and linguists on the origin and relationships of the Yakut, Tungus, Buryat, Kirgiz, the Amur tribes, and Samoyed and other ethnic groups of Siberia. Work is proceeding on the translation and editing of additional volumes and papers on Siberian archeology, ethnology, and physical anthropology selected by the Arctic Institute's advisory committee, of which Dr. Collins is chairman.

Dr. Collins' article on Eskimo art appeared in volume 5 of the *Encyclopaedia of World Art*. It traces the development of Eskimo art from prehistoric to modern times and describes and illustrates the

various regional art styles, ancient and modern, in Alaska, Canada, and Greenland. He also prepared an article on the relationships of the earliest Eskimo cultures to recently discovered pre-Eskimo cultures in the western Arctic for a volume on early man in the western Arctic to be published by the University of Alaska.

Dr. Collins continued to serve as a member of the Board of Governors of the Arctic Institute of North America and as a member of its publications committee responsible for the quarterly journal *Arctic* and the two other Arctic Institute series, *Technical Papers* and *Special Publications*. He also continued to serve as chairman of the directing committee which plans and supervises preparation of the *Arctic Bibliography*, a comprehensive reference work which abstracts and indexes the contents of publications in all fields of science, and in all languages, relating to the Arctic and sub-Arctic regions of the world. This Arctic Institute project, for which Dr. Collins has been primarily responsible since its inception in 1947, is being supported by grants and allotments from the Department of Defense, National Institutes of Health, Atomic Energy Commission, and Defense Research Board of Canada. The Library of Congress provides office space, and most of the work of compilation and editing is done there under the direction of Miss Marie Tremaine. In addition to the unsurpassed collections of the Library of Congress, those of the Smithsonian Library and 80 other large libraries in the United States and Canada, as well as of polar research institutes in England, France, and Norway, are being utilized in the preparation of the bibliography. Volume 10 was issued by the Government Printing Office in December 1961, and volume 11 is ready for the printer. Volume 10 (1,520 pages) abstracts and indexes the contents of 6,570 scientific publications on Arctic and sub-Arctic areas and on low temperature conditions; added to the abstracts appearing in the previous nine volumes, this makes a total of 62,848 such publications abstracted to date. In volume 10, for the first time, Russian language material exceeds that in English, reflecting expanded research activities of Soviet scientists in their Arctic territories; the volume contains abstracts, all in English, of 3,075 Russian publications, of 2,503 publications in English, 513 Scandinavian, 212 German, and 267 in other languages. Subjects that have received special emphasis in this volume are geology, geophysics, mineral resources, meteorology, fisheries, oceanography, transportation, construction, economic and social conditions, anthropology and acculturation of Eskimos and native Siberian peoples, acclimatization, military and public health, diseases, and the environmental effects of darkness, humidity, light, and low temperature on animals, man, and plants.

Dr. William C. Sturtevant, ethnologist, continued his research re-

lated to the ethnology of the Eastern North American Indians. Particularly he broadened his Iroquois research, previously concentrated on the Seneca of New York, to include the very poorly known Seneca-Cayuga of northeastern Oklahoma. During August 1961 he spent 3 weeks doing field work among this group (including attendance at their major annual ceremony, the Green Corn Dance). In January and May he spent several days studying Oklahoma Seneca-Cayuga specimens in the Museum of the American Indian in New York, and in June visited the National Museum of Canada in Ottawa to study the large collection made among this group by Marius Barbeau in 1911 and 1912. These Iroquois are descended from a group which settled in Ohio in the 18th century, together with accretions received since then from New York and Canada. At present those who speak an Indian language speak Cayuga. Although there have been continuous intermittent contacts with other Iroquois, the culture of this group is the most deviant found in any Iroquois community, and its study promises to elucidate several aspects of general Iroquois culture—particularly some features of the various major ritual complexes. Conversations with informants during a brief return visit to the New York Seneca in October helped clarify some of these matters.

While in Oklahoma Dr. Sturtevant spent a day among the Delaware inquiring about the last years of their ceremonial structure, the Big House. Carved posts from this building were studied in museums in Oklahoma, New York, and Toronto during this and previous years, and some notes on the subject by F. G. Speck were located in the American Philosophical Society Library in Philadelphia. Dr. Sturtevant returned from Oklahoma via Mississippi and North Carolina, stopping about 3 days in each State to renew and expand his acquaintance with the Choctaw and Cherokee.

During September Dr. Sturtevant prepared a paper on "Spanish-Indian Relations in Southeastern North America," which he delivered at the annual meeting of the American Indian Ethnohistoric Conference in Providence in October. This later appeared in *Ethnohistory* (vol. 9, pp. 41-94, 1962). His paper on "Taino Agriculture" was published in *Antropológica Supplement Publication No. 2* (Caracas, 1961). In October Dr. Sturtevant attended an International Conference on Iroquois Research, at McMaster University, Hamilton, Ontario, where he presented an oral report on his Oklahoma field work. In November he attended the annual meetings of the American Anthropological Association in Philadelphia.

Dr. Wallace L. Chafe, linguist, spent July and August in Anadarko, Okla., collecting material for a description of the Caddo language. He recorded a considerable quantity of linguistic data on this language for which almost no information was previously available, and he

returned to Oklahoma in mid-June 1962 to continue this work. In August he spent a few days with Dr. Sturtevant at the Seneca-Cayuga Green Corn Dance and was able to locate a few speakers of Wyandot, a language that had been thought to be extinct.

Between September and May Dr. Chafe worked at the Bureau on a half-time basis, teaching courses on several linguistic subjects at Catholic and Georgetown Universities. At Georgetown he worked with a speaker of Winnebago and hopes eventually to prepare some descriptive material on that language. Through this study he was led to pursue further some facts suggestive of a remote relationship between the Siouan, Caddoan, and Iroquoian language families. During the fall he continued his survey of the present number of speakers of North American Indian languages, the results of which are being published in the *International Journal of American Linguistics*. He read papers at the International Conference on Iroquoian Studies at Hamilton, Ontario, in October, and at the Annual Meeting of the American Anthropological Association in Philadelphia in November. He was program chairman for the spring meeting of the American Ethnological Society in Washington in April and edited the papers read at the meeting for publication. During the late spring he spent several weeks continuing work on a Seneca dictionary.

Robert M. Laughlin, ethnologist specializing in the Middle American area, joined the staff of the Bureau on June 11, 1962. He spent the remaining days of the fiscal year in research on the Huastec of Veracruz and San Luis Potosí, Mexico, in preparation for an article for the Handbook of Middle American Indians, to be published by the Middle American Research Institute of Tulane University.

RIVER BASIN SURVEYS

During fiscal 1962 the River Basin Surveys unit continued its program for salvage archeology in areas to be flooded or otherwise destroyed by the construction of large dams. The work as in previous years was carried on in cooperation with the National Park Service and the Bureau of Reclamation of the Department of the Interior, the Corps of Engineers of the Department of the Army, and a number of State and local institutions. An increase in funds that became available late in the year made possible an expansion in the program. During 1961-62 the investigations were supported by a transfer of \$231,705 from the National Park Service and a grant of \$2,000 from the Appalachian Power Co. The funds from the National Park Service were for use in the Missouri Basin and along the Chattahoochee River, Alabama-Georgia. The grant from the Appalachian Power Co. was to provide for an archeological survey in the area along

the Roanoke River in southern Virginia where its Smith Mountain Project is underway. The funds from the National Park Service provided \$204,500 for the Missouri Basin and \$27,205 for the Chattahoochee Project. A carryover of \$7,734 in the Missouri Basin made the total for that area \$212,234. The grand total of funds available in 1961-62 for the River Basin Surveys was \$241,439.

Investigations in the field consisted of surveys and excavations. Most of the efforts were concentrated in the digging of sites, but surveys were made in three new reservoir basins and two watershed project areas. Also, at the end of the year a survey was underway in the Missouri River area in Montana, locally known as the Missouri Breaks, which is to be set aside as the Lewis and Clark National Wilderness Waterway. Two of the new reservoirs were in Virginia and one in Nebraska. One of the watershed projects was also in Nebraska and the other was in Iowa. At the beginning of the fiscal year three parties were in the field in the Missouri Basin. A fourth began operations in that area in August, and another party resumed investigations along the Chattahoochee River during the same period. At the end of April a party returned to the Chattahoochee area and started further excavations in the Walter F. George Reservoir Basin. In May two small parties were at work in Nebraska, one in South Dakota, and one in Iowa. In June 11 parties moved into the Missouri Basin; one of them was working in Kansas, seven were in South Dakota, one was in Wyoming, one was in Wyoming-Montana, and one in Montana. With the exception of the one in Alabama-Georgia, which terminated its activities on June 30, all these parties were continuing their investigations at the close of the fiscal year.

As of June 30, 1962, reservoir areas where archeological surveys and excavations had been made since the start of the salvage program totaled 258, located in 29 States. In addition, two lock projects, four canal areas, and two watershed areas had been examined. During the years since the program got underway, 4,979 sites have been located and recorded, and of that number 1,171 were recommended for excavation or limited testing. Because complete excavation is rarely possible, except in the case of a few small sites, the term "excavation" implies digging approximately 10 percent of a site. With the exception of those where the work was done during the past year, preliminary appraisal reports have been issued for most of the areas surveyed and, in cases where additional reconnaissance has resulted in the discovery of other sites, supplemental reports have been prepared. Where no archeological manifestations were noted or where they were too meager to be of import, no general report was issued. Manuscripts have been completed for two of the surveys made last year, and they probably will be issued sometime during the coming fiscal year.

By the end of the year, 547 sites in 54 reservoir basins and 1 watershed area had either been tested or dug sufficiently to provide good information about them. Thus far at least one example of each site recorded in the preliminary surveys has been examined. They cover the range from camping locations occupied by the early hunting and gathering peoples of about 10,000 years ago to village remains left by early historic Indians, as well as the remains of frontier Army and trading posts of European origin. Reports on the results of the investigations have appeared in various scientific journals, in the *Bulletins of the Bureau of American Ethnology*, and in the *Miscellaneous Collections of the Smithsonian Institution*. Bulletin 179, containing *River Basin Surveys Papers 21-24*, was distributed in December 1961. These papers consist of a series of reports on excavations conducted in Texas, Iowa, and the Columbia basin, Oregon-Washington. Bulletin 182, containing *River Basin Surveys Paper 25*, a report on the excavations carried on in the John H. Kerr Reservoir basin, Virginia-North Carolina, was in press at the end of the year and should be ready for distribution early in the coming year. *River Basin Surveys Papers 26-32*, comprising Bulletin 185, should be ready for distribution early in the coming year. The papers contain data on the results of investigations in the Tiber Reservoir basin, Montana, the Garrison and Jamestown Reservoir areas in North Dakota, and the Lovewell Reservoir area in Kansas. *River Basin Surveys Papers 33-38*, which will constitute Bulletin 189, have been turned over to the editors and will be sent to the printer early in the next fiscal year. The contents pertain to excavations in North Dakota, South Dakota, and Kansas.

Throughout the year the River Basin Surveys continued to receive helpful cooperation from the National Park Service, the Bureau of Reclamation, the Corps of Engineers, the Geological Survey, and various State and local institutions. The field personnel of all the cooperating agencies assisted the party leaders in many ways and the relationship was excellent in all areas. Transportation and guides were furnished in a number of instances, and mechanical equipment made available by the construction agency speeded the work at a number of locations. Detailed maps of the reservoirs under investigation were supplied by the agency concerned and helpful information was provided whenever it was needed. The National Park Service continued to serve as liaison between the various agencies, both in Washington and in the field. It also was responsible for the preparation of estimates and justifications for the funds needed to carry out the salvage program. Valuable assistance in numerous ways was provided by the commanding officer at Fort Benning in Georgia while studies were being made in that portion of the Walter F. George

Reservoir basin which is within the boundaries of the Fort Benning Reservation. Various local clubs and groups of citizens, both in Alabama and Georgia, the Georgia Historical Commission, and the University of Georgia assisted the leader of the River Basin Surveys party while he was working along the Chattahoochee River. In the Missouri Basin Project engineers and personnel from the Corps of Engineers were very helpful in carrying out activities in that area. Furthermore, the Corps of Engineers and the Missouri Basin Project of the River Basin Surveys cooperated in the preparation of small informative pamphlets telling about various reservoirs along the Missouri River. The pamphlets were published by the Corps of Engineers and are being distributed to visitors at various reservoir installations.

General direction and supervision of the program were continued by the main office in Washington. The field headquarters and laboratory at Lincoln, Nebr., was in direct charge of the work in the Missouri Basin. The activities along the Chattahoochee River and in southern Virginia were supervised by the Washington office.

Washington office.—The main headquarters of the River Basin Surveys in the Bureau of American Ethnology continued under the direction of Dr. Frank H. H. Roberts, Jr., throughout the year. Carl F. Miller and Harold A. Huscher, archeologists, were based at that office. Mr. Miller spent a major portion of the year in the Washington office working on materials and data he had collected during previous seasons in the field. He also corrected the final page proofs for his report on the investigations made at the James H. Kerr Reservoir on the Roanoke River in southern Virginia. He made a number of talks before schools and civic organizations in the metropolitan area of Washington and spoke before the Archeological Society of Delaware at Wilmington. In October he attended the sessions of the Eastern States Archeological Federation at Williamsburg, Va. He identified numerous artifacts from the southeastern archeological area for collectors who either sent them to the office or brought them in person and furnished information for replies to letters inquiring about archeological problems. On April 3 at Rocky Mount, Va., he began an archeological reconnaissance of the Smith Mountain Project of the Appalachian Power Co. He completed that assignment and returned to Washington on May 11. He then prepared a report on the results of his survey, recommending a series of excavations for the two reservoir areas included in the project. On June 11 he left Washington for Lincoln, Nebr., to take charge of one of the Missouri Basin field parties. His activities during the remainder of the fiscal year are covered in the Missouri Basin portion of this report.

At the beginning of the fiscal year Mr. Huscher was in the Washing-

ton office working on records and collections from the previous field season. Early in August he established headquarters at Eufaula, Ala., for a series of archeological studies in the Walter F. George Reservoir basin on the Chattahoochee River. Because of unfavorable weather conditions, he ended his field activities there at the end of December. In November he participated in the sessions of the Conference for Plains Archeology, at Lawton, Okla., and on December 1 and 2 in the Southeastern Archeological Conference held at Ocmulgee National Monument at Macon, Ga. After his return to Washington, Mr. Huscher devoted his time to the study of data and materials which he had collected during the previous months along the Chattahoochee River. At the end of May he again returned to the Walter F. George Reservoir area, Alabama-Georgia, and resumed his investigations of archeological sites to be flooded by the rising waters of the reservoir. He completed his field activities at the end of June.

Alabama-Georgia.—During the period from August 4 to December 30, a series of investigations was made in the Walter F. George Reservoir basin on the Chattahoochee River by a party under the direction of Harold A. Huscher. They spent the first 2 weeks of the field season checking a series of public-use areas laid out at regular intervals on both sides of the Chattahoochee River from Columbia, Ala., north to the Fort Benning area. Between the Fort Benning Reservation and Columbus, Ga., a series of harbor developments is contemplated, and a further check of sites was made at that location. The party found that the recreation-area program would involve four important sites on the Alabama side of the river and one on the Georgia side. Original plans had called for virtual destruction of the great Rood's Landing mound site on the Georgia side, but as a result of conferences with the representatives of the Corps of Engineers the roads contemplated were shifted so that they would completely miss the mounds and adjacent archeological manifestations. The new plans also provided for the development of the central plaza of the site as a grassed lawn area. This particular site is significant because it was an important ceremonial center which contained eight mounds.

Following the study of the public-use area the crew was enlarged and the remainder of the field season was devoted to an examination of 24 additional sites. Collections were made from 21 of them, 9 of which had not previously been listed. Actual excavations were made at eight sites, of which the two mounds south of Georgetown, Ga., were worked most extensively. In every place where digging was done, four or more squares were excavated. Each square is 10' x 10' in area and each was excavated in 6'' levels, the material from them being put through power screens. This made possible

much more progress than would have been the case had the usual hand methods been used throughout.

The mound sites were particularly important because they contained considerable new information pertaining to several cultural periods in the region. One of them, known as the Cool Branch Mound site, proved to be an unusually fine example of a large burial mound with accompanying village, surrounded by a palisade. The large mound was in the approximate center and the walls were constructed to conform to its orientation. The enclosure was rectilinear, measuring about 700 feet on the side, with 10-foot-square bastions or towers spaced about 115 feet apart. The data obtained indicate that this village conformed quite closely to those which occupied the Gordon sites in Tennessee, the New Madrid sites, Aztalan in Wisconsin, and even the Huff and Black Partizan sites in the middle Missouri Valley. Furthermore, the findings agree closely with the description of the town of Mauvila in Alabama which the Spaniards destroyed in 1540. The village may well have been occupied at the time of the first penetration of the Spaniards, but it apparently was abandoned and fell into ruin before the Indians had contact with the Europeans, because no materials of European manufacture were recovered during the course of the excavations. The other locations consisted in the main of former villages, and they yielded specimens representative of all the cultural periods from Early Archaic to Early Historic Creek. The data obtained from them will assist materially in developing the aboriginal history of that area.

In the last week in April Mr. Huscher resumed his activities in the Walter F. George area. During most of May he continued further excavations at the Cool Branch site, gathering data on the burial pit which lay beneath the main mound and further information about the palisade walls and general village features. Attention was then turned to an examination of nine sites, one of which had not previously been recorded. Actual excavations were conducted at six of the sites. In view of the limited time available, only three excavation squares were dug at most of them, although in one or two cases an additional square was opened. Two of the sites have particular significance. One of them on the Alabama side of the river in the Fort Benning area is presumed to be the location of the last town occupied by the Yuchi in that area. It has not definitely been identified as to name, but the information from it should help to throw considerable light on the length of time that tribe was living that far north along the Chattahoochee River after having been driven from their Tennessee and Savannah River locations. The second site is on the opposite side of the river in Georgia and may well represent an extension or continuation of the Yuchi village in Alabama.

Trade materials are present in the deposits at both locations. Those on the Georgia side, however, are much less numerous than those on the Alabama side and may indicate an earlier abandonment of that part of the village. There is close similarity between the specimens from both sites. The Georgia site actually may represent the location of one of the towns called Hlekatchka and also seems to be the most promising location for the original Captain Ellich's (Yuchi) town which was settled in the early 18th century. If it was Hlekatchka, the latter is reported to have been destroyed in 1814. Excavations on the site produced large quantities of debris indicating the burning of a house or houses, possibly the entire village, which supports the idea that it may have been that particular village. It is unfortunate that time and funds did not permit further and more extensive excavations on both sides of the river. The other sites which were tested during June contributed still more information pertaining to several aboriginal periods in the Chattahoochee Valley.

Missouri Basin.—For the sixteenth consecutive year the Missouri Basin Project continued to operate from the field headquarters and laboratory in Lincoln, Nebr. Dr. Robert L. Stephenson served as chief of the project throughout the year. Activities included surveys, excavations, analyses of materials, and reporting on results. During the summer months the work consisted mainly of excavations. Analyses and preparation of reports received the major attention throughout the rest of the year. The chronology program, begun in January 1958, was especially emphasized.

At the beginning of the fiscal year the permanent staff, in addition to the chief, consisted of three archeologists, one administrative assistant, one administrative clerk, one secretary, one scientific illustrator, one photographer, and four museum aides. On the temporary staff were two assistant archeologists, one cook, and 25 field crewmen. At the end of the year there were five archeologists in addition to the chief, one administrative assistant, one administrative clerk, one secretary, one clerk typist, one scientific illustrator, one photographer, and four museum aides on the permanent staff. The temporary staff included 4 archeologists, 5 field assistants, 3 cooks, and 83 field crewmen.

During the year there were 19 Smithsonian River Basin Surveys field parties at work in the Missouri Basin. Two of these were operating in the Oahe Reservoir area and two in the Big Bend Reservoir area of South Dakota during July and August. One small party investigated the Salt-Wahoo Watershed area in Nebraska in April; one party conducted surveys and excavations in the Pony Creek Watershed area in Iowa in May; a small party visited the Fort Sully Site in the Oahe Reservoir area in May; a survey of the

Arcadia Reservoir area in Nebraska was also made in May; during June one party was at work in the Tuttle Creek Reservoir area in Kansas, one in the Missouri Breaks area of Montana, two in the Yellowtail Reservoir area of Montana and Wyoming, four in the Oahe Reservoir area of South Dakota, and three in the Big Bend Reservoir area of South Dakota.

Other field work in the Missouri Basin included 12 parties from State institutions operating under agreements with the National Park Service and in cooperation with the Smithsonian Institution in the Inter-Agency Archeological Salvage Program.

Appropriated funds for this fiscal year were materially increased over the previous 2 years, thus permitting a substantial increase in the amount of salvage that could be accomplished. Most of this new activity came at the end of the fiscal year since the field season at the beginning was nearly completed before the new money became available. The field parties at work at the start of the year were conducting intensive excavations of key sites. Toward the end of the year, when the 1962 field season began, crews were engaged in intensive surveys of new areas, sampling of large numbers of sites in other areas, and carrying on intensive excavations at a series of key sites in several reservoir basins.

At the beginning of the year Robert W. Neuman, assisted by William G. Buckles, was directing a crew of 10 Indian laborers excavating a series of 8 prehistoric burial mounds near the Big Bend Dam in central South Dakota. Having begun work on June 7 of the previous fiscal year, this party continued in the field until September 8. Three low, dome-shaped, earthen mounds were excavated at the Sitting Crow site (39BF225).¹ The mounds, ranging from 2 feet in height and 50 feet in diameter to nearly twice that size, contained 10 intrusive historic interments representing at least 3 types of burials. These were primary burials in wooden coffins, primary burials in pits, and a secondary bundle burial. Some of the coffin burials were associated with grave posts and were scattered, singly, while others were associated with the pit burials within a circular enclosure of vertical posts. Glass, metal, wood, stone, leather, and fabric grave goods were recovered from this historic component. The burial mound complex proper was represented by single and multiple secondary burials. These remains were found scattered about on the mound floor or sometimes deposited in shallow, sub-

¹ Site designations used by the River Basin Surveys are trinomial in character, consisting of symbols for State, county, and site. The State is indicated by the first number, according to the numerical position of the State name in an alphabetical list of the United States; thus, for example, 32 indicates North Dakota, 39 indicates South Dakota. Counties are designated by a two-letter abbreviation; for example, ME for Mercer County, MN for Mountrall County, etc. The final number refers to the specific site within the indicated State and county.

mound pits. Artifact associations consist of small, triangular, side-notched points, end scrapers, marine and fresh-water shell beads, and a bipointed copper awl.

Four mounds were excavated at the Side Hill site (39BF223). The burial mound component there was essentially the same as at the Sitting Crow site, but in addition there was evidence of cremation in association with Truman Plain Rim pottery.

Only one mound was excavated at the Old Quarry site (39BF234). It was found to contain a portion of a wooden log, a bison skull, and concentrations of hematite on the mound floor. Two large, subfloor pits were located near the mound center and each contained secondary burials of seven to nine individuals. A single artifact, a large undiagnostic body sherd, was recovered from one pit. A bison skull also was found in the same pit.

While testing below the mounds at the Sitting Crow and Side Hill sites, two, and possibly three, stratified, lithic components were located. The deepest component was indicated by a zone of charcoal-stained soil containing stone chips. The intermediate component was in a light-colored soil zone and contained thin, triangular points with concave bases, end scrapers, knives, worked and unworked chips, bison bone fragments, and shallow basin-shaped firepits. The uppermost lithic component is typologically similar to the McKean complex represented at various sites in western South Dakota and eastern Wyoming.

During the last week of the field season, all the 46 mounds between Fort Thompson and Campbell Creek were mapped. They range from 25 to 80 feet in diameter and from 1 to 4 feet in height. The tumuli sometimes occur singly and in other instances are in groups.

The second Smithsonian Institution field party at work at the beginning of the year was directed by Dr. Warren W. Caldwell, assisted by Richard E. Jensen. With a crew of 11 men, they had begun work on June 13 of the preceding year and continued through August 22. The entire time was devoted to excavations at the Pretty Head site (39LM232). This site is situated on the right bank of the Missouri River in the lower portion of the Big Bend Reservoir area. Two houses were completely excavated, a third was excavated except for the heavy fill marking one corner, two midden areas were extensively tested, a defensive moat was sectioned in several places, and the old occupation surface between two houses was cleared.

The site is roughly a rectangular area of hillocks and depressions capping the riverward edge of Terrace 1, which stands about 60 feet above the summer stage of the Missouri River. A number of oval depressions were arranged in irregular rows paralleling the cutbank of the river. These proved to be the remains of houses, although



1. Smithsonian River Basin Surveys crew excavating two burial pits at the Old Quarry Mound, Big Bend Reservoir, South Dakota. These pits contained bones of both infants and adults.



2. Smithsonian River Basin Surveys crew skimming the floor of a long, rectangular house following drauline pass at the Pretty Head site, Big Bend Reservoir. The drauline was found very effective in moving large amounts of overburden.



1. Long, rectangular house excavated at the Pretty Head site. Crewman is sitting in the remnant of a ditch that extended the length of the house. The floor of the house, except where disturbed by the ditch, was covered with a deposit of red ocher. River Basin Surveys.



2. Aerial view of the Potts Village, Oahe Reservoir, South Dakota. The Missouri River is in the background. At maximum pool elevation the Oahe Reservoir will be about 15 feet above this site. The excavations outlined in the fortified area indicate the house structure within it. River Basin Surveys.

the orientation was not consistent and the village pattern was by no means as regular as had been anticipated. The village had only one extended occupation. It appears that the houses had been arranged in streets or blocks but subsequent growth was haphazard and unplanned. There is further support of this view in relation to the defensive features of the village. The entire occupation area is mantled by midden debris and wind-blown silts to such an extent that the moat was completely obscured. At least one late house (Feature 7) was built athwart the moat, which was already filled with refuse and could have had but little usefulness for defensive purposes. Feature 7 was smaller and less complex than the other houses.

Mantling all the houses were several soil zones, the earliest of which was particularly evident. It is tempting to equate this with a severe drought in the Central Plains during the last quarter of the 13th century. Drought conditions may well have been a disruptive factor that brought progressive changes and collapse to this village. The houses excavated (Features 2, 4, and 7) were uniformly of the long rectangular type but differed in details. All were deep, with floors excavated 2 to 3 feet below the old occupation surface, which in turn was 2 to 4 feet below the present surface. In each the floor had been painted with a red, mineral paint and in Feature 4 there were two such painted floors separated by 0.2 foot of sterile fill. The entrance to each house was a wide ramp from the old surface to the floor. In Feature 4, the ramp led across a wide platform and ended in a low step. On either side of the ramp was a narrow trench that continued across the front of the trench, separating it from the house proper. There was a similar trench in Feature 2.

A large number of bell-shaped cache pits were found beneath the floor of Feature 2, but not in the other houses. Features 2 and 4 contained much bison bone, particularly skulls, lying on the floor and within the mantling fill. They were notably absent from Feature 7, suggesting a change in cultural emphasis or perhaps in local ecology. In each house the firepit was located on the centerline just inside the inner end of the ramp. Superstructures of all three houses were nearly identical. Posts 2 or 3 feet apart were set at the base of the wall excavation and, except for the entrance, continued around the entire perimeter. Central posts were absent but were replaced by roof supports in two rows, each a short distance from the centerline.

A large area between Features 2 and 4 was cleared to the old surface and two thick midden deposits were trenched. The defensive moat was located and sectioned in six places, tracing it through Feature 7 and around a bastioned corner. Uniformly the moat was 3 to 5 feet deep with a maximum width of 10 feet. The accompanying stockade was not discernible. Artifacts were abundant in the midden

areas and the house fill. Pottery was mainly of the Foreman types, but there was also much Over Focus pottery. Probably the cultural position of the site is intermediate between the Monroe-Anderson Foci, where Foreman Ware is frequent, and the Over Focus. Nonceramic artifacts were not distinctive, but a fragment of copper and a long bone object resembling an arctic snow beater are notable. These two objects suggest trade with the north, and the architecture of the houses is remarkably similar to certain examples reported for the northern Plateau. It seems suggestive that the Early Village people of the Plains may have cultural ties not hitherto recognized.

The third Smithsonian field party at work at the beginning of the year was directed by Dr. Robert L. Stephenson, assisted by Lee G. Madison. With a crew of 10 men they had begun excavations on June 19 of the previous year and continued work through August 31. Most of the season was spent on excavations at the Potts Village site (39CO19) on the right bank of the Missouri River, just south of Mobridge, S. Dak., in the Oahe Reservoir area. All or parts of seven houses were excavated, the fortification ditch was tested in several places, middens and cache pits were sampled, the entire stockade was uncovered, and the single loop bastion and two bastioned entrances were completely excavated.

This is the site of an early La Roche village that probably dates from about the late 15th or early to middle 16th century. It is entirely precontact, and no items of White origin were found in any part of the excavations. The site consisted of the remains of about 30 circular earthlodges, grouped in a long, oval area along the edge of the second terrace above the Missouri River. Within the village 11 houses, including a large ceremonial lodge, were encircled by a deep, narrow fortification ditch and palisade. The ditch was 6 to 8 feet in depth and 10 to 20 feet wide. The palisade was composed of upright cedar, cottonwood, and oak posts set close together. A single large loop bastion protected the north and west sides of the fortified area and a steep bank protected the east and southeast sides (toward the river).

Architectural details of the entrances to these fortified villages along the Missouri River have not previously been determined. On the basis of some evidence, simple overlapping lines of stockade posts with a passageway between have been presumed. At the Potts site two examples of a very distinctive entrance were clearly defined. In this type of entrance the stockade line curved outward and then back in toward the center of the fortified area to form a small loop bastion about 10 feet in diameter, but with one side forming a straight line of posts extending some 10 to 15 feet into the village. Parallel to the straight line of posts was another similar line about 4 feet from it

that extended outward from the fortified area and curved around to form a small loop bastion about 8 feet in diameter and then recurve back to join the regular line of the palisade posts. Thus the entrance consisted of two small, loop bastions with a narrow passageway between them that ran some 10 feet back into the fortified area. Opposite the narrow passageway was a ramp across the fortification ditch. One entrance was to the north, the other to the south.

Outside the fortified area the two houses that were partially excavated appeared of the same structural type and artifact content as those that were within the fort. The architecture was of the four center post pattern with widely spaced wall posts, leaner posts, and short entrances, forming a circular earthlodge of some 28 to 45 feet in diameter. Artifacts from the site include abundant pottery, bone, stone, and shell objects. The pottery is unusually homogeneous and well within the earliest of the La Roche tradition. Elaborate or spectacular objects were almost entirely lacking, although a few shell ornaments and catlinite pipes were recovered.

One week was spent in August by this party in excavating a portion of the Blue Blanket Island site (39WW9), located on an island in the Missouri River just north of the Potts Village site. This was a late village of circular earthlodges encircled by a wide, shallow fortification ditch and palisade. The palisade formed a nearly circular pattern enclosing less than 20 houses with no evidence of houses outside it. The ditch was but 2 or 3 feet deep and 20 to 25 feet wide. Half of one house was excavated, the ditch and palisade were sampled in several places, and a dozen random test squares were dug.

Stockade posts as well as outer wall posts of the house were split timbers set close together with the bark side in. Burning caused good preservation of the structural features. Inside the row of split wall timbers of the house were large, whole support posts spaced every 6 or 7 feet to form main roof and wall supports. The four main center posts were large, whole posts. The entrance was short but unusually well made. Pottery and other artifacts were not abundant but metal objects were present. The village apparently is one of those viewed by Lewis and Clark as a recent ruin in 1804, and probably dates from the last quarter of the 18th century until about 1802 or 1803. Access to the site each day was by motorboat from the right bank of the river near the Potts Village site.

The fourth Smithsonian field party at work during the early part of the fiscal year consisted of a crew of four men directed by Dr. William M. Bass. They worked from August 7 to 18 and excavated 40 burials from the Sully site (39SL4), some 19 miles northwest of Pierre, S. Dak., on the left bank of the Missouri River. Dr. Bass spent two previous seasons on burial excavations at that site and has

recovered a total of 264 interments there. It was thought that the brief stay during the 1961 season would exhaust the burial area and give a good statistical sample of a single population. However, it became evident that more burials are to be found there and plans were made to continue the work in the 1962 season. The Sully site unquestionably offers a better opportunity than any other to obtain a really meaningful sample of the protohistoric Arikara physical types in the Missouri Basin. Numerous artifacts were recovered with the burials. They include catlinite pipes, wooden pipe stems, a whole pottery vessel, glass and copper beads, woven mats, and bone tools.

The 1962 field season began early this year with a brief survey of the area to be flooded by the several proposed small reservoirs in the Salt-Wahoo Drainage Basin in Lancaster and Seward Counties, southeastern Nebraska. Robert W. Neuman, assisted by Lionel A. Brown and John W. Garrett, the latter a member of the staff of the Nebraska State Historical Society, spent April 5 and 6 investigating the areas designated as Dams 4, 8, 13, and 17. This initial survey revealed nothing of archeological interest in proposed flood areas of these four reservoirs. Construction activities at these dams should be watched, however, when the time comes for building the dams, as buried sites of the Archaic and Woodland periods might then be discovered.

The second Missouri Basin Project field party for the new season began work in the Pony Creek Drainage area of Mills County, southwestern Iowa, on May 1. There the Soil Conservation Service is building a series of small reservoirs and terracing large areas as protection against erosion. Lionel A. Brown, assisted first by Wilfred M. Husted, and later by Lee G. Madison, made an intensive survey of the area in immediate danger of destruction, and then with a crew of 3 men tested 7 of the 16 sites located. They completed the season's work on May 25. One house was excavated in each of three sites, 13ML205, 13ML206, and 13ML216. Extensive tests were made in sites 13ML201, 13ML204, 13ML208, and 13ML215. This party recommended further investigations in all of the sites, 13ML201 through 13ML216 except 13ML201, 13ML213, 13ML214, and 13ML215, which will either be out of danger of damage from construction or have no promise of yielding useful archeological information. The houses excavated were square to rectangular in shape and provided artifacts suggestive of the Aksarben Aspect and related materials.

The third field party, consisting of G. Hubert Smith and Jerry L. Livingston, visited the historic site of Fort Sully (39SL45) in Sully County, north of Pierre, S. Dak., during the period of May 15-18 for the purpose of making a topographic map of the site, but heavy rains made this impossible.

The fourth party, Smith and Livingston, made a survey of the area to be flooded by the Arcadia Dam in Custer County, Nebr., on May 19 and 20. One site, 25CU202, was located within the reservoir area, but it appeared to be of little archeological value.

On June 12, the fifth and sixth Missouri Basin field parties left for the field. Party No. 5, directed by Robert W. Neuman and assisted by John J. Hoffman and a crew of 10, began work on the early circular house village known as the Mostad site (39DW234) and by the end of the year was well along on the excavation of the fortification system of that site. Party No. 6, also directed by Neuman but assisted by James J. Stanek and a crew of 10, began work on the 2 burial mounds at the Swift Bird site (39DW233). By the end of the year this party had cleared a large part of one mound and was excavating the burial chamber within it. Both sites are on the right bank of the Missouri River some 8 miles south of Mobridge, in Dewey County, S. Dak., and will be in the bank-slumping area of the Oahe Reservoir. The two parties were camped together in the area between the two sites.

The seventh and eighth Missouri Basin Project field parties left for the field on June 7. Party No. 7, directed by Dr. Warren W. Caldwell and assisted by Richard T. Jensen and a crew of 11, began work on the Langdeau site (39LM209) in the neck of the Big Bend in the Big Bend Reservoir just above Lower Brule, Lyman County, S. Dak. By the end of the year this crew was well along with the excavation of three houses of long-rectangular pattern. Party No. 8, also directed by Dr. Caldwell but assisted by Richard E. Carter and a crew of nine, began work on site 39LM2, overlooking Medicine Creek, near the neck of the Big Bend in the Big Bend Reservoir, some 8 miles above Lower Brule, Lyman County, S. Dak. By the end of the year this crew had completed the excavation of one circular house but was finding evidence of an earlier occupation of the long-rectangular house period. These two parties were camped together at the Crazy Bull School House near Lower Brule.

The ninth Missouri Basin Project field party, under the direction of G. Hubert Smith assisted by Lee G. Madison and a crew of eight, left for the field on June 12. Based in Pierre, S. Dak., this crew at the end of the fiscal year was making progress on the excavations at the historic site of Fort George (39ST202) some 15 miles downstream from Pierre in Stanley County, in the area to be flooded by the Big Bend Reservoir. Prehistoric occupations lie beneath the historic fur trading post at that site and both historic and prehistoric components were being excavated.

The tenth Missouri Basin Project field party, directed by Dr. William M. Bass and assisted by Jon Muller and a crew of six, left Lin-

coln on June 7. Also based in Pierre with the Smith party, this crew, with the aid of heavy equipment, by the end of the year had excavated approximately 89 burials from a new area at the Sully site (39SL4) some 23 miles upriver from Pierre in Sully County. The rising waters of the Oahe Reservoir were beginning to encroach upon the site at that time. So far over 350 burials have been recovered from this one protohistoric Arikara site.

The eleventh Missouri Basin Project field party, directed by Dr. Alfred W. Bowers, assisted by William B. Colvin and a crew of 10, left for the field on June 14. Based in Mobridge, S. Dak., this party began excavating at the two adjacent sites, 39CO14 and 39CO34, at the mouth of the Grand River in Carson County. These sites are in the bank-slumping area of the Oahe Reservoir and were substituted for others that had become unavailable for excavation owing to impoundment of Oahe Reservoir waters. By the end of the year tests in middens, excavations of lodges, and samples of the fortification system were progressing well.

The twelfth field party, not scheduled to begin work until early in the following fiscal year, was to go to the Big Bend Reservoir.

The thirteenth Missouri Basin field party, directed by Lionel A. Brown with a crew of five, left for the field on June 13, and after a tortuous trip by pack train down Black Canyon into the Big Horn Canyon made camp at the confluence of the two canyons. The group began excavation of site 24BH215, adjacent to the party camp, in the bottom of the Big Horn Canyon some 6 miles upstream from the location of the Yellowtail Dam, Big Horn County, Mont. The site proved to be a large camping area and a few projectile points and potsherds had been recovered by the end of the year.

Party No. 14 also left for the field on June 13. It consisted of Wilfred M. Husted with a crew of five. The party established camp near the upper end of the Horseshoe Bend of the Big Horn River in Big Horn County, Wyo., in the upper reaches of the Yellowtail Reservoir area. They tested one site and partially excavated another but the terrain proved to be so rough that work without a boat was impractical. At the end of the year the men were making intensive foot surveys of that end of the canyon. There were prospects of obtaining a boat so that excavations could be resumed early in the coming fiscal year.

Party No. 15 left for the field on June 13 with Oscar L. Mallory in charge of a crew of three. This group began an archeological survey along the Missouri River between Fort Benton, Mont., and the upper reaches of the Fort Peck Reservoir. This is known as the Missouri Breaks area. Beginning near Fort Benton, the party had surveyed some 20 miles of the area by the end of the fiscal year and had located 19 sites, mostly tipi sites and rock cairns.

The sixteenth Missouri Basin Project field party, directed by Carl F. Miller, with a crew of nine, left for the field on June 15 and established headquarters in the town of Blue Rapids, Kans. By the end of the year this party had examined three of the sites in the upper reaches of the Tuttle Creek Reservoir in Marshall County, northeastern Kansas, and had begun testing one of them (14MH70).

Cooperating institutions working in the Missouri River Basin at the beginning of the fiscal year included six field parties, representing five State agencies in Nebraska, Kansas, South Dakota, and Missouri. Dr. Preston Holder, with a crew of students from the University of Nebraska, completed work during July on the Leavenworth site (39CO9), 10 miles north of Mobridge, S. Dak., in the Oahe Reservoir area. Dr. Carl H. Chapman and a crew from the University of Missouri continued the survey and testing of sites in the Kaysinger Bluff Reservoir area on the Osage River in west-central Missouri during the period July to September. In addition, Chapman had a University of Missouri crew at work on the survey of the Stockton Reservoir in a branch of the Osage River in Cedar and Dade Counties, Mo. Thomas A. Witty with a group from the Kansas State Historical Society was excavating the Woods site (14CY30) and testing several other sites in the Milford Reservoir area on the Republican River in Geary County, Kans. Roger T. Grange and a crew from the Nebraska State Historical Society was at work in the Red Willow Reservoir basin in Frontier County, southwestern Nebraska. This reservoir is nearly completed and by the end of this field season will begin to fill. Dr. Preston Holder, assisted by Dr. Emily Blasingham and a crew of students from the University of Nebraska, was at work on excavation, testing, and survey of sites in the Norton Reservoir area of northwestern Kansas. Dr. Carlyle S. Smith, assisted by Walter Birkby and a crew of students from the University of Kansas, began work in June excavating two key sites and testing several others in the Melvern Reservoir area in Osage County, east-central Kansas. Dr. Carl H. Chapman and a crew from the University of Missouri were continuing the survey and testing of sites in the Kaysinger Bluff Reservoir area in west-central Missouri and, with a second crew, was at work sampling sites in the Stockton Reservoir area in Cedar and Dade Counties, Mo. All the cooperating institution parties mentioned above were operating under agreements with the National Park Service and cooperating with the Smithsonian Institution in the Inter-Agency Archeological Salvage Program.

During the time that the Missouri Basin Project archeologists were not in the field, they were engaged in analyses of their materials and in laboratory and library research. They also prepared manuscripts of technical reports and wrote articles and papers of a more popular nature.

The Missouri Basin Chronology Program by the end of the year had been in operation 3½ years, having been begun by archeologists of the Missouri Basin Project in January 1958. Cooperation and continued participation by most of the archeologists in the Plains area have been most encouraging. Especial emphasis last year was on the dendro-chronological section of the program, particularly the master chart for the Fort Thompson-to-Cheyenne River area. During the fiscal year many wood samples from prehistoric houses were matched to this chart and considerable effort was devoted to the refinement of the laboratory techniques of tree-ring study being used in the Lincoln office. To this end additional equipment was purchased, such as microscopes, a De Rouen Dendrochronograph, a power sander, and an increment borer. Also, consultations and advice were sought from the staff of the laboratory of tree-ring studies at the University of Arizona, and much assistance was obtained from these discussions.

The carbon-14 section of the Chronology Program received major attention throughout the year. Seven additional dates were obtained from charcoal samples submitted to the University of Michigan Memorial Phoenix Laboratory. In addition to this source of C-14 dates, an agreement was entered into between the Chronology Program and Isotopes Incorporated, of Westwood, N.J., under the direction of Milton Trautman, to date a series of charcoal specimens. The agreement with Isotopes Incorporated has resulted in 19 dates so far derived from the Missouri Basin Chronology Program.

The laboratory and office staff spent its full effort during the year in processing specimen materials for study, photographing and illustrating specimens, preparing specimen records, and typing, filing, and illustrating record and manuscript materials. The accomplishments of the laboratory and office staff are listed in tables 1 and 2.

Dr. Robert L. Stephenson, chief, when not in charge of field parties, devoted a large part of his time to management of the over-all Missouri Basin Project. His individual archeological research and report writing were minimal during the year, but he made some further progress on the monograph reporting the "Archeological Investigations in the Whitney Reservoir, Texas" and on the analyses of specimens from the Sully site (39SL4) in the Oahe Reservoir. Throughout the year he continued to serve as chairman of the Missouri Basin Chronology Program, as assistant editor of "Notes and News in the Plains Area" for *American Antiquity*, and as associate editor of the *Plains Anthropologist*. At the 19th Plains Conference for Archeology, held in Lawton, Okla., on Thanksgiving weekend, he served as chairman of the session on "Salvage Archeology in the Plains" and presented a paper on "Three Smithsonian Salvage Sites" and also one on "Historic Montana Burials."

Dr. Stephenson attended the meeting of the "Committee for the

Recovery of Archeological Remains" held in Washington, D.C., on February 8-9 and reported on the Missouri Basin Project activities of the past 2 years and the prospects for the coming year. He attended the annual meeting of the Nebraska Academy of Sciences in Lincoln on April 13. During the period April 15-22 he was in Austin, Tex., serving as technical adviser and making studio sequences for a motion picture on salvage archeology in the Plains area. From April 28 to May 8 he attended the Society for American Archeology annual meeting at Tucson, Ariz., where he presented a paper on "Administrative Problems of the River Basin Surveys." While in Tucson he conferred with the staff of the Laboratory of Tree-Ring Research and of the Geochronology Laboratory of the University of Arizona. During the year he wrote several book reviews for scientific journals and gave talks to various local civic organizations. Among the latter was the Omaha, Nebr., Kiwanis Club meeting to honor Dr. Ahmed Fakhry and the Tutankhamun exhibit at Joslyn Art Museum on May 9, and the meeting of the planning committee for the Heartland Exhibit at the New York World's Fair in 1964-65, held in Omaha on May 17. From June 17 to 24 he visited the field parties in Montana and at the end of the year was back in the Lincoln office.

Lionel A. Brown, archeologist, joined the staff on April 2 and spent the ensuing month in the Lincoln office learning field and laboratory procedures and preparing for the summer's field work. He was in the field from May 1 to 25 conducting surveys and excavations in the Pony Creek Drainage area of southwestern Iowa. On June 13 he again left for the field, where at the end of the year he was excavating in the Yellowtail Reservoir in Montana.

Dr. Warren W. Caldwell, archeologist, when not in charge of field parties, devoted most of his time to analyses of specimen materials he had recovered from salvage excavations in previous years. He completed two drafts of a monograph entitled "Archeological Investigations at the Black Partizan site (39LM218), Big Bend Reservoir, South Dakota," and that is now ready for final revision. He continued sporadic work on the revision of his manuscript "The Archeology of Wakemap," wrote several reviews for various scientific journals, and had the following three technical articles and one monograph published: "Archeological Excavations at the Coralville Reservoir, Iowa," published in Bureau of American Ethnology Bulletin 179, River Basin Surveys Paper No. 22, 1961; "Tree Ring Investigations in Central South Dakota," published in abstract in the Proceedings of the 72d Meeting of the Nebraska Academy of Sciences, 1962; "Tree Ring Dating and the Village Cultures of South Dakota," published in *Progress* of the Interior Missouri Basin Field Committee, 1962; and "The Missouri Basin Chronology Program, Statement No. 3," published by offset in the Missouri Basin Project office, 1962.

Throughout the year he served as collaborator for the Plains area on *Abstracts of New World Archeology* and prepared abstracts of 10 articles for that publication. In addition, he served as contributing editor for Plains literature and reviews for the *Plains Anthropologist*, and (on annual leave) as part-time assistant professor of anthropology at the University of Nebraska, as well as continuing his position as chairman of the dendrochronology section of the Missouri Basin Chronology Program. On April 14 he attended the annual meeting of the Nebraska Academy of Sciences where he presented a paper entitled "Tree Ring Investigations in Central South Dakota" and served as a panel discussant in a symposium on "Modern Research Methods in the Field of Ethnohistory." He attended the 27th annual meeting of the Society for American Archeology in Tucson, Ariz., on May 3-5, where he participated in a symposium on "Tree Ring Dating" and also conferred with the staff members of the Laboratory of Tree Ring Research and the Geochronology Laboratory at the University of Arizona. At the end of the year he was again engaged in excavating archeological sites in the Big Bend Reservoir area.

Wilfred M. Husted, archeologist, joined the staff on April 16 and spent the rest of that month in the Lincoln office learning field and laboratory procedures and preparing for the summer's field work. During May 1-11 he was in the field with Brown in the Pony Creek Drainage area in Iowa. On June 13, he again left for the field where, at the end of the year, he was excavating in Yellowtail Reservoir area in Wyoming.

Robert W. Neuman, archeologist, when not in the field conducting excavations, was at work analyzing archeological materials he had previously excavated in the Big Bend and Oahe Reservoir areas. He completed one monograph entitled "The Good Soldier Site, Lyman County, South Dakota," which will appear as River Basin Surveys Paper No. 37 in Bulletin 189 of the Bureau of American Ethnology. The major portion of his laboratory research time was devoted to an analysis of data and the development of a trait list for burial mounds in the Middle Missouri and northern Plains areas, the compilation of a report on preceramic horizons in the Fort Thompson vicinity, and an article on check-stamped pottery in the northern and central Plains. Throughout the year he served as chairman of the carbon-14 section of the Missouri Basin Chronology Program. Over the Thanksgiving weekend he attended the Plains Conference for Archeology at Lawton, Okla., where he presented a paper on "The 1961 Missouri Basin Project Field Season" and another on "Historic Indian Burials near Fort Thompson." On April 13 he attended the annual meeting of the Nebraska Academy of Sciences in Lincoln and presented a paper entitled "Check Stamped Pottery on the Central and Northern Plains," which was published in abstract in the proceedings of the meeting.

On May 4-5 he attended and participated in the annual meeting of the Central States Anthropological Society in St. Louis. At the end of the year he was again in the field conducting archeological excavations.

G. Hubert Smith, archeologist, was on duty at the first of the year in the Lincoln office continuing work on the comprehensive report of investigations at the site of Like-a-Fishhook Village and Fort Berthold I and II (32ML2), in the Garrison Reservoir, North Dakota. He devoted most of his efforts during the year to this report and had completed most of a first draft of it by the end of the year. During the period July 21-29 he accompanied the chief on a trip to Montana and Wyoming, particularly to consult with Bureau of Reclamation officials in regard to the salvage and preservation of Fort C. F. Smith at the mouth of the Big Horn Canyon in Montana, near the construction area of the Yellowtail Dam. He attended the 19th Plains Conference for Archeology at Lawton, Okla., on Thanksgiving weekend and served as chairman of a session on "Historic Sites Archeology and Ethnography." On April 13 he attended the annual meeting of the Nebraska Academy of Sciences in Lincoln and participated in a symposium on "Research Methods in Ethnohistory." On May 5 he attended and participated in the annual meeting of the National Trust for Historic Preservation held in Omaha, Nebr. Throughout the year he served as chairman of the historic documentation section of the Missouri Basin Chronology Program and as a member of the editorial board of the *Plains Anthropologist*.

During the period of May 15-20 he was in the field visiting the Fort Sully site in the Oahe Reservoir area of central South Dakota and making an archeological survey of the Arcadia Reservoir area in central Nebraska. On June 12 he returned to the field where he was again conducting excavations in the Big Bend Reservoir area at the end of the year.

TABLE 1.—Specimens processed, July 1, 1961-June 30, 1962

Reservoir	Number of sites	Catalog numbers assigned	Number of specimens processed
Arcadia.....	1	5	29
Big Bend.....	9	2, 435	64, 892
Fort Randall.....	1	5	8
Lewis and Clark.....	1	4	20
Oahe.....	9	1, 971	17, 457
Sites not in a reservoir area.....	5	325	1, 274
Total.....	26	4, 745	83, 680

As of June 30, 1962, the Missouri Basin Project had cataloged 1,339,396 specimens from 2,152 numbered sites and 59 collections not assigned site numbers.

Specimens restored: 5 pottery vessel sections.

Specimens donated to the Missouri Basin Project for comparative use:

Thirty-one pot rim sherds representing Fort Rice and Huff wares—State Historical Society of North Dakota, courtesy of W. Raymond Wood.

Thirty-one trade beads—University of Texas, courtesy of Edward B. Jelks.

Three United States Army buttons dating 1850–70—courtesy of S. J. Olsen, Florida Geological Survey.

TABLE 2.—*Record material processed, July 1, 1961–June 20, 1962*

MISSOURI BASIN PROJECT

Reflex copies of records.....	3, 809
Photographic negatives made.....	1, 135
Photographic prints made.....	3, 392
Photographic prints mounted and filed.....	1, 673
Transparencies mounted in glass.....	564
Kodachrome pictures taken in lab.....	156
Cartographic tracings and drawings.....	55
Illustrations.....	29
Lettering of plates.....	10
Profiles drawn.....	33
Plate layouts made for manuscripts.....	10

Virginia.—An archeological reconnaissance was made during the period from April 3 to May 11 at the Smith Mountain Project on the Roanoke River in southern Virginia. That is an Appalachian Power Co. undertaking and consists of the construction of two dams—Smith Mountain and Leesville—which will provide water for power purposes. The two reservoirs they will form will be located in Bedford, Franklin, and Pittsylvania Counties, Va. The survey was made by Carl F. Miller. His work was greatly facilitated by complete cooperation on the part of personnel of the Appalachian Power Co. and the Nello L. Teer Construction Co. The power company provided a helicopter which made possible a study of the reservoir areas from the air and also the taking of aerial photographs of the more important sites.

Mr. Miller located and recorded 35 sites in the Smith Mountain basin and 17 sites in the Leesville basin. Of the total of 52, only 1 will not be endangered by the inundation of the 2 areas. However, after careful examination of the surfaces and the testing of some sites, Mr. Miller concluded that only four of them merited excavation and detailed study. Three are in the Smith Mountain basin, while the fourth is in the Leesville basin. The sites cover the Early, Middle, and Late Woodland periods, involving a timespan beginning about 3000 B.C. and lasting to about A.D. 1000. They are significant be-

cause of the fact that they occur upstream from the James H. Kerr Reservoir where extensive archeological studies were made several years ago and, while related to the manifestations present there, they appear to contain some cultural elements which were not found farther downstream. Excavations will be made at Smith Mountain during the next fiscal year.

ARCHIVES

The Bureau archives continued under the custody of Mrs. Margaret C. Blaker, archivist.

Following the death of Dr. John P. Harrington, extensive series of his linguistic and ethnographic notes relating to numerous North American Indian tribes were returned from private storage and deposited with the Bureau through the courtesy of his daughter, Miss Awona W. Harrington. This material is voluminous and has become disarranged during years of storage. To serve as a preliminary guide, a list of the manuscripts, with particular attention to those dealing with Indian languages of California, was prepared by Miss Catherine Callaghan, scientific linguist.

A collection of letters, family records, and photographs from the estate of Matilda Coxe Stevenson, relating mainly to Mrs. Stevenson, although some pertained to her husband, Col. James Stevenson, was received as a gift from Manning Gasch of McLean, Va.

Two copybooks containing Micmac ideograms and an interlinear transcription of the Micmac words written about 1943 by Frank Navin, an Indian of Cape Breton, Nova Scotia, were lent by the Rev. Father Placide, O.F.M., Cap., Ristigouche, Quebec, to be microfilmed for the Bureau archives.

A collection of over 4,000 photographic prints relating to North American Indian tribes was transferred from the U.S. National Museum. The prints have been sorted and arranged by cultural area and tribe, but much remains to be done in tracing the original accession data in order to determine actual or terminal dates and other relevant background information.

Forty-two photographs relating to several Hopi pueblos, taken by Miss Margaret Brainard in 1929-31, 1938, and 1950, were donated by her.

Thirty-six color transparencies of North Carolina and Oklahoma Cherokee, taken by Raymond Fogelson in 1960, were donated by him.

Thirty-three photographs of persons of Indian descent living in Virginia, Maryland, Delaware, Maine, and Quebec, taken by Daniel Kennedy in 1960 and 1961, were donated by him.

Sixteen photographs of Chippewa Indians taken in 1905 at Grand Marais and Grand Portage, Minn., by Frances Densmore before she became affiliated with the Bureau were donated by Eliot Davis,

superintendent of Grand Portage National Monument, Grand Marais, Minn.

Seven photographs of western Indians were lent for copying by Vernon M. Riley of Chino, Calif.

As in previous years the manuscript and photographic collections were consulted by numerous scholars and members of the general public. There were approximately 175 written and personal inquiries about manuscripts, including requests for microfilm copies, and approximately 600 inquiries about and requests for photographic prints. Over 2,450 photographs were prepared and distributed, an increase over last year's figure.

ILLUSTRATIONS

The illustrator devoted most of his time to preparing and completing a variety of tasks in the fields of archeology, anthropology, and ethnology. Work was also prepared for the River Basin Surveys and for several other branches of the Institution.

LIBRARY

A reference librarian was appointed for the Bureau of American Ethnology Library in May 1962, to provide library services for the staffs of the Bureau and other branches of the Smithsonian Institution, and other qualified scholars. Rearrangement of the library's collection has already been completed, and it is planned to organize and maintain the collection so that it will realize its potential usefulness.

In the process of shifting materials, various interesting publications have attracted attention, among them what seems to be the original *Circular in Reference to Degrees of Relationship Among Different Nations* by Lewis Henry Morgan and a good collection of congressional reports pertaining to Indian affairs beginning with the 12th Congress. Several early editions of encyclopedias, dictionaries, and gazetteers have been gathered together and made more accessible for the patrons.

The valuable reprint collection has been organized and an author index made with assistance of summer student employees.

Special emphasis will be placed on the strengthening of this library's collection by filling gaps in important serial runs, reactivating and following up on exchange materials, and the acquisition of important works, both retrospective and current.

EDITORIAL WORK AND PUBLICATIONS

The editorial work of the Bureau continued during the year under the immediate direction of Mrs. Eloise B. Edelen. The following publications were issued:

Seventy-eighth Annual Report of the Bureau of American Ethnology, 1960-61. ii+33 pp., 2 pls. 1962.

Bulletin 175. Mohave ethnopsychiatry and suicide: The psychiatric knowledge and the psychic disturbances of an Indian tribe, by George Devereux. vi+586 pp., 10 pls. 1961.

Bulletin 179. River Basin Surveys Papers, Nos. 21-24, Frank H. H. Roberts, Jr., editor. xviii+337 pp., 56 pls., 43 figs. 1961.

No. 21. Excavations at Texarkana Reservoir, Sulphur River, Texas, by Edward B. Jelks.

No. 22. Archeological investigations at the Coralville Reservoir, Iowa, by Warren W. Caldwell.

No. 23. The McNary Reservoir: A study in Plateau archeology, by Joel L. Shiner.

No. 24. The Sheep Island site and the Mid-Columbia Valley, by Douglas Osborne, Alan Bryan, and Robert H. Crabtree.

Bulletin 183. Seneca Thanksgiving rituals, by Wallace L. Chafe. iii+302 pp. 1961.

Publications distributed totaled 19,326, as compared with 29,845 for the fiscal year 1961.

COLLECTIONS

The following collections were made by staff members of the River Basin Surveys of the Bureau of American Ethnology and transferred to the permanent collections of the Department of Anthropology, U.S. National Museum:

Acc. Nos.

236771, 238626, 238627----- 11,560 miscellaneous stone, bone, and shell archeological specimens from various localities in the United States.

MISCELLANEOUS

Dr. M. W. Stirling, Dr. A. J. Waring, and Sister Inez Hilger continued as research associates. Dr. John P. Harrington, linguist on the staff of the Bureau from February 20, 1915, until his retirement on April 30, 1954, and later research associate, died on October 21, 1961, in San Diego, Calif., after many months' illness.

Dr. Wallace L. Chafe worked part time during the academic year 1961-62 so that he could teach linguistics in the graduate school at Catholic University of America.

Robert M. Laughlin reported for duty on June 10 as ethnologist specializing in the Middle American area.

The Bureau revised and reissued during the fiscal year the following bibliographies and lists:

SIL-47, rev., 8/61: Selected bibliography on the Battle of the Little Big Horn. 5 pp.

SIL-99, rev., 3/62: Bibliography on American Indian medicine and health. Compiled by William C. Sturtevant. 39 pp.

SIL-65, 3d rev., 3/62: Introductory bibliography on the American Indian. 7 pp.

- SIL-53, rev., 4/62: Photographic collections of the Bureau of American Ethnology. 2 pp.
- SIL-90, rev., 4/62: Some dealers in second-hand anthropological and government publications. 2 pp.
- SIL-50, 4th rev., 6/62: Selected list of portraits of prominent Indians in the collections of the Bureau of American Ethnology. 3 pp.
- SIL-81, rev., 6/62: Selected bibliography on stone-chipping methods. 4 pp.

Although the 3,227 letters received in the director's office during the year indicate a decrease from the previous year, the total is well above the average for the past several years. This number, of course, does not include semiofficial letters received by staff members from colleagues and interested individuals. Because the Bureau does not maintain a mailing list for its bibliography series, many college and university librarians write in for complete sets and for information leaflets. About 8,000 informational items were mailed from the main Bureau office in response to requests for such material. The above totals do not include Bureau material and publications sent out by the Editorial and Publications Division. Many lots of specimens were received by mail or brought to the office for identification and for such information as could be provided by Bureau specialists.

Respectfully submitted.

FRANK H. H. ROBERTS, Jr., *Director.*

Dr. LEONARD CARMICHAEL,
Secretary, Smithsonian Institution.

Report on the Astrophysical Observatory

SIR: I have the honor to submit the following report on the operations of the Smithsonian Astrophysical Observatory for the fiscal year ended June 30, 1962:

The Astrophysical Observatory includes two divisions: the division of astrophysical research in Cambridge, Mass., for the study of solar and other types of energy impinging on the earth; and the division of radiation and organisms in Washington, for the investigation of radiation as it relates directly or indirectly to biological problems. Shops are maintained in Washington for work in metals, woods, and optical electronics, and to prepare special equipment for both divisions; and a shop conducted in cooperation with the Harvard College Observatory in Cambridge provides high-precision mechanical work. The field station at Table Mountain, Calif., was discontinued. Twelve satellite-tracking stations are in operation, in Florida, Hawaii, and New Mexico in the United States and abroad in Argentina, Australia, Curaçao, India, Iran, Japan, Peru, South Africa, and Spain.

DIVISION OF ASTROPHYSICAL RESEARCH

The Observatory research staff made significant contributions to knowledge of solar astrophysics, meteors, meteorites, artificial satellites, geophysics, and space science. The continuing refinement of observational techniques and the development of new analytical methods provided valuable data and opened up new areas of astrophysical investigation.

The Observatory continued, with mutual benefit, its close liaison with Harvard College Observatory, the Massachusetts Institute of Technology, Boston University, and other research centers.

Solar astrophysics.—Dr. Leo Goldberg, with Dr. William Liller, is directing the design and construction of the ultraviolet scanning spectrometer for flight in the S-17 satellite within the framework of the program of Orbiting Solar Observatories of the National Aeronautics and Space Administration. The spectral range of the spectrometer will be 500 Å. to 1,500 Å. and the resolving power will be about 1.0 Å. Calibration and testing of the instrument packages will be carried out in a new laboratory of the Space Science Building.

The scanning spectrometers are scheduled for rocket flights at the end of 1962 and for flight aboard the S-17 satellite during the first quarter of 1963.

The work of the laboratory also includes a broad program of basic research on the vacuum ultraviolet radiation of atoms and molecules of astrophysical importance with 1- and 3-meter vacuum spectrographs and a shock tube and flash tube as sources.

Trying to account for the effect of solar-radiation pressure on the drag of the Explorer IX satellite, Dr. Luigi G. Jacchia, assisted by Jack Slowey, found that the computed variations of orbital eccentricity for that satellite are 3 percent too small when the old value of the solar constant, $1.94 \text{ ly. min}^{-1}$, is used; the discrepancy disappears when use is made of the new value, $2.00 \text{ ly. min}^{-1}$, proposed in 1960 by F. S. Johnson to account for the excess ultraviolet radiation. This experience suggests that artificial satellites, of appropriate construction and in appropriate orbits, could be used for a better determination of the solar constant, although there remain serious difficulties connected with the earth's albedo and with the reflectivity and the spin of the satellite.

Dr. Max Krook proceeds with his theoretical investigations into the further development and application of methods for determining the structure of nongray atmospheres. He is also applying, in a number of cases, methods developed in continuum theories in gas dynamics to problems of the flow of rarefied gases; examining various problems in the dynamics of ionized gases (e.g., the structure of shock fronts in the presence of magnetic fields); and studying the exact solution of one-dimensional problems in the kinetic theory of gases.

Dr. Charles A. Whitney has completed several projects related to his long-range studies of stellar atmospheres and stellar pulsation. He has devised a simple but powerful new computational method for the smoothing of spectrophotometric data, a central problem of observational astrophysics hitherto dependent on subjective procedures. His comparison of theoretical with observed duration of line-splitting in the spectrum of a pulsating variable (W Virginis) reveals excellent accord with previous observations. His investigation of the reaction of a stellar atmosphere to abrupt variations in heat flux from below has resulted in a formula that will aid in distinguishing between fluctuations from variable heating and those from sound waves propagating through the atmosphere. From his study of the structure of shock fronts in hydrogen he has found, with the aid of Angelo J. Skalafuris, that radiation produced by recombination behind the shock heats and ionizes the gas ahead of the shock, thus significantly altering the flow and temperature patterns.

With the assistance of Mr. Skalafuris and W. Kalkofen, Dr. Whitney has studied ionization relaxation with a one-level atom, an essential aspect of the general shock problem, and has drawn some significant conclusions on temperatures which, with other results, will bear importantly on the whole program in this area.

Studies on the structure of stellar atmospheres continues along several lines. Dr. Owen F. Gingerich, investigating radiative equilibrium, has introduced into his computer program new correctional procedures developed by Dr. Krook and Dr. Eugene Avrett and is preparing several manuscripts for publication. David W. Latham's work on convective equilibrium will provide a basis for the theoretical study of solar granulation, a subject to which Dr. Whitney's work on thermal relaxation (performed with Alan Krasberg) will contribute. Dr. Whitney is also carrying out tests to determine the magnitude of departures from local thermodynamic equilibrium in stellar atmospheres; is attempting to interpret the periodicity of small-scale motions in terms of cepheid-like pulsation; and has begun a new study of the structure of the lunar surface by means of optical, infrared, and radio data.

During this period Miss Sylvia Boyd and Barry Goldstein completed measurements of the profiles of 30 absorption lines in 25 spectra of pulsating variables. Robert B. Stefanik studied the time-dependence of hydrogen excitation in a varying electron gas to determine the type of atomic model necessary for obtaining realistic shock structures.

Dr. Paul W. Hodge and Dr. Frances W. Wright have been investigating the possible presence in the Large Magellanic Cloud of Population II Cepheids, at present not known to exist there. They have concentrated on the globular clusters as the most likely location, in the vicinity of which previously known and new variables have been studied for periods, brightness, and light-curve characteristics.

Dr. Richard McCrosky made further progress in his observations of Raman scattered Lyman α to determine the still unknown percentage of hydrogen molecules in interstellar space. He is using for this purpose the infrared sensitive detectors on the Harvard College Observatory 61-inch telescope.

Dr. Henri E. Mitler is making a theoretical and analytical study of the possibility of optical cosmic-ray detection, on the assumption that information obtained from the Cerenkov light pulse might lessen the need for the usual huge counter array. He has nearly completed his analysis of the probable amount of He^3 produced in planetesimals and its effect on concurrent element formation, the determination of which is crucial for testing the cosmogonic theory of Fowler, Greenstein, and Hoyle. Dr. Mitler is also investigating single-particle energy levels in nuclei for possible application of the Hartree-Fock theory (especially for predictability of low-lying excited states), in preference to Brueckner's t -matrix.

Dr. Thomas W. Noonan is attempting to formulate, and then solve, certain problems in cosmology and general relativity, especially in the field now being studied at the Harvard College Observatory under the direction of Dr. David Layzer.

Meteoritical studies.—Dr. E. L. Fireman, Dr. David Tilles, and J. De Felice continue their measurements of radioactive isotopes in recently fallen meteorite and satellite material. Dr. Fireman has established that the Ehole meteorite fell August 31, 1961. The quantities of helium-3, argon-37, and argon-39 present are similar to those found in the previously measured Bruderheim and Hamlet meteorites, an indication of a similar history of cosmic-ray bombardment. Almost completed are measurements of those isotopes in the separated stone and iron phases of the Harleton meteorite, to determine the sources of excess argon-37. Dr. Fireman and Mr. De Felice have measured helium-3 and argon-39 in the metallic phase of a stony (Bruderheim) meteorite. Results of their analysis of uranium, potassium, argon-40, and krypton-xenon in iron meteorites by neutron activation will be important in determining the age and early history of the meteorites.

The most important results from the study of radioactive isotopes in recovered satellites were the discoveries that solar flares contain 1 percent tritium and that Van Allen particles also contain 1 percent tritium. The program will continue to provide information on the intensity, energy spectra, and isotopic composition of the trapped hydrogen nuclei in the Van Allen belts, as well as on the flux of primary high-energy cosmic rays in the vicinity of the earth.

Dr. Ursula B. Marvin, while investigating accessory minerals in meteorites, discovered in an iron sample the presence of cristobalite, which appears to contradict metallurgical evidence requiring far higher pressures of atmospheres than this mineral can theoretically tolerate. In association with Professor C. Frondel she has also studied the meteoritic phosphate mineral merrillite, apparently having the structure of whitlockite. Analysis of both these minerals should provide useful information on the geochemical environment of the meteorites at the time of formation.

With Dr. Fireman and Dr. Tilles, she is attempting to separate 100 mg. mineral samples from stony meteorites to determine the areas of noble gas isotopes and trace elements. The study seeks light on the early history of the meteorites and the solar system. For such analysis and other isotopic measurements, Dr. Tilles continues work on the construction of a high sensitivity mass spectrometer, which, when completed, should augment present scanty knowledge of primordial and radiogenic noble gases in iron meteorites and help elucidate the age, cooling history, and formation of the irons. Dr. Tilles has initiated an additional investigation of hydrogen and tritium retention in the metal of meteorites as a means of studying their temperatures in space and to help explain the widely varying tritium content of the metal phase of stony and iron-nickel meteorites.

Dr. F. Behn Riggs is experimenting further with his design of an electron probe microanalyzer, which makes possible a point-by-point chemical analysis of polished surfaces of sectioned meteorites without destroying the material. Combined with other metallurgical techniques, it should throw light on the nature, history, and formation of meteorites. His analyses so far show the need for a spectrometer, now under construction, to scan X-ray wavelengths for the presence of elements interfering with best results.

Dr. John Wood has been studying the composition of chondrules to determine whether his hypothesis, that they are hardened droplets of liquid silicates which condensed from the vapor phase during the origin of the solar system, is compatible with current solar theories. Estimating temperatures and pressures in the models of Hoyle and Cameron, and comparing them with those at which liquid silicates and liquid metallic iron are stable, he concludes that conditions do obtain in these models under which the droplets might condense. If, as he has postulated, the chondrites should in fact prove to be original planetesimals from which both planets and chondrites accreted, research into the birth and history of the planets can be greatly advanced.

Important in this connection is Dr. Wood's almost completed analysis of the compositional variation of about 50 chondrules separated from the chondrite Bjurböle. For his quantitative arc spectrographic study he has used equipment available at the Cabot Spectrographic Laboratory at Massachusetts Institute of Technology. Dr. Wood has also extended his investigations to the chondrite Renazzo, probably a sample of quite primitive, unaltered planetary material, the detailed mineralogy of which should reveal the nature of processes operating during the origin of the planets. He is using the services of the Advanced Metals Corporation of Cambridge for his microchemical determinations. From his examination of the probable metamorphism of most chondrites, Dr. Wood is offering in a forthcoming paper a hypothesis to explain the mineral peculiarities of unmetamorphosed (e.g., Renazzo) chondrites.

Dr. Pedro E. Zadunaisky's study of the definitive orbit of Comet Halley 1910, to test current theories about forces perturbing the elliptic-orbit motion of a comet, has now achieved three written and tested computer programs. Interpretation and reporting of results will follow further development of these programs.

Dr. Richard E. McCrosky, in collaboration with the Harvard College Observatory, the United States Air Force, Lincoln Laboratory, and NASA, has progressed in his attempt to reproduce meteor phenomena by injecting into the upper atmosphere, at meteoric velocities, bodies of known and sufficient size. His results are of critical importance in calibrating the mass-luminosity and density scale of natural meteors in the optical range.

Dr. McCrosky's project of seeking recovery of meteorites as soon as possible after their fall, to provide data on the intensity of cosmic-ray intensity near the earth and throughout the orbit of the meteorite, is approaching actual implementation. In the first such large-scale use of automatic photography for the purpose, he will direct a network of 16 camera stations in the Midwest which will record meteors in flight and from analysis of the film indicate the probable site of meteoritic landing. To this site, from headquarters in Lincoln, Nebr., designated searchers will make their quick-recovery trips and forward the material for analysis. Field testing of the cameras has been carried out, and the first station is expected to begin photographing in November, with hopes that the entire program may be in operation by the summer of 1963. Results should greatly increase our present knowledge of the numbers, masses, and orbits of meteorites. Dr. McCrosky is being assisted by Messrs. Tougas, Munn, and Wargo.

Dr. Salah Hamid has found from his study of the selection effects on the orbital elements of short-period photographic meteors that a true distribution of the eccentricity and perihelion distance of the interplanetary particles corresponds to previous observations, and that any comparison between theoretical and observed distributions must consider separately meteors meeting the earth at the ascending node and those meeting it at the descending node. His examination of the age of short-period photographic meteors, though employing a different method, confirms the 10^4 -year estimate of the director and Dr. Luigi Jacchia.

From his study of the Quadrantids meteor stream, Dr. Hamid concludes that it originated from a comet captured by Jupiter 3,000 years ago and that its inclination, owing to perturbations of the planet, changed from 13° to 75° . Investigating the question of a possible common origin of this stream with the apparently unrelated δ -Aquarid stream, he found that both stem from the same comet, but that their differing approaches to Jupiter (and its perturbations) have markedly affected their different duration, perihelion distance, and present position. This study should be useful for investigation of other meteoritic problems, such as the rest of the Aquarid stream complex and the Toroidal groups.

Dr. R. Southworth's project of observing faint meteors for data basic to meteor studies has involved planning and supervising the computations of the trajectory and the previous orbit around the sun of meteors observed by the radar system of the Harvard Radio Meteor Project near Havana, Ill. His observations of fainter meteors than have been previously made by this method show excellent results in accuracy and homogeneity. He has progressed satisfactorily also in his study of the dynamical history of meteor streams, a problem

both important to the whole subject of meteors and probably helpful in the study of other objects and events in interplanetary space.

Robert E. Briggs completed his study of the space distribution of interplanetary dust particles. He found that the light scattered by the computed distribution is in good agreement with observed zodiacal light, particularly along the ecliptic, and that most of the particles must have diameters of the order of 1 micron and fairly rough surfaces of low reflectivity. He is now turning his attention to the velocity distribution of interplanetary dust particles. The results of this study should be valuable for current and future research on the nature of interplanetary space, and perhaps provide new estimates on the significance of particle collisions and breakup.

Dr. Paul W. Hodge and Dr. Frances Wright continue their study of the rate of accretion of meteoritic matter by the earth, especially that in the form of dust particles collected by jet aircraft at altitudes ranging from 30,000 to 90,000 feet. They plan to analyze material gathered at even greater heights on the X-15. In addition, they have examined dust from very old ice deeply embedded in the Greenland and Arctic icecaps.

The director's study of the erosion and puncturing of bodies in free space continues. The preliminary results obtained have been reported at three scientific meetings and two publications in press. In brief, he has found that space erosion increases from a few angstrom units per year for irons to 10 times this rate for stones and nearly a thousand times greater rate for fragile material from comets. The correlation of erosion rate with brittleness or compressive strength indicates cratering by impacts with dust particles in space. A mean space density of about 10^{-22} gm/cm³ is required, consistent with measures of scattered sunlight. Near the earth a higher rate appears to prevail, possibly from moon dust, as he has previously suggested. The most dangerous place with respect to meteoritic puncture is probably the moon's surface. The project has importance for fundamental research on the interplanetary medium and for space engineering problems.

Dr. Fred A. Franklin has completed his dynamical and photometric studies of the rings of Saturn. He has obtained for rings A and B the values of their optical and physical thicknesses, their masses, and the fraction of their volume occupied by particles. He now also has a value for the average radius of the individual particles and a measure of the roughness of their surfaces. The derived thicknesses of the rings are surprisingly small, measured in inches. The rings are found to be an enduring feature of the solar system.

Space studies.—Two major projects for Orbiting Astronomical Observatories have made satisfactory progress. The director and Dr.

Robert J. Davis, astrophysicist in charge, with other Observatory scientists, have concentrated on "Celescope," the series of telescopes intended for orbiting in artificial satellites above the earth's atmosphere. Equipped to provide television images in four colors of the entire celestial sphere, this vital new technique, when completed and in operation, will vastly extend astronomical observation to the far ultraviolet region of the spectrum and prepare the way for further detailed studies of objects and areas revealed by the surveys. Contracts have been completed for fabrication of two Aerobee-Hi rocket payloads carrying a prototype Celescope of simplified design to test critical electronic equipment and the brightness of stars in the ultraviolet. These stars, found in recent observations by NASA and others to be 10 times fainter than supposed, require more sensitive television camera tubes ("uvicons") and larger optics than were originally available for the experimental flight. Now that better uvicons are available, the rocket payloads will be rebuilt to accept them. Contract for the satellite payload has been awarded, and construction is proceeding.

In connection with this problem Dr. Om P. Rustgi has set up a laboratory for absolute calibration of uvicons, a matter of highest importance to the project for measuring stellar and interstellar radiation.

Rocket failures and the insufficiently sensitive tubes have delayed the program, but successful orbit is expected in 1964. The Celescope project is being conducted in cooperation with NASA's Orbiting Astronomical Observatories Program, which provides auxiliary equipment and support, but the scientific management of the experimental payload and analysis of the results remain the Smithsonian's responsibility. The long-range plan is for development of even more powerful telescopes and equipment.

Dr. G. Colombo, professor of theoretical mechanics at the University of Padua, Italy, during his 2-year stay at the Observatory has analyzed the stabilization of a satellite at the point of equilibrium between the earth's and the moon's gravitational forces and is exploring the feasibility of a high sensitivity device for detecting displacement which would significantly affect techniques of space navigation and communication. He has also completed an analysis of the motion of Explorer XI (1961 Gamma) around its center of mass and demonstrated qualitatively that variations of its angular momentum are explicable only by the interaction of the earth's magnetic field and the body of the satellite.

Dr. Colombo has recently initiated a study of numerical integration in the semirestricted three-body problem (including radiation pressure from a fourth body) to investigate the possible use of such pressure for transferring earth-around-moon orbits of satellites with large

A/m ratios to moon-around-earth orbits. Related research includes the effect of lunar orbital eccentricities on moon satellites with large semimajor axis, and the problem of the asteroidal belt and the law of distribution of apsidal lines. Results should contribute to information about dust particles emanating from the moon, orbits of moon satellites, and space navigation and communication.

G. H. Conant, Jr., began an analysis of techniques of numerical integration of orbits to determine the nature of error "buildup" as a function of time, and possibly to devise new methods for minimizing this factor. The program has special pertinence to satellite and lunar-probe research.

Dr. Mario D. Grossi studied the effect of the ionosphere, the Van Allen belts, and the earth's magnetic field on radio-astronomical observations in MF and HF bands. Using the Hamiltonian ray-tracing for his analysis, he has written a program for computation on IBM-7090. He has demonstrated the existence of a continuous series of focal regions produced by the earth's ionosphere and has applied his results with some success to the problem of Jovian decameter radio bursts.

Imre G. Izsak, seeking increased accuracy of geodetic data derived from satellite observations, devised a modification of differential orbit improvement using residuals of observations along the orbit and in the normal direction to it with different, empirically determined weights. He constructed a precise theory of the critical inclination for more adequate knowledge of satellite motion. He also developed a computer program to make satellite orbits with very small eccentricities useful for the determination of odd zonal harmonics. Using precisely reduced Baker-Nunn satellite observation, he finds coefficients with 0.5 percent standard error, which is the highest accuracy achieved yet. For his continuing research into the tesseral harmonics of the geopotential, he is developing a computer program more satisfactory than that provided by an earlier method. In collaboration with Dr. Michael P. Barnett of Massachusetts Institute of Technology, he is also working on the application of computers to the analytical development of the planetary disturbing function in the restricted problem of three bodies.

Dr. Luigi G. Jacchia has concluded a significant portion of his study of atmospheric drag on artificial satellites, at present the only reliable source of information on atmospheric densities above 200 km. His analysis confirms the theory of the semiannual effect of interaction between the solar wind and the upper atmosphere, its amplitude varying with the 11-year solar cycle; reveals the influence of geomagnetic perturbations on the temperature of the upper atmosphere; provides correlations between atmospheric temperatures and the solar

flux at diametric wavelength, as well as the position of the sun with respect to the zenith; and makes possible prediction of atmospheric temperatures and densities as a function of solar-activity parameters. In continuing this program, which has already made such important contributions, he will concentrate especially on atmospheric structure. Jack Slowey has been closely associated with Dr. Jacchia in these investigations.

Dr. Yoshihide Kozai, on the basis of recently determined data from artificial satellites and other celestial bodies, proceeds with his investigations of astronomical constants. From his research into the geodetic uses of artificial satellites, he has recently prepared reports on results for the tesseral harmonics of the earth's gravitational field, on his second-order theory of oblateness perturbations, and on his re-determinations of coefficients of zonal spherical harmonics to the ninth order, derived from analysis of Baker-Nunn observations of 13 satellites. Dr. Kozai has also begun a new program to investigate secular perturbations of asteroids for information on high inclination and high eccentric orbits, a problem involving the stability theory of asteroids and of the solar system.

Dr. Don A. Lautman's study of the distribution of the perihelia of the asteroids attempts to determine a possible relationship with effects of second-order secular perturbations by Jupiter. His continuing numerical integration project to explore possible use of radiation pressure on balloon satellites as a means of achieving orbits around the moon has resulted in several computer programs which he will utilize for this purpose and for the study of other orbital problems awaiting investigation.

Dr. G. Veis continued his work in the geodetic uses of satellites from a geometric point of view. He is developing a program to use almost simultaneous observations for space triangulations and for absolute orientation in space of triangulation nets. He is currently attempting to determine the position of the 12 Baker-Nunn cameras by using the newest precisely reduced Baker-Nunn observations.

Satellite-tracking program.—The optical tracking of artificial satellites with NASA support continues to furnish important data for the prediction of orbits, determination of atmospheric densities, and geophysical and geodetic information. The program embraces a worldwide organization of 92 Moonwatch teams composed of non-professional observers and 12 precision photographic stations in various parts of the world, photographic image-reduction, detailed analysis by electronic computers, precise reduction of satellite positions, and calculation of satellite ephemerides.

From May 1, 1961, to May 1, 1962, visual observations by Moonwatch of 75 objects (satellites and their orbiting components) totaled

12,073, furnishing basic data for correcting ephemerides and for acquiring and reacquiring nonbroadcasting satellites. During the year the teams conducted a number of searches for orbiting objects.

In the same period the Computations Division distributed to the 12 Baker-Nunn stations 73,466 predictions that yielded 26,446 observations reported by cable to Cambridge. This amounts to approximately twice the activity of the previous year.

The Photoreduction Center received 25,060 successful films (arcs) and completed 15,409 reductions of satellite positions.

Through the Communications Center, 1.5 to 2 million words were cleared each month, 95 percent of these representing satellite data received or sent throughout the world. This compares with approximately 1 million words per month in the previous year.

The Research and Analysis Division has derived valuable conclusions based on the data drawn from the several tracking activities (see *Space Science*). For example, the variations of density in the high atmosphere for altitudes of 200 to 750 km. have been determined with respect to solar activity, ultraviolet and corpuscular radiation. The data on atmospheric drag obtained by optical observation are now used as basic information by most investigators in the field of atmospheric studies.

The geodetic applications of satellite observations continue to be studied. Knowledge of station coordinates has been improved by means of a program of simultaneous satellite observations from selected stations. The Baker-Nunn stations are now well equipped for this type of observation, and a prediction program for simultaneous observations is working satisfactorily. Good results have been obtained already from the stations in Peru and Argentina working simultaneously.

To further this work, studies are being conducted of the adaptability of modified aerial reconnaissance cameras for use as semimobile cameras for geodetic use, both independently and in conjunction with the fixed-position Baker-Nunn network. The Observatory is cooperating with the Department of Defense and NASA in establishing an international program for a flashing-light geodetic satellite.

Following a decision to continue operations of the optical satellite tracking program for a number of years, steps are being taken to do major maintenance and overhaul work on the cameras.

This work is complicated by the fact that facilities for handling the optical components of the cameras do not exist in most of the countries where the cameras are located.

PUBLICATIONS

Publications of the Smithsonian Contributions to Astrophysics included numbers 9 through 11 of volume 5.

The following papers by staff members of the Astrophysical Observatory appeared in various journals:

- AVRETT, E. H. Particle motion in the equatorial plane of a dipole magnetic field. *Journ. Geophys. Res.*, vol. 67, pp. 53-58, 1962.
- CARRIER, G. F., and AVRETT, E. H. A non-gray radiative-transfer problem. *Astrophys. Journ.*, vol. 134, pp. 469-481, 1961.
- COLOMBO, G. Instability of motion at the Lagrangian triangular point in the earth-moon system. *Nature*, vol. 193, p. 1063, 1962.
- COOK, A. F.; HAWKINS, G. S.; and STIENON, F. M. Meteor trail widths. *Astron. Journ.*, vol. 67, pp. 158-162, 1962.
- DAVIS, R., and GODFREDSON, E. A. Optimum resolving power for an ultraviolet space telescope. *Planet. Space Sci.*, vol. 5, pp. 207-212, 1961.
- DAVIS, R. J., and RUSTGI, O. P. Ultraviolet instrumentation for Telescope—an astrophysical reconnaissance satellite. *Applied Optics*, vol. 1, pp. 131-137, 1962.
- FIREMAN, E. L. The Ehole meteorite, its acquisition and its radioactivity. *Journ. Geophys. Res.*, vol. 67, pp. 2592-2594, 1962.
- FIREMAN, E. L., and DE FELICE, J. Argon-39, argon-37, and tritium in the recently fallen Bruderheim meteorite (abstract). *Journ. Geophys. Res.*, vol. 66, p. 2528, 1961.
- . Tritium, argon-37, and argon-39 in the Bruderheim meteorite. *Journ. Geophys. Res.*, vol. 66, pp. 3547-3551, 1961.
- FIREMAN, E. L.; DE FELICE, J.; and TILLES, D. Solar flare tritium in a recovered satellite. *Phys. Rev.*, vol. 123, pp. 1935-1938, 1961.
- FIREMAN, E. L., and FISHER, D. E. Uranium in the Sikhote-Alin meteorite and its relation to the lead method of age determination. *Nature*, vol. 192, pp. 644-645, 1961.
- FIREMAN, E. L., and ROWLAND, F. S. An additional measurement of the tritium contents of atmospheric hydrogen of 1949. *Journ. Geophys. Res.*, vol. 66, p. 4321, 1961.
- GINGERICH, O. Polynomial approximation for the negative hydrogen-ion absorption coefficient. *Astrophys. Journ.*, vol. 134, pp. 653-656, 1961.
- . A computer program for non-gray stellar atmospheres (abstract). *Astron. Journ.*, vol. 66, p. 285, 1961.
- GOLDBERG, L. Project West Ford—properties and analysis. Introduction. *Astron. Journ.*, vol. 66, pp. 105-106, 1961.
- . Solar experiments—U.S. plans. *Mém. Soc. Roy. Sci. Liège, ser. 5*, vol. 55, pp. 30-38, 1961.
- . The Sun. *Bull. Atomic Scientists*, vol. 17, pp. 210-213, 1961.
- . Studying the universe from a space platform. *In* S. Ramo, ed., *Peacetime uses of outer space*, McGraw-Hill Book Co., New York, 1961.
- . Report of Commission 12 on radiation and structure of the solar atmosphere. *In* D. H. Sadler, ed., *Trans. Intern. Astron. Union, Reports on astronomy*, vol. XI A, pp. 63-89, Academic Press, New York, 1962.
- GOLDBERG, L., and DYER, E. R., Jr. The Sun. *In* L. V. Berkner and H. Odishaw, ed., *Science in space*, pp. 307-340, McGraw-Hill Book Co., New York, 1961.
- . Galactic and extragalactic astronomy. *In* L. V. Berkner and H. Odishaw, ed., *Science in space*, pp. 341-399, McGraw-Hill Book Co., New York, 1961.
- GROSSI, M. D.; STROM, K. M.; and STROM, S. E. Ionospheric focusing of cosmic radio sources. *Journ. Geophys. Res.*, vol. 67, pp. 1672-1674, 1962.
- HAGIHARA, Y. Rotation of an earth satellite in flight along its orbit. *Smithsonian Contr. Astrophys.*, vol. 5, No. 9, pp. 113-143, 1961.

- HODGE, P. W. Sampling dust from the stratosphere. *Smithsonian Contr. Astrophys.*, vol. 5, No. 10, pp. 145-152, 1961.
- IZSAK, I. G. A determination of the ellipticity of the earth's equator from the motion of two satellites. *Astron. Journ.*, vol. 66, pp. 226-229, 1961.
- . A determination of the ellipticity of the earth's equator from the motion of two satellites. *In* H. C. van de Hulst, C. de Jager, and A. F. Moore, ed., *Space Research II*, pp. 352-359, North Holland Publishing Co., Amsterdam, 1961.
- IZSAK, I. G., and KOZAI, Y. Equipotential surfaces of the earth as obtained from satellite motions (abstract). *Journ. Geophys. Res.*, vol. 66, pp. 2538-2539, 1961.
- JACCHIA, L. G. Irregularities in atmospheric densities deduced from satellite observations. *Ann. Géophys.*, vol. 17, pp. 52-55, 1961.
- . A working model for the upper atmosphere. *Nature*, vol. 192, pp. 1147-1148, 1961.
- . Satellite drag during the events of November 1960. *In* H. C. van de Hulst, C. de Jager, and A. F. Moore, ed., *Space Research II*, pp. 747-750, North Holland Publishing Co., Amsterdam, 1961.
- . Interplanetary matter. *In* H. H. Koelle, ed., *Handbook of astronomical engineering*, pp. 2.57-2.64, McGraw-Hill Book Co., New York, 1961.
- KOZAI, Y. Tesseral harmonics of the gravitational potential of the earth as derived from satellite motions. *Astron. Journ.*, vol. 66, pp. 355-358, 1961.
- . Potential field of the earth derived from motions of artificial satellites. *In* S. H. Laurila and W. A. Heiskanen, ed., *Proc. Symposium of Geodesy in the Space Age*, pp. 174-176, Ohio State University, Inst. Geodesy, Photogrammetry, and Cartography, Publ. No. 15, 1961.
- KUMAR, S. S. A method for computing monochromatic fluxes in model stellar atmospheres (abstract). *Astron. Journ.*, vol. 66, pp. 288-289, 1961.
- . On the age of the galaxy. *Observatory*, vol. 82, pp. 34-36, 1962.
- . On the Λ and Φ operators of radiative transfer theory. *Smithsonian Contr. Astrophys.*, vol. 5, No. 11, pp. 153-185, 1962.
- LASSOVSKY, K. On the accuracy of the measurements made upon films photographed by Baker-Nunn satellite tracking cameras (abstract). *Astron. Journ.*, vol. 66, p. 289, 1961.
- LEDOUX, P., and WHITNEY, C. A. Velocity fields and associated thermodynamic variations in the external layers of intrinsic variable stars. *In* R. N. Thomas, ed., *Aerodynamic phenomena in stellar atmospheres*, Proc. 4th Symposium on Cosmical Gas Dynamics, I.A.U. Symposium No. 12, pp. 131-193, *Nuovo Cimento Suppl.*, ser. 10, vol. 22, No. 1, 1961.
- MITLER, H. E. Electromagnetic potentials in quantum mechanics. *Phys. Rev.*, vol. 124, pp. 940-944, 1961.
- SKALAFURIS, A., and WHITNEY, C. A. Radiative cooling behind shock fronts in stellar atmospheres. *Ann. d'Astrophys.*, vol. 24, pp. 420-424, 1961.
- SOUTHWORTH, R. B. Planetary perturbations and the Perseid meteor stream (abstract). *Astron. Journ.*, vol. 66, pp. 295-296, 1961.
- STROM, S. E., and STROM, K. M. A possible mechanism for Jovian decameter bursts (abstract). *Astron. Journ.*, vol. 67, p. 121, 1962.
- TILES, D. Variations of silicon isotope ratios in a zoned pegmatite. *Journ. Geophys. Res.*, vol. 66, pp. 3015-3020, 1961.
- . Natural variations in isotopic abundances of silicon. *Journ. Geophys. Res.*, vol. 66, pp. 3003-3013, 1961.
- . Primordial gas in the Washington County meteorite. *Journ. Geophys. Res.*, vol. 67, pp. 1687-1689, 1962.

- VEIS, G., and WHIPPLE, F. L. Experience in precision optical tracking of satellite for geodesy. In H. C. van de Hulst, C. de Jager, and A. F. Moore, ed., *Space Research II*, pp. 17-33, North Holland Publishing Co., Amsterdam, 1961.
- WHIPPLE, F. L. Dust halo. *Space World*, vol. 1, No. 8, pp. 20 ff, 1961.
- . Problems of the cometary nucleus. *Astron. Journ.* vol. 66, pp. 375-380, 1961.
- . On the distribution of semimajor axes among comet orbits. *Astron. Journ.*, vol. 67, pp. 1-9, 1962.
- . Report of Sub-commission 22a on meteorites. In D. H. Sadler, ed., *Trans. Intern. Astron. Union, Reports on astronomy*, vol. XIA, pp. 213-227, Academic Press, New York, 1962.
- WHITNEY, C. A. Determination of atmospheric densities from satellite observations. *Ann. Géophys.*, vol. 17, pp. 237-244, 1961.
- WOOD, J. A. Chondrules and the origin of the terrestrial planets. *Nature*, vol. 194, pp. 127-130, 1962.
- ZADUNAISKY, P. E.; SHAPIRO, I. I.; and JONES, H. M. Solar radiation pressure effects, gas leakage rates, and air densities inferred from the orbit of Echo I. In H. C. van de Hulst, C. de Jager, and A. F. Moore, ed., *Space Research II*, pp. 339-351, North Holland Publishing Co., Amsterdam, 1961.

The Special Reports of the Astrophysical Observatory distribute catalogs of satellite observations, orbital data, and preliminary results of data analysis prior to journal publication. Thirty-five numbers (64 through 98), issued during the year, contain the following material:

Special Report No. 64, July 7, 1961.

The revised orbit of Satellite 1958 Zeta, by R. C. Nigam.

Special Report No. 65, July 14, 1961.

Atmospheric drag on non-spherical artificial satellites, by P. E. Zadunaisky.

Special Report No. 66 (C-22), July 17, 1961.

Catalogue of satellite observations: Satellites 1958 Alpha (Explorer I), 1958 β 1 (carrier rocket, Vanguard I), 1958 Epsilon (Explorer IV), 1959 α 1 (Vanguard II), 1959 α 2 (carrier rocket, Vanguard II), 1959 Eta Vanguard III, and 1959 ϵ 1 (Explorer VII), for Sept. 1-Dec. 31, 1960, by D. V. Mechau.

Special Report No. 67 (C-23), July 17, 1961.

Catalogue of satellite observations: Satellites 1960 ϵ 1 (Echo I), and 1960 ϵ 2 (carrier rocket, Echo I), for Sept. 1-Dec. 31, 1960, by D. V. Mechau.

Special Report No. 68 (C-24), July 17, 1961.

Catalogue of satellite observations: Satellites 1960 β 1 (carrier rocket, Tiros I), for Sept. 14-21, 1960; 1960 β 2 (Tiros I), for Sept. 2-Oct. 15, 1960; 1960 γ 1 (carrier rocket, Transit 1B), for July 7-27, 1960; 1960 γ 2 (Transit 1B), for July 26-Nov. 7, 1960; 1960 η 1 (Transit 2A), for June 26-Dec. 29, 1960; 1960 η 2 (Greb), for June 22-Dec. 23, 1960; 1960 η 3 (carrier rocket, Transit 2A, Greb), for June 23-Dec. 31, 1960; 1960 ξ 1 (Explorer VIII), for Nov. 4-Dec. 30, 1960; 1960 ξ 2 (carrier rocket, Explorer VIII), for Nov. 19-Dec. 24, 1960; 1960 Omicron (Discoverer XVII), for Nov. 13-Dec. 31, 1960; and 1960 Sigma (Discoverer XVIII), for Dec. 8-31, 1960, by D. V. Mechau.

Special Report No. 69, July 17, 1961.

List of coordinates of stations engaged in the observation of artificial earth satellites, by D. V. Mechau.

Special Report No. 70, July 18, 1961.

The motion of Satellite 1958 Epsilon around its center of mass, by G. Colombo.

Special Report No. 71, July 24, 1961.

Elements of the orbit of the Satellite 1959 Eta (Vanguard III) during the first year after launching, by P. E. Zadunaisky and B. Miller.

Special Report No. 72, August 9, 1961.

Tesseral harmonics of the potential of the earth as derived from satellite motions, by Y. Kozai.

Special Report No. 73, August 10, 1961.

Differential orbit improvement with the use of rotated residuals, by I. G. Izsak.

Special Report No. 74, September 18, 1961.

On the accuracy of measurements made upon films photographed by Baker-Nunn satellite tracking cameras, by K. Lassovszky.

Special Report No. 75, September 19, 1961.

Density of the heterosphere related to temperature, by M. Nicolet.

Special Report (unnumbered), September 20, 1961.

Index to SAO Special Reports Nos. 1-75.

Special Report No. 76, October 2, 1961.

Effects of the earth's ionosphere on HF radio astronomy from artificial satellites, by M. D. Grossi, K. M. Strom, and S. E. Strom.

Special Report No. 77, October 24, 1961.

Short-periodic oscillations in the drag of Satellite 1958 Alpha, by L. G. Jacchia and J. Slowey.

Special Report No. 78, October 25, 1961.

Satellite orbital data: Satellites 1958 Alpha, 1958 β 1 and 1959 α 1 by B. Miller, for May-Dec. 1960, compiled by D. V. Mechau.

Special Report No. 79, October 30, 1961.

The analysis of gravity, by H. Jeffreys.

Special Report No. 80, November 1, 1961.

The stabilization of an artificial satellite at the inferior conjunction point of the earth-moon system, by G. Colombo.

Special Report No. 81, November 24, 1961.

The orbits of the Satellites 1959 α 1 and 1959 α 2 and the perturbations on the perigee distance of 1959 α 1, by R. C. Nigam.

Special Report No. 82 (P-1), November 30, 1961.

Catalog of precisely reduced observations: Satellites 1959 α 1, for Feb. 17-June 30, 1959; and 1959 Eta, for Sept. 18-Dec. 31, 1959, prepared by G. Veis.

Special Report No. 83, January 31, 1962.

Project Telescope, by R. J. Davis and Telescope staff.

Special Report No. 84, February 9, 1962.

Preliminary analysis of the atmospheric drag of the twelve-foot balloon satellite (1961 δ 1), by L. G. Jacchia and J. Slowey.

Special Report No. 85 (P-2), February 12, 1962.

Catalog of precisely reduced observations: Satellites 1959 α 1, for July 1-Dec. 31, 1959; 1959 α 2, for Mar. 6-May 31, 1959; 1960 α 2, for Sept. 10-Dec. 31, 1960; 1960 Omicron, for Nov. 13-Nov. 16, 1960; and 1960 Sigma, for Dec. 8-Dec. 10, 1960, prepared by G. Veis.

Special Report No. 86, February 21, 1962.

Satellite orbital data: Satellites 1958 Alpha, for Jan. 1-July 1, 1961; 1958 β 1, for Jan. 1-July 27, 1961; 1960 ξ 1, for Nov. 4, 1960-July 3, 1961; 1961 δ 1, for Feb. 16-July 2, 1961; and 1961 ν 1, for April 28-Sept. 1, 1961, by B.

Special Report No. 86, February 21, 1962—Continued

Miller; and 1959 $\alpha 1$, for Dec. 31, 1960–July 1, 1961, by J. Weingarten, compiled by I. G. Izsak.

Special Report No. 87 (C-25), February 23, 1962.

Catalogue of satellite observations: Satellites 1958 Alpha (Explorer I), 1958 $\beta 1$ (carrier rocket, Vanguard I), 1959 1 (Vanguard II), 1959 $\alpha 2$ (carrier rocket, Vanguard II), 1959 Eta (Vanguard III), and 1959 $\alpha 1$ (Explorer VII), for Jan. 1–June 30, 1961, by D. V. Mechau.

Special Report No. 88 (C-26), February 23, 1962.

Catalogue of satellite observations: Satellites 1960 $\alpha 1$ (Echo I) and 1960 $\alpha 2$ (carrier rocket, Echo I), for Jan. 1–June 30, 1961, by D. V. Mechau.

Special Report No. 89 (C-27), February 23, 1962.

Catalogue of satellite observations: Satellites 1960 $\xi 1$ (Explorer VIII), for Nov. 3, 1960–June 30, 1961; 1961 $\delta 1$ (Explorer IX), for Feb. 16–June 30, 1961; and 1961 $\eta 1$ (Explorer XI), for April 27–June 30, 1961, by D. V. Mechau.

Special Report No. 90, Mar. 14, 1962.

On the critical inclination in satellite theory, by I. G. Izsak.

Special Report No. 91 (P-3), April 20, 1962.

Catalog of precisely reduced observations: Satellites 1958 $\delta 2$, for Dec. 1–17, 1958; 1959 $\alpha 2$, for Jan. 1–Dec. 31, 1960; and 1959 Eta, for Jan. 1–June 30, 1960.

Special Report No. 92 (E-1), April 23, 1962.

Satellite orbital data: Satellites 1958 $\delta 2$, for Dec. 7–14, 1959, by Y. Kozai; 1959 $\alpha 1$, for Feb. 21–Dec. 30, 1959, by P. Stern and M. Gutierrez; 1959 $\alpha 2$, for Mar. 19–May 28, 1959, by P. Stern; 1959 Eta, for Sept. 23–Dec. 30, 1959, by R. Nigam and P. Stern; 1960 $\epsilon 2$, for Sept. 11, 1960–Mar. 12, 1961, by I. Izsak and J. Weingarten; 1960 Omicron, for Nov. 13–15, 1960, by J. Weingarten; and 1960 Sigma, for Dec. 8–10, 1960, by J. Weingarten, compiled by I. G. Izsak.

Special Report No. 93, May 4, 1962.

Satellite orbital data: Satellites 1958 Alpha, for July 1, 1961–Jan. 1, 1962, by B. Miller; 1959 $\alpha 1$, for July 1, 1961–Jan. 1, 1962, by M. Gutierrez; 1960 $\xi 1$, for July 1, 1961–Jan. 1, 1962, by M. Hall; and 1961 $\delta 1$, for July 2, 1961–Jan. 5, 1962, by J. Weingarten, compiled by I. G. Izsak.

Special Report No. 94, May 23, 1962.

On the motion of Explorer XI around its center of mass, by G. Colombo.

Special Report No. 95 (P-4), June 18, 1962.

Catalog of precisely reduced observations: Satellites 1959 Eta, for July 1–Dec. 31, 1960; and 1960 $\epsilon 2$, for Jan. 1–June 30, 1961, prepared by K. Haramundanis.

Special Report No. 96 (C-28), June 25, 1962.

Catalogue of satellite observations: Satellites 1958 Alpha (Explorer I), 1959 $\alpha 1$ (Vanguard II), 1959 Eta (Vanguard III), and 1959 $\alpha 1$ (Explorer VII), for July 1–Dec. 31, 1961; and 1959 $\alpha 2$ (carrier rocket, Vanguard II), for July 1–27, 1961, by B. Miller.

Special Report No. 97 (C-29), June 25, 1962.

Catalogue of satellite observations: Satellites 1960 $\alpha 1$ (Echo I) and 1960 $\alpha 2$ (carrier rocket, Echo I), for July 1–Dec. 31, 1961, by B. Miller.

Special Report No. 98 (C-30), June 25, 1962.

Catalogue of Satellite observations: Satellites $\xi 1$ (Explorer VIII) and 1961 $\delta 1$ (Explorer IX), for July 1–Dec. 31, 1961; $\nu 1$ (Explorer XI), for July 1–Sept. 28, 1961; and 1961 $\alpha 1$ (Transit 4a) and 1961 $\alpha 2$ (Injun Solar Radiation), for June 29–Dec. 31, 1961, by B. Miller.

OTHER ACTIVITIES

The director and Drs. Gingerich, Goldberg, Jacchia, Kozai, and Lassovszky attended the International Astronomical Union meeting in Berkeley, Calif. Mr. Izsak addressed the Space Science Symposium at Pasadena, Calif.

In August 1961, more than 50 scientists from 9 different countries attended the International Symposium on the Astronomy and Physics of Meteors held at the Observatory headquarters, Cambridge, Mass. The director, Dr. Hawkins, Dr. McCrosky, Dr. Southworth, and Mr. Briggs presented papers at the meeting. Drs. Fireman, Hamid, Jacchia, Wright, and Cook also attended. The proceedings of the symposium will be published in the Smithsonian Contributions to Astrophysics.

Dr. Whipple addressed the American Rocket Society meeting in New York on the concentration of dust around the earth.

Sir Harold Jeffreys delivered a series of 24 public lectures on figures of the earth and moon. He also lectured at the Institute of Geodesy at the University of Ohio.

Dr. Whipple represented the International Astronomical Union at a meeting of the International Academy of Astronautics and the Twelfth International Astronautical Congress in Washington, D.C. He also attended the U.S. Air Force's North American Air Defense Command Optical Space Science Conference in Colorado Springs, Colo.

Dr. Southworth presented a paper at a meeting on the exploration of the solar system by radar and radio-astronomy at the International Astronautical Congress in Washington, D.C.

Dr. Kozai attended the USSR conference on Theoretical Astronomy in Moscow.

Dr. Tilles presented a paper "Tritium in Discoverer Satellites" at the National meeting of the American Geophysical Union at Los Angeles, Calif.

Dr. Davis and Mr. Strom attended the American Astronomical Society Meeting in Denver, Colo. Mr. Strom presented a paper at the meeting.

Dr. Whipple was awarded the American Astronautical Society's Space Flight Award for 1962 at the annual meeting of the Society in Washington, D.C. He was elected vice president of the Society for 1962. He also spoke before the Subcommittee on Patents of the House of Representatives Committee on Science and Astronautics. He appeared before the full committee and presented a paper urging removal of military secrecy from the planned flashing-light geodetic satellite "Project Anna."

Dr. Davis presented a paper on Project Celeste to the Institute of Radio Engineers in Baltimore.

The director and Dr. Wood attended the National Aeronautics and Space Administration Institute of Space Studies Conference on "The Origin of the Solar System" in New York.

The Observatory, together with the Harvard College Observatory, were hosts to the 110th annual meeting of the American Astronomical Society. Drs. Whipple, Southworth, Fireman, Kozai, Gingerich, Whitney and Messrs. Briggs and Zadunaisky presented papers.

Dr. Kozai attended a symposium on Solar System Constants at the Rand Corporation, Santa Monica, Calif.

Mr. Hagge attended a meeting of Study Group VII, C.C.I.R., in Geneva, Switzerland, concerning the international distribution of standard frequency and time signals.

Drs. Whipple, Colombo, Fireman, Jacchia, Kozai, Lautman, Tilles, Wood, Veis, and Mr. Izsak contributed to the COSPAR Meeting in Washington.

Drs. Jacchia and Kozai attended the International Symposium on the Dynamics of Satellites in Paris, France.

Drs. Whipple and Goldberg were invited to attend the National Academy of Sciences, Space Science Board, summer study program at the State University of Iowa. The program was directed toward an examination of the scope and quality of the national space science program and its future objectives.

STAFF CHANGES

The following scientists joined the staff: Dr. Thomas Noonan, Dr. Henri Mitler, Dr. Ursula Marvin, Dr. Frances Wright, and Dr. Allan F. Cook. During this year Sir Harold Jeffreys, Dr. Marcel Nicolet, Dr. Salah Hamid, Dr. George Veis, and Dr. G. G. Cillié worked at the Observatory.

Dr. Karoly Lassovszky died on December 20, 1961.

As of June 30, 1962, 322 persons were employed at the Observatory.

DIVISION OF RADIATION AND ORGANISMS

Prepared by W. H. KLEIN, Chief of the Division

The research program of the Division has been concerned with fundamental studies in the area of radiation biology with emphasis on developing systematic concepts of the metabolic mechanisms and responses of living organisms as influenced and regulated by radiation.

In the study of phototropic responses, the tropic response of *Phycomyces blakesleeanus* to unilateral broad band blue (400-500 m μ) light has been found to disappear at intensities greater than 1,300

$\mu\text{w}/\text{cm}^2$. The growth response also has been found to vanish for sporangiophores adapted at intensities greater than $1,300 \mu\text{w}/\text{cm}^2$. As this intensity is approached, the growth rate becomes 30–50 percent higher than that observed for sporangiophores adapted in the normal range of intensities, and this increased rate is maintained for long periods of time (3 or more hours). However, the mechanism controlling the level of light sensitivity (the range adjustment mechanism) appears to function at any intensity and with the same time constant of about 4.0 minutes as in the normal range.

The bending rate in the normal range is about 5–7 degrees/minute for continuous unilateral stimuli given at 90° to the long axis of the sporangiophore. As the intensity approaches $1300 \mu\text{w}/\text{cm}^2$, the bending rate decreases rapidly to zero. Apparently, the gradient across the cylindrical growing zone disappears, just as found previously for immersion oils with an index of refraction near 1.295. Whether this loss of a gradient is due to saturation of the light sensitive system or to bleaching of the photoreceptors is not yet known.

Preliminary action spectra, at $20 \text{ m}\mu$ intervals, for this disappearance of the tropic response have been completed and found to have very nearly the same wavelength dependence as observed previously in the normal range tropic response.

The dimensions of the cytoplasmic layer within the growing zone and adjacent regions of the sporangiophore have been measured under oil immersion. On the average, the cytoplasm occupies about 40 percent of the diameter from the sporangium to 1 mm below. In the growing zone itself it is about 25 percent of the diameter, and below the growing zone decreases to about 15 percent. The cytoplasm is continuously streaming while being observed, and its thickness fluctuates as much as 10 percent within a few minutes at any one point.

The growth promoting effect of cobalt in etiolated leaf tissue is independent of growth inhibition by 2,4-dinitrophenol, which uncouples oxidative phosphorylation. Cobalt does not raise the adenosine triphosphate (ATP) concentration of leaf tissue, but does prevent a decrease in ATP content in the presence of 2,4-dinitrophenol. In order to elucidate the role of cobalt, experiments were performed with isolated mitochondria, the subcellular organelles which are the sites of oxidative phosphorylation. The results showed that cobalt alone had no significant effect on respiration or phosphorylation. However, when mitochondria were exposed to both cobalt and 2,4-dinitrophenol, phosphorylative activity increased about 10 percent over that of the 2,4-dinitrophenol control. Mitochondria contain not only enzymes that synthesize ATP, but also enzymes that decompose ATP. Since the influence of cobalt on the synthesis of ATP was relatively small, the possibility of cobalt's influencing the enzymatic decomposition was

examined. The results of these experiments showed that cobalt inhibited the destruction of ATP. This effect was observed both in the presence and absence of 2,4-dinitrophenol. Thus, it is indicated that cobalt exerts its growth-promoting influence by inhibiting the activity of the enzyme ATPase.

Studies on light-dependent chloroplast maturation have been conducted, using chloramphenicol (antibiotic) to determine the participation of protein synthesis in the maturation process. Etiolated plants that have been treated with chloramphenicol do not develop photosynthetic activity when irradiated with white light. Synthesis of chlorophyll is markedly inhibited and cannot be altered by large changes in the intensity of irradiation. In contrast, other light-dependent responses such as leaf expansion, opening of the hypocotyl hook, and anthocyanin formation are not inhibited by the antibiotic.

Measurements of excitation of chlorophyll fluorescence in intact control and treated leaves show that chloramphenicol does not prevent development of the ability of carotenoid pigments to transfer energy to chlorophyll. Measurements of Hill reaction and photosynthetic phosphorylation of chloroplasts of treated and control leaves show that antibiotic prevents development of these photosynthetic activities. Light-dependent increase of the photosynthetic enzyme TPN-linked glyceraldehyde-phosphate dehydrogenase was inhibited by chloramphenicol but that of another, carboxydismutase, was not. Increase in leaf protein which is associated with chloroplast maturation was partially inhibited by chloramphenicol.

These results indicate that chloramphenicol prevents synthesis of substances necessary for dark reactions of photosynthesis. At least one of the substances lacking in treated leaves and necessary for photosynthesis is associated with chloroplasts. Inhibition of development of photosynthetic activity of leaves can be accounted for by the ability of chloramphenicol to inhibit protein synthesis in leaves.

The physiological basis for changes in sensitivity of maize chromosomes to X-rays during seed germination has been studied, using somatic mutation technics. X-ray damage was markedly enhanced by oxygen, i.e., plants grown from seeds irradiated under anoxia (helium) showed a two- to three-fold reduction in sector frequencies as compared to plants grown from seed irradiated in air. Oxygen enhancement, which was virtually nil for dry seed, attained its initial expression after 4-5 hours hydration. Irradiation in two atmospheres of pure oxygen, rather than in air, effected no increase in sector frequencies during these first 4-5 hours. Apparently, the "oxygen effect" is not influenced primarily by factors governing availability of oxygen to the embryo, but owes its inception to other biochemical or biophysical changes during this early period of germination.

Studies involving the reversal of red light induction by far-red radiation at 25° C. show that there must be a time delay interposed between red and far-red light treatments before maximum reversal can occur in hypocotyl hook of beans, in *Arabidopsis* seed germination, and in leaf disc expansion. Lettuce seed germination and reversal by far-red light at 25° C. does not require a time delay between light treatments to obtain maximum efficiency in reversal. However, when the experiments are conducted at 2° C., a requirement for a time delay between light treatments is manifested.

The influence of such exogenous and endogenous factors as substrate, age, ionizing radiation, and particularly the red, far-red photomorphogenic pigment system on the development of the chlorophyll-synthesizing mechanism in etiolated leaf tissue, have all been previously demonstrated in this laboratory. The apparent effect of the mediation of a photomorphogenic receptor on chlorophyll synthesis implies a radiant energy stimulation of biochemical systems associated with either pigment precursor synthesis and/or exo- or endoplastid enzyme systems, resulting in observable gross morphological proplastid changes.

Light-microscope examination of corn leaf tissue macerates have revealed both biochemical and morphological changes within the developing proplastid. In the dark-grown seedling, proplastids continue to enlarge slowly and accumulate considerable starch internally during the first several days of growth; a short pretreatment with white light, on the other hand, induces an observable degradation of accumulated starch, as well as considerable enlargement in proplastid size. These light-induced proplastid changes can be correlated with photomorphogenic leaf responses such as elongation and expansion.

PUBLICATIONS

- PRICE, LEONARD, and KLEIN, WILLIAM H. Red, far-red response and chlorophyll synthesis. *Plant Physiol.*, vol. 36, pp. 733-735, 1961.
- SHROPSHIRE, WALTER, Jr. The lens effect and phototropism of *Phycomyces*. *Journ. Gen. Physiol.*, vol. 45, pp. 949-958, 1962.
- MARGULIES, MAURICE M. The effect of chloramphenicol on the light dependent development of seedlings of *Phaseolus vulgaris* var. Black Valentine, with particular reference to the development of photosynthetic activity. *Plant Physiol.*, vol. 37, pp. 473-480, 1962.

OTHER ACTIVITIES

The division was represented during this year at various conferences of scientists and meetings of scientific societies. Drs. L. Loercher and W. H. Klein were invited participants in the Gordon Research Conferences on Biochemistry and Agriculture, Tilton, N.H.,

where Dr. Loercher presented a paper on "The Influence of Cobalt on Leaf Expansion and Yield of Oxidative Phosphorylation."

Attending the annual meetings of the American Institute of Biological Sciences in August 1961 at Purdue University were L. Price, M. Margulies, W. Shropshire, V. B. Elstad, W. H. Klein, L. Loercher, and J. L. Edwards. Included among the papers presented to the American Society of Plant Physiologists at these meetings were "The Effect of Red and Far-Red Radiant Energy and Delta Amino Levulinic Acid on the Lag Phase of Chlorophyll Synthesis in Bean Seedlings," by E. C. Sisler, W. H. Klein, and Rebecca Gettens; "The Mode of Action of Cobalt in the Expansion of Etiolated Leaf Tissue," by L. Loercher; "The Effect of Chloramphenicol on Chlorophyll Formation and on Development of Photosynthetic Activity," by M. Margulies; and "Negative Phototropism of *Phycomyces* Sporangio-phores to Blue Light Stimuli," by W. Shropshire. Dr. Klein attended the Executive Committee sessions of the American Society of Plant Physiologists.

Also in August, J. H. Harrison attended the Seminar for Scientific Glassblowers held at the State University of New York. Mr. Harrison and A. H. Busch attended the 8th Annual Symposium of the American Vacuum Society held in October in Washington.

Dr. Klein was an invited participant in the Conference on Basic Mechanisms in Radiobiology, San Juan, P.R., sponsored by the Atomic Energy Commission in November.

Dr. Shropshire attended the annual meeting of the Biophysical Society in Washington in February 1962. In March Dr. Klein visited the University of Arizona at Tucson to consult with Dr. Paul Damon regarding carbon-dating facilities, and in April he studied newly developed carbon-dating technics at Radiochemistry, Inc., at Louisville, Ky.

In May 1962, Drs. R. Latterell and Klein attended the 10th Annual Meeting of the Radiation Research Society at Colorado Springs, Colo.

Dr. Shropshire visited Duke University and North Carolina State College in June to consult with university scientists in the Departments of Biophysics and Plant Physiology.

Also in June, Mr. Harrison and A. H. Busch attended the 7th Annual Symposium of the American Scientific Glassblowers Society, held in Washington, where Mr. Harrison participated as chairman of the workshop committee.

The installation of a radio-carbon dating laboratory has been accomplished, and the facility is expected to be operational by August 1962. Facilities have also been installed for research in the biochemistry and physiology of marine organisms.

Dr. Pieter J. A. L. de Lint joined the research staff as visiting plant physiologist from Wageningen, the Netherlands. Dr. Konstantinos Mitrakos also joined the Division as visiting physiologist and biochemist from the University of Thessalonika, Greece.

Respectfully submitted.

FRED L. WHIPPLE, *Director.*

DR. LEONARD CARMICHAEL,
Secretary, Smithsonian Institution.

Report on the National Collection of Fine Arts

SIR: I have the honor to submit the following report on the activities of the National Collection of Fine Arts for the fiscal year ended June 30, 1962:

SMITHSONIAN ART COMMISSION

The 39th annual meeting of the Smithsonian Art Commission was held in Washington on Tuesday, December 5, 1961. Members present were Paul Manship, chairman; Leonard Carmichael, secretary; Gilmore D. Clarke, David E. Finley, Walker Hancock, Bartlett H. Hayes, Ogden M. Pleissner, Charles H. Sawyer, Stow Wengenroth, Archibald G. Wenley, and Andrew Wyeth. James C. Bradley, Assistant Secretary; Theodore W. Taylor, Assistant to the Secretary of the Smithsonian Institution; and Thomas M. Beggs, Director, National Collection of Fine Arts, were also present.

The Commission recommended reappointment of Robert Woods Bliss, Wilmarth Lewis, Henry P. McIlhenny, and Ogden M. Pleissner for the usual 4-year period.

The following officers were reelected for the ensuing year: Paul Manship, chairman; Robert Woods Bliss, vice chairman; and Leonard Carmichael, secretary.

The following were reelected members of the executive committee for the ensuing year: David E. Finley, chairman; Robert Woods Bliss, Gilmore D. Clarke, Archibald G. Wenley, with Paul Manship and Leonard Carmichael, *ex officio*.

Dr. Carmichael announced the gift from Mrs. Laura Dreyfus Barney of Barney Studio House, 2306 Massachusetts Avenue. One of its principal rooms is being redecorated at the suggestion of the donor to be used by the Smithsonian Institution for meetings and cultural events.

He informed the Commission that Congress had appropriated planning funds to provide detailed plans and specifications for the remodeling of the Patent Office Building, which is expected to be vacated by the Civil Service Commission in 1963 and ready for occupancy by the National Collection of Fine Arts and the National Portrait Gallery during 1965. Dr. Carmichael stated that bills concerning the National Portrait Gallery had passed the Senate and had been favorably reported out of committee in the House.

[An act "To provide for a National Portrait Gallery as a bureau of the Smithsonian Institution" (Public Law 87-443) was approved on April 27, 1962.]

Mr. Beggs reported briefly that plans for space distribution in the Patent Office Building at present allotted approximately 40 percent to the National Collection of Fine Arts, 40 percent to the National Portrait Gallery, and 20 percent to common services. He stated that the National Collection of Fine Arts was looking forward to utilizing the space for increasing its temporary exhibition program and for the expansion and proper display of permanent collections. Mr. Beggs pointed out the following sources from which the National Collection of Fine Arts receives its collections: purchases, such as those from the Ranger and Myer Funds; gifts and bequests from individuals; transfers from other Government agencies; and gifts of state.

The Commission recommended acceptance of the following for the National Collection of Fine Arts:

Two bronzes, *The Bear Tamer and Head of Kid*, by Paul Bartlett, N.A. (1865-1925). Offered by Miss Mary Bowditch, Boston, Mass.

Bronze, *Napoleon I (1769-1821)* by Launt Thompson (1833-1894). Offered by Dr. Gifford B. Pinchot, Upperco, Md.

Oil, *Mother (Annie Williams Gandy)*, by Thomas C. Eakins (1844-1916). Bequest of Mrs. Edward Pearson Rodman, through Miss Helen W. Gandy, Washington, D.C.

Oil, *Portrait of Isaac Lea (1792-1886)* by Bernhard Uhle (1848-1930). Offered by Mrs. Lea Hudson, New York City.

Watercolor, *Hains Point* by William H. Holmes (1846-1933). Offered by Lt. Col. C. W. Tazwell, Madeira Beach, Fla.

Andre Joseph Villard by David Boudon (active 1795-1797), miniature, watercolor on paper. Offered by Frederick W. Cron, Falls Church, Va.

Two subjects, *Mary and Unidentified Gentleman*, miniatures, watercolor on ivory, by Nina Nash Cron. Offered by Frederick W. Cron, Falls Church, Va.

Henry Smith by Undetermined Artist, miniature, watercolor on ivory. Offered by Mrs. Willis Adams, Arlington, Va.

Flemish tapestry, *The Beheading of St. Paul*. Offered by Mrs. Phillip Coffin, Hamilton, Mass.

The Commission recommended that decision concerning an Unidentified Portrait by Undetermined Artist, oil on panel, which was transferred from the Library of Congress, be deferred until next year.

THE CATHERINE WALDEN MYER FUND

The following miniatures, watercolor on ivory, were acquired from the fund established through the bequest of the late Catherine Walden Myer:

No. 127. *William Thornton (1759-1828)* by Robert Field (c. 1769-1819). Acquired from Miss Maude S. Gallup, Springfield, Vt.

No. 128. *Portrait of a Lady* attributed to John Cox Dillman Engleheart (1783-1862). Acquired from Mr. and Mrs. H. H. Rankin, Laurel, Md.

No. 129. Self Portrait by John Wesley Jarvis (1780-1839). Acquired from Mrs. Helen Moffatt Langdon, Alexandria, Va.

No. 130. Portrait of Mustian by E. Bossi. Acquired from Arthur J. Dettmers, Jr., Washington, D.C.

No. 131. J. Maitland attributed to Richard Cosway (1740-1821).

No. 132. S. Stone, attributed to John Wood Dodge (1807-1893).

No. 133. Man in Black Coat, White Stock by A. Galloway.

No. 134. Man in Brown Coat by Nathaniel Hone (1718-1821).

No. 135. Man in Dark Blue Coat by Mausion.

No. 136. Young Woman with Dark Hair by Andrew Plimer (1763-1837).

No. 137. Man with Black Hair, Blue Coat, by Undetermined Artist.

No. 138. Man with Powdered Wig, Blue Coat, by Undetermined Artist.

No. 139. Young Girl in White by Undetermined Artist.

Nos. 131 through 139 were acquired from Mrs. Hubert G. King, Washington, D.C.

WITHDRAWALS BY OWNERS

Silver sugar bowl and cream pitcher by William Thomson, lent October 25, 1951, were withdrawn by William Huntington on November 20, 1961.

ART WORKS LENT AND RETURNED

<i>Institutions</i>	<i>Loans</i>	<i>Loans returned</i>
Baltimore Museum of Art.....	1	1
Bureau of the Budget.....	2	2
Chrysler Art Museum, Provincetown, Mass.....	--	1
Council of Economic Advisers.....	1	--
Dallas Museum of Fine Arts.....	1	1
Defense, Department of.....	1	1
General Services Administration.....	1	--
GWETA (Educational TV Studio).....	2	2
Health, Education, and Welfare, Department of.....	22	20
Indian Claims Commission.....	1	--
Interior, Department of the.....	1	1
Internal Revenue Service.....	1	4
Justice, Department of.....	--	10
Lincoln Museum.....	--	1
Municipal Court for the District of Columbia.....	1	1
National Gallery of Art.....	2	2
Naval Historical Foundation.....	1	1
Peru, Embassy of.....	1	1
Post Office Department.....	1	--
Smithsonian Institution.....	24	8
State, Department of.....	1	1
Supreme Court, United States.....	1	--
Treasury, Department of the.....	2	--
United States District Court for the District of Columbia.....	1	5
United States Information Agency.....	1	1
Virginia Museum of Fine Arts.....	--	1
The White House.....	1	2
Whitney, Gertrude Vanderbilt, Museum of Western Art.....	--	1
Williamsport (Pa.) Community Arts Festival.....	13	13
	84	81

SMITHSONIAN LENDING COLLECTION

The following were added to the lending collection December 5, 1961:

Bronze, Head of Cat, by Paul Bartlett, N.A. (1865-1925). Offered by Miss Mary O. Bowditch, Boston, Mass.

Ivory, Statue of Liberty, by Raman Sankar. Offered by the artist, Karala State, Trivandrum, India, through the Embassy of India.

Two oils, Circus People Resting and Side Show, Ticket Seller, by Bernice Cross (1912-). Transferred from the National Zoological Park.

Three oils, Trout Stream, Top of the Ridge, and The Alcantara, together with two watercolors, Cathedral Steps, Cicicastenango, and Castillo de Bagor, Gerona, by Albert Sheldon Pennoyer (1888-1957). Offered by the estate of Albert Sheldon Pennoyer through the executors.

Three oils, The Deserted House, The Happy House, and Little White House (Holland), by S. Seymour Thomas (1868-1956). Offered by Mrs. Jean Haskell, Los Angeles, Calif.

Five oils, Unidentified Man by M. Shramchenko (1909-), George Washington (1732-1799), by Undetermined Artist, Christopher Columbus (c. 1446 or 1451-1506) by Undetermined Artist, Undetermined Title, by M. Stolypin, and Undetermined Title by G. Villegas. Transferred from the Library of Congress.

Two soft crayon lithographs, Duchess Charlotte of Northumberland and Duke Hugh of Northumberland, by Undetermined Artist. Offered by Mr. and Mrs. J. M. Higgin, Durham, England.

Harold F. Cross restored the following paintings: Alice Barney in Brown and White by Troubetzkoy; Albert Clifford Barney by O. W. Roederstein; Child by P. L. J. DeConinck; Laura at 16 by Alice Pike Barney; and Angel by Undetermined Artist.

The White Stock by Alice Pike Barney was renovated by Istvan P. Pfeiffer.

ART WORKS LENT FROM LENDING COLLECTION

<i>Institutions</i>	<i>Loans</i>	<i>Loans returned</i>
District Court for the District of Columbia-----	3	--
Dutchess County Art Association, New York-----	11	11
Health, Education, and Welfare, Department of-----	20	20
Internal Revenue Service-----	--	1
Science Information Exchange-----	--	15
United States District Court for the District of Columbia-----	--	3
	34	50

ALICE PIKE BARNEY MEMORIAL FUND

Additions to the principal during the year amounting to \$2,260.62 increased the total invested sums in the Alice Pike Barney Memorial Fund to \$43,358.91.

THE HENRY WARD RANGER FUND

According to a provision of the Henry Ward Ranger bequest, that paintings purchased by the Council of the National Academy of Design from the fund provided by the bequest and assigned to American art institutions may be claimed during the 5-year period beginning

10 years after the death of the artist represented, the following paintings, recalled for action of the Smithsonian Art Commission at its meeting December 5, 1961, were returned for permanent accession by the institutions to which they had been assigned.

No. 34. Captain Taylor's Sister, by Ernest L. Ipsen, N.A. (1869-1951); purchased in 1923 for \$2,000 and assigned to the Dallas Art Association, Dallas, Tex.

No. 60. Still Life, by Frank W. Benson, N.A. (1862-1951); purchased in 1926 for \$10,000 and assigned to the California Palace of the Legion of Honor, San Francisco, Calif.

The following paintings, purchased by the Council of the National Academy of Design since the last report, have been assigned as follows:

<i>Title and artist</i>	<i>Assignment</i>
246. Landscape, Bridgehampton, by Paul Resika (1928-).	St. Gregory College, Shawnee, Okla.
247. The Sleeping Porch, by Frank Furnham (1926-).	Smith College Museum of Art, Northampton, Mass.
248. Douarnenez, by Miriam Broudy (1905-).	Everhart Museum, Scranton, Pa.
249. Reflections, by Adolf Konrad (1915-).	Assignment pending.
250. Elements of Construction, by Robert W. Daley (1922-).	Indiana University, Bloomington, Ind.
251. City of Churches, by Zoltan Sepeshy (1898-).	Rhode Island School of Design, Providence, R.I.
252. Lake Erie Shore, by Werner Groshaus (1913-).	Davenport Municipal Art Gallery, Davenport, Iowa.
253. Thanksgiving, by Salvatore Lascari (1884-).	Bruce Museum, Greenwich, Conn.
254. High Pastures (watercolor), by Warren Baumgartner (1894-).	Assignment pending.
255. Housing Development (watercolor), by E. Ingersoll Maurice (Mrs.) (1901-).	University of Kansas, Lawrence, Kans.
256. Figures in the Sunlight (watercolor), by John E. Costigan (1888-).	Rochester Memorial Art Gallery, Rochester, N.Y.
257. Thaw (watercolor), by Robert W. Bode	T. L. Wright Art Center, Beloit College, Beloit, Wis.
258. The Fascination of Toledo (watercolor), by Carol M. Grant.	Assignment pending.
259. Walls of Georgetown (watercolor), by Ralph Avery (1906-).	Witte Memorial Museum, San Antonio, Tex.
260. Porlock Weir (watercolor), by Donald Teague (1897-).	Mills College, Oakland, Calif.
261. Turn Around (watercolor), by Ed Graves (1917-).	Assignment pending.
262. Story Teller (watercolor), by Frederick Wong (1929-).	Assignment pending.
263. Monday Morning (watercolor), by Herb Olsen (1905-).	Assignment pending.
264. Evening by the Seashore (watercolor), by Mong Q. Lee (1923-1960).	Des Moines Art Center, Des Moines, Iowa.

SMITHSONIAN TRAVELING EXHIBITION SERVICE

In addition to 108 exhibits held over from previous years as indicated below, 27 new shows were introduced. The total of 135 shows was circulated to 316 museums in the United States. Two exhibitions were prepared for circulation abroad.

EXHIBITS CONTINUED FROM PRIOR YEARS

- 1955-56*: Chinese Ivories from the Collection of Sir Victor Sassoon.
- 1956-57*: Japan II by Werner Bischof; and The World of Edward Weston.
- 1957-58*: The American City in the 19th Century; Recent American Prints; Japanese Woodblock Prints; Theatrical Posters of the Gay Nineties; Contemporary Portuguese Architecture; Nylon Rug Designs; Burmese Embroideries; Japanese Dolls; Thai Painting; The Anatomy of Nature; Photographs of Sarawak; Glimpses of Switzerland; Drawings by European Children; Photographs of Angkor Wat; and Pup, Cub and Kitten.
- 1958-59*: Advertising in 19th Century America; The Engravings of Pieter Brueghel the Elder; Charles Fenderich—Lithographer of American Statesmen: Contemporary Religious Prints from the Sloniker Collection; Religious Subjects in Modern Graphic Arts; Contemporary French Tapestries I; Our Town; Stone Rubbings from Angkor Wat; Shaker Craftsmanship; Children's Paintings from India; and A Child Looks at the Museum.
- 1959-60*: The Art of Seth Eastman; Contemporary Greek Painting; Early Drawings of Toulouse-Lautrec; Watercolors and Drawings by Thomas Rowlandson; Prints and Drawings by Jacques Villon; American Prints Today; Brazilian Printmakers; Lithographs of Fantin-Latour; Arts and Cultural Centers; Bernard Ralph Maybeck; Enamels; Eskimo Art; Contemporary French Tapestries II; Story of American Glass; Bazaar Paintings from Calcutta; Gandhara Sculpture; Sardinian Crafts; Arctic Riviera; Photographs by Robert Capa I; Photographs by Robert Capa II; Outer Mongolia; Pagan; Portraits of Greatness; Contrasts; Paintings by Young Africans; Japan I; and Greek Costumes and Embroideries.
- 1960-61*: Work by Torres Garcia; Three Swiss Painters; The Technique of Fresco Painting; Folk Painters of the Canadian West; Paintings by Ch'i Pai-Shih; Birds of Greenland; A Tribute to Grandma Moses; The America of Currier and Ives; View 1960; Drawings by Sculptors; The Graphic Art of Edvard Munch; German Color Prints; Eskimo Graphic Art; Civil War Drawings I; Civil War Drawings II; American Art Nouveau Posters; American Industry in the 19th Century; America on Stone; Designed in Okinawa; Okinawa—Continuing Traditions; Prints by Munakata; Contemporary Japanese Drawings; Japan: Design Today; The Spirit of the Japanese Print; Americans—A View from the East; Swiss Industrial Architecture; Contemporary Swedish Architecture; Mies van der Rohe; Irish Architecture of the Georgian Period; One Hundred Years of Colorado Architecture; Brasilia—A New Capital; Scenic Designers Offstage; Design in Germany Today; Fibers, Tools and Weaves; Designed for Silver; Batiks by Maud Rydin; American Textiles; The Seasons, color photographs by Eliot Porter; The World of Werner Bischof; The Image of Physics; Charles Darwin: The Evolution of an Evolutionist; The Beginnings of Flight; The Magnificent Enterprise—Education Opens the Door; The New Theatre in Germany; Tropical Africa I; Tropical Africa II; Symphony in Color; Paintings and Pastels by Children of Tokyo; Children's Art from Italy; Hawaiian Chil-

1960-61—Continued

dren's Art; Designs by Children of Ceylon; and Children's Paintings from Chile.

EXHIBITIONS INITIATED IN 1962

Archeology

<i>Title</i>	<i>Source</i>
Tutankhamun's Treasures-----	Department of Antiquities, United Arab Republic; United Arab Republic Embassy.

Paintings and Sculpture

14 Americans in France-----	American Cultural Center, Paris.
George Catlin, Paintings and Prints---	Smithsonian Institution.
Physics and Painting-----	Index of American Design, National Gallery of Art.
UNESCO Watercolor Reproductions----	UNESCO in Paris; Twentieth Century Fund.

Drawings and Prints

Belgian Drawings-----	Ministère de l'Instruction Publique; M. J. van Lerberghe; Belgian Embassy.
The Lithographs of Childe Hassam----	Smithsonian Institution; National Gallery of Art; Boston Public Library; Carnegie Institute in Pittsburgh; Detroit Institute of Art; Philadelphia Museum of Art; and others.
Contemporary Italian Drawings-----	Traveling Exhibition Service, Smithsonian Institution.
John Baptist Jackson-----	Smithsonian Institution, Jacob Kainen; museums in the United States and abroad.
Contemporary Swedish Prints-----	National Museum; Galleri Brinken, Stockholm; E. Maurice Bloch, Curator, Grunwald Graphic Arts Foundation, UCLA Galleries.
Tiepolo Drawings-----	Victoria and Albert Museum, London; British Government.

Oriental

Japanese Posters-----	Collection of Library of Congress.
The Face of Viet Nam-----	Raymond Cauchetier, photographer, Paris.

Architecture

Architectural Photography (New Edition).	American Institute of Architects; Architectural Photographers Association.
Le Corbusier—Chapel at Ronchamp----	American Institute of Architects.
The Family, The Neighborhood, The City.	United Neighborhood Houses; National Federation of Settlements and Neighborhood Centers.

Design and Crafts

<i>Title</i>	<i>Source</i>
100 Books from the Grabhorn Press-----	Edwin and Robert Grabhorn Collection, private owners.
Wisconsin Designer-Craftsmen-----	Milwaukee Art Center, Mrs. Meg Torbert; Wisconsin Designer-Craftsmen.

Photography

Caribbean Journey-----	Fritz Henle, photographer, New York City.
The Swedish Film-----	Swedish Institute, Stockholm, Dr. Tore Tallroth, Director; Embassy of Sweden.
The Story of a Winery-----	Paul Masson Vineyards; Ansel Adams and Pirkle Jones, photographers.

Science

This Is the American Earth-----	Sierra Club of San Francisco.
The Hidden World of Crystals-----	Merck Sharp & Dohme Research Laboratories.
Hummingbirds -----	American Museum of Natural History, New York City.

Children's Art

Brazilian Children's Art-----	Alvares Pentecosta Foundation, São Paulo; Escolinhas de Arts do Brazil, Rio de Janeiro; Brazilian Embassy.
Children Look at UNESCO-----	School Art League, New York; Commercial Museum, Philadelphia.
My Friends-----	Arts and Activities Magazine; Galerie St. Etienne.

STAFF ACTIVITIES

An increasing amount of staff time is devoted to reorganization and planning in preparation for removal to the Old Patent Office Building. Adaptation of NCFAs collections and functions to the space allotted, certain areas of which must be shared jointly with the newly authorized National Portrait Gallery, demands much of the director's time. Recommendations of many features essential to modern gallery operation are required in the conversion of a historic structure erected a century ago. Assistance of the staff of the Smithsonian, especially in providing the services of consultants, Eugene Kingman for exhibition techniques, Dr. Anthony Garvan for historical research on the Old Patent Office Building, and Dr. Richard H. Howland for architectural character of interior design, has been much appreciated. Professional advice from construction specialists and staff members of the architectural firm of Faulkner, Kingsbury & Stenhouse, has been found most helpful. Guidance of the Public Buildings Service, General Services Administration, has been indispensable.

The renovation of the Natural History Building and the removal and rehanging of between 300 and 400 other items have required relocation of storage involving packing and shipping large canvases. This has been planned and removal operations accomplished with the aid of the buildings management department of the Institution. That department has also given the NCFa generous shop assistance in moving the A. P. Barney Lending Collection to new storage and has provided excellent cooperation, often at short notice, in the installation of foyer exhibits, such as Okinawa: Textiles and Traditions. The assistance of Mr. and Mrs. Istvan P. Pfeiffer was helpful in completing this special show. Keyes Porter has contracted to cross-index accessions and otherwise amplify the usefulness of cataloged information. Until illness prevented, George C. Groce was engaged in a study of the collections to determine most essential needs in future augmentation. The staff inventoried Barney Collection pictures on loan to Federal agencies, noting condition and obtaining information essential to the care of the collection.

In addition to the approximately 20,000 requests for information received by mail and telephone, inquiries made in person at the office numbered 1,600. In all, 189 works of art were examined by the director and curator.

Special catalogs were published for the following traveling exhibitions: Tutankhamun's Treasures; Tiepolo Drawings; Belgian Drawings; and Drawings by Sculptors. Informative folders were printed for traveling shows in the following categories: Natural History and Science; Oriental Art Exhibitions; History Exhibitions; Photography Exhibitions; and Children's Art Exhibitions. A special catalog of Traveling Exhibitions for 1962-63 was also published.

Contracts were let for the relining and restoring by Harold F. Cross of the following: *Roses* by Walter Shirlaw; *Sheepyard, Moonlight*, by H. L. Walker; *Portrait of Dr. Stejneger* by Bjorn Egeli; *Brother and Sister* by Abbott H. Thayer; *Nymph and Water Babies at Play* by William Baxter Closson; *Angel* by Abbott H. Thayer; *Autumn* by Bruce Crane; *Rome and the Campagna* by Richard Wilson; *Visit to the Tomb of Washington* by Thomas P. Rossiter; *A Load of Brush* by Louis Paul Dessar; 11 paintings by Edmund C. Tarbell entitled *President Wilson*, *General George Leman*, *Mary Reading*, *Herbert Hoover*, *Self Portrait*, *Mr. Frick and Daughter Helen*, *Mrs. Tarbell as a Girl*, *Margery and Little Edmund*, *Marshal Foch*, *Roses in Blue Vase*, and *In the Orchard*; and *Mrs. Elizabeth Boucher* attributed to John S. Copley.

Henri G. Courtais contracted for renovation of the following paintings: *Self Portrait* by Sir Thomas Lawrence; *Archibald Skirving* by Sir Henry Raeburn; *Head of Old Man* by Jose de Ribera; *Mrs. Towry*

by Sir Thomas Lawrence; Edmund Waller by Gerard van Soest (formerly attributed to Dobson); Marine by Richard Parkes Bonington; Virgin and Child by Bernard Van Orley; Ralph Cross Johnson by Ernest Moore; Duke of Sussex by Sir William Beechey; Canal Scene by Francesco Guardi; Water Scene by Francesco Guardi; Landscape by Thomas Barker; and Young Girl attributed to Drost.

SPECIAL EXHIBITIONS

July 1 through 23, 1961. Ninth Interservice Photography Contest, sponsored by the Armed Forces of the United States; consisted of photographs by members of the armed services.

July 29 through August 27, 1961. The Magnificent Enterprise: Education Opens the Door, sponsored by the Vassar Club of Washington, D.C., and circulated by the Smithsonian Traveling Exhibition Service; consisted of 200 photographs, engravings, lithographs, posters, and drawings.

September 8 through October 18, 1961. The Eighth International Exhibition of Ceramic Art, sponsored by the Kiln Club of Washington, D.C., and installed by the Division of Ceramics and Glass; consisted of 426 items, including 255 objects from the United States and 171 objects from 16 foreign countries. A catalog was privately printed.

October 21 through November 9, 1961. Sixty-eighth Annual Exhibition of the Society of Washington Artists, consisting of 74 paintings and 20 sculptures. A catalog was privately printed.

November 19 through December 7, 1961. Twenty-fourth Metropolitan Art Exhibition, sponsored by the American Art League; consisted of 134 paintings and 30 sculptures. A catalog was privately printed.

December 15, 1961, through January 7, 1962. Paintings by George Catlin, Artist and Historian of the American Indian; consisted of 115 items including 90 paintings (recently restored by Henri G. Courtais), 13 colored lithographs, 7 photographs, and 3 miniatures from the collections of the Smithsonian Institution, together with 2 photographs loaned by the Gilcrease Institute of American History and Art. A multilithed catalog was printed. (Thirty-five paintings and 12 lithographs from this exhibition were selected for circulation by the Smithsonian Traveling Exhibition Service.)

December 16, 1961, through January 7, 1962. Americans—A View from the East, circulated by the Smithsonian Traveling Exhibition Service; consisted of 42 Japanese woodblock prints.

January 14 through February 4, 1962. Twenty-fourth National Exhibition of the Society of Washington Printmakers; consisted of 165 prints. A catalog was privately printed.

January 14 through February 4, 1962. The Character of Korea, sponsored by the Embassy of Korea and circulated by the American-Korean Foundation; consisted of 55 photographs by Wallace C. Marley. An illustrated catalog and explanatory brochure were privately printed.

February 11 through March 4, 1962. An exhibition of the Ilke and Jacoby Lace Collection from St. Gall, Switzerland, sponsored by the Ambassador of Switzerland and circulated by the Swiss Fabric and Embroidery Center, New York City. An illustrated brochure was privately printed.

March 11 through 29, 1962. Sixty-fourth Annual National Exhibition of the Washington Water Color Association; consisted of 104 watercolors. A catalog was privately printed.

March 29 through 31, 1962. An exhibition by Ikebana International, consisting of Japanese flower arrangements by Sofu Teshigahara.

April 8 through 29, 1962. Twenty-first Biennial Art Exhibition sponsored by the National League of American Pen Women; consisted of 74 items, including paintings, drawings, and graphic arts. A catalog was privately printed.

April 16 through 29, 1962. The Hidden World of Crystals, circulated by the Smithsonian Traveling Exhibition Service; consisted of 25 microphotographs of drugs and chemicals by Jack Kath of Merck Sharp & Dohme Research Laboratories.

May 6 through 27, 1962. Twenty-ninth Annual Exhibition of the Miniature Painters, Sculptors and Gravers Society of Washington, D.C.; consisted of 157 items. A catalog was privately printed.

May 5 through 27, 1962. Okinawa—Textiles & Traditions, under the auspices of the Cultural Properties Committee of the Government of the Ryukyu Islands and circulated by the Smithsonian Traveling Exhibition Service; consisted of 164 items, including scrolls, lacquer, ceramics, toys, inryo and netsuke, and textiles (kimonos, tisaji, furoshiki, fabric samples, and bolts). Oriental flower displays were arranged daily by members of Ikebana International.

May 5 through 27, 1962. Birds of Greenland, sponsored by the Ambassador of Denmark and Countess Knuth-Winterfeldt and circulated by the Smithsonian Traveling Exhibition Service; consisted of 52 watercolors by Gitz-Johansen and a book, *The Birds of Greenland* by Finn Salomonsen, containing reproductions of paintings by Gitz-Johansen. A brochure was privately printed.

June 3 through 21, 1962. Works of Government Artists sponsored by the Society of Federal Artists, consisted of 153 items.

June 3 through 24, 1962. An exhibition of color woodcuts by John Baptist Jackson (1701–1780), circulated by the Smithsonian Traveling Exhibition Service; consisted of 40 woodcuts and a book, *John Baptist Jackson: 18th Century Master of Color Woodcuts*, by Jacob Kainen, U.S. National Museum Bulletin 222.

Respectfully submitted.

THOMAS M. BEGGS, *Director.*

DR. LEONARD CARMICHAEL,
Secretary, Smithsonian Institution.

Report on the Freer Gallery of Art

SIR: I have the honor to submit the 42d annual report of the Freer Gallery of Art, for the year ended June 30, 1962.

Archibald Gibson Wenley, second director of the Freer Gallery of Art, died on February 17, 1962. He was born May 5, 1898, in Ann Arbor, Mich., and graduated from the University of Michigan in 1921, and the Library School of the New York Public Library in 1923. In that same year, Mr. Wenley joined the staff of the Freer Gallery as a trainee sinologist, and participated in the archeological surveys conducted in China under the joint sponsorship of the Museum of Fine Arts, Boston, and the Freer Gallery. He studied under Freer auspices in Paris for 3 years at the *École des Langues Orientales Vivantes* and the *Institut des Hautes Études Chinoises*; and in Kyoto, Japan, for 2 years.

Mr. Wenley formally joined the staff of the Freer Gallery in 1931 as associate in research. He possessed a firm foundation in the languages, history, and culture of China and Japan; and, when John Ellerton Lodge, the first director of the Freer Gallery, died in December 1942, Mr. Wenley was appointed as director. He served on numerous committees through the years, including the Smithsonian Art Commission; member of the Board of United States Civil Service Examiners at Washington, D.C., for the Smithsonian Institution; member, the Visiting Committee, Dumbarton Oaks Research Library and Collection; research professor of Oriental art, University of Michigan; trustee, Textile Museum of the District of Columbia; trustee, Hermitage Foundation, Norfolk, Va.; chairman of the Louise Wallace Hackney Scholarship Committee of the American Oriental Society; president, Cosmos Club; and chairman, American Committee for the Japanese Government Loan Exhibition, 1953.

Archibald Wenley was a distinguished scholar and was particularly known for his contributions to the study of archaic Chinese bronzes. He contributed articles and reviews to many journals, and in 1946, in collaboration with Dr. John A. Pope, who now succeeds him as director, published *A Descriptive and Illustrative Catalogue of Chinese Bronzes Acquired during the Administration of John Ellerton Lodge*. In 1943 he brought the Freer Fellowship program with the University of Michigan into reality and expanded the research facilities and publication programs of the Gallery. One result was the inauguration of the monograph series *Ars Orientalis*, a scholarly quarto journal of the arts of Islam and the East published jointly

by the Smithsonian and the university. Altogether, Mr. Wenley was associated with the Gallery for more than 30 years, and his constructive influence on the progress, growth, and administration of the organization will be felt for many years to come.

THE COLLECTIONS

Under the terms of paragraph 4 of the first codicil of the last will and testament of the late Charles Lang Freer, the following five objects were presented by Mrs. Eugene Meyer:

BRONZE

- 61.30. Chinese, Chou dynasty. *Tsun*; stylized dove; four gold characters on crest. Height: 0.265; length: 0.200; width: 0.135.
- 61.31. Chinese, Chou dynasty. *Yi* (or *i*); snake motif. Height: 0.205; length: 0.320; width: 0.177.
- 61.32. Chinese, Chou dynasty. *Hu*; inlaid with silver, and malachite. Damaged. Height: 0.526; width (with handles): 0.278; width: 0.255.
- 61.33. Chinese, Shang dynasty. *Kuang*; design incorporates many stylized birds and animals. No inscription. Height: 0.314; length: 0.313; width: 0.142.

PAINTING

- 61.34. Chinese, Sung (Chin) dynasty, late 12th or early 13th century, by Li Shan. "Wind and Snow in the Fir Pines." Ink and light colors on silk; signature, 1 inscription, and 25 seals on painting; label, 5 colophons, and 50 seals on mount. Makimono (painting): height 0.297; width: 0.792; (overall) height: 0.312; width: 10.032. (Illustrated.)

Twenty-seven objects were added to the collections by purchase as follows:

METALWORK

- 62.1. Persian, Sasanian, first half of 6th century A.D. Silver bowl partially gilt, showing King Kavadh I hunting ibex and gazelle. Dark purplish gray incrustation of silver chloride on silver background; traces of green copper corrosion products. Small breaks, with some pieces missing on lower left. Height: 0.024; diameter, 0.191. (Illustrated.)

PAINTING

- 62.14. Chinese, Ch'ing dynasty, 18th century, by Huang Shen (1687–after 1768). Old man gazing at branches of magnolia in a vase. Ink and light red-brown color on paper. Inscription and two seals of the artist on the painting. Height: 1.020; width: 0.400.
- 62.5. Chinese, Ch'ing dynasty, dated 1706, by Wang Yüan-chi (1642–1715). River landscape; in the manner of Huang Kung-wang. Ink and color on paper. Inscription and four seals of the artist on the painting, along with seven collectors' seals. Label, with one seal, on the reverse of the mounting. Kakemono: height: 0.977; width: 0.592.
- 62.4. Chinese, Ch'ing dynasty, dated 1704, by Wu Li (1632–1718). Landscape: "Streams and Mountains after Rain"; in the manner of Huang Kung-wang. Ink on paper. Inscription and three seals of the artist on the painting, along with three collectors' seals. Label on reverse of the mounting. Kakemono: height: 1.310; width: 0.310.
- 62.2. Japanese, Kamakura period, 14th century, Buddhist school. *Kako Genzai*

- Ingakyō* (Sutra of Cause and Effect). Ink and color on paper; fragment of a handscroll. Makimono: height: 0.269; width: 0.989.
- 62.3. Japanese, Kamakura period, 14th century, Yamatoe school. *Hōnen Shōnin Gyōjō Ezu* (Illustrated Deeds of the Priest Hōnen). Ink and color on paper; fragment of a handscroll. Makimono: height: 0.406; width: 0.727.
- 62.6- Japanese, Kamakura period, 14th century, Yamatoe school. Three illustrations from: *Shōtoku Taishi Eden* (An Illustrated History of Prince Shōtoku). "The Archery Contest," "The Flying Tiles," and "Shōtoku Taishi on Horseback." Ink and color on paper; fragments from a handscroll. Makimono: height: 0.347; average width: 0.460-0.505.
- 62.8. Japanese, Kamakura period, 14th century, Yamatoe school. *Kōnin Shōnin Eden* (An Illustrated Biography of the Priest Kōnin). Ink and color on paper; fragment from a handscroll. Makimono: height: 0.336; width: 0.559.
- 62.9. Japanese, Kamakura period, 14th century, Yamatoe school. Portrait of Prince Shōtoku (aged 14) as the Budhisattva Jizō. Ink and color on silk. Kakemono: height: 1.247; width: 0.689.
- 61.23- Japanese, Ashikaga period, Yamatoe school. A pair of illustrations from: 61.24. *Geppōji Kenritsu Engi* (History of the Founding of the Geppōji Temple). Text by Kinnatsu; dated 1495. Ink, color and gold on paper. Makimono: height: 0.345; average width: 10.660-11.377.
- 62.19 Japanese, Edo period, Ukiyoe school, by Shorakusai (18th-19th century). Theatre scene from "The Tale of the Brothers Soga"; man and woman in snowy landscape. In color on paper. Makimono: height: 0.254; width: 0.520.
- 61.25 Japanese, Edo period, 18th century, Ukiyoe school, by Tsukioka Settei (1710-1786). "Woman with a Puppet." Ink, color and gold on paper. Kakemono: height: 0.989; width: 0.269. (Illustrated.)
- 62.10- Japanese, Edo period, early, Unkoku school, by Unkoku Tōnin (early 17th 6212. century). A set of three screens; Birds in Landscape. Ink, color and gold leaf; *fusuma* (sliding doors) now mounted as two-fold screens. Average: height: 1.605; width: 1.680.

POTTERY

- 61.27. Chinese, T'ang-Sung dynasty, "gray ware" of *yueh* type. Tall vase with slender neck and wide mouth; loops on shoulder; cover. Clay: hard gray porcellaneous stoneware. Glaze: clear. Decoration: none. Height: 0.326; diameter: 0.152.
- 62.17. Chinese, Ming dynasty, early 16th century. Dish with plain rim. Clay: fine white porcelain. Glaze: transparent, glossy. Decoration: dragons among lotus scrolls inside and out, painted in underglaze blue. Mark of four Mongolian (*Phags-pa*) characters in blue on base. Height: 0.047; diameter: 0.216.
- 62.16. Chinese, Ming dynasty, Chia-ching period (1522-1566). Vase of *kuan* shape. Clay: fine white porcelain. Glaze: transparent, glossy. Decoration: floral scrolls, and boys playing in a garden, painted in underglaze blue. Six-character Chia-ching mark in blue on base. Height: 0.267; diameter: 0.320.
- 62.20. Japanese, Momoyama period, *shino* ware. Dish on three feet, so-called "cake dish," with four-lobed, upturned rim. Clay: coarse buff-gray stoneware. Glaze: thick, bubbly, uneven, grayish. Decoration: plum blossom sprays in iron brown. Height: 0.055; diameter: 0.169.

- 61.26. Japanese, Edo period (1615-1867), *imari* ware. Jar of *kuan* shape. Clay: white porcelain. Glaze: clear, slightly bluish. Decoration: three plant groups in underglaze blue. Height: 0.237; diameter: 0.220.
- 62.15. Japanese, Edo period (late Genroku), *imari* ware. Dish with ten-lobed rim. Clay: white porcelain. Glaze: transparent. Decoration: paulonia and diaper pattern painted in underglaze blue, overglaze enamel colors and gold; waves and plum blossoms outside *Daikon* in blue on base. Height: 0.057; diameter: 0.343.
- 62.18. Japanese, Edo period (late Genroku), *imari* ware. Jar of globular form, with cover and small handle on top. Clay: white porcelain. Glaze: transparent. Decoration: floral patterns, roundels, and diaper patterns in underglaze blue and overglaze enamels and gold. *Daikon* in overglaze red and gold on base. Height: 0.140; diameter: 0.133.
- 61.29 Japanese, Edo period (1615-1867), Kakiemon ware. Deep bowl of decagonal shape with flaring rim and upturned lip. Clay: white porcelain. Glaze: clear. Decoration: hydrangeas and phoenixes in overglaze enamels; dragon in slip inside; brown rim. Height: 0.101; diameter: 0.210.
- 61.28. Japanese, Edo period (1615-1867), by Kenzan. Teabowl; round with smooth surface and finely cut thin foot; signed Kenzan. Box. Clay: fairly fine grained brownish buff stoneware. Glaze: clear, finely crackled. Decoration: pine trees with blue needles on ground of white slip, on one side inside, and on the other outside. Height: 0.066; diameter: 0.133. Box: height: 0.124; length: 0.161; width: 0.161.

REPAIRS TO THE COLLECTIONS

Thirty-two Chinese, Japanese, and Indian objects were restored, repaired, or remounted by T. Sugiura, Oriental picture mounter. F. A. Haentschke, illustrator, remounted 73 Indian, Persian, and Arabic paintings. Repairs and regilding of 16 frames for American paintings were done outside the Gallery.

CHANGES IN EXHIBITIONS

Changes in exhibitions amounted to 523, which were as follows:

American art:		Japanese art:	
Oils -----	55	Gold -----	2
Prints -----	34	Lacquer -----	12
Chinese art:		Paintings -----	66
Bronze -----	29	Pottery -----	20
Cloisonné -----	1	Sculpture -----	3
Ivory -----	4	Near Eastern art:	
Jade -----	40	Bookbinding -----	5
Lacquer -----	3	Glass -----	6
Paintings -----	25	Jade -----	2
Pottery -----	50	Manuscripts -----	1
Christian art:		Metalwork -----	37
Crystal -----	2	Paintings -----	20
Glass -----	6	Pottery -----	35
Gold -----	20		
Manuscripts -----	43		
Stone sculpture -----	2		

LIBRARY

The library is the research unit for study of the cultures which produced the objects in the collections. The reading room is open to the public Monday through Friday, and 659 college and university students as well as specialists made constant use of the reference materials. No statistics are kept of the use made by the staff or the Freer Fellows and Hackney Scholars who are studying at the Gallery. The need for additional space for both librarians and readers is increasing constantly.

During the year 870 acquisitions (by title) were added to the library; 248 of these were by purchase and 622 by exchange and gift. Outstanding gifts were: 155 titles of books, which supplied many reference books difficult to find, from the library of A. G. Wenley; 36 rare picture books, the gift of Lincoln Kirstein; a copy of *Chūgoku kinseki tōji zukan* (Old Chinese art), the gift of T. Asano and T. Misugi; a rare woodblock print of an 11-headed Kannon of the early Kamakura period (13th century), the gift of R. Hosomi of Osaka, Japan. The outstanding purchase was a copy of *Chieh tzu yüan hua chuan* (Mustard seed garden painting manual), a Japanese recut edition of 1812-17.

The year's record of cataloging included a total of 926 entries of which 485 analytics were made and 283 new titles of books, pamphlets, and microfilms were cataloged. Additions to the continuations of sets of books numbered 158, and 4,815 cards were added to the catalog.

The slide collection was transferred to the library in February 1962. Mrs. Roberta Handler joined the library staff as slide librarian. New equipment for housing the slides was purchased, a manual of procedure outlined, and the work of binding, classification, and labeling has proceeded. During the year 1,884 slides were bound and labeled, and 3,579 were lent.

There were 202 requests for bibliographic information by telephone and letters. Two bibliographies were prepared for publication, and a bibliography of the works of each member of the staff.

Librarians from other museums visited the library for exchange of professional knowledge. Mr. Hewson of Gallaudet College, accompanied by his class of 12 library science students, spent some time at the Gallery observing library methods.

The library staff continued active in the professional associations. Mrs. Hogenson and Mrs. Handler attended the annual conference of the Special Libraries Association in Washington, May 1962. Mrs. Usilton attended the American Library Association in Cleveland, July 1961, and at Miami Beach, Fla., June 1962.

PUBLICATIONS

No publications were issued by the Freer Gallery during this fiscal year.

Publications of staff members were as follows:

- CAHILL, JAMES F. *The art of Southern Sung China—Asia House, 1962*. New York, Asia Society, 1962. 103 pp., illus.
- . "The return of the absent servants: Chou Fang's *Double Sizes* restored." *Archives of the Chinese Art Society of America*, vol. 15 (1961), pp. 26–28 incl. illus.
- . Review of "Chinese pictorial art, as viewed by the connoisseur," by R. H. van Gulik. *Journal of the American Oriental Society*, vol. 81 (1961), pp. 448–451.
- ETTINGHAUSEN, RICHARD. *Arab painting*. Geneva, Skira, 1962. 208 pp. mount. illus. (part col.) map. (Treasures of Asia.)
- . Review of "Turkish painting," edited with introduction and notes by Emel Esin. *Artibus Asiae*, vol. 24 (1961), p. 73.
- . *Persian miniatures in the Bernard Berenson collection*. Milano, Officine Grafiche Ricordi, 1961. 6 pp., 12 pls., each with descriptive letterpress.
- GETTENS, R. J. "Mineral alteration products on ancient metal objects," in *Proceedings of the IIC Rome Conference, 1961*, pp. 171–174.
- . "Proposal for a handbook on analysis of materials of paintings," in *Proceedings of the IIC Rome Conference, 1961*, pp. 47–50.
- . "IIC and ICOM: Conservation meeting in Rome and Barcelona," in *Museum News* (Washington, D.C.), vol. 40, pp. 36–39.
- POPE, JOHN A. Review of "Bronze culture of ancient China," by William C. White. *Ars Orientalis*, vol. 4 (1961), pp. 432–440, plate.

PHOTOGRAPHIC LABORATORY AND SALES DESK

The photographic laboratory made 11,461 items during the year as follows: 8,718 prints, 1,222 negatives, 1,605 color slides, and 76 color film sheets. At the sales desk 50,570 items were sold, comprising 4,496 publications and 46,074 reproductions (including postcards, slides, photographs, reproductions in the round, etc.).

BUILDING AND GROUNDS

The exterior of the building appears to be sound and in good condition. Refinishing of the bronze surrounding the court and on the exterior of the north door is underway. The roof is scheduled to be repaired this summer; also the sidewalk in front of the building is to be removed and replaced to conform with the work now being done on the 12th Street underpass.

In the interior, the limestone door frames of the exhibition galleries are being cleaned. All concrete floors were painted and given a protective coat of wax.

The doors leading from the main office to the library were reworked and fitted with glass.

The sales desk at the north entrance was completely refinished on location.

Three hundred twenty seats were installed in the Auditorium.

In general, the courtyard planting is doing well. Four small boxwoods and four azaleas were replaced. Two cotoneasters were replaced with *Ilex* var. *globosa*. A complete new listing and diagram of all plants was made for the Freer Gallery of Art pamphlet. The plantings at the fountain have been made as usual. Each has made a splendid showing in its respective season. Lantana was set out for the summer and is beginning to flourish.

ATTENDANCE

The Gallery was open to the public from 9 to 4:30 every day except Christmas Day. The total number of visitors to come in the main entrance was 130,597. The highest monthly attendance was in April, 21,929.

There were 2,589 visitors who came to the Gallery office for various purposes—for general information, to submit objects for examination, to consult staff members, to take photographs or sketch in the galleries, to use the library, to examine objects in storage, etc.

AUDITORIUM

The series of illustrated lectures was continued as follows:

1961

- October 10. Dr. Noel Barnard, Australian National University, Canberra, Australia, "Bronze Casting in Ancient China," Attendance, 145.
- November 7. Dr. Eleanor Consten von Erdberg, Rheinisch-Westphalische Technische Hochschule, Aachen, Germany, "The Japanese House: A Pattern of Simplicity." Attendance, 294.

1962

- January 16. Prof. Oswald Sirén, Keeper Emeritus of Pictures and Sculptures, National Museum, Stockholm, Sweden, "True and False in Chinese Sculpture." Attendance, 255.
- February 13. Prof. Willy Hartner, Johan Wolfgang Goethe-Universitat, Frankfurt, Germany, "Astrology on Persian Metal Work." Attendance, 206.
- March 13. William Watson, British Museum, London, England, "A New Find of Chinese Bronzes with Human Figurines." Attendance, 183.
- April 3. Dr. James C. Harle, Ashmolean Museum, Oxford, England, "The Art and Architecture of South India." Attendance, 215.

Outside organizations used the auditorium as follows:

The Washington Film Society showed the following films:

- "La Retour" and "Under the Roofs of Paris." October 6. Attendance, 150.
- "Storm over Asia." October 13. Attendance, 167.
- "Under the Black Mask" and "United Nations Week." October 20. Attendance, 119.

"Berlin, Symphony of a Great City" and "Arms and the League."	October 27. Attendance, 155.
"Cabinet of Dr. Caligari."	November 3. Attendance, 154.
"Carnival in Flanders."	November 17. Attendance, 190.
"Vampyr" and "Sunday by the Sea."	November 24. Attendance, 158.
"Seven Samurai."	December 1. Attendance, 193.
"Les Mistons," "Meshes of the Afternoon," and "The Very Eye of Night."	December 8. Attendance, 122.
"El" and "City Lights."	December 15. Attendance, 112.
"Ten Days that Shook the World."	December 22. Attendance, 170.
"The Passion of Joan of Arc."	March 22. Attendance, 132.
	March 23. Attendance, 155.
"Mother" and "Chess Fever."	April 5. Attendance, 137
	April 6. Attendance, 231.
"Tolerance."	May 3. Attendance 153.
	May 4. Attendance, 239.
"Duck Soup," "Primary," and "Musical Poster No. One."	May 10. Attendance, 106.
	May 11. Attendance, 179.
"Italian Straw Hat."	May 17. Attendance, 114.
	May 18. Attendance, 208.
"Thunder over Mexico" and "Mexican Bus Ride."	May 24. Attendance, 96.
	May 25. Attendance, 206.
"Variety" and "The Knockout."	June 7. Attendance, 91.
	June 8. Attendance, 127.
"The Gold Rush" and "Night at the Peking Opera."	June 21. Attendance, 247.
"Eva Wants to Sleep" and "Sunday."	June 28. Attendance, 214.

The U.S. Department of Agriculture held meetings as follows:

Marketing Division.	October 16. Attendance, 176.
	October 17. Attendance, 197.
	October 18. Attendance, 117.
	October 19. Attendance, 129.
Outlook Conference.	November 14. Attendance, 82.
	November 15. Attendance, 447.
4-H Clubs. Farmers' Cooperative Service.	November 16. Attendance, 177.
	December 11. Attendance, 143.
	December 12. Attendance, 144.
	December 13. Attendance, 131.
	December 14. Attendance, 68.
Federal Extension Service.	January 9. Attendance, 185.
	January 10. Attendance, 212.
	January 12. Attendance, 92.
Agricultural Stabilization and Conserva- tion Service.	April 4. Attendance, 194.
Foreign Agricultural Service.	April 9. Attendance, 260.
	April 12. Attendance, 70.
	April 25. Attendance, 117.
	April 26. Attendance, 350.
	April 27. Attendance, 166.
	May 18. Attendance, 82.
June 6. Attendance, 91.	

June 13. Attendance, 94.

June 20. Attendance, 127.

June 27. Attendance, 96.

The Food and Drug Administration held meetings as follows:

October 18. Attendance, 119.

November 2. Attendance, 264.

December 20. Attendance, 91.

January 17. Attendance, 67.

March 21. Attendance, 78.

March 27. Attendance, 66.

April 12. Attendance, 70.

May 16. Attendance, 82.

The Washington Society, Archeological Institute of America, held illustrated lectures as follows:

Dr. Zakhy Iskander, Department of Antiquities, Cairo, Egypt: "Tutankhamun's Treasures." November 9. Attendance, 193.

Dr. J. O. Brew, Director, Peabody Museum, Harvard University: "The Drowning Sphinx: Salvage Archeology in Advance of Technical Progress in Nubia." November 30. Attendance, 143.

Japan-America Society, two recitals by Miss Miyoko Watanabe, *Kabuki* dancer, and Mr. Kimio Eto, *koto* player. December 2. Attendance, 660.

American Chemical Society.

February 8. Attendance, 51.

Washington Society, Archeological Institute of America.

February 8. Attendance, 221.

Washington Fashion Group, programs by Eleni Epstein, fashion editor, *Washington Star*.

March 5. Attendance, 275.

March 12. Attendance, 243.

March 19. Attendance, 197.

March 26. Attendance, 219.

April 2. Attendance, 198.

March 30. Attendance, 423.

Japan-America Society and Washington Film Society, two showings of Japanese film, "Jochuku" and selected short subject.

Morgan State College, lecture by Dr. Robert P. Multhauf, Department of Science and Technology, Smithsonian Institution.

April 27. Attendance, 278.

Overall total attendance in the auditorium for the year was 13,417.

STAFF ACTIVITIES

The work of the staff members was devoted to the study of new accessions, of objects contemplated for purchase, and of objects submitted for examination, as well as to individual research projects in the fields represented by the collection of Chinese, Japanese, Persian, Arabic, and Indian materials. Reports, oral and written, and exclusive of those made by the technical laboratory (listed below), were made on 10,893 objects as follows: For private individuals, 3,269;

for dealers, 1,785; for other museums, 5,839. In all, 440 photographs were examined, and 920 Oriental language inscriptions were translated for outside individuals and institutions. By request, 24 groups totaling 489 persons met in the exhibition galleries for docent service by the staff members. Five groups totaling 20 persons were given docent service by staff members in the storage rooms.

Among the visitors were 61 distinguished foreign scholars or persons holding official positions in their own countries who came here under the auspices of the Department of State to study museum administration and practices in this country.

During the year the technical laboratory carried on the following activities:

Objects examined by various methods including microscopic, microchemical, X-ray diffraction, ultraviolet light, spectrochemical analysis, and specific gravity determination:

Freer objects examined.....	140
Outside objects examined.....	113

The following projects were undertaken by the laboratory during the year:

1. For a period of 2 weeks in October and November 1961, Miss E. West worked as a guest of the Conservation Center of the Institute of Fine Arts, New York University, where she continued the spectrochemical analyses of inscribed Chinese ceremonial bronzes in the Freer collections.

2. R. J. Gettens continued as editor and Miss West as assistant editor of *IIC Abstracts* published by the International Institute for Conservation of Historic and Artistic Works, London, England.

3. Continued systematic collection of data on technology of ancient copper and bronze in the Far East.

4. Continued analysis by wet chemical methods of Chinese bronzes in the Freer collections.

By invitation the following lectures were given outside the Gallery by staff members (illustrated unless otherwise noted):

1961

September 13.	Dr. Pope, at the College Art Association, New York City, "Collecting Oriental Art in America." Attendance, 250.
September 18.	Dr. Stern, at the Kunstindustrie Museum, Copenhagen, Denmark, "Popular Painting in Tokugawa Japan." Attendance, 100.
September 25.	Dr. Cahill, at the Society for Asian Art, San Francisco, Calif., "Some Distinctions in Chinese Paintings." Attendance, 100.
September 25.	Mr. Gettens, at the International Institute for Conservation of Historic and Artistic Works, conference in Rome, Italy, "Museum Climate." Attendance, 190.
September 26.	Mr. Gettens, at the International Institute for Conservation of Historic and Artistic Works, conference in Rome, "Proposal for a Handbook on Painting Material." Attendance, 190.

1961—Continued

- September 27. Dr. Cahill, at the Oakland Art Museum, Colloquium Orientalicum. University of California, Oakland, Calif., "Some Problems in the Dating and Attribution of Chinese Paintings." Attendance, 35.
- October 4. Dr. Stern, at the Ethnographic Museum, München, Germany, "Popular Painting in Tokugawa Japan." Attendance, 25.
- October 5. Dr. Stern, at Société Suisse Japon, Zürich, Switzerland, "Popular Painting in Tokugawa Japan." Attendance, 30.
- October 6. Dr. Cahill, at the United States Department of Agriculture Overseas Club, Washington, D.C., "Chinese Art." Attendance, 75.
- October 17. Dr. Pope, at the Winterthur Museum, Winterthur, Del., "Chinese Porcelains at Home and Abroad." Attendance, 240.
- October 20. Dr. Stern, at the Musée Guimet, Paris, France, for staff members only, "Popular Painting in Tokugawa Japan." Attendance, 5.
- October 26. Dr. Cahill, at the Metropolitan Museum of Art, New York City, "Chinese Art Treasures." Attendance, 400.
- October 27. Dr. Stern, at the Museum of Asiatic Studies, Amsterdam, Holland, "Popular Painting in Tokugawa Japan." Attendance, 150.
- November 6. Dr. Cahill, at the Philadelphia Museum of Art, Philadelphia, Pa., "Some Distinctions in Chinese Paintings." Attendance, 200.
- November 7. Dr. Stern, at the Victoria and Albert Museum, London, England, "Popular Painting in Tokugawa Japan." Attendance, 250.
- November 7. Mr. Gettens, at the American Embassy, London, England, "Technical Studies of Works of Art." Attendance, 50.
- November 13. Dr. Pope, at the Alexandria Association, Alexandria, Va., "Chinese Porcelains at Home and Abroad." Attendance, 50.
- November 20. Dr. Ettinghausen, at the Center of Mid-Eastern Studies, Fogg Art Museum, Cambridge, Mass., "Pictorial Arts of the Umayyads." Attendance, 70.
- December 1. Dr. Cahill, at the American University (Seminar Group), Washington, D.C., "Chinese Painting and the Contemporary West." Attendance, 30.
- December 5. Dr. Ettinghausen, at the Institute of Fine Arts, New York University, New York City, "Opportunities for Studies and Careers in Near Eastern Art." (Not illustrated.) Attendance, 30.
- 1962
- January 7, 9. Dr. Pope, at the Museum of Fine Arts, Boston, Mass., "Chinese Art Treasures." Attendance, each day, 400; total 800.
- January 8, 9. Dr. Cahill, at Smith College, Northampton, Mass., "Contemporary Relevance of Chinese Painting to the Modern West." Attendance, each day, 750; total, 1,500.

1962—Continued

- January 12. Dr. Ettinghausen, at International Student House, Washington, D.C., "Western and Eastern Art: A Comparison." Attendance, 40.
- January 24. Dr. Stern, at the Regents' Meeting, Smithsonian Institution, "Research Contrast—Japanese Art in European Collections." Attendance, 26.
- February 2. Dr. Stern, at the Norfolk Museum of Art, Norfolk, Va., "Popular Painting in Tokugawa Japan." Attendance, 150.
- February 4. Dr. Cahill, at the Washington County Museum, Hagerstown, Md., "Chinese Art." Attendance, 150.
- February 5. Dr. Pope, at the Norfolk Museum of Art, Norfolk, Va., "Oriental Pottery." Attendance, 100.
- February 5. Dr. Cahill gave the first of 16 lectures at American University, Washington, D.C.; there were 25 students in the group.
- February 15. Dr. Pope, at the Art Institute of Chicago, Chicago, Ill., "Chinese Art Treasures." Attendance, 500.
- February 16. Dr. Pope, at The Orientals, Art Institute of Chicago, gave a gallery talk and lecture, "Chinese Art Treasures." Total attendance, 175.
- March 2. Dr. Stern, at the Norton Gallery, Palm Beach, Fla., "Popular Painting of Tokugawa Japan." Attendance, 60.
- March 20. Dr. Cahill, at the Cleveland Park Club, Washington, D.C., "Chinese Art." Attendance, 35.
- March 25. Dr. Cahill, at Asia House, New York City, "The Art of Southern Sung China." Attendance, 250.
- March 31. Dr. Ettinghausen, at the Hajji-Baba Club, New York City, "Persian and Mughal Miniatures." Attendance, 52.
- April 5. Dr. Stern, at the American Oriental Society, Harvard University, Cambridge, Mass., "A Japanese Screen Painting: Kamikaze versus Christian." Attendance, 30.
- April 9. Dr. Pope, at the Cosmos Club, Washington, D.C., "Chinese Porcelains at Home and Abroad." Attendance, 175.
- April 9, 10. Dr. Ettinghausen, at the 15th Annual Symposium on Art, Sarasota, Fla., "Persian Painting" and "Persian and Indian Painting." Attendance, respectively, 325 and 275; total, 600.
- April 18. Dr. Ettinghausen, at the University of Michigan, Department of the History of Art, Ann Arbor, Mich., "Political Themes in Early Muslim Paintings and Mosaics." Attendance, 100.
- May 3. Dr. Stern, at the Japan Society, Asia House, New York City, "A Survey of Japanese Art." Attendance, 175.
- May 9. Dr. Cahill, at the De Young Memorial Museum, San Francisco, Calif., "Chinese Art Treasures." Attendance, 400.
- May 9. Mr. Gettens, at the Abracadabra Club, Washington, D.C., "Minerals in Art." Attendance, 30.
- May 10. Dr. Ettinghausen, at the Asia Society, New York City, "Herat School of Painting." Attendance, 180.

1962—Continued

- May 11. Dr. Ettinghausen, at the Institute of Fine Arts, New York University, New York City, "Political Themes in Early Islamic Paintings and Mosaics." Attendance, 95.
- May 15. Dr. Cahill, at the De Young Memorial Museum, San Francisco, Calif., "Chinese Art Treasures," and "Chinese Figure, Bird, Flower and Animal Painting." Attendance, each lecture, 400; total, 800.
- May 16. Mr. Gettens, at the U.S. Department of Health, Education, and Welfare, Food and Drug Administration, Washington, D.C., "Analytical Problems in Archaeology." Attendance, 82.
- May 16. Dr. Cahill, at a seminar, Stanford University, Stanford, Calif., "Connoisseurship of Chinese Painting," and lecture, "Chinese Art Treasures." Attendance, respectively, 15 and 200; total, 215.
- May 17. Dr. Cahill, at the University of California, Berkeley, Calif., "Great Paintings in the Chinese Art Treasures Exhibition" and "The Contemporary Relevance of Chinese Painting." Attendance, respectively, 250 and 300.

Members of the staff traveled outside Washington on official business as follows:

1961

- July 5-8. Dr. Stern, in New York City, examined objects at dealers and in museums.
- July 8-10. Dr. Stern, in Boston, Mass., examined objects at dealers and in museums.
- July 9-15. Mrs. Usilton, Librarian, in Cleveland, Ohio, attended the meetings of the American Library Association.
- July 29. Dr. Ettinghausen, in New York City, examined objects at dealers.
- August 25-
January 8. Dr. Stern, in Europe, examined objects in museums, in private collections, and at dealers; and consulted with colleagues in various institutions of learning, which involved travel in Sweden, Denmark, Germany, Switzerland, France, Belgium, Holland, England, Scotland, Italy, and Greece.
- September 4-15. Dr. Cahill, in New Haven, Conn., and New York City, examined objects at dealers, and in private collections. He attended the International Congress of Art Historians at Columbia University, a session of the College Art Association, Biltmore Hotel, and a reception of that group at the Institute of Fine Arts, New York University. He also attended the dinner and opening of the Chinese Art Treasures Exhibition at the Metropolitan Museum of Art, and saw the exhibition of Peasant and Nomad Carpets of Asia at Asia House.
- September 13-15. Dr. Pope, in New York City, attended the dinner and opening of the Chinese Art Treasures Exhibition at the Metropolitan Museum of Art, and examined objects at dealers.

1961—Continued

- September 9–
November 25. Mr. Gettens, in Europe, attended meetings of conference of the International Institute for Conservation of Historic and Artistic Works, in Rome, Italy; and meetings of the International Council of Museums, in Barcelona, Spain, where he read a paper, "Report on the Study of Metallic Antiquities." He traveled extensively in Italy, Spain, Greece, Turkey, Switzerland, France, Belgium, and England, where he examined antiquities in various museums and private collections; visited various archeological sites, and historical locations and monuments.
- October 17–18. Dr. Pope conducted a seminar on Chinese Trade Porcelains, at Winterthur Museum, Winterthur, Del. Attendance, 87.
- October 20–25. Dr. Ettinghausen, in New York City, attended the Social Science Research Council Conference on Muslim Self and Image; he also examined objects at various dealers.
- October 23–29. Dr. Pope, in Boston, examined objects in the Morse Collection at the Museum of Fine Arts, and Japanese ceramics at the Fogg Art Museum. He also attended a meeting of the Committee to Visit Department of Far Eastern Civilizations, Harvard University.
- October 23–
November 3. Miss West worked as a guest of the Conservation Center of the Institute of Fine Arts, New York University, carrying out spectrographic analyses of Chinese bronzes and glazes from the Freer collections.
- October 30. Dr. Pope, in New York City, examined objects at various dealers.
- November 7. Dr. Pope, in Baltimore, examined objects at the Baltimore Museum of Art and at the Walters Art Gallery.
- November 15. Miss West, Dr. Cahill, and Mr. Sugiura, in New York City, attended a Symposium on "Paper and Textile Supported Art Objects."
- November 15–21. Dr. Ettinghausen attended the Annual Conference of American Research Center in Egypt, at the Boston Museum of Fine Arts, as a trustee. He also examined objects at various dealers and in one private collection in New York City.
- November 19. Dr. Pope, in Philadelphia, appeared as a panelist on the University of Pennsylvania TV program, "What in the World," over WCAU-TV.
- December 14–21. Dr. Ettinghausen, in Paris, France, attended the exhibition of "Seven Thousand Years of Iranian Art," held at the Petit Palais; he also examined objects at various dealers.
- 1962
- January 10–12. Dr. Pope, in New York City, examined objects at various dealers.
- January 11. Dr. Cahill, in Boston, visited the Chinese Art Treasures Exhibition at the Museum of Fine Arts, where he gave several gallery talks, and examined Chinese paintings in the permanent collection.



61.25. Japanese painting, Edo period, Ukiyoe school; "Woman with a Puppet" by Tsukioka Settei. Freer Gallery of Art.



61.33. Chinese bronze *kuang*, Shang dynasty. Freer Gallery of Art.



61.34. Chinese painting, Sung dynasty, by Li Shan Freer Gallery of Art.



62.1. Persian (Sasanian) silver bowl, 6th century A.D. Freer Gallery of Art.

1962—Continued

- January 13. Dr. Cahill, in New York City, visited the Chinese painting exhibition at the Mi Chou Galleries; and examined objects for a dealer and in a private collection.
- February 24. Dr. Pope, in New York City, attended a meeting at the American Council of Learned Societies as Chairman of ACLS-SSRC Joint Committee on Grants for Research on Asia.
- March 2. Dr. Stern, in Palm Beach, Fla., examined objects for a number of private individuals, and at the Norton Gallery.
- March 23. Dr. Stern and Mr. Gettens, in New York City, attended a meeting with representatives of New York University and Mr. McLane of the Rockefeller Foundation re: plans for setting up a course in conservation of art objects.
- March 23. Dr. Cahill, in New York City, met with Mr. Compton of the Rockefeller Foundation re: plans for photographing the Chinese collections of art objects in Taiwan.
- March 25. Dr. Pope, in Baltimore, examined objects at the Baltimore Museum of Art.
- April 2-4. Dr. Pope and Dr. Stern, in Boston, attended meetings of the American Oriental Society.
- April 6. Dr. Stern, in New York City, attended a training program meeting at the New York Conservation Center.
- May 3-4. Mrs. L. O. West attended the meetings of the Museum Sales Association at the Munson-Williams Proctor Institute, Utica, N.Y., and the Corning Glass Works, Corning, N.Y.
- May 7-10. Dr. Pope, in New York City, examined objects at various dealers.
- May 8-18. Dr. Cahill, in California, was a member of a panel discussion on a radio broadcast from Station KPFA, Berkeley; was interviewed regarding the Chinese Art Treasures Exhibition, Station KPIX-TV, San Francisco; and made tape recordings for future broadcasts, of an interview on The Chinese Art Treasures, and the Smithsonian Institution, Station KCBS, San Francisco.
- May 15. Dr. Pope, in Ann Arbor, attended a meeting of the Freer Fund Committee at the University of Michigan.
- May 25. Dr. Stern and Mr. Sugiura visited the Philadelphia Museum of Art, where they examined Far Eastern paintings in need of repair.
- June 1. Dr. Cahill, in New York City, attended a conference at the Rockefeller Foundation re: his proposed trip to Taiwan.
- June 1, 2. Dr. Pope and Dr. Cahill, in New York City, attended a conference on the Study of Chinese Civilization at the American Council of Learned Societies.
- June 4-7. Mr. Gettens and Miss E. West, at Williamsburg, Va., attended meetings of the American Association of Museums, and the IIC-American Group, where Miss West served as Chairman of the Art Technical Section.
- June 5-8. Dr. Pope, at Williamsburg, Va., attended meetings of the American Association of Museums.

1962—Continued

- June 14. Dr. Pope and Dr. Cahill, at Mt. Kisco, N.Y., visited the home of Mrs. Eugene Meyer, where they examined Far Eastern objects.
- June 14-15. Dr. Stern, in Philadelphia, visited the collections in the Philadelphia Museum of Art and examined objects in a private collection.
- June 15. Dr. Cahill, in New York City, examined objects at various dealers.
- June 18-22. Mrs. Bertha Usilton, in Miami, Fla., attended meetings of the American Library Association.
- June 21. Dr. Ettinghausen, in New York City, examined objects at dealers.
- June 29-30. Dr. Ettinghausen, in New York City, attended a dinner meeting of the Iran Foundation, Inc.; examined objects at one dealer's, and visited the collections at the Metropolitan Museum of Art and the Jewish Museum.

As in former years, members of the staff undertook a wide variety of peripheral duties outside the Gallery, served on committees, held honorary posts, and received recognitions.

Respectfully submitted,

JOHN A. POPE, *Director.*

Dr. LEONARD CARMICHAEL,
Secretary, Smithsonian Institution.

Report on the National Air Museum

SIR: I have the honor to submit the following report on the activities of the National Air Museum for the fiscal year ended June 30, 1962:

Staff studies and planning for the new National Air Museum Building and exhibit continued, pending the appropriation of planning funds.

All records for visitors in the Air and Space Building were broken during the year with a total of 1,986,319. This was more than double the count of 987,858 for fiscal year 1961 and reflects the growing interest in the historic relics of air and space flight. Although this old (1917) building contains but 17,400 square feet and houses less than 5 percent of the National Aeronautics and Space Collection, it had the third largest visitor count of the Smithsonian museum buildings. The largest single day's count exceeded 31,000. One aircraft had to be removed to make room for people!

The Museum received many historically significant accessions during the year. Here are a few examples: the Air Force-Douglas C-54 "Sacred Cow," first Presidential aircraft, and an F-86A North American Fighter aircraft, from the U.S. Air Force; a Bellanca CF airplane and an Anzani three-cylinder air-cooled radial engine, from Mrs. Guiseppi Bellanca; instrumented duplicates of Pioneer IV, Lunar Space Probe and the Explorer I, America's first orbiting satellite, from the Jet Propulsion Laboratory; the General Thomas D. White Air Force Space Trophy from Dr. Thomas W. McKnew; Astronaut Alan B. Shepard's Mercury Spacecraft "Freedom 7," from the National Aeronautics and Space Administration; a Polaris rocket from the U.S. Navy; and the original "Journal des Marches et Operations" kept by Capt. Georges Thenault, French Commander of the Lafayette Escadrille, from Madame Thenault.

One of the most active and increasing functions of the Museum continues to be information service. During the year the Museum averaged more than 600 letters per month, furnishing historical, technical, and biographical information on air and space flight to authors, researchers, schools, Government agencies, students, and the public.

ADVISORY BOARD

A meeting of the Advisory Board was held on March 21, 1962, with all members present. Among the actions taken by the Board were

the following: Approval of the appointment of Alfred V. Verville as an honorary fellow of the National Air Museum; approval of the inauguration of a series of publications called "Smithsonian Annals of Flight"; and approval of the preliminary floor arrangement and interior concept of the proposed new National Air Museum Building, planning funds for the building to be included in the 1964 budget.

SPECIAL EVENTS

Many distinguished visitors came to the Museum during the year. Among these were U.S. Astronauts Shepard, Glenn, and Grissom and Soviet Union Cosmonaut Titov.

Among the special presentation and commemorative ceremonies held were: The Polaris rocket, presented by the Honorable Paul B. Fay, Jr., Under Secretary of the Navy; "Freedom 7," presented by the Honorable James E. Webb, NASA Administrator; "Sacred Cow," presented by Maj. Gen. Brooke E. Allen, U.S. Air Force; Whittle Engine Anniversary Commemoration, with his Excellency Sir David Ormsby Gore, British Ambassador; reproduction of the A-1, the Navy's first airplane, by Adm. James S. Russell, U.S. Navy; "Boedy's Album," a collection of some 12,000 autographed photographs of people in aviation, by Kenneth Boedecker; portrait of Amelia Earhart, by Blanche Noyes, Zonta Club of Washington.

The director attended a number of the annual meetings of aviation, aerospace, and educational organizations and societies. He also visited a number of Air Force and Navy bases, NASA centers, and major contractors of these agencies in the aerospace flight program. He spoke frequently on these visits, emphasizing the importance of the proper preservation and recording of the space flight history currently being made. This has resulted in an increased flow of historical material and information to the museum.

Paul E. Garber, head curator and historian, and Curators Louis S. Casey and Kenneth E. Newland represented the Museum at a number of aviation and aerospace meetings during the year and spoke on the work of the Museum. Mr. Garber delivered 42 lectures.

IMPROVEMENTS IN EXHIBITS

Continued experiments with means and methods of display in the Air and Space Building provide valuable experience in planning the exhibits for the new building.

REPAIR, PRESERVATION, AND RESTORATION

The acquisition of surplus machines, parts, and tools for the preservation and restoration division at Silver Hill, Md., has improved this facility. Storage, restoration, preservation, and the preparation of aircraft and engines for display are full-time activities of the staff.

ASSISTANCE TO GOVERNMENT DEPARTMENTS

The Museum continued its service to various Government departments during the year. Included were the Federal Aviation Agency, NASA, Library of Congress, Department of Justice, U.S. Navy, and U.S. Air Force.

REFERENCE MATERIAL AND ACKNOWLEDGMENTS

The library, reference files, and photographic files of the Museum have been greatly enriched during the year with new materials. These are very valuable to staff and visitor researchers in providing information, authenticating historical data.

The cooperation of the following persons and organizations in providing this material is sincerely appreciated and acknowledged:

- ACADEMY OF AERONAUTICS, INC., Flushing, N.Y.: Six boxes of periodicals.
- AIRCRAFT OWNERS AND PILOTS ASSOCIATION, J. B. HARTRANFT, JR., Bethesda, Md.: Two cabinets each with 20 drawers for IBM card files; 37 of the drawers have IBM cards filed by aircraft registration numbers.
- ALTHIN, DR. TORSTEN, Stockholm, Sweden: Book titled "Moderna Luftfartyg," in Swedish and published in 1910.
- ARMSTRONG, ROBERT, AIRCRAFT OWNERS AND PILOTS ASSOCIATION, Bethesda, Md.: AOP's Yellow Guide to Aircraft Listings.
- ATWELL, LT. COMDR. ROBERT B., USN, Norfolk, Va.: An aeronautical map of the United States, Canada, Cuba, and Mexico, made by James T. Igoe Co., copyright 1930.
- AZBE, VICTOR J., AZBE CORP., St. Louis, Mo.: Original letter written by Major Parseval; photograph of Major Parseval.
- BEAIRD, HENRY G., JR., SWISS AMERICAN AVIATION CORP., St. Gallen, Switzerland: Photos of SAAC-23 $\frac{1}{10}$ scale model; three-view and longitudinal drawings; preliminary specifications list.
- BERLINER, COL. HENRY, Washington, D.C.: Photograph of Emile Berliner, two scrapbooks.
- BRAND, HARRISON, JR., AEROSPACE INDUSTRIES ASSOCIATION, Washington, D.C.: Three books, "American Heroes of the War in the Air," by Howard Mingos and inscribed by the author; "The Birth of an Air Industry"; "Air Power for Peace."
- BRYANT, MAJ. ROBERT L., USAF, DIRECTOR, AIR FORCE MUSEUM, Wright-Patterson AFB, Ohio: Approximately 1,500 linear feet of documents on foreign aircraft; photos and drawings on commercial aircraft and others on the theory, history, and development of aviation.
- COCHRAN, MISS JACQUELINE, Washington, D.C.: A dossier requesting the homologation of two world records by Alan B. Shepard in "Freedom 7."
- COOKE, DAVID C., Valley Stream, N.Y.: Books, "Racing Planes That Made History"; "Flights That Made History"; "Jet and Rocket Planes That Made History"—all by David C. Cooke.
- DAY, CURTISS L., Elkhart, Ind.: 25 Photographs of early planes and flyers. Circa 1910-11.
- DODD, MEAD & Co. INC., New York, N.Y.: A book, "Wonders of Flight," by Robert Wells.
- DOOLITTLE, LT. GEN. JAMES H., Redondo Beach, Calif.: 36 black and white aerial photos, unmounted; 4 mounted black and white aerial photos; 2 mounted

- color aerial photos; 1 print, "The First Carriage, The Ariel"; 1 drawing, "Tut-ankh-amen's Battleplane"; 1 drawing color, "British Schneider Trophy Team, 1929"; 2 sets of photographs of J. H. Doolittle tablecloth, 6 photographs to a set.
- DRAIN, CAPT. NICHOLAS A. USN (Ret.), Ventura, Calif.: Original patent for low-drag, metal aircraft rivet joint.
- DRIGGS, IVAN H., Washington, D.C.: Assorted photographs, Mr. Driggs' proof copy of article written by Mr. Driggs and Mr. Lancaster on "Gas Turbines for Aircraft." Brochure on Luscombe Airplane Development Corp., newspaper clippings.
- ENGSTRUM, PAUL, Arlington, Va.: Pamphlet, photograph, and clippings illustrating and describing the Slate all-metal dirigible airship SMD-100, proposed as a cargo-handling long-range versatile vehicle especially for airlifting parts of space vehicles. One large mounted photograph of the Slate airship of 1928; one photograph of proposed Slate airship; two copies of article from "Aeronautical World" for September 1928 describing Slate airship.
- EVANS, A. W., McDONNELL AIRCRAFT CORP., St. Louis, Mo.: Twelve 11" x 14" color photographs of F4H-1 aircraft.
- FAIRBANK, MURRY N., Belmont, Mass.: 5 paintings of early aircraft; 3 photos of Burgess airplanes; 4 photos of Harvard-Boston Meet, 1911; 6 Burgess Aeroplane brochures; 1 folder containing newspaper clippings and magazine articles; 1 folder of transcripts from G. S. Curtiss diaries and interviews; 18 blueprints, pencil drawings, and an original tracing of Burgess Navy Hydro-aeroplane, Twin Float, March 1919.
- FLIEDNER, C. S., Chevy Chase, Md.: About 14 file cases of books, photographs, and other material.
- FRANK, MAJ. GEN. W. H., Washington, D.C.: Eight photograph albums, historical set of aeronautical photographs, 1906-17.
- FRIEDMAN, MITCHELL, Belleville, N.J.: Cross-section view of a Warner "Scarab" engine. General information about the Lambert R-266 air-cooled radial engine. General information plus a picture and a drawing of the Wright-Hispano 8-cylinder V-type water-cooled engine. The Waco Model "F" airplane booklet. 21 tracings of models A, E, I, and H Hispano-Suiza engines.
- FRICTSHE, CARL B., Alexandria, Va.: Pamphlets, "The Metalclad Airship," "Some Economic Aspects of the Rigid Airship," all by Carl B. Fritsche; book, "The Metalclad Airship ZMC-2."
- GILLESPIE, GEORGE M., Miami, Fla.: Copy of poem "Prayer Becomes Our Shepard's Rainbow" written by George M. Gillespie. Copy of letter from Commander Shepard to Mr. Gillespie.
- GLOVER, GEORGE, Northwood, Mass.: Book, "European Sporting Activities Amsterdam-Cologne," by Kiesel & Hulek.
- GOFF, COL. E. A., Edgewater, Md.: Book, "First Transcontinental Flight," by Charles S. Wiggin.
- GRAY, CAPT. A. A., USNR, McLean, Va.: Photocopies of following: one certificate, attesting to crossing by air of international date line; one photo, 7" x 5", of crew who made first commercial flight to Suva, Fiji Island, photographed with Fiji chiefs; one framed photo, 8" x 10", of the S-42 arriving at Diamond Head, Hawaii, on first flight, April 7, 1935; one postcard, 5½" x 3½", California Clipper at Cavite, P.I.; one photo, 5" x 7" Boeing 314 at Honolulu, February 1939; one photo 9½" x 7", China Clipper leaving San Francisco; one framed photo, 8" x 10", of Capt. Ed Musick.
- HARLOW, MAX B., Pasadena, Calif.: Brochure and 3-view drawing on the Atlas Model H-10 airplane; brochure, photograph, and 3-view drawing of the

- Harlow PJC-2 airplane; photograph and two 3-view drawings of the Harlow PC-5 airplane.
- HATCH, DENISON, Franklin Watts, Inc., New York, N.Y.: Book, "Early Air Pioneers, 1862-1935," by Maj. James F. Sunderman.
- HENRY FORD MUSEUM, Dearborn, Mich.: 8" x 10" photograph showing left front view of Packard diesel-powered Stinson "Detroit" Model SM-1B. On the side of the fuselage are painted the words, "This airplane powered with original Packard diesel aircraft engine made world's first diesel powered flight, September 19, 1928."
- HIGHAM, DR. ROBIN, Chapel Hill, N.C.: Book, "Rolls-Royce Dart Aero-Engine Maintenance Manual."
- HINSON, MR. AND MRS. JOHN A., New York, N.Y.: Insurance policy issued to Harry Houdini in 1909 for his aeroplane; photo of aeroplane (Farman).
- IRVIN, LESLIE L.: Newspaper clippings, magazine articles, Parachute Manual by Engineering Division Air Service.
- JENSEN, VOLMER, Volmer Aircraft, Burbank, Calif.: Three-view drawing of the VJ-22 airplane.
- KERLEY, ROBERT V., Ethyl Corp., Detroit, Mich.: Book, "History of the Aircraft Piston Engine," by S. D. Heron, subtitle, "A Brief Outline," preface by Lt. Gen. James H. Doolittle, USAF, published by the Ethyl Corp., Research and Development Department.
- KORN, EDWARD A., East Orange, N.J.: Two 8" x 10" photographs of Mr. Korn.
- LARKINS, WILLIAM T., Concord, Calif.: Book, "U.S. Navy Aircraft 1921-1941," by William T. Larkins.
- LIPPINCOTT, HARVEY H., Connecticut Historical Society, Hartford, Conn.: Cross section drawing of Pratt & Whitney Aircraft Engine No. 1 Wasp Model A.
- LARSEN, DOUGLAS, A., General Dynamics Corp., Washington, D.C.: Book, "Dynamic America."
- LIPKIS, LEON G., Los Angeles, Calif.: Book, "The 541st Bomb Squadron."
- MACKENZIE, ROY JAY, Cranston, R.I.: Texaco house organ, vol. 24, No. 2, "The Texaco Star Aviation Number"; Rhode Island Review, vol. 1, No. 3; 17 aviation photographs.
- MASSIN, ALEX, Ontario, Canada: 6 magazines, 21 commemorative envelopes.
- MCDONNELL, AIRCRAFT CORP., St. Louis, Mo.: Three copies of "Report No. 8422, October 9, 1961; Freedom 7, May 5, 1961"; a 67-page illustrated report of the capsule used in the first Mercury manned space flight and the renovations made to it prior to its being placed in the National Air Museum; line drawings, colored charts, picture of "Freedom 7" on cover, size 11 $\frac{1}{8}$ " x 8 $\frac{3}{4}$ ".
- MCGOWAN, JOHN, FRANKLIN INSTITUTE, Philadelphia, Pa.: Microfilm of Wright Brothers material containing a series of laboratory notebooks, data sheets, notes on various wind tunnel tests, sketches and original drawings of the 1903, 1904, 1905, 1907, and 1910 biplanes.
- MEANS, DR. J. H., Boston, Mass.: Three books edited by James Means: "The Aeronautical Annual 1897," No. 3; "The Aeronautical Annual 1895," No. 1; "Epitome of the Aeronautical Annual 1910."
- MEYER, ROBERT B., JR., Potomac, Md.: Nine 5-view drawings by E. F. Schmidt.
- MIKESH, CAPT. ROBERT C., USAF, Washington, D.C.: One 8" x 10" photo, one 4" x 5" transparency, one sheet of operational history of the C-54 "Sacred Cow."
- MOLSON, K. M., NATIONAL AVIATION MUSEUM, Ottawa, Canada: Transcript of the clippings from J. A. S. McCurdy scrapbook.
- MOODY, JAY H., Oklahoma City, Okla.: Book, "Aircraft and Engine Code Book."
- MOREHOUSE, HAROLD E., Williamsport, Pa.: 44 illustrated biographies which appeared in various issues of the "American Aviation Historical Society

- Journal"; two copies of biography of his life; one copy of description of the Kettering Aerial Torpedo (1917-18) titled "The Dayton-Wright World War I 'Bug' Story," and a photograph of himself; eight 3" x 4" photographs of persons connected with the Kettering "Bug" Aerial Torpedo project of World War I and one 5" x 7" photograph of the type of "Bug" constructed during the 1930's.
- MOUREY, RICHARD D., KAMAN AIRCRAFT CORP., Bloomfield, Conn.: Eleven 8" x 10" photographs of Kaman helicopters.
- MOYERMAN, SAMUEL, Philadelphia, Pa.: 15 pilots' logbooks covering period 1917-39.
- NAVY, DEPARTMENT OF THE, BUREAU OF AERONAUTICS LIBRARY, Washington, D.C.: 83 volumes of aviation books.
- NAVY, DEPARTMENT OF THE, NAVAL PHOTOGRAPHIC CENTER, Washington, D.C.: Five 16-mm movie films, MN-1539Z—"K" Type Airship Take-off Operation; MN-1539AA—"K" Type Airship, L.T.A. Landings; MN-2722A—History of Balloons; MN-6135—Lighter Than Air Training; MN-6830—The Airship Fundamental Principles and Operation.
- NAVY, DEPARTMENT OF THE, DEPARTMENT OF SPECIAL PROJECTS, Washington, D.C.: Book, "Polaris."
- NAVY, DEPARTMENT OF THE, BUREAU OF WEAPONS, Washington, D.C.: One volume entitled "Seaplane and Flying Boats—Line and Test Data for Early Aeronautical Models, 1336 to 2234."
- NATIONAL AVIATION MUSEUM, Ottawa, Canada: Five 5" x 7" photographs of Curtiss Model L airplane engine of 1910-11.
- PETERSON, JOHN J., NATIONAL AERONAUTICS AND SPACE ADMINISTRATION, Langley AFB, Va.: Booklet, "Results of the First U.S. Manned Suborbital Space Flight."
- POBEREZY, PAUL H., EXPERIMENTAL AIRCRAFT ASSOCIATION, Hales Corners, Wis.: A set of Health Parasol drawings, 14 sheets; set of EAA Biplane drawings, 15 sheets.
- PFEFER, JOE, Porterville, Calif.: Framed photograph.
- RAMSEY, MRS. DEWITT C., Washington, D.C.: A collection of 149 books from Admiral DeWitt C. Ramsey.
- REYNOLDS, BRUCE, Santa Barbara, Calif.: Eight 5" x 7" photographs, two 3½" x 6" photographs, one 4" x 6" photographs, 19 8" x 10" photographs from Frank Bryant.
- RING, GRANT A., UNITED AIRCRAFT CORP., East Hartford, Conn.: 9 annual reports and 3 pieces of literature dealing with company growth.
- SCEARCE, W. R., CAPITAL AIRLINES, Washington, D.C.: Airline schedules and chronological history of Capital Airlines Service; 17 8" x 10" photographs; book, "Biography of a Pioneer."
- SCHOENE, ARTHUR L., CHANCE VOUGHT CORP., Dallas, Tex.: 26 8" x 10" photographs of the "V" type Vought aircraft.
- SHAW, W. H., QANTAS AIRLINE, London, England: Research report on Lawrence Hargrave, "The Aeronautical Work of Lawrence Hargrave (1850-1915)."
- SCOENI, R., CHANCE VOUGHT AIRCRAFT, Dallas, Tex.: 41 8" x 10" photos; 1 genealogy chart; 1 Corsair Outline F4U; 1 reprint of the "Flying Pancake" from Air Pictorial, February 1959; 1 chronological history of Corsair; 1 biography of Chance Milton Vought; 1 historical Data Production Airplanes made by Chance Vought Aircraft; 1 list of Chance Vought "Firsts"; 1 historical sketch on F4U; 1 reprint from Naval Aviation News, March 1957.
- SPEIZMAN, WILLIAM J., Silver Spring, Md.: Book, "Instructions for the Care and Operation of Model A-1 and E Hispano-Suiza Aeronautical Engines."

- STEPTOE, THOMAS E., ESTATE OF, Fontana, Calif.: Two albums; one airmail and one Early Birds; one file folder on Early Birds.
- STITS, RAYMOND, Riverside, Calif.: SA-7D "Skycoupe," 30 sheets, 1 photo; SA-3B "Playboy," 12 sheets, 7 photos; SA-3A "Playboy," 12 sheets, 6 photos, SA-6B, "Flut-R-Bug," 18 sheets, 5 photos; 7 8" x 10" photos, 1 general arrangement of Stits aircraft, Model SA-9A plan.
- STUDER, MRS. CLARA, West Medford, Mass.: A recorded tape, pastel portrait, photographs, copies of letters, news clippings, and other texts pertaining to Amelia Earhart; two texts relative to airmail history and philately.
- TILLMAN, RAY, MERCURY AIRCRAFT, INC., Hammondsport, N.Y.: Duplicate and copies of Howard Shaver collection of air-mail photographs.
- TRUCK, LT. COMDR. W. J., SCIENCE MUSEUM, London, England: Two sets of 2 true-to-scale prints of the full-size and half-scale drawings of the W.1.A. engine.
- UHL, CHARLES C.: A folder of newspaper clippings on Carl Ben Eielson.
- VERVILLE, ALFRED V., San Diego, Calif.: Blueprint of Curtiss TS-1, one sheet, plan view only, scale 1½" to the foot, made by the Navy Department, Bureau of Construction and Repair.
- VON MEISTER, F. W., MAYBACH MOTOR Co., New York, N.Y.: 13 original photos of the LZ-127 Graf Zeppelin.
- WATERMAN, WALDO D., San Diego, Calif.: 1 file folder of biographical and Early Bird material: 21 blueprints of Waterman W-4 airplane; 13 original tracings; 1 set of erection drawings for JN4D; 19 miscellaneous photos of W-4 airplane; 1 wire bracing diagram of JN4D from Payne Field.
- WERTHEIM ADVERTISING ASSOCIATION, New York, N.Y.: Print, black and white, 8½" x 11", titled "Emanuel Swedenborg," showing that Swedish philosopher seated and holding a quill pen in act of writing.
- WIEGMAN, C. H., LYCOMING DIVISION OF AVCO MANUFACTURING CORP., Williamsport, Pa.: Test of Diesel Power, Inc., diesel conversion of the Lycoming 0-290-1 engine (December 1948).
- WRIGHT, DR. THEODORE P., Ithaca, N.Y.: 3-volume set of articles and addresses of Dr. Wright.
- ZONTA INTERNATIONAL, Chicago, Ill.: A poster, reprint of biographical article, and a copy of "The Zontian," describing the Amelia Earhart scholarships established by this organization of executive and professional women.

ACCESSIONS

Additions to the National Aeronautical and Space collections received and recorded during the fiscal year 1962 totaled 137 specimens in 81 separate accessions, as listed below. Those from Government departments are entered as transfers unless otherwise indicated; others were received as gifts or loans.

- ABBOTT, DR. IRA H., Washington, D.C.: Oil portrait of Dr. Joseph S. Ames. (N.A.M. 1294.)
- AIR FORCE, DEPARTMENT OF THE, BOLLING AIR FORCE BASE, Washington, D.C.: Air Force Douglas C-54 "Sacred Cow," Presidential aircraft (N.A.M. 1285).
- AIR FORCE MUSEUM, Dayton, Ohio: Group of six aerial cameras; four American, one German, and one Japanese (N.A.M. 1309); North American F-86A Fighter aircraft (N.A.M. 1296).
- AVCO MANUFACTURING CORP., LYCOMING DIVISION, Stratford, Conn.: T-53-L-1, Shaft-turbine helicopter engine. (N.A.M. 1326.)

- BEECH AIRCRAFT CORP., Wichita, Kans.: Models of the Beech 65 and L-23D aircraft. (N.A.M. 1265.)
- BELLANCA, MRS. GIUSEPPI, Galena, Md.: Bellanca CF airplane and an Anzani 3-cylinder aircooled radial engine. (N.A.M. 1259.)
- BLODGETT, CHARLES L.: Sample of RPI rocket fuel taken from Thor missile just before launch of first Pioneer space probe. (N.A.M. 1295.)
- BOYD, G. N., Brielle, N.J.: A 6-cylinder 1911 Kirkham aircraft engine which was used to fly at least 5 different airplanes in 1911 and 1912. (N.A.M. 1282.)
- BURNELLI, V. J., Washington, D.C.: Wind-tunnel model of Burnelli Loadmaster, 1:12 size. (N.A.M. 1312.)
- CADY, DR. GEORGE, Seattle, Wash.: Tube of helium from Navy's first helium-filled airship and one tube of gas from well in Kansas where helium was discovered in 1905. (N.A.M. 1311.)
- CHENNAULT, MRS. CLAIRE, Washington, D.C.: Oil portrait of Gen. Claire Chennault painted by Y. T. Lin of Taipei, Taiwan. (N.A.M. 1297.)
- COFFYN, MRS. FRANK T., Palo Alto, Calif.: Pilot's license No. 26 issued by Aero Club of America to Frank T. Coffyn and Helicopter certificate No. 3. (N.A.M. 1329.)
- COLE, MARCH G., Merrimac, Mass.: Stock certificates and circulars issued by Aerial Navigation Co. in 1851. (N.A.M. 1269.)
- CRAUN, BERNARD, Arlington, Va.: Radio receiving set for use in aircraft during WW-I, complete with leather helmet and built-in headset. (N.A.M. 1317.)
- CRELLY, MR. AND MRS. H. J., College Park, Md.: Two Wright airplane wheels, one Paragon propeller, and one book of airmail covers—all associated with the donor's personal acquaintance with early aviation history at the College Park airfield. (N.A.M. 1306.)
- CUSTER, W. R., Hagerstown, Md.: Prototype of the Custer Channel-wing aircraft. (N.A.M. 1261.)
- DRIGGS, MRS. IVAN, Washington, D.C.: Model of Driggs Dart and computer. (N.A.M. 1328.)
- DITTENBERGER, RICHARD, Parma, Ohio: Model of the Lockheed U-2 Reconnaissance aircraft. (N.A.M. 1293.)
- EARLY BIRDS, THE, Fairfield, Conn.: Bronze plaque commemorating Glenn Curtiss first solo (N.A.M. 1333); bronze plaque containing the names of all members, past and present, of the donating organization (N.A.M. 1322).
- ECKER, HERMAN A., Fort Lauderdale, Fla.: Curtiss-type flying boat built and flown by donor. (N.A.M. 1313.)
- FILIPPI, BERNARD P., Baltimore, Md.: Pastel portrait of Charles A. Lindbergh painted in 1956 by Rosemary Mahoney. (N.A.M. 1302.)
- FLAMMER, CAPT. PHILIP M., Colorado Springs, Colo.: Helmet which was taken from dead body of Raoul Lufbery after his tragic death in combat in WW-I. (N.A.M. 1267.)
- FLEET, MAJ. REUBEN H., San Diego, Calif.: Scale model of Consolidated NY-2 as flown by James Doolittle in his famous "under the hood" blind flight, Sept. 29, 1929. (N.A.M. 1307.)
- FRANKEL, ARTHUR G., Little Rock, Ark.: Letter and envelope sent to donor on first air mail, May 15, 1918. (N.A.M. 1320.)
- GAFFNEY, JAMES F., Cleveland, Ohio: Scale model of the Japanese Army "Nick," Kawasaki two-place twin-engined long-range day and night fighter, used in WW-II. (N.A.M. 1332.)
- GENERAL DYNAMICS CORP., Washington, D.C.: One scale model of a Convair Atlas-E satellite launching vehicle. (N.A.M. 1330.)
- GENERAL MOTORS, ALLISON DIVISION, Indianapolis, Ind.: Cutaway specimen of the Allison 501 Turboprop engine mounted for display (N.A.M. 1303); OLDS-

- MOBILE DIVISION, Lansing, Mich.: Rotor assembly for the J 65-B-3 Sapphire turbojet engine. (N.A.M. 1283.)
- GLEICK, J. T., Morton Grove, Ill.: Stabilizer brace wire fitting whose failure caused termination of world endurance flight of Jackson and O'Brine in 1929. (N.A.M. 1324.)
- GROENHOFF, HANS, Miami Beach, Fla.: Purchase of photo negative collection. (N.A.M. 1300.)
- GRUMMAN AIRCRAFT Co., Bethpage, N.Y.: Models of Grumman Aircraft F-11-F, WF-2, and S2F-1. (N.A.M. 1316.)
- HARLANDER, A. C., Oakland, Calif.: WW-I memorabilia including navigation chart, fur-lined goggles, carrier pigeon message capsule, Very signal pistol, and two rolls of aerial gunnery film. (N.A.M. 1281.)
- HARTWICK, HERBERT D., La Crescenta, Calif.: Model of Ford 4AT-B Trimotor (purchase). (N.A.M. 1315.)
- HAYWARD, JOHN B., Washington, D.C.: Original letter written by Orville Wright to Otto T. Mallery, Nov. 9, 1933. (N.A.M. 1289.)
- HEIN, ARNOLD: Skeletonized model of the Fokker D VII World War I single seat fighter. (N.A.M. 1292.)
- HILL, C. R., Grafton, Ohio: Carburetor for Curtis OX-5 engine. (N.A.M. 1286.)
- HOCK, CHARLES F., Allentown, Pa.: Falcon propeller used on early Navy trainers. (N.A.M. 1304.)
- JACOBS, MRS. RUTH A., Dayton, Ohio: Early 4-cylinder Wright Brothers engine. (N.A.M. 1273.)
- JET PROPULSION LABORATORY, Pasadena, Calif.: Instrument duplicates of the Pioneer IV, Lunar Space Probe, and the Explorer I, America's first satellite (N.A.M. 1262); fully instrumented flight-spares of the satellite Explorer I. (N.A.M. 1271.)
- KERWOOD, COL. CHARLES, Washington, D.C.: Trophy of the Ligue Internationale des Aviateurs, founded in 1926 by Col. Clifford Burke Harmon, pioneer American balloonist and aviator. (N.A.M. 1287.)
- MARR, CAPT. GIFFEN A., Fort Leonard Wood, Mo.: Three flight instruments recovered from the B-24 Bomber "Lady Be Good" after 16 years. (N.A.M. 1270.)
- MARTIN-MARIETTA CORP., Baltimore, Md.: Models of Martin aircraft and experimental projected aircraft of the Martin Co. (N.A.M. 1299.)
- McKNEW, DR. THOMAS W., Washington, D.C.: The General Thomas D. White Air Force Space Trophy. (N.A.M. 1280.)
- MEYER, CORD, New York, N.Y.: Portion of side fuselage fabric from the DH-4, the first American-built DH to see combat in WW-I. (N.A.M. 1284.)
- MOORE, MAJ. GEOFFREY, Bath, England: WW-I Anti-zeppelin explosive dart. (N.A.M. 1274.)
- NATIONAL AERONAUTICS AND SPACE ADMINISTRATION, Washington, D.C.: "Freedom 7" Mercury Spacecraft which carried Alan Shepard on U.S. First Space Flight and an astronaut space suit. (N.A.M. 1264.)
- NASH, MISS CAROLYN, Washington, D.C.: Fragment of a parachute reported to be associated with the 1925 expedition of Roald Amundsen and his companions who endeavored to fly to the North Pole in two Dornier flying boats, departing Spitzbergen May 21, 1925. (N.A.M. 1334.)
- NATIONAL HISTORICAL WAX MUSEUM, Washington, D.C.: Plastic display head of Comdr. Alan B. Shepard made to fit into the Space Helmet and Suit to be displayed with the "Freedom 7" Mercury Capsule. (N.A.M. 1266.)
- NAVY, DEPARTMENT OF THE, Washington, D.C.: Polaris, the Nation's first large solid propellant ballistic missile, and the first designed to be fired by ships at sea. (N.A.M. 1260.) NAVAL ACADEMY, Annapolis, Md.: Engine from

- Japanese Ota kamikaze attack plane. (N.A.M. 1277.) NAVAL RESEARCH LABORATORY, Washington, D.C.: 16-mm. movie camera which took pictures of the earth from 100 miles altitude in 1954; also a copy of the film and a mosaic picture, using 180 frames from the film. (N.A.M. 1276.) BUREAU OF WEAPONS, Washington, D.C.: Full-size replica of Curtiss A-1, the Navy's first aircraft (N.A.M. 1275); Mitsubishi Airplane, A6M5 "Zero" (N.A.M. 1305.) U.S. MARINE CORPS, Quantico, Va.: Ordnance materiel for installation on Museum specimens. (N.A.M. 1263.)
- NEUMANN, CHARLES L., Tulsa, Okla.: A complete Mark I Sperry Automatic Direction Finder unit, one of the first to be used by the airlines in the 1930's. (N.A.M. 1298.)
- NEVIN, ROBERT S., Denver, Colo.: Scale model of the Curtiss twin-tractor flying boat of 1912 (purchase). (N.A.M. 1201.)
- PARSONS, REAR ADM. EDWIN C., Osprey, Fla.: Fragment of first American flag to be flown over German lines on day America entered WW-I. (N.A.M. 1278.)
- PIONIERI DELL 'AERONAUTICA, Rome, Italy: Life-size bronze busts of the pioneer Italian flyers Mario Calderara and Umberto Savoia. (N.A.M. 1321.)
- POPULAR MECHANICS MAGAZINE, CLIFFORD HICKS, EDITOR, Chicago, Ill.: 12 water-color paintings by Korta, of the "Twelve Most Significant Aircraft of All Time." (N.A.M. 1327.)
- PROCTOR, ELBERT W., Takoma Park, Md.: Pilot's flight gear used by donor as a pilot for National Air Transport in late 1920's. (N.A.M. 1255.)
- RANDALL, W. D., Jr., Orlando, Fla.: Duplicate of hand-wrought knife carried in "Freedom 7" Mercury spacecraft on its famous flight. (N.A.M. 1254.)
- ROCKWELL, COL. PAUL A., Asheville, N.C.: French uniform worn by the donor's brother, Kiffin Rockwell, as a pilot in the WW-I Lafayette Escadrille, together with copies of the eight medals awarded to the deceased. (N.A.M. 1323.)
- SCALE CRAFT MODELS, Massillon, Ohio: Model of a Curtiss HS2L Flying Boat, WW-I, U.S. Navy patrol craft (purchase). (N.A.M. 1310.)
- SIMPSON, COL. DONALD P., Teheran, Iran: German WW-II Navigation Kit. (N.A.M. 1279.)
- SIX, ROBERT F., Denver, Colo.: Original watercolor painting entitled "Beech Aircraft in Flight," by Alfred Owles. (N.A.M. 1318.)
- SMITHSONIAN INSTITUTION, Washington, D.C.: Original letter written by Wilbur Wright to the Smithsonian on May 30, 1899, requesting available information on flight (N.A.M. 1301); flag taken from L-49 German Zeppelin and fragments of outer and inner bag of craft (N.A.M. 1268.)
- SOUBIHAN, MRS. ROBERT, Washington, D.C.: Memorabilia of donor's husband's service in the Lafayette Escadrille. (N.A.M. 1256.)
- STEMP, MR. AND MRS. RONALD F., Annapolis, Md.: Wooden aircraft propeller of the middle 1920's presented to donor by Col. A. A. Anderson, a partner in the Bellanca Airplane Co. (N.A.M. 1308.)
- SWEDENBORG FOUNDATION, INC., New York, N.Y.: A scale model of the concept of an aircraft by Emanuel Swedenborg, Swedish philosopher, engineer, and theologian who conceived this aircraft about 1714. (N.A.M. 1290.)
- THENAULT, MME. GEORGES, Paris, France: Two-volume diaries "Journal des Marches et Operations" kept by Capt. Georges Thenault, the French Commander of the Lafayette Escadrille. (N.A.M. 1272.)
- TRACY, DANIEL, Lakewood, Ohio: Model of Curtiss R-1 Pulitzer Prize winner of 1921 aircraft (purchase) (N.A.M. 1257); scale model of the French Nieuport-Delage-29 airplane, the final winner of the James Gordon Bennett Trophy, 1920 (purchase) (N.A.M. 1331).

UNITED AIRCRAFT CORP., Hartford, Conn.: The Igor Sikorsky International Trophy awarded for outstanding achievement in the helicopter field (N.A.M. 1325). PRATT & WHITNEY DIVISION: Two-throw crankshaft for Pratt & Whitney R-2800 engine (N.A.M. 1258).

UNITED AIRLINES, Chicago, Ill.: Models of Douglas DC-6, DC-7 and Boeing Stratocruiser 277. (N.A.M. 1314.)

WEEMS, CAPT. P. B. H., Annapolis, Md.: A Japanese cargo WW-II parachute. (N.A.M. 1288.)

ZONTA CLUB OF WASHINGTON, Washington, D.C.: Oil painting of Amelia Earhart by Arthur Laronda. (N.A.M. 1319.)

Respectfully submitted.

PHILIP S. HOPKINS, *Director.*

DR. LEONARD CARMICHAEL,
Secretary, Smithsonian Institution.

Report on the National Zoological Park

SIR: I have the honor to submit the following report on the activities of the National Zoological Park for the fiscal year ended June 30, 1962:

BIRTHS

The major zoological event at the National Zoological Park during the past year was the birth of a male lowland gorilla on September 9, 1961. The parents, Nikumba and Moka, were brought from French Equatorial Africa (now Congo) by the Arundel Expedition in February 1955; at that time their age was estimated to be 18 months for the male and 20 months for the female. During the last weeks of the 9-month pregnancy an hourly check was made on the gorilla cage, but the actual birth was not observed. The baby was discovered by a night keeper at 6:58 a.m. As Moka showed no maternal interest in her infant, it was removed from the cage and taken to the home of Bernard Gallagher, supervisory keeper of great apes, where Mrs. Gallagher reared it along with a 5-month-old chimpanzee. On April 24, after more than 7 months with the Gallaghers, Tomoka and his chimpanzee companion, Lulu, were brought to the Zoo and put on exhibition April 24.

Radio Station WAVA, Arlington, Va., owned by Arthur Arundel, who had originally escorted Nikumba and Moka from Brazzaville to Washington, held a contest to select a name for the baby, and the naming ceremony was broadcast on April 24.

Tomoka is the second gorilla born in captivity in the United States and the fourth bred, born, and raised in captivity in the world. Comparing the development of this gorilla with the statistics available of those born elsewhere (Columbus, Ohio, and Basel, Switzerland), the most outstanding difference appears to be the early date at which upper and lower incisors erupted. In Goma, the female gorilla reared in the home by Dr. Lang in Basel, under similar conditions to ours, the first breakthrough of the incisors was observed at the age of 2 months, and at the age of 6 months four lower and two upper incisors were reported. As indicated in the accompanying table, Tomoka's lower median left incisor broke through on October 3, 25 days after birth, and the lower median right on October 5, 27 days after birth. Both median upper incisions were showing 35 days after birth, and at the end of 66 days all eight incisors had erupted.

ERUPTION OF DECIDUOUS TEETH

	[in days]											
Average chimpanzee*-----	308	126	122	111								
Average human*-----	839	486	316	277								
Goma-----				68	74							
Tomoka-----	175	111	61	51	55	61	111	175				
	m ₁	pm ₂	pm ₁	c	i ₂	i ₁	i ₁	i ₂	c	pm ₁	pm ₂	m ₁
Tomoka-----	183	145			68	25	27	79		141	183	
Goma-----					90	60	59	90				
Average human*-----	787	492			395	222						
Average chimpanzee*-----	247	150			124	95						

*Ref: E. Boyd, L. B. Higley, E. H. Hixon, V. O. Hurme, M. Massler, H. V. Meredith, A. H. Riesen, A. H. Schultz (Zurich).

Tomoka's weight curve appears to ascend a little more rapidly than that of Goma, while Tomoka's growth curve levels off at an earlier date than Goma's.

Except for an early rhinal and bronchial cold and occasional diarrheas, mostly during dentition periods, no major upsets occurred in Tomoka's early life, and the baby at present gives all indications of being sound, healthy, and both mentally and physically well developed. Special mention should be made of the ceaseless effort of Mrs. Louise Gallagher, who proved to be an extremely reliable, conscientious, and dedicated foster mother.

Among other important births at the Zoo was that of an F2 Dorcas gazelle fawn, as well as a male fawn from the mother originally donated by President Bourguiba of Tunisia in 1960, bringing the number of this little herd up to five.

The birth of a male ring-tailed lemur (*Lemur catta*) on April 21, 1962, appears to be the first in this country since 1914 when the Philadelphia Zoo recorded a *Lemur catta* born, but did not note whether it was bred in captivity.

For the first time in this Zoo, lesser pandas were born—twins, a male and a female, on June 20. They were approximately 4 inches long, weighed about 4 ounces, and were nursed by the mother.

The Australian kookaburra laid a total of six eggs in two clutches, and five young were successfully raised.

The exchange of the old black swan cob for a new one resulted in two clutches of eggs, four and six, respectively. Out of the first, one cygnet was hatched in the incubator, while in the second clutch all six cygnets were hatched and brooded by the mother.

Following the procedure of previous years, all births and hatchings are listed below, whether or not the young were successfully raised.

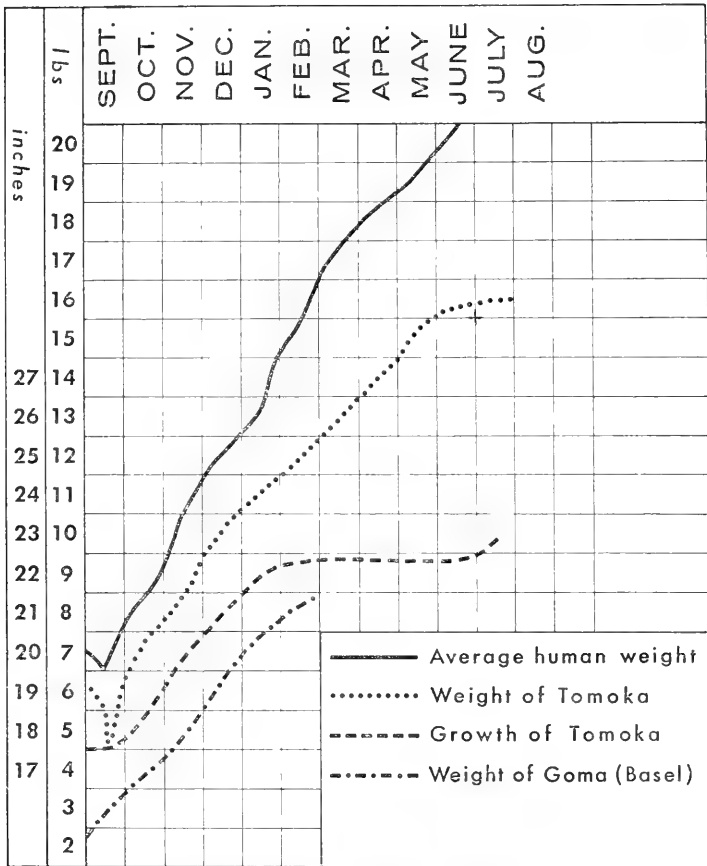

FIGURE 1.—Growth and weight graph of Tomoka compared with the average human weight and the weight of Goma.

In many instances the record of animals having bred in captivity is of importance.

MAMMALS

Common name	Scientific name	Number
Australian sugar glider	<i>Petaurus breviceps</i>	1
Rat kangaroo	<i>Potorous</i> sp.	2
European hedgehog	<i>Erinaceous europacus</i>	4
Ring-tailed lemur	<i>Lemur catta</i>	1
Galago	<i>Galago crassicaudatus</i>	1
Brown capuchin	<i>Cebus</i> sp.	1
Black spider monkey	<i>Ateles geoffroyi</i>	1
Black spider monkey	<i>Ateles fusciceps</i>	*1
Pygmy marmoset	<i>Cebuella pygmaea</i>	1
Hybrid macaque	<i>Macaca philippinensis</i> × <i>M. irus</i>	1
Barbary ape	<i>Macaca sylvanus</i>	3

*Stillborn.



Tomoka, male lowland gorilla, when 4 days old. National Zoological Park.



Tomoka at 11 months, playing in his cage. National Zoological Park.
Photograph by T. W. Roth.

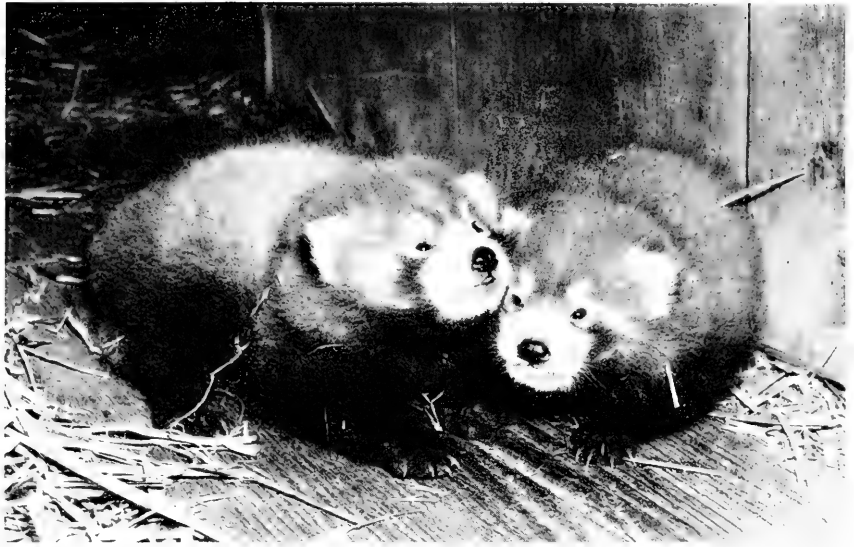

1. Baby lesser pandas bred and born in the National Zoological Park.
Photograph by T. W. Roth.



2. Baby *Lemur catta*, bred and born in the National Zoological Park, with its mother
Photograph by T. W. Roth.

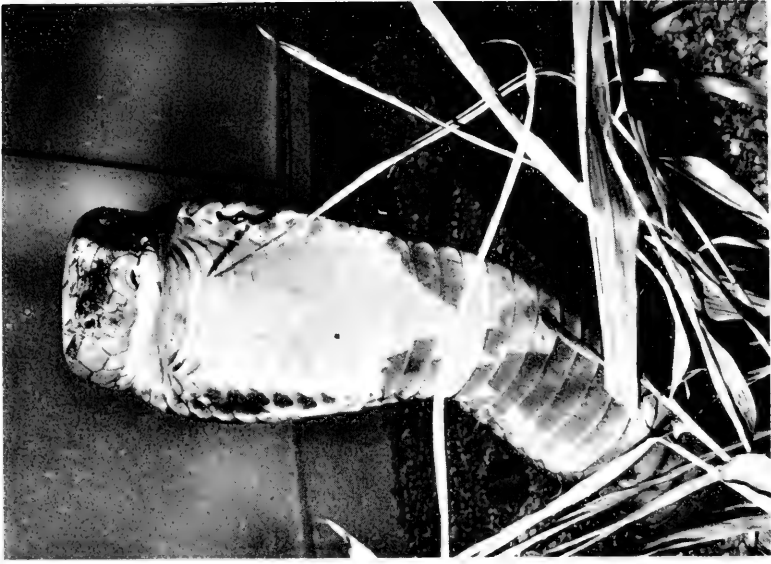

2. A 15-foot king cobra arrived from Thailand during the current year. National Zoological Park. Photograph by Chinn, Washington Evening Star.



1. The male saïra antelope wears a piece of rubber hose on each horn to prevent damage to the female. National Zoological Park. Photograph by J. W. Roth.

Common name	Scientific name	Number
Sooty mangabey	<i>Cercocebus fuliginosus</i>	1
Hybrid gibbon	<i>Hyllobates agilis</i> × <i>H. lar pileatus</i> .	1
Chimpanzee	<i>Pan satyrus</i>	*1
Lowland gorilla	<i>Gorilla gorilla</i>	1
Two-toed sloth	<i>Choloepus didactylus</i>	1
Prairie-dog	<i>Cynomys ludovicianus</i>	5
Patagonian cavy	<i>Dolichotis patagona</i>	2
Timber wolf	<i>Canis lupus nubilus</i>	*1
Cape hunting dog	<i>Lycan pictus</i>	4
Korean bear	<i>Selenarctos thibetanus ussuricus</i>	1
European brown bear	<i>Ursus arctos</i>	2
Hybrid bear F2	<i>Thalarchos maritimus</i> × <i>Ursus middendorffi</i> .	*2
Grizzly bear	<i>Ursus horribilis</i>	*1
Lesser panda	<i>Ailurus fulgens</i>	2
Neumann's genet	<i>Genetta genetta neumannii</i>	2
Formosan spotted civet	<i>Viverricula indica</i>	1
African water civet	<i>Atilax paludinosus</i>	2
Black leopard	<i>Panthera pardus</i>	*1
African lion	<i>Panthera leo</i>	4
Grant's zebra	<i>Equus burchelli boehmi</i>	2
Collared peccary	<i>Pecari tajacu</i>	3
Nile hippopotamus	<i>Hippopotamus amphibius</i>	1
Llama	<i>Lama glama</i>	2
White fallow deer	<i>Dama dama</i>	1
Axis deer	<i>Axis axis</i>	3
Red deer	<i>Cervus elaphus</i>	1
Elk	<i>Cervus canadensis</i>	1
Sika deer	<i>Cervus nippon</i>	6
Virginia deer	<i>Odocoileus virginianus</i>	2
Reindeer	<i>Rangifer tarandus</i>	2
Dorcas gazelle	<i>Gazella dorcas</i>	2
Aoudad	<i>Ammotragus lervia</i>	*1
Big-horned sheep	<i>Ovis canadensis</i>	1

BIRDS

Black swan	<i>Chenopsis atrata</i>	7
Wood duck	<i>Aix sponsa</i>	75
Mallard duck	<i>Anas platyrhynchos</i>	25
Mandarin duck	<i>Dendroessa galericulata</i>	1
Red junglefowl	<i>Gallus gallus</i>	1
Peafowl	<i>Pavo cristatus</i>	4
Indian emerald-winged tree dove	<i>Chalcophaps indica</i>	1
Leadbeater's cockatoo	<i>Kakotie leadbeateri</i>	1
Grass parakeet	<i>Melopsittacus undulata</i>	2
Kookaburra	<i>Dacelo gigas</i>	6

REPTILES

Box turtle	<i>Terrapene carolina</i>	1
Painted turtle	<i>Chrysemys picta</i>	4
Red-lined turtle	<i>Pseudemys scripta callirostris</i>	2

<i>Common name</i>	<i>Scientific name</i>	<i>Number</i>
Yellow-bellied turtle.....	<i>Pseudemys scripta scripta</i>	5
Red-eared turtle.....	<i>Pseudemys scripta elegans</i>	4
Red-bellied turtle.....	<i>Pseudemys rubriventris</i>	2
Cook's tree boa.....	<i>Boa enydris cooki</i>	18
Eastern garter snake.....	<i>Thamnophis sirtalis</i>	30
Eastern ribbon snake.....	<i>Thamnophis sauritus</i>	6
Black racer.....	<i>Coluber constrictor</i>	24
Corn snake.....	<i>Elaphe obsoleta guttata</i>	6
Northern copperhead.....	<i>Ancistrodon contortrix</i>	8
Western diamondback rattlesnake.....	<i>Crotalus atrox</i>	7

FISHES

Egyptian mouthbreeder.....	<i>Haplochromis multicolor</i>	30
----------------------------	--------------------------------------	----

GIFTS

Gifts from foreign dignitaries again enriched the National collection. President William V. S. Tubman of Liberia, making an official visit to Washington, spent 2 hours in the Zoo on September 13 and presented a leopard. President Ibrahim Abboud of Sudan came to the Zoo on October 5 and donated four demoiselle cranes and two migratory cranes, which were welcome additions to the collection.

"Ambika," the Indian elephant which was a gift from the "Share Your Birthday Foundation" and the Maharajah of Mysore, came to the Zoo on deposit April 14, 1961. After touring the country and making appearances at schools and playgrounds, she was formally presented to the Zoo on January 5, 1962. A. K. Ray, first secretary of the Indian Embassy, the Secretary of the Smithsonian Institution, and Mrs. Ira J. Heller, president of the Share Your Birthday Foundation, were all present at the ceremony.

In return for a pygmy hippopotamus, given last year by President Tubman of Liberia, the National Zoological Park sent a trio of American bison to the zoo in Monrovia. The shipment was accompanied by Charles Thomas, senior keeper.

Dr. R. E. Kuntz sent a valuable collection of reptiles (listed below), and J. E. Joy, who has sent interesting specimens in the past, gave his entire collection of western reptiles.

Space does not permit listing all gifts received in the course of the year, but the following are of special interest:

Brown, Comdr. L. L., Takoma Park, Md., hill mynah.

Browne, Mrs. Elwyn, Seat Pleasant, Md., kinkajou.

Cline, Martin J., Bethesda, Md., 4 alligators.

DePrato, Mario, Kensington, Md., coral snake, sand boa.

Eccard, Elliott, Bethesda, Md., Petz's parakeet.

Evans, Wallace L., Richmond, Va., boa constrictor.

Fish and Wildlife Service: through Dr. A. S. Mosby, Blacksburg, Va., broad-winged hawk; Cambridge, Md., 2 whistling swans; through Dr. Gordon Clark,

Chincoteague, Va., 4 snowy egrets, 4 little blue herons, herring gull, 4 common terns, 14 American egrets, 6 laughing gulls, 5 Louisiana herons, 6 skimmers, 4 ospreys, 2 eastern green herons; Wildlife Refuge, Patuxent, Md., 2 ovenbirds, 2 Acadian flycatchers, red-eyed vireo, 3 cardinals, 20 wood thrushes, 5 scarlet tanagers, 2 Kentucky warblers, redstart; through R. Halstead, Washington, N.C., 3 pintail ducks, 3 black ducks, 4 mallard ducks, 6 wood ducks, green-winged teal, 3 whistling swans.

Franklin Park Zoo, Boston, Mass., 3 pygmy goats.

French Creek Game Farm, French Creek, W. Va., 2 American black bears, 2 southern fox squirrels, 8 timber rattlesnakes.

Hoffman, Charles R., Washington, D.C., American bittern.

Holmes, Mrs. Dorothy, Arlington, Va., Petz's parakeet.

Hood, Capt. G. H., U.S.S. *Hermitage*, African ball python, Nile crocodile.

Hower, Lt. S. H., Washington, D.C., mute swan.

Johnson, Alex R., San José, Costa Rica, ocelot.

Jones, Thomas R., Arlington, Va., 3 timber rattlesnakes.

Joy, J. E., San Angelo, Tex., 3 crevice spiny lizards, 2 flat-headed snakes, western hog-nosed snake, 2 rough green snakes, 2 Sonoran king snakes, 2 bull snakes, Lindheimer's rat snake, 2 Great Plains rat snakes, 3 Texas long-nosed snakes, Texas soft-shelled turtle, broad-banded copperhead, northern copperhead, 7 Western diamondback rattlesnakes, 14 Texas horned lizards, 10 collared lizards, 5 Texas spiny lizards, diamondback water snake, 2 race runners, 3 Western coachwhips, 2 Brazos water snakes, 5 short-lined skinks, 2 water snakes, black-necked garter snake.

Kuntz, Dr. R. E., Taipei, Taiwan, 2 Asiatic crested porcupines, 5 lesser Indian rat snakes, 3 Formosan green snakes, 32 palm vipers (of 2 species), 4 Taiwan habus, 4 Formosan rat snakes, 2 Russell's vipers, 9 many-banded kraits, 5 Taiwan cobras, 5 greater Indian rat snakes, 5 Formosan striped rat snakes, 6 striped keel-backed water snakes, Oshima rat snake, 4 Philippine monitors, 3 regal pythons, 10 Tokay geckos.

Latham, Mrs. Inez, Washington, D.C., 2 Bengalee finches, 2 cut-throat finches, 2 Indian silverbills.

Lewis, Dr. T. H., Bethesda, Md., 5 teiid lizards.

Montana State Game Commission, Helena, Mont., 2 Rocky Mountain goats.

Mullinax, Mrs. Lois, Takoma Park, Md., green monkey.

National Institutes of Health, Bethesda, Md., 10 deer mice (including 2 albinos), meadow vole, 6 Egyptian spiny mice, 9 African grass mice, 2 Egyptian gerbils.

Owens, Charles H., Woodbridge, Va., 3 green guenons.

Pesacane, A., Silver Hill, Md., toucan.

Ratliff, Lester, Washington, D.C., regal python, alligator.

Roth, T. H., Washington, D.C., 14 hinged-back tortoises (of 2 species), gelada baboon, green guenon, leopard tortoise, 12 vitelline masked weavers.

Rothrock, Mrs. Grace E., Washington, D.C., double yellow-headed parrot.

Schein, Steven, Silver Spring, Md., Cook's tree boa, boa constrictor, Florida king snake, spectacled caiman.

Setzer, Dr. Henry, Washington, D.C., desert hedgehog.

Sinclair, Miss Glenn, Hampton, Va., 3 gray foxes.

Skeels, Reginald V., Alexandria, Va., lesser hill mynah.

Van Doren, F. S., Manassas, Va., lesser hill mynah.

Voorhees, Alan, Bethesda, Md., mute swan.

Walter, Garvin J., Jr., Washington, D.C., keel-billed toucan.

Zander, Mrs. R. V., Alexandria, Va., cockatiel.

PURCHASES

Among important purchases of the year were a female African rhinoceros obtained as a mate for the male acquired last year, two female Masai giraffes (*Giraffa camelopardalis tippelskirchi*), the rare (in captivity) East African golden cat (*Felis (Profelis) aurata pallida*), a magnificent specimen of honey badger or ratel (*Mellivora capensis*), four saiga antelopes, and a trio of African jumping hares well adjusted to captivity and very rarely exhibited in zoos.

A shipment from Thailand yielded two open-billed storks (*Anastomas lamelligerus*) and one Feilden's falconet (*Neohyrax cinereiceps*), believed to be the only one at present in captivity in the United States.

The reptile collection was increased by two magnificent specimens of king cobra, the larger of which measures a good 16 feet. When word was received that these snakes had arrived at Idlewild Airport on a cold February day, senior keeper Mario DePrato made a quick trip to New York to receive them and bring them back to the Zoo. They were put in a safe place for the night and unpacked the following day.

Dr. W. T. Roth, general curator, while in India purchased an interesting collection of small birds; and J. Lear Grimmer, associate director, during his field trip in British Guiana purchased four white-faced saki monkeys and an assortment of small mammals, birds, and reptiles.

Other purchases of interest were:

Clouded leopard	Hoopoe
Martial eagle	2 Gaboon vipers
Hooded vulture	4 African clawed frogs
White-backed vulture	2 Blumberg's toads
Long-crested hawk eagle	18 Tokay geckos
3 pygmy cormorants	2 Kori's bustards
4 African gray parrots	

EXCHANGES

An arrangement with the British Guiana Zoo, Georgetown, B.G., resulted in an exchange in which a surplus lion cub belonging to the National Zoological Park was offered for 56 birds indigenous to South America, 14 mammals, and 2 snakes.

During the course of his studies of the hoatzin in British Guiana Mr. Grimmer collected 63 birds and 34 reptiles for the Zoo. Among the birds was a small parrot (*Conurus solstitialis*). There are no records of this species ever having previously been in captivity in zoos of the United States.

Other animals obtained through exchange were:

Barcelona Zoo, Barcelona, Spain, 2 Goliath frogs.
Catskill Game Farm, Catskill, N.Y., llama.

- Franklin Park Zoo, Boston, Mass., 2 Abyssinian ground hornbills.
 George's Pet Shop, Bladensburg, Md., 2 spiny-tailed iguanas, 2 emerald tree boas, 2 razor-billed toucanets.
 Gorsuch, George W., New Windsor, Md., 2 Egyptian geese.
 Hanson, Charles, Athens, Ohio, Texas gopher snake, desert tortoise, 2 island water snakes, 3 garter snakes (melanistic phase), 6 gray tree frogs.
 McCrossin, B., Washington, D.C., Egyptian goose.
 Norfolk Zoo, Norfolk, Va., 4 coatimundis, 2 American bison.
 Portland (Oreg.) Zoo, 2 siamangs, 3 Columbian ground squirrels.
 Royal Zoological Society of Scotland, Edinburgh, 2 gannets.
 San Antonio Zoo, San Antonio, Tex., jungle cat, tassel-eared squirrel.
 Southwick Game Farm, Blackstone, Mass., 2 saddle-billed storks, mute swan, 2 tricolored squirrels.
 Thomas, Charles, Washington, D.C., 2 European songthroats, 2 European buntings, 8 European linnets.
 Tote-em-In Zoo, Wilmington, N.C., 4 European red squirrels, 2 murine opossums, 2 pygmy marmosets, chicken turtle, chicken snake, 2 South African spiny lizards, 2 plated lizards, 2 Ameiva lizards, 4 crested basilisks, 4 South American tortoises, 4 Florida box turtles, 2 Texas tortoises, African mud turtle, 12 day geckos (3 species of *Phelsuma*), mabuya, 4 lizards (*Hoplurus sawicola*), skink (*Zonosaurus aeneus*), 3 skinks (*Z. madagascariensis*).
 Zinner, Hermann, Vienna, Austria, 7 Aesculapian snakes, 3 European racers, 4 European grass snakes, 6 tessellated water snakes, 14 water terrapins, 10 tree frogs, 4 spadefoot toads, 21 green lizards, 2 malpolons, 4 European vipers.
 Zoological Society of Trinidad, Port-of-Spain, Trinidad, South American racer, rainbow boa, 10 Ameiva lizards, boa constrictor, 2 boat-billed herons, 6 scarlet ibis, 4 maroon tanagers, 2 palm tanagers, 6 blue tanagers, 6 kiskadee fly-catchers.

The following animals were sent to other zoos and to private collectors in exchange:

- Buffalo Society of Natural Sciences, Buffalo, N.Y., tree boa.
 Calgary Zoo, Calgary, Alberta, European brown bear.
 Chicago Zoological Society, Brookfield, Ill., Dall sheep (traded a female for a male; sent female for breeding).
 Cincinnati Zoo, Cincinnati, Ohio, llama.
 Fort Worth Zoo, Fort Worth, Tex., harpy eagle.
 Franklin Park Zoo, Boston, Mass., serval kitten, black-backed jackal, black spider monkey, 3 fat-tailed gerbils.
 George's Pet Shop, Bladensburg, Md., 2 yellow-necked parrots.
 Hanson, Charles, Athens, Ohio, corn snake, American alligator.
 Houston Zoo, Houston, Tex., 2 woodchucks, 3 Egyptian spiny mice, 2 fat-tailed gerbils, 2 Meriones, 3 Neumann's genets, 2 water civets, night monkey, hybrid gibbon, 3 brown-throated conures, 4 tawny-bellied seedeaters.
 McCrossin, B., Washington, D.C., 2 onogadori chickens, ring-necked dove.
 Norfolk Zoo, Norfolk, Va., llama, African porcupine.
 Oakie, W. A., Winston-Salem, N.C., 4 mute swan cygnets, 2 whooper swan cygnets.
 Philadelphia Zoo, Philadelphia, Pa., American crocodile.
 San Antonio Zoo, San Antonio, Tex., African crowned crane, raccoon dog, jungle cat, spider monkey, 2 sooty monkeys, gelada baboon, 4 black squirrels, 4 fat-tailed gerbils.
 Southwick Wild Animal Farm, Blackstone, Mass., emu, black swan, 2 wild turkeys.

Steinhart Aquarium, San Francisco, Calif., 2 Surinam toads.

Thomas, Charles, Washington, D.C., 2 cockatiels.

Toledo Zoo, Toledo, Ohio, 2 Cape hunting dogs.

Tote-em-In Zoo, Wilmington, N.C., 4 Virginia deer, collared peccary, 4 American black bears, 3 olive baboons, 2 leopards, 5 Sika deer.

Werber, S. F., Silver Spring, Md., 1 Canada goose.

The associate director, J. Lear Grimmer, and Mrs. Grimmer returned to British Guiana to continue investigation into the ecology of the hoatzin (*Opisthocomus hoatzin*). Certain observations of the bird in former years made it desirable to have a morphologist-anatomist on the expedition, and Dr. Wilhelm Marinelli, professor of zoology and director of graduate biology, University of Vienna, was invited to participate in view of his longstanding interest in the species. After spending 10 weeks in field work throughout British Guiana, Mr. Grimmer and Dr. Marinelli assembled and studied their findings for 2 months at the University of Vienna, correlating behavior patterns and anatomical aspects of the bird.

One of the hoatzins brought to the National Zoo established an important longevity record. Captured July 10, 1961, it lived until January 25, 1962—long enough to make close-range daily observations possible. Much was learned of its adaptability to cage environment and food requirements. The field work will continue with an ultimate goal of establishing an integrated breeding colony of this extraordinary bird in the National Zoological Park.

The expeditions have been sponsored by the Smithsonian Institution, the National Geographic Society, the Mitch Miller Foundation, and the Jewett Foundation. An article on the work done in British Guiana will be published in the October 1962 National Geographic Magazine.

General improvements and innovations in the animal department included experimental reversed daylight setups. Also an attempt was made to winter more animals outdoors than previously. By providing a minimal amount of heat, through overhead lamps or underground heating cables in their shelters or sleeping boxes, gazelles and macaques were successfully wintered outdoors. Cockatoos and parakeets were given "hot-foot" perches made of pipe, through which an electric heating wire was run, controlled by a thermostat.

In the large mammal division an elephant training program was initiated in May in order to keep the young male African elephant, "Dzimbo," under control and to provide "Nancy," "Ambika," and "Shanti" with more exercise.

The commissary division increased the raising of food animals such as waxworms, crickets, mealworms, chickens, rabbits, and guinea pigs, and thereby provided a valuable addition to the diet of the animals.

The night-keepers program, while not yet completely staffed, has

proved to be a valuable development; night-time feeding and attention have contributed greatly to the number of baby animals and birds successfully raised at the Zoo.

The importance of a zoological collection rests, to a large extent, upon its diversity and scope. The National Zoological Park has enjoyed some measure of success in its efforts to add representative species belonging to little-known or absent families.

The total number of accessions for the year was 1,340. This includes gifts, purchases, exchanges, deposits, births, and hatchings.

STATUS OF THE COLLECTION

Class	Orders	Families	Species or subspecies	Individuals
Mammals.....	14	48	244	665
Birds.....	22	78	415	1, 209
Reptiles.....	4	26	206	809
Amphibians.....	2	11	23	109
Fishes.....	4	9	21	80
Arthropods.....	3	5	5	57
Mollusks.....	1	1	1	30
Total.....	50	178	914	2, 959

ANIMALS IN THE COLLECTION ON JUNE 30, 1962

MAMMALS

MONOTREMATA

<i>Family and common name</i>	<i>Scientific name</i>	<i>Number</i>
Tachyglossidae:		
Echidna, or spiny anteater.....	<i>Tachyglossus aculeatus</i>	1

MARSUPIALIA

Didelphidae:		
Murine opossum.....	<i>Marmosa</i> sp.....	1
	<i>Didelphis marsupialis</i>	1
Dasyuridae:		
Tasmanian devil.....	<i>Sarcophilus harrisii</i>	1
Phalangeridae:		
Sugar glider.....	<i>Petaurus breviceps</i>	3
Squirrel glider.....	<i>Petaurus norfolcensis</i>	7
Phascolomidae:		
Hairy-nosed wombat.....	<i>Lasiorhinus latifrons</i>	2
Mainland wombat.....	<i>Wombatus hirsutus</i>	1
Macropodidae:		
Tree kangaroo.....	<i>Dendrolagus matschici</i>	1
Rat kangaroo.....	<i>Potorous</i> sp.....	3

INSECTIVORA				
<i>Family and common name</i>	<i>Scientific name</i>	<i>Number</i>		
Erinaceidae:				
European hedgehog-----	<i>Erinaceus europaeus</i> -----	4		
African desert hedgehog-----	<i>Paracchinus aethiopicus</i> -----	1		
Short-tailed shrew-----	<i>Blarina brevicauda</i> -----	2		
PRIMATES				
Lemuridae:				
Ring-tailed lemur-----	<i>Lemur catta</i> -----	4		
Lorisidae:				
Great galago-----	<i>Galago crassicaudatus</i> -----	2		
Dwarf galago-----	<i>Galago senegalensis zanzibaricus</i> -----	2		
Common potto-----	<i>Perodicticus potto</i> -----	1		
Cebidae:				
Night monkey-----	<i>Aotus trivirgatus</i> -----	2		
Brown capuchin monkey } White-throated capuchin } Capuchin }	<i>Cebus capucinus</i> -----	10		
Weeping capuchin monkey-----			<i>Cebus griseus</i> -----	1
White-faced saki monkey-----			<i>Pithecia pithecia</i> -----	1
Squirrel monkey-----	<i>Saimiri sciureus</i> -----	6		
Black spider monkey-----	<i>Ateles fusciceps</i> -----	4		
Spider monkey-----	<i>Ateles geoffroyi</i> -----	6		
Woolly monkey-----	<i>Lagothrix</i> sp-----	1		
Callithricidae:				
Pygmy marmoset-----	<i>Cebuella pygmaea</i> -----	2		
Cottontop marmoset-----	<i>Saguinus oedipus</i> -----	1		
Red-handed marmoset-----	<i>Saguinus midas</i> -----	1		
Cercopithecidae:				
Toque, or bonnet monkey-----	<i>Macaca sinica</i> -----	3		
Javan macaque-----	<i>Macaca irus mordax</i> -----	2		
Crab-eating macaque-----	<i>Macaca irus</i> -----	1		
Philippine macaque-----	<i>Macaca philippinensis</i> -----	2		
Macaque, hybrid-----	<i>Macaca philippinensis</i> × <i>M. irus</i> -----	1		
Rhesus monkey-----	<i>Macaca mulatta</i> -----	4		
Formosan monkey-----	<i>Macaca cyclopis</i> -----	2		
Red-faced macaque-----	<i>Macaca speciosa</i> -----	1		
Barbary ape-----	<i>Macaca sylvānus</i> -----	14		
Moor macaque-----	<i>Macaca maurus</i> -----	1		
Gray-cheeked mangabey-----	<i>Cercocebus albigena</i> -----	1		
Agile mangabey-----	<i>Cercocebus galeritus agilis</i> -----	1		
Golden-bellied mangabey-----	<i>Cercocebus galeritus chrysogaster</i> -----	1		
Red-crowned mangabey-----	<i>Cercocebus torquatus</i> -----	2		
Sooty mangabey-----	<i>Cercocebus fuliginosus</i> -----	3		
Crested mangabey-----	<i>Cercocebus aterrimus opdenboschii</i> -----	1		
Black-crested mangabey-----	<i>Cercocebus aterrimus</i> -----	2		
Chacma baboon-----	<i>Papio comatus</i> -----	1		
Olive baboon-----	<i>Papio anubis</i> -----	3		
Gelada baboon-----	<i>Theropithecus gelada</i> -----	4		
Vervet guenon-----	<i>Cercopithecus aethiops pygerythrus</i> -----	1		

<i>Family and common name</i>	<i>Scientific name</i>	<i>Number</i>
Cercopithecidae—Continued		
Green guenon.....	<i>Cercopithecus aethiops sabaeus</i>	5
Grivet guenon (color variation).....	<i>Cercopithecus aethiops aethiops</i>	1
Moustached monkey.....	<i>Cercopithecus cephus</i>	3
Diana monkey.....	<i>Cercopithecus diana</i>	1
Roloway monkey.....	<i>Cercopithecus diana roloway</i>	1
Preuss's guenon.....	<i>Cercopithecus lhoesti preussi</i>	1
DeBrazza's guenon.....	<i>Cercopithecus neglectus</i>	2
White-nosed guenon.....	<i>Cercopithecus nictitans</i>	1
Lesser white-nosed guenon.....	<i>Cercopithecus nictitans petaurista</i>	1
Allen's swamp monkey.....	<i>Allenopithecus nigroviridis</i>	2
Spectacled, or Phayre's, langur.....	<i>Presbytis phayrei</i>	1
Entellus, or Hanuman monkey.....	<i>Presbytis entellus</i>	1
Langur.....	<i>Presbytis</i> sp.....	1
Pongidae:		
White-handed gibbon.....	<i>Hylobates lar</i>	5
Wau-wau gibbon.....	<i>Hylobates moloch</i>	1
Gibbon, hybrid.....	<i>Hylobates agilis</i> × <i>H. lar pileatus</i>	1
Gibbon, hybrid.....	<i>Hylobates lar</i> × <i>H. sp</i>	1
Siamang gibbon.....	<i>Symphalangus syndactylus</i>	1
Sumatran orangutan.....	<i>Pongo pygmaeus abelii</i>	2
Bornean orangutan.....	<i>Pongo pygmaeus pygmaeus</i>	1
Chimpanzee.....	<i>Pan satyrus</i>	4
Gorilla.....	<i>Gorilla gorilla</i>	3

EDENTATA

Myrmecophagidae:		
Giant anteater.....	<i>Myrmecophaga tridactyla</i>	1
Bradypodidae:		
Two-toed sloth.....	<i>Choloepus didactylus</i>	8
Dasypodidae:		
Nine-banded armadillo.....	<i>Dasypus novemcinctus</i>	1

LAGOMORPHA

Leporidae:		
Domestic rabbit.....	<i>Oryctolagus cuniculus</i>	7

RODENTIA

Sciuridae:		
Tassel-eared squirrel.....	<i>Sciurus aberti aberti</i>	1
Gray squirrel (albino).....	<i>Sciurus carolinensis</i>	2
Sciuridae:		
Southern fox squirrel.....	<i>Sciurus niger</i>	3
European red squirrel.....	<i>Sciurus vulgaris</i>	4
Indian palm squirrel.....	<i>Funambulus palmarum</i>	1
Giant Indian squirrel.....	<i>Ratufa indica</i>	1
Tricolored, or Prevost's, squirrel.....	<i>Callosciurus prevosti</i>	1
Asiatic squirrel.....	<i>Callosciurus nigrovittatus</i>	1
Formosan tree squirrel.....	<i>Callosciurus erythraeus</i>	1
Woodchuck, or groundhog.....	<i>Marmota monax</i>	3
Prairie-dog.....	<i>Cynomys ludovicianus</i>	8
California ground squirrel.....	<i>Citellus beecheyi</i>	4

<i>Family and common name</i>	<i>Scientific name</i>	<i>Number</i>
Sciuridae—Continued		
Washington ground squirrel.....	<i>Citellus washingtoni</i>	5
Golden-mantled ground squirrel.....	<i>Citellus lateralis</i>	3
Eastern chipmunk.....	<i>Tamias striatus</i>	2
Eastern chipmunk (albino).....	<i>Tamias striatus</i>	1
Yellow pine chipmunk.....	<i>Eutamias amoenus</i>	1
Formosan flying squirrel.....	<i>Petaurista grandis</i>	1
Eastern flying squirrel.....	<i>Glaucomys volans</i>	5
Castoridae:		
Beaver	<i>Castor canadensis</i>	2
Leporidae:		
Cape jumping hare.....	<i>Pedetes caffer</i>	3
Cricetidae:		
White-footed mouse.....	<i>Peromyscus</i> sp.....	7
Golden hamster.....	<i>Mesocricetus auratus</i>	1
East African maned rat.....	<i>Lophiomys ibeanus</i>	3
Pine vole.....	<i>Pitymys pinetorum</i>	3
Gerbil	<i>Gerbillus pyramidum</i>	16
Fat-tailed gerbil.....	<i>Pachyuromys duprasi</i>	30
Jird	<i>Meriones</i> sp.....	4
Hairy-tailed jird.....	<i>Sekectamys calurus</i>	1
Muridae:		
Multimammate rat.....	<i>Mastomys natalensis</i>	1
Slender-tailed cloud rat.....	<i>Phloeomys cumingii</i>	1
Egyptian spiny mouse.....	<i>Acomys cahirinus</i>	14
Egyptian spiny mouse.....	<i>Acomys dimidiatus</i>	25
Hystricidae:		
Malay porcupine.....	<i>Acanthion brachyura</i>	1
African porcupine.....	<i>Hystrix galeata</i>	7
Asiatic crested porcupine.....	<i>Hystrix</i> sp.....	2
Caviidae:		
Patagonian cavy.....	<i>Dolichotis australis</i>	5
Dasyproctidae:		
Red agouti.....	<i>Dasyprocta</i> sp.....	3
Acuchy	<i>Dasyprocta acuchy</i>	2
Chinchillidae:		
Peruvian viscaccia.....	<i>Lagidium viscaccia</i>	1

CARNIVORA

Canidae:		
Dingo	<i>Canis familiaris dingo</i>	3
Coyote	<i>Canis latrans</i>	1
Common jackal.....	<i>Canis aureus</i>	2
Timber wolf.....	<i>Canis lupus nubilus</i>	2
Texas red wolf.....	<i>Canis niger rufus</i>	1
Arctic fox.....	<i>Alopex lagopus</i>	2
Fennec.....	<i>Fennecus zerda</i>	2
Gray fox.....	<i>Urocyon cinereoargenteus</i>	3
Raccoon dog.....	<i>Nyctereutes procyonoides</i>	2
Cape hunting dog.....	<i>Lycan pictus</i>	2
Big-eared fox.....	<i>Otocyon megalotis</i>	1

<i>Family and common name</i>	<i>Scientific name</i>	<i>Number</i>
Ursidae:		
Spectacled bear.....	<i>Tremarctos ornatus</i>	1
Himalayan bear.....	<i>Selenarctos thibetanus</i>	1
Japanese black bear.....	<i>Selenarctos thibetanus japonicus</i> ..	1
Korean bear.....	<i>Selenarctos thibetanus ussuricus</i> ..	2
European brown bear.....	<i>Ursus arctos</i>	3
Iranian brown bear.....	<i>Ursus arctos occidentalis</i>	2
Alaskan Peninsula bear.....	<i>Ursus gyas</i>	1
Grizzly bear.....	<i>Ursus horribilis</i>	2
Black bear.....	<i>Euarctos americanus</i>	1
Polar bear.....	<i>Thalarctos maritimus</i>	2
Hybrid bear.....	<i>Thalarctos maritimus</i> × <i>Ursus middendorffi</i> .	4
Malay sun bear.....	<i>Helarctos malayanus</i>	2
Sloth bear.....	<i>Melursus ursinus</i>	2
Procyonidae:		
Cacomistle, or ring-tailed cat.....	<i>Bassariscus astutus</i>	5
Raccoon.....	<i>Procyon lotor</i>	5
Raccoon (albino).....	<i>Procyon lotor</i>	1
Coatimundi.....	<i>Nassua narica</i>	4
Peruvian coatimundi.....	<i>Nasua nasua dorsalis</i>	1
Kinkajou.....	<i>Potos flavus</i>	4
Olingo.....	<i>Bassaricyon gabbi</i>	2
Lesser panda.....	<i>Ailurus fulgens</i>	5
Mustelidae:		
Ferret.....	<i>Mustela eversmanni</i>	1
Marten.....	<i>Martes americana</i>	1
Fisher.....	<i>Martes pennanti</i>	1
South American tayra.....	<i>Tayra barbara barbara</i>	1
British Guiana tayra.....	<i>Tayra barbara poliocephala</i>	2
Grison.....	<i>Galictis vittata</i>	1
Zorilla, or striped weasel.....	<i>Ictonyx striatus</i>	2
Wolverine.....	<i>Gulo luscus</i>	1
Ratel.....	<i>Mellivora capensis</i>	1
American badger.....	<i>Taxidea taxus</i>	1
Golden-bellied ferret-badger.....	<i>Helictis moschata subaurantiaca</i> ..	3
Common skunk.....	<i>Mephitis mephitis</i>	2
California spotted skunk.....	<i>Spilogale putorius phenax</i>	1
Viverridae:		
Genet.....	<i>Genetta genetta neumannii</i>	7
Genet (black phase).....	<i>Genetta genetta</i>	1
Formosan spotted civet.....	<i>Viverricula indica</i>	2
Linsang.....	<i>Prionodon linsang</i>	1
African palm civet.....	<i>Nandinia binotata</i>	2
Formosan masked civet.....	<i>Paguma larvata taiwana</i>	1
Binturong.....	<i>Arctictis binturong</i>	1
African gray mongoose.....	<i>Herpestes ichneumon</i>	1
African water civet.....	<i>Atilax paludinosus</i>	4
Striped African mongoose.....	<i>Crossarchus fasciatus</i>	2
Black-footed mongoose.....	<i>Bdeogale</i> sp.....	2
White-tailed mongoose.....	<i>Ichneumia albicauda</i>	1

<i>Family and common name</i>	<i>Scientific name</i>	<i>Number</i>
Hyaenidae:		
Striped hyena	<i>Hyaena hyaena</i>	2
Felidae:		
Bobcat	<i>Lynx rufus</i>	2
Lynx	<i>Lynx canadensis</i>	1
Caracal	<i>Lynx caracal caracal</i>	1
Jungle cat	<i>Felis chaus</i>	2
Pallas cat	<i>Felis manul</i>	2
Serval cat	<i>Felis serval</i>	3
Ocelot	<i>Felis pardalis</i>	1
Margay cat	<i>Felis wiedii</i>	5
Golden cat	<i>Felis aurata</i>	1
Puma	<i>Felis concolor</i>	1
Leopard	<i>Panthera pardus</i>	4
Black leopard	<i>Panthera pardus</i>	2
Lion	<i>Panthera leo</i>	6
Bengal tiger	<i>Panthera tigris</i>	2
Bengal tiger (white phase)	<i>Panthera tigris</i>	1
Jaguar	<i>Panthera onca</i>	1
Clouded leopard	<i>Neofelis nebulosa</i>	1
Snow leopard	<i>Uncia uncia</i>	2
Cheetah	<i>Acinonyx jubata</i>	2

PINNIPEDIA

Otariidae:		
California sea-lion	<i>Zalophus californianus</i>	6
Patagonian sea-lion	<i>Otaria flavescens</i>	1
Phocidae:		
Harbor seal	<i>Phoca vitulina</i>	2

TUBULIDENTATA

Orycteropodidae:		
Aardvark, or antbear	<i>Orycteropus afer</i>	1

PROBOSCIDEA

Elephantidae:		
African elephant	<i>Loxodonta africana</i>	1
Forest elephant	<i>Loxodonta cyclotis</i>	1
Indian elephant	<i>Elephas maximus</i>	2

HYRACOIDEA

Procaviidae:		
Hyrax	<i>Procavia sp.</i>	1

PERISSODACTYLA

Equidae:		
Mongolian wild horse	<i>Equus przewalskii</i>	1
Burro, or donkey	<i>Equus asinus</i>	1
Grant's zebra	<i>Equus burchelli boehmi</i>	4
Grevy's zebra	<i>Equus grevyi</i>	2
Tapiridae:		
Brazilian tapir	<i>Tapirus terrestris</i>	2

<i>Family and common name</i>	<i>Scientific name</i>	<i>Number</i>
Rhinocerotidae:		
Great one-horned Indian rhinoceros	<i>Rhinoceros unicornis</i>	1
White, or square-lipped, rhinoceros	<i>Ceratotherium simum</i>	2
African black rhinoceros	<i>Diceros bicornis</i>	2

ARTIODACTYLA

Tayassuidae:		
Collared peccary	<i>Pecari tajacu</i>	4
Hippopotamidae:		
Hippopotamus	<i>Hippopotamus amphibius</i>	3
Pygmy hippopotamus	<i>Choeropsis liberiensis</i>	4
Camelidae:		
Llama	<i>Lama glama</i>	6
Guanaco	<i>Lama glama guanicoe</i>	3
Alpaca	<i>Lama pacos</i>	4
Bactrian camel	<i>Camelus bactrianus</i>	1
Cervidae:		
White fallow deer	<i>Dama dama</i>	4
Axis deer	<i>Axis axis</i>	6
Red deer	<i>Cervus elaphus</i>	5
American elk	<i>Cervus canadensis</i>	1
Sika deer	<i>Cervus nippon</i>	11
Père David's deer	<i>Elaphurus davidianus</i>	1
Virginia deer	<i>Odocoileus virginianus</i>	7
Reindeer	<i>Rangifer tarandus</i>	12
Forest caribou	<i>Rangifer caribou</i>	1
Giraffidae:		
Nubian giraffe	<i>Giraffa camelopardalis camelopardalis</i>	1
Masai giraffe	<i>Giraffa camelopardalis tippelskirchi</i>	2
Antilocapridae:		
Pronghorn	<i>Antilocapra americana</i>	1
Bovidae:		
Sitatunga	<i>Tragelaphus spekkii</i>	1
Brindled gnu, or blue wildebeest	<i>Connochaetes taurinus</i>	3
Anoa	<i>Anoa depressicornis</i>	2
Zebu	<i>Bos indicus</i>	1
Yak	<i>Poephagus grunniens</i>	3
Gaur	<i>Bibos gaurus</i>	2
Cape buffalo	<i>Syncerus caffer</i>	4
American bison	<i>Bison bison</i>	2
Dorcas gazelle	<i>Gazella dorcas</i>	5
Saiga antelope	<i>Saiga tatarica</i>	4
Himalayan tahr	<i>Hemitragus jemlahicus</i>	1
Rocky Mountain goat	<i>Oreamnos americanus</i>	1
African pygmy goat	<i>Capra hircus</i>	3
Ibex	<i>Capra ibex</i>	1
Aoudad	<i>Ammotragus lervia</i>	3
Bighorn sheep	<i>Ovis canadensis</i>	2
Dall sheep	<i>Ovis dalli dalli</i>	1

BIRDS

SPHENISCIFORMES

<i>Family and common name</i>	<i>Scientific name</i>	<i>Number</i>
Spheniscidae:		
King penguin.....	<i>Aptenodytes patagonica</i>	4
Adélie penguin.....	<i>Pygoscelis adeliae</i>	1

STRUTHIONIFORMES

Struthionidae:		
Ostrich.....	<i>Struthio camelus</i>	1

RHEIFORMES

Rheidae:		
Rhea.....	<i>Rhea americana</i>	1

CASUARIIFORMES

Casuariidae:		
Double-wattled cassowary.....	<i>Casuarus bicarunculatus</i>	2
Dromiceidae:		
Emu.....	<i>Dromiccius novaehollandiae</i>	3

TINAMIFORMES

Tinamidae:		
Pileated tinamou.....	<i>Crypturus soui panamensis</i>	1

PROCELLARIIFORMES

Diomedidae:		
Black-footed albatross.....	<i>Diomedea nigripes</i>	2

PELECANIFORMES

Pelecanidae:		
Rose-colored pelican.....	<i>Pelecanus onocrotalus</i>	2
White pelican.....	<i>Pelecanus erythrorhynchos</i>	3
Brown pelican.....	<i>Pelecanus occidentalis occidentalis</i> .	1
Dalmatian pelican.....	<i>Pelecanus crispus</i>	4
Sulidae:		
Gannet.....	<i>Sula bassana</i>	1
Phalacrocoracidae:		
Double-crested cormorant.....	<i>Phalacrocorax auritus auritus</i> ...	3
Farallon cormorant.....	<i>Phalacrocorax auritus albociliatus</i> .	1
European cormorant.....	<i>Phalacrocorax carbo</i>	6

CICONIIFORMES

Ardeidae:		
Reddish egret.....	<i>Dichromanassa rufescens rufescens</i> .	2
Reddish egret (white phase).....	<i>Dichromanassa rufescens rufescens</i> .	1
Cattle egret.....	<i>Bubulcus ibis</i>	5
American egret.....	<i>Casmerodius albus</i>	8
Snowy egret.....	<i>Leucophoyx thula</i>	3
Great white heron.....	<i>Ardea occidentalis</i>	2

Family and common name	Scientific name	Number
Ardeidae—Continued		
Eastern green heron.....	<i>Butorides virescens</i>	3
Louisiana heron.....	<i>Hydranassa tricolor</i>	4
Black-crowned night heron.....	<i>Nycticorax nycticorax</i>	12
Little blue heron.....	<i>Florida caerulea caerulea</i>	4
American bittern.....	<i>Botaurus lentiginosus</i>	1
Least bittern.....	<i>Ixobrychus exilis exilis</i>	1
Tiger bittern.....	<i>Tigrisoma lineatum</i>	2
Cochleariidae:		
Boat-billed heron.....	<i>Cochlearius cochlearius</i>	1
Balaenicipitidae:		
Shoebill.....	<i>Balaeniceps rex</i>	1
Ciconiidae:		
American wood ibis.....	<i>Mycteria americana</i>	2
European white stork.....	<i>Ciconia ciconia</i>	4
Indian adjutant stork.....	<i>Leptoptilos dubius</i>	1
White-bellied stork.....	<i>Abdimia sphenorhyncha</i>	2
Open-billed stork.....	<i>Anastomus oscitans</i>	2
Saddle-billed stork.....	<i>Ephippiorhynchus senegalensis</i>	1
Threskiornithidae:		
White ibis.....	<i>Eudocimus albus</i>	2
Scarlet ibis.....	<i>Eudocimus ruber</i>	8
Black-faced ibis.....	<i>Theristicus melanopis</i>	1
Black-headed ibis.....	<i>Threskiornis melanocephala</i>	1
White-faced glossy ibis.....	<i>Plegadis mexicana</i>	1
Eastern glossy ibis.....	<i>Plegadis falcinellus</i>	4
Roseate spoonbill.....	<i>Ajaia ajaja</i>	6
Phoenicopteridae:		
Chilean flamingo.....	<i>Phoenicopterus chilensis</i>	2
Cuban flamingo.....	<i>Phoenicopterus ruber</i>	1
Old World flamingo.....	<i>Phoenicopterus antiquorum</i>	1
ANSERIFORMES		
Anhimidae:		
Crested screamer.....	<i>Chauna torquata</i>	4
Anatidae:		
Coscoroba swan.....	<i>Coscoroba coscoroba</i>	4
Mute swan.....	<i>Cygnus olor</i>	3
Black-necked swan.....	<i>Cygnus melanocoryphus</i>	2
Whooper swan.....	<i>Olor cygnus</i>	2
Whistling swan.....	<i>Olor columbianus</i>	13
Trumpeter swan.....	<i>Olor buccinator</i>	2
Black swan.....	<i>Chenopsis atrata</i>	9
Egyptian goose.....	<i>Alopochen aegyptiacus</i>	4
White-fronted goose.....	<i>Anser albifrons</i>	3
Indian bar-headed goose.....	<i>Anser indicus</i>	5
Emperor goose.....	<i>Anser canagicus</i>	2
Blue goose.....	<i>Anser caerulescens caerulescens</i>	6
Lesser snow goose (color phase).....	<i>Anser caerulescens caerulescens</i>	2
Greater snow goose.....	<i>Anser caerulescens atlanticus</i>	5
Ross's goose.....	<i>Anser rossii</i>	4
Red-breasted goose.....	<i>Branta ruficollis</i>	4
Canada goose.....	<i>Branta canadensis</i>	24

Family and common name	Scientific name	Number
Anatidae—Continued		
Lesser Canada goose.....	<i>Branta canadensis leucopareia</i>	5
Cackling goose.....	<i>Branta canadensis minima</i>	4
White-cheeked goose.....	<i>Branta canadensis occidentalis</i>	3
Canada goose × blue goose, hybrid.....	<i>Branta canadensis</i> × <i>Anser caerulescens</i>	2
Ruddy shelduck.....	<i>Casarca ferruginea</i>	2
Wood duck.....	<i>Aix sponsa</i>	71
Mandarin duck.....	<i>Aix galericulata</i>	12
Indian cotton teal.....	<i>Nettapus coromandelianus</i>	3
Pintail duck.....	<i>Anas acuta</i>	5
Green-winged teal.....	<i>Anas crecca</i>	1
Chestnut-breasted teal.....	<i>Anas castanea</i>	1
Gadwall.....	<i>Anas strepera strepera</i>	4
European wigeon.....	<i>Anas penelope</i>	2
Mallard duck.....	<i>Anas platyrhynchos</i>	45
Mallard duck × American pintail duck, hybrid.....	<i>Anas platyrhynchos</i> × <i>A. acuta</i>	1
Indian spotted-billed duck.....	<i>Anas poecilorhyncha</i>	1
Black duck.....	<i>Anas rubripes</i>	8
Greater scaup duck.....	<i>Aythya marila</i>	5
Lesser scaup duck.....	<i>Aythya affinis</i>	5
Red-headed duck.....	<i>Aythya americana</i>	7
Ring-necked duck.....	<i>Aythya collaris</i>	1
Canvasback duck.....	<i>Aythya valisineria</i>	5
Rosy-billed pochard.....	<i>Metopiana peposaca</i>	1
Red-crested pochard.....	<i>Netta rufina</i>	1
Bufflehead duck.....	<i>Bucephala albeola</i>	1
American goldeneye duck.....	<i>Bucephala clangula americana</i>	1
Baldpate.....	<i>Mareca americana</i>	10

FALCONIFORMES

Cathartidae:		
Andean condor.....	<i>Vultur gryphus</i>	1
King vulture.....	<i>Sarcoramphus papa</i>	1
Black vulture.....	<i>Coragyps atratus</i>	2
Hooded vulture.....	<i>Necrosyrtes monachus</i>	1
Griffon vulture.....	<i>Gyps fulvus</i>	1
Ruppell's vulture.....	<i>Gyps rüppellii</i>	3
Turkey vulture.....	<i>Cathartes aura</i>	8
Sagittariidae:		
Secretarybird.....	<i>Sagittarius serpentarius</i>	2
Accipitridae:		
African yellow-billed kite.....	<i>Milvus migrans</i>	2
Brahminy kite.....	<i>Haliastur indus</i>	1
Black-faced hawk.....	<i>Leucopternis melanops</i>	1
Red-winged hawk.....	<i>Heterospizias meridionalis</i>	1
Red-tailed hawk.....	<i>Buteo jamaicensis</i>	4
Red-shouldered hawk.....	<i>Buteo lineatus</i>	2
Swainson's hawk.....	<i>Buteo swainsoni</i>	1
Mauduyt's hawk eagle.....	<i>Spizaetus ornatus</i>	1
Long-crested hawk eagle.....	<i>Lophaëtus occipitalis</i>	1

<i>Family and common name</i>	<i>Scientific name</i>	<i>Number</i>
Accipitridae—Continued		
Great black hawk.....	<i>Ictinaetus malayensis</i>	1
Golden eagle.....	<i>Aquila chrysaetos</i>	3
Imperial eagle.....	<i>Aquila heliaca</i>	2
White-breasted sea eagle.....	<i>Haliaeetus leucogaster</i>	1
Pallas's eagle.....	<i>Haliaeetus leucoryphus</i>	1
Bald eagle.....	<i>Haliaeetus leucocephalus</i>	2
Buzzard eagle.....	<i>Buteo poecilochrous</i>	1
Harpy eagle.....	<i>Harpia harpyja</i>	1
Guianan crested eagle.....	<i>Morphnus guianensis</i>	1
Monkey-eating eagle.....	<i>Pithecophaga jefferyi</i>	1
Martial eagle.....	<i>Polemaetus bellicosus</i>	1
Bateleur eagle.....	<i>Terathopius ecaudatus</i>	2
Bearded vulture.....	<i>Gypaëtus barbatus</i>	1
Pandionidae:		
American osprey.....	<i>Pandion haliaetus carolinensis</i>	2
Falconidae:		
Sparrow hawk.....	<i>Falco sparverius</i>	3
Duck hawk.....	<i>Falco peregrinus anatum</i>	1
Feilden's falconet.....	<i>Neohierax cinereiceps</i>	1
Red-footed falcon, or crane hawk.....	<i>Falco vespertinus</i>	1
Large-billed falcon.....	<i>Falco biarmicus</i>	1
Forest falcon.....	<i>Micrastur semitorquatus</i>	2
Chimango.....	<i>Milvago chimango</i>	1
Chimachima hawk.....	<i>Milvago chimachima</i>	2
Audubon's caracara.....	<i>Polyborus cheriway</i>	2
White-throated caracara.....	<i>Phalcoboenus albugularis</i>	2
GALLIFORMES		
Megapodiidae:		
Brush turkey.....	<i>Alectura lathamii</i>	1
Cracidae:		
Wattled curassow.....	<i>Crax globulosa</i>	2
Crested curassow.....	<i>Crax alector</i>	4
Nocturnal curassow.....	<i>Nothocrax urumutum</i>	1
White-headed piping guan.....	<i>Pipile cumanensis</i>	1
Phasianidae:		
Bobwhite, or quail.....	<i>Colinus virginianus</i>	1
Chuckar quail.....	<i>Alectoris graeca</i>	1
Gambel's quail.....	<i>Lophortyx gambeli</i>	2
Valley quail.....	<i>Lophortyx vallicola</i>	6
Argus pheasant.....	<i>Argusianus argus</i>	1
Golden pheasant.....	<i>Chrysolophus pictus</i>	3
Red junglefowl.....	<i>Gallus gallus</i>	6
Black-backed kaleege pheasant.....	<i>Gennaeus melanonotus</i>	2
Silver pheasant.....	<i>Gennaeus nycthemerus</i>	1
Peafowl.....	<i>Pavo cristatus</i>	7
Indian blue peacock.....	<i>Pavo cristatus</i>	1
Ring-necked pheasant.....	<i>Phasianus colchicus</i>	4
Ring-necked pheasant (albino).....	<i>Phasianus colchicus</i>	2
Ring-necked pheasant × green pheasant, hybrid.....	<i>Phasianus colchicus</i> × <i>P. versicolor</i>	1
Bhutan, or gray peacock pheasant.....	<i>Polyplectron bicalcaratum</i>	2

<i>Family and common name</i>	<i>Scientific name</i>	<i>Number</i>
Numididae:		
Vulturine guineafowl.....	<i>Acryllium vulturinum</i>	3
Meleagrididae:		
Ocellated turkey.....	<i>Agriocharis ocellata</i>	2
Wild turkey.....	<i>Melcugris gallopavo</i>	1
GRUIFORMES		
Gruidae:		
Siberian crane.....	<i>Grus leucogeranus</i>	1
European crane.....	<i>Grus grus</i>	2
Sarus crane.....	<i>Antigone antigone</i>	2
African crowned crane.....	<i>Balcarica pavonina</i>	5
Psophiidae:		
Trumpeter.....	<i>Psophia crepitans</i>	2
Rallidae:		
Cayenne wood rail.....	<i>Aramides cajanea</i>	2
Virginia rail.....	<i>Rallus limicola</i>	1
Purple gallinule.....	<i>Ionornis martinica</i>	2
White-breasted waterhen.....	<i>Amaurornis phoenicurus</i>	1
South Pacific swamp-hen.....	<i>Porphyrio poliocephalus</i>	1
Eurypygidae:		
Sun bittern.....	<i>Eurypyga helias</i>	1
Cariamidae:		
Cariama, or seriama.....	<i>Cariama cristata</i>	1
Otididae:		
Kori bustard.....	<i>Eupodotis kori</i>	2
Senegal bustard.....	<i>Eupodotis senegalensis</i>	1
CHARADRIIFORMES		
Jacanidae:		
Common jacana.....	<i>Jacana spinosa</i>	3
Haematopodidae:		
Oystercatcher.....	<i>Haematopus ostralegus</i>	1
Charadriidae:		
Australian banded plover.....	<i>Zonifer tricolor</i>	2
European lapwing.....	<i>Vanellus vanellus</i>	3
South American lapwing.....	<i>Belonopterus cayennensis</i>	4
Crocodile bird.....	<i>Pluvianus aegyptius</i>	7
Recurvirostridae:		
Black-necked stilt.....	<i>Himantopus mexicanus</i>	1
Burhinidae:		
South American thick-knee.....	<i>Burhinus bistriatus</i>	1
Stercorariidae:		
MacCormick's skua.....	<i>Catharacta skua maccormicki</i>	1
Laridae:		
Ring-billed gull.....	<i>Larus delawarensis</i>	3
Kelp gull.....	<i>Larus dominicanus</i>	3
Laughing gull.....	<i>Larus atricilla</i>	3
Herring gull.....	<i>Larus argentatus</i>	1
Great black-backed gull.....	<i>Larus marinus</i>	2
Silver gull.....	<i>Larus novae-hollandiae</i>	6
Noddy tern.....	<i>Anous stolidus</i>	1

COLUMBIFORMES

<i>Family and common name</i>	<i>Scientific name</i>	<i>Number</i>
Columbidae:		
Band-tailed pigeon.....	<i>Columba fasciata</i>	2
High-flying Budapest pigeon.....	<i>Columba livia</i>	1
Black-billed pigeon.....	<i>Columba nigrirostris</i>	1
Triangular spotted pigeon.....	<i>Columba guinea</i>	2
Crowned pigeon.....	<i>Goïra victoria</i>	1
Blue ground dove.....	<i>Claravis pretiosa</i>	4
Ruddy ground dove.....	<i>Chamaepelia rufipennis</i>	1
Indian emerald-winged tree dove.....	<i>Chalcophaps indica</i>	8
Bleeding-heart dove.....	<i>Gallicolumba luzonica</i>	1
Diamond dove.....	<i>Geopelia cuneata</i>	1
Plain-breasted ground dove.....	<i>Columbigallina minuta</i>	8
Ground dove.....	<i>Columbigallina passerina</i>	2
Ring-necked dove.....	<i>Streptopelia decaocto</i>	5
Blue-headed ring dove.....	<i>Streptopelia tranquebarica</i>	2
White-winged dove.....	<i>Zenaida asiatica</i>	1
Mourning dove.....	<i>Zenaidura macroura</i>	1

PSITTACIFORMES

Psittacidae:		
Kea parrot.....	<i>Nestor notabilis</i>	2
Red lory.....	<i>Domicella garrula</i>	1
Banksian cockatoo.....	<i>Calyptorhynchus magnificus</i>	1
White cockatoo.....	<i>Kakatoe alba</i>	1
Solomon Islands cockatoo.....	<i>Kakatoe ducrops</i>	1
Sulphur-crested cockatoo.....	<i>Kakatoe galerita</i>	3
Bare-eyed cockatoo.....	<i>Kakatoe sanguinea</i>	3
Great red-crested cockatoo.....	<i>Kakatoe moluccensis</i>	1
Leadbeater's cockatoo.....	<i>Kakatoe leadbeateri</i>	6
Cockatiel.....	<i>Nymphicus hollandicus</i>	6
Yellow-and-blue macaw.....	<i>Ara araurauna</i>	5
Red-and-blue macaw.....	<i>Ara chloroptera</i>	4
Red-blue-and-yellow macaw.....	<i>Ara macao</i>	2
Illiger's macaw.....	<i>Ara maracana</i>	2
Brown-throated conure.....	<i>Conurus aeruginosus</i>	11
Yellow conure.....	<i>Conurus solstitialis</i>	1
Petz's parakeet.....	<i>Aratinga canicularis</i>	2
Rusty-cheeked parrot.....	<i>Aratinga pertinax</i>	2
Tovi parakeet.....	<i>Brotogeris jugularis</i>	1
Yellow-naped parrot.....	<i>Amazona auropalliata</i>	2
Finsch's parrot.....	<i>Amazona finschi</i>	1
Blue-fronted parrot.....	<i>Amazona aestiva</i>	5
Red-fronted parrot.....	<i>Amazona bodini</i>	1
Double yellow-headed parrot.....	<i>Amazona oratrix</i>	4
Black-headed, or Nanday, parrot.....	<i>Nandayus nanday</i>	7
Lineolated parakeet.....	<i>Bolborhynchus lineolatus</i>	2
White-winged parakeet.....	<i>Brotogeris versicolorus</i>	1
African gray parrot.....	<i>Psittacus erithacus</i>	4
Blossom-headed parakeet.....	<i>Psittacula cyanocephala</i>	9
Greater ring-necked parakeet.....	<i>Psittacula eupatria</i>	2
Rose-breasted parakeet.....	<i>Psittacula alexandri</i>	1
Moustached parakeet.....	<i>Psittacula fasciata</i>	1

Family and common name	Scientific name	Number
Psittacidae—Continued		
Lesser ring-necked parakeet.....	<i>Psittacula krameri</i>	4
Barraband's parakeet.....	<i>Polytelis swainsoni</i>	1
Quaker parakeet.....	<i>Myiopsitta monacha</i>	15
Grass parakeet.....	<i>Melopsittacus undulatus</i>	4
Rosy-faced lovebird.....	<i>Agapornis roseicollis</i>	2
Masked lovebird.....	<i>Agapornis personata</i>	1
Black-headed caique, or seven-color parrot.....	<i>Pionites melanocephala</i>	2
Yellow-thighed caique.....	<i>Pionites leucogaster xanthomeria</i>	1

CUCULIFORMES

Musophagidae:		
Purple-headed turaco.....	<i>Gallirex porphyreolophus</i>	1
South African turaco.....	<i>Tauraco corythax</i>	1
White-bellied go-away bird.....	<i>Corythaxoides leucogaster</i>	1
Plantain-eater.....	<i>Crinifer africanus</i>	1
Cuculidae:		
Koel.....	<i>Eudynamis scolopacea</i>	1
Roadrunner.....	<i>Geococcyx californianus</i>	2
Coucal, or crow-pheasant.....	<i>Centropus sinensis</i>	1

STRIGIFORMES

Tytonidae:		
Barn owl.....	<i>Tyto alba</i>	2
Strigidae:		
Great horned owl.....	<i>Bubo virginianus</i>	2
Screech owl.....	<i>Otus asio</i>	3
Spectacled owl.....	<i>Pulsatrix perspicillata</i>	1
Malay fishing owl.....	<i>Ketupa ketupu</i>	1
Snowy owl.....	<i>Nyctea nyctea</i>	4
Barred owl.....	<i>Strix varia varia</i>	9
Burrowing owl.....	<i>Speotyto cunicularia hypugaea</i>	2
Nepal brown wood owl.....	<i>Strix newarensis</i>	1
Short-eared owl.....	<i>Asio flammeus</i>	2

COLIIFORMES

Coliidae:		
Mousebird.....	<i>Colius striatus</i>	1

TROGONIFORMES

Trogonidae:		
Cuban trogon.....	<i>Priotelus temnurus</i>	1

CORACIIFORMES

Alcedinidae:		
Kookaburra.....	<i>Dacelo gigas</i>	13
Coraciidae:		
Lilac-breasted roller.....	<i>Coracias caudata</i>	2
Indian roller.....	<i>Coracias benghalensis</i>	2
Bucerotidae:		
Pied hornbill.....	<i>Anthracoceros malabaricus</i>	1
Concave-casqued hornbill.....	<i>Buceros bicornis</i>	1
Abyssinian ground hornbill.....	<i>Bucorvus abyssinicus</i>	2

<i>Family and common name</i>	<i>Scientific name</i>	<i>Number</i>
Bucerotidae—Continued		
Leadbeater's hornbill.....	<i>Bucorvus leadbeateri</i>	1
Gray hornbill.....	<i>Tockus birostris</i>	1
Great black-casqued hornbill.....	<i>Ceratogymna atrata</i>	1
Malayan hornbill.....	<i>Aceros undulatus</i>	1
Crowned hornbill.....	<i>Tockus alboterminatus</i>	1
Yellow-billed hornbill.....	<i>Tockus flavirostris</i>	1

PICIFORMES

Capitonidae:		
Asiatic great barbet.....	<i>Megalaima virens</i>	1
Crimson-breasted, or coppersmith, barbet.....	<i>Megalaima haemacephala</i>	1
Toucan barbet.....	<i>Sennornis ramphastinus</i>	1
Ramphastidae:		
Keel-billed toucan.....	<i>Ramphastos culminatus</i>	2
Sulphur-and-white-breasted toucan.....	<i>Ramphastos vitellinus</i>	1
Ariel toucan.....	<i>Ramphastos ariel</i>	4
Cuvier's toucan.....	<i>Ramphastos cuvieri</i>	2
Razor-billed toucanet.....	<i>Pteroglossus castanotis</i>	2
Picidae:		
Golden-backed woodpecker.....	<i>Brachypternus benghalensis</i>	2

PASSERIFORMES

Tyrannidae:		
Kiskadee flycatcher.....	<i>Pitangus sulphuratus</i>	4
Acadian flycatcher.....	<i>Empidonax virescens</i>	2
Eastern kingbird.....	<i>Tyrannus tyrannus</i>	1
Pittidae:		
Indian pitta.....	<i>Pitta brachyura</i>	1
Alaudidae:		
Horned lark.....	<i>Eremophila alpestris</i>	2
Corvidae:		
Magpie.....	<i>Pica pica</i>	4
Yellow-billed magpie.....	<i>Pica nuttalli</i>	1
Asiatic tree pie.....	<i>Crypsirina formosae</i>	2
Magpie jay.....	<i>Calocitta formosa</i>	1
Blue jay.....	<i>Cyanocitta cristata</i>	1
European jay.....	<i>Garrulus glandarius</i>	2
African white-necked crow.....	<i>Corvus albus</i>	2
American crow.....	<i>Corvus brachyrhynchos</i>	3
Raven.....	<i>Corvus corax</i>	2
Indian crow.....	<i>Corvus splendens</i>	1
Formosan red-billed pie.....	<i>Cissa caerulea</i>	5
Occipital blue pie.....	<i>Cissa occipitalis</i>	1
Chinese cissa, or hunting crow.....	<i>Cissa chinensis</i>	3
Inca jay.....	<i>Xanthoura yncas</i>	1
Paridae:		
Gray tit.....	<i>Parus major</i>	1
Green-backed tit.....	<i>Parus monticolus</i>	1
Tufted titmouse.....	<i>Parus bicolor</i>	1
Sittidae:		
Chestnut-bellied nuthatch.....	<i>Sitta castanea</i>	1

<i>Family and common name</i>	<i>Scientific name</i>	<i>Number</i>
Timaliidae:		
Red-eyed babbler.....	<i>Chrysomma sinense</i>	4
Scimitar babbler.....	<i>Pomatorhinus schisticeps</i>	1
White-crested laughing thrush.....	<i>Garrulax bicolor</i>	4
Black-headed sibia.....	<i>Heterophasia capistrata</i>	2
Silver-eared mesia.....	<i>Mesia argentauris</i>	3
Pekin robin.....	<i>Leiothrix luteus</i>	9
Crested yuhina.....	<i>Yuhina flavicollis</i>	2
Pycnonotidae:		
Red-eared bulbul.....	<i>Pycnonotus jocosus</i>	1
Black-headed bulbul.....	<i>Pycnonotus atriceps</i>	3
Red-vented bulbul.....	<i>Pycnonotus cafer</i>	5
White-cheeked bulbul.....	<i>Pycnonotus leucogenys</i>	5
White-eared bulbul.....	<i>Pycnonotus leucotis</i>	1
Mimidae:		
Mockingbird.....	<i>Mimus polyglottos</i>	1
Catbird.....	<i>Dumetella carolinensis</i>	3
Turdidae:		
Wood thrush.....	<i>Hylocichla mustelina</i>	20
Robin (albino).....	<i>Turdus migratorius</i>	1
European song thrush.....	<i>Turdus ericetorum</i>	2
Blackbird.....	<i>Turdus merula</i>	2
Cliff chat.....	<i>Thamnota cinnamomeiventris</i>	1
White-capped redstart.....	<i>Chaimarrhornis leucocephalus</i>	1
Muscicapidae:		
Veriter flycatcher.....	<i>Muscicapa thalassina</i>	1
Bombycillidae:		
Cedar waxwing.....	<i>Bombycilla cedrorum</i>	2
Sturnidae:		
Rose-colored pastor.....	<i>Pastor roseus</i>	1
Purple starling.....	<i>Lamprocolius purpureus</i>	3
Burchell's long-tailed starling.....	<i>Lamprotornis caudatus</i>	1
Amethyst starling.....	<i>Cinnyricinclus leucogaster</i>	1
Tri-colored starling.....	<i>Spreo superbus</i>	1
Starling.....	<i>Sturnus vulgaris</i>	2
Jungle mynah.....	<i>Aceridotheres tristis</i>	1
Lesser hill mynah.....	<i>Gracula religiosa indica</i>	3
Greater Indian hill mynah.....	<i>Gracula religiosa intermedia</i>	2
Nectariniidae:		
Scarlet-chested sunbird.....	<i>Chalcomitra rubescens</i>	1
Variable sunbird.....	<i>Cinnyris venustus raceis</i>	2
Scarlet-tufted malachite sunbird.....	<i>Nectarinia johnstoni</i>	2
Beautiful sunbird.....	<i>Nectarinia pulchella</i>	1
Purple sunbird.....	<i>Nectarinia asiatica</i>	1
Tecasse sunbird.....	<i>Nectarinia tacazze</i>	1
Zosteropidae:		
White-eye.....	<i>Zosterops palpebrosa</i>	6
Vireonidae:		
Red-eyed vireo.....	<i>Vireo olivaceus</i>	1
Chloropseidae:		
Blue-winged fruit-sucker.....	<i>Chloropsis hardwickei</i>	2

<i>Family and common name</i>	<i>Scientific name</i>	<i>Number</i>
Coerebidae:		
Black-headed sugarbird.....	<i>Chlorophanes spiza</i>	2
Purple sugarbird.....	<i>Cyanerpes coccyula</i>	4
Blue, or yellow-winged, sugarbird....	<i>Cyanerpes cyaneus</i>	1
Bananaquit	<i>Coereba flavcola</i>	1
Parulidae:		
Kentucky warbler.....	<i>Oporornis formosus</i>	1
Redstart	<i>Setophaga ruticilla</i>	1
Ovenbird	<i>Sciurus aurocapillus</i>	2
Ploceidae:		
Red-naped widowbird.....	<i>Coliuspasser laticauda</i>	10
Giant whydah.....	<i>Diathropura procne</i>	1
Baya weaver.....	<i>Ploceus baya</i>	3
Vitelline masked weaver.....	<i>Ploceus vitellinus</i>	5
Mahali weaver.....	<i>Ploceipasser mahali</i>	1
Red bishop weaver.....	<i>Euplectes orix</i>	1
White-headed nun.....	<i>Lonchura maja</i>	4
Indian silverbill.....	<i>Lonchura malabarica</i>	1
Bengalese finch.....	<i>Lonchura sp.</i>	6
Cut-throat weaver finch.....	<i>Amadina fasciata</i>	2
Lavender finch.....	<i>Estrilda coccytescens</i>	2
Strawberry finch	<i>Estrilda amandava</i>	1
Red-eared waxbill.....	<i>Estrilda astrild</i>	1
Common waxbill.....	<i>Estrilda troglodytes</i>	1
Zebra finch.....	<i>Poephila castanotis</i>	10
Gouldian finch.....	<i>Poephila gouldiae</i>	1
Java sparrow.....	<i>Padda oryzivora</i>	13
Icteridae:		
Yellow-headed marshbird.....	<i>Xanthocephalus xanthocephalus</i>	1
Rice grackle.....	<i>Psomocolax oryzivora</i>	1
Purple grackle.....	<i>Quiscalus quiscula</i>	4
Swainson's grackle.....	<i>Holoquiscalus lugubris</i>	1
Boat-tailed grackle.....	<i>Megaquiscalus major</i>	1
Glossy cowbird.....	<i>Molothrus bonariensis</i>	2
Brown-headed cowbird.....	<i>Molothrus ater</i>	2
Bay cowbird.....	<i>Molothrus badius</i>	2
Colombian red-eyed cowbird.....	<i>Tangavius armenti</i>	1
Red-winged blackbird.....	<i>Agelaius phoeniceus</i>	4
Red-breasted marshbird.....	<i>Leistes militaris</i>	8
Thraupidae:		
Palm tanager.....	<i>Tanagra palmarum</i>	1
Blue tanager.....	<i>Thraupis cana</i>	2
White-edged tanager.....	<i>Thraupis leucoptera</i>	2
Yellow-rumped tanager.....	<i>Ramphocelus icteronotus</i>	1
Passerini's tanager.....	<i>Ramphocelus passerinii</i>	1
Maroon, or silver-beaked, tanager....	<i>Ramphocelus jacapa</i>	3
Scarlet tanager.....	<i>Piranga olivacca</i>	5
Red tanager.....	<i>Piranga rubra</i>	1
Fringillidae:		
Tropical seed finch.....	<i>Oryzoborus angpicensis</i>	3
Rice grosbeak.....	<i>Oryzoborus crassirostris</i>	1
Evening grosbeak.....	<i>Hesperiphona vespertina</i>	3

Family and common name	Scientific name	Number
Fringillidae—Continued		
Black-throated cardinal	<i>Paroaria gularis</i>	5
Black-eared cardinal	<i>Paroaria gularis nigro</i>	1
Cardinal	<i>Richmondia cardinalis</i>	3
European linnet	<i>Carduelis cannabina</i>	4
European goldfinch	<i>Carduelis carduelis</i>	3
European goldfinch × canary (hybrid)	<i>Carduelis carduelis</i> × <i>Serinus canarius</i>	1
Canary	<i>Serinus canarius</i>	2
Green finch	<i>Chloris chloris</i>	1
Lesser yellow finch	<i>Sicalis luteola</i>	2
Saffron finch	<i>Sicalis flaveola</i>	5
White-lined finch	<i>Spermophila lineola</i>	5
European bullfinch	<i>Pyrrhula pyrrhula</i>	1
Melodious grassquit	<i>Tiaris canora</i>	1
Chaffinch	<i>Fringilla coelebs</i>	1
Slate-colored junco	<i>Junco hyemalis</i>	1
Buff-throated saltator	<i>Saltator maximus</i>	1
Tawny-bellied seedeater	<i>Sporophila minuta</i>	9
Song sparrow	<i>Melospiza melodia</i>	1
Dickeissel	<i>Spiza americana</i>	5
White-throated sparrow	<i>Zonotrichia albicollis</i>	1
White-crowned sparrow	<i>Zonotrichia leucophrys</i>	2
Yellowhammer	<i>Emberiza citrinella</i>	1
European bunting	<i>Emberiza calandra</i>	2
Jacarini finch	<i>Volatinia jacarini</i>	5

REPTILES

LORICATA

Alligatoridae:

Caiman	<i>Caiman sclerops</i>	3
Black caiman	<i>Melanosuchus niger</i>	8
American alligator	<i>Alligator mississippiensis</i>	16
Chinese alligator	<i>Alligator sinensis</i>	2

Crocodilidae:

Broad-nosed crocodile	<i>Osteolaemus tetraspis</i>	2
African crocodile	<i>Crocodylus niloticus</i>	3
Narrow-nosed crocodile	<i>Crocodylus cataphractus</i>	1
Salt-water crocodile	<i>Crocodylus porosus</i>	1
American crocodile	<i>Crocodylus acutus</i>	1

Gavialidae:

Indian gavial	<i>Gavialis gangeticus</i>	1
---------------	----------------------------	---

CHELONIA

Chelydridae:

Snapping turtle	<i>Chelydra serpentina</i>	20
Alligator snapping turtle	<i>Macrochelys temminckii</i>	1

Kinosternidae:

Musk turtle	<i>Sternotherus odoratus</i>	4
Mud turtle	<i>Kinosternon subrubrum</i>	5
South American mud turtle	<i>Kinosternon creuntatum</i>	1

<i>Family and common name</i>	<i>Scientific name</i>	<i>Number</i>
Emydidae:		
Box turtle.....	<i>Terrapene carolina</i>	91
Three-toed box turtle.....	<i>Terrapene carolina</i>	2
Ornate box turtle.....	<i>Terrapene ornata</i>	1
Florida box turtle.....	<i>Terrapene bauri</i>	5
Kura kura box turtle.....	<i>Cuora amboinensis</i>	2
Diamondback turtle.....	<i>Malaclemys terrapin</i>	4
Map turtle.....	<i>Graptemys geographica</i>	2
False map turtle.....	<i>Graptemys pseudogeographica</i>	2
Barbour's map turtle.....	<i>Graptemys barbouri</i>	4
Painted turtle.....	<i>Chrysemys picta</i>	10
Western painted turtle.....	<i>Chrysemys picta belli</i>	13
Cumberland turtle.....	<i>Pseudemys scripta troostii</i>	7
South American red-lined turtle.....	<i>Pseudemys scripta callirostris</i>	2
Yellow-bellied turtle.....	<i>Pseudemys scripta scripta</i>	15
Red-bellied turtle.....	<i>Pseudemys rubriventris</i>	9
Red-eared turtle.....	<i>Pseudemys scripta elegans</i>	34
Southern water turtle.....	<i>Pseudemys floridana</i>	7
Florida red-bellied turtle.....	<i>Pseudemys nelsoni</i>	2
Central American turtle.....	<i>Pseudemys ornata</i>	2
Cuban water turtle.....	<i>Pseudemys decussata</i>	1
Chicken turtle.....	<i>Deirochelys reticularia</i>	2
Spotted turtle.....	<i>Clemmys guttata</i>	3
Wood turtle.....	<i>Clemmys insculpta</i>	5
Iberian pond turtle.....	<i>Clemmys leprosa</i>	2
European water terrapin.....	<i>Clemmys caspica rivulata</i>	14
European pond turtle.....	<i>Emys orbicularis</i>	3
Blanding's turtle.....	<i>Emys blandingii</i>	2
Reeves' turtle.....	<i>Chinemys reevesii</i>	4
Testudinidae:		
Giant Aldabra tortoise.....	<i>Testudo elephantina</i>	2
Galapagos tortoise.....	<i>Testudo vicina</i>	2
Duncan Island tortoise.....	<i>Testudo ephippium</i>	2
South American tortoise.....	<i>Testudo denticulata</i>	5
Star tortoise.....	<i>Testudo elegans</i>	1
European tortoise.....	<i>Testudo graeca</i>	1
Mountain tortoise.....	<i>Testudo emys</i>	2
Texas gopher tortoise.....	<i>Gopherus berlandieri</i>	2
Pelomedusidae:		
African water turtle.....	<i>Pelomedusa subrufa</i>	2
African black mud turtle.....	<i>Pelusios nigricans</i>	1
Amazon spotted turtle.....	<i>Podocnemis unifilis</i>	2
Chelydidae:		
South American side-necked turtle.....	<i>Batrachemys nasuta</i>	2
Australian side-necked turtle.....	<i>Chelodina longicollis</i>	3
Small side-necked turtle.....	<i>Hydromedusa tectifera</i>	2
Large side-necked turtle.....	<i>Phrynops hilarii</i>	8
Kreff's turtle.....	<i>Emydura krefftii</i>	3
Murray turtle.....	<i>Emydura macquarrii</i>	3
South American gibba turtle.....	<i>Mesoclemmys gibba</i>	2
Flat-headed turtle.....	<i>Platemys platycephala</i>	3

<i>Family and common name</i>	<i>Scientific name</i>	<i>Number</i>
Trionychidae:		
Southern soft-shelled turtle-----	<i>Trionyx ferox</i> -----	4
Texas soft-shelled turtle-----	<i>Trionyx emoryi</i> -----	1
African soft-shelled turtle-----	<i>Trionyx triunguis</i> -----	2
SAURIA		
Gekkonidae:		
Giant gecko-----	<i>Gekko stentor</i> -----	1
Tokay gecko-----	<i>Gekko gecko</i> -----	27
Day gecko-----	<i>Phelsuma cepedianum</i> -----	3
Day gecko-----	<i>Phelsuma sp.</i> -----	2
Iguanidae:		
Common iguana-----	<i>Iguana iguana</i> -----	1
Carolina anole-----	<i>Anolis carolinensis</i> -----	50
Texas horned lizard-----	<i>Phrynosoma cornutum</i> -----	10
Fence lizard-----	<i>Sceloporus undulatus</i> -----	2
Texas spiny lizard-----	<i>Sceloporus olivaceus</i> -----	2
Crevice spiny lizard-----	<i>Sceloporus poinsetti</i> -----	3
Cuban spiny lizard-----	<i>Lciocephalus varius</i> -----	2
Collared lizard-----	<i>Crotaphytus collaris</i> -----	3
Spiny-tailed iguana-----	<i>Ctenosaura acanthura</i> -----	3
Ameiva lizard-----	<i>Ameiva ameiva ameiva</i> -----	6
Ameiva lizard-----	<i>Ameiva ameiva praesignis</i> -----	1
Agamid lizard-----	<i>Hoplurus saviicola</i> -----	2
Chuckwalla-----	<i>Sauromalus hispidus</i> -----	1
Scincidae:		
Mourning skink-----	<i>Egernia luctuosa</i> -----	2
White's skink-----	<i>Egernia whitei</i> -----	4
Shirt-lined skink-----	<i>Eumeces brevilineatus</i> -----	5
Greater five-lined skink-----	<i>Eumeces fasciatus</i> -----	1
Great Plains skink-----	<i>Eumeces obsoletus</i> -----	2
Broad-headed skink-----	<i>Eumeces laticeps</i> -----	1
Sand skink-----	<i>Scinus officinalis</i> -----	2
Stump-tailed skink-----	<i>Tiliqua rugosa</i> -----	1
Malayan skink-----	<i>Mabuya multifasciata</i> -----	2
Gerrhosauridae:		
African plated lizard-----	<i>Zonosaurus sp.</i> -----	2
Madagascar plated lizard-----	<i>Zonosaurus madagascariensis</i> ---	3
Bronze plated lizard-----	<i>Zonosaurus acneus</i> -----	1
Plated lizard-----	<i>Gerrhosaurus major</i> -----	1
Plated lizard-----	<i>Gerrhosaurus validus</i> -----	2
Lacertidae:		
European green lizard-----	<i>Lacerta viridis</i> -----	9
European green lizard-----	<i>Lacerta strigata trilineata</i> -----	8
Teiidae:		
Yellow tegu-----	<i>Tupinambis teguixin</i> -----	4
Race runner-----	<i>Cnemidophorus sacki gularis</i> ---	1
Teiid lizard-----	<i>Cnemidophorus sp.</i> -----	3
Cordylidae:		
South African spiny lizard-----	<i>Cordylus vandami perkoensis</i> ---	2
Varanidae:		
Dumeril's monitor-----	<i>Varanus dumerili</i> -----	2
Indian monitor-----	<i>Varanus flavescens</i> -----	1

Family and common name	Scientific name	Number
Varanidae—Continued		
Malayan monitor.....	<i>Varanus salvator</i>	1
Philippine monitor.....	<i>Varanus nuchalis</i>	4
Helodermatidae:		
Gila monster.....	<i>Heloderma suspectum</i>	1
Mexican beaded lizard.....	<i>Heloderma horridum</i>	1
Beaded lizard (black phase).....	<i>Heloderma horridum alvernensis</i> ..	1
Anguidae:		
Glass lizard.....	<i>Ophisaurus ventralis</i>	3
European glass lizard.....	<i>Ophisaurus apodus</i>	2

SERPENTES

Boidae:		
Anaconda	<i>Eunectes murinus</i>	1
Cook's tree boa.....	<i>Boa enydrii cooki</i>	5
Emerald tree boa.....	<i>Boa caninus</i>	2
Boa constrictor.....	<i>Constrictor constrictor</i>	2
Emperor boa.....	<i>Constrictor imperator</i>	1
Cuban ground boa.....	<i>Tropidophis melanura</i>	1
Rainbow boa.....	<i>Epicrates cenchria</i>	3
Cuban tree boa.....	<i>Epicrates angulifer</i>	3
Sand boa.....	<i>Eryx conica</i>	1
Ball python.....	<i>Python regius</i>	2
Indian rock python.....	<i>Python molurus</i>	2
Regal python.....	<i>Python reticulatus</i>	5
Acrochordidae:		
Elephant trunk snake.....	<i>Acrochordus javanicus</i>	1
Colubridae:		
King snake.....	<i>Lampropeltis getulus getulus</i>	1
Speckled king snake.....	<i>Lampropeltis getulus holbrooki</i> ..	3
California king snake.....	<i>Lampropeltis getulus californiae</i> ..	1
Florida king snake.....	<i>Lampropeltis getulus floridae</i>	1
Sonoran king snake.....	<i>Lampropeltis getulus splendida</i> ..	3
Scarlet king snake.....	<i>Lampropeltis triangulum doliata</i> ..	1
Milk snake.....	<i>Lampropeltis triangulum</i>	1
Tropical king snake.....	<i>Lampropeltis polyzona</i>	1
Garter snake.....	<i>Thamnophis sirtalis sirtalis</i>	2
Garter snake (melanistic phase).....	<i>Thamnophis sirtalis sirtalis</i>	2
Black-necked garter snake.....	<i>Thamnophis cyrtopsis ocellata</i>	1
Ribbon snake.....	<i>Thamnophis sauritus</i>	1
Western hognose snake.....	<i>Heterodon nasicus</i>	1
Water snake.....	<i>Natrix sipedon</i>	2
Red-bellied water snake.....	<i>Natrix erythrogaster</i>	1
Island water snake.....	<i>Natrix insularum</i>	2
European grass snake.....	<i>Natrix natrix natrix</i>	4
European water snake.....	<i>Natrix natrix persa</i>	2
Brazos water snake.....	<i>Natrix harteri</i>	2
Water snake.....	<i>Natrix harteri paucimaculata</i>	2
Diamondback water snake.....	<i>Natrix rhombifera</i>	1
Tessellated water snake.....	<i>Natrix tessellata</i>	4
Tessellated water snake (green phase). phase).	<i>Natrix tessellata</i>	2
Queen snake.....	<i>Natrix septemvittata</i>	1

Family and common name	Scientific name	Number
Colubridae—Continued		
Indigo snake.....	<i>Drymarchon couperi</i>	1
Pilot black snake.....	<i>Elaphe obsoleta obsoleta</i>	3
Pilot black snake (albino).....	<i>Elaphe obsoleta obsoleta</i>	1
Corn snake.....	<i>Elaphe obsoleta guttata</i>	2
Fox snake.....	<i>Elaphe vulpina</i>	2
Asiatic rat snake.....	<i>Elaphe taeniura</i>	2
Lindheimer's rat snake.....	<i>Elaphe lindheimeri</i>	1
Great Plains rat snake.....	<i>Elaphe emoryi</i>	2
Chicken snake.....	<i>Elaphe quadrivittata</i>	2
Aesculapian snake.....	<i>Elaphe longissima subgrisea</i>	7
Formosan rat snake.....	<i>Dinodon rufozonatum</i>	4
Oshima rat snake.....	<i>Zaocys oshimai</i>	1
Cat-eyed snake.....	<i>Leptodeira annulata</i>	1
Black racer.....	<i>Coluber constrictor constrictor</i>	1
European racer.....	<i>Coluber jugularis caspius</i>	2
European racer (melanistic phase).....	<i>Coluber viridiflavus</i>	1
Red racer.....	<i>Masticophis flagellum frenatum</i>	1
Western coachwhip.....	<i>Masticophis flagellum testaceus</i>	3
Ring-necked snake.....	<i>Diadophis punctatus edwardsii</i>	1
Lesser Indian rat snake.....	<i>Elaphe carinata</i>	9
Eastern worm snake.....	<i>Carphophis amoenus</i>	1
DeKay's snake.....	<i>Storeria dekayi</i>	1
Rough green snake.....	<i>Ophiodrys aestivus</i>	2
Green whip snake.....	<i>Dryophis prasinus</i>	1
Bull snake.....	<i>Pituophis catenifer sayi</i>	2
Great Basin gopher snake.....	<i>Pituophis catenifer deserticola</i>	1
Greater Indian rat snake.....	<i>Ptyas mucosus</i>	4
European malpolon.....	<i>Malpolon monspessulanus</i>	2
File snake.....	<i>Simocephalus cepensis</i>	1
Wolf snake.....	<i>Lycodon flavomaculatus</i>	1
Tantilla snake.....	<i>Tantilla gracilis</i>	2
Texas long-nosed snake.....	<i>Rhinocheilus lecontei tessellatus</i>	2
Formosan green snake.....	<i>Liopeltis major</i>	2
Cat-eyed snake.....	<i>Eteirodipsas</i> sp.....	1
Green-headed tree snake.....	<i>Leptophis mexicanus</i>	1
Elapidae:		
Indian cobra.....	<i>Naja naja</i>	1
Taiwan cobra.....	<i>Naja naja atra</i>	12
King cobra.....	<i>Ophiophagus hannah</i>	2
Many-banded krait.....	<i>Bungarus multicinctus</i>	10
Crotalidae:		
Southern copperhead.....	<i>Ancistrodon contortrix contortrix</i>	1
Northern copperhead.....	<i>Ancistrodon contortrix mokeson</i>	4
Western broad-banded copperhead.....	<i>Ancistrodon contortrix laticinctus</i>	2
Water moccasin, or cottonmouth.....	<i>Ancistrodon piscivorus</i>	2
Asian snorkel viper.....	<i>Ancistrodon acutus</i>	1
Green palm viper.....	<i>Trimeresurus gramineus</i>	29
Stejneger's palm viper.....	<i>Trimeresurus stejnegeri</i>	3
Mamushi, or Asiatic viper.....	<i>Trimeresurus elegans</i>	1
Habu, or Asiatic viper.....	<i>Trimeresurus flavoviridis</i>	1

Family and common name	Scientific name	Number
Crotalidae—Continued		
Taiwan habu.....	<i>Trimercsurus okinavensis</i>	4
Western diamondback rattlesnake....	<i>Crotalus atrox</i>	13
Timber rattlesnake.....	<i>Crotalus horridus</i>	5
Canebrake rattlesnake.....	<i>Crotalus atricaudatus</i>	1
Viperidae:		
Gaboon viper.....	<i>Bitis gabonica</i>	2
European viper (melanistic phase)...	<i>Vipera berus</i>	1
European viper.....	<i>Vipera ammodytes meridionalis</i> ...	1
European viper.....	<i>Vipera ammodytes montandoni</i> ...	2
European viper.....	<i>Vipera ammodytes ammodytes</i> ...	2
Russell's viper.....	<i>Vipera russellii</i>	2

AMPHIBIANS

CAUDATA

Amphiumidae:		
Congo eel.....	<i>Amphiuma means</i>	1
Ambystomidae:		
Spotted salamander.....	<i>Ambystoma maculatum</i>	1
Salamandridae:		
Japanese red-bellied newt.....	<i>Dicmietylus pyrrhogaster</i>	8
Red-spotted newt.....	<i>Dicmietylus viridescens</i>	11

SALIENTIA

Bufonidae:		
American toad.....	<i>Bufo terrestris americanus</i>	1
Blomberg's toad.....	<i>Bufo blombergi</i>	2
Giant toad.....	<i>Bufo marinus</i>	5
Cuban toad.....	<i>Bufo pellocephalus</i>	6
Pelobatidae:		
European spadefoot toad.....	<i>Pelobates fuscus</i>	4
Pipidae:		
Surinam toad.....	<i>Pipa pipa</i>	15
African clawed frog.....	<i>Xenopus laevis</i>	4
Congo pygmy frog.....	<i>Hymenochirus</i> sp.....	2
Leptodaelylidae:		
Colombian horned frog.....	<i>Ceratophrys calcarata</i>	2
Hylidae:		
Barking tree frog.....	<i>Hyla gratiosa</i>	3
Green tree frog.....	<i>Hyla cinerea</i>	1
Cuban tree frog.....	<i>Hyla septentrionalis</i>	3
European tree frog.....	<i>Hyla arborea</i>	8
Gray tree frog.....	<i>Hyla versicolor</i>	2
Microhylidae:		
Narrow-mouthed toad.....	<i>Microhyla carolinensis</i>	2
Ranidae:		
African bull frog.....	<i>Rana adspersa</i>	1
American bull frog.....	<i>Rana catesbeiana</i>	1
Green frog.....	<i>Rana clamitans melanota</i>	1
Leopard frog.....	<i>Rana pipiens</i>	25

FISHES

NEOCERATODONTOIDEI

Family and common name	Scientific name	Number
Protopterygidae:		
African lungfish	<i>Protopterus annectens</i>	2

OSTARIOPHYSOIDEI

Characidae:		
Piranha	<i>Serrasalmus niger</i>	1
Metynnis	<i>Metynnis roosevelti</i>	1
Black tetra	<i>Gymnocorymbus ternetzi</i>	1
Cyprinidae:		
Zebrafish	<i>Brachydanio rerio</i>	4
Tiger barb	<i>Puntius partipentazona</i>	2
White Cloud Mountain fish	<i>Tanichthys albonubes</i>	8
Electrophoridae:		
Electric eel	<i>Electrophorus electricus</i>	8
Gymnotidae:		
African knifefish	<i>Sternarchella schotti</i>	1

CYPRINODONTOIDEI

Poeciliidae:		
Flag-tailed guppy	<i>Lebistes reticulatus</i>	10
Guppy	<i>Lebistes reticulatus</i>	15
Black mollie	<i>Mollienesia latipinna</i>	3
Platy, or moonfish	<i>Xiphophorus maculatus</i>	2

PERCOMORPHOIDEI

Anabantidae:		
Climbing perch	<i>Anabas testudineus</i>	3
Cichlidae:		
Peacock cichlid	<i>Astronotus ocellatus</i>	1
Egyptian mouthbreeder	<i>Haplochromis multicolor</i>	3
African mouthbreeder	<i>Pelmatochromis belladorsalis</i>	2
Angelfish	<i>Pterophyllum eimekei</i>	2
Jack Dempsey fish	<i>Cichlasoma biocellatum</i>	8
Jewelfish	<i>Hemichromis bimaculatus</i>	1
Loricariidae:		
South American catfish	<i>Plecostomus plecostomus</i>	2

ARTHROPODS

DECAPODA

Cenobitidae:		
Land hermit crab	<i>Coenobita clypeatus</i>	23
Gecareinidae:		
Florida blue land crab	<i>Cardisoma guanhumi</i>	2

ARANEIDA

Theridiidae:		
Black-widow spider	<i>Latrodectus mactans</i>	1
Aviculariidae:		
Tarantula	<i>Eurypelma</i> sp.	1

ORTHOPTERA

<i>Family and common name</i>	<i>Scientific name</i>	<i>Number</i>
Blattidae:		
Tropical giant cockroach-----	<i>Blaberus giganteus</i> -----	30

MOLLUSKS

PULMONATA

Planorbidae:		
Pond snail-----	<i>Helisoma trivolvis</i> -----	30

REORGANIZATION

A reorganization of management of the National Zoological Park was completed during the year. The number of departments was reduced from five to three, headed by the office of the director.

The functions of the animal department, under Dr. W. T. Roth, were increased to include the veterinary and commissary divisions. This department also has reptile, bird, small mammal, and large mammal divisions. It provides for the development, identification, classification, and care of the zoological collection. The veterinary division provides medical care for the collection. The commissary division provides food for the animals. The duties of the reptile, bird, small mammal, and large mammal divisions include cleaning of enclosures, feeding and watering the animals, observing and inspecting for signs of sickness or injury, and administering prescriptions as ordered.

A scientific research department, under J. Lear Grimmer, was created, and at the present time is operating with one division, the information and education division. A research division will be formed at a later date. This department provides zoological research, educational, and informational programs and activities. The information and education division designs, creates, and maintains all signs, enclosure labels, and directional aids (with the exception of police traffic signs) and prepares for publication and distribution information about the National Zoological Park and the animal collection.

The administrative services department, under Travis E. Fauntleroy, Jr., includes the mechanical, police, grounds, and services divisions. This department provides administrative and operational services necessary for support of the functions of the National Zoological Park. The mechanical division constructs, renovates, repairs, and maintains the buildings. The police division protects the buildings, grounds, facilities, property, employees, and visitors. The grounds division provides gardening, tree care, and grounds maintenance. The service division provides operational services, including

procurement and supply, custodial and labor activities, transportation service, vehicle and motorized equipment maintenance, restrooms, telephone switchboard, and messenger service.

PERSONNEL

William R. James, captain of the National Zoological Park police since 1953, died at the age of 62 on December 21, 1961. He had been an employee of the Park since 1922 and on the police force since 1929. The quiet, efficient manner in which he handled his work won him the respect not only of his fellow employees but also of the thousands of visitors whom he befriended.

The director was one of the 10 "outstanding young men" of the year in Government service to receive the Arthur Flemming Award.

In September the director visited a number of western zoos to study new construction in connection with the forthcoming construction program at the National Zoological Park. He also attended the annual conference of the American Association of Zoological Parks and Aquariums in Rochester, N.Y., and was elected secretary of the association for 1961-62.

Two new positions were filled: Dr. Waldfried T. Roth became general curator of the National Zoological Park on August 7, 1961; Miss Marion McCrane was appointed zoologist on April 17, 1962. She has been assigned to the information and education division and is working on a project to design new labels for the entire collection.

Dr. James F. Wright, appointed veterinarian at the Zoo on August 5, 1957, resigned on June 30, 1962, to take a position in the U.S. Public Health Service. In addition to his regular duties in the Park, Dr. Wright has made a valuable contribution to the study of the projectile syringe and its use in capturing and treating wild animals.

Tony Wallace, who came to the Zoo as a mason November 27, 1933, retired May 26, 1962; and George Schmedegaard, an animal keeper since April 10, 1948, retired June 30, 1962. Samuel Beeler, animal keeper, was recalled to military service on September 30, 1961.

Thomas Schneider, animal keeper, was promoted to medical technologist.

In the fiscal year 1962 there were 205 authorized positions in the Zoo: Administrative office, 17, an increase of 1 (zoologist); animal department, 80, an increase of 4 (1 commissary steward, 2 night keepers, 1 biologist); mechanical department, 64, an increase of 3 (1 subjourneyman, 2 laborers); police department, 33; grounds department, 11.

FRIENDS OF THE NATIONAL ZOO

The Friends of the National Zoo, a group of civic-minded citizens, continued their interest in the development and expansion of the Zoo. Robert McLaughlin, former Commissioner of the District of Columbia, was elected president of the organization. Its membership has been kept informed on plans for the modernization of the Zoo, and at a luncheon on February 21 the director showed the Friends the master plan for a 10-year capital outlay program for the Zoo.

The Friends are actively backing plans for a "Breeding Zoo" in this country, to be established possibly as a cooperative venture by American zoos under the direction of the Federal Government, and John Perry, former president of the Friends, contributed an article to the Saturday Evening Post (April 7, 1962) dealing with the necessity of some sort of "Operation Rescue" for animals now threatened with extinction.

From June 1 to June 10 the Friends sponsored a "Home Show for Birds," which took place outside the birdhouse. The many types of birdhouses, feeding stations, and bird baths displayed attracted much favorable attention, not only from visitors but also from the native wild birds.

On June 6 the Friends gathered for their annual night visit of the Park, and saw many of the animals under nocturnal conditions.

INFORMATION AND EDUCATION

The Zoo continues to handle a large correspondence with persons all over the world and from every part of this country who write to the Zoo, as a national institution, for information regarding animals, proper diet, or treatment of disease. Visitors to the office as well as to the animal exhibits are constantly seeking information.

An innovation this year was the showing of films made of Zoo animals over the new educational TV station in Washington, Station WETV, channel 26. Five programs dealing with mammals, birds, reptiles, and amphibians were beamed to the children of Maryland, Virginia, and the District of Columbia. Lulu, the baby chimpanzee, appeared on a Science Program entitled "Space," and her keeper, Mr. Gallagher, spoke of the contributions chimpanzees have made to space travel. One of this year's lion cubs appeared on channel 4, WRC-TV, with M. Brown, keeper in charge of the lion house.

The director addressed the annual meeting of the Dallas (Tex.) Zoological Society on October 23, 1961. He also gave two radio talks and several illustrated lectures to local clubs and civic organizations, as well as a lecture on the white tiger to a Smithsonian

Institution seminar. He assisted WMAL-TV in taping a Zoo program, which was broadcast on April 14, and advised Parthenon Pictures of Hollywood on the Zoo section of a travel film they were making of Washington, D.C.

Dr. James F. Wright gave many illustrated talks on the use of the projectile syringe in immobilizing or treating wild animals. Among the groups he addressed were the School of Veterinary Medicine, University of Pennsylvania; the Zoo Veterinary Association of the American Veterinary Medical Association, meeting in Detroit, Mich.; the Veterinary Pathology group of the Armed Forces Institute of Pathology; Biological Society of Washington; Grayson Laboratory personnel of the University of Maryland.

Sgt. Marvin Jones, U.S. Army, now stationed at Fort Myer, made a signal contribution to the history of the Zoo by reorganizing the card catalog of mammals in the collection since 1888 and publishing a mimeographed list giving the scientific name, common name, date when each species was first exhibited, date of the first birth of a species in the collection, and designating by an asterisk the animals still living in the Zoo on June 30, 1962.

Ordinarily the Zoo does not conduct guided tours of the Park, but exceptions were made for three groups of handicapped children and adults. Mrs. Perle Mesta and Miss Jane Russell sponsored the visit on June 18 of 52 children from WAIF (World Adoption International Foundation). The occasion was the adoption of the 10,000th child by American parents under this foundation.

On July 13, 1961, 1,842 foreign students from 50 different countries toured the Zoo; on May 12, 1962, the school patrol, consisting of 6,336 students from all parts of the country, came to the Park following their annual parade on Constitution Avenue.

The Virginia Herpetological Society held its annual meeting in the reptile house on August 11, 1961. The American Society of Ichthyologists and Herpetologists, holding its 42d Annual Meeting in Washington, came to the Zoo on Sunday morning, June 17, and about 100 scientists were shown the reptile house before the regular visiting hours.

REPORT OF THE VETERINARIAN

In the Annual Reports for 1960 and 1961 reference was made to the similarity, both clinically and pathologically, of a central nervous system syndrome occurring in monkeys at the Park to the "Acute Amaurotic Epilepsy" described by Langdon and Cadwallader in 1915 and Van Bogaert and Scherer in 1935. Since the last Annual Report four additional cases have been seen clinically in young monkeys, one of which was euthanized for viral isolation studies, the others being

still under observation. The euthanized individual was an 8-month-old female sooty mangabey (*Cercocebus fuliginosus*); the three monkeys under observation are two 10-month-old Barbary apes (*Macaca sylvanus*), one male and one female, and one hybrid macaque (*M. philippinensis* × *M. irus*). Tissues were also taken for viral isolation attempts from two black-crested mangabeys (*Cercocebus aterrimus*) with histories of at least one CNS seizure. One of these monkeys was apparently blind without visible defect in the eyes, and both seemed normal in all other respects.

Although no viral agents were isolated from the black-crested mangabeys mentioned above, the histopathological sections of the blind animal showed enough lesions in the optic nerve to account for its blindness. It has not been determined what was responsible for these lesions although they appear to be of long standing. No viral agent has been demonstrated in the tissues from the 8-month-old sooty mangabey described above. All viral isolation attempts included culture and intracerebral mouse and hamster inoculation.

The three remaining young macaques still under observation have been free from seizures and any other abnormal clinical signs for approximately 3 months.

The virus isolation attempts were performed by Dr. Anthony Morris, chief of the Section on Respiratory Viruses of the Laboratory of Virology and Rickettsiology, Division of Biologics Standards, National Institutes of Health.

From the past 4 years' experience with this condition, several facts became apparent. First, the condition has occurred only in Old World monkeys, the Cercopithecoidea (except for one gibbon, *Hyllobates* sp.). It has involved the genera *Macaca*, *Cercocebus*, *Cercopithecus*, and *Hyllobates* (one case), with the genus *Macaca* most often noted. Second, there seems to be no relation to the habitat of the animal, some cases appearing in a closed exhibit building, others in all-season outdoor cages, and one case in a monkey that had been raised in a keeper's home from the day of birth. Third, the condition is first seen when the animal is usually less than a year old. Both sexes have been affected but females predominate. Fourth, those animals which have died usually did so after the first or second noted CNS seizure. Several animals which had one or two seizures in their first year have been followed until age 2½ without report of additional seizures and without apparent blindness. Fifth, in none of the cases has there been any diarrhea during or after the seizure, nor had there been any evidence of inappetence. Some animals which had been eating at the onset of the seizure began to eat again within minutes after the attack, and there was no animal noted that did not eat within the day.

In spite of the previous points, the histopathological and microbiological studies to date on these monkeys seem to support the premise that the condition is not infectious but probably toxic. At this time the possibility of lead poisoning cannot be completely ruled out.

Parasites.—Identification of parasites from the animal collection was made by the Beltsville Parasitological Laboratory of the U.S. Department of Agriculture. The nematodes, acanthocephalids, and linguatilids were identified by M. B. Chitwood; trematodes, ticks, and mites by Dr. A. McIntosh; and cestodes by W. W. Becklund.

Bacteriology.—Tuberculosis was found to be the cause of death in four animals, two bighorn sheep, a female wisent, and an aged female gaur. The infections in the bighorn sheep and the gaur were classified as the bovine type of organism by Dr. A. G. Karlson, of the Mayo Clinic, Rochester, Minn.

Dr. J. R. Wadsworth of the Department of Animal Pathology of the University of Vermont continued to assist the Zoo with his interpretation of suspected tumor tissues from the collection.

Whenever possible, hearts and large vessels of necropsy specimens are saved for Dr. Thomas Perry, of the George Washington University School of Medicine, for his study of comparative pathology of these organs.

Dr. F. R. Lucas, director of the Livestock Sanitary Laboratory, Centreville, Md., provided clinical laboratory services and microscopic tissue reports.

Dr. K. F. Meyer, of the George Williams Hooper Foundation of the University of California, assisted the Park by determining the complement fixation titers of quarantined psittacine birds to the psittacosis antigen. He also advised the Park on a feeding and treatment regimen for all quarantined birds.

Black-bear project.—At the request of the National Park Service, a field trip was made to the Great Smoky Mountains National Park in early August 1961 to instruct park personnel in the use of the Cap-Chur equipment. Each year in several of the National Parks "rogue" bears cause personal injuries to visitors and thousands of dollars in property damage. Usually the park personnel know the individual troublesome bears by sight, but the culvert trap method of removing or translocating the bear is not always successful. Furthermore, a troublesome bear once trapped and returned is most likely to be trap shy. During approximately 6 days of field work, 20 free-ranging American black bears were injected, using the Cap-Chur equipment. Five individuals were underdosed and did not react to the drug; one syringe did not inject because of mechanical difficulties; and two bears escaped from the area during the latent period of the drug and so it could not be determined whether the dose was effective. Five bears were immo-

bilized and released after measurements, one crippled bear was immobilized and euthanized, and six were immobilized, placed in the mobile culvert traps, and translocated to the extreme boundary of the park. The drug used in these immobilization procedures was succinylcholine chloride; the estimated average immobilizing dose was 0.46 mg. per pound of estimated body weight, the average latent period of the drug was 2 minutes, and the average recovery period was 15 minutes. No difficulties were encountered from overdosage, and the animals usually showed very little reaction to the injection. Almost all immobilizations were completely carried out from the main highway which runs through the park. This field work served to support earlier theories that the bear (including all species) is the ideal subject for immobilization with the drug succinylcholine chloride. The regional director, National Park Service, commented on the project: "The results and conclusions of these tests as reported indicate that the method shows promise as a practicable means of capturing dangerous or nuisance bears for relocation or other disposition."

Following are the statistics for the mortality rates at the Zoo during the past fiscal year and a table of comparison with the past 7 fiscal years:

Cause	Mortality, fiscal year 1962			Total mortality, past 7 years	
	Reptiles	Birds	Mammals		
No autopsy for sundry reasons ¹	155	121	32	1956.....	618
Attrition (within 7 days after arrival)...	(²)	2	21	1957.....	549
Intern. diseases ³	54	66	45	1958.....	550
Infect. diseases ⁴	2	28	4	1959.....	472
Parasites.....	7	12		1960.....	532
Injuries, accidents.....	1	5	12	1961.....	517
Euthanasia.....		1	6
Total.....	219	245	120	1962.....	584

¹ Reasons include preserving of intact specimen for Museum and research, progressed decomposition, insufficient remains in case of predators, *et al.*

² No figures available.

³ Internal diseases include acute and chronic diseases of lung, liver, kidney, and heart, and intestinal ailments other than parasite involvement, as well as CNS disorders.

⁴ Infectious diseases include TB, viremia, toxoplasmosis, coccidiosis, *et al.*

The only fossa (*Cryptoprocta ferow*) in the United States, as far as was known, died on January 6, 1962. This largest of the Malagasy carnivores was acquired from Ivan T. Sanderson on October 6, 1954, as a fully adult specimen and showed obvious signs of senility during his last years at the Zoo. Post-mortem findings indicated no specific disease but rather a general physical deterioration due to old age.

The horned toad (*Ceratophrys ornata*) mentioned in last year's Annual Report died on August 7, 1961. This specimen had been collected by the National Zoological Park Expedition to Argentina and was received in the Zoo June 27, 1939. It died after 22 years 1 month 11 days in captivity.

A Malay fishing owl (*Ketupa ketupu*), collected as an adult by the National Geographic Society-Smithsonian Expedition to Netherlands East Indies in 1937, died on June 24, 1962, after 24 years 8 months 26 days in the collection.

COOPERATION

At all times special efforts are made to maintain friendly contacts with other Federal and State agencies, private concerns and individuals, and scientific workers for mutual assistance. As a result, the Zoo receives much help and advice and many valuable animals, and in turn it furnishes information and, whenever possible, animals it does not need.

In cooperation with the State Department, a bald eagle was sent to Berlin, to be presented by Attorney General Robert Kennedy to the West Berlin Zoo.

Through the cooperation of the U.S. Fish and Wildlife Service, a number of waterfowl were obtained for the Zoo. Senior keeper W. Widman made a trip to Washington, N.C., to collect a pair of swans and a number of ducks.

Special acknowledgment is due George Kirk and John Pulaski, in the office of the Dispatch Agent in New York City, and Stephen E. Lato, Dispatch Agent in San Francisco, who are frequently called upon to clear shipments of animals coming from abroad, often at great personal inconvenience—late at night, or on a weekend.

When it is necessary to quarantine animals coming into this country, they are taken to the U.S. Department of Agriculture's station in Clifton, N.J. During the past year Dr. B. C. Swindell and Andy Goodel, two of the officials stationed there, have been most cooperative in keeping the National Zoological Park informed as to the well-being of animals and birds being held there for quarantine.

The reptile division is frequently called upon by hospitals or police for help in identifying snakes or snake bites. This year senior keeper M. DePrato collaborated with Dr. George B. Rabb of the Chicago Zoological Society by assembling information on crocodylians to be published in book form. The division also helped the Navy take photographs of all poisonous snakes and lizards in the collection, these to appear in a field manual for Navy personnel.

Perhaps the most important project undertaken by the reptile division was in cooperation with Dr. Bert N. Ladu and Dr. Jerome J.

Kamm, National Institutes of Health, in connection with a biochemical study of snake venom. NIH was particularly interested in venom from an Asiatic pit viper and arranged for 20 specimens to be sent to the National Zoological Park and cared for in the reptile house. The habus (*Trimeresurus*) of three different species arrived on September 15, and were milked by Mr. DePrato and keeper Lee D. Schmeltz. National Institutes of Health reported: "Research workers made use of *Trimeresurus flavoviridis* venom in biochemical experiments. The venom from this species contains an agent, still unidentified, which is not found in other venoms. This agent has the ability to digest or solubilize the walls of submicroscopic particles [microsomes] of mammalian liver. Microsomes contain enzyme systems which metabolize many types of drugs, such as barbiturates, analgesics, and hypnotics, but biochemical studies on these enzyme systems have been handicapped because the microsomal particles could not be solubilized by other methods. Making this venom available to NIH biochemists will permit them to accomplish this important step and thereby learn more about how drugs are metabolized in the liver."

The National Zoological Park arranged a large-scale shipment of American mammals and birds for the new zoo of Delhi, India. The general curator of the animal department accompanied the shipment and safely delivered 2 coyotes, 2 porcupines, 2 coatimundis, 2 foxes, 1 bear, 1 paca, 1 ocelot, 2 raccoons, 2 opossums, 2 whistling swans, 3 Virginia deer, 2 bison, and 2 pumas, and during the absence of the director of the Delhi Zoo instructed the zoo personnel there in the maintenance and husbandry requirements of this collection. Arrangements for the shipment were made by the Ambassador of the United States to India, the Honorable J. Kenneth Galbraith. Fred Stark, director of the San Antonio (Tex.) Zoo, contributed the pair of bison, and Walter Stone, director of Franklin Park Zoo in Boston, Mass., supplied the porcupines, bear, paca, ocelot, and coatimundis. The Virginia deer were a contribution from the West Virginia Game Commission. The remainder of the stock came from the collection at the National Zoo.

The director of the Zoo and the general curator spent 2 days in Boston as consultants for the Franklin Park Zoo and the Middlesex Fells Zoo in Stoneham, Mass., both of which are planning new construction.

The office of forest fire prevention, U.S. Department of Agriculture, installed a new exhibit at Smokey Bear's cage consisting of a set of large photographs showing the devastation caused by forest fires and the capture of a small singed bear. In a glass case are Smokey's hat, belt, trousers, shovel, and a jug of honey. This was in answer to the complaints frequently heard from small children who had expected Smokey to be dressed as a forest ranger.

Animals that die in the Zoo are offered to the U.S. National Museum. This year 23 animals were sent to the Museum and there preserved as scientific specimens. If the Museum does not need the animals, they are sent on request to research workers in other institutions.

The Zoo cooperated with the National Capital Parks and lent small animals to Park naturalists and to the Nature Center in Rock Creek Park for demonstration.

VISITORS

Work continued on developing a new method of estimating total visitor attendance, as mentioned in last year's Annual Report. This is being done in cooperation with Albert Mindlin and Sidney Starobin, statisticians of the management office of the District of Columbia.

Number of bus groups visiting the Zoo in fiscal year 1962

Locality	Number of groups	Number in groups	Locality	Number of groups	Number in groups
Alabama.....	26	1, 180	Mississippi.....	6	246
Arkansas.....	1	26	New Hampshire.....	3	115
Connecticut.....	8	374	New Jersey.....	29	1, 102
Delaware.....	12	469	New York.....	236	7, 874
District of Columbia..	204	7, 762	North Carolina.....	78	7, 134
Florida.....	83	3, 120	Ohio.....	51	1, 939
Georgia.....	90	3, 750	Pennsylvania.....	333	13, 261
Illinois.....	12	442	Rhode Island.....	14	585
Indiana.....	4	170	South Carolina.....	51	2, 130
Kansas.....	1	40	Tennessee.....	45	1, 807
Kentucky.....	6	232	Texas.....	1	48
Louisiana.....	1	32	Vermont.....	3	111
Maine.....	8	286	Virginia.....	844	34, 255
Maryland.....	1, 154	45, 880	West Virginia.....	86	3, 473
Massachusetts.....	13	438	Wisconsin.....	16	527
Michigan.....	38	1, 492			
Minnesota.....	2	90	Total.....	3, 459	140, 390

Groups from foreign countries

Brazil.....	1	21	Japan.....	1	30
Canada.....	1	30	Korea.....	1	37
Denmark.....	1	21	Norway.....	2	68
France.....	1	30	Foreign students.....	54	1, 842
Germany.....	1	17			
			Total.....	64	2, 113

About 2 p.m. each day the cars then parked in the Zoo are counted and listed according to the State or country from which they come. This is, of course, not a census of the cars coming to the Zoo but is

valuable in showing the percentage of attendance by States of people in private automobiles. Many District of Columbia, Maryland, and Virginia cars come to the Zoo to bring guests from other States. The tabulation for the fiscal year 1962 is as follows :

	<i>Percentage</i>		<i>Percentage</i>
Maryland -----	33.2	Massachusetts -----	0.8
Virginia -----	23.6	Connecticut -----	.6
District of Columbia -----	20.6	South Carolina -----	.6
Pennsylvania -----	4.1	California -----	.5
New York -----	2.6	Illinois -----	.5
North Carolina -----	2.0	Michigan -----	.5
New Jersey -----	1.3	Tennessee -----	.5
Ohio -----	1.3	Georgia -----	.4
Florida -----	1.1	Indiana -----	.4
West Virginia -----	1.1	Alabama -----	.3

The remaining 4 percent came from other States, Canada, Canal Zone, England, France, Germany, Guam, Japan, Mexico, Nova Scotia, Panama, and Puerto Rico.

On the days of even small attendance there are cars parked in the Zoo from at least 15 States, the District of Columbia, and foreign countries. On average days there are cars from about 22 States, the District of Columbia, and foreign countries; and during the periods of greatest attendance the cars represent no less than 34 different States and countries.

POLICE DEPARTMENT

After the death of Capt. William R. James (see p. 166), who had been commanding officer of the police force since 1952, Lt. C. R. Brink was promoted to the rank of captain on March 4, 1962. Lt. J. R. Wolfe, who joined the department in 1946, was appointed executive officer. E. A. King and D. B. Bell were promoted from sergeant to lieutenant, and A. S. Kadlubowski and C. S. Grubbs were promoted from private to the rank of sergeant.

A notable improvement in the police department was the installation of a two-way radio hookup between the station and the police car. This new means of communication has facilitated stronger law enforcement.

The practice of using temporary men during the busy season (April to October) continues to prove a highly satisfactory arrangement. Otherwise, the ever-increasing number of special details and assignments would result, at times, in reducing the number of regular officers available for patrol duty.

The total number of visitors stopping in the police station for information of various sorts was 9,027.

The police pistol range has been improved by the erection of a 7-foot-high safety fence on all sides. A request from the chief of

domestic operations division, Office of Security, Department of State, for the use of the pistol range was granted and a weekly program has been put into operation.

Pvt. G. R. Nicoloff was assigned as a permanent rider of the mounted section, making a total of four mounted officers. This will insure having two men riding each day to give better patrolling along the creek, and a horseman assigned to patrol the bridle paths and isolated wooded areas on Sundays and holidays. The mounted color guard continues to participate in local parades.

Sgts. A. L. Canter and C. S. Grubbs received citations in March from the American Red Cross for services rendered as first-aid instructors. The total number of first-aid cases handled by police throughout the year was 1,004.

Juvenile arrests totaled 115. A special file has been set up to handle this increase in petty misbehavior acts by juveniles. Fifty-three truant children were picked up, and appropriate action was taken; and 196 lost children were returned to their parents or school groups. The police also have charge of lost and found articles; whenever these are claimed by their owners they are returned, but 26 pairs of eyeglasses and sunglasses were sent to the Society for the Prevention of Blindness, and 3 bags of clothing and miscellaneous articles, unclaimed, were turned over to the Goodwill Industries.

The police department is closely associated with the Metropolitan Police Department of the District of Columbia, the U.S. Park Police, and police departments of nearby counties of Maryland and Virginia. The department has been aided by the D.C. Chapter, American Red Cross, which has assigned personnel to the Zoo on such days as Easter Monday, School Boy Patrol Day, and other times when unusually large crowds of children are expected. The assistance given by the Red Cross in treating minor injuries (such as skinned knees and insect bites) is greatly appreciated. The District of Columbia Fire Department Ambulance and Rescue Squad responds to calls for transporting sick or injured persons to local hospitals when necessary.

An article on the activities of the National Zoological Park police appeared in "Policeman's Association News" for October 1961.

SAFETY SUBCOMMITTEE

The National Zoological Park safety subcommittee, consisting of Lt. John R. Wolfe, chairman; Dr. James F. Wright, administration office; Capt. C. E. Brink, police department; Bert J. Barker, animal department; Reily Straw, maintenance and construction; Michael Dubik of the grounds department; and Mrs. W. M. Holden of the Smithsonian Institution, secretary, held monthly meetings to suggest, discuss, and make recommendations to the director on safety improvements.

The safety manuals for the animal, grounds, and maintenance departments are printed and in effect. The police safety manual is in press. Each employee is issued a copy of a safety manual and is responsible for carrying out the prescribed safety measures.

The safety improvements program was continued during the year with the cooperation of the District of Columbia Department of Buildings and Grounds. The hazardous unbroken flight of steps from the main bear line to the seal pool was removed and other access provided under this program. The roofs on both wings of the reptile house were replaced and roof ventilators were installed to correct the poor air circulation in the visitor area. Also included in the program was the replacement of 890 square yards of walkway pavement, 5,431 lineal feet of fencing, and handrails on all steps throughout the Park having three or more risers.

Among the miscellaneous safeguards installed during the year were a blinker stoplight at the small door to the reptile house basement; lanterns provided to the shop to mark excavations in progress; reinforcement of the guard railing outside the elephant house; new summer and winter doors for the front of the lion house; exit lights in the small mammal building, reptile house, and monkey house. New traffic signs were put up, and all traffic and crosswalk lines were repainted.

MAINTENANCE, CONSTRUCTION, AND GROUNDS

The work of the maintenance and construction department varied from picking up and disposing of the ever-increasing amount of refuse and trash to major construction necessary in maintaining the existing buildings and grounds and providing new shelters and enclosures for the animals exhibited.

The giraffe cage, both inside and out, at the elephant house, was completely rebuilt for the Masai giraffes received on September 30, 1961. Ironwork in the cage and partitions was redesigned so as to eliminate all wood, a possible source of contamination; the ground in the outside cage was removed to a depth of 6 inches and replaced; inside and outside cages were steam cleaned and sterilized prior to repainting.

Reconstruction of the main bear line, started in 1960, was continued during the summer of 1961. Two new partition walls were built, designed to conform with those built during the previous years except that pneumatically-placed concrete was used in lieu of poured-in-place concrete, with resulting savings in time, labor, and material. Five pools were repaired, the largest of which was practically rebuilt, again using sprayed or gunned rather than poured concrete. The wooden beds in all dens were replaced.

The puma house came in for its share of the maintenance program. The west half of the inside wooden dens was removed and rebuilt. Outside, concrete paving and copings were repaired or replaced.

The downstairs office rooms in the east wing of the administration building, more than 100 years old, were refurbished following the replacement of the wood floor which had yielded to the onslaught of time and termites. Asphalt tile over the new concrete, an acoustical tile ceiling, and repainted walls and woodwork were included in the project. At the request of the division of political history of the Smithsonian Institution, a window pane from one of the upstairs rooms was removed and taken to the Institution. Visitors to the house had scratched political slogans on the glass with diamonds: "Down with Hickory's enemies"; "Huzzah for Old Hickory"; "Old Hickory Forever." One was dated 1827.

The large second-floor room at the reptile house was redone and made suitable for use as an auditorium.

The rewiring of the small mammal house was completed. A new main electrical distributing panel and a separate panel for the motors operating the ventilating system and heating controls were included in the rewiring.

A welcome improvement to the Park was the development of a large picnic area south of and adjoining the restaurant.

The grounds department continued to plant and service trees. A snow fence was put up in certain areas to deter visitors from trampling on newly planted shrubbery. Logs were used to terrace banks and protect them from erosion. It was the work of this department to remove excess soil and debris after construction jobs were done. The department continued to provide perches, hollow logs, and forage for the animals.

Agencies which provided the Zoo with plants in exchange for compost included the U.S. Plant Introduction Center, the D.C. Water Department, the National Arboretum, Walter Reed Hospital, the U.S. Botanical Gardens, and the Bureau of Naval Weapons.

PLANS FOR THE FUTURE

A master plan for the development and growth of the National Zoological Park was submitted by the architectural and engineering firm of Daniel, Mann, Johnson & Mendenhall on September 11, 1961. This plan was accepted in principle by the director and by the Board of Regents of the Smithsonian Institution. It also received the endorsement of the National Capital Planning Commission and the Fine Arts Commission.

Plans and specifications for the first phase of the reconstruction are now being prepared. Work under this phase will consist of a

modernization of the existing birdhouse and the adjacent outside exhibit areas, and the construction of an east-west perimeter road which will ultimately take the automobile traffic from the center of the Park.

The director and the staff of the National Zoological Park are working with the architects and engineers in furnishing requirements and design criteria to be followed in the development of the Zoo. An experimental panel employing the use of high tensile strength wires stretched vertically with no horizontal ties so as to be almost invisible to the viewer, yet contain the exhibited birds, has been installed between two of the hawk cages. Various species of birds will be put into this experimental enclosure to determine the optimum spacing of the vertical wires.

Plans were made by the National Capital Parks for the relocation of Beach Drive from the west side of Rock Creek to the east side, tunneling under the hill where the administration building stands. Certain limited areas of land on the east side of the creek will be turned over to National Capital Parks. This will provide a 24-hour, all-weather, north-south road connecting Potomac Parkway and Rock Creek Park. It will not be within the boundary or jurisdiction of the National Zoological Park. Work will be started in the next fiscal year.

Respectfully submitted.

THEODORE H. REED, *Director.*

Dr. LEONARD CARMICHAEL,
Secretary, Smithsonian Institution.

Report on the Canal Zone Biological Area

SIR: It gives me pleasure to present herewith the annual report on the Canal Zone Biological Area for the fiscal year ended June 30, 1962.

SCIENTISTS, STUDENTS, AND OBSERVERS

Following is the list of 85 scientists, students, and observers who made use of the Canal Zone Biological Area facilities on the mainland and/or visited Barro Colorado Island last year and stayed for several days in order to conduct scientific research or observe the wildlife of the area. In addition, scientists of other research and technical organizations in the Canal Zone and the Republic of Panama made use of station facilities.

<i>Name</i>	<i>Principal interest</i>
Andrews, Michael L., Sussex, England.	Wildlife photography.
Baker, Ann, Long Island, N.Y.	Birds.
Barghoorn, Dr. and Mrs. Elso S., Harvard University.	Limnology.
Bernstein, Dr. Irwin S., Emory University.	Rhesus monkeys.
Blest, Dr. Andrew D., University College, London.	Lepidopteran behavior.
Booth, Dr. and Mrs. Ernest S., Escondido, Calif.	Wildlife photography.
Booth, Shirley, Escondido, Calif.	Wildlife photography.
Buchsbaum, Ralph University of Pittsburgh.	Wildlife photography.
Burns, Mrs. Marjorie, Escondido, Calif.	Wildlife photography.
Campbell, Mr. and Mrs. Carlton I., Smithsonian Institution.	Inspection of facilities.
Campbell, Milton, University of Illinois.	Coleoptera.
Christiansen, James, University of Utah.	Assistant to Dr. Legler.
Collett, T. S., University College, London.	Assistant to Dr. Blest.
Collier, Dr. Gerald, San Diego State College.	Jaçana behavior and ecology.
Cottam, Dr. Grant, University of Wisconsin.	Plant morphology, physiology, and behavior.

<i>Name</i>	<i>Principal interest</i>
Darnall, Mr. and Mrs. J. S., Dyersburg, Tenn.	Wildlife observation.
Darnall, Mrs. Ruth, Chicago, Ill.	Wildlife observation.
Deusing, Mr. and Mrs. Murl, Baileys Harbor, Wis.	Wildlife photography.
Dwyer, Dr. John., St. Louis University.	Botany.
Evans, Jeremy, Harvard University.	Insect physiology.
Florey, Dr. and Mrs. Ernst, University of Washington.	Wildlife observation.
Gazin, Dr. and Mrs. Charles L., Smithsonian Institution.	Vertebrates.
Greenwell, Francis M., Smithsonian Institution.	Assistant to Dr. Handley.
Handley, Dr. Charles O., Smithsonian Institution.	Mammals.
Hayward, Dr. and Mrs. C. Lynn, Brigham Young University.	Wildlife observation.
Heatwole, Dr. Harold, University of Puerto Rico.	Assistant to Dr. Sexton.
Hartshorne, Mr. and Mrs. Charles, Atlanta, Ga.	Bird vocal patterns.
Hodge, Dr. Walter H., National Science Foundation.	Inspection of facilities.
Holgerson, Dr. Holger, Stavanger, Norway.	Insects and littoral marine organisms.
Hughes-Schrader, Dr. Sally, Duke University.	Cytology and cytotaxonomy of Mantis- pidae and Pentatomidae.
Hunt, George, Harvard University.	Flycatcher behavior and ecology.
Izower, Jack, New York, N.Y.	Tanagers and finches.
Jackson, Mr. and Mrs. B. L., Washington, D.C.	Wildlife observation.
Jones, Dr. Duvall A., Madison College.	Birds and amphibians.
Kamstedt, Brit I. S., Stavanger, Norway.	Assistant to Dr. Holgerson.
Keck, Dr. David D., National Science Foundation.	Inspection of facilities.
Knight, Dennis, University of Wisconsin.	Plant morphology, physiology, and behavior.
Legler, Dr. John M., University of Utah.	Turtles and entomology.
Livingston, Dr. Luzern G., Swarthmore College.	Diatoms.
Loftin, Horace, Florida State University.	Fresh-water fishes.
Olding, Mr. and Mrs. D., Mannings School, Jamaica, B.W.I.	Wildlife observation.

<i>Name</i>	<i>Principal interest</i>
O'Neill, John P., Norman, Okla.	Wildlife observation.
Owen, Mr. and Mrs. Herbert, Bremerton, Wash.	Wildlife observation.
Peebles, Dr. James S. University of Utah.	Assistant to Dr. Legler.
Pipkin, Mrs. Sarah B. Gorgas Memorial Laboratory.	Fruit flies.
Pope, Dr. and Mrs. W. Gorgas Hospital, Ancon, C.Z.	Wildlife observation.
Proctor, Vernon W. Texas Technological College.	Algae.
Ream, Dr. and Mrs. Robert, University of Wisconsin.	Plant morphology, physiology, and behavior.
Rubinoff, Dr. and Mrs. Ira, Harvard University.	Ichthyology.
Ruckes, Dr. and Mrs. Herbert, American Museum of Natural His- tory.	Hemiptera.
Rudd, Dr. Velva, Smithsonian Institution.	Botany.
Schmitt, Mr. and Mrs. Rupert, Manitowish Water, Wis.	Wildlife observation.
Schorach, Mr. and Mrs. Carl B. Ventura, Calif.	Wildlife observation.
Sexton, Dr. Owen J., Washington University.	Amphibians and reptiles.
Smith, Dr. W. John, Harvard University.	Flycatcher behavior.
Stuart, Dr. Alastair M., University of Chicago.	Termites.
Stull, Dr. Arthur, Washington, D.C.	Wildlife observation.
Taylor, Mr. and Mrs. R. W. Harvard University.	Ants.
Tyson, Edwin L. Florida State University.	Bats.
Waldes, Mrs. Rosaline, Long Island, N.Y.	Bird observation.
Walker, John, Encyclopaedia Britannica, New York, N.Y.	Wildlife photography.
Watson, H., Canal Zone.	Wildlife observation.
Wetmore, Dr. and Mrs. Alexander, Smithsonian Institution.	Bird observation.
Willis, Edwin L., University of California.	Ecology and behavior of birds that follow army ants.
Yerger, Dr. Ralph W., Florida State University.	Fishes and mammals.

VISITORS

Approximately 190 visitors were permitted to visit the island for a day.

RAINFALL

During the dry season (January through April) of the calendar year 1961, rains of 0.01 inch or more fell during 38 days (97 hours) and amounted to 7.63 inches, as compared to 26.64 inches during 1960. During the wet season of 1961 (May through December), rains of 0.01 inch or more fell on 192 days (752 hours) and amounted to 92.58 inches, as compared to 113.43 inches during 1960. Total rain for the year was 100.21 inches. During 37 years of record, the wettest year was 1935 with 143.42 inches, and the driest was 1930 with only 76.57 inches. February was the driest month of 1961 (0.24 inch) and August the wettest (19.73 inches). The maximum records for short period were: 5 minutes, 1.30 inches; 10 minutes, 1.65 inches; 1 hour, 4.11 inches; 2 hours, 6.33 inches; 24 hours, 10.87 inches.

TABLE 1.—Annual rainfall, Barro Colorado Island, Canal Zone

Year	Total inches	Station average	Year	Total inches	Station average
1925	104.37		1944	111.96	109.30
1926	118.22	113.56	1945	120.42	109.84
1927	116.36	114.68	1946	87.38	108.81
1928	101.52	111.35	1947	77.92	107.49
1929	87.84	106.56	1948	83.16	106.43
1930	76.57	101.51	1949	114.86	106.76
1931	123.30	104.69	1950	114.51	107.07
1932	113.52	105.76	1951	112.72	107.28
1933	101.73	105.32	1952	97.68	106.94
1934	122.42	107.04	1953	104.97	106.87
1935	143.42	110.35	1954	105.68	106.82
1936	93.88	108.98	1955	114.42	107.09
1937	124.13	110.12	1956	114.05	107.30
1938	117.09	110.62	1957	97.97	106.98
1939	115.47	110.94	1958	100.20	106.70
1940	86.51	109.43	1959	94.88	106.48
1941	91.82	108.41	1960	140.07	107.41
1942	111.10	108.55	1961	100.21	106.95
1943	120.29	109.20			

TABLE 2.—Comparison of 1960 and 1961 rainfall, Barro Colorado Island (inches)

Month	Total		Station average	Years of record	1961 excess or deficiency	Accumulated excess or deficiency
	1960	1961				
January	2.96	1.23	2.15	36	-0.92	-----
February	.95	.24	1.33	36	-1.09	-2.01
March	4.47	.71	1.24	36	-0.53	-2.54
April	18.26	5.45	3.45	37	+2.00	-0.54
May	15.55	7.86	10.90	37	-3.04	-3.58
June	11.53	10.70	10.84	37	-0.14	-3.72
July	11.46	6.94	11.23	37	-4.29	-8.01
August	7.02	19.73	12.42	37	+7.31	-0.70
September	9.49	13.33	10.26	37	+3.07	+2.37
October	19.50	17.22	14.14	37	+3.08	+5.45
November	16.53	10.84	17.96	37	-7.12	-1.67
December	22.35	5.96	11.03	37	-5.07	-6.74
Year	140.07	100.21	106.95	-----	-----	-6.74
Dry season	26.64	7.63	8.17	-----	-----	-0.54
Wet season	113.43	92.58	98.78	-----	-----	-6.20

BUILDINGS, EQUIPMENT, AND IMPROVEMENTS

The facilities on Barro Colorado Island were improved and expanded in various ways. A partition was added to the Chapman House to improve storage and floor distribution. The Zinc Meta-Arsenate House was repaired, and portions of its electrical wiring system were replaced. New cages were constructed. The old wooden water tank was repaired and provided with a new roof. Three bridges in the forest were completely rebuilt and new poacher-warning signs were placed around the perimeter of the island. A line for a "walkie-talkie" phone was installed between the dock area and the main building to provide faster communication between these two points.

Maintenance and repair activities included complete overhauls of two generators and extensive repairs to a third. The launch and the two speedboats were painted, and the hull of the former was repaired extensively. All inboard and outboard motors were given complete service checks and outworn parts were replaced. All the buildings on the island were repainted and some wire screening was replaced. Minor repairs and improvements were made to appliances and other pieces of equipment.

The 1951 sedan and the Jeep were replaced, respectively, by a 1962 station wagon and a 1962 Jeep. A 27-foot launch was transferred

to the Canal Zone Biological Area for cargo and passenger use. The Hydrographic Office of the Panama Canal Company completed the installation of new rain-recording equipment. Expansion of the library continued.

OTHER ACTIVITIES

Two scientific aides were employed to serve as temporary assistants. Edwin L. Tyson of Florida State University is analyzing the bat population of the island and Robert M. King has begun a cytotaxonomic study of Compositae in the Canal Zone and adjacent areas.

The research of the resident naturalist continued to progress with the publication of several papers which dealt with various aspects of neotropical birds.

FINANCES

Trust funds for the maintenance of the island and its living facilities are obtained by collections from visitors and scientists, table subscriptions, and donations.

The following institutions continued their support to the laboratory through the payment of table subscriptions: Eastman Kodak Co., New York Zoological Society, and Smithsonian Institution. Donations are gratefully acknowledged from C. M. Goethe and Rodrigo Marciacq.

PLANS AND REQUIREMENTS

It is hoped that funds will be made available for the installation of an electric cable from the mainland to the island in order to increase the amount of electric power available and avoid dependence on the generators.

ACKNOWLEDGMENTS

The Canal Zone Biological Area can operate only with the excellent cooperation of the Canal Zone Government and the Panama Canal Company. Thanks are due especially to the former Lt. Gov. John D. McElheny, and the Executive Secretary Paul Runnestrand and his staff, the Customs and Immigration officials, and the Police Division. Also deeply appreciated are the technical advice and assistance provided by P. Alton White, chief of the Dredging Division, and members of his staff, and C. C. Soper of the Eastman Kodak Co.

Respectfully submitted.

MARTIN H. MOYNIHAN,
Resident Naturalist.

DR. LEONARD CARMICHAEL,
Secretary, Smithsonian Institution.

Report on the International Exchange Service

SIR: I have the honor to submit the following report on the activities of the International Exchange Service for the fiscal year ended June 30, 1962:

In 1848 the Smithsonian Institution issued the first of its long series of scientific publications. In addition to the American distribution, several hundred copies were sent to scientific and other learned institutions abroad; in return, many valuable publications were received from the foreign institutions. To continue this desirable international exchange of scientific information, the Smithsonian Institution appointed agents in a number of foreign countries to facilitate exchanges. In 1851, the privilege of utilizing the Smithsonian exchange system was offered to other learned bodies, and this opportunity for wide distribution of scientific publications was so eagerly grasped that the system grew rapidly. Thus began a Smithsonian service that increased steadily in usefulness, and the quantity of material has increased from a few hundred pounds of publications transmitted in 1849, to more than 900,000 pounds in the fiscal year 1962.

From the beginning, U.S. Government departments made use of the service for the exchange of their publications for the publications of other governments. In 1886 in Brussels, a formal agreement for the exchange between countries, not only of governmental documents but also of scientific and literary publications, was ratified by eight nations. With the ratification of this Convention by the United States, the Smithsonian Institution system of exchange of publications was given official sanction and the Smithsonian Institution continued to carry on this important work and was recognized as the official agency of the United States for the international exchange of publications.

The work of the International Exchange Service serves as a means of developing and executing, in part, the broad and comprehensive objective of the Smithsonian Institution, "the diffusion of knowledge." Over the years the operations of the Service have affected most beneficially the libraries of all learned institutions in the United States and have helped to promote the rapid growth of science through facilitating the international exchange of ideas. Libraries through-

out the world have been enriched by the publications received through the Service from many institutions in the United States, and in turn the libraries of the United States have benefited from the publications received from the institutions in foreign countries.

The Service's operation works in this fashion: Libraries, scientific societies, educational institutions, and individuals in the United States who wish to distribute their publications to foreign countries on exchange or as gifts advise the International Exchange Service of the names and addresses of the foreign organizations to which they wish to send their publications, and the general character and approximate weight of the publications they wish to transmit. If the publications are accepted for transmission, packing and shipping instructions are furnished the sender. The transportation charges to the Smithsonian Institution must be prepaid, but there is no charge to the sender for the cost of transportation from the Smithsonian Institution to the intended addressees. Publications transmitted through the International Exchange Service must be packaged and addressed by the senders. The Service receives shipments of addressed packages of publications from the foreign exchange bureaus. These packages are forwarded to the addressees in the United States whose names appear on the packages.

Publications weighing 798,009 pounds were received by the International Exchange Service during the year from approximately 250 domestic sources for transmission to recipients in over 100 foreign countries. Publications weighing 114,509 pounds were received from foreign countries for distribution to addressees in the United States.

The Service transmitted by ocean freight addressed packages of publications, weighing 611,853 pounds to the foreign exchange bureaus, for distribution in their countries. The cost to the Smithsonian Institution for transmitting these publications was \$36,717.49, or approximately 6 cents per pound. Listed below are the names of the foreign exchange bureaus to whom the International Exchange Service forwards addressed packages of publications for distribution.

LIST OF EXCHANGE SERVICES

AUSTRIA: Austrian National Library, Vienna.

BELGIUM: Service des Échanges Internationaux, Bibliothèque Royale de Belgique, Bruxelles.

CHINA: National Central Library, Taipei, Taiwan.

CZECHOSLOVAKIA: Bureau of International Exchanges, University Library, Prague.

DENMARK: Institut Danois des Échanges Internationaux, Bibliothèque Royale, Copenhagen.

EGYPT: Government Press, Publications Office, Bulaq, Cairo.

FINLAND: Library of the Scientific Societies, Helsinki.

FRANCE: Service des Échanges Internationaux, Bibliothèque Nationale, Paris.

- GERMANY (Eastern) : Deutsche Staatsbibliothek, Berlin.
- GERMANY (Western) : Deutsche Forschungsgemeinschaft, Bad Godesberg.
- HUNGARY : Service Hongrois des Échanges Internationaux, Országos Széchenyi Konyvtár, Budapest.
- INDIA : Government Printing and Stationery Office, Bombay.
- INDONESIA : Minister of Education, Djakarta.
- ISRAEL : Jewish National and University Library, Jerusalem.
- ITALY : Ufficio degli Scambi Internazionali, Ministero della Pubblica Istruzione, Rome.
- JAPAN : Division for Interlibrary Services, National Diet Library, Tokyo.
- KOREA : Korean Library Association, Seoul.
- NETHERLANDS : International Exchange Bureau of the Netherlands, Royal Library, The Hague.
- NEW SOUTH WALES : Public Library of New South Wales, Sydney.
- NEW ZEALAND : General Assembly Library, Wellington.
- NORWAY : Service Norvégien des Échanges Internationaux, Bibliothèque de l'Université Royale, Oslo.
- PHILIPPINES : Bureau of Public Libraries, Department of Education, Manila.
- POLAND : Service Polonais des Échanges Internationaux, Bibliothèque Nationale, Warsaw.
- PORTUGAL : Seccão de Trocas Internacionais, Biblioteca Nacional, Lisbon.
- QUEENSLAND : Bureau of International Exchange of Publications, Chief Secretary's Office, Brisbane.
- RUMANIA : International Exchange Service, Biblioteca Centrala de Stat, Bucharest.
- SOUTH AUSTRALIA : South Australian Government Exchanges Bureau, Government Printing and Stationery Office, Adelaide.
- SPAIN : Junta de Intercambio y Adquisición de Libros y Revistas para Bibliotecas Públicas, Ministerio de Educación Nacional, Madrid.
- SWEDEN : Kungliga Biblioteket, Stockholm.
- SWITZERLAND : Service Suisse des Échanges Internationaux, Bibliothèque Centrale Fédérale, Berne.
- TASMANIA : Secretary of the Premier, Hobart.
- TURKEY : National Library, Ankara.
- UNION OF SOUTH AFRICA : Government Printing and Stationery Office, Cape Town.
- UNION OF SOVIET SOCIALIST REPUBLICS : Bureau of Book Exchange, State Lenin Library, Moscow.
- VICTORIA : Public Library of Victoria, Melbourne.
- WESTERN AUSTRALIA : State Library, Perth.
- YUGOSLAVIA : Bibliografski Institut FNRJ, Belgrade.

Many countries do not have exchange facilities for the distribution of addressed publications. During the past fiscal year the International Exchange Service mailed addressed packages of publications weighing 225,335 pounds directly to the intended recipients in such countries.

There has been a noticeable increase in requests for permission to transmit publications through the International Exchange Service to the newly created nations of the world. More dental and medical libraries in the United States are finding the Service helpful in distributing their journals and books to foreign libraries.

FOREIGN DEPOSITORIES OF GOVERNMENTAL DOCUMENTS

In accordance with treaty stipulations, conventions, and other agreements made between the United States and various foreign countries for the mutual exchange of official publications, the Smithsonian Institution transmits the official U.S. Government publications to the foreign depository libraries. The libraries that receive copies of all these official publications are the full depositories of the Government documents. The libraries that receive a selected list are the partial depositories of the Government documents. During the fiscal year 662,274 pieces weighing 227,169 pounds were received by the Smithsonian Institution for transmission to the 57 full depositories, and 101,171 pieces weighing 48,764 pounds were received for transmission to the 45 partial depositories. Listed below are the names of the full and partial depositories.

FULL DEPOSITORIES

- ARGENTINA: División Biblioteca, Ministerio de Relaciones Exteriores y Culto, Buenos Aires.
- AUSTRALIA: Commonwealth National Library, Canberra.
 NEW SOUTH WALES: Public Library of New South Wales, Sydney.
 QUEENSLAND: Parliamentary Library, Brisbane.
 SOUTH AUSTRALIA: Public Library of South Australia, Adelaide.
 TASMANIA: Parliamentary Library, Hobart.
 VICTORIA: Public Library of Victoria, Melbourne.
 WESTERN AUSTRALIA: State Library, Perth.
- AUSTRIA: Administrative Library, Federal Chancellery, Vienna.
- BRAZIL: Biblioteca Nacional, Rio de Janeiro.
- BURMA: Government Book Depot, Rangoon.
- CANADA: Library of Parliament, Ottawa.
 MANITOBA: Provincial Library, Winnipeg.
 ONTARIO: Legislative Library, Toronto.
 QUEBEC: Library of the Legislature of the Province of Quebec.
- CEYLON: Department of Information, Government of Ceylon, Colombo.
- CHILE: Biblioteca Nacional, Santiago.
- CHINA: National Central Library, Taipei, Taiwan.
 National Chengchi University, Taipei, Taiwan.
- COLOMBIA: Biblioteca Nacional, Bogotá.
- COSTA RICA: Biblioteca Nacional, San José.
- CUBA: Dirección de Organismos Internacionales, Ministerio de Relaciones Exteriores, Habana.¹
- CZECHOSLOVAKIA: University Library, Prague.
- DENMARK: Institut Danois des Échanges Internationaux, Copenhagen.
- EGYPT: Bureau des Publications, Ministère des Finances, Cairo.
- FINLAND: Parliamentary Library, Helsinki.
- FRANCE: Bibliothèque Nationale, Paris.
- GERMANY: Deutsche Staatsbibliothek, Berlin.
 Free University of Berlin, Berlin-Dahlem.
 Parliamentary Library, Bonn.

See footnotes on p. 194.

GREAT BRITAIN :

ENGLAND : British Museum, London.

LONDON : London School of Economics and Political Science. (Depository of the London County Council.)

INDIA : National Library, Calcutta.

Central Secretariat Library, New Delhi.

Parliament Library, New Delhi.

INDONESIA : Ministry for Foreign Affairs, Djakarta.

IRELAND : National Library of Ireland, Dublin.

ISRAEL : State Archives and Library, Hakiryra, Jerusalem.

ITALY : Ministero della Pubblica Istruzione, Rome.

JAPAN : National Diet Library, Tokyo.²

MEXICO : Secretaría de Relaciones Exteriores, Departamento de Información para el Extranjero, México, D.F.

NETHERLANDS : Royal Library, The Hague.

NEW ZEALAND : General Assembly Library, Wellington.

NORWAY : Utenriksdepartementets Bibliothek, Oslo.

PERU : Sección de Propaganda y Publicaciones, Ministerio de Relaciones Exteriores, Lima.

PHILIPPINES : Bureau of Public Libraries, Department of Education, Manila.

PORTUGAL : Biblioteca Nacional, Lisbon.

SPAIN : Biblioteca Nacional, Madrid.

SWEDEN : Kungliga Biblioteket, Stockholm.

SWITZERLAND : Bibliothèque Centrale Fédérale, Berne.

TURKEY : National Library, Ankara.

UNION OF SOUTH AFRICA : State Library, Pretoria, Transvaal.

UNION OF SOVIET SOCIALIST REPUBLICS : All-Union Lenin Library, Moscow.

UNITED NATIONS : Library of the United Nations, Geneva, Switzerland.

URUGUAY : Oficina de Canje Internacional de Publicaciones, Montevideo.

VENEZUELA : Biblioteca Nacional, Caracas.

YUGOSLAVIA : Bibliografski Institut FNRJ, Belgrade.²

PARTIAL DEPOSITORIES

AFGHANISTAN : Library of the Afghan Academy, Kabul.

BELGIUM : Bibliothèque Royale, Bruxelles.

BOLIVIA : Biblioteca del Ministerio de Relaciones Exteriores y Culto, La Paz.

BRAZIL : MINAS GERAIS : Departamento Estadual de Estatística, Belo Horizonte.

BRITISH GUIANA : Government Secretary's Office, Georgetown, Demerara.

CANADA :

ALBERTA : Provincial Library, Edmonton.

BRITISH COLUMBIA : Provincial Library, Victoria.

NEW BRUNSWICK : Legislative Library, Fredericton.

NEWFOUNDLAND : Department of Provincial Affairs, St. John's.

NOVA SCOTIA : Provincial Secretary of Nova Scotia, Halifax.

SASKATCHEWAN : Legislative Library, Regina.

DOMINICAN REPUBLIC : Biblioteca de la Universidad de Santo Domingo, Ciudad Trujillo.

ECUADOR : Biblioteca Nacional, Quito.

EL SALVADOR :

Biblioteca Nacional, San Salvador.

Ministerio de Relaciones Exteriores, San Salvador.

See footnotes on p. 194.

GREECE: National Library, Athens.

GUATEMALA: Biblioteca Nacional, Guatemala.

HAITI: Bibliothéque Nationale, Port-au-Prince.

HONDURAS:

Biblioteca Nacional, Tegucigalpa.

Ministerio de Relaciones Exteriores, Tegucigalpa.

ICELAND: National Library, Reykjavik.

INDIA:

BOMBAY: Secretary to the Government, Bombay.

BIHAR: Revenue Department, Patna.

KERALA: Kerala Legislature Secretariat, Trivandrum.

UTTAR PRADESH:

University of Allahabad, Allahabad.

Secretariat Library, Lucknow.

WEST BENGAL: Library, West Bengal Legislative Secretariat, Assembly House, Calcutta.

IRAN: Imperial Ministry of Education, Tehran.

IRAQ: Public Library, Baghdad.

JAMAICA:

Colonial Secretary, Kingston.

University College of the West Indies, St. Andrew.

LEBANON: American University of Beirut, Beirut.

LIBERIA: Department of State, Monrovia.

MALAYA: Federal Secretariat, Federation of Malaya, Kuala Lumpur.

MALTA: Minister for the Treasury, Valletta.

NICARAGUA: Ministerio de Relaciones Exteriores, Managua.

PAKISTAN: Central Secretariat Library, Karachi.

PANAMA: Ministerio de Relaciones Exteriores, Panamá.

PARAGUAY: Ministerio de Relaciones Exteriores, Sección Biblioteca, Asunción.

PHILIPPINES: House of Representatives, Manila.

SCOTLAND: National Library of Scotland, Edinburgh.

SIAM: National Library, Bangkok.

SINGAPORE: Chief Secretary, Government Offices, Singapore.

SUDAN: Gordon Memorial College, Khartoum.

VIETNAM: Direction des Archives et Bibliothéques Nationales, Saigon.³

INTERPARLIAMENTARY EXCHANGE OF THE OFFICIAL JOURNALS

There are now being sent abroad through the International Exchange Service 85 copies of the daily issues of the Federal Register and 100 copies of the daily issues of the Congressional Record. The names and addresses of the recipients of the official journals are listed below:

DEPOSITORIES OF CONGRESSIONAL RECORD AND FEDERAL REGISTER

ARGENTINA:

Biblioteca del Poder Judicial, Mendoza.⁵

Dirección General del Boletín Oficial e Imprentas, Buenos Aires.¹

Cámara de Diputados Oficina de Información Parlamentaria, Buenos Aires.

See footnotes on p. 104.

AUSTRALIA :

Commonwealth National Library, Canberra.

NEW SOUTH WALES : Library of Parliament of New South Wales, Sydney.

QUEENSLAND : Chief Secretary's Office, Brisbane.

VICTORIA : Public Library of Victoria, Melbourne.⁵

WESTERN AUSTRALIA : Library of Parliament of Western Australia, Perth.

BELGIUM : Bibliothèque du Parlement, Palais de la Nation, Brussels.⁴

BRAZIL :

Biblioteca da Câmara dos Deputados, Brasília, D.F.⁴

Secretaria da Presidencia, Rio de Janeiro.⁴

BRITISH HONDURAS : Colonial Secretary, Belize.

CAMBODIA : Ministry of Information, Phnom Penh.

CANADA :

Clerk of the Senate, Houses of Parliament, Ottawa.

Library of Parliament, Ottawa.

CEYLON : Ceylon Ministry of Defense and External Affairs, Colombo.⁴

CHILE : Biblioteca del Congreso Nacional, Santiago.⁴

CHINA :

Legislative Yuan, Taipei, Taiwan.⁴

Taiwan Provincial Government, Taipei, Taiwan.

CUBA :

Biblioteca del Capitolio, Habana.

Biblioteca Pública Panamericana, Habana.⁵

CZECHOSLOVAKIA : Československa Akademie Ved, Prague.⁴

EGYPT : Ministry of Foreign Affairs, Egyptian Government, Cairo.⁴

FINLAND : Library of the Parliament, Helsinki.⁴

FRANCE :

Bibliothèque Assemblée Nationale, Paris.

Bibliothèque Conseil de la République, Paris.

Library, Organization for European Economic Cooperation, Paris.⁴

Research Department, Council of Europe, Strasbourg.⁴

Service de la Documentation Étrangère Assemblée Nationale, Paris.⁴

GERMANY :

Amerika Institut der Universität München, München.⁴

Archiv, Deutscher Bundestag, Bonn.

Bibliothek des Instituts für Weltwirtschaft an der Universität Kiel,
Kiel-Wik.

Bibliothek Hessischer Landtag, Wiesbaden.⁴

Deutsches Institut für Rechtswissenschaft, Potsdam-Babelsberg II.⁵

Deutscher Bundesrat, Bonn.⁴

Deutscher Bundestag, Bonn.⁴

Hamburgisches Welt-Wirtschafts-Archiv, Hamburg.

Westdeutsche Bibliothek, Marburg, Hessen.^{4 6}

GHANA : Chief Secretary's Office, Accra.^{1 4}

GREAT BRITAIN :

Department of Printed Books, British Museum, London.

House of Commons Library, London.⁴

N.P.P. Warehouse, H.M. Stationery Office, London.^{5 7}

Printed Library of the Foreign Office, London.⁴

Royal Institute of International Affairs, London.⁴

GREECE : Bibliothèque Chambre des Députés, Hellénique, Athens.

GUATEMALA : Biblioteca de la Asamblea Legislativa, Guatemala.

HAITI : Bibliothèque Nationale, Port-au-Prince.

HONDURAS : Biblioteca del Congreso Nacional, Tegucigalpa.

HUNGARY: Országos Széchenyi Könyvtár, Budapest.

INDIA:

- Civil Secretariat Library, Lucknow, United Provinces.⁵
- Indian Council of World Affairs, New Delhi.⁴
- Jammu and Kashmir Constituent Assembly, Srinagar.⁴
- Legislative Assembly, Government of Assam, Shillong.⁴
- Legislative Assembly Library, Lucknow, United Provinces.
- Kerala Legislature Secretariat, Trivandrum.⁴
- Madras State Legislature, Madras.⁴
- Parliament Library, New Delhi.
- Gokhale Institute of Politics and Economics, Poona.⁴

IRELAND: Dail Eireann, Dublin.

ISRAEL: Library of the Knesset, Jerusalem.

ITALY:

- Biblioteca Camera dei Deputati, Rome.
- Biblioteca del Senato della Repubblica, Rome.
- International Institute for the Unification of Private Law, Rome.⁵
- Periodicals Unit, Food and Agriculture Organization of the United Nations, Rome.⁵

JAPAN:

- Library of the National Diet, Tokyo.
- Ministry of Finance, Tokyo.

JORDAN: Parliament of the Hashemite Kingdom of Jordan, Amman.⁴

KOREA: Library, National Assembly, Seoul.

LUXEMBOURG: Assemblée Commune de la C.E.C.A., Luxembourg.

MEXICO:

- Dirección, General Información, Secretaría de Gobernación, Mexico, D.F.
- Biblioteca Benjamin Franklin, México, D.F.
- AGUASCALIENTES:** Gobernador del Estado de Aguascalientes, Aguascalientes.
- BAJA CALIFORNIA:** Gobernador del Distrito Norte, Mexicali.
- CAMPECHE:** Gobernador del Estado de Campeche, Campeche.
- CHIAPAS:** Gobernador del Estado de Chiapas, Tuxtla Gutiérrez.
- CHIHUAHUA:** Gobernador del Estado de Chihuahua, Chihuahua.
- COAHUILA:** Periódico Oficial del Estado de Coahuila, Palacio de Gobierno, Saltillo.
- COLIMA:** Gobernador del Estado de Colima, Colima.
- GUANAJUATO:** Secretaría General de Gobierno del Estado, Guanajuato.⁵
- JALISCO:** Biblioteca del Estado, Guadalajara.
- MÉXICO:** Gaceta del Gobierno, Toluca.
- MICHOACÁN:** Secretaría General de Gobierno del Estado de Michoacán, Morelia.
- MORELOS:** Palacio de Gobierno, Cuernavaca.
- NAYARIT:** Gobernador de Nayarit, Tepic.
- NUEVO LEÓN:** Biblioteca del Estado, Monterrey.
- OAXACA:** Periódico Oficial, Palacio de Gobierno, Oaxaca.⁵
- PUEBLA:** Secretaría General de Gobierno, Puebla.
- QUERÉTARO:** Secretaría General de Gobierno, Sección de Archivo, Querétaro.
- SINALOA:** Gobernador del Estado de Sinaloa, Culiacán.
- SONORA:** Gobernador del Estado de Sonora, Hermosillo.
- TAMAULIPAS:** Secretaría General de Gobierno, Victoria.
- VERACRUZ:** Gobernador del Estado de Veracruz, Departamento de Gobernación y Justicia, Jalapa.
- YUCATÁN:** Gobernador del Estado de Yucatán, Mérida.

NETHERLANDS: Koninklijke Bibliotheek, The Hague.⁵

NEW ZEALAND: General Assembly Library, Wellington.

NORWAY: Library of the Norwegian Parliament, Oslo.

PANAMA: Biblioteca Nacional, Panama City.⁴

PHILIPPINES: House of Representatives, Manila.

POLAND: Kancelaria Rady Państwa, Biblioteka Sejmowa, Warsaw.

PORTUGUESE TIMOR: Repartição Central de Administração Civil, Dili.⁵

RHODESIA AND NYASALAND: Federal Assembly, Salisbury.⁵

RUMANIA: Biblioteca Centrala de Stat RPR, Bucharest.

SPAIN: Boletín Oficial del Estado, Presidencia del Gobierno, Madrid.⁵

SWEDEN: Universitetsbiblioteket, Uppsala.^{3,4}

SWITZERLAND:

International Labour Office, Geneva.^{5,7}

Library, United Nations, Geneva.

TOGO: Ministère d'État, de l'Intérieur, de l'Information et de la Presse, Lomé.

UNION OF SOUTH AFRICA:

CAPE OF GOOD HOPE: Library of Parliament, Cape Town.

TRANSVAAL: State Library, Pretoria.

UNION OF SOVIET SOCIALIST REPUBLICS: Fundamental'nii Biblioteka Obshchestvennykh Nauk, Moscow.

URUGUAY: Diario Oficial, Calle Florida 1178, Montevideo.

YUGOSLAVIA: Bibliografski Institut FNRJ, Belgrade.⁷

The International Exchange Service accepts publications for transmission to addressees in all countries except to the mainland of China, North Korea, and Communist-controlled areas of Vietnam, but will not accept packages of publications from domestic sources intended for addressees in the United States or in a territory subject to the jurisdiction of the United States.

The number and weight of the packages received from sources in the United States for transmission abroad, and the number and weight of packages received from foreign sources intended for domestic addressees, are classified in the accompanying table. The balance of exchange is not even because many countries do not have an exchange service through which they may transmit publications to the Smithsonian Institution for distribution in the United States, therefore sending their publications directly to the addressees in the United States.

¹ Change of address.

² Receives two sets.

³ Added during the year.

⁴ Congressional Record only.

⁵ Federal Register only.

⁶ Three copies.

⁷ Two copies.

Classification	Received by the Smithsonian Institution for transmission			
	For transmission abroad		For distribution in the United States	
	Number of packages	Weight in pounds	Number of packages	Weight in pounds
U.S. parliamentary documents received for transmission abroad.....	816, 044	352, 959	-----	-----
Publications received from foreign sources for U.S. parliamentary addressees.....	-----	-----	8, 410	11, 623
U.S. departmental documents received for transmission abroad.....	232, 405	225, 667	-----	-----
Publications received from foreign sources for U.S. departmental addressees.....	-----	-----	5, 539	13, 719
Miscellaneous scientific and literary publications received for transmission abroad.....	183, 915	219, 383	-----	-----
Miscellaneous scientific and literary publications received from abroad for distribution in the United States.....	-----	-----	56, 961	89, 167
Total.....	1, 232, 364	798, 009	70, 910	114, 509
Grand total.....	1, 303, 274	-----	-----	912, 518

Respectfully submitted.

J. A. COLLINS, *Chief.*

DR. LEONARD CARMICHAEL,
Secretary, Smithsonian Institution.

Report on the National Gallery of Art

SIR: I have the honor to submit, on behalf of the Board of Trustees, the 25th annual report of the National Gallery of Art, for the fiscal year ended June 30, 1962. This report is made pursuant to the provisions of section 5(d) of Public Resolution No. 14, 75th Congress, 1st session, approved March 24, 1937 (50 Stat. 51).

ORGANIZATION

The statutory members of the Board of Trustees of the National Gallery of Art are the Chief Justice of the United States, the Secretary of State, the Secretary of the Treasury, and the Secretary of the Smithsonian Institution, ex officio. The four general trustees continuing in office during the fiscal year ended June 30, 1962, were Chester Dale, Paul Mellon, Rush H. Kress, and John Hay Whitney. Ferdinand Lamnot Belin, who had been a general trustee since 1938 and vice president since 1939, died on July 6, 1961. On May 28, 1962, John N. Irwin II was elected a general trustee for the remainder of the term expiring July 1, 1971. On May 29, 1962, Chester Dale was reelected by the Board of Trustees to serve as president of the Gallery and Paul Mellon was reelected vice president.

The executive officers of the Gallery as of June 30, 1962, are as follows:

Huntington Cairns, Secretary-Treasurer.	Ernest R. Feldler, Administrator.
John Walker, Director.	Huntington Cairns, General Counsel.
	Perry B. Cott, Chief Curator

The three standing committees of the Board, as constituted at the annual meeting on May 29, 1962, were as follows:

EXECUTIVE COMMITTEE

Chief Justice of the United States, Earl Warren, Chairman.	Paul Mellon.
Chester Dale, Vice Chairman.	John Hay Whitney.
Secretary of the Smithsonian Institution, Leonard Carmichael.	

FINANCE COMMITTEE

Secretary of the Treasury, C. Douglas Dillon, Chairman.	Secretary of the Smithsonian Institution, Leonard Carmichael.
Chester Dale, Vice Chairman.	John Hay Whitney.
Paul Mellon.	

ACQUISITIONS COMMITTEE

Chester Dale, Chairman.
Paul Mellon.

John Hay Whitney.
John Walker.

PERSONNEL

At the close of the fiscal year 1962, full-time Government employees on the staff of the National Gallery of Art numbered 307. The U.S. Civil Service regulations govern the appointment of employees paid from appropriated public funds.

Continued emphasis was given to the training of employees under the Government Employees Training Act. Under the provisions of this act, 13 Gallery employees obtained additional training in their professions.

APPROPRIATIONS

For the fiscal year ended June 30, 1962, the Congress of the United States in the regular annual appropriation for the National Gallery of Art provided \$1,932,000 to be used for salaries and expenses in the operation and upkeep of the Gallery, the protection and care of works of art acquired by the Board of Trustees, and all administrative expenses incident thereto, as authorized by joint resolution of Congress approved March 24, 1937 (20 U.S.C. 71-75; 50 Stat. 51).

The following expenditures and encumbrances were incurred:

Personnel compensation and benefits-----	\$1,689,450.15
All other items-----	242,473.32
Unobligated balance-----	76.53
	<hr/>
Total-----	1,932,000.00

ATTENDANCE

There were 1,332,506 visitors to the Gallery during the fiscal year 1962, an increase of 300,166 over the previous year. The daily average number of visitors was 3,671.

ACCESSIONS

There were 1,437 accessions by the National Gallery of Art as gifts, loans, or deposits during the fiscal year.

GIFTS

During the year the following gifts or bequests were accepted by the Board of Trustees:

PAINTINGS		
<i>Donor</i>	<i>Artist</i>	<i>Title</i>
Avalon Foundation, New York, N.Y.	Sargent-----	A Street in Venice.
Mrs. Mellon Bruce, New York, N.Y.	Fragonard-----	A Young Girl Reading.

<i>Donor</i>	<i>Artist</i>	<i>Title</i>
Samuel H. Kress Foundation, New York, N. Y.	Aspertini.....	St. Sebastian.
Do.....	Daddi.....	The Crucifixion.
Do.....	Domenico di Bartolo.	Madonna and Child En- throned with St. Peter and St. Paul.
Do.....	Bartolo di Fredi....	The Presentation of the Virgin.
Do.....	Bellini.....	The Infant Bacchus.
Do.....	Creti.....	The Quarrel.
Do.....	Bronzino.....	Eleanora di Toledo.
Do.....	Carpaccio.....	Madonna and Child.
Do.....	Carracci.....	Venus Adorned by the Graces.
Do.....	Christus.....	A Donor and His Wife.
Do.....	Cima da Conegliano	St. Helena.
Do.....	Clouet.....	"Diane de Poitiers."
Do.....	David.....	Madame David.
Do.....	___do.....	Napoleon in His Study.
Do.....	Fragonard.....	Blindman's Buff.
Do.....	___do.....	The Swing.
Do.....	___do.....	Hubert Robert.
Do.....	Grünewald.....	The Small Crucifixion.
Do.....	Guercino.....	Cardinal Francesco Cennini.
Do.....	Holbein, the Younger.	Portrait of a Young Man.
Do.....	Juan de Flandes....	The Annunciation.
Do.....	___do.....	The Nativity.
Do.....	___do.....	The Adoration of the Magi.
Do.....	___do.....	The Baptism of Christ.
Do.....	Largillière.....	A Young Man with His Tutor.
Do.....	Lucas van Leyden..	The Card Players.
Do.....	Memling.....	The Presentation in the Temple.
Do.....	Master of St. Veronica	The Crucifixion.
Do.....	Nattier.....	Joseph Bonnier de la Mos- son.
Do.....	Pierino del Vaga....	The Nativity.
Do.....	Rubens.....	The Assumption of the Virgin.
Do.....	Saenredam.....	Cathedral of St. John at 's-Hertogenbosch.
Do.....	___do.....	Church of Santa Maria della Febbre, Rome.
Do.....	Savoldo.....	Elijah Fed by the Raven.
Do.....	Scorel.....	The Rest on the Flight into Egypt.
Do.....	Sebastiano del Piombo.	Cardinal Bandinello Sauli, His Secretary and Two Geographers.
Do.....	___do.....	Portrait of a Humanist.

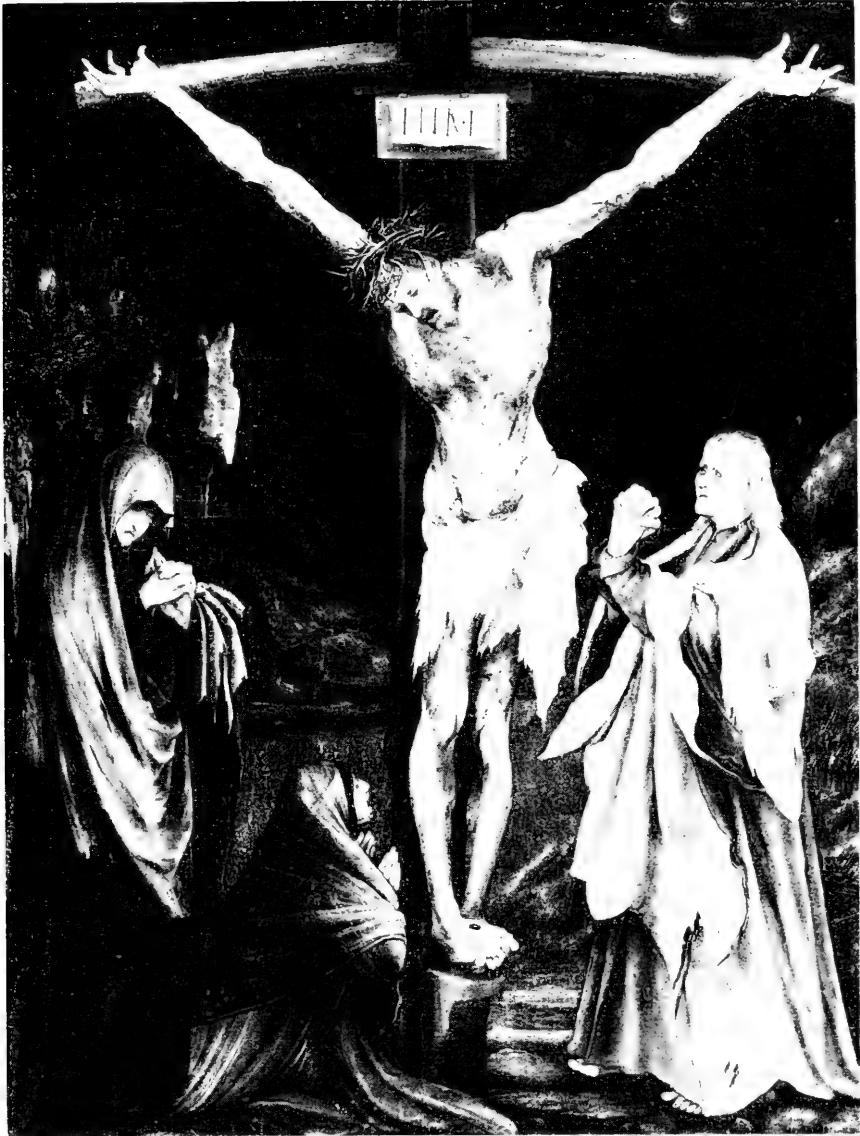

Grünewald: The Small Crucifixion. National Gallery of Art. Samuel H. Kress Collection.

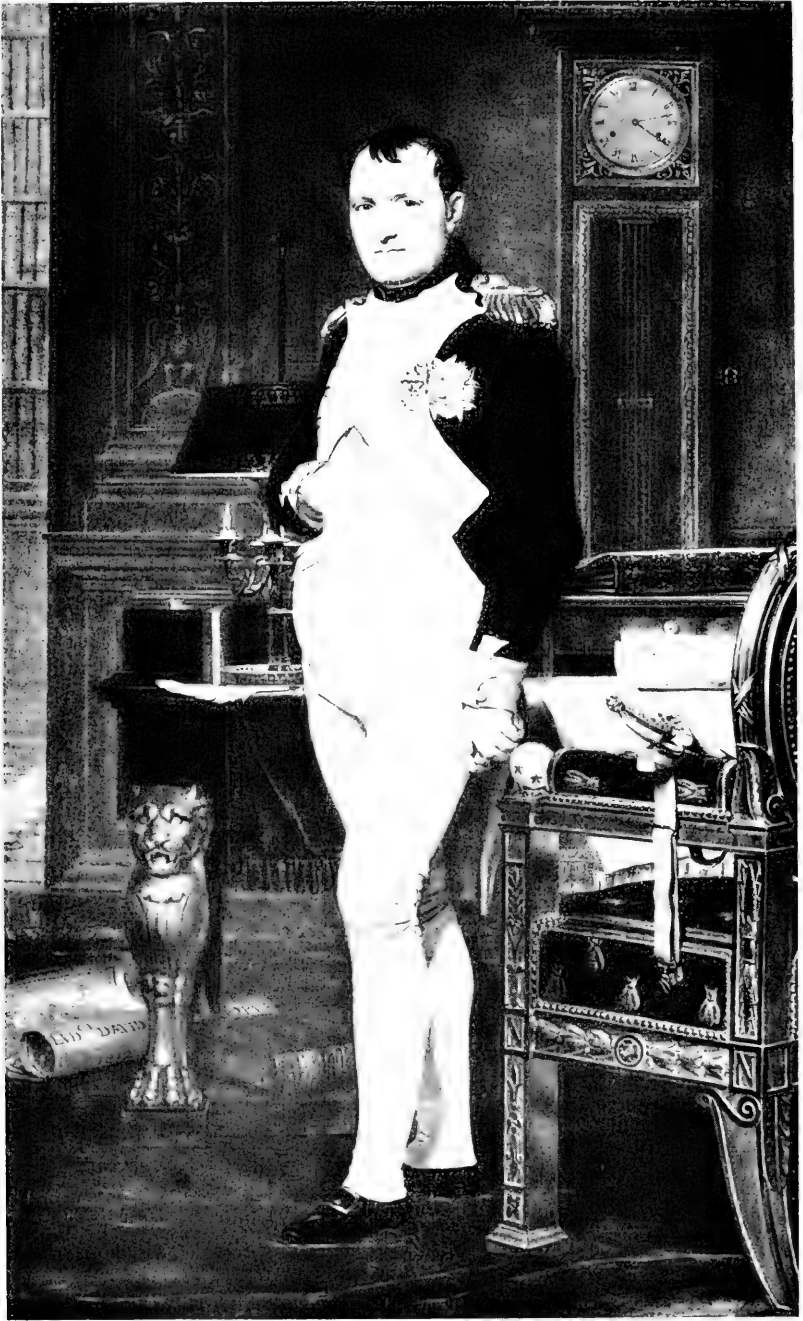

David: Napoleon in His Study. National Gallery of Art. Samuel H. Kress Collection

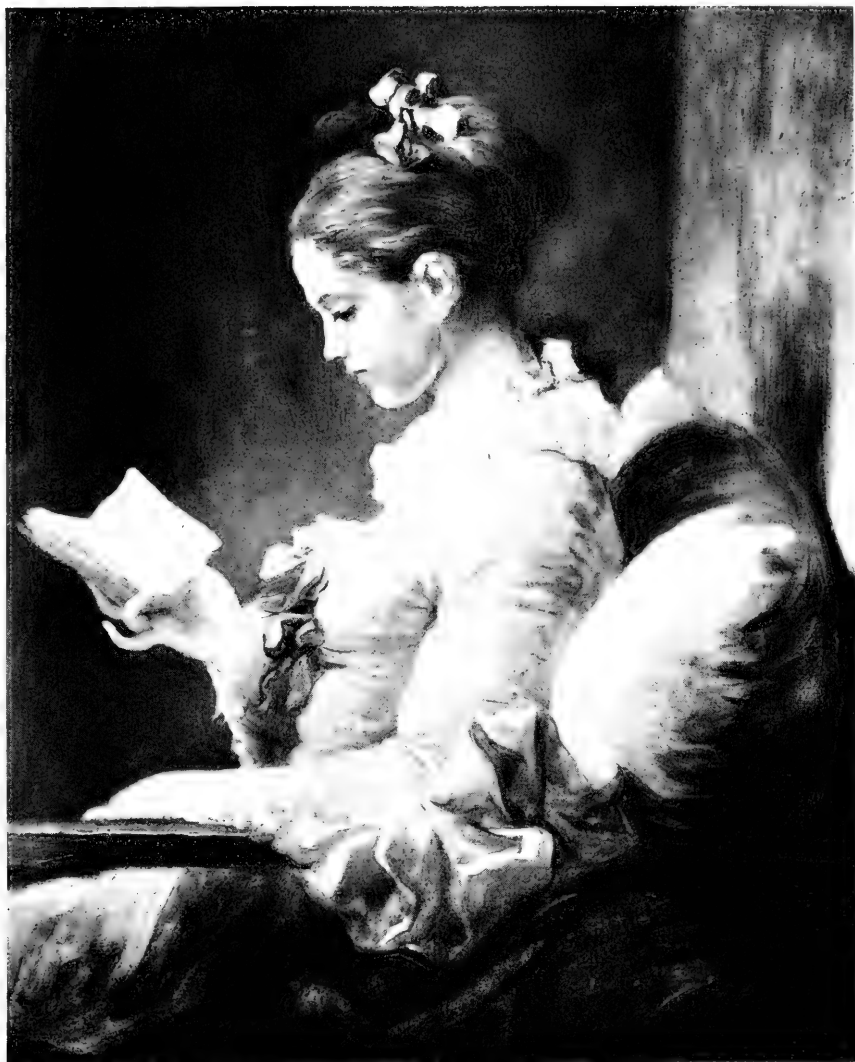

Fragonard: A Young Girl Reading. National Gallery of Art. Gift of Mrs. Mellon Bruce in memory of her father, Andrew W. Mellon.



1. Redon: Wildflowers. National Gallery of Art.
Gift of Loula D. Lasker.



2. Manet: Oysters. National Gallery of Art. Gift of the Adele R. Levy Fund, Inc.

<i>Donor</i>	<i>Artist</i>	<i>Title</i>
Samuel H. Kress Foundation, New York, N.Y.	Signorelli.....	The Marriage of the Virgin.
Do.....	Solario.....	Pietà.
Do.....	Strozzi.....	Bishop Alvise Grimani.
Do.....	Tiepolo.....	A Scene from Roman History.
Do.....	Tintoretto.....	The Conversion of St. Paul.
Do.....	----do.....	Doge Alvise Mocenigo and Family before the Madonna and Child.
Do.....	Titian.....	Doge Andrea Gritti.
Do.....	Valdés Leal.....	The Assumption of the Vir- gin.
Do.....	Veronese.....	St. Jerome in the Wilderness.
Do.....	----do.....	St. Lucy and a Donor.
Do.....	Ghirlandaio.....	Madonna and Child.
Do.....	Watteau.....	Ceres (Summer).
Do.....	Zoppo.....	Madonna and Child.
Do.....	Vouet.....	St. Jerome and the Angel.
Do.....	Canaletto.....	The Portello and the Brenta Canal at Padua.
Do.....	French Master, sec- ond half, 15th cen- tury.	Portrait of an Ecclesiastic.
Do.....	French School, 1572.	Prince Hercule-François, Duc d'Alencon.
Do.....	Luini.....	The Magdalen.
Do.....	Florentine School, 16th century.	Dante.
Do.....	Ricci, Sebastiano and Marco.	Memorial to Admiral Sir Cloudisley Shovell.
Do.....	Rosso, Il.....	Portrait of a Man.
Do.....	Rubens.....	Marchesa Brigida Spinola Doria.
Do.....	Vouet.....	The Muses Urania and Cal- liope.
Do.....	Baldung Grien.....	St. Anne with the Christ Child, the Virgin, and St. John the Baptist.
Do.....	Bellotto.....	The Castle of Nymphen- burg.
Do.....	----do.....	View of Munich.
Do.....	Bourdon.....	The Finding of Moses.
Do.....	Bouts.....	Portrait of a Donor.
Do.....	Bramantino.....	The Apparition of Christ among the Apostles.
Do.....	Correggio.....	Salvator Mundi.
Do.....	Cranach, the Elder..	The Crucifixion with Longinus.

<i>Donor</i>	<i>Artist</i>	<i>Title</i>
Samuel H. Kress Foundation, New York, N.Y.	Diana.....	The Presentation and Marriage of the Virgin, Annunciation.
Do.....	Fei.....	The Assumption of the Virgin.
Do.....	Foppa.....	St. Bernardino.
Do.....	Gentileschi.....	St. Cecilia and an Angel.
Do.....	Goya y Lucientes...	Don Antonio Noriega.
Do.....	Hamen y León.....	Still Life.
Do.....	La Tour.....	Claude Dupouch.
Do.....	Master of Badia a Isola.	Madonna Enthroned with Angels.
Do.....	Master of the St. Bartholomew Altar.	The Baptism of Christ.
Do.....	Mor.....	Portrait of a Young Man.
Do.....	Nicolò dell' Abate and Denys Calvaert.	The Judgment of Paris.
Do.....	Patinir, follower of...	The Flight into Egypt.
Do.....	Piazzetta.....	Madonna and Child Appearing to San Filippo Neri.
Do.....	Pontormo.....	Monsignor della Casa.
Do.....	Prud'hon.....	David Johnston.
Do.....	Ruisdael.....	Landscape.
Do.....	Savoldo.....	The Adoration of the Child.
Do.....	Signorelli.....	Madonna and Child with Saints.
Do.....	Strigel.....	St. Mary Cleophas and Her Family.
Do.....	----do.....	St. Mary Salome and Her Family.
Do.....	Tintoretto.....	Summer.
Do.....	Vassallo.....	The Larder.
Do.....	Venetian Master, third quarter, 18th century.	Before the Masked Ball.
Do.....	Seyffert.....	Rush H. Kress.
Miss Loula D. Lasker, New York, N.Y.	Redon.....	Wildflowers.
Adele R. Levy Fund, Inc., New York, N.Y.	Manet.....	Oysters.
Do.....	Redon.....	Pansies.
Lady Roxana Vereker, Valbonne, France.	Carpenter.....	Mrs. Henry C. Bowen.
Miss Martha E. Warner, Paoli, Pa.	Bass Otis.....	John Smith Warner.
Mrs. E. Laurence White, Prides Crossing, Mass.	Lydia Emmet.....	Mother and Children.

SCULPTURE

<i>Donor</i>	<i>Artist</i>	<i>Title</i>
Samuel H. Kress Foundation, New York, N.Y.	Solari.....	The Man of Sorrows.
Do.....	North Italian School, 1321.	Madonna and Child Enthroned with Angels.
Do.....	Michelozzi.....	Madonna with the Sleeping Child.
Do.....	Nino Pisano.....	The Archangel Gabriel.
Do.....do.....	The Virgin Annunciate.
Do.....	French School, first half, 14th century.	Madonna and Child.
Do.....	Sansovino.....	Andiron with Figure of Mars.
Do.....do.....	Andiron with Figure of Venus.
Do.....	Bernini.....	Monsignor Francesco Barberini.
Do.....	Giovanni di Turino.	Madonna and Child.
Do.....	Italian School, first half, 17th century.	Chiara da Verrazano.
Do.....do.....	Giovanni da Verrazano.
Do.....	Vittoria.....	Portrait of a Young Knight.
Do.....do.....	Portrait of a Venetian Lady.
Lessing J. Rosenwald, Jenkintown, Pa.	Daumier.....	Le Petit Propriétaire.
Do.....do.....	Le Visiteur.

DECORATIVE ARTS

Samuel H. Kress Foundation, New York, N.Y.	15 enamels.	
The Tunisian People, Tunisia.	Roman Mosaic, 3d century A.D.	Symbols of Bacchus as God of Wine and the Theater.

GRAPHIC ARTS

During the year Copley Amory gave an engraving entitled *The Copley Family* by Copley. Seventy-four objects in niello were given by the Samuel H. Kress Foundation, and Lessing J. Rosenwald increased his gift to the Gallery with 84 prints and drawings.

OTHER GIFTS

In the fiscal year 1962 gifts of money were made by the Old Dominion Foundation, Avalon Foundation, Mrs. Mellon Bruce, Calouste Gulbenkian Foundation, Miss Martha E. Warner, and Irving R. Saal. An additional cash bequest was received from the estate of William Nelson Cromwell. Gifts of securities during the year were received from the estate of Ferdinand Lamot Belin and from Mrs. Mildred G. Bryan.

EXCHANGE OF WORKS OF ART

In exchange for one-third interest in the "Geese Book," a medieval choral missal, the Samuel H. Kress Foundation gave the National Gallery of Art 200 antique frames.

WORKS OF ART ON LOAN

The following works of art were received on loan by the Gallery:

<i>From</i>	<i>Artist</i>	<i>Title</i>
Robert Woods Bliss, Washington, D.C.	-----	53 objects of Pre-Columbian art.
Chester Dale, New York, N.Y.	Bellows-----	Blue Morning.
Do-----	Monet-----	The Seine at Giverny.
Col. and Mrs. Edgar W. Garbisch, New York, N.Y.	Unknown-----	4th Pennsylvania Cavalry.
Mr. and Mrs. David Lloyd Kreeger, Washington, D.C.	Van Gogh-----	Vase of Flowers.
Do-----	Monet-----	Water Lilies.
Do-----	Renoir-----	Bather.
Mrs. Eugene Meyer, Washington, D.C.	Dufresne-----	Still Life.
Do-----	Renoir-----	Nude.

WORKS OF ART ON LOAN RETURNED

The following works of art on loan were returned during the fiscal year:

<i>To</i>	<i>Artist</i>	<i>Title</i>
Robert Woods Bliss, Washington, D.C.	-----	111 objects of Pre-Columbian art.
Chester Dale, New York, N.Y.	Bellows-----	Blue Morning.
Do-----	Monet-----	The Seine at Giverny.
Col. and Mrs. Edgar W. Garbisch, New York, N.Y.	Chambers-----	New York Harbor with Small Sailing Vessel.
Do-----	Unknown-----	4th Pennsylvania Cavalry.
Mr. and Mrs. David Lloyd Kreeger, Washington, D.C.	Van Gogh-----	Vase of Flowers.
Do-----	Monet-----	Water Lilies.
Do-----	Renoir-----	Bather.
Samuel H. Kress Foundation, New York, N.Y.	Basaiti-----	Madonna and Child.
Mrs. Eugene Meyer, Washington, D.C.	Dufresne-----	Still Life.
Do-----	Renoir-----	Nude.

WORKS OF ART LENT

During the fiscal year the Gallery lent the following works of art for exhibition purposes:

<i>To</i>	<i>Artist</i>	<i>Title</i>
American Federation of Arts, New York, N.Y.	Unknown.....	Jonathan Benham.
Do.....	Joseph Badger.....	Mrs. Isaac Foster.
Do.....	Unknown.....	Catharine Hendrickson.
Do.....	do.....	The Start of the Hunt.
Do.....	do.....	The End of the Hunt.
Do.....	do.....	The Sargent Family.
Do.....	Earl.....	Family Portrait.
Do.....	Unknown.....	Alice Slade.
Do.....	do.....	Joseph Slade.
Do.....	do.....	General Washington on White Charger.
Do.....	Bundy.....	Vermont Lawyer.
Do.....	Unknown.....	Blue Eyes.
Do.....	do.....	The Hobby Horse.
Do.....	John Bradley.....	Little Girl in Lavender.
Do.....	Susanne Walters.....	Memorial to Nicholas M. S. Catlin.
Do.....	Linton Park.....	Flax Scutching Bee.
Do.....	Unknown.....	Mahantango Valley Farm.
Do.....	do.....	Civil War Battle Scene.
Do.....	Hofmann.....	Berks County Almshouse.
Art Institute of Chicago, Chicago, Ill.	Eakins.....	Monsignor Diomedea Falconio.
Do.....	do.....	The Biglen Brothers Racing.
Department of Defense, Washington, D.C.	Murray.....	James V. Forrestal.
Philadelphia Museum of Art, Philadelphia, Pa.	Eakins.....	Monsignor Diomedea Falconio.
Do.....	do.....	The Biglen Brothers Racing.
Century 21 Exposition, Seattle, Wash.	Copley.....	Epes Sargent.
Texas Technological College, Lubbock, Tex.	Earl.....	Andrew Jackson.
The White House, Washington, D.C.	22 sketches for WPA murals.
Wilmington Society of the Fine Arts, Wilmington, Del.	Unknown.....	Village by the River.
Woodlawn Plantation, Mount Vernon, Va.	Polk.....	General Washington at Princeton.

EXHIBITIONS

The following exhibitions were held at the National Gallery of Art during the fiscal year 1962:

Chinese Art Treasures. Sponsored by the Government of the Republic of China. Continued from previous fiscal year through August 13, 1961.

- Early American Lighting Devices.* From the Index of American Design. Continued from previous fiscal year through July 12, 1961.
- Exhibitions of recent accessions.* Roman mosaic, third century A.D. "Symbols of Bacchus as God of Wine and the Theater," May 4, 1961, through August 25, 1961; "Girl with a Basket of Fish" and "Girl with a Basket of Oranges" by Renoir, August 30, 1961, through September 26, 1961; "A Young Girl Reading" by Fragonard, November 21, 1961, through March 22, 1962; "Pansies" and "Wildflowers" by Redon, January 5, 1962, through January 24, 1962; "The Copley Family" by Copley, May 11, 1962, through June 8, 1962; and "Oysters" by Manet, June 22, 1962, to continue into the next fiscal year.
- Lithographs and etchings by Goya.* From the Rosenwald Collection. July 13 through September 13, 1961.
- Etchings and drawings by Giovanni Battista Tiepolo and Giovanni Domenico Tiepolo.* From the Rosenwald and W. G. Russell Allen Collections. September 15, 1961, through November 2, 1961.
- Tiepolo Drawings.* From the Victoria and Albert Museum, London. September 17 through October 15, 1961.
- French XVIIIth century color prints.* From the Widener Collection. October 7, 1961, through November 6, 1961.
- A Retrospective Exhibition of the Work of Thomas Eakins.* From 57 collections and private lenders. October 8, 1961, through November 12, 1961.
- Tutankhamun Treasures.* From the Department of Antiquities of the United Arab Republic. November 3, 1961, through December 3, 1961.
- Art Treasures for America.* From the Samuel H. Kress Collection. December 10, 1961, through February 1, 1962.
- Christmas prints.* From the Rosenwald Collection. December 14, 1961, through January 24, 1962.
- Early American Glass.* From the Index of American Design. January 25, 1962, through May 24, 1962.
- English Drawings and Water Colors.* From British Collections, sponsored by the English-Speaking Unions of the United States and the British Commonwealth, and from the Collection of Mr. and Mrs. Paul Mellon. February 18, 1962, through April 1, 1962.
- English mezzotints.* From the Rosenwald Collection. February 17, 1962, through April 1, 1962.
- Lithographs by George Bellows.* From the Mellon, Rosenwald, and Addie Burr Clark Memorial Collections. April 21, 1962, to continue into the next fiscal year.
- Prints with color.* From the Rosenwald Collection. May 25, 1962, to continue into the next fiscal year.
- Exhibition of the Collection of Mr. and Mrs. André Meyer.* June 10, 1962, to continue into the next fiscal year.

TRAVELING EXHIBITIONS

Rosenwald Collection.—Special exhibitions of prints, drawings, and sculpture from the Rosenwald Collection were circulated during the fiscal year to 35 museums, universities, schools, and art centers in the United States and abroad.

Index of American Design.—During the fiscal year 1962, 28 traveling exhibitions (865 plates and 34 lithographs) were circulated in this country to 14 States, the District of Columbia, and in Canada and Germany.

CURATORIAL ACTIVITIES

Under the direction of Dr. Perry B. Cott, chief curator, the curatorial department accessioned 291 gifts to the Gallery during the fiscal year 1962. Advice was given with respect to 1,586 works of art brought to the Gallery for expert opinion and 24 visits to collections were made by members of the staff in connection with offers of gifts. About 4,435 inquiries, many of them requiring research, were answered verbally and by letter.

Miss Elizabeth Mongan, curator of graphic arts, lectured on graphic arts at Bryn Mawr College, Bryn Mawr, Pa., Cheltenham, England, and Beaver College, Pa. She gave a course in graphic arts to six seniors from Bryn Mawr College at Alverthorpe Gallery, Jenkintown, Pa., October through January. She was on the jury of selection for the Print Club of Philadelphia and for American Prints Today, Print Council of America.

Dr. H. Lester Cooke, curator of painting, lectured on modern art at the Corcoran Gallery of Art, Washington, D.C., and the Indiana Club of Washington, D.C. He also gave two lectures to the Italian Society of Washington. During the year Dr. Cooke assisted in judging the following art shows: Mid-States Annual, Evansville, Ind.; Miniature Society of America, Smithsonian Institution, Washington, D.C.; annual art exhibition of Charles County, Md.; and the Indian Head Art Society annual exhibition, Indian Head, Md.

The Richter Archives received and cataloged over 679 photographs on exchange from museums here and abroad, 96 purchased photographs, and about 1,000 reproductions. Five hundred photographs were added to the Iconographical Index.

RESTORATION

Francis Sullivan, resident restorer of the Gallery, made regular and systematic inspection of all works of art in the Gallery and on loan to Government buildings in Washington, and periodically removed dust and bloom as required. He relined, cleaned, and restored 12 paintings and gave special treatment to 26. Twenty paintings were X-rayed as an aid in research. Experiments were continued with synthetic materials suggested by the National Gallery of Art Fellowship at the Mellon Institute of Industrial Research, Pittsburgh, Pa. Technical advice on the conservation of paintings was furnished the public upon request, and advice on and special treatment were given to works of art belonging to other Government agencies, including the White House, U.S. Capitol, U.S. Coast Guard, and the Supreme Court.

Mr. Sullivan made trips to various cities in connection with the loan of paintings to the Gallery for special exhibitions. He also attended a conference in Rome, Italy, on "Recent Advances in Conser-

vation" sponsored by the International Institute for Conservation and, while in Europe, met with conservators in London, Paris, Amsterdam, and Brussels.

PUBLICATIONS

William P. Campbell, assistant chief curator, wrote the notes for the catalog of the exhibition *Retrospective Exhibition of the Work of Thomas Eakins*.

Miss Elizabeth Mongan, curator of graphic arts, wrote an article for the Print Council of America Year Book entitled "Battle of Fornovo."

Dr. H. Lester Cooke, curator of painting, wrote an article on the development of Winslow Homer's watercolor technique for the *Art Quarterly*, Summer 1961.

Dr. Katharine Shepard, assistant curator of graphic arts, wrote a book review for the *American Journal of Archaeology* for January 1962 on "Romische Funde" by Hans von Hülsen.

During the fiscal year 1962 the Publications Fund placed seven catalogs on sale: *Tiepolo Drawings from the Victoria and Albert Museum, London*; *Thomas Eakins, A Retrospective Exhibition*; *Tutankhamun Treasures*; *Kress Gift to the Nation*; *English Drawings and Water Colors from British Collections*; *English Drawings and Water Colors from the Collection of Mr. and Mrs. Paul Mellon*; and *Exhibition of the Collection of Mr. and Mrs. André Meyer*. Four books were placed on sale also: *Art Treasures for America*, an anthology of painting and sculpture from the Samuel H. Kress Collection; *Paintings of the World's Great Galleries*, with a section on the National Gallery of Art by Perry B. Cott; *The Collected Dialogues of Plato* edited by Edith Hamilton and Huntington Cairns; and *Of Divers Arts* by Naum Gabo, the A. W. Mellon Lecturer in the Fine Arts for 1959. Other material made available included 6 large color reproductions, a variety of jewelry pieces made from 6 small sculptures, 10 color filmstrips on the Gallery collection produced by Encyclopaedia Britannica, and 2 sets of playing cards reproducing Gallery subjects.

Sixteen color postcards and one 11" by 14" color reproduction of the new Fragonard "A Young Girl Reading" were published, together with 51 new 2" by 2" color slides. The Christmas cards included seven new color subjects and nine new graphic arts selections.

EDUCATIONAL PROGRAM

The program of the educational department was carried out under the direction of Dr. Raymond S. Stites, curator in charge of educational work, and his staff. The staff lectured and conducted tours on works of art in the Gallery's collection.

Attendance for the general tours, tours of the week, and picture of the week talks totaled 41,314. This represents an increase of 2,475 over last year's attendance. The attendance at the Sunday afternoon auditorium lectures totaled 10,668.

Special tours, lectures, and conferences were arranged and a total of 16,006 were served in this manner. This is an increase over last year of 1,918 persons. These included groups of visitors from Government agencies, club and study groups, foreign students, religious organizations, convention groups, and women's organizations. These special services were also given to school groups from all over the country.

The program of training volunteer docents continued and special instruction was given to approximately 100 volunteers from the Junior League of Washington and the American Association of University Women. By special arrangement with the public and parochial schools of the District of Columbia and surrounding counties of Maryland and Virginia, these volunteers conducted tours for 59,989 children, an increase of 8,069 children over last year's total.

Forty-one lectures were delivered in the auditorium on Sunday afternoons. Five of these were delivered by staff members, and 30 by guest lecturers. Kathleen Raine delivered the Eleventh Annual Series of the Andrew W. Mellon Lectures in the Fine Arts on six consecutive Sundays beginning on March 4 on the subject "Wisdom of the Ages: A Study of the Traditional Sources of William Blake."

The slide library of the educational department has a total of 44,274 slides in its permanent and lending collections. During the year 2,244 slides were added to the collections. In all, 250 persons borrowed a total of 11,229 slides from the collections. It is estimated these slides were seen by 20,780 viewers.

Members of the staff participated in outside activities delivering lectures, teaching courses, and attending classes in foreign universities. Also members of the staff prepared scripts for the Lectour recordings and for radio talks and wrote the material used in the school tour program and the slide lending program.

A printed calendar of events was prepared and distributed monthly to a mailing list of about 9,300 names. This is an increase over last year of 1,747 names.

EXTENSION SERVICES

The extension service continued under the direction of the curator of the Index of American Design, Dr. Grose Evans. This service circulates to the public the traveling exhibits, Gallery films, and slide lecture sets. There are 26 traveling exhibits in circulation, lent free of charge except for transportation charges. These were circulated in 156 bookings and were seen by an estimated 78,000 viewers. Three

special exhibits were prepared by special request and circulated. Preparation was begun on a program to circulate exhibits in the school systems of New York state.

Three films were circulated in 139 bookings and were seen by an estimated 41,700 viewers. A total of 930 sets of slide lectures on a variety of subjects were circulated in 2,019 bookings and seen by approximately 121,150 viewers. The extension services this year reached approximately 240,850 persons, an increase over last year of 88,870.

LIBRARY

During the year the library, under the supervision of Miss Ruth Carlson, accessioned 4,397 publications of which 3,955 were received by exchange, as gifts, or purchased from private funds. Government funds were used to purchase 13 books and 26 subscriptions to periodicals, and for the binding of 188 volumes of periodicals. In all, 1,279 photographs were added this year and were acquired by exchange or by purchase from private funds.

During the year the library classified and cataloged 1,667 publications, 6,384 cards were filed, and 2,517 periodicals were recorded. There were 8,781 periodicals circulated, and 3,622 books borrowed by members of the staff. This year the library sold 9 duplicate books and disposed of 500 periodicals to the United States Book Exchange. A total of 1,483 books and 4 microfilms were borrowed on interlibrary loan.

The exchange program became a library function during the year and 570 National Gallery of Art publications were distributed.

The library maintains a stock of black-and-white photographs of works of art in the Gallery's collections. These are maintained for the use of the staff, for exchange, for reproduction in approved publications and for sale to the public. Approximately 6,108 photographs were stocked in the library during the year and 1,243 orders for 6,014 photographs were filled. There were 366 permits for reproduction of 1,319 subjects processed.

INDEX OF AMERICAN DESIGN

The Index of American Design under the supervision of Dr. Grose Evans circulated 106 sets of color slides (5,306) throughout the country; and 230 photographs of Index material were used for exhibits, study, publicity, and reproduction in approved publications. The photographic file was increased by 69 negatives and 260 prints. Twenty-eight permits to reproduce 103 subjects from the Index were issued.

The material in the Index of American Design was studied during the year by 458 persons doing special research and for publication, exhibition, and use by designers.

The curator of the Index of American Design took part again in the orientation program of USIA personnel and delivered 8 lectures to approximately 251 people on American folk art. He also delivered five lectures to school and club groups. Dr. Evans conducted a series of 45 television lectures on the history of painting.

MAINTENANCE OF BUILDING AND GROUNDS

The Gallery building, mechanical equipment, and grounds were maintained at the established standards throughout the year.

A new security system, protecting all exterior entrances and exits, was installed jointly by the Gallery staff and the Federal Engineering Co. This system provides for the sounding of an alarm in the National Gallery of Art Guard Office simultaneously with the sounding of an alarm at the Federal Engineering Co. headquarters, should any of the exterior doors, windows, or exterior ducts be opened during specified periods.

Specially designed acoustic tile was installed in the compressor room to lower the sound level as a protection for the hearing of employees working in that area.

An additional sprinkler system, tied in with the ADT alarm system, was installed in the unfinished area, G-15, on the ground floor.

The Gallery greenhouse continued to produce flowering and foliage plants in quantities sufficient for all decorative needs of special openings and day-to-day requirements of the Garden Courts.

The planting of zoysia grasses in exposed lawns and parking strips continued. After experimentally determining that Emerald zoysia is apparently hardy under Gallery conditions, the planting of this strain is being undertaken in all areas which were not previously planted with Meyer zoysia or zoysia matrella.

LECTOUR

The Gallery's electronic guide system, Lectour, was increased by over 50 percent in September 1961, when 11 new rooms were added to the 20 already wired for broadcast. This additional equipment makes it possible for the first time for visitors to have the benefit of Lectour in the Gallery's collection of decorative art on the ground floor.

During the fiscal year 1962 Lectour was used by 87,736 visitors.

Lectour broadcasts were prepared for the special exhibitions of the Kress Gift to the Nation, Eakins Retrospective Exhibition, and English Drawings and Water Colors.

OTHER ACTIVITIES

Forty Sunday evening Calouste Gulbenkian Foundation concerts were given in the East Garden court. The National Gallery of Art

orchestra conducted by Richard Bales played 10 of these concerts. Two were made possible in part by the Music Performance Trust Fund of the American Federation of Musicians. The National Gallery Strings, conducted by Mr. Bales, furnished music during the Thomas Eakins opening on October 7, 1961, and at the opening of English Water Colors on February 17, 1962. The concert on Sunday, October 22, 1961, was dedicated to United Nations Day. Five consecutive Sunday evenings during May and June were devoted to the Gallery's 19th American Music Festival. All concerts were broadcast by Station WGMS-AM and FM in stereophonic sound. Washington music critics covered the concerts. Intermission talks during the broadcasts were delivered by members of the Educational Department staff on works of art in the Gallery, and on music by Mr. Bales. During the season Mr. Bales and the National Gallery orchestra played a number of engagements outside the Gallery's regular programs. Two hour-long television programs of the National Gallery orchestra with Mr. Bales conducting were shown on WTOP. Mr. Bales received an award for his outstanding contributions to American music from the Academy of Achievement, Monterey, Calif., and the National Gallery of Art received an Award of Merit from the National Federation of Music Clubs for its participation in the performance of American music.

In response to requests, 27,268 copies of the pamphlet "A Cordial Invitation from the Director" and 2,264 copies of the Gallery's information booklet were sent to members of Congress and to organizations holding conventions in Washington, D.C.

Henry B. Beville, the head of the Gallery's photographic laboratory, and his staff processed 26,661 items including negatives, prints, color transparencies, color separations, and slides.

A total of 232 permits to copy works of art and 124 permits to photograph works of art were issued.

AUDIT OF PRIVATE FUNDS OF THE GALLERY

An audit of the private funds of the Gallery will be made for the fiscal year ended June 30, 1962, by Price Waterhouse & Co., public accountants. A report of the audit will be forwarded to the Gallery.

Respectfully submitted.

HUNTINGTON CAIRNS, *Secretary.*

DR. LEONARD CARMICHAEL,
Secretary, Smithsonian Institution.

Report on the Library

SIR: I have the honor to submit the following report on the activities of the Smithsonian library for the fiscal year ended June 30, 1962:

The library continued to furnish pertinent literature and information in support of the various programs and activities of the Institution.

ACQUISITIONS

Publications received during the year totaled 84,061. In this number are represented 2,475 purchased books, subscriptions to 826 journals, and publications received as gifts and exchanges. In cooperation with scientific and learned organizations throughout the world, 83 new exchanges were established. In addition, approximately 1,750 volumes, which had been specially requested by staff members, were received.

Outstanding gifts from interested donors provided the library with many valuable and difficult to locate publications. Some of these include:

The Encyclopedia Americana, the 1829 and the 1962 Seattle World's Fair editions, from the Americana Corp., New York. Accepted by Dr. Leonard Carmichael in a special ceremony in the Board of Regents Room, May 1, 1962.

342 items on architecture and town planning, from Elbert Peets, Washington, D.C.

Collection of scientific publications, from W. J. Hammer (bequest).

Scottish Art Review, vols. 1-7, from J. Ramsay, Braidwood, Glasgow, Scotland.

Price lists, catalogs, books, and pamphlets on the history of dentistry, from Edward H. Angle (bequest).

The Melander collection of 262 volumes on Diptera, from Dr. J. F. Gates Clarke, U.S. National Museum.

"Fan Leaves," by Fan Guild of Boston, from Mrs. Frank C. Doble, Belmont, Mass.

41 volumes on mechanical and civil engineering, from Mrs. Carolyn H. Edwards, Glen Echo, Md.

5 books on weapons, from Mrs. John Oliver LaGorce, Washington, D.C.

"Primitive into Painter," by William B. O'Neal, from the author, Charlottesville, Va.

Relación de Michoacán, 1541 (facsimile), from His Excellency Mariano de Yturralde y Orbegoso, the Ambassador of Spain, Washington, D.C.

17 volumes on ceramics and glass, from Dr. Hans Syz, Westport, Conn.

34 volumes on physical sciences, from the U.S. Naval Observatory Library.

Collection of journals, from Mrs. DeWitt C. Ramsay, Washington, D.C.
4 trade catalogs, from C. V. S. Roosevelt, Washington, D.C.

In conjunction with the library's exchange program, a total of 32,055 pieces of duplicate and extraneous materials were sent to other libraries. This included 26,717 items forwarded to the Library of Congress and 2,481 dissertations sent to the National Library of Medicine.

In all, 116,116 pieces of material were handled by the acquisitions section during the year.

REFERENCE AND CIRCULATION

The reference librarians answered 30,498 requests for specific types of information, replied to 3,441 pieces of correspondence, circulated 33,704 books and journals, and cleared the loan records of 26,269 volumes. No circulation record is maintained of those books and journals assigned to divisional libraries. Publications borrowed from other libraries, chiefly the Library of Congress, totaled 5,386; approximately 1,503 volumes were lent. The number of persons using the reading and reference facilities of the central and branch libraries totaled 24,423, an increase of 9,903 over the previous year. Additional funds enabled the library to purchase seriously needed reference and bibliographical materials.

CATALOGING AND BINDING

The organization and control of the library's collection are necessary to provide an effective library program for the staff of the Institution.

The catalog section cataloged 6,564 volumes, recataloged 344 volumes, transferred 537 volumes, recorded 29,967 serials in the Serial Record, and filed 34,568 cards into the card catalog.

The binding unit prepared 6,400 volumes of books and journals for binding by a commercial binder. The Editorial and Publications Division designed end papers to be used for all newly bound or rebound books and journals, which attractively indicate Smithsonian ownership. The skilled hand-binding staff preserved 3,049 volumes and pamphlets which were either too fragile or valuable to be sent outside the Institution for repair. This program, to preserve our valuable research and source materials, continues on a rewarding basis.

PROGRAMS AND FACILITIES

The library staff continued to develop and put into practice new procedures, routines, and form letters which provided more efficient and expeditious operations. In the central library, for example, 45,000 volumes were rearranged and filed in one sequence on the shelves. Such improvements are important to the functioning of the library as a whole.

During the year the library staff assisted in the Smithsonian exhibition program by conducting extensive research to provide background information and appropriate illustrations for proposed exhibits.

Careful consideration was given to the efficient and economic arrangement of space and equipment in the library's allotted area in the east and west ranges in the Natural History Building. Floor plans were made for the library of the National Collection of Fine Arts and the National Portrait Gallery in the Patent Office Building.

A Xerox 914 book copier was acquired for the purpose of extending library services. This quick photocopying equipment provides the research staff with library materials that are needed for long-term use, particularly those that are out of print and/or difficult to locate.

STAFF CHANGES AND ACTIVITIES

Mrs. Etta C. Bachrach, formerly with the National Library of Medicine, joined the catalog section staff in April. Miss Janice Brown, chief of the reference and circulation section, retired on May 18.

During the year, staff members attended the International Conference on Cataloguing Principles sponsored by UNESCO in Paris, France, the American Library Association's annual conference, the American Library Association's Library Buildings and Equipment Institutes, the Special Libraries Association's conference, and U.S. Book Exchange meetings. Staff members also visited the Bibliothèque National in Paris and the Library for the National Portrait Gallery in London.

BRANCH LIBRARIES

The branch library for the Museum of History and Technology answered 13,327 reference questions, circulated 12,847 books and journals, and provided assistance to 5,591 visitors to the library. The trade catalog collection was enriched by the addition of 816 commercial catalogs, many of which are rare and out of print. A concentrated effort is being made to organize this collection prior to its move into the new Museum of History and Technology building. A twice-monthly accessions list was continued with gratifying results.

The importance of the Bureau of American Ethnology branch library's valuable collection of materials on the North American Indians was recognized by steps taken during the year toward making this better available to Smithsonian and visiting scientists. The physical appearance and lighting arrangements were improved, and Mrs. Carol F. Jopling, formerly with the U.S. Information Agency, was appointed as librarian.

Procedures were put into effect for the operation of the branch library of the Smithsonian Astrophysical Observatory in Cambridge,

Mass. The acquisition of all library materials for SAO is conducted by the central library, but the materials are delivered directly to Cambridge where the cataloging is performed. This procedure makes books and journals available more rapidly to the SAO staff than was heretofore possible. Approximately 5,625 visitors availed themselves of this library, 905 books and journals were circulated, and 275 reference questions were answered.

The division of insects branch library of approximately 18,000 volumes was moved to Lamont Street in April, along with the division itself and the U.S. Department of Agriculture Insect Identification Branch.

SUMMARIZED STATISTICS

ACCESSIONS

	Volumes	Total recorded volumes, 1962
Smithsonian Central Library including the Museum of Natural History.....	2, 623	345, 931
Museum of History and Technology.....	2, 959	
Astrophysical Observatory (SI).....	4	13, 404
Smithsonian Astrophysical Observatory, Cambridge, Mass.....	296	1, 700
Radiation and Organisms.....	170	2, 039
Bureau of American Ethnology.....	289	39, 180
National Air Museum.....	135	951
National Collection of Fine Arts.....	86	14, 391
National Zoological Park.....	1	4, 297
Science Information Exchange.....	1	1
Total.....	6, 564	421, 894

Unbound volumes of periodicals and reprints and separates from serial publications, of which there are many thousands, have not been included in the above totals.

Exchanges:

New exchanges arranged.....	83
Specially requested publications received.....	1, 750

Cataloging:

Volumes cataloged.....	7, 445
Catalog cards filed.....	34, 568

Serials: Number of serials recorded..... 29, 967

Circulation: Loans of books and periodicals..... 33, 704

Binding and Repair:

Volumes sent to the bindery.....	6, 400
Volumes repaired in the library.....	3, 049

Respectfully submitted.

RUTH E. BLANCHARD, *Librarian.*

DR. LEONARD CARMICHAEL,
Secretary, Smithsonian Institution.

Report on Publications

SIR: I have the honor to submit the following report on the publications of the Smithsonian Institution and its branches for the year ended June 30, 1961:

The publications of the Smithsonian Institution are issued partly from federally appropriated funds (Smithsonian Reports and publications of the National Museum, the Bureau of American Ethnology, and the Astrophysical Observatory) and partly from private endowment funds (Smithsonian Miscellaneous Collections, publications of the Freer Gallery of Art, and some special publications). The Institution also edits and publishes under the auspices of the Freer Gallery of Art the series *Ars Orientalis*, which appears under the joint imprint of the University of Michigan and the Smithsonian Institution. In addition, the Smithsonian publishes a guidebook, a picture pamphlet, postcards and a postcard folder, color slides, a filmstrip on Smithsonian exhibits, a coloring book for children, and popular publications on scientific and historical subjects related to its important exhibits and collections for sale to visitors. Through its publication program the Smithsonian endeavors to carry out its founder's expressed desire for the diffusion of knowledge.

During the year the Institution published 12 Smithsonian Miscellaneous Collections papers; 1 Annual Report of the Board of Regents and separates of 21 articles in the General Appendix; 1 Annual Report of the Secretary; 2 special publications; and reprints of 3 publications.

The U.S. National Museum issued 1 Annual Report, 4 bulletins, 5 papers in the series Contributions from the U.S. National Herbarium, 10 papers in the series Contributions from the Museum of History and Technology, and 12 Proceedings papers.

The Bureau of American Ethnology issued 1 Annual Report and 3 Bulletins.

The Astrophysical Observatory issued 4 papers in the series Smithsonian Contributions to Astrophysics.

The Smithsonian Traveling Exhibition Service, under the National Collection of Fine Arts, published 5 catalogs.

DISTRIBUTION

Requests for publications and information continued to show a substantial increase during the year. The publications distribution

section, under the immediate direction of Mrs. Eileen M. McCarthy, received 37,609 requests for publications from foreign and domestic libraries, universities, research institutions, educational establishments, and individuals throughout the world. Visitors to the office and replies to inquiries numbered 28,938.

A total of 817,695 copies of publications and miscellaneous items were distributed: 26 Contributions to Knowledge; 34,396 Smithsonian Miscellaneous Collections; 7,801 Annual Report volumes and 33,210 pamphlet copies of Report separates; 48,328 special publications; 244 reports of the Harriman Alaska Expedition; 60,473 publications of the National Museum; 19,326 publications of the Bureau of American Ethnology; 21,276 publications of the National Collection of Fine Arts; 526 publications of the Freer Gallery of Art¹; 21 Annals of the Astrophysical Observatory; 7,674 Smithsonian Contributions to Astrophysics publications; 789 War Background Studies; 3,349 reports of the American Historical Association; and 5,800 publications not issued by the Smithsonian Institution. Miscellaneous items: 3 sets of North American Wild Flowers and 162 North American Wild Flower prints; 23 Pitcher Plant volumes; 60,384 Guide Books; 17,919 picture pamphlets; 320,441 postcards, 122,753 postcard folders, 18,267 color slides; 122,753 information leaflets; 372 statuettes; 3,761 View-master reels.

The distribution section assisted also in the distribution to libraries of three titles published as a result of the Institution's participation in the translation program of the National Science Foundation: Studies on Crustacea of the Red Sea, part 1, by O. Paul'son; Fauna of U.S.S.R.: Birds, vol. 2, No. 3, Charadriiformes, Suborder Alcae, by E. V. Kozlova; and Ecology of Sea Colony Birds of the Barents Sea, by L. O. Belopol'skii.

SMITHSONIAN MISCELLANEOUS COLLECTIONS

In this series, under the immediate editorship of Miss Ruth B. MacManus, there were issued 12 papers as follows:

Volume 142

- No. 2. Folk religion in Southwest China, by David C. Graham. 246 pp., 28 pls., 10 figs. (Publ. 4457.) November 1, 1961. (\$4.)
 No. 4. Cenozoic and Cretaceous echinoids from Trinidad and Venezuela, by C. Wythe Cooke. 35 pp., 14 pls. (Publ. 4459.) August 18, 1961. (\$1.25.)

Volume 143

- No. 3. Supplement to the annotated, subject-heading bibliography of termites, 1955-1960, by Thomas E. Snyder. 137 pp. (Publ. 4463.) December 29, 1961. (\$1.50.)

¹ In addition to those distributed by the Gallery itself.

- No. 4. Comparison of tektite specimens from Empire, Georgia, and Martha's Vineyard, Massachusetts, by Roy S. Clarke, Jr., and Maxwell K. Carron. 18 pp., 6 pls. (Publ. 4465.) August 24, 1961. (60 cents.)
- No. 5. A long-range temperature forecast, by C. G. Abbot. 46 pp., 5 figs. (Publ. 4471.) October 27, 1961. (75 cents.)
- No. 6. The caterpillar and the butterfly, by R. E. Snodgrass. 51 pp., 17 figs. (Publ. 4472.) November 3, 1961. (75 cents.)
- No. 7. The organization and probable evolution of some mixed species flocks of Neotropical birds, by M. Moynihan. 140 pp. (Publ. 4473.) March 5, 1962. (\$1.50.)

Volume 144

- No. 1. A further study of the lower Eocene mammalian faunas of southwestern Wyoming, by C. Lewis Gazin. 98 pp., 14 pls., 2 figs. (Publ. 4474.) January 17, 1962. (\$1.50.)
- No. 2. Dimensional relationships for flying animals, by Crawford H. Greenewalt. 46 pp., 17 figs. (Publ. 4477.) April 6, 1962. (\$2.)
- No. 3. Revision of the cassiduloid echnoids, by Porter M. Kier. 262 pp., 44 pls., 184 figs. (Publ. 4500.) June 26, 1962. (\$5.)

Volume 145

- No. 1. Systematic notes concerned with the avifauna of Panama, by Alexander Wetmore. 14 pp. (Publ. 4501.) June 26, 1962. (30 cents.)
- No. 2. Notes on fossil and subfossil birds, by Alexander Wetmore. 17 pp., 2 figs. (Publ. 4502.) June 26, 1962. (30 cents.)

SMITHSONIAN ANNUAL REPORTS

REPORT FOR 1960

The complete volume of the Annual Report of the Board of Regents for 1960 was received from the printer on October 4, 1961:

Annual Report of the Board of Regents of the Smithsonian Institution showing the operations, expenditures, and condition of the Institution for the year ended June 30, 1960. x+605 pp., illus. (Publ. 4435.)

The general appendix contained the following papers (Publ. 4436-4456):

The science of yesterday, today, and tomorrow, by W. F. G. Swann.

The origin and nature of the moon, by Harold C. Urey.

Exploring the solar system by radar, by Paul E. Green, Jr., and Gordon H. Pettengill.

Digital computers: Their history, operation, and use, by E. M. McCormick.

Navigation—from canoes to spaceships, by Charles S. Draper.

Photography of the ocean floor, by A. S. Laughton.

History of a tsunami, by Elliott B. Roberts.

Hailstorms and hailstones of the western Great Plains, by Vincent J. Schaefer.

The 1959-60 eruption of Kilauea Volcano, by Donald H. Richter and Jerry P. Eaton.

Diamonds, by H. J. Logie.

Seeing the magnetization in transparent magnetic crystals, by J. F. Dillon, Jr.

Biophysics of bird flight, by August Raspet.

- Animal societies, from slime molds to man, by R. E. Snodgrass.
 Luminescence in marine organisms, by J. A. C. Nicol.
 Trumpets in the West, by William B. Morse.
 Problems involved in the development of clam farms, by Harry J. Turner, Jr.
 The growth of cotton fiber science in the United States, by Arthur W. Palmer.
 Rice—Basic food for one-third of the earth's people, by Raymond E. Crist.
 The River Basin salvage program: After 15 years, by Frank H. H. Roberts, Jr.
 New World prehistory, by Gordon R. Willey.
 The art of Seth Eastman, by John Francis McDermott.

REPORT FOR 1961

The report of the Secretary, which will form part of the 1961 Annual Report of the Board of Regents, was issued January 25, 1962.

Report of the Secretary and financial report of the Executive Committee of the Board of Regents for the year ended June 30, 1961. x+236 pp., 14 pls. (Publ. 4475.)

SPECIAL PUBLICATIONS

- European military museums, by J. Lee Westrate. 206 pp., 13 pls. (Publ. 4432.) [July 17] 1961. (\$4.)
 Smithsonian publications available for distribution December 31, 1960. 46 pp. (Publ. 4464.) [July 12] 1961.

REPRINTS

The First Ladies Hall, by Margaret W. Brown [Klaphor]. (Revised.) 12 pp., illus. (Publ. 4212.) [Oct. 15] 1961. (25 cents.)

Solar variations and weather, by Charles Greeley Abbot. 48 pp., illus. (Publ. 4505.) [May 4, 1962.] (50 cents.) Reprinted from "The Sun and the Welfare of Man," volume 2 of the Smithsonian Scientific Series, pp. 138-182, 1943.

Smithsonian Mathematical Tables: Hyperbolic functions, prepared by George F. Becker and C. E. Van Orstrand. (7th reprint.) iii+321 pp. (Publ. 1871.) August 25, 1961. (\$5.)

PUBLICATIONS OF THE UNITED STATES NATIONAL MUSEUM

The editorial work of the National Museum continued during the year under the immediate direction of John S. Lea, assistant chief of the division. The following publications were issued:

REPORT

The United States National Museum annual report for the year ended June 30, 1961. Pp. viii+188, illus. January 25, 1962.

BULLETINS

- 216, part 3. Ichneumon-flies of America north of Mexico: 3. Subfamily Gelinae, Tribe Mesostenini, by Henry and Marjorie Townes. Pp. viii+602, 400 figs. Mar. 13, 1962.
 222. John Baptist Jackson: 18th-century master of the color woodcut, by Jacob Kainen. Pp. xii+183, illus. 101 (12 in color). June 1, 1962.
 224. Robber flies of the world: The genera of the family Asilidae, by Frank M. Hull. Pp., pt. 1, x+430, pt. 2, v+431-907. June 25, 1962.

225. Contributions from the Museum of History and Technology, papers 12-18, by members of the staff and others:
- Paper 17. The effect of Bacon's Rebellion on government in England and Virginia, by Wilcomb E. Washburn. Pp. 135-152, 8 figs. February 16, 1962.
- Paper 18. Excavations at Rosewell in Gloucester County, Virginia, 1957-1959, by Ivor Noël Hume. Pp. 153-229, 38 figs. May 24, 1962.
228. Contributions from the Museum of History and Technology, papers 19-30, by members of the staff and others:
- Paper 21. The pioneer steamship *Savannah*: A study for a scale model, by Howard I. Chapelle. Pp. 61-80, 9 figs. Sept. 15, 1961.
- Paper 22. Drawings and pharmacy in al-Zahrāwī's 10th-century surgical treatise, by Sami Hamarneh. Pp. 81-94, 21 figs. Oct. 10, 1961.
- Paper 23. The introduction of self-registering meteorological instruments, by Robert P. Multhauf. Pp. 95-116, 16 figs. Sept. 6, 1961.
- Paper 24. Introduction of the locomotive safety truck, by John H. White. Pp. 117-131, 12 figs. Sept. 5, 1961.
- Paper 25. The migrations of an American boat type, by Howard I. Chapelle. Pp. 133-154, 20 figs. Nov. 6, 1961.
- Paper 26. Holcomb, Fitz, and Peate: Three 19th-century American telescope makers, with introduction by Robert P. Multhauf. Pp. 155-184, 15 figs. Jan. 15, 1962.
- Paper 27. Kinematics of mechanisms from the time of Watt, by Eugene S. Ferguson. Pp. 185-230, 46 figs. Feb. 14, 1962.
- Paper 28. The development of electrical technology in the 19th century: 1. The electrochemical cell and the electromagnet, by W. James King. Pp. 231-271, 71 figs. Jan. 15, 1962.
232. The lithographs of Childe Hassam, a catalog, by Fuller Griffith. Pp. vii+66, 45 figs. June 29, 1962.

CONTRIBUTIONS FROM THE NATIONAL HERBARIUM

Volume 35

- Part 3. Origins of the flora of southern Brazil, by Lyman B. Smith. Pp. viii+215-249, 42 figs., 4 pls. Mar. 19, 1962.
- Part 4. A synopsis of the American Velloziaceae, by Lyman B. Smith. Pp. 251-292, 12 pls. Mar. 19, 1962.
- Part 5. Synopsis of the South American species of *Vismia* (Guttiferae), by Joseph Ewan. Pp. 293-377, 7 pls. June 5, 1962.

Volume 36

- Part 2. Marine algae from the tropical Atlantic Ocean: V. Algae from the Lesser Antilles, by William Randolph Taylor. Pp. 43-62, 4 pls. Jan. 31, 1962.

Volume 37

- Part 1. Studies of Pacific island plants, XVII: The genus *Geniostoma* (Loganiaceae) in the New Hebrides, Fiji, Samoa, and Tonga, by Albert C. Smith and Benjamin C. Stone. Pp. 1-41, 8 pls. Jan. 5, 1962.

PROCEEDINGS

Volume 112

- No. 3449. Revision of the marine silver hatchetfishes (family Sternoptychidae), by Leonard P. Schultz. Pp. 587-649, 26 figs. Sept. 7, 1961.
- Title page, table of contents, and index. Pp. 1-vii, 651-677. Feb. 14, 1962.

Volume 113

- No. 3453. Notes on Australian flies of the family Conopidae, by Sidney Camras. Pp. 61-76. Aug. 1, 1961.
- No. 3454. New and previously known millipeds of Panama, by H. F. Loomis. Pp. 77-123, 8 figs. Aug. 16, 1961.
- No. 3455. New genera and new species of lacebugs from the Eastern Hemisphere (Hemiptera: Tingidae), by Carl J. Drake and Florence A. Ruhoff. Pp. 125-183, 24 figs. Aug. 1, 1961.
- No. 3456. The weevil genus *Smicronyx* in America north of Mexico (Coleoptera: Curculionidae), by Donald M. Anderson. Pp. 185-372, 157 figs., 1 pl. May 31, 1962.
- No. 3457. Neotropical Microlepidoptera, I and II, by J. F. Gates Clarke. Pp. 373-388, 9 figs. Apr. 30, 1962.
- No. 3458. Two new species of *Parastenocaris* (Copepoda: Harpacticoida) from Santa Catarina, Brazil, by Hans Jakobi and Jayme de Loyola e Silva. Pp. 389-397, 2 figs. June 5, 1962.
- No. 3460. Water-striders of the subgenus *Stridulivella* from Mexico, Central America, and the West Indies (Hemiptera: Veliidae), by Carl J. Drake and Arnold S. Menke. Pp. 413-419, 3 pls. June 19, 1962.
- No. 3462. New and little-known species of South and Central American land snails (Bulimulidae), by Juan José Parodiz. Pp. 429-456, 2 pls. June 4, 1962.
- No. 3463. *Gorgonolaureus*, a new genus of ascothoracid barnacle endoparasitic in Octocorallia, by Huzio Utinomi. Pp. 457-464, 9 figs. June 19, 1962.
- No. 3464. Larvae of the caddis-fly genus *Rhyacophila* in eastern North America (Trichoptera: Rhyacophilidae), by Oliver S. Flint, Jr. Pp. 465-493, 11 figs. May 31, 1962.

PUBLICATIONS OF THE BUREAU OF AMERICAN ETHNOLOGY

The editorial work of the Bureau continued during the year under the immediate direction of Mrs. Eloise B. Edelen. The following publications were issued:

- Seventy-eighth Annual Report of the Bureau of American Ethnology, 1960-61. ii+33 pp., 2 pls. 1962.
- Bulletin 175. Mohave ethnopsychiatry and suicide: The psychiatric knowledge and the psychic disturbances of an Indian tribe, by George Devereux. vi+586 pp., 10 pls. 1961.
- Bulletin 179. River Basin Surveys Papers, Nos. 21-24, Frank H. H. Roberts, Jr., editor. xviii+337 pp., 56 pls., 43 figs. 1961.
- No. 21. Excavations at Texarkana Reservoir, Sulphur River, Texas, by Edward B. Jelks.
- No. 22. Archeological investigations at the Coralville Reservoir, Iowa, by Warren W. Caldwell.
- No. 23. The McNary Reservoir: A study in Plateau archeology, by Joel L. Shiner.
- No. 24. The Sheep Island site and the Mid-Columbia Valley, by Douglas Osborne, Alan Bryan, and Robert H. Crabtree.
- Bulletin 183. Seneca Thanksgiving rituals, by Wallace L. Chafe. iii+302 pp. 1961.

PUBLICATIONS OF THE ASTROPHYSICAL OBSERVATORY

The editorial work of the Smithsonian Astrophysical Observatory continued under the immediate direction of Ernest E. Biebighauser. The year's publications in the series Smithsonian Contributions to Astrophysics are as follows:

Volume 4

No. 4. Precision orbits of 413 photographic meteors, by Luigi G. Jacchia and Fred L. Whipple. Pp. 97-129, 6 figs. 1961. (Corrected edition.)

Volume 5

No. 9. Rotation of an earth satellite in flight along its orbit, by Yusuke Hagihara. Pp. 113-143, 5 figs. 1961.

No. 10. Sampling dust from the stratosphere, by Paul W. Hodge. Pp. 145-152, 2 figs., 2 pls. 1961.

No. 11. On the Λ and Φ operators of radiative transfer theory, by S. S. Kumar. Pp. 153-185, 8 figs. 1962.

PUBLICATIONS OF THE NATIONAL COLLECTION OF FINE ARTS

The following catalogs were issued by the Smithsonian Traveling Exhibition Service during the year:

Drawings by sculptors. 16 pp., illus. 1961.

Belgian drawings from Ensor to Delvaux. 32 pp., illus. 1961.

Tutankhamun treasures. 46 pp., illus. 1961.

Tiepolo drawings from the Victoria and Albert Museum, London. 32 pp., illus. 1961.

Smithsonian Institution traveling exhibitions. 1962-63 catalog. 70 pp.

REPORTS OF THE AMERICAN HISTORICAL ASSOCIATION

The annual reports of the American Historical Association are transmitted by the Association to the Secretary of the Smithsonian Institution and are by him communicated to Congress, as provided in the act of incorporation of the Association. The following report was issued during the year:

Annual Report of the American Historical Association for 1960. Vol. 1. Proceedings. 1961.

REPORT OF THE NATIONAL SOCIETY, DAUGHTERS OF THE AMERICAN REVOLUTION

In accordance with law, the manuscript of the sixty-fourth annual report of the National Society, Daughters of the American Revolution, was transmitted to Congress on March 6, 1962.¹

¹ D.A.R. reports are published as Senate documents and are not available from the Smithsonian Institution.

OTHER ACTIVITIES

The chief of the division continued to represent the Smithsonian Institution on the board of trustees of the Greater Washington Educational Television Association, Inc., of which the Institution is a member, and served on its executive committee. He also represented the Institution at the annual meeting of the Association of American University Presses held in June at Palo Alto, Calif.

A noteworthy item in press at the close of the year was an "Author-Subject Index to Articles in Smithsonian Annual Reports, 1849-1961," compiled and edited under the direction of the editorial and publications division.

The division, as well as other branches of the Institution, cooperated with the National Science Foundation during the year in the preparation of No. 13 of the Foundation's series of bulletins describing the policies and practices of Federal agencies relative to their scientific and technical information activities. This bulletin, on the scientific information activities of the Smithsonian Institution, was published by the Foundation in June.

Respectfully submitted.

PAUL H. OEHSER,

Chief, Editorial and Publications Division.

Dr. LEONARD CARMICHAEL,

Secretary, Smithsonian Institution.

Other Activities

LECTURES

In 1931 the Smithsonian Institution received a bequest from James Arthur, of New York City, a part of the income from which was to be used to endow an annual lecture on some aspect of the sun. The 28th Arthur lecture was delivered in the auditorium of the Natural History Building on the evening of May 8, 1962, by Dr. Martin Schwarzschild, Eugene Higgins professor of astronomy, Princeton University. His subject was "Astronomical Photography from the Stratosphere."

Lt. Gen. James H. Doolittle, USAF (Ret.), delivered the third Lester D. Gardner lecture, on "Early Blind Flying," in the auditorium of the Natural History Building on the evening of September 28, 1961. This lecture was published in full in the general appendix of the Annual Report of the Board of Regents of the Smithsonian Institution for 1961 (pp. 337-355).

Dr. Rodney Young, professor of classical archaeology, University of Pennsylvania, lectured on "Gordion on the Royal Road" in the auditorium of the Natural History Building on the evening of February 8, 1962. This was sponsored jointly by the Smithsonian Institution and the Archaeological Institute of America.

Several lectures were sponsored by the Freer Gallery of Art and the National Gallery of Art. These are listed in the reports of these bureaus.

SCIENCE INFORMATION EXCHANGE

The Science Information Exchange receives, organizes, and disseminates information on scientific research in progress. Its mission is to facilitate planning and management of scientific research activities supported by Government and non-Government agencies and institutions by promoting the exchange of information that concerns subject matter, distribution, level of effort, and other data pertaining to current research in the prepublication stage. It helps program directors and administrators to avoid unwanted duplication and to determine the most advantageous distribution of research funds. It serves the entire scientific community by informing individual in-

investigators about who is currently working on problems in their special fields. Funds for the operation of the Science Information Exchange were provided by the principal Federal agencies served.

This year the Exchange was reorganized and expanded to undertake the registration of research in the physical sciences in addition to the established program in the biological, medical, and social sciences. This expansion, projected over 18 months, involves the reorganization of the Exchange, the acquisition of enlarged computer facilities, a professional staff for the new physical sciences division, and a program for a systems analysis and control intended to coordinate efficiently the complex operational procedures.

The new physical sciences division is being organized around an initial collection of basic and applied research records in the fields of chemistry, physics, mathematics, earth sciences, materials, and electronics. Five specialists now form the nucleus of this staff. About 4,000 projects have been registered. The acquisition of another 3,000 to 4,000 records over the next few months will afford a fairly representative sample of Government research in these research specialties.

The life sciences division has had 12 years of successful operation in biology, medicine, psychology, and social sciences and continues to expand the scope and volume of its collection and services at a healthy rate. About 56,000 records of research proposals, awards, and contracts were received this year. About half a million copies of research records were selected and sent out in response to requests for information. Five new staff members were added to this division during the year.

Dr. Stella Leche Deignan resigned as director of the Exchange in September to take a position with the National Institutes of Health. Dr. Monroe E. Freeman was appointed director to succeed her. Dr. David Hersey became associate director for the life sciences division. Harvey Marron was appointed assistant director for operations.

SMITHSONIAN MUSEUM SERVICE

The Smithsonian Museum Service, through appropriate educational media, interprets to museum visitors and to the general public the objects, specimens, and exhibits in the several Smithsonian museums and develops interpretative and educational material relating to the work of the Institution in the fields of science, natural history, art, and history. The Museum Service also cooperates with the volunteer docents of the Junior League of Washington, D.C. A more complete report of this activity, directed by G. Carroll Lindsay, curator, is carried in the Report on the U.S. National Museum (pp. 38-40).

The Museum Service provided assistance to professional groups and individuals visiting the museums of the Institution or planning to

do so. Assistance in the form of lectures, answers to inquiries, and special tours of certain museum areas was rendered to college and university groups visiting the Institution and to other groups and individuals from the United States and abroad, visiting or planning to visit the Smithsonian in a professional capacity. Mr. Lindsay served as consultant on museum organization and practices to representatives from other museums on several occasions.

Arrangements were made through the Museum Service for Smithsonian participation in the workshop on community resources sponsored by the University of Maryland. Through the facilities of this workshop, a 5-day program outlining the history of the Institution and the work of the various Smithsonian museum and research bureaus was presented to 42 graduate students from the University of Maryland. This workshop has, since its inception in 1958, provided an opportunity for more than 200 local school teachers and university faculty members to become acquainted with cultural resources of the Institution of value in school curricula.

A radio lecture system has been installed in nine halls and in the rotunda of the Museum of Natural History, under the direction of the Museum Service. These lectures, written by the assistant curator, Mrs. Sophy D. Burnham, in cooperation with the various subject specialists involved, provide background information about the 34 major areas of the halls included in the system.

The Museum Service cooperated with WTOP-TV to produce the television program "The World of Mammals" and with WMAL-TV to produce the television film "The History of the Smithsonian Institution." It also arranged for loans of objects to the Greater Washington Educational Television Association for several of their educational television programs and for spot announcements of the Junior League guided tours of the Smithsonian.

Through the Museum Service, distribution of certain duplicate specimens and objects from the United States National Museum was made to the Overbrook School for the Blind for use in that school's training of blind children. Special "touch" exhibits and demonstrations were arranged for a visiting group from the Perkins Institute for the Blind, Watertown, Mass.

Mrs. Janet Stratton of the Museum Service staff directed the installation of the exhibit "Jazz Memorabilia," shown in the rotunda of the Arts and Industries Building in connection with the Jazz Festival sponsored by the President's Music Committee of the People-to-People program.

The program for visitor orientation to Smithsonian Museums was continued through the installation of two floor plans and directories

placed in the original Smithsonian building, one at the north door and the other at the east door. In addition, signs were placed in the Natural History Building announcing special exhibits.

A 6-week summer training program for high school students, organized by Mrs. Arthur Goldberg and the Urban Service Corps, has been established. Its purpose is to acquaint the students with the location and content of the Smithsonian exhibits and the work of the Institution so that they may acquaint small groups of their contemporaries with the exhibits of the Institution.

A great many slides were added to the slide lending library, and two slide lectures were prepared, one on "The Smithsonian Institution" and the other on "Some Possessions of George Washington in the Smithsonian Institution."

Arrangements for various Smithsonian public functions and events including lectures, films, and the opening of new halls and exhibits were made by the Museum Service. More complete information about these activities will be found under appropriate headings elsewhere in this Report. Mailing lists for announcements of these events were maintained and kept current.

The Smithsonian Calendar of Events, a listing of special events of the Institution, was prepared and distributed monthly.

The curator attended the Annual Winterthur Seminars in Museum Operation and Connoisseurship held at Winterthur, Del., in May 1962; the annual meeting of the Museum Stores Association held at the Munson-Williams-Proctor Institute in Utica, N.Y., and the Corning Museum of Glass, Corning, N.Y., in May 1962; and the annual meeting of the American Association of Museums held in Williamsburg, Va., in June 1962. Mrs. Burnham, the assistant curator, when in Europe in March 1962 visited the British Museum; British Museum of Natural History; Science Museum, South Kensington; Victoria and Albert Museum; Rijksmuseum, Amsterdam; Palais de la Decouverte; Musée de l'Homme; Unesco Museum Documentation Center; Jeu de Paume, Louvre, Paris. She also attended the annual meeting of the American Association of Museums held in June in Williamsburg.

Mr. Lindsay traveled to Providence, R.I., to consult with the director and trustees of the Old Slater Mill and to the Youth Museum at Savannah, Ga., regarding various administrative problems of these museums.

Report of the Executive Committee of the Board of Regents of the Smithsonian Institution

For the Year Ended June 30, 1962

To the Board of Regents of the Smithsonian Institution:

Your executive committee respectfully submits the following report in relation to the funds of the Smithsonian Institution, together with a statement of the appropriations by Congress for the Government bureaus in the administrative charge of the Institution.

SMITHSONIAN INSTITUTION

PARENT FUND

The original bequest of James Smithson was £104,960 8s 6d—\$508,318.46. Refunds of money expended in prosecution of the claim, freight, insurance, and other incidental expenses, together with payment into the fund of the sum of £5,015, which had been withheld during the lifetime of Madame de la Batut, brought the fund to the amount of \$550,000.

The gift of James Smithson was “lent to the United States Treasury, at 6 per centum per annum interest” (20 USC. 54) and by the Act of March 12, 1894 (20 USC. 55) the Secretary of the Treasury was “authorized to receive into the Treasury, on the same terms as the original bequest of James Smithson, such sums as the Regents may, from time to time see fit to deposit, not exceeding, with the original bequest the sum of \$1,000,000.”

The maximum of \$1,000,000 which the Smithsonian Institution was authorized to deposit in the Treasury of the United States was reached on January 11, 1917, by the deposit of \$2,000.

Under the above authority the amounts shown below are deposited in the United States Treasury and draw 6 percent interest:

	<i>Unrestricted funds</i>	<i>Income 1962</i>
James Smithson.....	\$727, 640	\$43, 658. 40
Avery	14, 000	840. 00
Habel	500	30. 00
Hamilton	2, 500	150. 00
Hodgkins (General).....	116, 000	6, 960. 00
Poore	26, 670	1, 600. 20
Rhees	590	35. 40
Sanford	1, 100	66. 00
Total	889, 000	53, 340. 00

	<i>Restricted funds</i>	
Hodgkins (Specific)-----	\$100,000	\$6,000.00
Reid-----	11,000	660.00
	<hr/>	<hr/>
Total-----	111,000	6,660.00
	<hr/>	<hr/>
Grand Total-----	1,000,000	60,000.00

In addition to the \$1,000,000 deposited in the Treasury of the United States there has been accumulated from income and bequests the sum of \$4,147,562.65 which has been invested. Of this sum, \$3,969,482.90 is carried on the books of the Institution as the Consolidated Fund, a policy approved by the Regents at their meeting on December 14, 1916. The balance is made up of several small funds.

CONSOLIDATED FUND

(Income for the unrestricted use of the Institution)

Fund	Investment 1962	Income 1962
Abbott, W. L., Special-----	\$22,522.34	\$1,174.27
*Avery, Robert S., and Lydia-----	59,712.30	3,113.28
Gifts, royalties, gain on sale of securities-----	417,403.46	21,762.48
Hachenberg, George P., and Caroline-----	6,079.80	316.99
*Hamilton, James-----	610.23	31.80
Hart, Gustavus E.-----	736.34	38.40
Henry, Caroline-----	1,828.34	95.34
Henry, Joseph and Harriet A.-----	74,105.83	3,863.72
*Hodgkins, Thomas G. (General)-----	45,793.92	2,387.59
Morrow, Dwight W.-----	116,900.22	6,094.91
Olmsted, Helen A.-----	1,211.99	63.21
*Poore, Lucy T. and George W.-----	246,039.46	12,827.93
Porter, Henry Kirke-----	432,950.15	22,573.05
*Rhees, William Jones-----	715.22	37.30
*Sanford, George H.-----	1,345.68	70.14
*Smithson, James-----	1,845.53	96.44
Taggart, Gansen-----	540.68	28.17
Witherspoon, Thomas A.-----	195,089.23	10,171.54
	<hr/>	<hr/>
Total-----	1,625,430.72	84,746.56

*In addition to funds deposited in the United States Treasury.

CONSOLIDATED FUND
(Income restricted to specific use)

Fund	Investment 1962	Income 1962
Abbott, William L., for investigations in biology-----	\$157, 601. 60	\$8, 217. 01
Armstrong, Edwin James, for use of Department of Invertebrate Paleontology when principal amounts to \$5,000-----	1, 898. 60	94. 07
Arthur, James, for investigations and study of the sun and annual lecture on same-----	60, 459. 26	3, 152. 23
Bacon, Virginia Purdy, for traveling scholarship to investigate fauna of countries other than the United States-----	75, 738. 96	3, 948. 88
Baird, Lucy H., for creating a memorial to Secretary Baird-----	54, 057. 76	1, 897. 70
Barney, Alice Pike, for collection of paintings and pastels and for encouragement of American artistic endeavor-----	43, 358. 91	2, 260. 62
Barstow, Frederick D., for purchase of animals for Zoological Park-----	1, 511. 33	78. 77
Canfield collection, for increase and care of the Canfield collection of minerals-----	57, 819. 33	3, 014. 59
Casey, Thomas L., for maintenance of the Casey collection and promotion of researches relating to Coleoptera-----	18, 948. 75	987. 94
Chamberlain, Francis Lea, for increase and promotion of Isaac Lea Collection of gems and mollusks-----	42, 571. 13	2, 219. 58
Dykes, Charles, for support in financial research-----	65, 085. 37	3, 393. 41
Eickemeyer, Florence Brevoort, for preservation and exhibition of the photographic collection of Rudolph Eickemeyer, Jr-----	16, 431. 70	856. 73
Hanson, Martin Gustav and Caroline Runice, for some scientific work of the Institution, preferably in chemistry or medicine-----	13, 439. 14	700. 71
Higbee, Harry, income for general use of the Smith- sonian Institution after June 11, 1967-----	48. 56	1. 49
Hillyer, Virgil, for increase and care of Virgil Hillyer collection of lighting objects-----	9, 935. 35	518. 01
Hitchcock, Albert S., for care of the Hitchcock Agrostological Library-----	2, 385. 43	124. 39
Hrdlička, Aleš and Marie, to further researches in physical anthropology and publication in connec- tion therewith-----	76, 090. 74	3, 770. 58
Hughes, Bruce, to found Hughes alcove-----	28, 936. 60	1, 508. 70
Johnson, E. R. Fenimore, research in underwater photography-----	10, 546. 65	522. 63
Loeb, Morris, for furtherance of knowledge in the exact sciences-----	131, 751. 73	6, 869. 23
Long, Annette and Edith C., for upkeep and pres- ervation of Long collection of embroideries, laces, and textiles-----	820. 82	42. 80
Maxwell, Mary E., for care and exhibition of Maxwell collection-----	29, 651. 40	1, 545. 94

CONSOLIDATED FUND—continued

Fund	Investment 1962	Income 1962
Myer, Catherine Walden, for purchase of first-class works of art for use and benefit of the National Collection of Fine Arts.....	\$30,535.47	\$1,592.04
Nelson, Edward W., for support of biological studies.....	33,618.85	1,752.79
Noyes, Frank B., for use in connection with the collection of dolls placed in the U.S. National Museum through the interest of Mr. and Mrs. Noyes.....	1,452.37	75.70
Pell, Cornelia Livingston, for maintenance of Alfred Duane Pell collection.....	11,205.62	584.25
Petrocelli, Joseph, for the care of the Petrocelli collection of photographic prints and for the enlargement and development of the section of photography of the U.S. National Museum.....	11,206.92	584.30
Rathbun, Richard, for use of division of U.S. National Museum containing Crustacea.....	16,078.72	838.30
*Reid, Addison T., for founding chair in biology, in memory of Asher Tunis.....	26,889.37	1,401.97
Roebbling Collection, for care, improvement, and increase of Roebbling collection of minerals.....	182,448.20	9,512.42
Roebbling Solar Research.....	25,908.78	1,425.07
Rollins, Miriam and William, for investigations in physics and chemistry.....	215,074.58	10,928.64
Smithsonian employees' retirement.....	35,185.27	1,851.54
Springer, Frank, for care and increase of the Springer collection and library.....	27,109.61	1,413.41
Strong, Julia D., for benefit of the National Collection of Fine Arts.....	15,115.01	788.07
Walcott, Charles D. and Mary Vaux, for development of geological and paleontological studies and publishing results of same.....	724,193.35	37,719.87
Walcott, Mary Vaux, for publications in botany.....	87,506.96	4,562.40
Younger, Helen Walcott, held in trust.....	117,024.81	6,027.49
Zerbee, Francis Brinckle, for endowment of aquaria.....	1,433.98	74.76
Total.....	2,461,076.99	126,859.03

*In addition to funds deposited in the United States Treasury.

FREER GALLERY OF ART FUND

Early in 1906, by deed of gift, Charles L. Freer, of Detroit, gave to the Institution his collection of Chinese and other Oriental objects of art, as well as paintings, etchings, and other works of art by Whistler, Thayer, Dewing, and other artists. Later he also gave funds for construction of a building to house the collection, and finally in his will, probated November 6, 1919, he provided stocks and securities to the estimated value of \$1,958,591.42, as an endowment fund for the operation of the Gallery. The fund now amounts to \$10,089,088.74.

SUMMARY OF ENDOWMENTS

Invested endowment for general purposes.....	\$2, 514, 430. 72
Invested endowment for specific purposes other than Freer endowment.....	2, 633, 131. 93
Total invested endowment other than Freer.....	5, 147, 562. 65
Freer invested endowment for specific purposes.....	10, 089, 088. 74
Total invested endowment for all purposes.....	15, 236, 651. 39

CLASSIFICATION OF INVESTMENTS

Deposited in the U.S. Treasury at 6 percent per annum, as authorized in the U.S. Revised Statutes, sec. 5591.....	\$1, 000, 000. 00
Investments other than Freer endowment (cost or market value at date acquired) :	
Bonds	\$1, 478, 884. 02
Stocks	2, 594, 012. 40
Real estate and mortgages.....	57, 506. 00
Uninvested capital.....	17, 160. 23
Total investments other than Freer endowment.....	4, 147, 562. 65
Investment of Freer endowment (cost or market value at date acquired) :	
Bonds	\$5, 055, 130. 47
Stocks	5, 023, 175. 83
Uninvested capital.....	10, 782. 44
Total investments.....	10, 089, 088. 74
Total investments.....	15, 236, 651. 39

EXHIBIT A

BALANCE SHEET OF PRIVATE FUNDS

June 30, 1962

ASSETS

Current funds :

General :

Cash :

United States Treasury current account.....	\$777, 833. 49
In banks and on hand.....	417, 888. 82
	1, 195, 722. 31
Travel and other advances.....	17, 680. 35

Total general funds.....	1, 213, 402. 66
---------------------------------	------------------------

Restricted :

Cash—United States Treasury current account	\$2, 569, 147. 45
Investments—stocks and bonds (quoted market value \$1,619,839.07).....	1, 635, 712. 56

Total restricted funds.....	4, 204, 860. 01
------------------------------------	------------------------

Total current funds.....	5, 418, 262. 67
---------------------------------	------------------------

EXHIBIT A—Continued

ASSETS—continued

Endowment funds and funds functioning as endowment:

Investments:

Freer Gallery of Art:

Cash-----	\$10,782.44	
Stocks and bonds (quoted market value \$13,306,202.51)-----		10,078,306.30
		<u>10,089,088.74</u>

Consolidated:

Cash-----	\$16,880.03	
Stocks and bonds (quoted market value \$4,696,018.45)-----		3,952,602.87
		<u>3,969,482.90</u>

Loan to United States

Treasury-----	1,000,000.00	
Other stocks and bonds (quoted market value \$143,894.75)-----	120,293.55	
Cash-----	280.20	
Real estate at book value--	57,506.00	5,147,562.65
Total endowment funds and funds functioning as endowment-----		<u>15,236,651.39</u>
Total-----		<u>20,654,914.06</u>

FUND BALANCES

Current funds:

General:

Unexpended funds—unrestricted-----		\$1,213,402.66
Total general funds-----		<u>1,213,402.66</u>

Restricted (Exhibit C):

Unexpended income from endowment---	\$1,210,899.50	
Funds for special purposes (gifts, grants, etc.)-----	2,993,960.51	
Total restricted funds-----		<u>4,204,860.01</u>
Total current funds-----		<u>5,418,262.67</u>

Endowment funds and funds functioning as endowment (Exhibit D):

Freer Gallery of Art-----	\$10,089,088.74	
Other:		
Restricted-----	\$2,633,131.93	
General-----	2,514,430.72	5,147,562.65
Total endowment funds and funds functioning as endowment-----		<u>15,236,651.39</u>
Total-----		<u>20,654,914.06</u>

EXHIBIT B

PRIVATE FUNDS

STATEMENT OF CURRENT GENERAL FUND RECEIPTS AND DISBURSEMENTS
AND CHANGES IN CURRENT GENERAL FUND BALANCES

Year ended June 30, 1962

	Operations	Publications	Gifts and grants
Current receipts:			
Endowment income:			
Freer Gallery of Art.....	\$437,961.29	-----	-----
Other restricted funds.....	64,905.35	-----	-----
Unrestricted.....	138,086.56	-----	-----
Investment income.....	66,007.78	-----	-----
Gifts and grants, including administrative overhead.....	214,440.80	-----	\$6,074,087.84
Publications and photographs.....	-----	\$108,251.13	-----
Miscellaneous.....	9,266.44	-----	-----
Appropriated from endowment fund.....	325.53	-----	-----
Total current receipts.....	930,993.75	108,251.13	6,074,087.84
Current expenditures:			
Salaries:			
Administrative.....	125,382.46	-----	-----
Research.....	19,717.71	-----	2,589,259.57
Other.....	185,385.66	-----	-----
Total salaries.....	330,485.83	-----	2,589,259.57
Purchase for collection.....	140,568.30	-----	-----
Researches and exploration and related administrative expenses:			
Travel.....	17,264.74	-----	-----
Equipment and supply.....	4,644.55	-----	-----
Other.....	9,890.90	-----	3,484,828.27
Publications and photographs.....	40,015.86	51,296.65	-----
Buildings, equipment, and grounds:			
Buildings and installations.....	19,190.93	-----	-----
Court and grounds maintenance.....	742.11	-----	-----
Technical laboratory.....	2,404.57	-----	-----
Contractual services—custodian and legal fees.....	23,109.21	-----	-----

EXHIBIT B—Continued

PRIVATE FUNDS—Continued

STATEMENT OF CURRENT GENERAL FUND RECEIPTS AND DISBURSEMENTS
AND CHANGES IN CURRENT GENERAL FUND BALANCES—continued

Year ended June 30, 1962—Continued

	Operations	Publications	Gifts and grants
Current expenditures—Continued			
Salaries—Continued			
Supplies and expenses:			
Meetings, special exhibits.....	\$17, 112. 96	-----	-----
Lectures.....	3, 063. 57	-----	-----
Photographs and reproductions.....	5, 679. 83	-----	-----
Library.....	4, 056. 35	-----	-----
Sales desk.....	15, 386. 14	-----	-----
Stationery and office supplies.....	105. 27	-----	-----
Postage, telephone, and telegraph.....	212. 57	-----	-----
Employees' withholding payments, net.....	(753. 61)	-----	-----
Total current expenditures.....	633, 180. 08	51, 296. 65	6, 074, 087. 84
Excess of current receipts over current expenditures.....	297, 813. 67	56, 954. 48	354, 768. 15
Balance at beginning of year.....	-----	-----	858, 634. 51
Balance at end of year.....	-----	-----	1, 213, 402. 66

EXHIBIT C

PRIVATE FUNDS

STATEMENT OF CHANGES IN CURRENT RESTRICTED FUND BALANCE

Year ended June 30, 1962

	Unexpended income	Funds for special purposes (gifts, grants, etc.)	Total
Balance at beginning of year	\$1, 084, 076. 28	\$2, 290, 370. 27	\$3, 374, 446. 55
Add:			
Income from restricted endowment:			
Freer Gallery of Art	470, 093. 22	-----	470, 093. 22
Other restricted funds	273, 011. 96	-----	273, 011. 96
	743, 105. 18	-----	743, 105. 18
Less custodial costs	31, 119. 62	-----	31, 119. 62
	711, 985. 56	-----	711, 985. 56
Net income from restricted endowment	711, 985. 56	-----	711, 985. 56
Sale of publications	36, 329. 31	619. 30	36, 948. 61
Gifts and grants	-----	6, 676, 997. 94	6, 676, 997. 94
Other	4, 762. 85	252, 054. 13	256, 816. 98
Transfer from endowment funds, net	-----	1, 381. 69	1, 381. 69
	1, 837, 154. 00	9, 221, 423. 33	11, 058, 577. 33
Deduct:			
Transfer to current income, net of custodial cost:			
Freer Gallery of Art	407, 917. 14	-----	407, 917. 14
Other restricted funds	63, 829. 88	6, 074, 087. 84	6, 137, 917. 72
Unrestricted	138, 086. 56	-----	138, 086. 56
	609, 833. 58	6, 074, 087. 84	6, 683, 921. 42
Transfer	-----	159, 626. 14	159, 626. 14
Income added to principal, net	10, 169. 76	-----	10, 169. 76
Transfer to (from) gifts and grants	6, 251. 16	(6, 251. 16)	-----
	626, 254. 50	6, 227, 462. 82	6, 853, 717. 32
Balance at end of year	1, 210, 899. 50	2, 993, 960. 51	4, 204, 860. 01

EXHIBIT D

PRIVATE FUNDS

STATEMENT OF CHANGES IN PRINCIPAL OF ENDOWMENT FUNDS AND FUNDS
FUNCTIONING AS ENDOWMENT

Year Ended June 30, 1962

Balance at beginning of year-----		\$14, 592, 560. 72
Add:		
Gifts and bequests (including transfer of Johnson Fund)-----	\$56, 340. 53	
Income added to principal as prescribed by donor-----	10, 169. 76	
Net gain on investments-----	586, 454. 75	652, 965. 04
		<hr/>
		15, 245, 525. 76
Deduct:		
Amount transferred to gifts and grants for Roebling Fund-----	8, 548. 84	
Amount appropriated to current funds for retirement payments-----	325. 53	8, 874. 37
		<hr/>
		15, 236, 651. 39
		<hr/> <hr/>
Balance at year end consisting of:		
Unrestricted -----	2, 514, 430. 72	
Restricted for:		
Freer Gallery of Art-----	10, 089, 088. 74	
Other collections and research-----	2, 633, 131. 93	
		<hr/>
		15, 236, 651. 39

The practice of maintaining savings accounts in several of the Washington banks and trust companies has been continued during the past year, and interest on these deposits amounted to \$10,986.45.

Deposits are made in banks for convenience in collection of checks, and later such funds are withdrawn and deposited in the United States Treasury. Disbursement of funds is made by check signed by the Secretary of the Institution and drawn on the United States Treasury.

The Institution gratefully acknowledges gifts and grants from the following:

A. P. Smith Manufacturing Corporation, a gift to the Marine Archeology Fund.
Academic Press, a contribution to the Rathbun Fund.

American Cocoa Research Institute, a grant to defray costs of art work in connection with a monograph of the genus *Theobroma*.

American Council of Learned Societies, a grant for participation in the International Congress on the Antiquity and Origin of Man in the Americas.

American Philosophical Society, a grant for support of research on the Oklahoma Seneca Cayuga Indians.

Appalachian Power Co., a grant to cover preliminary archeological surveys in the Smith Mountain Reservoir Area on the Roanoke River.

Atomic Energy Commission :

A grant for the support of research entitled "A Study of the Biochemical Effects of Ionizing and Nonionizing Radiation on Plant Metabolism during Development."

A grant for the support of research entitled "Systematic Zoological Research on the Marine Fauna of the Tropical Pacific Area."

Lucy H. Baird, bequest for the Spencer Fullerton Baird Fund.

Laura Dreyfus Barney, a gift to finance the publication of the catalog of the Barney Collection.

Laura Dreyfus Barney and Natalie Clifford Barney, additional interest in Barney Studio House (aggregate of two quarterly shares received).

Charles and Rosanna Batchelor Memorial Incorporated, a grant for the purpose of improving the Emma E. Batchelor stamp collection.

Bredin Foundation, additional grant for the support of research entitled "Ocean Food Chain Cycle."

Mrs. M. P. Bryon, a gift for the purchase of historic items for the National Aeronautical Collection.

Bureau of Naval Weapons, grant for procurement of changes incidental to construction of the scale model of the A-I Airplane.

Mrs. J. Campbell, a contribution to the Zoo Animal Fund.

Department of the Air Force :

Additional grant for upper atmosphere stellar image study.

Additional grant for research directed toward providing a program for use with an I.B.M. 704 Computer for determination of satellite density data.

Additional grant for the study of "Atmospheric Entry and Impact of High Velocity Meteorites."

Additional grant for research directed toward the study of stellar scintillation.

Additional grant for research directed toward the studies of rate of accretion of interplanetary matter by the earth.

Department of the Army :

A grant for support of research entitled "Potential Vectors and Reservoirs of Disease in Strategic Overseas Areas."

A grant for the support of research entitled "Mammals and their Ectoparasites from Ethiopia."

Additional grant for research entitled "Procurement of Satellite Tracking and Orbit."

Eastern Federation of Gem and Minerals Societies, fund for inspection of an exhibit of gems and minerals.

Embassy of Guatemala, a gift for investigating a fossil vertebrate occurrence near Zacapa.

Felix and Helen Juda Foundation, a gift to the Freer Gallery of Art for the purchase of collections.

Fred Maytag Family Foundation, a gift to the Marine Archeology Fund.

General Atomic Division, a gift to the Meteorite Fund.

Goodman Manufacturing Co., a gift for the purchase of the Benard Mining Prints.

For purchase of the Harleton Texas Meteorite :

Brookhaven Laboratory

Carnegie Institute of Technology

University of California

University of Chicago

University of Kentucky

Harvard University, a grant for Symposium of Evolution of Crustacea.

International Association for Dental Research, gift for research in Physical Anthropology.

Edwin A. Link, a gift to the Marine Archeology Fund.

Link Foundation, a grant for the support of special publications on aviation.

Mrs. Ethel B. McCay, a gift for the purchase of postal history material.

National Aeronautics and Space Administration :

Additional grant for the support of research entitled "Optical Satellite Tracking Program."

Additional grant for the scientific and engineering study for instrumenting and orbiting telescope.

Additional grant for research on the motion of artificial satellites.

National Geographic Society, additional grant for Paleo-Indian investigations at Agate Basin, Eastern Wyoming.

National Institutes of Health, a grant for the support of research entitled "Studies of Asian Biting Flies."

National Science Foundation :

Grant for the support of research entitled "Ordovician Gastropods of Norway and a Comparison of American and European Ordovician Gastropods."

Additional grant for the support of research entitled "Monographic Studies of the Family Tingidae."

Grant for the support of research entitled "Morphology and Paleocology of the Permian Brachiopods of the Glass Mountains, Texas."

Additional grant for the support of research entitled "Endocrine Basis of Parasitic Breeding of Birds."

Grant for the support of research entitled "The Flora of Fiji."

Grant for the support of research entitled "Mammals of Southeastern United States."

Additional grant for the support of research entitled "Tertiary Forests of the Tonasi-Santiago Basin of Panama."

Additional grant for the support of research entitled "Phanerogams of Colombia."

Additional grant for the support of research entitled "South Asian Microlepidophers, Particularly the Philippine Series."

Additional grant for the support of research entitled "A Monograph of the Lichen Genus *Parmalia*."

Grant for the support of research entitled "Permo-Triassic Reptiles of South Africa."

Additional grant for the support of research entitled "Comparative Analysis of Behavior in Tropical Birds."

Grant for the support of research entitled "The Mammals of Panama."

Additional grant for the support of research entitled "Revisionary Study of the Blattoidea."

Additional grant for the support of research entitled "Taxonomy of the Bamboos: Redefinition of the Genera."

Grant for the support of research entitled "Stellar Atmospheres."

Grant for the support of research entitled "Settlement Patterns in the Missouri Valley."

Grant for the support of research entitled "Caddo Language Study."

Grant for the support of research entitled "A Late Pleistocene Fauna and Possible Human Associations near Littleton, Colorado."

Grant for the support of research entitled "Oldest Fossil Bryozoa of the United States."

- Grant for the support of research entitled "Taxonomy of Bamboos."
- Grant for the support of research entitled "Systematics and Distribution of North American Calanoid and Harpacticoid Copepoda."
- Grant for the support of research entitled "Scientific Community in England, 1820-1860."
- Grant for the support of research entitled "Photoresponses and Optical Properties of *Phycomyces* Sporangioophores."
- Grant for the support of research entitled "Ecology and Behavior of *Suncus murinus*."
- Grant for the support of research entitled "Paramo Flora of Northeastern Peru."
- Grant for the support of research entitled "Taxonomy of the Genus *Swartzia*."
- Grant for the support of research entitled "Foreign Cambrian Trilobites with American Affinities."
- Grant for support of research entitled "Systematic Significance of Echinoid Spines."

Office of Naval Research:

- Additional grant for support of research entitled "Information on Shark Distribution and the Distribution of Shark Attack all over the World."
- Additional grant for studies concerning the development of a proposal for an institute for laboratory of human performance standards.
- Additional grant for research in connection with studies on the marine fauna of the South Pacific Ocean.
- Additional grant to perform psychological research studies.
- Additional grant to perform aeronautical research studies.
- Grant for research on biological community interrelationships and to record observations of behavior on film.
- Additional grant to provide expert consultants to advise the Navy Advisory Committee.
- Grant for support of research studies on the Microlepidoptera of the Island of the mosquitoes of the world.
- Grant for support of research studies on the Microlepidoptera of the Island of Rapa.
- Grant for support of research entitled "A Study of Anatomy and Taxonomy of Hawaiian Woods."

B. T. Rocca, gift for the purchase of a geological specimen.

American Association of Museums through Rockefeller Brothers Fund, a grant to cover insurance on the Egyptian Collection to be exhibited by Smithsonian Institution Traveling Exhibition Service.

For the support of the Science Information Exchange:

- Atomic Energy Commission
- Department of Defense
- Department of the Navy
- Federal Aviation Agency
- National Aeronautics and Space Administration
- National Institutes of Health
- National Science Foundation
- Veterans' Administration

St. Petersburg Shell Club, fund for inspection of an exhibit of shells.

Philip M. Stern, a gift for animal shipment.

Chauncey Stillman, a gift for the restoration of a landau presented to the Smithsonian Institution by Mr. Stillman.

Tucson Gem and Mineral Society, fund for inspection of an exhibit of gems and minerals.

United States Information Agency, a grant for the support of the Third International Exhibition of Contemporary Ceramics held in Prague, Czechoslovakia.

United Van Lines, a gift to the Meteorite Fund.

University of West Indies, Trinidad, fund for Neotropical Botany Conference in Trinidad.

Villanova University, a gift for the special Paleontological Fund.

Woods Hole Oceanographic Institution, a grant for research cruise from Cape Sable, Nova Scotia, to Trinidad.

The following appropriations were made by Congress for the Government bureaus under the administrative charge of the Smithsonian Institution for the fiscal year 1962:

Salaries and Expenses.....	\$9, 125, 000. 00
National Zoological Park.....	1, 387, 600. 00

The appropriation made to the National Gallery of Art (which is a bureau of the Smithsonian Institution) was \$1,932,000.00.

In addition, funds were transferred from other Government agencies for expenditure under the direction of the Smithsonian Institution as follows:

Working Funds, transferred from the National Park Service, Interior Department, for archeological investigations in river basins throughout the United States.....	\$231, 705. 00
--	----------------

The Institution also administers a trust fund for partial support of the Canal Zone Biological Area, located on Barro Colorado Island in the Canal Zone.

AUDIT

The report of the audit of the Smithsonian Private Funds follows:

THE BOARD OF REGENTS,
Smithsonian Institution
Washington 25, D.C.

We have examined the balance sheet of private funds of Smithsonian Institution as of June 30, 1962, and the related statement of current general private funds receipts and disbursements and the several statements of changes in funds for the year then ended. Our examination was made in accordance with generally accepted auditing standards, and accordingly included such tests of the accounting records and such other auditing procedures as we considered necessary in the circumstances.

Land, building, furniture, equipment, works of art, living and other specimens and certain sundry property are not included in the accounts of the Institution; likewise, the accompanying statements do not include the National Gallery of Art and other departments, bureaus and operations administered by the Institution under Federal appropriations. The accounts of the Institution are maintained on the basis of cash receipts and disbursements, with the result that the accompanying statements do not reflect income earned but not collected or expenses incurred but not paid.

In our opinion, subject to the matters referred to in the preceding paragraph, the accompanying statement of private funds presents fairly the assets and funds principal of Smithsonian Institution at June 30, 1962; further the accompanying statement of current general private funds receipts and disbursements and several statements of changes in funds, which have been prepared on a basis consistent with that of the preceding year, present fairly the cash transactions of the private funds for the year then ended.

PEAT, MARWICK, MITCHELL & Co.

Washington, D.C.
September 17, 1962

Respectfully submitted:

(S) CLARENCE CANNON
(S) CARYL P. HASKINS
(S) ROBERT V. FLEMING
Executive Committee.

GENERAL APPENDIX
to the
SMITHSONIAN REPORT FOR 1962

ADVERTISEMENT

The object of the **GENERAL APPENDIX** to the Annual Report of the Smithsonian Institution is to furnish brief accounts of scientific discovery in particular directions; reports of investigations made by staff members and collaborators of the Institution; and memoirs of a general character or on special topics that are of interest or value to the numerous correspondents of the Institution.

It has been a prominent object of the Board of Regents of the Smithsonian Institution from a very early date to enrich the annual report required of them by law with memoirs illustrating the more remarkable and important developments in physical and biological discovery, as well as showing the general character of the operations of the Institution; and, during the greater part of its history, this purpose has been carried out largely by the publication of such papers as would possess an interest to all attracted by scientific progress.

In 1880, induced in part by the discontinuance of an annual summary of progress which for 30 years previously had been issued by well-known private publishing firms, the Secretary had a series of abstracts prepared by competent collaborators, showing concisely the prominent features of recent scientific progress in astronomy, geology, meteorology, physics, chemistry, mineralogy, botany, zoology, and anthropology. This latter plan was continued, though not altogether satisfactorily, down to and including the year 1888.

In the report of 1889, a return was made to the earlier method of presenting a miscellaneous selection of papers (some of them original) embracing a considerable range of scientific investigation and discussion. This method has been continued in the present report for 1962.

An "Author-Subject Index to Articles in Smithsonian Annual Reports, 1849-1961" (Smithsonian Publication 4503) was issued in 1963.

Reprints of the various papers in the General Appendix may be obtained, as long as the supply lasts, on request addressed to the Editorial and Publications Division, Smithsonian Institution, Washington 25, D.C.

Aircraft Propulsion

A REVIEW OF THE EVOLUTION OF AIRCRAFT POWERPLANTS¹

By C. FAYETTE TAYLOR

Professor of Automotive Engineering Emeritus, Massachusetts Institute of Technology

[With 27 plates]

VERY EARLY POWERPLANTS

Man's muscles, usually attached to flapping wings, were the earliest and most obvious source of power suggested for flight. In spite of innumerable attempts, even as late as 1921, there is no record of heavier-than-air sustained flight with this kind of power.² On the other hand, many early balloons were equipped with oars or paddles, and at least two dirigible balloons, Ritchell at Hartford, Conn., in 1878, and deLome in Paris, 1863, were equipped with propellers driven by pedals and a manned windlass, respectively. Cromwell Dixon of Seattle, Wash., demonstrated a dirigible powered by a pedal-driven propeller as late as 1907.

The first successful free flights by a man-made heavier-than-air contrivance seem to have been by model helicopters whose counter-rotating propellers, usually made of bird feathers, were driven by a wooden or whalebone bow. Gibbs-Smith, in his excellent historical book "The Aeroplane," credits the Chinese with this invention, as early as the fourth or fifth century, A.D. The first successful model helicopter of this type in the western world was by Launoy and Bienvenu in France in 1784, to be followed in 1792 by that of Sir George Cayley (fig. 1), "Father of British Aeronautics." Alphonse Pénau (1851-80) improved on Cayley's design by using twisted rubber bands, both for model helicopters and for a near-conventional model monoplane (fig. 2). This system of propulsion remains to this day the most important source of power for small airplane and helicopter

¹ The Fourth Lester B. Gardner Lecture, given at M.I.T. March 8, 1962, and at the Smithsonian Institution October 5, 1962.

² In May 1962, after this paper was written, John Wimpenny, at St. Albans, England, flew the monoplane *Puffin*, powered by a pedal-driven propeller, for ½ mile (Christian Science Monitor, May 18, 1962, p. 21). The *Puffin* is a specially built monoplane of 84 feet span weighing 115 pounds, with propeller behind the tail, geared to bicycle pedals.

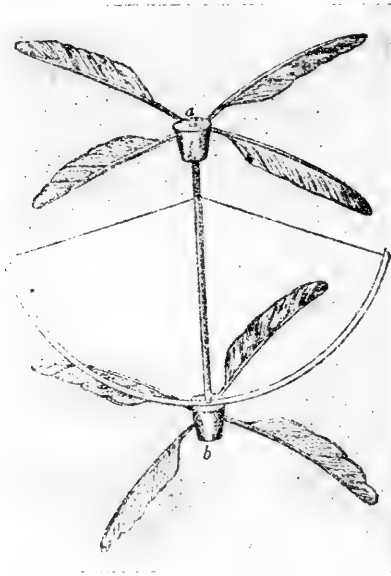

FIGURE 1.—Cayley helicopter model, bent-bow propulsion.

models, and even today probably powers many more “airplanes” than any other type of powerplant. It is of historical interest to note here that in the first detailed account of their pioneer flights the Wright Brothers attribute their early interest in flying to toy helicopters powered by rubber bands.

The first successful flight by a model airplane powered by other means than rubber bands is said to be that of DuTemple in France, 1858, using a clockwork motor. Steam power was later used by this same inventor, but there is no authentic record of successful flight. A compressed-air-driven model by Victor Tatin (France) made circular tethered flights in 1879.

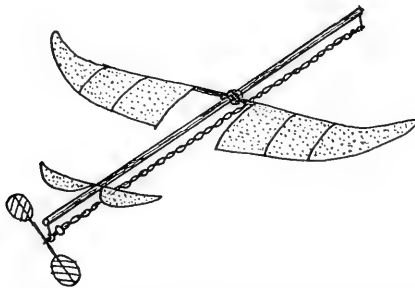

FIGURE 2.—Penaud Planaphore, rubber-band propulsion.

Odd sources of power, proposed and in some cases even tried, included tethered gryphons (birds were evidently considered inadequate), sails, and horses on a treadmill (obviously at least 1,000 pounds per hp.). The prize for ingenuity in the unconventional category might go to one Laurenco de Gusmão of Portugal, who, about the year 1700, is said to have proposed an aircraft sustained by magnets acting on electrified amber and propelled by a hand-power bellows blowing on its sails.

Sir George Cayley built and tested a "flying" machine powered by gunpowder in 1807, but it never flew. A model ornithopter with wings operated by gunpowder, built by Trouvé, is said to have risen from the ground in 1870, but I consider this doubtful.

There are records of two flights of dirigible airships using electric motors with batteries, namely, that of Tissandier at Auteuil in October 1883, and that of Renard and Krebs near Paris in August 1884. The latter machine was considered quite successful.

Rocket power, inspired by the Chinese invention of the ballistic rocket in the 12th century, was suggested by Gerard in 1784. An English cartoon of 1825 shows a proposed rocket in flight to the moon propelled by a steerable steam jet. For man-carrying powered flight, the first use of rockets was by Fritz von Opel (Germany) in 1928. First jet-engined flight was that of the Heinkel-178 airplane in Germany, August 27, 1939, powered with the HeS-3B gas turbine engine of 1,100 pounds thrust developed by Pabst von Ohain.

STEAM POWER

Steam power became a popular proposal for aerial navigation in the early 19th century, soon after it had been successfully demonstrated in ships, locomotives, and road vehicles.

A model helicopter by W. H. Phillips (England) rose from the ground under steam power in 1842. Power was by steam jets in the wing tips, a remarkable anticipation of a modern application of jet power.

Contrary to most historical statements, the steam-driven models of Henson and Stringfellow were apparently not capable of sustained rising or level flight. In the short indoor flights of record, take-off was from a horizontal wire somewhat higher than the landing point. Thus, these flights were what may be called "powered glides." However, the powerplants used are of interest because of their advanced design. Gibbs-Smith attributes the powerplant design to Henson, stating that Stringfellow was more the skilled mechanic than the inventor. The 20-foot-span model built by Henson, but never flown, was said to include a well-designed steam plant, but details are diffi-

cult to find. Stringfellow's "flying" model was a 10-foot-span monoplane equipped with a $\frac{3}{4}$ -inch bore by 2-inch stroke double-acting steam engine driving two mid-wing 16-inch propellers geared to three times engine speed. Its best powered glide was for about 120 feet indoors. A Stringfellow engine and boiler, a multibulb affair, is now at the National Air Museum of the Smithsonian Institution (pl. 1, fig. 1).

A dirigible balloon with a 3-hp. steam plant weighing 351 pounds was flown by Henri Giffard from Paris to Trappes in 1851 (pl. 1, fig. 2.) I have not found a technical description of this engine. In spite of earlier and later designs for steam-driven dirigible balloons, that of Giffard seems to be the only one which made successful flights.

Mozhaiski in Russia in 1884 and Clement Ader in 1890 both built and tested full-scale steam-powered machines. At most, these machines made short uncontrolled "hops." Only Ader's machine seems to have had the ability to lift itself without external assistance. No engine details seem to be available.

The best-known full-scale attempt at flight with steam was that of Sir Hiram Maxim in 1893. Maxim was an experienced steam engineer, and his powerplant was far more advanced than the aircraft to which it applied. It was rated at 363 hp. and weighed, complete, 1,800 pounds or 5 pounds per hp. The engine, a two-cylinder affair (pl. 2, fig. 1), was evidently of extraordinarily light weight. The boiler (pl. 2, fig. 2) was of the multiple water-tube type, very much like modern marine steam boilers. Operation along rails indicated that this engine could furnish the power necessary to lift even the monstrous contraption in which it was installed. Lack of success with this machine was not the fault of the powerplant.

Any discussion of steam power for aircraft should include the work of S. P. Langley who built and successfully flew an unmanned steam-powered model of 14-foot span in 1896. Fortunately, Langley's records are complete, and full technical details are available. The most notable feature of Langley's steam powerplants (pl. 3, fig. 1) was the use of "flash" boilers, that is, boilers consisting of one or more long coiled tubes, with water pumped in at one end and steam issuing from the other. This type was used successfully later in the White automobile and is probably the type which would be used today if no alternative to steam power was available. Langley's steam plants weighed in the neighborhood of 7 pounds per horsepower. He was perhaps the first to grapple with the problem of flame "blowout" in an aeronautical burner. A sentence from his memoirs reads in part, "Unfortunately there is a limit to this process (increasing the air flow through the burner) of increasing the air supply . . . a certain speed

of efflux cannot be exceeded without putting the flame out." The early jet engines encountered this same problem.

Of course, steam ceased to be of importance for aircraft after flights by the Wright brothers and others had demonstrated the superior qualities of the internal-combustion engine. Steam was given the final coup-de-grace by a United States officer, brought up on steam power, who reported in 1926, "On the basis of these three considerations (weight, economy, air resistance) they (steam powerplants) are absolutely impossible." My own opinion is not so extreme. If steam power was without competitors, we would have successful steam aircraft today, but at a considerable sacrifice in performance and perhaps also in safety.

Steam power continues to have an emotional appeal to many people, and interest in steam power on the part of such enthusiasts continued into the 1930's. A Travelair biplane powered with a steam engine by Besler was actually flown in California in 1932.

INTERNAL-COMBUSTION ENGINES

The earliest successful aeronautical application of this type of power appears to be in a dirigible balloon flight by Paul Haenlein in Germany in 1872. A 4-cylinder 5 hp. (40 r.p.m.) Lenoir engine using coal-gas fuel was used. The Lenoir engine was the first commercial type of internal-combustion engine. The cylinders drew in air for half the stroke and fired at atmospheric pressure at midstroke. Efficiency was low—about 5 percent.

The relatively light-weight and relatively efficient "Otto-cycle" gasoline engine began with developments in England and Germany in the 1880's, stimulated by automobile development. Its application to aircraft came soon after. The first flight with this type engine was apparently that of David Schwartz in Germany in a dirigible balloon in 1897.

Santos Dumont flew a dirigible in Paris in 1898, equipped with a pair of "tricycle" engines in tandem, rated together at $3\frac{1}{2}$ hp. and weighing, it is said, 66 pounds, or 19 pounds per hp. These engines were probably forerunners of the 3 hp. Clement engine used by Dumont for his one-man dirigible airship flown during the summer of 1903. This engine was a two-cylinder Vee type, air cooled, and weighed 8.8 pounds per hp.

The first successful heavier-than-air flight powered by a gasoline engine was that of Langley's $\frac{1}{4}$ -size model, which flew 350 feet on June 18, 1901, and 1,000 feet on August 8, 1903. The engine (pl. 3, fig. 2) was a 5-cylinder air-cooled radial, designed and built by Stephen M. Balzer and redesigned and rebuilt by Charles M. Manly. It gave 3.2 hp. at 3,000 r.p.m. with a weight of 7 pounds (see table

MANLY AND VEAL
CONSULTING ENGINEERS
250 WEST 54TH STREET
NEW YORK

April 27, 1926.

Professor C. Fayette Taylor,
Aeronautical Department,
Massachusetts Institute of Technology,
Cambridge A, Massachusetts.

Dear Professor Taylor:-

I had forgotten that I had not included in the Memoir the more detailed information concerning the size, weight and speed of the small Manly Motor.

Unfortunately, I cannot refer to the original records which were returned for safe keeping to the Archives of the Smithsonian. However, my recollection of the matter, I think, is quite accurate and is as follows:

The bore was 2-1/16" diameter; the stroke 2-3/4"; the power developed was 3 H.P. at 1800 R.P.M. and the weight was just ten (10) lbs., including carbureter, ignition coil and the small storage battery that had a life of about five (5) minutes service in firing the engine.

I do not recall that any photographs were made of this engine except while it was assembled in the frame of the quarter-size model and believe that the pictures shown in the Memoir are as good as any that I had of it.

The cylinders of this engine were made of heavy steel tubing turned down to form thin integral radiating fins, with the cylinder barrel only 1/32" thick at the bottom of the fins. Cast iron liners were shrunk into these cylinders and were bored out to leave them 1/32" thick. The cylinder heads were made from solid hand forgings (machined out) which were screw threaded and brazed to the steel cylinder barrels before the latter were finish machined. The general plan of construction of it was similar to that of the large engine except that it was air-cooled instead of water-cooled.

I will try to look up some personal memoranda that I have and see if I can give you more definite detailed data regarding the weight of the engine and its accessories, but, I think the above information is fairly accurate as to general features.

Yours very truly,

CHM/MCB

Chas. M. Manly

FIGURE 3.—Letter from Charles M. Manly describing the small gasoline engine.

1 for other data). At 2.2 pounds per hp., this engine can legitimately be described as remarkable for its time. Figure 3 shows a letter from C. M. Manly giving some data on this engine that were not published in the memoirs.

The first man-carrying heavier-than-air flights were, of course, those of the Wright brothers on December 17, 1903. The engine used was their own design. In these four flights, assisted takeoff was not used (as it was in later flights). Thus, powered heavier-than-air flight by man was first achieved on that day.

The Wright engine of 1903, and Charles Manly's magnificent full-scale engine completed late in 1901, and tested in 1902, 1903, and 1904 (also based somewhat on Balzer's design), may be taken as the real beginning of the age of the reciprocating internal-combustion engine in aeronautics. As such, these engines are worthy of some detailed attention.

WRIGHT BROTHERS' ENGINE

Little was known about the accomplishments of the Wright brothers until some years after their flights of December 17, 1903. Figure 4 shows a short and amusingly inaccurate report in the *New York Times* of December 26, 1903, which attracted little attention.

In spite of the fact that the flights near Dayton in 1904 and 1905 were witnessed by numerous people, the press paid them no attention. The first eyewitness report published was a letter in *Gleanings in Bee Culture*, Medina, Ohio, January 1, 1905, by its publisher, A. I. Root, under the title "What God Hath Wrought."

The first public report by the Wrights themselves appeared in the *Century Magazine* of September 1908. (The *Century* was similar in content and format to Harper's and the *Atlantic Monthly*.) At the time of publication I discovered this article in our home copy of the "Century." In spite of its many photographs of the machine in flight, my father refused to believe that human flight had been achieved. This attitude was pretty general at the time, partly on account of the great number of false claims to flight which had been made in the past. These claims also account for the incredible absence of reports by the Dayton press, whose representatives, after witnessing two unsuccessful attempts at flight in 1904, failed to report eyewitness accounts of the many flights made in 1904 and 1905, or even to go 8 miles out of town to see for themselves!

The *Century* article is extraordinary in its simple and beautiful expository style, and in its evidence of the almost excessive modesty of the brothers Wright, together with their rationality and persistence. I believe that it should be rated as a classic in American scientific literature.

AIRSHIP AFTER BUYER.

Inventors of North Carolina Box Kite Machine Want Government to Purchase It.

Special to The New York Times.

WASHINGTON, Dec. 25.—The inventors of the airship which is said to have made several successful flights in North Carolina, near Kitty Hawk, are anxious to sell the use of their device to the Government. They claim that they have solved the problem of aerial navigation, and have never made a failure of any attempt to fly.

Their machine is an adaptation of the box kite idea, with a propeller working on a perpendicular shaft to raise or lower the craft, and another working on a horizontal shaft to send it forward. The machine, it is said, can be raised or lowered with perfect control, and can carry a strong gasoline engine capable of making a speed of ten miles an hour.

The test made in North Carolina will be fully reported to the Ordnance Board of the War Department, and if the machine commends itself sufficiently, further tests will be made in the vicinity of Washington, and an effort made to arrange a sale of the device to the Government. The use to which the Government would put it would be in scouting and signal work, and possibly in torpedo warfare.

FIGURE 4.—*New York Times* account of Wright brothers' first airplane, Dec. 25, 1903.

The 1903 Wright engine (pl. 4, fig. 1) was designed by the brothers Wright and built with the assistance of their faithful mechanic, Charles E. Taylor (not related to the writer). This engine is especially well described by Robert B. Meyer, Jr., in the Annual Report of the Smithsonian Institution for 1961. It was a 4-cylinder water-cooled, horizontal engine of 200 cubic inches displacement, with automatic inlet valves. Fuel was supplied by gravity from a small can on top of the engine. From there it flowed through an adjustment valve to a surface in the intake pipe which was heated by the cylinder water jacket. Ignition was by a low-tension magneto with "make-and-break" spark contacts in the cylinders. The engine would give 16 hp. for a minute or so, after which it gave a steady 12 hp. Control, such as it was, was by the spark timing. As shown in table 1, this engine was heavy and of low power compared to the contemporary Manly engine, but it flew! This basic design was later improved by the Wrights so that by 1910 it was delivering 30 hp. for a weight of 180 pounds, 6 pounds per hp.

The first and subsequent engines followed contemporary automobile practice in cylinder arrangement. However, the water jacket and crankcase were of cast aluminum, an innovation which, although

in use for aircraft engines from the beginning, has just recently come into use for some automobiles. After being in England for a number of years, No. 1 Wright engine is now on display in the original airplane in the National Air Museum, Smithsonian Institution.

It was my good fortune to know Orville Wright, and to see him frequently during the period 1919 to 1923 when I was engineer-in-charge of the aircraft-engine laboratory of the U.S. Army Air Service in Dayton, Ohio. He had previously retired from active participation in aeronautics, and had become a very modest, very quiet, much beloved member of the Dayton community, and of the famous Dayton Engineers Club.

THE 1903 MANLY ENGINE

Considering the then state of the art, this 52-hp. 5-cylinder water-cooled radial engine represents one of the most remarkable pieces of engineering design and construction ever achieved. Manly, a young graduate of Cornell University, was hired by S. P. Langley, to supervise the design and construction of his "aerodromes" and to pilot the 1903 machine.

The history of this engine is interesting. In December 1898 Langley contracted with a New York City automobile builder, Stephen M. Balzer, for a 12-hp. engine to be completed in 3 months. Considering that even now, the development of a reliable gasoline engine is a matter of at least 2 years, this contract must stand as one of the most optimistic on record!

In May 1900 Manly worked with the Balzer engine, a rotary radial, and came to the conclusion that it was, to say the least, unpromising. At this point Langley and Manly spent 3 months in America and Europe trying to obtain at least the promise of an engine to meet their requirements, but without success. It was decided therefore that Manly should take up the further development of the Balzer engine. Balzer had been working on both the quarter-scale and the full-scale engines. All Balzer's engines were of the rotating-radial type, but Manly decided, quite wisely, to use the stationary radial principle. Using a number of parts made by Balzer, the full-scale engine which he finally completed late in 1901 is shown in plate 5 with statistics in table 1, page 294.

This engine, described in detail in the Langley Memoirs, is now displayed in the Smithsonian removed from the "aerodrome." Power was carefully measured on a dynamometer and, most remarkably, sustained for three consecutive 10-hour tests. The specific weight, 2.58 pounds per hp.,³ remained as a low record until the Liberty engine of

³ Without water or flywheels, but with ignition battery. This condition is the same as for the weights quoted for other liquid-cooled engines.

1918. The figure of 0.196 pound per cubic inch displacement has never been closely approached.

The 5-inch bore cylinders, assembled and brazed together by Manly himself, were built up of steel $\frac{1}{16}$ inch thick, lined with $\frac{1}{16}$ inch of cast iron.⁴ Water jackets were steel 0.020 inch thick. The difficulty of the brazing operation is mentioned by Manly and can well be imagined. Cylinder heads and valve pockets were machined integrally with the $\frac{1}{16}$ -inch-thick barrels.

The engine completely anticipated modern large aircraft engines in the use of the radial arrangement with a master connecting rod, the cam and valve-gear arrangement, and the use of crankcase, cylinders, and other parts machined all over to carefully controlled dimensions.

Manly's skill as an engineer and machinist was matched by his courage in making two (unsuccessful) takeoffs from the top of a houseboat, without previous instruction or experience as a pilot and in an airplane without landing gear. His survival of two crashes into the icy waters of the Potomac River testifies to his quick thinking and skill as a swimmer. In contrast to the poor preparation for the Manly attempts, the Wright brothers, before making their first powered flights, had become skilled aviators by virtue of over 1,000 flights in gliders of a size and type quite similar to that of their first powered airplane. All early Wright machines were equipped with landing skids.

Nowadays it is hard to appreciate the difficulties of these early aircraft-engine builders. Although successful automobiles were in operation both in Europe and in the United States, most of them were equipped with engines far too heavy and too low in power for airplane use. Accessory equipment such as spark plugs, carburetors, and magnetos was not available on the open market and had to be obtained from reluctant automobile builders or else built by hand. Worst of all, there was no established body of good practice, and details of existing practice were either very difficult to find or else held as closely guarded secrets. In view of these difficulties, the accomplishments of the Wrights and Manly are all the more remarkable.

ENGINES 1907-1909

After the Wrights had demonstrated the actuality of airplane flight, a period of nearly 3 years elapsed before anyone else flew in a heavier-than-air craft. Meanwhile the Wrights increased their duration of flight to more than half an hour and their distance to nearly 25 miles, both records accomplished in their flight of October 5, 1905. In 1906 the Hungarian Vuia, the Dane Ellehammer, and the Brazilian

⁴ Later development shows this to have been unnecessary. Steel cylinder bores have been used since the Gnome engines of 1909.

Alberto Santos-Dumont accomplished flights, hardly more than short "hops," in airplanes with unconvincing control systems. Not until November 9, 1907, did anyone but the Wright brothers fly as long as 1 minute, or over 1,000 ft. On that date Henri Farman in a "Voisin" biplane flew for 3,368 feet in 1 minute 14 seconds, with a 50 hp. "Antoinette" engine, apparently under good control.

"Antoinette" engines (pl. 6) were built in Paris by Lavavasseur as early as 1905 and were to become very important powerplants for European aviation in the next few years. Santos-Dumont used one rated at 24 hp. for his "hop" of 772 feet in November 1906. Both Farman's and Santos-Dumont's engines were 8-cylinder Vee types, rated at 24 and 50 hp. respectively. Farman's engine weighed 3 pounds per hp., a remarkable figure at that time (see table 1, page 295).

"Antoinette" engines had machined-steel cylinders with electrically deposited copper water jackets. All were water-cooled Vee type and were later built in 16- and 32-cylinder models. Together with the engines of Glenn Curtiss, and the E.N.V. engines (France, 1909) they pioneered the use of the water-cooled Vee engine in aeronautics. Other noteworthy details of the "Antoinette" included inlet-manifold fuel injection, and evaporative cooling.

Bleriot also used the 50-hp. "Antoinette" engine in his first tractor monoplane, No. VII, which flew in December 1907. The first helicopter to lift a man off the ground (Cornu, November 13, 1907) was also powered with an "Antoinette" engine. Cody made the first airplane flight in England October 16, 1908, with an airplane somewhat resembling the Wright in design, powered by the 50-hp. "Antoinette."

The year 1908 was memorable for rapid development of increasingly successful airplanes and engines. Except for Wright airplanes (which had flown over an hour), the longest flight was by Farman in a "Voisin"—44 minutes on October 2. Two important new engines appeared, namely, the 50-hp. Renault 8-cylinder air-cooled Vee (80-hp. example, pl. 7, fig. 1) and a Curtiss Vee 8-cylinder engine in the *June Bug* (1 minute 43 seconds flight on July 4) (pl. 8, fig. 1). On the last day of 1908 Wilbur Wright flew for 2 hours 24 minutes at Auvours, France—"un des plus passionants spectacles qu'ait jamais présenté l'histoire des sciences appliqués," according to a French commentator.

Glenn Curtiss was building and racing motorcycle engines soon after 1900. In 1902 Thomas Baldwin engaged him to supply an engine for Baldwin's dirigible airship, which flew successfully in 1904. In 1907 Curtiss joined the Aerial Experiment Association headed by Alexander Graham Bell, and thus began his distinguished career as a designer, builder, and pilot of both airplanes and engines.⁵

⁵ Also in 1907 Curtiss broke the world's motorcycle speed record (137 m.p.h.) with a 40 hp. V-8 air-cooled engine.

Curtiss's earliest engines were air-cooled, including the V-8 engine used in the famous *June Bug* (pl. 8, fig. 1). However, by 1908 he had settled on an 8-cylinder water-cooled Vee engine, similar to the "Antoinette" of Lavavasseur except that the cylinders were of cast iron, with monel-metal water jackets.

After the Wright brothers, Glenn Curtiss was certainly the most important figure in early American aviation, both in engine design and airplane design. The most noteworthy engine which developed from his early work was the famous "OX-5," to be described later. Engines bearing his name have an important place in aviation to this day.

The year 1909 has been called the "year of practical powered flying," because in that year flight began to be convincingly demonstrated by other than the Wright brothers. Four types of airplane—Wright, Antoinette, Farman, and Bleriot—demonstrated flights of more than 1 hour duration.

Bleriot made his famous cross-channel flight (37 minutes, 23.5 miles) on July 25, 1909. His tractor monoplane was equipped with the 25-hp. 3-cylinder Anzani, fan-type air-cooled engine (pl. 7, fig. 2). Later Anzani built one- and two-row radial air-cooled engines used in a number of airplanes prior to and soon after World War I. Another fan-type engine of this period was that of Esnault-Pelterie, installed in an unsuccessful airplane in 1907. His "R.E.P." fan-type engines were used subsequently in several successful airplanes.

An outstanding engine to appear in 1909 was the 50 hp. 7-cylinder "Gnome" rotary-radial, first flown in Henri Farman's No. III biplane. Rotary types had been built for automobiles by Stephen Balzer and Adams-Farwell in the U.S.A., and this type had been originally planned for the Langley "aerodrome," but it was first adapted to flying in the "Gnome." This engine (text fig. 5; pl. 9, fig. 1, and table 2) was a masterpiece for its time and deserves special attention here.

The design of the "Gnome" (pl. 9, fig. 1) was by Laurent Seguin. Made entirely from steel forgings machined all over, with integrally machined cooling fins and a modern master-rod system, it anticipated many features of the latest large air-cooled radials. The rotary feature was used in order to eliminate the flywheel, which had been previously thought essential, and also to assist in cooling. It frequently used a cowling quite like that later developed for static radials by the N.A.C.A. (see later remarks under "Cooling"). This and subsequent larger and more powerful versions became perhaps the most popular aircraft engines up to World War I and were used widely by both sides through most of that war.

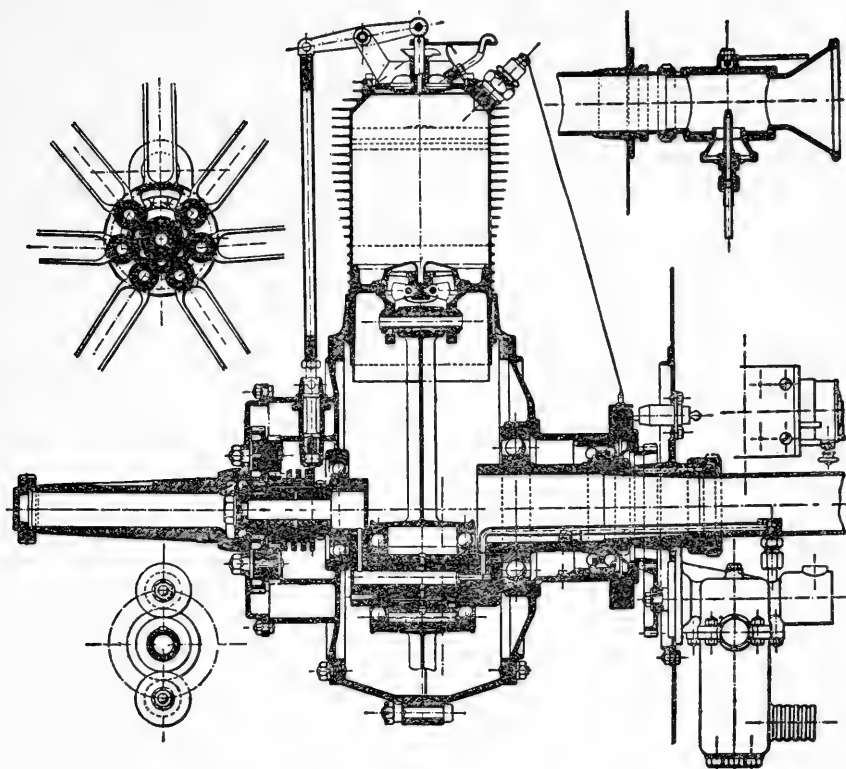

FIGURE 5.—“Gnome” engine, 1910, sectional drawing.

I had the pleasure of flying with a “Gnome” engine in 1920. It was exceptionally free of vibration and also relatively quiet. The only disagreeable feature was the castor-oil fumes discharged from the exhaust. Lubrication was achieved by pumping castor oil into the crankshaft at a fixed rate, and oil which was not burned eventually found its way out of the exhaust ports, after which much of it impinged and remained on the airplane (and on the pilot!). One of my first assignments in aviation (1917) was to make tests to show that mineral oil could be used in aero engines. Previous to that time castor oil had been considered as indispensable for aero engines as it was for young children.

Another interesting feature of the “Gnome” engine was its method of control. No carburetor was used, the fuel and air being introduced through the hollow crankshaft using separate valves controlled by the pilot. Because of the large inertia of the rotating engine, it was possible to adjust to the appropriate mixture by trial, without danger of stalling the engine. After starting the engine with a known setting of the valves for idling, the air throttle was opened wide, at which time firing ceased, but rotation continued. The fuel valve was then

opened until firing started and maximum propeller speed was attained. Since the reverse process was difficult, "throttling" was accomplished by temporarily cutting the ignition, keeping the engine going by short "bursts" of power. Oddly enough this technique was easy to learn and pilots seemed to like it.

Important engines of 1909 included the following (see also table 1, pages 294 and 295) :

Wright -----	4- and 6-cylinder vertical, water cooled.
Curtiss -----	8-cylinder Vee, water cooled.
Antoinette -----	8- and 16-cylinder Vee, water cooled.
E.N.V. -----	8-cylinder Vee, water cooled.
Darracq -----	2-cylinder opposed, water cooled.
Gnome -----	7-cylinder rotary, air cooled.
Renault -----	8-cylinder Vee, air cooled.
R.E.P. -----	7-cylinder fan, air cooled.
Anzani -----	3-cylinder fan, air cooled.

These engines accounted for nearly all important flights in 1909, including the winners of the first official aviation contests at Rheims.

The "Darracq" engine, used by Santos-Dumont, was important for being apparently the first aircraft engine to use mechanically operated inlet valves. All the others used automatic inlet valves, opened by suction. Since automobile engines had been using mechanically operated valves for many years before 1909, it is hard to understand why this important feature was so late in coming into use for aircraft engines.

ENGINES, 1910-1918

This period, including World War I, saw such rapid developments of aircraft engines that only the important ones can be described here. By "important" I mean those which pioneered successful new design features or which were particularly notable in service.

Early in this period the "Gnome" air-cooled rotary engine was dominant and was built in many countries and in several modified designs, including the "LeRhone" and "Clerget" (French) the BR-1 and BR-2 (British) and the "Oberürsel" and "Siemens" (German). It reached its height early in the war and was definitely obsolescent by 1918. Reasons for its demise were chiefly a limitation on speed due to centrifugal stress, the considerable windage losses, design limitations imposed by rotation of all parts but the crankshaft, and a rather strong gyroscopic effect on the airplane during turns. However, the rotary-type engine set a pattern for the later development of the modern air-cooled radial engine. It was a forged-and-machined-all-over engine, and it was radial and air-cooled, features which are now characteristic of most large military and commercial piston engines.

As the rotary engines became obsolete, the water-cooled Vee engine became the dominant type. In the U.S.A. the Curtiss "OX-5" engine (pl. 9, fig. 2, and table 1, page 294) led the field until 1917, when the "Liberty" and "Hispano-Suiza" engines (see later descriptions) were introduced here.

The "OX-5," a water-cooled V-8, had an aluminum crankcase, cast-iron cylinders with sheet monel-metal water jackets brazed onto the barrels, and overhead valves, push-rod operated. Used by both Army and Navy,⁶ it powered practically all U.S. and Canadian training airplanes and was probably responsible for training more pilots for World War I than any other engine. The best-known trainer, the Curtiss JN-4, affectionately known as the "Jenny," is shown in plate 8, figure 2. My first airplane ride (1917) was in a single-float seaplane with the "OXX-2," the Navy version of this engine.

The "OX-5" engine was considered very reliable for its day, but few pilots completed the (very short) training course without at least one forced landing. Its weaknesses included single ignition,⁶ a rather flimsy valve-operating gear including "pull-rods" for the inlet valves, and a tendency to leak water from the water pump down onto the low-slung carburetor. In freezing weather the latter defect accounted for many forced landings, as Dr. Stark Draper of M.I.T., who owned an "OX-5" equipped Curtiss *Robin* airplane, can testify.

A very important new style in liquid-cooled cylinder design appeared in 1915 on the German 6-cylinder 180 hp. "Mercedes" engine (fig. 6, table 1). This was the built-up welded-steel construction, widely used for a long time thereafter in most water-cooled engines. It was copied by such famous makes as Rolls-Royce "Eagle" (pl. 10, fig. 1), the "Liberty," F.I.A.T., Renault, Salmson, B.M.W., etc., but finally gave way to the cast-aluminum en-bloc construction, to be discussed later.

An important engine built in this style was the U.S. "Liberty" engine (pl. 10, fig. 2, and text fig. 7), which was developed under extraordinary circumstances. After a decision on May 29, 1917 (only 7 weeks after the U.S. entered the war), by the War Production Board to build an airplane engine more powerful than any in use up to that time, J. G. Vincent, Chief Engineer of Packard, and E. J. Hall, of the Hall-Scott Motor Co., started to design such an engine in the Willard Hotel, Washington, D.C. On May 31 preliminary layouts were approved by the W.P.B. and some extra help was called in. Complete layouts were approved June 4, detailed design was substantially completed on June 11, the first 8-cylinder engine was delivered to the Bureau of Standards for test July 3, and the first 12-cylinder engine completed the official 50-hour test August 25, 1917. The first "production" engine was delivered to the Army Air Service in Dayton on

⁶ The Navy version was a slight modification having dual ignition and a 100-hp. rating.

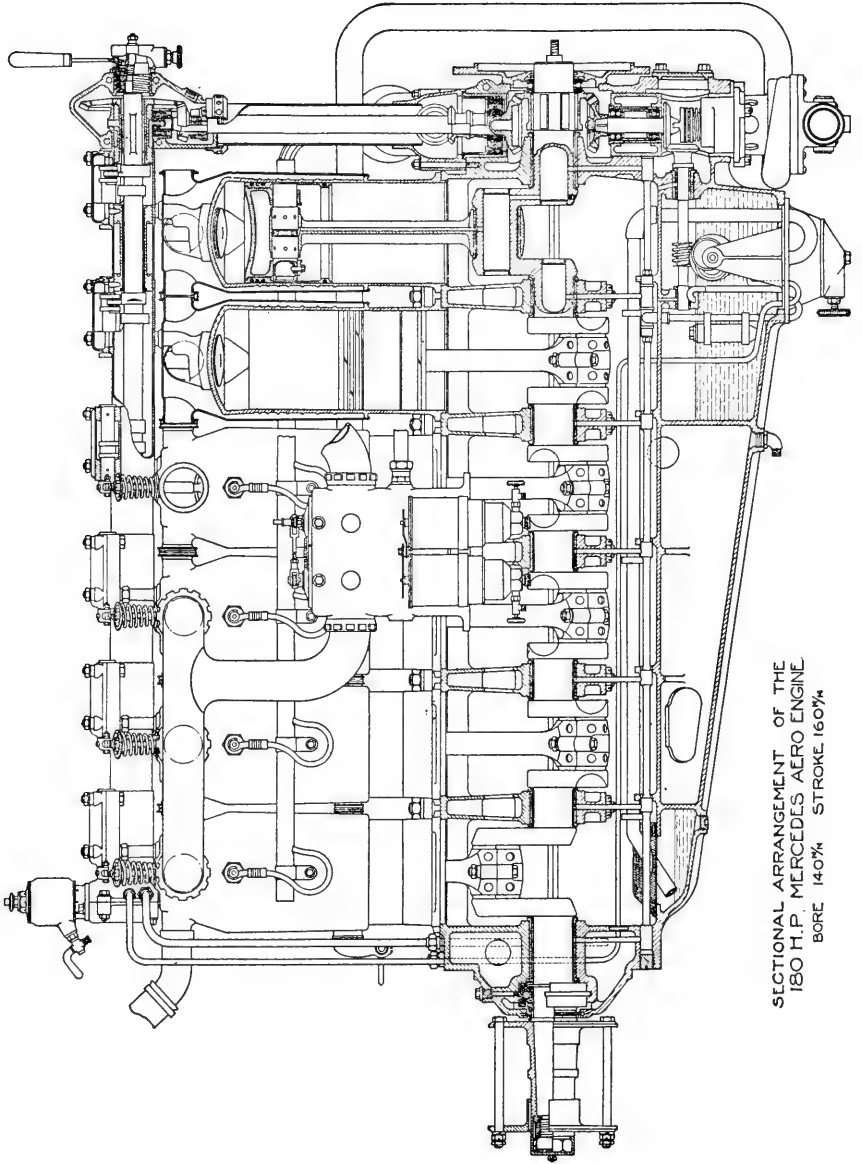

SECTIONAL ARRANGEMENT OF THE
180 H.P. MERCEDES AERO ENGINE
BORE 140 $\frac{1}{4}$ STROKE 160 $\frac{1}{4}$

FIGURE 6.—“Mercedes” 6-cylinder in-line engine, 180 hp., Germany, World War I.

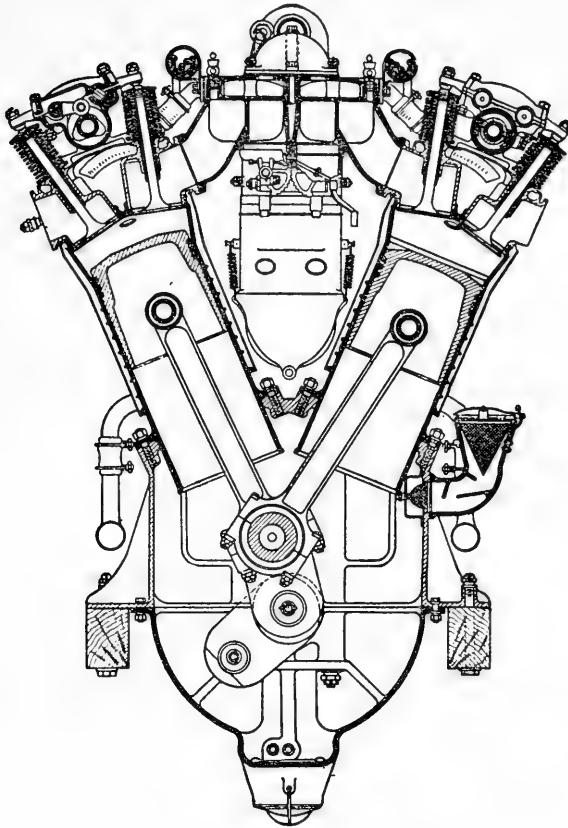

FIGURE 7.—“Liberty” engine, sectional transverse view.

Thanksgiving Day, 1917, just 6 months after Vincent and Hall had started their layout. I believe this record has never been equaled, before or since, except perhaps by the first Pratt and Whitney “Wasp,” described later.⁷

The design was based on the welded-cylinder construction pioneered by “Mercedes.” It had no radical features, but was an excellent synthesis of the state of the art of its time. Its principal weaknesses were cracking of the cylinder-head water jackets, burning of exhaust valves, and breaking of accessory gears. These faults were gradually reduced as time went on, and it was considered a reliable engine. Early production engines had a 50 percent chance of passing the government 50-hour endurance test. With later modifications, a bar welded between the ports to reduce cylinder distortion and jacket cracking, and heavier teeth for the gears, the only weakness remaining was in the exhaust valves, which served well most of the time.

⁷ Although the “Wasp” did not go into real quantity production nearly as quickly as did the “Liberty.”

Large quantities of the "Liberty-12" engine were produced by the automobile companies, including Packard, Ford, Lincoln, and some General Motors divisions. It was used by the British as well as by the U.S. Air Service and Navy. Engine production was far ahead of airplane production in this country, and at the end of the war many thousands of these engines were on hand. Many were sold at low prices to "rum runners" and were very successfully used in running liquor through the Coast Guard blockade along the Atlantic and Pacific coasts during the prohibition period. During these years the Coast Guard had no "requirement" for a light and powerful marine engine, and their motor boats were far outclassed by the "Liberty"-equipped bootleggers' craft.

The "Liberty" engine remained important in U.S. Army and Navy aviation well into the 1930's. This engine was used in the NC boats with a special economical carburetor setting developed at the Washington Navy Yard. NC-4 was, of course, the first aircraft to cross the Atlantic, May 16-17, 1919.⁸ The "Liberty" was also the first engine to fly nonstop across the American Continent (in the Fokker "T-2," May 2-3, 1923, piloted by Kelly and McCready). Also, in a turbo-supercharged version, it held the world's altitude records in 1920, 1921, and 1922, and powered the first flight around the world in 1924.

From a technical viewpoint, the outstanding airplane engine during World War I was undoubtedly the "Hispano-Suiza" V-8 (pl. 11, fig. 1, text fig. 8, and table 1), built first in Barcelona by a Swiss engineer, Marc Birkigt. It was adopted for French fighters in 1915 and used in the "Spad" 7 and 13, perhaps the best fighters of World War I.

The basic contribution of Birkigt to engine design was the en-bloc cylinder construction with a cast-aluminum water jacket containing steel cylinder barrels and with enclosed and lubricated valves and valve gear.⁹ The success of this engine started a revolution in liquid-cooled engine design which culminated in the Rolls-Royce "Kestrel" and "Merlin," via the Curtiss K-12, C-12, and D-12 engines. It was also the prototype for the "Mercedes" and "Junkers" engines which were the backbone of the 1940-45 German Luftwaffe, together with en-bloc Russian, Japanese, and Italian designs. By 1917 "Hispano-Suiza" engines were being built in England and the U.S.A., as well as in France.

The only weakness in the early "Hispano-Suiza" engines, by standards of the time, was a tendency toward exhaust-valve burning. This

⁸ The first *nonstop* Atlantic crossing was by Alcock and Brown, about a month later, June 14-15, 1919, using two Rolls-Royce "Eagle" engines, also with welded-cylinder construction (see pl. 10, fig. 1).

⁹ It will be recalled that the Wright brothers also used crude aluminum en-bloc water-jacket construction on their No. 1 engine. Subsequent engines, however, had separate cylinders.

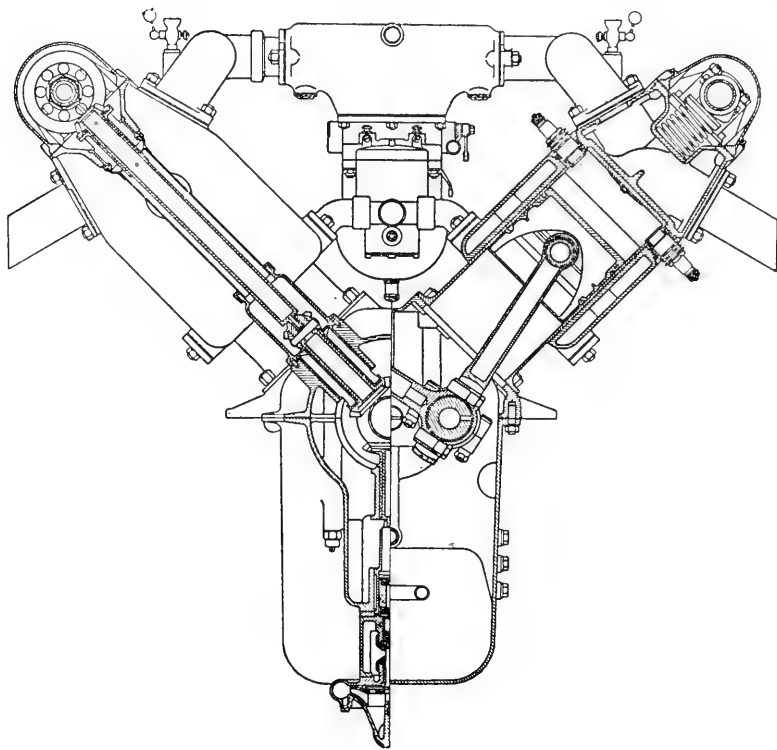

FIGURE 8.—“Hispano-Suiza” engine, sectional transverse view.

was due to the fact that the steel cylinder heads were “dry,” that is, they did not come directly into contact with the cooling water (see fig. 10, *β*). The flat steel head had a tendency to warp and lose contact with the aluminum jacket, which reduced valve cooling and also distorted the valve seats, causing exhaust valves to leak and burn under conditions of severe operation.

The development of this engine was continued in the U.S.A. after World War I by the Wright-Martin Co., which later became the Wright Aeronautical Corporation. One of the most important changes made was to eliminate the steel cylinder head and to seat the valves in bronze inserts pressed into the aluminum heads. This basic improvement set a pattern for the most successful subsequent liquid-cooled engines.

In contrast to the all-forged construction of the “Gnome” and the modern large radial engines, the “Hispano-Suiza” engine and its descendants were essentially cast-aluminum engines except for the moving parts and the cylinder barrels.

ENGINES, 1917-1940

In this period hundreds of new engine types appeared. From the technical point of view, the period is marked by the following significant developments:

1. Further development of the liquid-cooled engine of the all-cast type, chiefly for military purposes.
2. The development of the air-cooled radial engine to a place of dominance in all but fighter-type military and small civilian aircraft.
3. The advent of 4-cylinder vertical in-line, and later, opposed-cylinder, horizontal, air-cooled engines for light aircraft.
4. First trials of rocket and jet engines.

LIQUID-COOLED ENGINES AFTER 1918

By 1920 the success of the "Hispano-Suiza" engines by that time built in both the original size and a larger size (300 hp.), had convinced most designers that the welded-cylinder construction was obsolescent.

The Curtiss Company, in the U.S.A., took up the cast-aluminum engine, generally based on the "Hispano-Suiza," with successive 12-cylinder designs known as the K-12,¹⁰ C-12, D-12 (pl. 12, fig. 1), and V-1400 models. These were all of the 12-cylinder Vee type, with four valves per cylinder, instead of two as in the "Hispano-Suiza." The two early models had steel cylinder heads like that of the original "Hispano-Suiza," but cooling was greatly assisted by an integral stud, in the center between the valves, by means of which the head was held tightly against the water-jacket casting (fig. 10, 4). In the D-12 the steel head was abandoned, and the valve seats were bedded directly in the aluminum head, as in the Wright version of the "Hispano-Suiza."

The great success of the Curtiss engines in racing (first to exceed 200 m.p.h. in the Mitchell¹¹ Trophy race, Detroit, 1922, and winner of the Schneider trophy in 1923 and 1925) led the Rolls-Royce company to develop aluminum V-12 engines of similar type. The first was the "Kestrel" of 1927 soon followed by the racing or "R" type which attained theretofore unheard of output in proportion to its size and weight and won the Schneider trophy in 1929 and 1931. The "Kestrel" was followed by the Rolls-Royce "Merlin" (pl. 12, fig. 2), winner of the Battle of Britain, and also by the Allison V-1710 (a fairly faithful copy of the "Merlin"), and the German "Daimler-Benz" (fig. 9) and "Junkers" V-12 liquid-cooled engines, all descendants of the "Hispano-Suiza" and Curtiss. In all these engines the valves were seated in inserts embedded in the aluminum head, and thus had better valve cooling than the original "Hispano-Suiza"

¹⁰ The K was for Chas. B. Kirkham, who conceived the basic design for this series and was also consulted in the design of the earlier Liberty engine, q.v.

¹¹ Named for brother of Gen. William ("Billy") Mitchell.

THE INVERTED V TWELVE CYLINDER D.B.601N

Germany's Leading In-line Engine

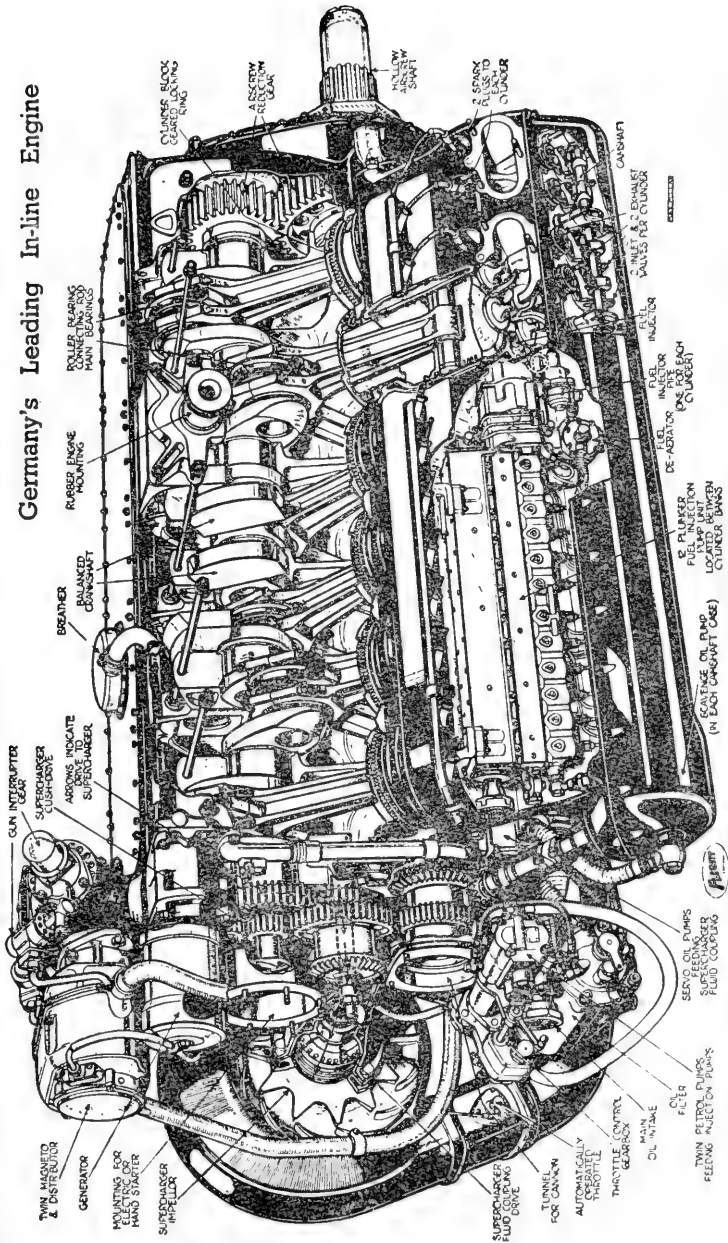

Part-sectional drawing of the liquid-cooled D.B.601N of 33.9 litres, bore and stroke 150 x 160 mm. Features of the engine are the twelve plunger in-line direct injection pump, and the fluid coupling which provides an infinitely variable gear for the supercharger drive. B.H.P. at 2,600 r.p.m. is 1,270, which for a weight of 1,540 lb. = 1.20 lb. h.p.

FIGURE 9.—“Daimler-Benz,” D.B. 601-N, 12-cylinder, Germany’s leading in-line engine, World War II (courtesy “Flight” magazine).

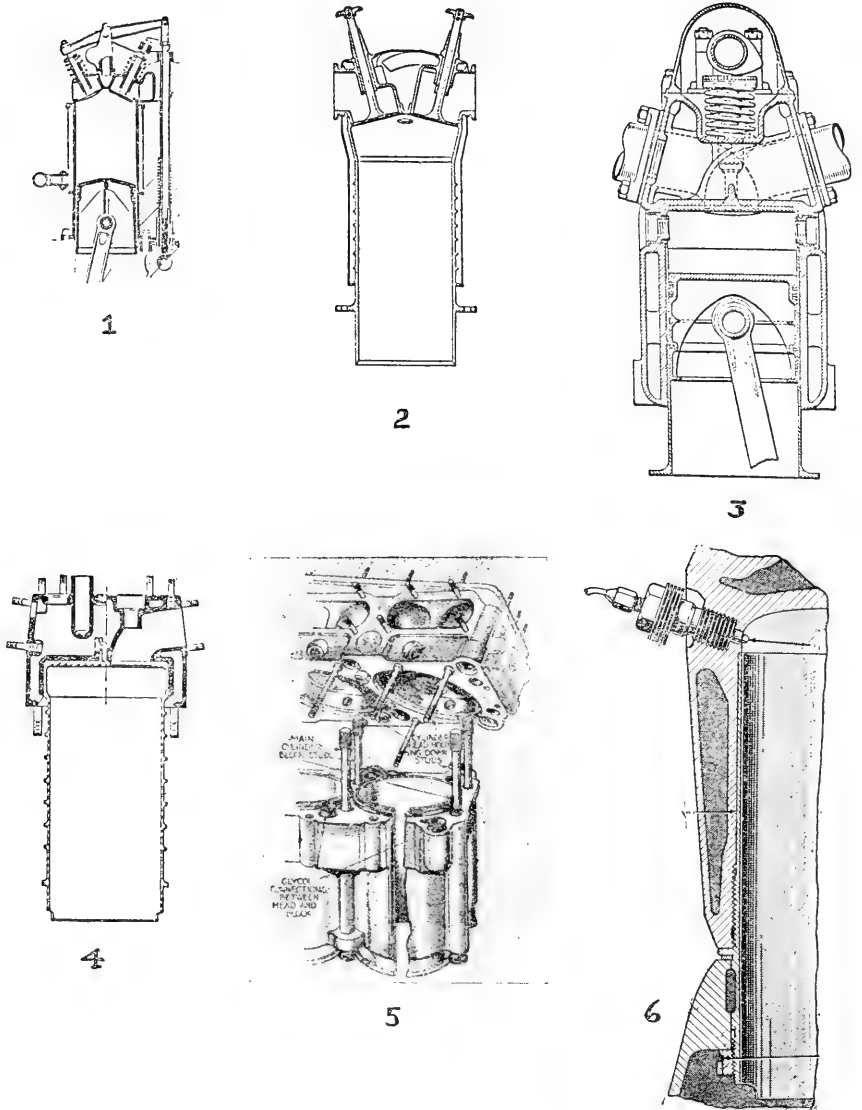

FIGURE 10.—Liquid-cooled cylinder development.

No.	Year	Name	Barrel	Jacket	Load by
1.....	1914	Curtiss OX-5.....	C.I.....	Monel sheet.....	Barrel.
2.....	1917	Liberty.....	Steel.....	Steel, welded.....	Do.
3.....	1915	Hispano-Suiza.....	do.....	Cast aluminum.....	Do.
4.....	1921	Curtiss K-12.....	do.....	do.....	Jacket.*
5.....	1934	Rolls "Merlin".....	do.....	do.....	Studs.
6.....	1935	Daimler-Benz.....	do.....	do.....	Barrel.

*Cast aluminum water jacket, not shown, was flanged and bolted to head and to crankcase.

design. In every case the basic structure consisted of cast aluminum crankcase with en-bloc water jackets and cylinder heads, also of cast aluminum. Cylinder barrels were uniformly of steel. Design details varied, especially in the method of taking the cylinder-head-to-crankcase load. This was successfully done as follows:

1. Through the cylinder barrels, Hispano-Suiza, Daimler-Benz, fig. 10, 3, 6.
2. Through the aluminum water-jacket structure, Curtiss and Junkers, fig. 10, 4.
3. By long bolts from cylinder heads to crankcase, Rolls-Royce and Allison, fig. 10, 5.

Figure 10 illustrates the evolution of liquid-cooled cylinder construction.

The improvement in performance of liquid-cooled engines since 1918 has been astonishing. The following figures illustrate this development:

Engine.....	1918	1948
	Liberty	Packard "Merlin"
Maximum hp.....	420	2,250
R.p.m.....	1,700	3,000
Brake mean effective pressure, psi.....	118	360
Mean piston speed, ft./min.....	1,985	3,000
Hp. per square inch piston area.....	1.78	8.2
Weight per hp., "dry" pounds.....	2.04	0.78

("Dry" weight is for complete engine without water, oil, or radiators.)

These improvements are attributable not only to improved detail design, but also to important developments in fuel, supercharging, and cooling fluid, which will be discussed in a later section of this lecture.

AIR-COOLED ENGINES, 1918-40

The "Gnome" and its rotary descendants (LeRhone, Clerget, B.R., Oberürsel, etc.) were obsolescent by 1918. Also obsolescent were air-cooled engines using cast-iron cylinders with integral heads and fins. These included the radial "Anzani," and the "Renault" Vee type with its descendants, the R.A.F. and F.I.A.T.

During the first World War it had become evident that the simple cast-iron cylinder¹² had reached its limit, and the Royal Aircraft Factory of Great Britain had employed Prof. A. H. Gibson, assisted by S. D. Heron, to develop more effective air-cooled cylinders. By 1918 they had constructed and tested steel cylinders with cast-aluminum heads, capable of higher specific outputs than any cast-iron cylinder (fig. 11). However, the practical use of the aluminum-head cylinder in England was seriously delayed by a parallel development starting in 1917 of air-cooled radials with steel, flat-head cylinders, capped by a bolted-on valve-port assembly of cast-iron or cast alumi-

¹² The chief limitations on the cast-iron cylinder are poor heat conductivity as compared with aluminum, and low strength as compared with steel.

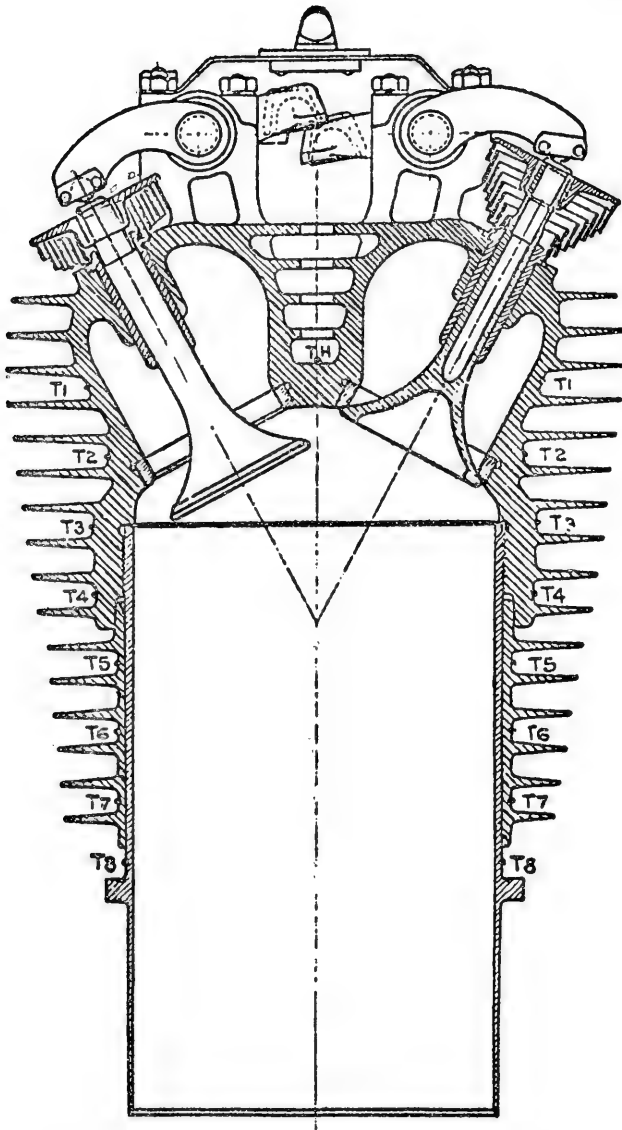

FIGURE 11.—Air-cooled cylinder developed by Dr. A. H. Gibson at the Royal Aircraft Establishment, 1918. This cylinder anticipates the essential features of all modern air-cooled aircraft-engine cylinders, including aluminum head screwed over steel barrel, applied finning on barrel. From (British) Advisory Committee for Aeronautics report I.C.E. 260. Jan. 1919.

num (fig. 12, *left*). This cylinder design suffered from the same trouble as the early "Hispano-Suiza" engines, namely, poor exhaust-valve cooling because of poor contact between the head and the separate cooling element. However, the first radial engine using this cylinder type, the A.B.C. "Wasp" of 4½" bore, was successful enough to gain the support of the British government for its development in a larger version, the "Dragonfly" of 5½" bore. Evidently the fact that cooling problems increase with increased cylinder size was not realized at the time.

This development finally became, through several changes in ownership, the Bristol "Jupiter" engine (pl. 13, fig. 1), which was built and used in considerable quantities in England and in Europe, chiefly for military purposes. It was never a really satisfactory aircraft engine, because of poor exhaust-valve cooling (S.D. Heron said that its consumption should be given in terms of pounds of exhaust-valves, rather than in pounds of fuel, per horsepower-hour!). Finally realizing this fact, Bristol changed from steel heads to aluminum heads with the Jupiter "F," about 1930.

Meanwhile the Gibson-Heron type cylinders had been further developed by Armstrong Siddeley, and were used on the "Jaguar" two-row radial (pl. 13, fig. 2) which passed its type test in 1922, 10 years after Gibson started his work.

A parallel development of air-cooled engines with aluminum cylinders was begun about 1916 by C. L. Lawrance. Starting in 1916 with a 2-cylinder opposed engine, he built a 3-cylinder engine in 1919, and finally a 9-cylinder 200-hp. radial in 1921, the J-1 (pl. 14, fig. 1), supported by an order for 200 engines from the U.S. Navy. In 1922 this company was absorbed by the Wright Aeronautical Corporation¹³ and, with Navy support, the 9-cylinder engine was built in improved models known as the Wright J-3, J-4, and J-4b, all with essentially the Lawrance cylinder design. During the same period, 1918-1926, S. D. Heron had left England and had been employed by the U.S. Army Air Service at McCook Field, Dayton, Ohio, to assist in the development of large radial engines.¹⁴ Heron was a devoted worker and an able engineer, and by 1921 had developed successful air-cooled cylinders of nearly 6 inches bore, based on his work with Gibson plus his own improvements worked out at McCook Field.

Against considerable resistance from their chief engineers, who at the time were thoroughly committed to watercooling, the Army contracted for sample radial engines from both Curtiss and Wright Aeronautical. Such engines were built, but in very small numbers.

The Lawrance and Heron developments were brought together when Heron joined Wright Aeronautical Corporation in 1926, the

¹³ See previous remarks regarding the Hispano-Suiza engine.

¹⁴ The author was in charge of the engine laboratory at McCook Field, and was closely associated with Heron and his work during this period.

first result being the Wright J-5, essentially a Lawrance-type engine with Heron-type cylinders (pl. 14, fig. 2). This was a successful engine of 200-hp. class as evidenced by its use in Lindbergh's New York-Paris flight, May 20-21, 1927, and in a number of early transport airplanes.

Although Wright Aeronautical had been experimenting with air-cooled radial engines having cylinders larger than those of the J-5, whose bore was 4.5 inches, the first really successful engine in this class was the Pratt and Whitney 425-hp. "Wasp" of 1927.

The merger with Lawrance having involved a management change, in the summer of 1925 a considerable fraction of the Wright Aeronautical staff, including the chief engineer, George J. Mead, resigned from Wright to form Pratt and Whitney Aircraft, of Hartford, Conn. In a time almost as short as that for the Liberty engine, this new group produced the "Wasp" shown in plate 15, figure 1, the first large radial air-cooled engine of what may be called "modern" design. The notable features of this engine included:

Rating, 425 hp. at 1,800 r.p.m.

9 cylinders, 5.75 x 5.75 inches.

Built-in geared centrifugal supercharger.

Fully enclosed valve gear with rocker boxes integral with cylinder head (pl. 15, fig. 1).

Forged and machined crankcase (pl. 15, fig. 2).

Domed-head, 2-valve cylinders, basically of the Heron design.

Divided crankpin with one-piece master rod (pl. 15, fig. 3).

While most of these features had appeared previously, their combination here was an eminently rational and successful one, and set a high standard for future radial-engine development.

The only important basic improvements to be developed later for radial air-cooled engines were:

1. The forged and machined aluminum cylinder head, pioneered by Bristol in England and Wright Aeronautical in the U.S.A. (Gnome had pioneered the forged and machined *steel* head for air-cooled engines).

2. The automatically lubricated (by engine oil) valve gear, pioneered by Pratt and Whitney in 1932 (first used in water-cooled aero engines by Hispano-Suiza, ca. 1914).

3. The vibration-absorbing counterweight, introduced by Wright Aeronautical in 1935, which will be discussed later.

4. Second-order balancing weights, to reduce vibration.

The basic features of the "Wasp," with the addition of the above improvements, are used in all modern large air-cooled radial engines. This type, of course, has dominated transport and much of military aviation until the recent advent of the jet and turbine engine. Plate

16 and plate 17, figure 2, show the outstanding modern air-cooled radial engines which are basically descendants of the Gnome, but with greatly improved detail design, including the composite steel and aluminum cylinder construction pioneered by Gibson, Heron, and Lawrance. Figure 12 shows the evolution of Wright cylinders from 1920 to about 1930, and plate 17, figure 1, shows the cylinder used on the Wright turbo-compound engine, the most highly developed air-cooled radial.

The following comparison illustrates the development of air-cooled engines from 1922 to the present time.

Engine.....	1922	1955
	Lawrance J-1	Wright Turbo- Compound
Maximum horsepower.....	200	3, 700
R. p. m.....	1, 800	2, 900
Brake mean effective pressure, psi.....	112	302
Mean piston speed ft./min.....	1, 650	3, 070
Horsepower per sq. in. piston area.....	1. 4	7. 0
Weight per hp. "dry".....	2. 38	0. 96

As in the case of liquid-cooled engines, developments in fuels, supercharging, and cooling systems were important factors in this development, as well as great improvements in detail design.

The subject of the air-cooled engine should not be left without mention of the remarkable development of the light-airplane engine beginning with the small British 4-cylinder vertical air-cooled "Cirrus" (1927) followed 5 years later by the 4-cylinder Continental A-40 which set the modern style of horizontal-opposed light-airplane engines. These have developed to a remarkable degree of reliability and (unsupercharged) performance. Recently, a license to build Continental engines of this type was acquired by Rolls-Royce, a real compliment to the high quality of these small powerplants. Plate 18, figure 1, shows the Continental A-65 4-cylinder engine brought out in 1938. This engine used composite steel and cast-aluminum cylinders, which are now standard for engines of this category.

Another category of air-cooled engines comprises those built for installation in model airplanes. These are usually single-cylinder engines of less than 1 inch bore and stroke (pl. 18, fig. 2). Some are rated up to 1 hp. at speeds of 15,000 r.p.m. or more. Originating in the U.S. about 1930, these engines were produced in very large quantities between 1945 and 1950. It is claimed that there were 180 manufacturers of model engines in the U.S. during this period. Their total production, in number of engines, probably exceeded that of all other aircraft engines combined. The popularity of engine-powered model airplanes fell off about 1950, and fewer are now manufactured.

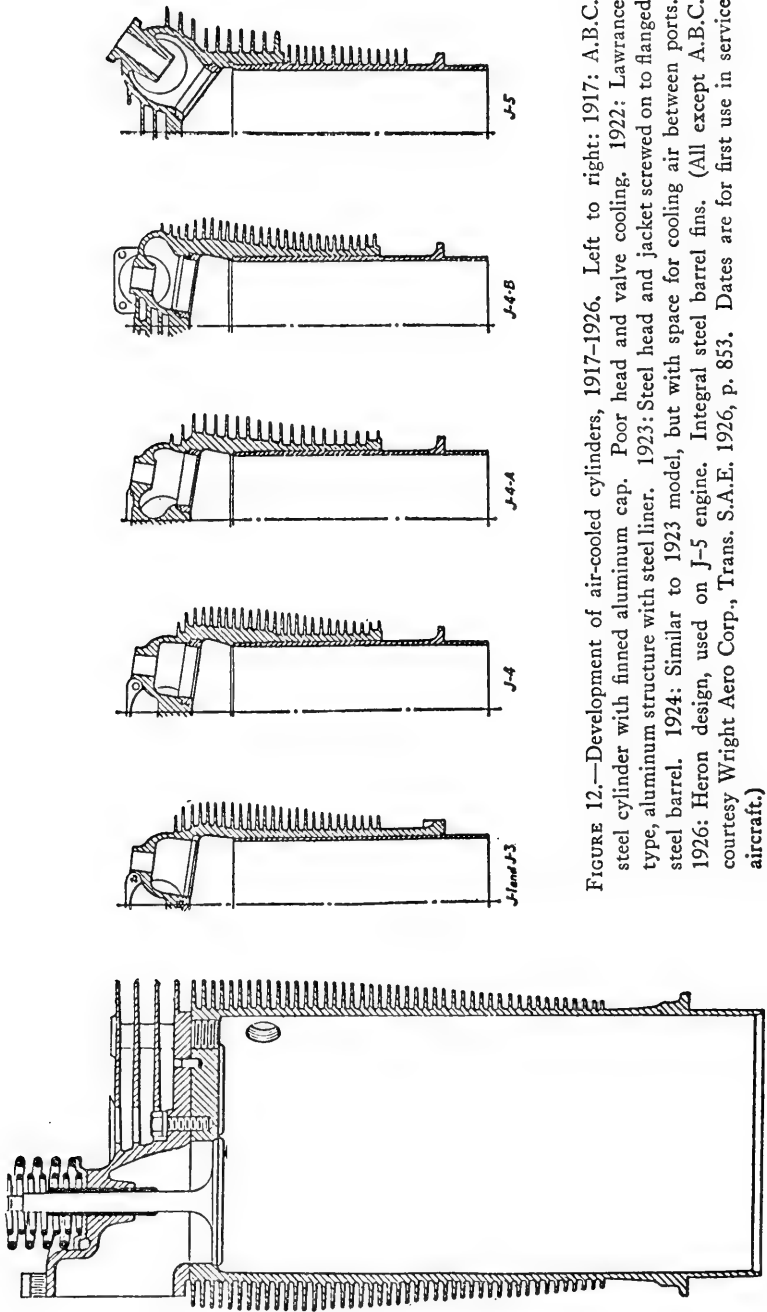

FIGURE 12.—Development of air-cooled cylinders, 1917-1926. Left to right: 1917: A.B.C. steel cylinder with finned aluminum cap. Poor head and valve cooling. 1922: Lawrance type, aluminum structure with steel liner. 1923: Steel head and jacket screwed on to flanged steel barrel. 1924: Similar to 1923 model, but with space for cooling air between ports. 1926: Heron design, used on J-5 engine. Integral steel barrel fins. (All except A.B.C. courtesy Wright Aero Corp., Trans. S.A.E. 1926, p. 853. Dates are for first use in service aircraft.)

AIR VS. LIQUID COOLING

The classic and often emotionally charged argument over the relative merits of liquid and air cooling started with the early days of flying ("Antoinette" vs. "Gnome," for example) and persisted to the end of World War II, when the advent of jets and turbo-props diverted attention elsewhere.

As we have seen, water cooling was dominant through World War I, except for the rotaries, which were obsolescent at its end. European military aviation remained generally committed to water cooling up to and through World War II, although some air-cooled engines were used in bombers and transports, and there was one excellent air-cooled European fighter, the Focke-Wulf with the B.M.W. two-row radial, developed from a Pratt and Whitney license. Japanese fighter aircraft also used air-cooled radials copied from Wright and Pratt and Whitney designs. Their other military aircraft used these and copies of the German Daimler-Benz liquid-cooled engine.

In the United States, the Navy made a commitment to air cooling in 1921 which has held for reciprocating engines to this day. It was chiefly Navy support that underwrote early Pratt and Whitney and Wright air-cooled developments. The reason for this choice lay in the limitations of the airplane carrier, which required short takeoff, compact size, and minimum maintenance. Commander Bruce Leighton was probably the one most responsible for this well-considered decision.

The most intense controversy on this subject took place in the U.S. Army Air Service, whose support for air-cooled engine development in the 1920's and 1930's was never as enthusiastic as that of the Navy, because of the assumed "larger frontal area" and greater "drag" of air-cooled radials, especially for use in fighter airplanes. That cooling drag was a real problem in the early days is illustrated by plate 19, figure 1, and plate 20, figure 1, showing typical installations of the 1920's.

The "drag" of air-cooled engines was greatly reduced by the advent of the very effective cowling and cylinder baffling developed by the (U.S.) N.A.C.A. starting in 1929 (pl. 20, fig. 2, and text fig. 13). Further reductions in cooling drag were achieved by increased cooling-fin area, which reduced the air velocity required for cooling (compare fig. 12 with pl. 17, fig. 1). These developments put the air-cooled radial virtually on a par with the water-cooled engines with regard to cooling drag, until the advent of high-temperature liquid cooling with glycol-water mixtures. Plate 19, figure 2, shows modern cowling for the air-cooled radial engine.

The use of high-boiling-point liquids (mixtures of water and ethylene glycol) for engines formerly water-cooled was introduced in 1932

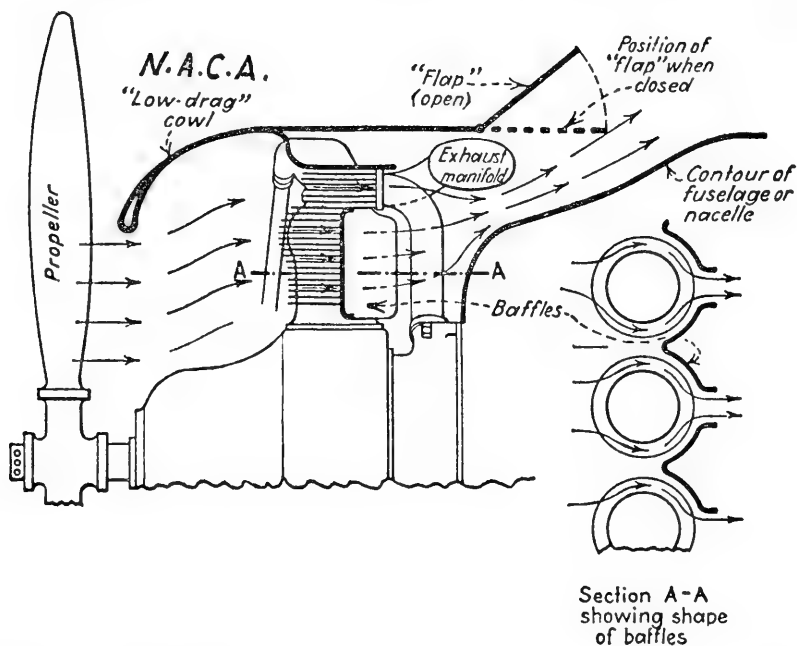

FIGURE 13.—Cooling-air flow in tractor installation of a cowled radial engine. Only the upper half of the installation is shown.

by Curtiss (pl. 21, fig. 1) and used soon afterward by Allison and Rolls-Royce. This change, which allowed operation of the coolant at 250° F., reduced the radiator area required by about 50 percent. This improvement, together with better radiator design and radiator cowl-ing (pl. 21, fig. 2), brought the drag of liquid-cooled engines well below that of air-cooled radials of equal power. Their installed weight, which had been greater than that of air-cooled radials, also came down to more comparable figures. Schlaifer gives the weight per horsepower of the best liquid-cooled fighter installation as 30 percent more at sea level and about the same at 25,000 ft.¹⁵ as a comparable air-cooled installation.

The fact that the "Battle of Britain" was won by liquid-cooled engines (the Rolls-Royce "Merlin") gave a great impetus to the Army prejudice in favor of water-cooled fighters.¹⁶ Actually, both types were used, and it was found that the air-cooled fighter was better at low altitude both because of its lighter specific weight and its lesser vulnerability to small-arms fire.

¹⁵ Owing to the fact that radiator area can be designed large enough for any altitude, while fin area on an air-cooled cylinder has a practical limit, and power of air-cooled engines therefore is limited by cooling, above a certain altitude.

¹⁶ One high officer answered the author's question, "Does the Army want liquid-cooled fighters even if better fighters can be built around air-cooled engines?" in the affirmative!

The elimination of the weight, complication, and maintenance of liquid-cooling systems has been the chief consideration in the use of air cooling for air-transport purposes since about 1932. With few exceptions, commercial air transports all over the world have used air-cooled engines, mostly of American manufacture, from the early beginnings in the late 1920's up to the present day. There are still (1962) many more nonmilitary airplanes powered by air-cooled piston engines than all other types combined, including jets and gas-turbines. Privately owned aircraft, with few exceptions, use air-cooled piston engines.

EXHAUST VALVES

As previously mentioned, the poppet exhaust valve has always been a critical item because it is subjected to such high gas temperature (up to 3000° F.) and high gas velocity, with small areas available (stem and seat only) for heat dissipation to the coolant. One method of attack on this problem has been through the use of improved materials. By 1918 the ordinary steels used at first had given way to "high-speed" tool steel which has a high degree of strength at elevated temperatures. Tungsten is the chief alloying element in such steel. Unfortunately, this type of steel burns readily at the seat of a leaking valve. Since about 1920 austenitic (high chromium) steels have been successfully used in various forms, with several other alloying elements, including principally silicon, nickel, and cobalt. A further important improvement, about 1934, was the use of "Stellite" facing on both valves and seats. This development occurred jointly in the U.S. and abroad (chiefly in Britain), with the manufacturers of poppet valves playing an important part.

Another, and very important, contribution to exhaust-valve life and reliability has been the use of a liquid partially filling a hollow valve, for the purpose of improving the conductivity of heat from head to stem. Heron and Gibson tried water in 1913, but the high steam pressure exploded the valve stem. Mercury was next tried, with more success, since its vapor pressure is lower. But mercury will not wet steel. A method of coating the internal valve surface with wettable material was developed by Midgeley and Kettering in 1917, and the Lawrence J-1 9-cylinder radial of 1921 (pl. 14, fig. 1), used mercury-filled valves with some success, although with trouble from mercury leakage.

When S. D. Heron came to McCook Field in 1919, he continued his work on valve coolants and soon used successfully the mixture of sodium and potassium nitrate previously used for heat treating of steel. This material has the necessary low vapor pressure, but its density is low. Continuing his work, by 1928 Heron had developed liquid sodium as the internal coolant, which is now universally used in aircraft exhaust valves and in many nonaircraft engines.

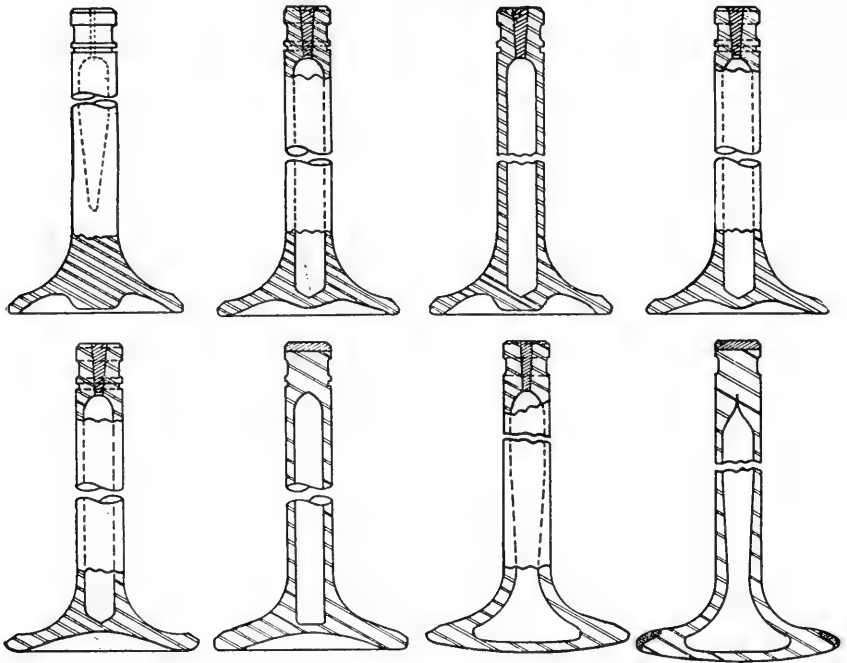

FIGURE 14.—Evolution of Wright Cyclone engine valves. From *Journal of S.A.E.*, Colwell, 1940.

Figure 14 shows a sequence of development in exhaust-valve design. Much ingenuity has been displayed by valve manufacturers in fabricating the modern hollow-head-with-hollow-stem valve, and filling it (partially) with metallic sodium.

The automatic lubrication of valves by engine oil, introduced to liquid-cooled engines by Hispano-Suiza (1914) and to air-cooled engines by Pratt and Whitney (1932) has also been an important contribution to the present long life and reliability of aircraft-engine valves.

Another method of attack on the valve-cooling problem was to eliminate the poppet valve in favor of some form of sliding valve. This method has not met with success, with one exception. The Bristol Aeroplane Co. developed its single-sleeve-valve air-cooled radial in the 1930's to the point where it was used to a limited extent in World War II.

FUELS AND DETONATION

One of the most important developments in aircraft propulsion has been the improvement in, and control of, aviation gasoline. This development is a long and complex story, and only a bare outline can be given here.

For successful use in spark-ignition engines, gasoline must have the proper volatility range, and the highest possible resistance to "knock," or "detonation." Control of volatility seems never to have been a serious problem, and development work in aircraft fuels has centered around increasing their antiknock value.

Earliest work on the relation of detonation to fuel composition seems to have been by Ricardo in England and by Kettering in the U.S.A. Intensive work was started by Midgeley and Boyd, under Kettering's direction, in Dayton, Ohio, in 1917. In the course of this work it was discovered that some substances, notably iodine, had a strong antiknock effect even in very small concentrations. This discovery led to an intensive search for powerful antiknock agents.

Midgeley's work was done on a tiny single-cylinder engine in an old Dayton kitchen, and when a promising substance was found there, he would bring it to the McCook Field engine laboratory for test in an aircraft engine. I was closely associated with his work during my administration of that laboratory, 1919-1923. By 1920 toluene and its related compounds appeared promising as an additive and were used in flight tests, notably by Schroeder for the 1920 altitude record with a turbo-supercharged Liberty engine. By 1921 the extreme antiknock effects of metallo-organic compounds was evident, and in 1922 Midgeley brought the first samples of tetraethyl lead, $\text{Pb}(\text{C}_2\text{H}_5)_4$, to McCook field for tests in a full-scale aircraft engine. This important substance was accepted for use in aviation gasoline by the U.S. Navy in 1926 and by the Army in 1933, and it is now universally accepted as an additive for gasoline.

Another important contribution was Edgar's work, about 1926, in determining the effect of fuel structure on antiknock quality and, specifically, discovering the high antiknock properties of the branched-chain parafins such as iso-octane.

Specifications and laboratory tests for antiknock quality of aviation fuels were sponsored by the Cooperative Fuel Research Committee in 1933, and led to good control of this quality in U.S. aviation fuels soon after. S. D. Heron was also an important contributor to this result. The "performance number" of a fuel, used from about 1935, is the ratio of knock-limited indicated mean effective pressure (klimep) with that fuel, to the klimep in the same engine using iso-octane. Figure 15 shows the improvement of klimep vs. time, achieved both by tetraethyl lead and the control of fuel composition.

The powerful effect of water or water-alcohol injection is also illustrated in figure 15. This development was promoted chiefly by the N.A.C.A. during the last war, and by 1946 water-alcohol injection was generally used for takeoff by both military and transport airplanes. The high consumption of the auxiliary fluid (about 50 percent of the fuel flow) limits its use to the takeoff period and to engines with suffi-

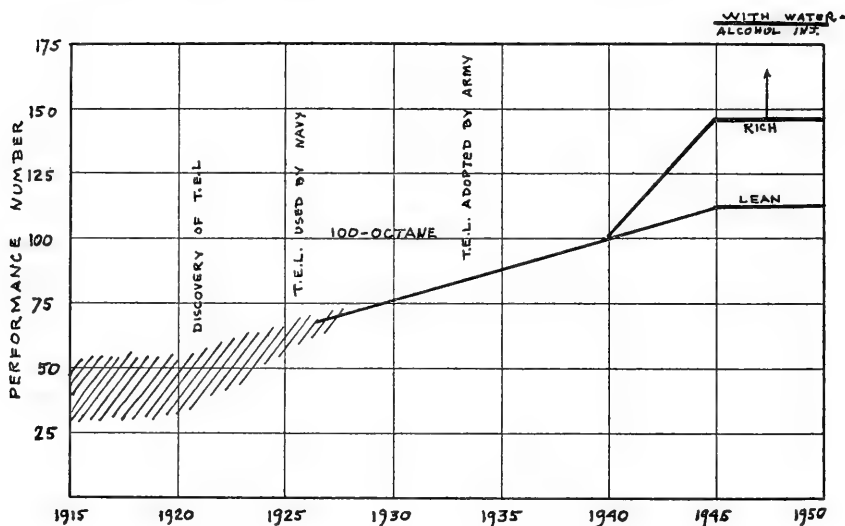

FIGURE 15.—Aviation fuel performance chart.

cient supercharging at sea level to take advantage of the increased knock limit.

VIBRATION CONTROL

Powerplant vibration presents two kinds of problems in aircraft. One is "external" vibration, or vibration of the powerplant with relation to the airplane itself. The other is "internal" vibration, that is, vibration of parts within the powerplant. Considerable external vibration from engine and propeller was accepted as normal in the early days of aviation. In my experience it became of concern first in 1920, with the Hispano-Suiza V-8 300-hp. engine, a larger version of the original model. This engine, like all V-8's up to that time, had cranks at 180 degrees, which gave a strong second-order horizontal vibration. It also had an unusually large torque variation, due to its large cylinders and high mean effective pressure. Pilots complained of discomfort with this engine.

About 1921 the Wright Aeronautical Corporation, which built the 300-hp. Hispano engine, built one with the cranks at 90 degrees which eliminated the horizontal shake. Vibration-measurement at that time was in a crude state, and the improvement obtained was demonstrated on the test stand by the fact that, with the 90-degree shaft, a penny would remain on the crankcase, while with the 180-degree shaft the penny would quickly bounce off.

The next test was to mount two engines in similar Thomas-Morse fighters, one with the 180-degree shaft and one with the 90-degree shaft. A number of engineers ran these engines on the ground, and a number of pilots flew them. The consensus was that there was

no noticeable difference in vibration of the airplane. Probably, the engine torque variation was so large in both cases as to obscure the improvement in sidewise shake. In any case, the 90-degree shaft was not approved, although it soon became standard on V-8 engines for nonaircraft use. Such was the state of vibration analysis in 1922!

Reduction of engine vibration became essential in the early days of commercial aviation when passenger comfort became important. In this case, radial engines were used. Draper and Bentley made a serious study of radial-engine shaking forces and moments in 1937-38. One solution lay in flexible engine mounts to reduce the transmission of vibration to the airplane structure. This involved a problem of "droop" due to gravity when the engine was mounted at its rear, as in the case of radials. There was also the problem of decoupling the several modes of vibration in order to avoid numerous critical speeds. This problem was solved by the mount patented by E. S. Taylor and K. Browne, which has been widely used since. The principle employed is an arrangement of links which have the effect of supporting the engine at its center of gravity, although the actual flexible mounts are at the rear. Koppen has used very flexible decoupled engine mounts in light airplanes with good effect since about 1939. Another contribution to reduction of engine vibration was the adoption by Wright and Pratt and Whitney, in the late 1930's, of second-order rotating weights to balance the second-order shaking component characteristic of the master-rod system in radial engines.

Internal vibration of reciprocating engines has been most serious in the propeller-crankshaft system. This type of vibration originates chiefly from the torque variation inherent in piston engines and may be destructive when resonance is involved.

The Liberty engine of 1917 had a torsional resonant speed of 1900 r.p.m. with the usual propeller. Its rating at 1700 r.p.m. was close enough to cause accessory-gear breakage as previously mentioned.

Serious trouble with torsional vibration was experienced in the 1920's in dirigible airships using long shafts between engine and propeller. This type of vibration also held back the development of metal propellers, discussed later in this article.

A very critical case of crankshaft-propeller vibration appeared with the introduction of the geared version of the Wright 9-cylinder 1820-cubic inch radial engine in 1935. This problem was quickly and brilliantly solved by E. S. Taylor and R. Chilton, who developed the pendulous counter-weight, which effectively counteracted the principal torque components of the engine and prevented breakages in the drive system. The basic concept was by E. S. Taylor, for which he received the Reed Award in 1936. Chilton contributed the

mechanical embodiment. This type of device has been used in large radial aircraft engines ever since, and also in many nonaircraft powerplants. After testing the first engines so equipped, it was found that these inventions had been anticipated in France, but the credit for practical application should go to Taylor and Chilton.

Another important torsional vibration problem was that of the gear-driven supercharger rotor. Various types of flexible coupling have been used in the gear train to avoid serious trouble.

Further consideration of vibration problems is included under the heading "Propellers."

ALTITUDE PERFORMANCE AND SUPERCHARGERS

The fact that reduced air density, as altitude increases, reduces engine power must have been realized before it became obvious in 1909, when airplanes began to try for high altitude flight. The advantage of altitude in military work was very apparent in World War I.

The only attempt at improved altitude performance used in World War I was embodied in the German BMW and Maybach engines, which were designed to be partly throttled near sea level, the throttle to be opened only above about 5,000 feet. Both engines were designed to be lighter in weight than would have been required for full-throttle operation at sea level, and the BMW also had higher compression ratios than could be used with full throttle at sea level without detonation. In these cases the advantage in altitude performance over an engine capable of full-throttle operation at sea level was quite small.

Measurement of engine performance at altitude was first seriously undertaken when the U.S. Bureau of Standards completed its altitude test chamber in 1918. Subsequently a considerable literature on this subject developed.

The Swiss engineer Buchi suggested the turbo supercharger for aircraft in 1914. This type was then developed in France by Rateau, and experimental models were tested during the war, but none was put into service use. Laboratory work on gear-driven superchargers was conducted during the war by the R.A.F. at Farnborough, England. Intensive development of supercharging equipment began both in England and the U.S.A. in 1918.

Many types of compressors have been considered, but only one, the centrifugal type, ever got beyond the experimental stage. The Royal Aircraft Factory had Armstrong-Siddeley build a radial engine with built-in geared centrifugal supercharger in 1916, but the design was unsuccessful, probably because of torsional vibration in the drive system. Siddeley did not produce a successful geared supercharger until that used in 1926 in the "Jaguar."

Geared superchargers were built experimentally by Curtiss and Wright Aeronautical Corporation in 1925, but the first U.S. produc-

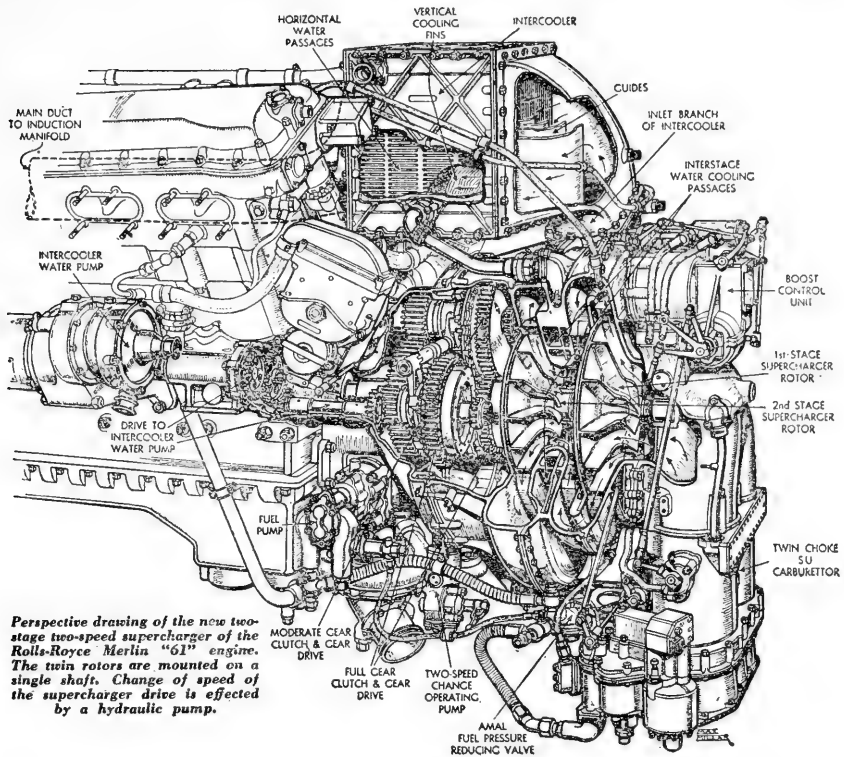

FIGURE 16.—Two-stage two-speed geared supercharger with intercooler and aftercooler of the Rolls-Royce "Merlin 61" engine of 1942, the first of its kind to be used in service. (Courtesy "Flight" magazine.)

tion engine to be so equipped was the Pratt and Whitney "Wasp" of 1927, a year later than the "Jaguar." Since 1930 all military and transport engines have been equipped with geared centrifugal superchargers, and in all cases some kind of flexible coupling has been introduced in the gear train to prevent critical torsional vibration. The culmination of the geared centrifugal type is represented by the two-stage, two-speed supercharger of the Rolls-Royce "Merlin" (fig. 16).

In 1918 the Engineering Division of the Army Air Service contracted with the General Electric Company to develop turbo superchargers of the Rateau type. The man in charge of this development for G.E. was Dr. Sanford A. Moss, who remained in this position for over 20 years. Experimental models applied to the Liberty engine were tested at the top of Pikes Peak in 1918, and in flight at McCook Field in 1919.

Plate 22, figures 1 and 2, show an installation of this early type of General Electric supercharger in the Liberty-equipped Le Pere airplane. This equipment held the world's altitude record for the years

1920, 1921, and 1922. Supercharging was hard on an engine not originally designed for it, and I remember when Major Schroeder, who made the 1920 record, returned from a flight with the Liberty engine and its nacelle cut in two by a failed connecting rod at the third crank from the front end. The only elements holding the four forward cylinders and the propeller in place were the crankshaft and the two camshaft housings. In spite of this condition, and the loss of all its cooling water, the Liberty engine was still running!

A serious difficulty with the supercharger shown in plate 22, figure 1, was the failure of turbine blades due to inadequate cooling of the turbine. To overcome this difficulty, I suggested placement of the turbine wheel on the nacelle surface, using an overhung turbine wheel as in plate 23, figure 1. This suggestion was adopted and used on all subsequent installations of turbo superchargers in the U.S.A. including the Martin biplane bombers¹⁷ of the 1920's and the B-17 and B-24 bombers. The Boeing Stratocruiser and the B-29 and B-50 bombers used essentially the same system, although in these airplanes the turbine was located inside the nacelle and the overhung wheel was cooled by air piped in from outside. Beginning with the B-17 the engines were also equipped with gear-driven superchargers acting as the second stage.

The only service use of turbo superchargers on foreign-built airplanes appears to be that of the German Junkers Diesel engine in a World War II high-altitude photographic airplane. It is remarkable that this very effective device received so little development outside of the U.S.A.

In 1927 the official world's altitude record was taken by Lieutenant Champion, U.S.N., with a Pratt and Whitney "Wasp" equipped with an N.A.C.A. Roots-type supercharger acting as first stage to the engine's own geared centrifugal equipment (pl. 23, fig. 2). This is the only important use of a noncentrifugal supercharger in aircraft.

Aftercoolers,¹⁸ that is, devices to cool the air after leaving the supercharger, have been generally used with turbo superchargers, and with two-stage geared types. Such coolers are shown in plate 22, figure 1, and plate 23, figure 1. The "Merlin" engine (fig. 16) used a water-cooled aftercooler with its own separate radiator and circulation system.

The culmination of the supercharger art is represented by the Wright Turbo-compound R-3350 engine shown in plate 17, figure 2. This engine, introduced about 1947, has three exhaust-driven turbines geared into the power system, as well as a two-speed centrifugal geared supercharger. In normal operation the turbines deliver more

¹⁷ A squadron of Martin bombers was the first combat group ever equipped with turbo superchargers (1923-24).

¹⁸ When the cooler is used between stages of supercharging, it is called an "intercooler."

power than is required by the supercharger. This engine is standard on the DC-7 and "Super Constellation," the last large piston-engined passenger-transport planes built in this country.

PROPELLERS

Gibbs-Smith credits the Chinese with first use of the air propeller, on toy helicopters. A helical screw is shown on a DaVinci helicopter drawing of about 1500, and screw propellers were used on dirigible balloons as early as 1784.

The success of the Wright brothers was in no small degree due to the excellent performance of their two counter-rotating wooden propellers, chain driven at $8/23$ engine speed, or about 380 r.p.m. The Wright brothers encountered many difficulties with propeller design. Apparently they could get no useful data from marine engineers and had to develop their own theory. In developing this theory, they often argued each other into a reversal opinion, but finally arrived at a design which Caldwell says ran at near optimum ratio of forward speed to tip speed, and had an efficiency of about 0.70.

The Wright propellers were of 3-ply laminated wood, very light in weight. It should, perhaps, have served as a warning to future propeller designers that the first fatal accident—the crash of Orville Wright and Lieutenant Selfridge in 1908, resulting in the death of Selfridge—was caused by a propeller failure. A broken blade set up sufficient vibration to cause the propeller to cut a rudder-bracing wire.

Wooden propellers were universally used from the Wrights' first flight until well after World War I. They were very reliable for the duty called for in that time, and were superseded only when the requirements for power and tip speed exceeded the limits within which a wooden propeller would safely operate.

Materials superior to wood were actively sought after World War I. Frank Caldwell, head of the propeller section at McCook Field (1918–30) and later chief engineer at Hamilton Standard, was the chief agent in this field, and has given excellent accounts of propeller developments. Here there is space for only the briefest review.

Micarta (canvas laminated with bakelite) was successfully used as a wood substitute by 1920. In 1921 Caldwell tested a steel-bladed propeller on his electric whirling machine to twice its rated power. He then, very innocently, presented it to me for a "routine" test on a Hispano-Suiza 300-hp. engine. After a few minutes at rated power, a blade broke off, came through the control board between the heads of two operators, climbed a wooden staircase, and went through the roof. The engine was reduced to junk.

The above incident was an early warning of the importance of vibration and fatigue in propeller operation. At my insistence, further "routine" propeller tests on experimental propellers were

made in a specially constructed "bombproof" shelter. All metal propellers of that time (1921-22) failed, with murderous results to the engine (pl. 24, fig. 1). In one case the whole assembly of crankshaft, rods, and pistons was pulled out and thrown 20 feet from what remained of the engine and stand.

Subsequent metal propeller development involved careful attention to vibration problems. The Reed type, using a twisted aluminum plate as a base (pl. 24, fig. 2), was one of the early successful designs. Later, the manufacturers of metal propellers developed elaborate equipment and procedures for the measurement and suppression of blade vibration.

The need for pitch control was realized in the 1920's, and some early designs of controllable pitch propellers were tested, usually with disastrous results because of mechanical weaknesses. Variable pitch became essential with the advent of the high performance airplane, the DC-3 being an early example. To make a long story short, the following is the sequence of important propeller developments with approximate dates:

1921-----	Aluminum blades, fixed pitch (Reed).
1923-----	Aluminum blades, adjustable pitch.
1931-----	Hollow steel blades.
1929-----	Controllable pitch, 2-position.
1935-----	Automatic, constant speed.
1938-----	Feathering.
1945-----	Reversible and feathering.

Both hydraulic and electric pitch control were used until after the last war. Now hydraulic control and aluminum blades are standard on piston engines, with a few exceptions. Plate 25, figure 1, shows an example.

REDUCTION GEARS

The Wrights, with their chain drive, were evidently aware that the optimum speed for engines is not usually that for propellers. Even before the Wrights, most experimental airplanes (Stringfellow, Maxim, Langley) had belt- or gear-driven propellers, although the drive ratio for steam engines was usually up rather than down.

Direct propeller drive, with the propeller mounted on the crankshaft, is attractive for its simplicity and reliability, and was used by most of the early flyers after Wright and up to the start of World War I. An exception was the early Renault air-cooled V-8 (pl. 7, fig. 1), the propeller shaft of which was an extension of the camshaft (or vice-versa) and ran at half crankshaft speed—a ratio which has been widely used since.

Other geared engines which appeared for use in World War I included the R.A.F. (copy of the Renault), the 8-cylinder-in-line Mer-

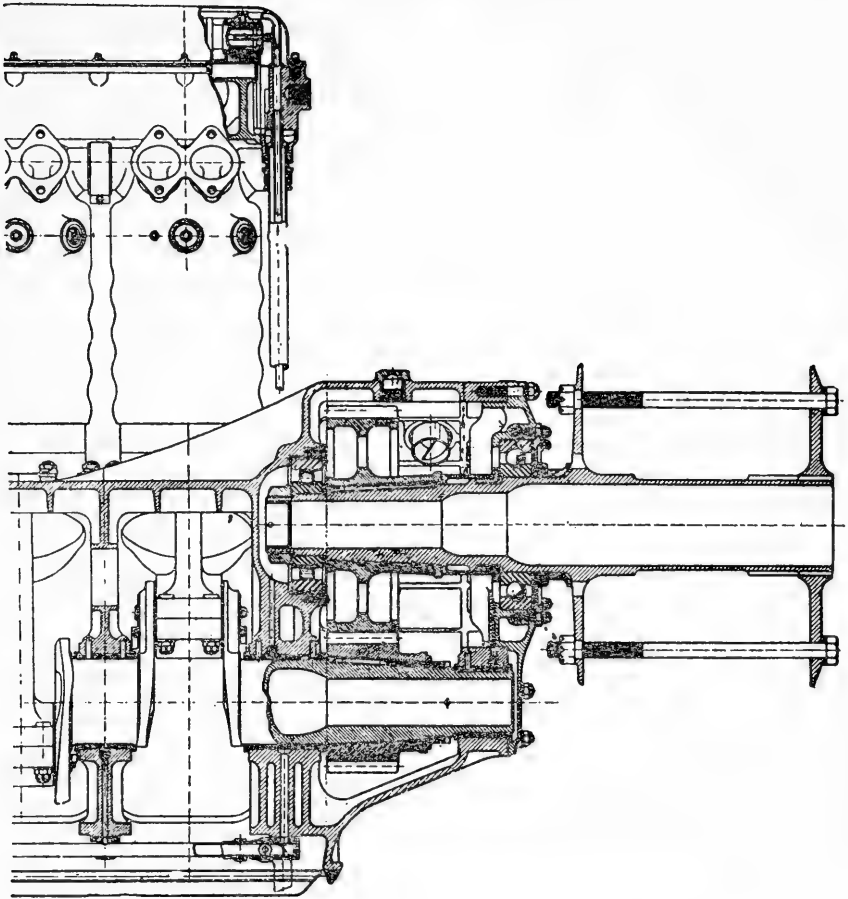

FIGURE 17.—Reduction gears of Renault Type 12 Kh engine.

cedes, and the 220-hp. Hispano-Suiza. These were soon followed by the Rolls-Royce "Eagle" with planetary gears. By 1920, most large European engines were geared.

The general use of gearing was much later in the United States. Actually, gearing was eliminated for the Curtiss D-12 in 1924 in order to save 25 pounds weight!

By 1930 it was evident to all that large engines should be geared to allow of optimum performance. Pratt and Whitney used an internal gear in 1931, and both Wright Aeronautical and Pratt and Whitney adopted the Farman planetary gear (fig. 18) for use in the DC-3 in 1933. From that time on, propeller reduction gears became an integral part of all large airplane engines, planetary spur gears (pl. 25, fig. 2) being standard for radials, and plain two-element spur gears for Vee engines (fig. 17).

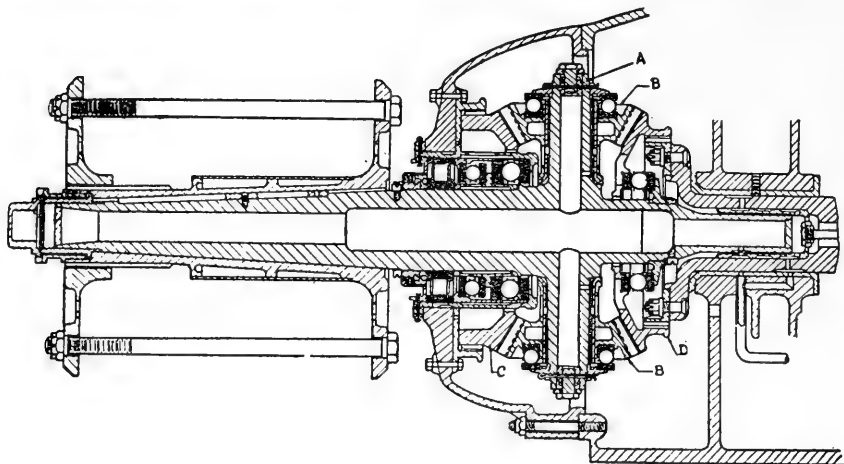

FIGURE 18.—Farman planetary bevel gear.

The plain spur gears used by the Rolls-Royce Merlin carried 2,200 takeoff horsepower satisfactorily on a 2-inch face width, a remarkable achievement in gear design.

SECONDARY PROBLEMS

Only brief mention can be made here of the numerous secondary, though often very important, problems encountered and solved in the development of reciprocating aircraft engines. Among these should be mentioned the following:

Starting.—Hand starting by the propeller was standard before 1920. Subsequent development included hand cranks, hand cranks with inertia flywheel, cartridge starters, air starters, and finally the present electric starter with storage battery.

Spark plugs.—Ceramic plugs were generally used in the U.S.A. before 1921. Both mica and ceramic plugs were used in Europe. From about 1921 to 1935 mica plugs were generally used. The development of new ceramic materials about 1935 caused a universal change to this material.

Carburetion.—At the time of the Wright brothers' first flight, little was known about carburetion, and various devices were used to introduce fuel to air. As mentioned earlier, the Wright brothers used gravity fuel feed from a small can to a heated surface in the inlet pipe. Manly used a large sheet-metal box filled with porous wooden blocks. These blocks were saturated with fuel, and the engine air was drawn past them, in the hope that a combustible mixture would result. The Antoinette engine apparently used a small pump to inject fuel into the air-inlet pipe. The carburetion system used for the Gnome rotary engine has already been described. All these systems required experimental adjustment, good for only one speed of the engine.

Meanwhile, float-type carburetors were being developed for automobile use, and these were used by most aircraft engines after the Gnome and Antoinette. The Wright brothers used float carburetors on their later engines.

Float-type carburetors were generally used for aircraft engines up to about 1935. A floatless carburetor was introduced by Chandler-Groves in 1935, and the Stromberg floatless injection-type carburetor became operational about 1938. Since that time most military and transport engines have used floatless-type carburetors, many of the injection type. Light-plane engines have, generally, continued to use float-type carburetors, although injection systems are available for this type.

Direct fuel injection.—Injection into the individual cylinders was used in gasoline engines for a short time on some Pratt and Whitney Wasps in 1931–32. This method was developed to service use in World War II in German military engines. It was adopted by Wright Aero Corporation for their R-3350 engine in 1944.

Inlet-port injection.—Injection through nozzles located at each inlet port has been used to a limited extent in light-aircraft engines since about 1946.

Stress measurement.—A very important contribution to improvement in the structural design of aircraft engines was made possible by the development of experimental stress analysis, which has been used by the major aircraft-engine manufacturers since about 1940. An important contribution to this art was the development of "Stresscoat" by E. S. Taylor and Greer Ellis in 1938. This method of showing stress patterns by means of a brittle lacquer coating had been used by the Germans earlier but was not known in this country until the work of the above-mentioned persons.

Miscellaneous.—Interesting historical developments have occurred in bearing materials, fuel systems, exhaust systems, control systems, fire extinguisher systems, and other elements, but space limitations prevent their consideration here.

UNCONVENTIONAL ENGINES

Hundreds of unconventional types of aircraft engine have been proposed, built, and tested. Among these may be mentioned:

1. Numerous "barrel" or "revolver" type engines. In this type the cylinders are positioned around the crankshaft with their axes parallel to it. Perhaps the best-known attempt was the "Almen" engine of 1921. None ever flew, as far as I know.

2. The Fairchild "Caminez" engine (fig. 19) was a 4-cylinder radial with rollers in the pistons operating on a two-lobe cam. This engine received U.S. Department of Commerce No. 1 type certificate (June

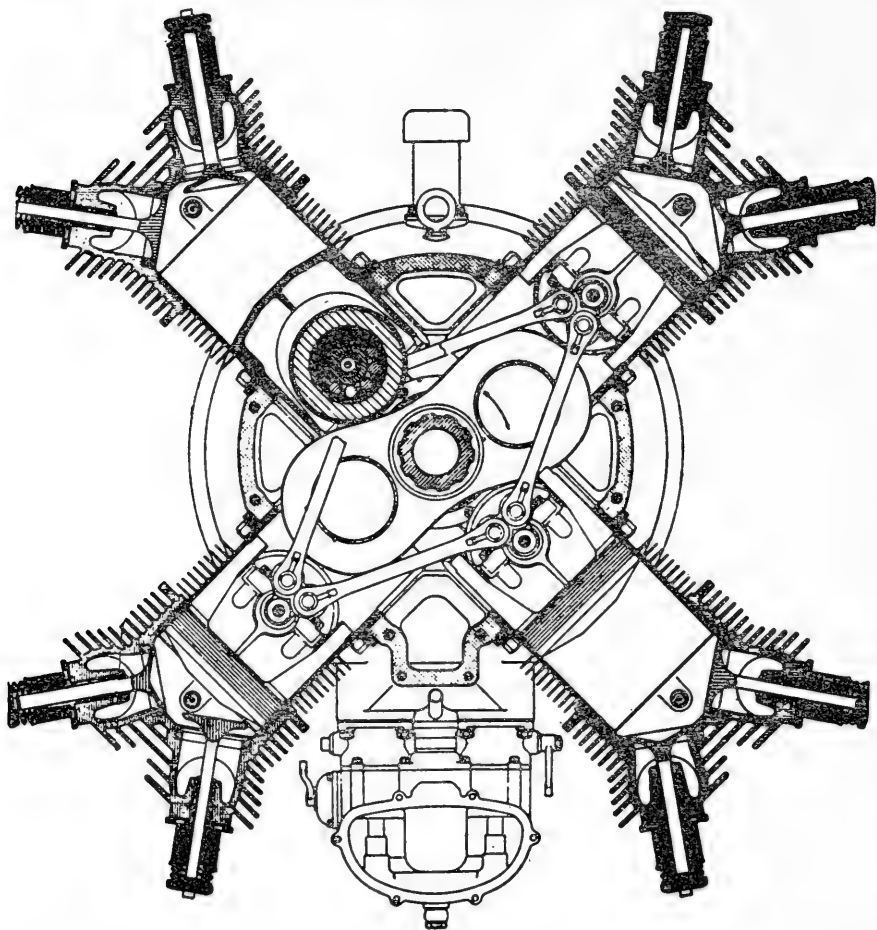

FIGURE 19.—Fairchild-Camenez engine, transverse section. This was the only crankless reciprocating engine to reach the stage of official approval (U.S. Dept. of Commerce Approved type Certificate No. 1, June 1927). Later it was found to be impractical because of severe torque variation.

1927) but proved impractical because of excessive vibration due to torque variation. It was flown experimentally 1926–28.

3. Sleeve-valve engines. The earliest development that I recall of a sleeve-valve aircraft engine was the Belgian "Minerva," which appeared in the 1920's, but never got beyond the experimental stage. This was a "Knight" type, or double-sleeve engine. The single sleeve, or "Burt-McCollum" type, was exploited chiefly in England and finally became operational in the Bristol line of aircraft radial engines, including the "Hercules" (pl. 26, fig. 1) and the "Centaurus." These engines were used by the British Air Force during World War II, and are still being manufactured (1962). The Napier "Sabre," also using the single-sleeve valve, was a 24-cylinder, liquid-cooled, two-crankshaft

“H” type engine used in British fighters toward the end of World War II. The Rolls-Royce “Eagle” (not to be confused with the 12-cylinder Eagle of World War I) was a 24-cylinder “H” type engine with sleeve valves, very similar to the Napier “Sabre.” It was developed after the war, too late to compete with the rapidly developing jet and turbine engines.

4. Diesel aircraft engines. Diesel engines built by Maybach were used in Zeppelin and other rigid airships in the 1920's. The first Diesel engine to power an airplane was a Packard air-cooled radial (pl. 27, fig. 1) designed by L. M. Woolson, who was killed in a crash (due entirely to bad weather) of an airplane powered with one of these engines before the development was completed. The Packard Diesel received CAA type certificate No. 43 on March 6, 1930. It set the world's nonrefueling duration record for heavier-than-air craft on May 25-28, 1931. This record still stands. This engine and its designer and manufacturer were the recipient of the Robert J. Collier trophy for 1931. However, it never became an important airplane powerplant. The Guiberson air-cooled radial Diesel engine followed the Packard and received C.A.A. type certificate No. 79, but was never widely used.

The most successful Diesel airplane engine was the Junkers “Jumo” 6-cylinder opposed-piston water-cooled engine (pl. 27, fig. 2), the development of which was started about 1920. This engine was used to a limited extent in German military airplanes and in German air transport, in the late 1930's. This engine also powered a high-altitude photographic reconnaissance airplane of World War II, but was obsolescent by that time.

The Napier “Nomad” engine, a two-cycle Diesel compound powerplant was designed after World War II for exceptionally high specific output. It was made obsolete by the gas turbines before full development.

Numerous other aircraft Diesels were built and test flown, mostly in Europe, but by the beginning of World War II it was evident that the Diesel engine could not compete with the conventional spark-ignition type, and development was then terminated. The research work of the N.A.C.A. on Diesel engines for aircraft during the late 1920's and early 1930's was outstanding.

5. Two-cycle engines. The Junkers Diesel engine, previously mentioned, has been the only two-cycle aircraft engine to get beyond the experimental stage. A great many two-cycle gasoline aircraft engines have been proposed, and many were built experimentally. Most of these were of the crankcase-compressor type, now common in outboard marine engines. The attraction of this type of engine lies in its mechanical simplicity and low cost, but it has serious

drawbacks for aircraft use, principal among which are its high fuel consumption when used with a carburetor, and its tendency toward misfiring and stalling at light loads. Most of the proposals have been for small, low-cost engines, but so far none has been developed with the characteristics necessary for a truly successful aircraft engine.

6. Finally there should be mentioned in this category two engines with unconventional cylinder arrangements.¹⁹ The first is the Napier "Lion" (pl. 26, fig. 2), the only W-type engine to see extensive service. This engine was liquid-cooled with its 12 cylinders arranged in 3 rows of 4 each. Brought out in 1918, it was quite widely used in British military and commercial aircraft, and won the Schneider Trophy, a race for seaplanes in 1927. The second engine in this category is the Pratt and Whitney R-4360, 28-cylinder air-cooled radial with 4 rows of 7 cylinders each (pl. 16, fig. 2). This is the largest (but not the most powerful) successful piston-type aircraft engine ever to reach the service stage. It has been used in many large military aircraft and in the Boeing "Stratocruiser." Besides the large number of cylinders and their unusual arrangement in "staggered" radial formation, unusual features include machined-all-over cylinder heads of unusual shape and an ingenious arrangement of the push-rod valve gear. This engine would undoubtedly have been more fully developed had it not been for the advent of jet engines and turbines.

SUMMARY OF PISTON-ENGINE DEVELOPMENT

Figure 20 shows performance parameters for piston aircraft engines since 1903.

Brake mean effective pressure (bmep) is a measure of an engine's ability to withstand high cylinder pressures and to produce power with a given speed and size. Starting at 62 pounds per square inch (Manly, 1902), it rose to 130 by 1925, which is near maximum for unsupercharged engines. With the introduction of supercharging and improved fuels in the 1930's, bmep was increased to takeoff values up to 360 psi (Rolls-Royce "Merlin") and 300 psi (U.S. large radial engines), where it has stopped since the advent of jets and turbines.

Mean piston speed (mps) at takeoff rose steadily from 750 ft./min. in 1903 to a maximum of 3,000 ft./min. in 1935, where it has remained.

Specific fuel consumption has improved from near 1 pound per horsepower-hour to current minimum values of less than 0.40. This gain has been achieved partly through improved design and partly

¹⁹ Obviously, the sleeve-valve Napier *Sabre* and the Junkers Diesel also had unconventional cylinder arrangements.

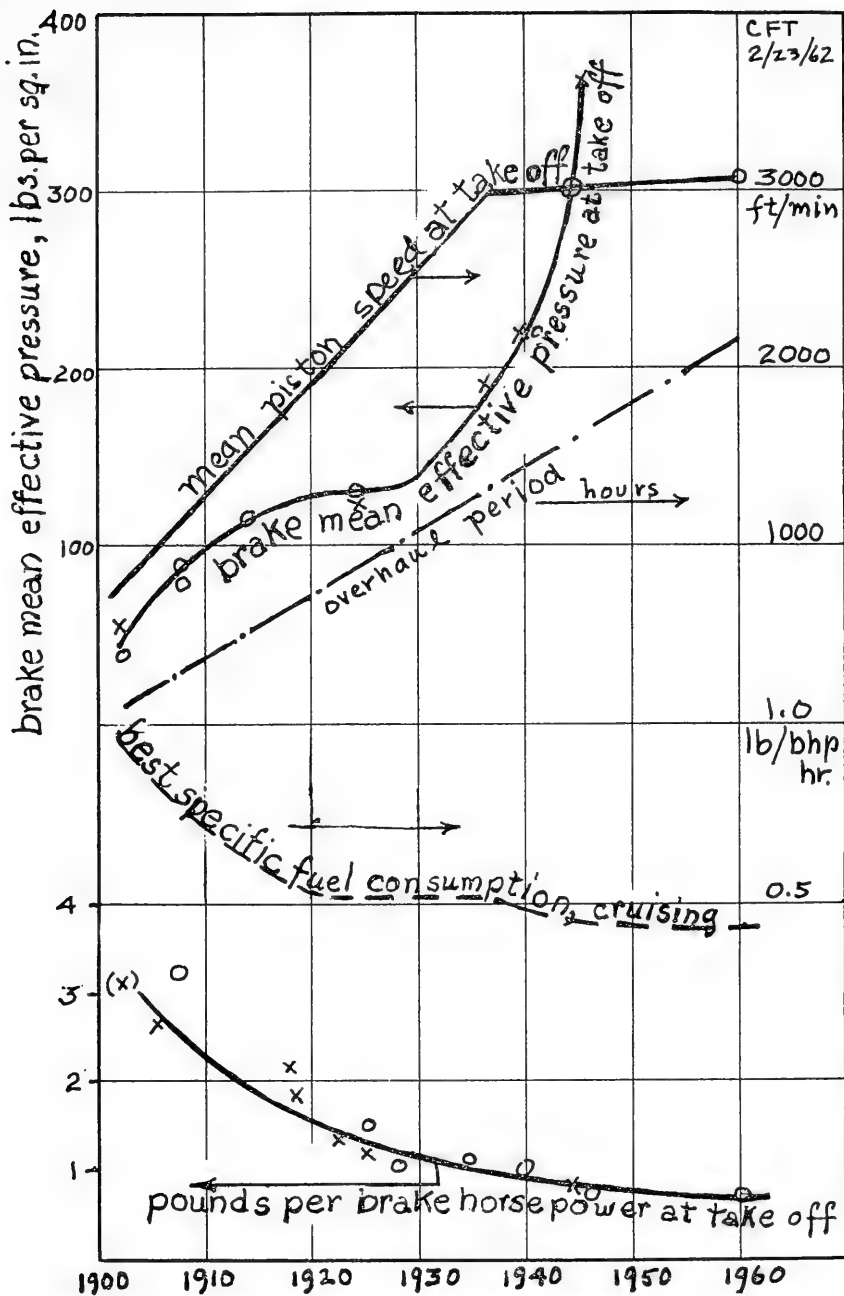

FIGURE 20.—Engine development curves.

because improved fuels have allowed higher compression ratios (from about 4.0 in 1903 to present values up to 8.0).

Best weight per horsepower in 1903 was the Manly engine, at 2.6 pounds. This value came down to 1 pound in 1935 and has gone slightly below that since (see table 1).

One of the most remarkable improvements has been in reliability and reduced maintenance. The very early aircraft engines were overhauled after every flight. The approved overhaul period for the best modern transport engines is now as high as 2,600 hours.

Further improvements in piston engines would have been made had it not been for the introduction of jets and turbines, which have virtually put an end to intensive development of the large piston engine. Jet engines are also under development for certain categories of small aircraft.

PISTON-ENGINE FAMILY TREE

Figure 21 shows the piston-engine family as it has developed, finally culminating in the Vee-12 liquid-cooled engines as represented by the Rolls-Royce and Packard "Merlin," and the 18-cylinder air-cooled radials; and the Pratt and Whitney R-2800 and the Wright 3350, both of which remain in air-transport service, as do also the Pratt and Whitney R-1830 and Wright R-1820 (in the DC-3 airplane). There are also some Pratt Whitney 9-cylinder "Wasps" in service in medium-powered airplanes, especially in Canada, and a few remain in service in the old Ford trimotors dating from about 1930.

TURBINE, JET, AND ROCKET ENGINES

Figure 21 includes a family tree for rocket, turbo-jet, and turbo-propeller engines. The history of these developments is so recent and so well covered in the literature (particularly by Schlaifer and Gibbs-Smith) that no attempt will be made to cover it here. There could well be a paper of similar length, or even a whole volume, devoted to this important and revolutionary development in aircraft propulsion.

NATIONAL CREDITS

It is interesting to review the contributions of the various nations in the field of aircraft propulsion. Table 2 summarizes this subject. It is evident that the U.S.A. and France have been the principal contributors to early engine development, while England has made significant contributions in late piston and early turbine engines, and Germany was the first to fly rocket and jet engines.

CONCLUSION

If the art and science of aircraft propulsion develop as fast in the next 50 years as they have since the Wright brothers' initial flight,

STEAM

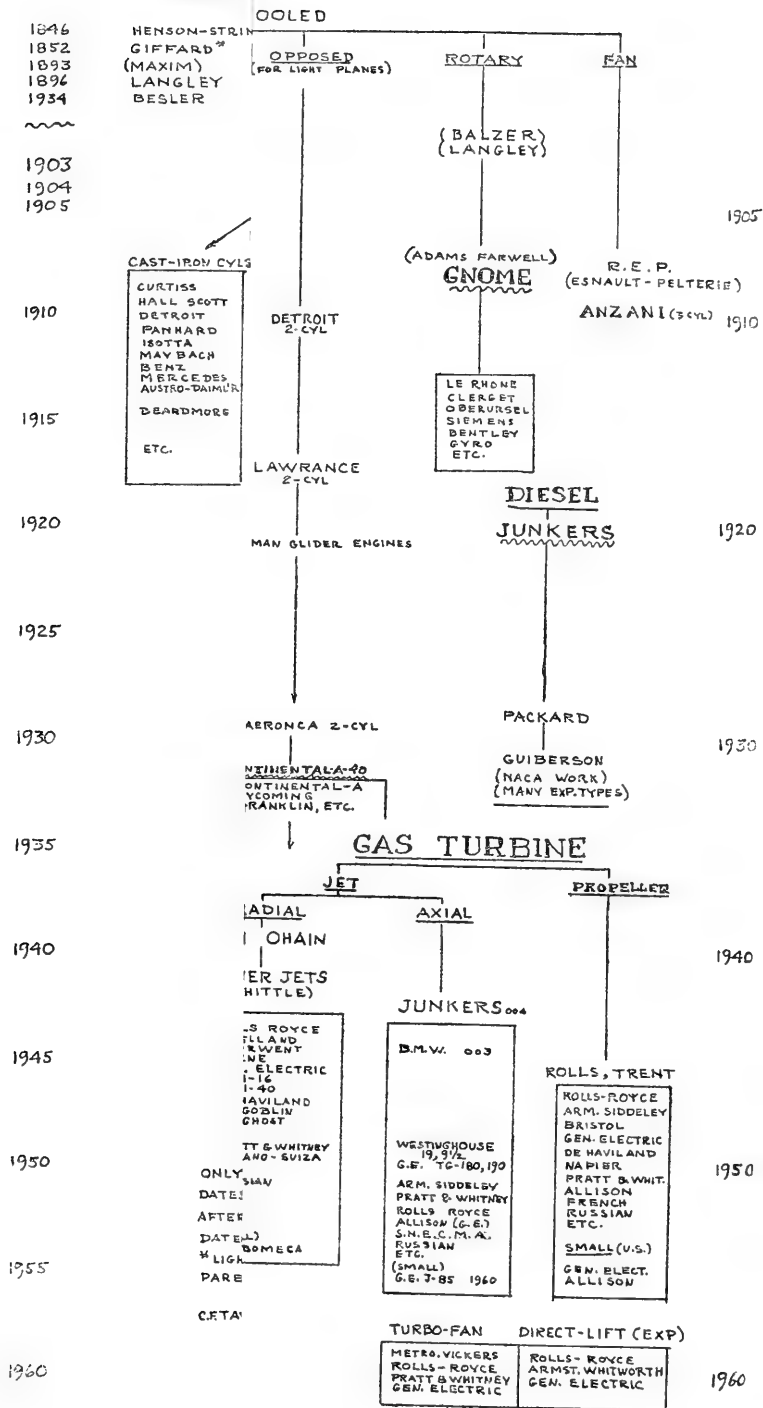

the following prophecy of Lester D. Gardner in *Aviation*, volume 1, No. 1, August 1916, will be as meaningful now as it was then:

Now many of the most distinguished scientists in all countries are giving aeronautics close and careful study. From the work of these men aeronautics will derive the information upon which progress, such as has never been thought possible, will be achieved.

EDITOR'S NOTE.—The full bibliography that accompanied the manuscript of this article was too lengthy for inclusion here, but if possible it will be arranged to publish it elsewhere.

PISTON ENGINE FAMILY

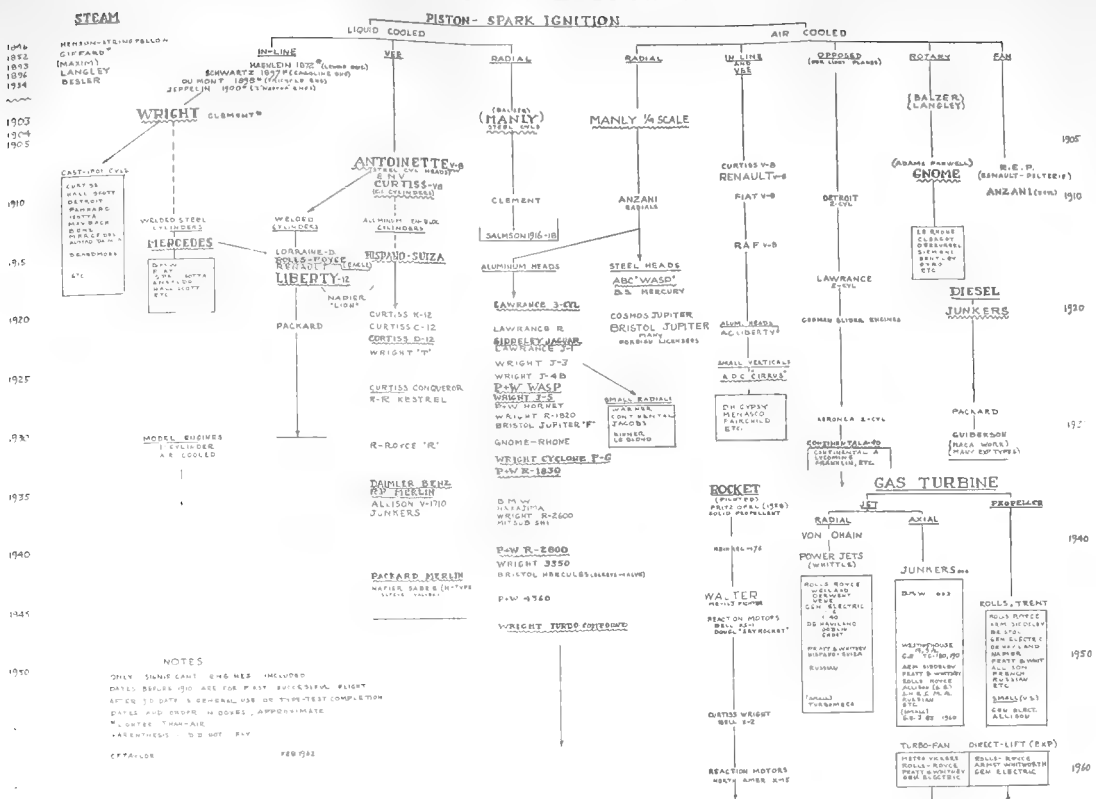

FIGURE 21 — The aircraft-engine family.

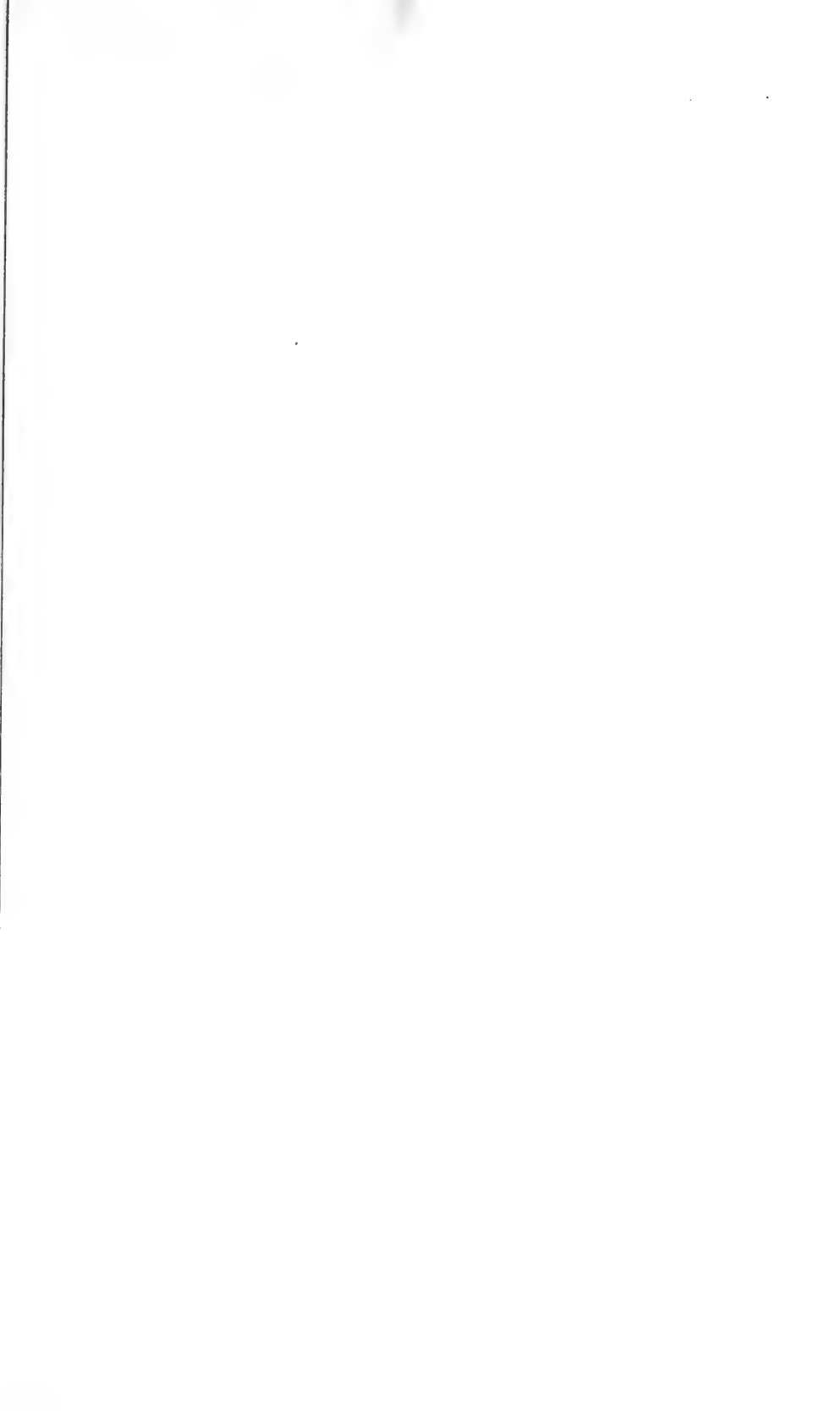

TABLE 1.—Part 1, Water-cooled engines

Engine	Year	Type	No. cyl.	Bore, in.	Stroke, in.	Displ., in. ³	Hp. ^a	R. p. m.	Weight ^b		Bmeep psi	Piston speed ft./min.
									lb.	lb. hp.		
Wright-----	1903	horizontal---	4	4	4	200	16	1,090	179	11.2	58	725
Manly-----	1901	radial-----	5	5	5.5	687	52	950	135	2.6	63	870
Antoinette---	1906	vee-----	8	3.15	3.15	196	32	1,400	93	2.9	91	735
Darracq-----	1909	opposed---	2	5.2	4.72	194	24	1,500	121	5.04	65	1,180
Curtiss OX-5---	1910	vee-----	4	4	5	503	90	1,400	320	3.55	101	1,170
Mercedes-----	1915	vertical---	6	5.51	6.3	901	160	1,400	618	3.86	100	1,470
Hispano-Suiza---	1915	vee-----	8	4.72	5.11	718	150	1,450	467	3.1	114	1,235
Liberty-----	1917	vee-----	12	5	7	1,650	420	1,700	856	2.04	118	1,985
Curtiss D-12---	1922	vee-----	12	4.5	6	1,145	325	1,800	704	2.16	125	1,800
R. R. Kestrel VI---	1930	vee-----	12	5	5.5	1,296	560	2,500	992	1.77	137	2,290
R. R. Merlin I-----	1936	vee-----	12	5.4	6	1,650	1,030	3,000	1,320	1.28	165	3,000
Packard-Merlin-----	1945	vee-----	12	5.4	6	1,650	2,250	3,000	1,740	.78	360	3,000

TABLE 1.—Part 2, Air-cooled engines

Engine	Year	Type	No. cyl.	Bore, in.	Stroke, in.	Displ., in. ³	Hp. ^a	R.p.m.	Weight ^b		Bmp. psi	Piston speed ft./min.
									lb.	lb./hp.		
<i>Air-cooled</i>												
Manly (model)	1901	radial	5	2.06	2.75	46.5	3.2	1,800	7	2.2	30	825
Anzani	1909	fan	3	4.13	5.12	206	24.5	1,600	145	5.9	59	1,360
Renault	1908	vee	8	2.76	4.72	226	35	1,400	242	6.9	88	1,100
Gnome	1909	rotary	7	3.93	3.93	335	50	1,150	165	3.3	103	753
Jupiter	1920	radial	9	5.75	7.5	1,753	400	1,650	700	1.75	109	2,060
Jaguar	1922	2-radial	14	5	5.5	1,512	360	2,000	910	2.53	94	1,830
Lawrance J-1	1922	radial	9	4.5	5.5	787	200	1,800	476	2.38	112	1,650
P. and W. Wasp	1926	radial	9	5.75	5.75	1,344	425	1,900	650	1.53	132	1,820
Wright 1820	1930	radial	9	6.13	6.88	1,823	575	1,900	940	1.64	-----	2,180
	1945	radial	9	6.13	6.88	1,823	1,525	2,750	1,376	.90	245	3,150
Continental A-65	1938	opposed	4	3.88	3.63	171	65	2,350	155	2.38	128	1,420
	1940	2-radial	18	5.75	6.0	2,804	2,000	2,700	2,300	1.15	209	2,700
P. and W. 2800	1945	2-radial	18	5.75	6.0	2,804	2,800	2,800	2,327	.83	305	2,800
	1948	4-radial	28	5.75	6.0	4,363	3,500	2,700	3,470	.99	235	2,700
P. and W. 4360	1941	2-radial	18	6.13	6.31	3,347	2,000	2,400	2,848	1.43	197	2,550
	1955	2-radial	18	6.13	6.31	3,347	3,700	2,900	3,500	.96	302	3,070

^a Maximum rated, or takeoff power.^b Radiator and water is not included in the weight of liquid-cooled engines.^c Not included for air-cooled engines.^d Dropped to 12 hp. after 1 minute.

All liquid-cooled engines later than Curtiss D-12 are supercharged.

All air-cooled engines later than Lawrance J-1 are supercharged, except Continental.

TABLE 2.—Credits by country

Country	First manned flight	Engine	Aircraft	Year
Austria:	Internal combustion engine	Lenoir gas engine	Haenlein (dirigible)	1872
Denmark:	Fixed radial engine	Ellehammer	Ellehammer	1906
England:	With gear-driven supercharger	Armstrong Siddley	Armstrong Siddley	1917
	Transatlantic nonstop	Rolls "Eagle"	Vickers <i>Vimy</i>	1919
	Turbo-propeller engine	Rolls "Trent"	<i>Meteor</i>	1945
France:	Steam engine	Steam	Giffard (dirigible)	1852
	Electric motor	Electric motor	Tissandier (dirigible)	1883
	Air-cooled Otto-cycle engine	Tricycle engine	Santos-Dumont (dirigible)	1898
	Helicopter	"Antoinette" V-8	Cornu helicopter	1908
	Rotary radial engine	Seguin "Gnome"	Voisin	1909
	More than 8 cylinders	Lavasseur "Antoinette" 16 cyl	Antoinette	1910
	Propeller reduction gear	Renault V-8	Farman	1910

Germany:	Rocket engine	vonOpel	Opel-Sander Rak-1	1929
	Diesel engine in commercial transport	Junkers 2-cycle opp. piston	Junkers	ca. 1936
	Jet engine	vonOhain	Heinkel He-178	1939
	Axial flow jet engine	Junkers Ju-004	Junkers	1944
	Rocket engine in military service	Walter	Messerschmidt	1944
Spain-Switzerland:	Aluminum engine	Hispano-Suiza		1914
U.S.A.:	Airplane	Wright	Wright	1903
	Seaplane	Curtiss	Curtiss	1911
	Over 400 hp.	Liberty	DeHavilland-4	1918
	Transatlantic with 2 stops	4 Liberties	Navy-Curtiss NC-4	1919
	Turbo supercharger	Liberty	LePere (McCook Field)	1920
	With fuel antiknock	Liberty	DH-4 (McCook Field)	1921
	Metal propeller	Reed	Standard J-1	1921
	Controllable pitch propeller	Hispano-Suiza	Curtiss JN-4 (McCook Field)	ca. 1921
	Over 200 m.p.h.	Curtiss D-12	Curtiss racer (Detroit)	1922

TABLE 2.—Credits by country—Continued

Country	First manned flight	Engine	Aircraft	Year
U.S.A.—Continued	Crankless engine	Caminez	Fairchild	1926
	Roots supercharger	Liberty	DH-4 (NACA)	1927
	Diesel engine	Packard	Stinson	1928
	Cylinder fuel injection with spark ignition	Pratt and Whitney	Ford or Fokker	1931
	With pendulum-type vibration absorber	Wright 1820		1935
	Automatic constant speed propeller	Pratt and Whitney	Douglas DC-3	1935

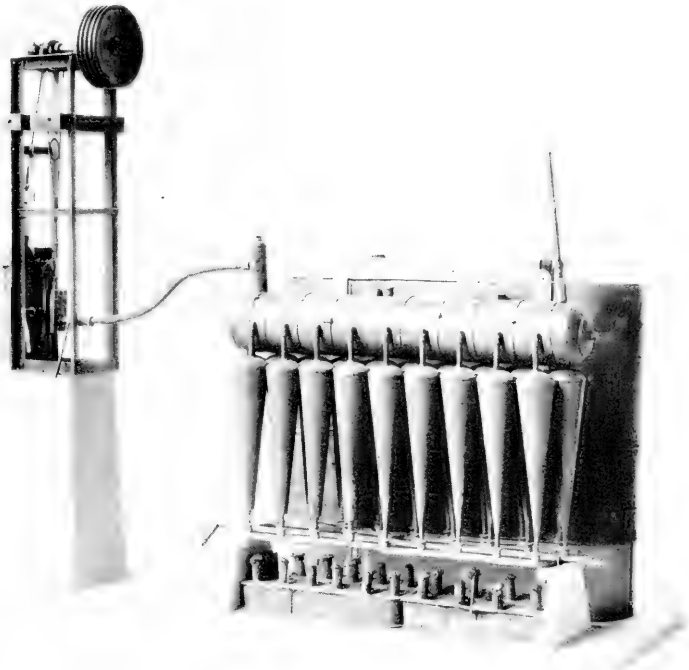

1. Stringfellow engine, 1868, National Air Museum specimen.

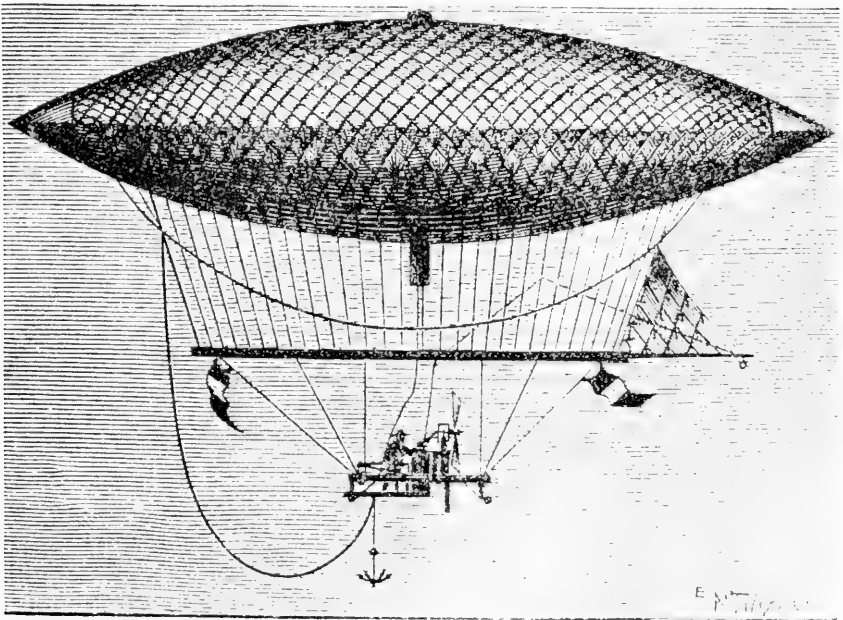

2. Giffard airship, steam-engine powered.



1. Maxim steam engine, 1894.

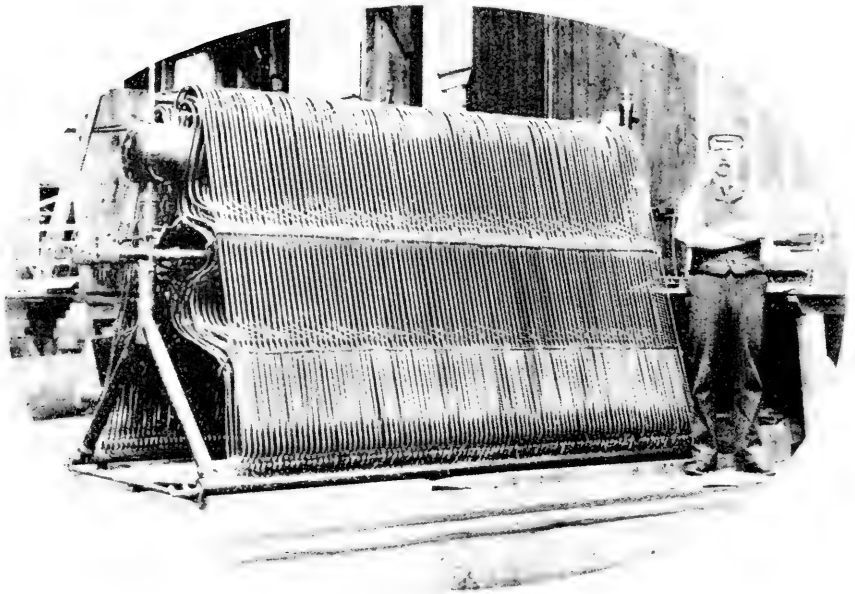

2. Maxim steam boiler, 1894.

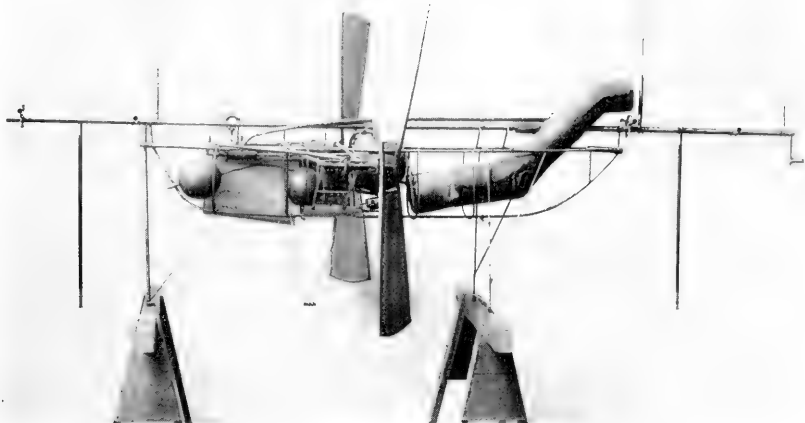

1. Langley steam engine used in Aerodrome No. 5, 1896.

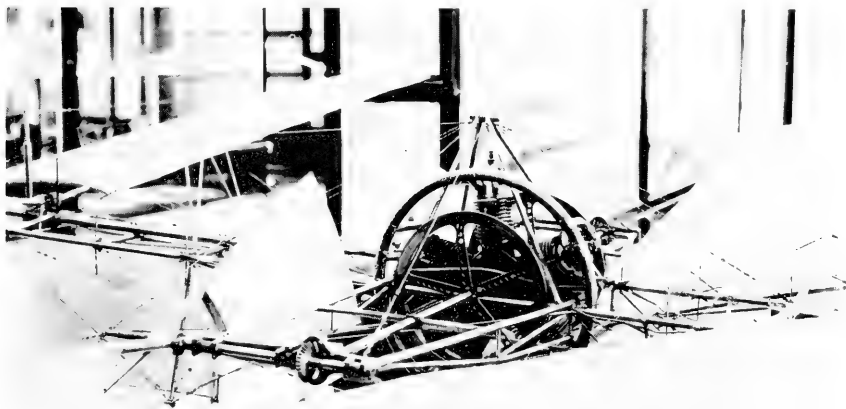

2. Langley gasoline engine used in one-quarter-size model aerodrome, 1901.

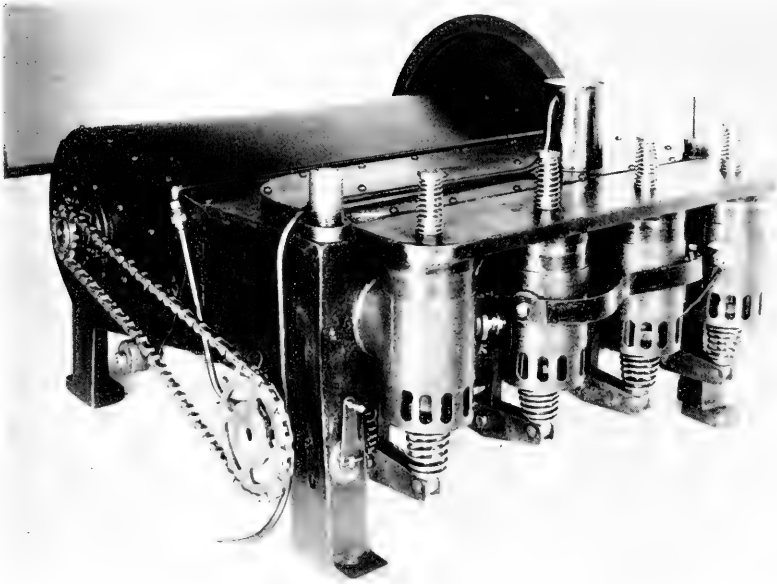

1. Wright brothers' engine from 1903 airplane.



2. Charles Taylor and $\frac{1}{2}$ -size Wright 1903 engine made by him.

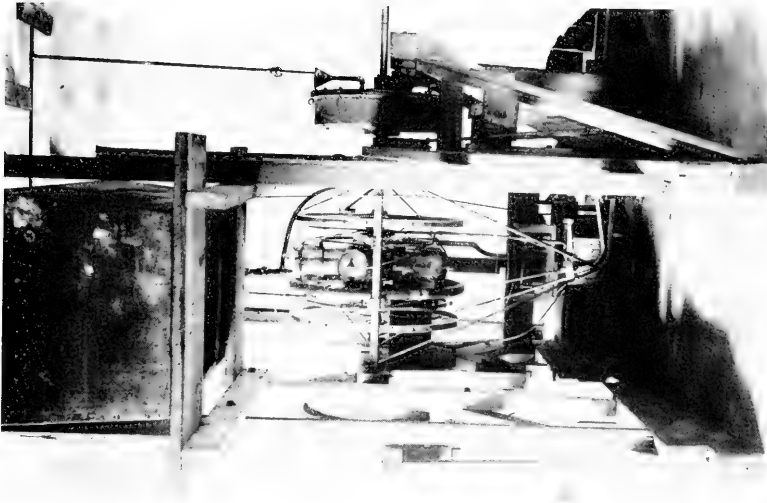

1. Langley-Manly-Balzer engine, 1903 in test stand.

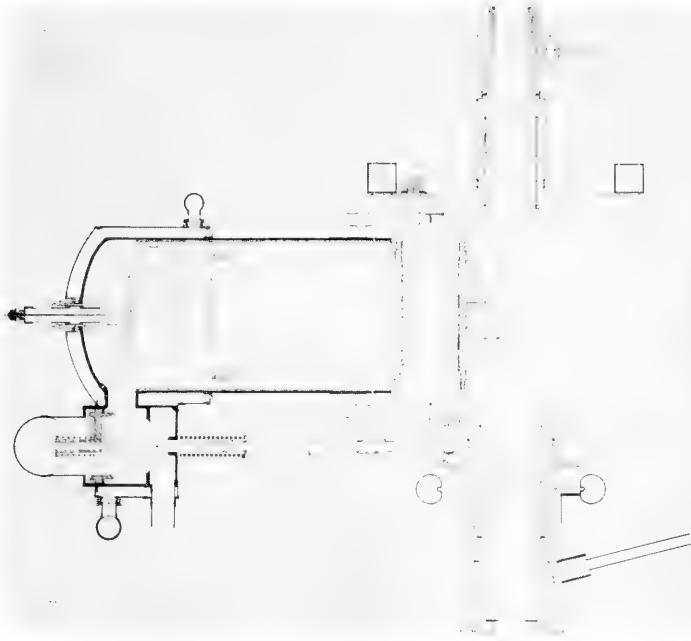

2. Langley-Manly-Balzer engine, 1903, sectional drawing of cylinder.

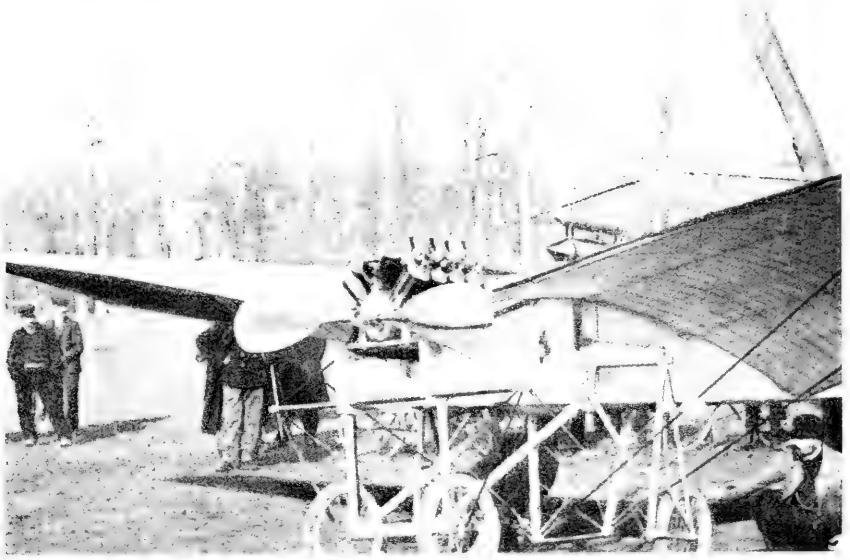

1. Antoinette monoplane with Lavavasseur Antoinette engine, 1909.

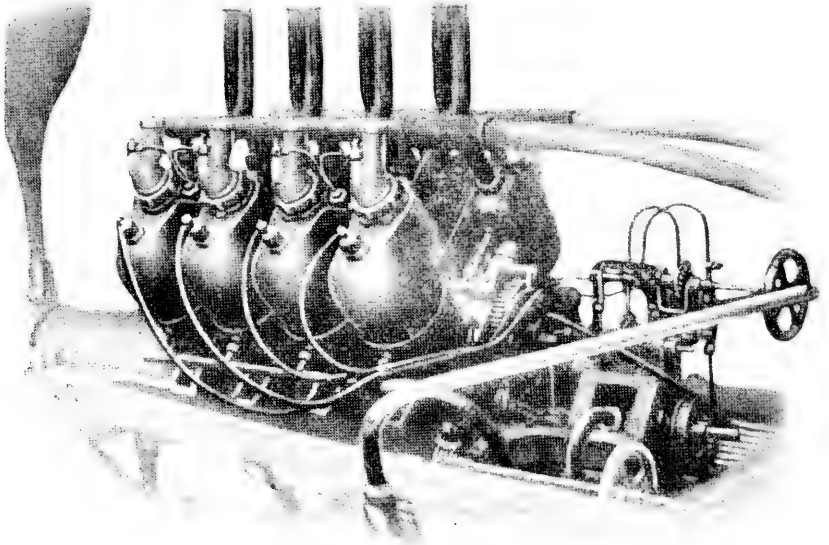

2. Antoinette engine, 8-cylinder, 55 hp.

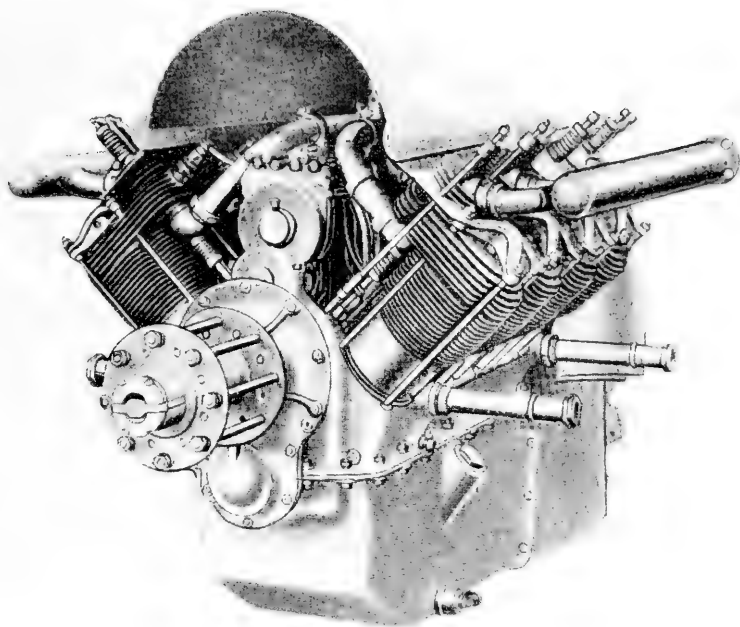

1. Renault engine, V-8, 80 hp.

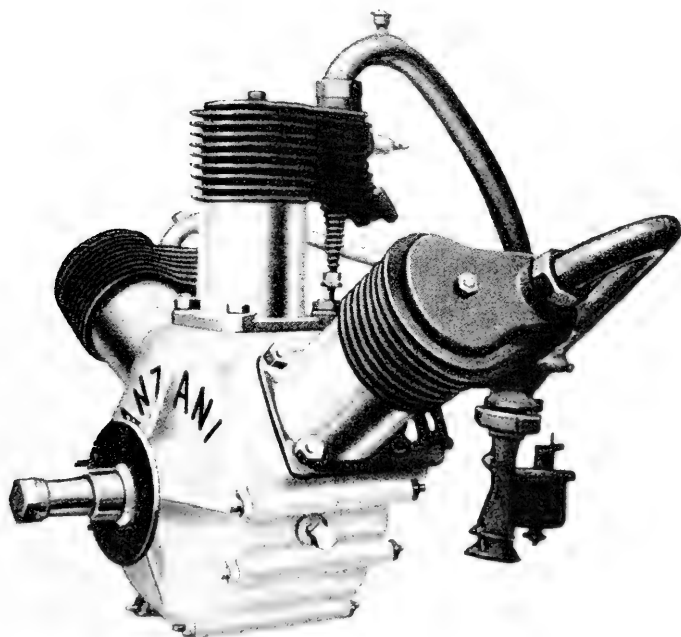

2. Anzani 3-cylinder fan-type engine, 22 hp., 1909.

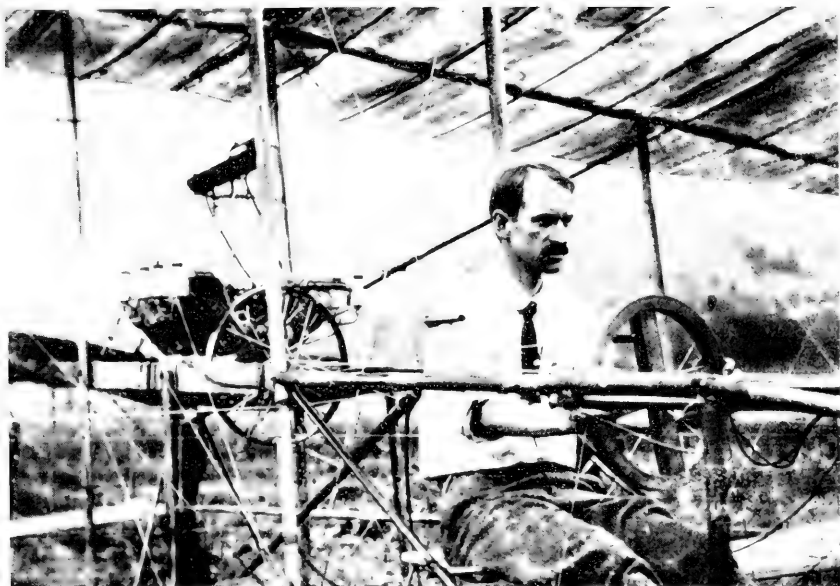

1. Glenn Curtiss in "June Bug" airplane, showing his engine installed, 1908.



2. Curtiss JN-4 airplane with OX-5 engine.

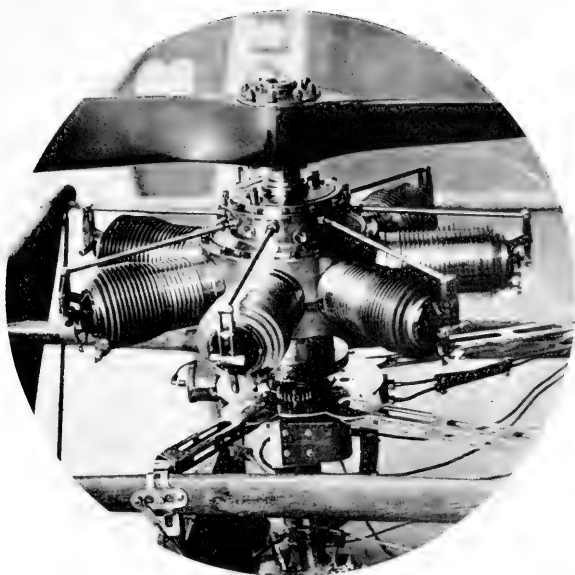

1. Gnome engine, 1910, 7-cylinder rotary, 50 hp., 1910.

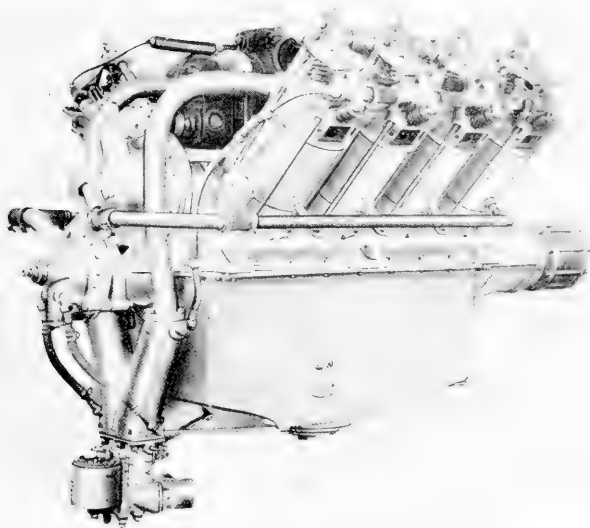

2. Curtiss OX-5 engine, V-8, 95 hp., 1917.

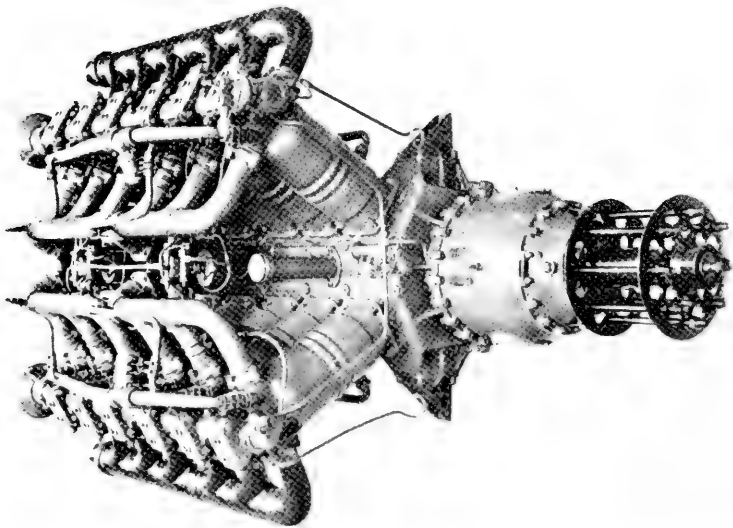

1. Rolls-Royce "Eagle" engine, 12-cylinder Vee, 360 hp.,
England, World War I.

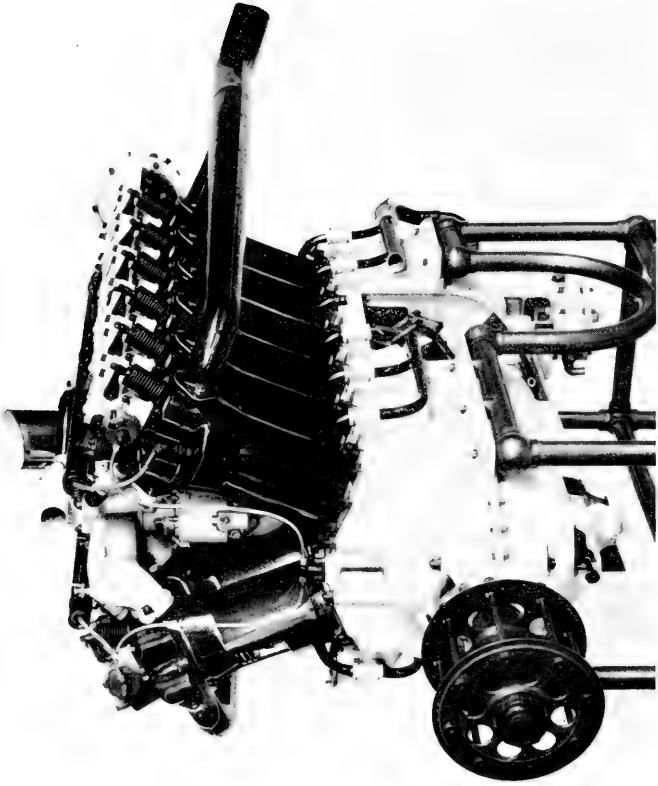

2. Liberty engine, 12-cylinder Vee, 400 hp., U.S.A., World War I.

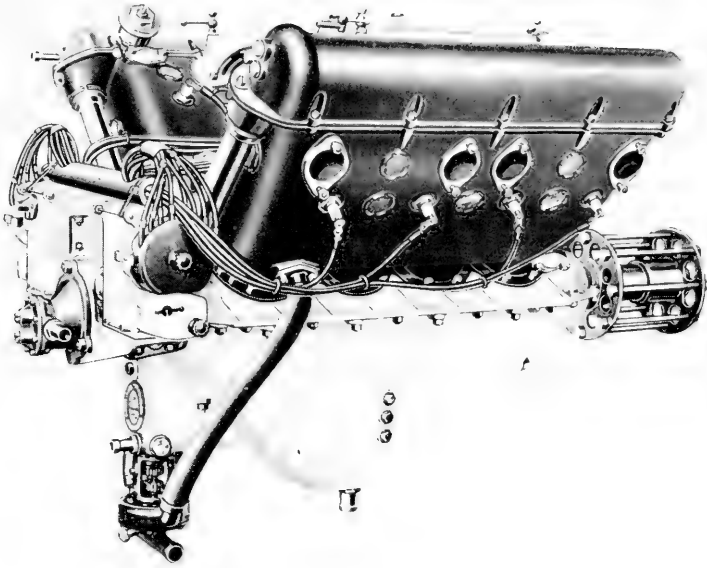

1. Hispano-Suiza engine, V-8, 180 hp., oblique view, magneto end, 1915.



2. SPAD airplane, used by 27th Squadron, A.E.F., World War I.

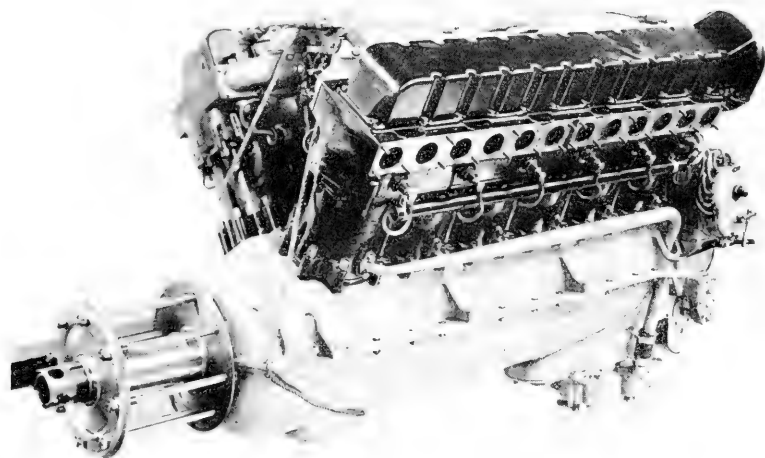

1. Curtiss D-12 engine, first to fly more than 200 m.p.h., Detroit, 1922.

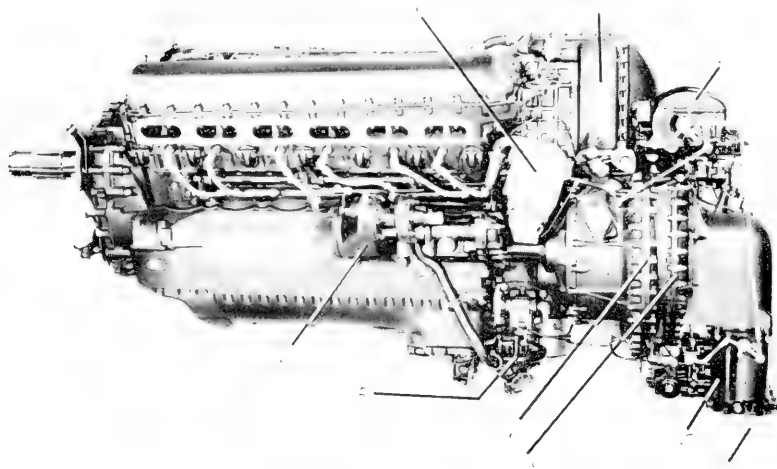

2. Rolls-Royce Merlin XX, 1944. 1, Left magneto; 2, aftercooler; 3, control unit; 4, carburetor air intake; 5, carburetor; 6, supercharger, first stage; 7, supercharger, second stage; 8, engine coolant pump; 9, aftercooler coolant pump.

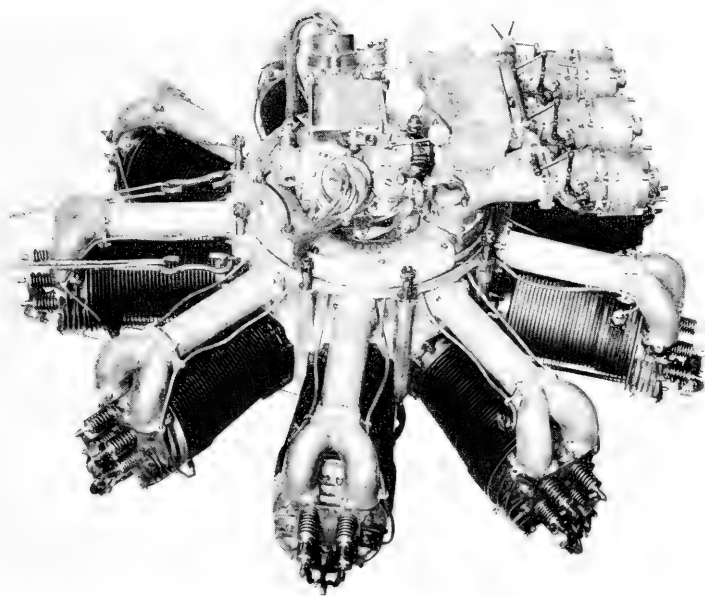

1. Bristol Jupiter, 1922, 360 hp., at 1600 r.p.m. This example was built by Cosmos Engineering Co., Ltd. (Photo from McCook Field Report 2193.)

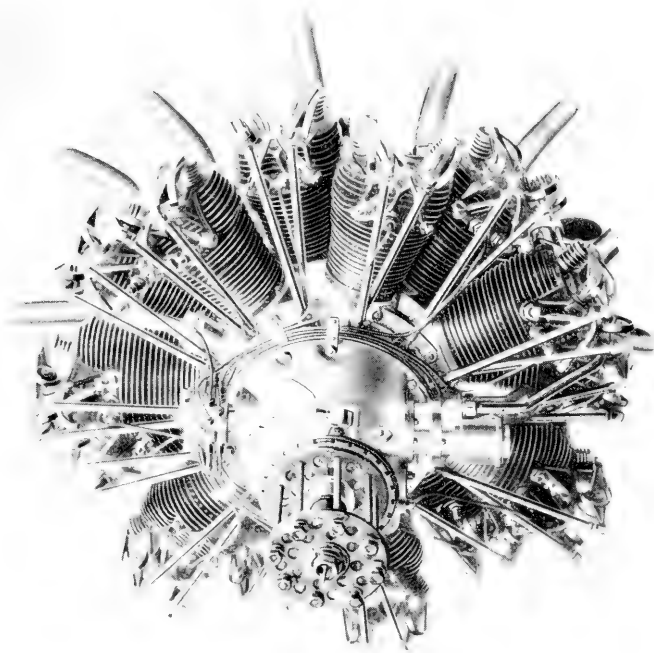

2. Armstrong-Siddeley Jaguar, 1922. First successful British radial engine with aluminum-head cylinders and gear-driven supercharger.

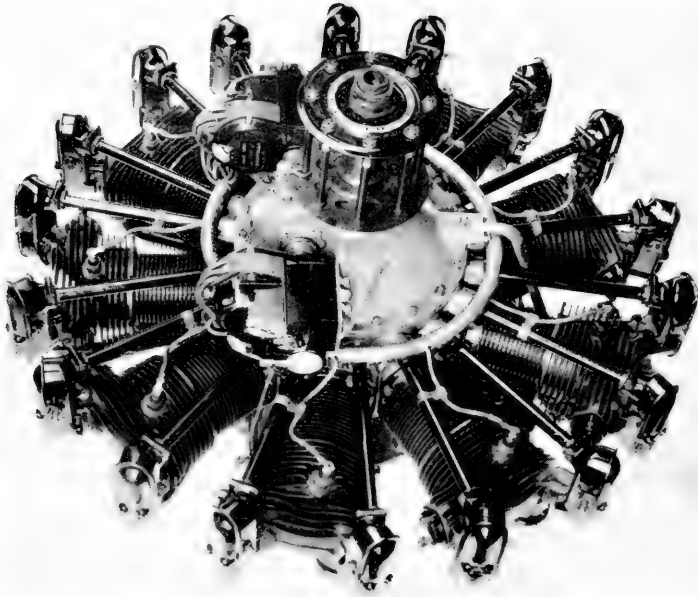

2. Wright Whirlwind engine of 1927. This type of engine was used by Lindbergh, Chamberlin, Byrd, and others.

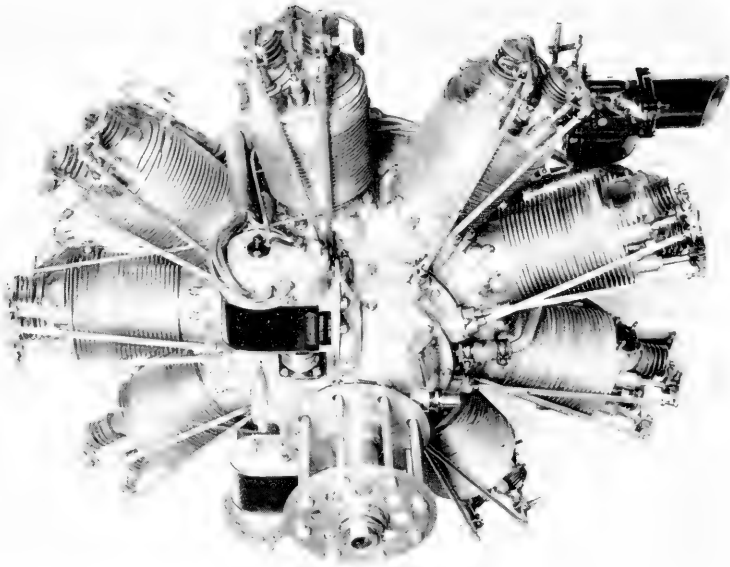

1. Lawrance J-1 air-cooled radial engine, 1924. The first American-designed 9-cylinder radial to be put into general use. The cast-aluminum cylinder head and internally-cooled exhaust valves have been retained in modern practice.

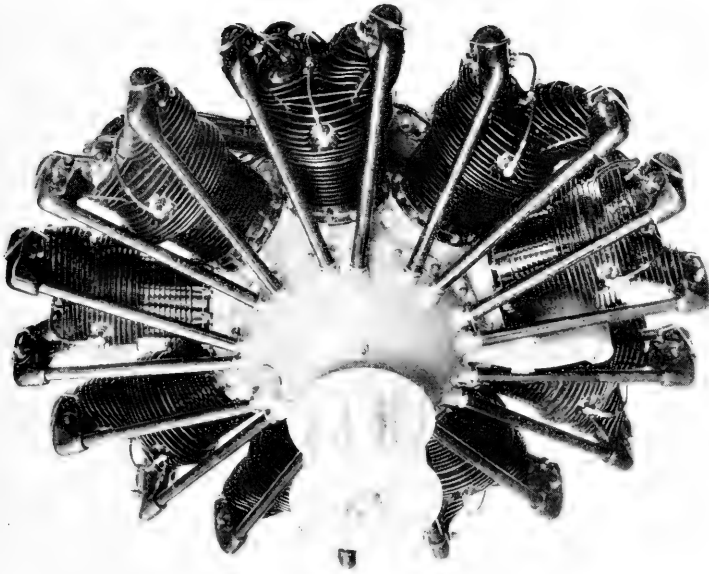

1. Pratt & Whitney, 425 hp, "Wasp" 1926. The first U.S. air-cooled radial of over 400 hp. to go into general service. It pioneered many technical features which became standard practice for this type.

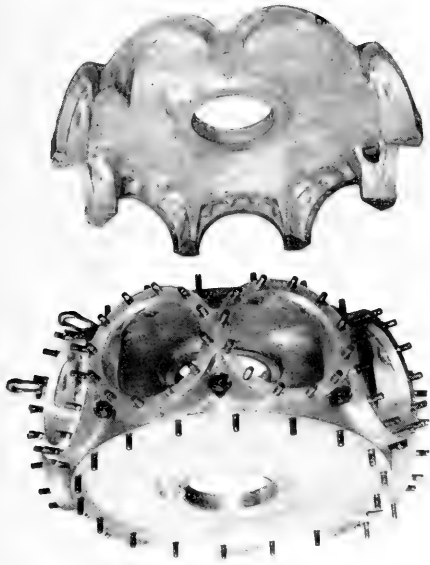

2. Forged aluminum crankcase of Pratt & Whitney "Wasp." Left, complete crankcase. Right, forging of one half before machining.

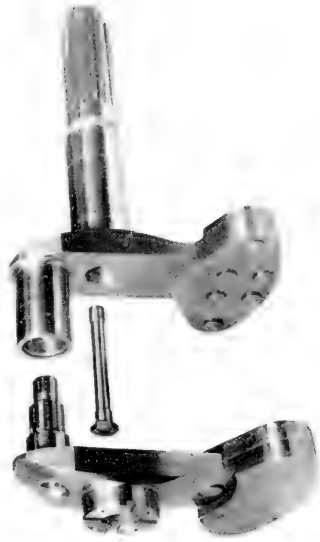

3. Divided crankshaft of Pratt & Whitney "Wasp." This type of shaft was first used on the "Gnome" engine (see pl. 9, fig. 1, and text fig. 5).

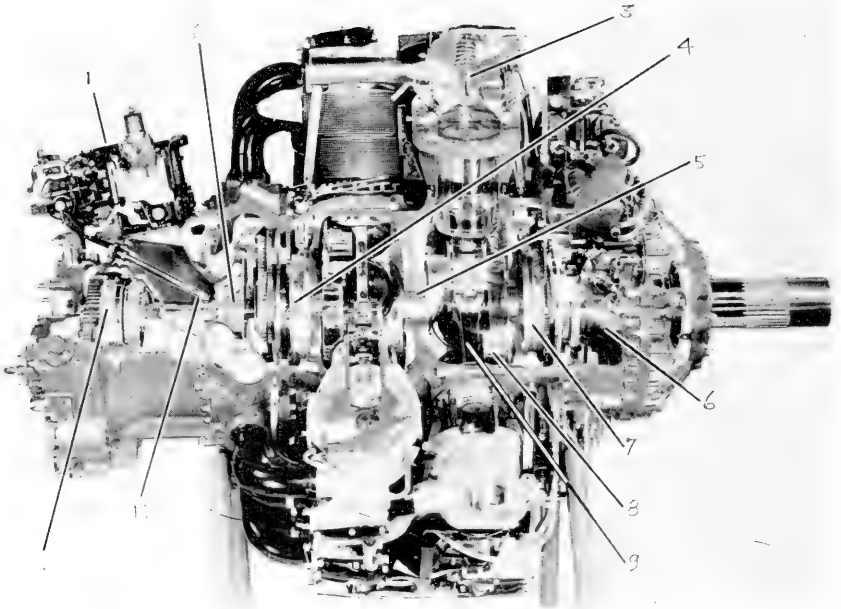

1. Pratt & Whitney R-2800, 18-cyl., 1946 (cutaway). 1, Injection carburetor; 2, supercharger rotor; 3, inlet valve; 4, rear cam drum; 5, center main bearing; 6, planetary reduction gear; 7, front cam drum; 8, front counterweight; 9, front master rod; 10, fuel nozzle; 11, supercharger drive gears.

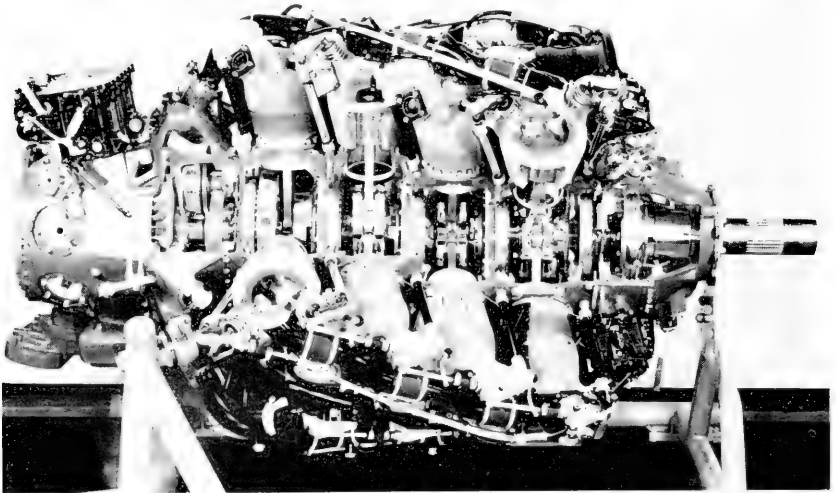

2. Pratt & Whitney R-4360, 28-cyl., 4-row air-cooled radial engine, 3350 hp., 1948, cutaway.

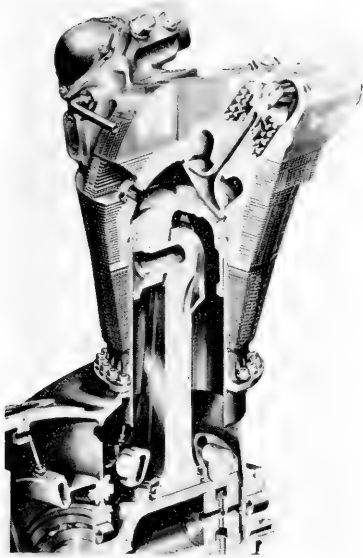

1. Forged cylinder for Wright 3350 engine, 1948. Forged and machined head, steel barrel with aluminum fins rolled in, sodium-cooled valves Stellite-faced, 100-plus square inches of fin area per square inch of piston area. (Courtesy Wright Aeronautical Corp.)

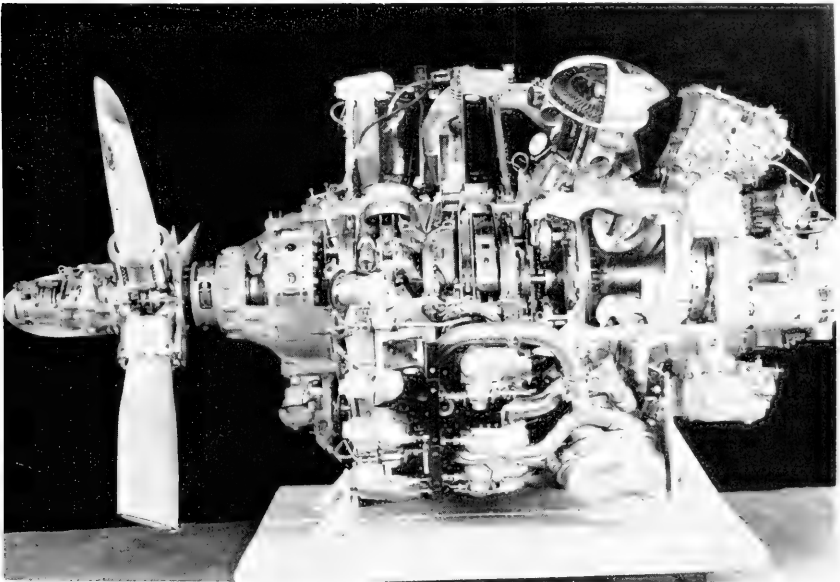

2. Wright turbo-compound, 18-cyl., 2-row air-cooled radial engine, 3350 hp., 1946 (cutaway).

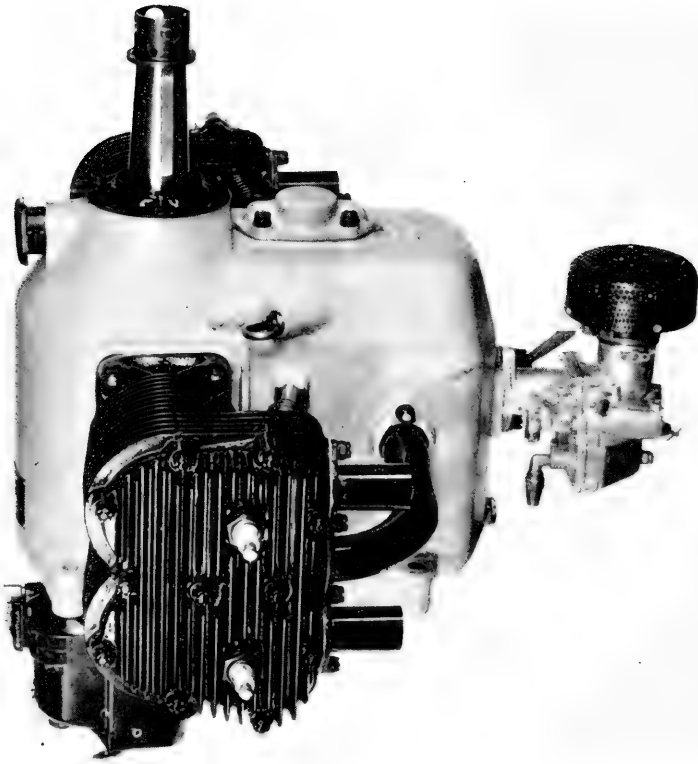

1. Continental A-40, 4-cyl. horizontal opposed, 38 hp., 1931.



2. Model airplane engine, "Super Cyclone."

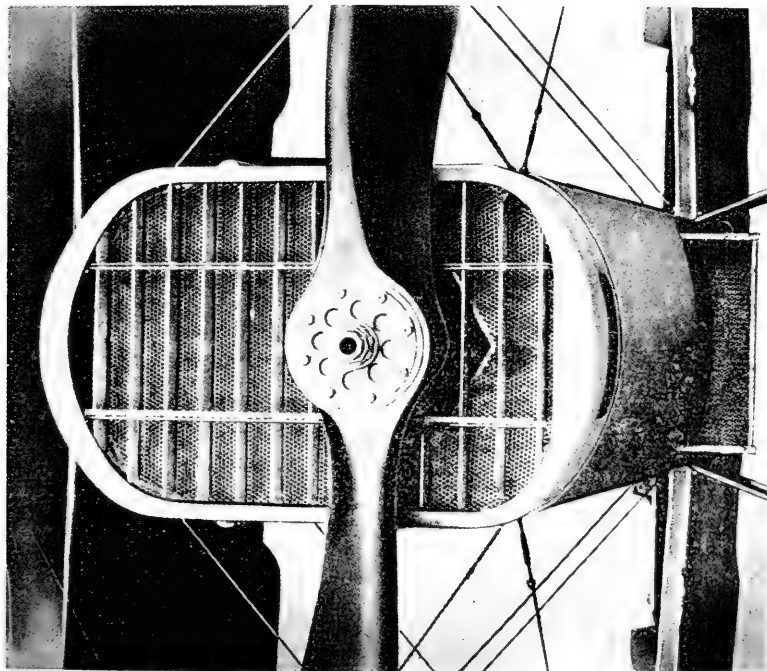

1. Large frontal coolant radiator for Liberty engine on Dell-4 airplane, 1918.



2. Cowling for a current installation of radial engine on a Douglas DC-6.

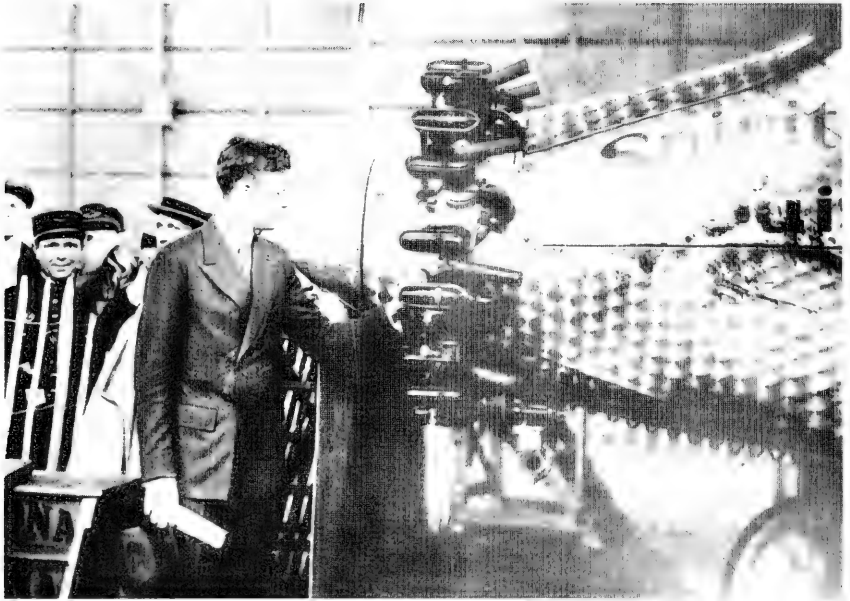

1. Exposed radial engine on Ryan NYP airplane, *Spirit of St. Louis*, with Charles Lindbergh, after landing at Paris, 1927.



2. Cowed radial engine on Lockheed *Air Express*, with Frank Hawks, 1929.



1. Comparison of radiator installations for water (left) and Ethylene Glycol cooling, on Curtiss Falcon airplanes, 1930. (Courtesy Curtiss-Wright Corp.)

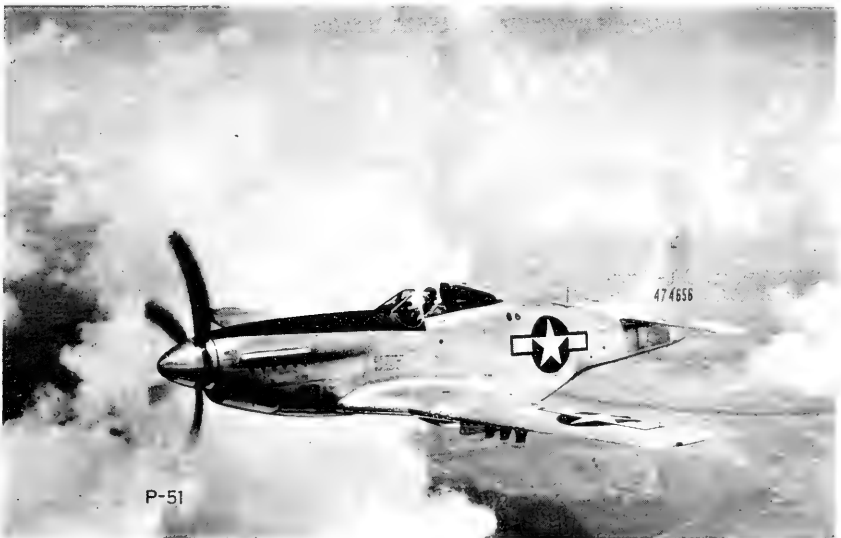

2. Liquid-cooled fighter, North American P-51 *Mustang*, World War II.

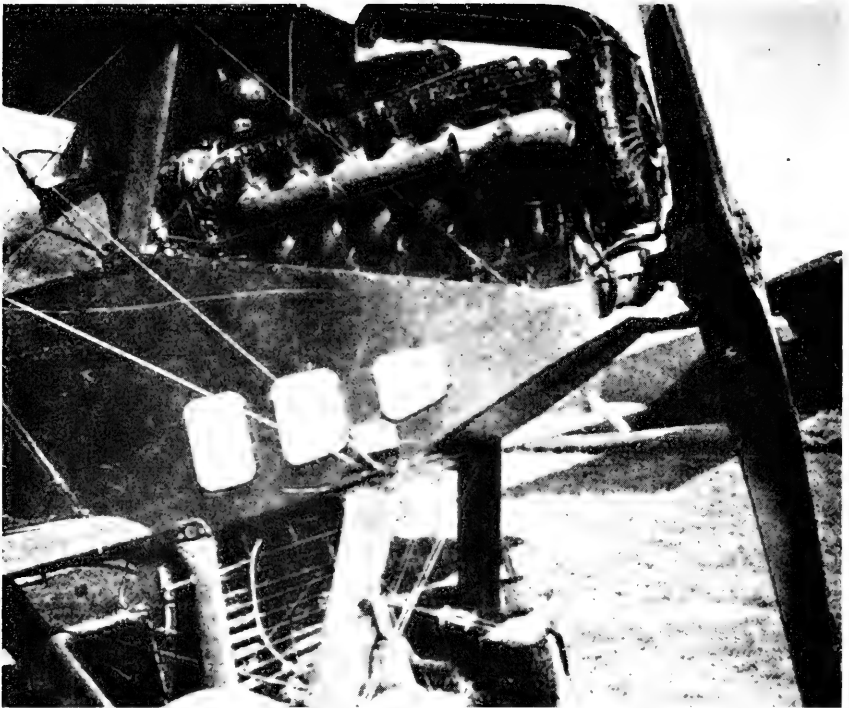

1. General Electric turbo-supercharger on Liberty engine, installed in LePere airplane which held the world altitude record for 1920, 1921, 1922.

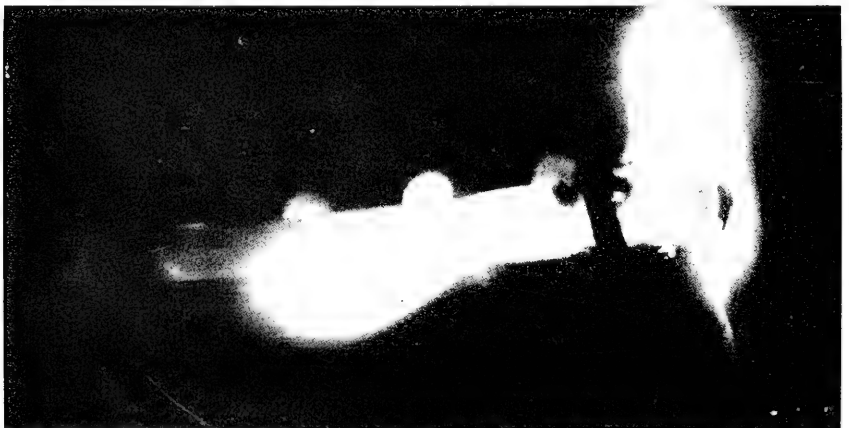

2. Night view of a turbo-supercharger in operation, the same installation as in fig. 1 above. The exhaust manifolds and the nozzle box are white hot from the high temperature of 1500° F., and the turbine is surrounded by hot gases while operating at over 20,000 r.p.m.

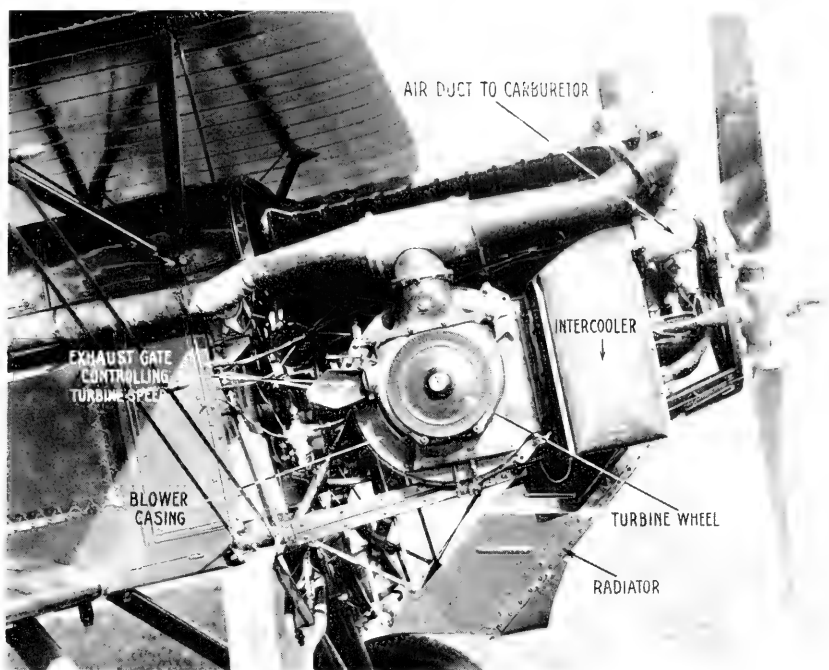

1. Side type turbo-supercharger installation on Curtiss D-12 engine, 460 hp., in Curtiss Falcon airplane, 1931. (Courtesy Materiel Div., U.S. Air Force.)



2. N.A.C.A. Roots type supercharger, coupled to Pratt & Whitney "Wasp" engine in a Wright Aero. Corp. "Apache" airplane. This installation broke the world altitude record in 1927. This was the only successful displacement-type supercharger. A, Supercharger; B, air intake; C, delivery pipe through intercooler D; E, supercharger bypass.

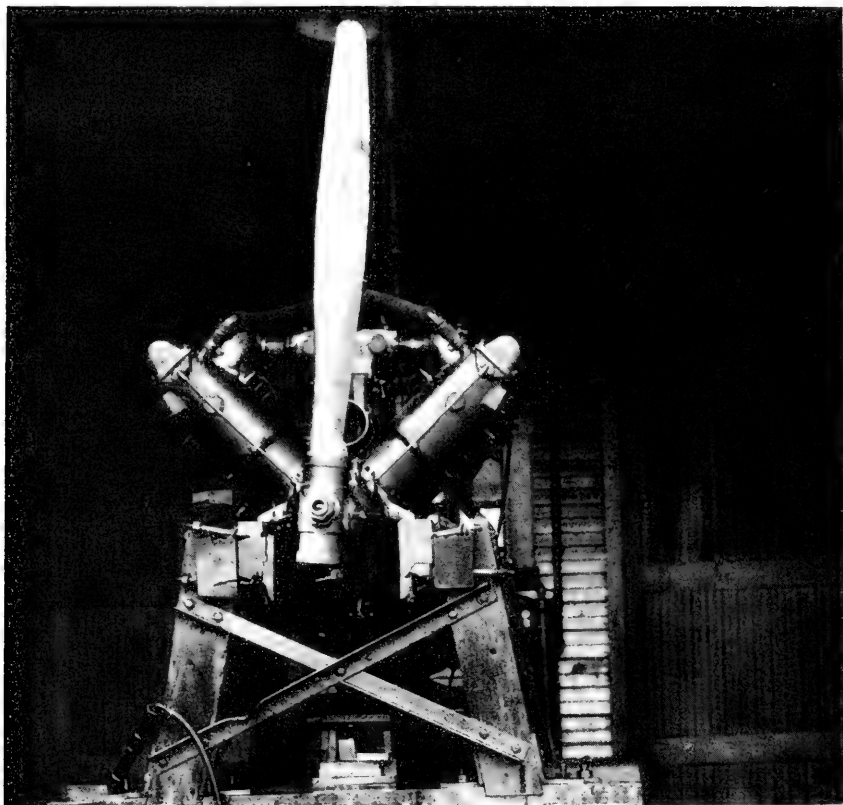

1. Failure of metal propeller tested on Hispano-Suiza 300 hp. engine at McCook Field May 1924. Most similar failures caused more engine damage than is shown here.

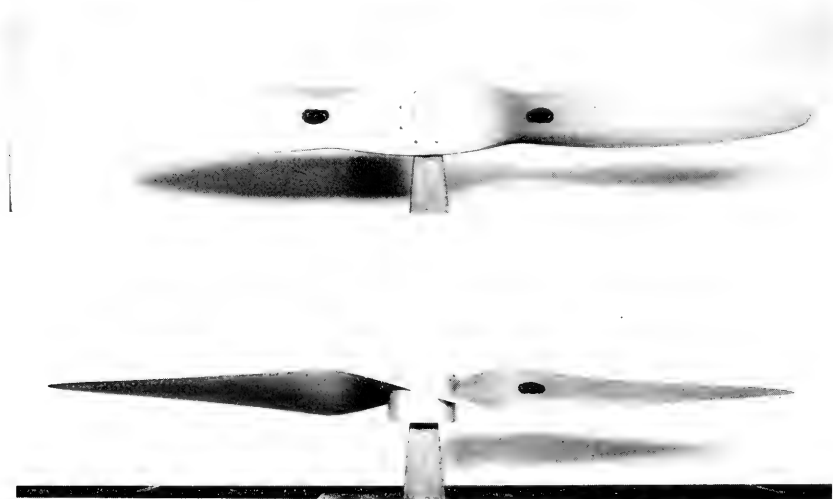

2. Curtiss-Reed twisted-metal propeller, 1925.

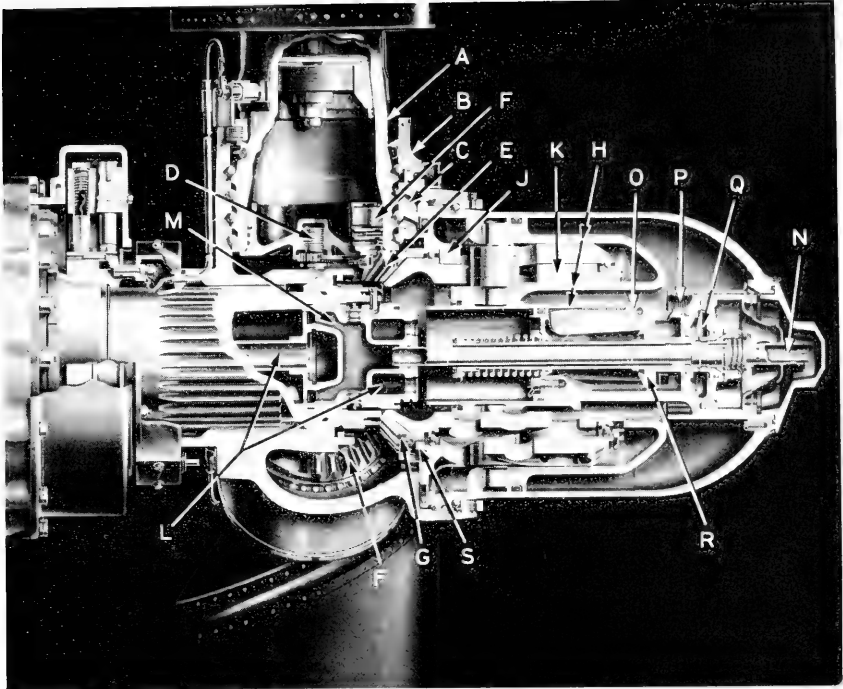

1. Hub of automatic reversible propeller, hydraulic type, 1949. (Courtesy Hamilton-Standard-Propellers.) A, Blade root; B, blade socket; C, holes for bearing-ball insertion; D, preloading screw; E, gear sector; F, splined ring, sector to blade root; G, operating gear, meshed with gear sectors; H, piston that turns operating gear; J, fixed cam; K, moving cam; L, oil passage to rear of piston; M, to front of piston; N, oil tube; O, stop to limit blade angle; P, stop adjusting screw thread; Q, servo piston for reversing blades; R, ring that retracts stop O for reversing; S, reverse stop ring.

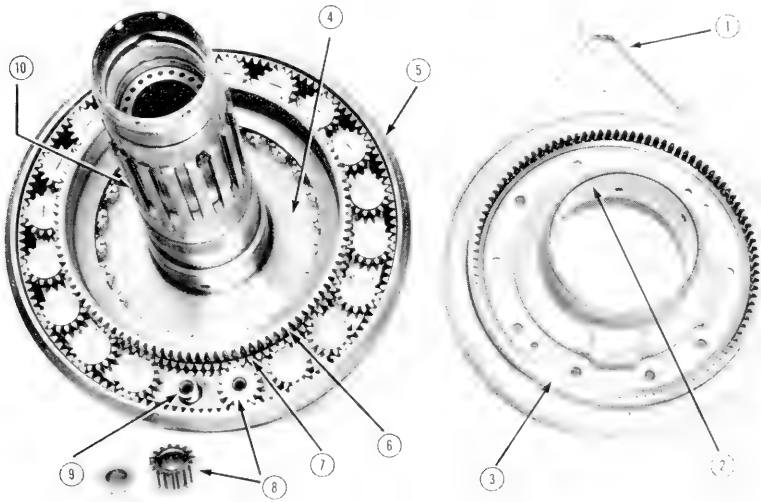

2. Modern planetary spur gear as used on radial engines. (Courtesy Wright Aeronautical Corp.) 1, Torque-meter arm; 2, bearing on propeller shaft; 3, spline for holding sun gear stationary; 4, propeller-shaft disc carrying pinions; 5, ring gear attached to crankshaft; 6, sun-gear spline; 7, sun gear (stationary); 8, pinions; 9, pinion shaft; 10, propeller shaft.

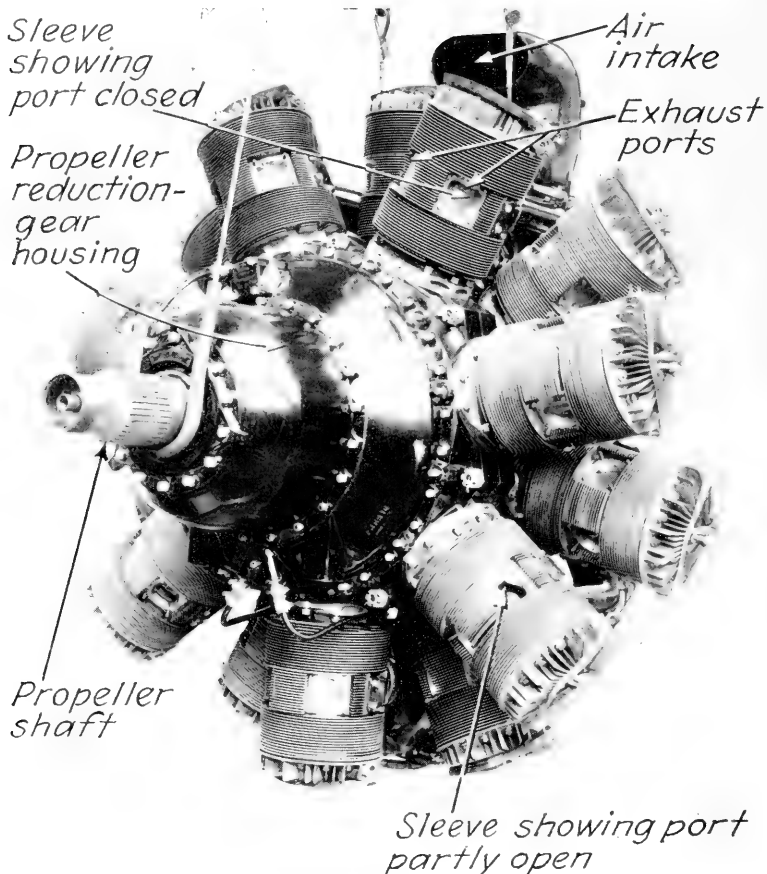

1. Bristol "Hercules" sleeve-valve engine, 14-cyl., radial air-cooled, 1650 hp., 1948. (Courtesy Bristol Aeroplane Co., Ltd.)

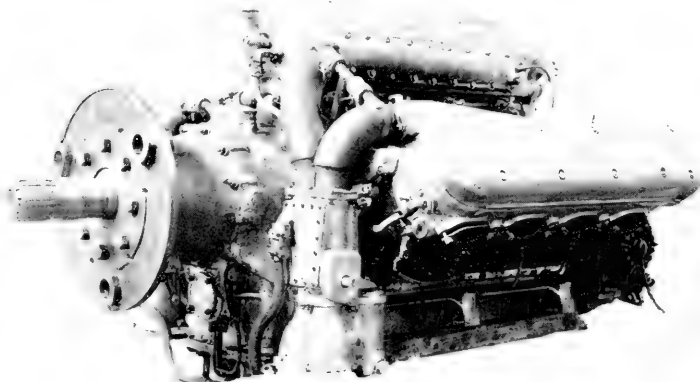

2. Napier "Lion" 12-cyl. "W"-type liquid-cooled engine. The only example of this form ever widely used. Normal rating, 450 hp. A racing version of 800 hp. powered the winner of the Schneider Trophy for seaplane speed in 1927, the Supermarine S-5 which flew at 281.65 m.p.h.

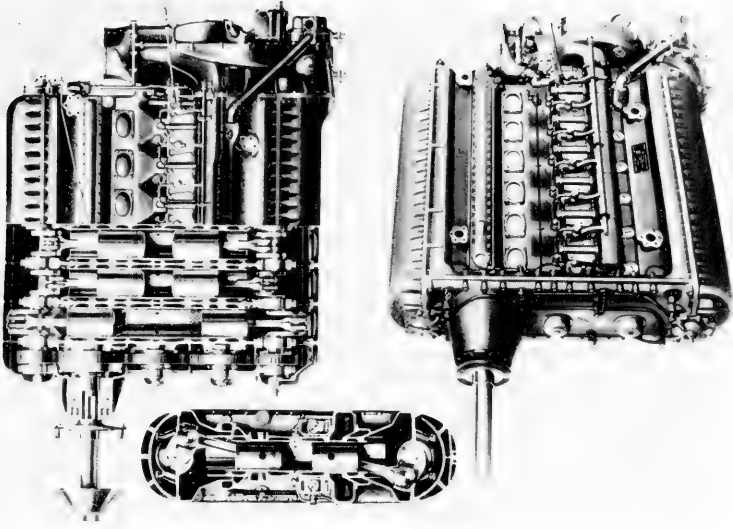

2. Junkers diesel engine.

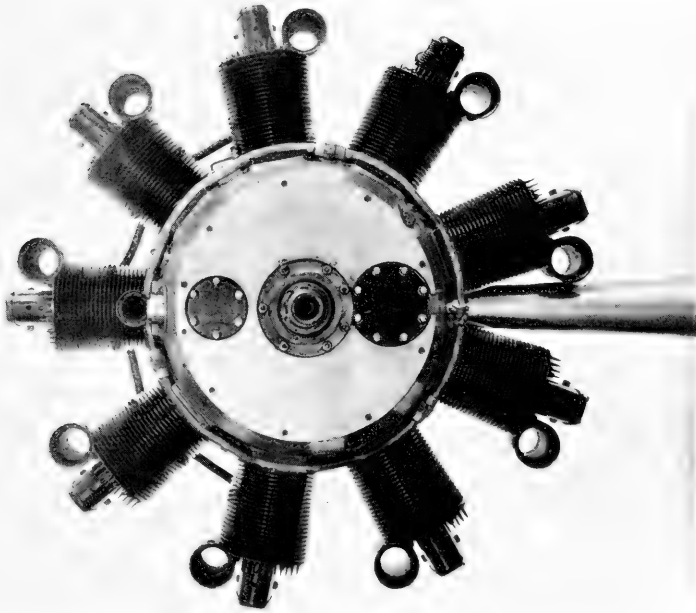

1. Packard diesel engine. This example, first of its type to fly, is in the National Air Museum. Weight 510 pounds, 225 hp.

Rocket Propulsion¹

By RALPH S. COOPER

*Los Alamos Scientific Laboratory
Los Alamos, New Mexico*

[With 1 plate]

IN THE exploration of space, propulsion—the means of getting there—has always been the crucial problem. Inspection of any of our space vehicles shows that the bulk (over 90 percent) of their volume and weight is devoted to the propulsion systems, mainly to the propellant itself. The extent of space exploration in the future will depend primarily upon the sizes and efficiencies of the propulsion systems that will be developed.

One might wonder whether large-scale space operations are economically feasible in terms of their apparently high energy requirements. But in fact, the electrical energy used by a typical American household during 1 month is sufficient to put about 75 pounds into orbit about the earth. The same amount of energy is contained in only 6 gallons (50 pounds) of gasoline plus the oxygen (150 pounds) needed to burn it. Rockets, being far from 100 percent efficient in transferring the energy to the payload, require about 5 to 10 times as much as this, but still the requirements are not unreasonable. Furthermore, atomic nuclei represent a very compact, almost limitless, source of energy if we can find ways to utilize them efficiently.

VELOCITY REQUIREMENTS

Space travel is dynamic in the sense that velocities rather than positions are significant. The important effect of propulsion is to change the vehicle velocity, which then results in an appropriate change in position, and thus one usually expresses the propulsion requirements for various missions in terms of a velocity. For example, the velocity required for a low earth orbit is about 26,000 feet per second (or 18,000 miles per hour). In addition, one must lift the vehicle to some height and overcome certain gravitational and

¹ Reprinted by permission from Bulletin of the Atomic Scientists for March 1962. Copyright 1962 by the Educational Foundation for Nuclear Science, 935 East 60th Street, Chicago 37, Ill.

TABLE 1.—*Mission velocity requirements*

<i>Mission</i>	<i>Velocity, ft./sec.*</i>
Low earth orbit.....	30,000
Earth escape }.....	42,000
Lunar hit }	
High earth orbit }.....	45,000
Lunar orbit }	
Mars, Venus probes }	
Lunar landing.....	50,000
Lunar round trip }.....	60,000
Escape from solar system }	
Mars, Venus round trip.....	60,000 to 90,000

*Including losses.

atmospheric losses (such as aerodynamic drag). These losses are frequently evaluated in terms of velocity and included in the mission requirement. Table 1 gives the approximate requirements for some missions of interest. A lunar round trip has only twice the velocity requirement of orbital missions, and interplanetary trips need only three times orbital velocity. However, this implies that the rockets must be respectively four and nine times as large as the orbital vehicles for the same payload and propulsion system.

ROCKET PRINCIPLES

Almost all types of rockets are based on the principle of action and reaction, and are similar in action to the recoil of a gun or to the motion of a balloon which is rapidly losing its gas. The motion depends upon expelling some material (propellant), be it gas, solid, or charged particles, from the vehicle. Thus rockets carrying their own propellant are able to operate in a vacuum outside the atmosphere, just as a gun's recoil is independent of the air about it. The velocity of the expellant with respect to the vehicle (called the exhaust velocity) is a measure of how effectively the propellant is used, and is comparable to the miles per gallon of an auto engine. The higher the exhaust velocity, the more effectively the propellant is being used, and although this requires more energy per unit mass of propellant, it is advantageous to have high exhaust velocity. Note that the original source of energy does not have to be in the ejected material, although this is true for chemically propelled rockets. In our earlier illustrations, the energy was stored in the gunpowder, not the lead projectile, and in the stretched rubber of the balloon as well as in the compressed gas. The initial gross weight of a rocket for a given payload depends exponentially upon the ratio of the mission velocity requirement and the exhaust velocity, making the results quite sensitive to these quantities. Since the mission velocities are relatively fixed, major reductions of vehicle sizes for given payloads and missions can come only through increasing the exhaust velocity.

The final mass includes the "dead" weight of the rocket (engines, tankage, unused propellant), as well as the payload. For some value of the ratio of velocity requirement to exhaust velocity, the dead weight required for the propulsion system leaves nothing remaining for the payload. This problem is circumvented by jettisoning used portions of the propulsion system, resulting in a number of stages. Usually the tankage and engines of a given stage are dropped when it has exhausted its propellant. Occasionally, as with the Atlas, which drops two of its engines, only portions are released. Staging permits arbitrary mission velocities to be attained, although the payloads may be small. One can find in general an optimum number of stages for a given mission and propulsion system. A high exhaust velocity allows one to use few stages, which results in a simpler, as well as a lighter, vehicle.

CHEMICAL PROPULSION: SOLID PROPELLANTS

Solid propellant rockets are the simplest, and were first historically. They were used in both China and Europe in the 13th century. Used sporadically for centuries, they became very popular in warfare about 1800 ("the rockets' red glare") but were displaced by rifled artillery which was much more accurate. They continued in use in a number of minor applications as well as in warfare where much cheap, light-weight, but inaccurate firepower was acceptable. These "powder" rockets contained black powder and, later, smokeless powder grains loosely packed in their cases, necessitating short burning periods to keep the rockets from bursting because of the high temperature.

During World War II, solid rockets using an asphalt base were developed for assisting airplane takeoffs (JATO units). This propellant could be cast in a single piece but tended to crack or soften with temperature changes. The development of rubber-based propellants after the war, combined with a design which kept the wall cool, opened the way for large solid rocket engines. The propellant is cast in place in a single mass with a central hole. The igniter in this hole ignites the inside surface, and the burning surface moves outward toward the case which remains cool until the propellant is almost completely burned. During the entire burning period, the case must be able to contain the high pressure (hundreds of pounds per square inch) which originates in the hot gases and is transmitted through the rubberlike propellant. Thus lightweight, high-strength materials are an important requirement for solid rockets, which tend to have high dead weights due to the case. The primary requirement for nozzle materials is ability to withstand extremely high temperatures, and for this purpose, inserts of special refractory materials (e.g., graphite or tungsten) are often placed in the nozzle throat.

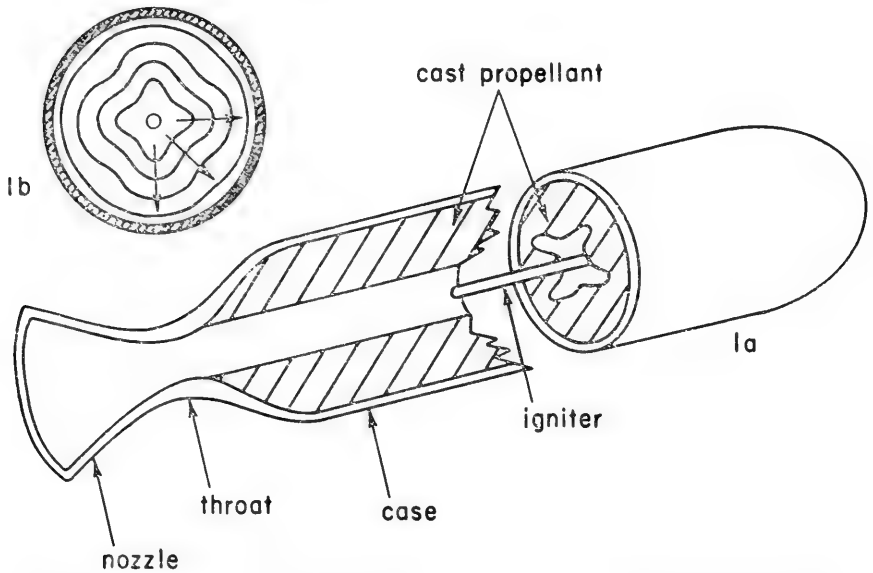

FIGURE 1.—*a*, Typical modern solid propellant rocket; *b*, recession of internal surface with time.

The propellant itself must contain both a fuel and an oxidizer, which supplies the oxygen for the combustion process. Both can be contained in the same molecule (such as nitroglycerine-nitrocellulose) which forms a homogeneous "double base" propellant. For large motors, a rubberlike fuel with small, discrete particles of oxidizer dispersed throughout ("composite" propellant) is more appropriate, since large pieces can be cast in place with little danger of cracking or softening. The exhaust velocity for such materials is in the range of 7,000 to 8,000 feet per second, which is not as good as many liquid propellant combinations. To place a payload in orbit (at a mission velocity requirement of 30,000 feet per second), four solid propellant stages are required, and such a vehicle (Scout) is being developed by NASA. Although it puts less than 1 percent of its initial weight in orbit, it has many of the favorable characteristics of solids—simplicity, ease of handling and launching, relatively low cost, use of various stages for different missions—which commend it to scientific research work with small payloads (about 100 pounds). The ease of scaling up or clustering solid rocket motors has led to their consideration as large boosters. When used as first stages only, their lower performance and higher dead weight are less significant. In very large sizes, the propellant cost (about \$1 per pound) becomes significant, as does the difficulty of handling the large quantities of potentially explosive material.

LIQUID PROPELLANT ROCKETS

In order to achieve higher exhaust velocities, it is necessary to use propellants with combustion products of low molecular weight, and these chemicals are generally liquid or gaseous at room temperatures. The gases (such as oxygen) would require too much volume and weight to be contained in that state, and thus are liquefied and kept at low (cryogenic) temperatures, in contrast to so-called "storable" propellants which are liquid at room temperatures. The first liquid propellant rocket engine was made about 1900, and in the 1920's and 1930's work on them was carried out independently in Germany and in the United States. Little was done in this country except the work of Prof. Robert Goddard.

A variety of applications and propellant combinations were evolved, including an antiaircraft missile using aniline as the fuel and nitric acid as the oxidizer, aircraft rocket engines utilizing alcohol and concentrated hydrogen peroxide, and finally the V-2, an alcohol and liquid oxygen missile. Based on research of the 1930's, its design was begun in 1938, and the first experimental flight was in 1942. Fortunately, internal political squabbles prevented its completion until late in the war. A 3,000-mile range, two-stage missile was being designed for bombarding the American Continent.

With the V-2, rocketry came of age. The Redstone missiles which were used for the U.S. suborbital manned flights were basically scaled-up versions of the V-2, as were early postwar Russian rockets. Long-range rockets with high explosive warheads are poor, expensive, inaccurate weapons, and probably would not have been developed except for the appearance of nuclear weapons, which gave the final impetus that led rapidly to space exploration capability.

The variety of propellant combinations and types of liquid rocket engines rapidly multiplied, and so a brief discussion must select and over-simplify. The propulsion system includes tankage, propellants, pumps to bring propellants to the combustion chamber where they

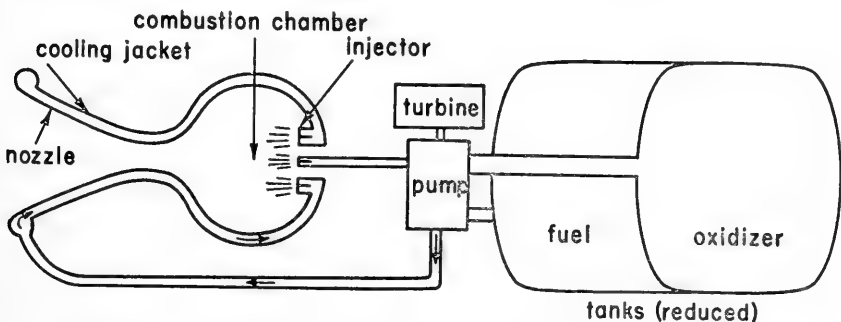

FIGURE 2.—Simplified schematic of a typical liquid propellant rocket.

are burned, and a nozzle to expel the gases efficiently. The fluid propellant can be used before combustion to cool the nozzle and combustion chamber, allowing longer periods of operation than uncooled solid rocket motors. The propellants may be forced into the engine under the pressure of gas in the tanks, but since this requires heavier tankage, for large rockets the propellant is pumped into the combustion chamber. Propellants enter through an "injector" which is similar to a showerhead and serves to disperse and mix the propellants for efficient combustion. The pump, which requires considerable power in large engines, is usually powered by a gas turbine. The turbine may have its own gas generating system or utilize the propellant combustion products to supply its working fluid. The nozzle or entire engine can be swiveled to provide flight control for the vehicle.

The dead weight of a large liquid rocket propulsion system is 5 to 10 percent of the stage gross weight. The most commonly used propellant combinations (for example, "RP," a kerosenelike hydrocarbon, and oxygen) yield exhaust velocities of about 10,000 feet per second, while the use of liquid hydrogen as a fuel yields 14,000 feet per second, which is close to the maximum possible with chemical propulsion. Hydrogen has a very low boiling point and very low density, but its high performance has led to its choice as the fuel for future U.S. spacecraft. For liquid chemical propulsion, two or three stages are optimum for the earth orbit mission, and only a high energy fueled rocket with a light structure can place itself in orbit with only a single stage. The liquid propellants are less expensive than solid fuel, but the engines are more complicated and therefore more expensive to develop and build. At this time, it is not clear whether it will be economically feasible to reduce costs by recovering spent boosters for reuse.

OTHER CHEMICAL SYSTEMS

Naturally many proposals have been made for improving the performance of chemical systems by increasing their exhaust velocity, reducing dead weights or complexity. Specialized systems have been or will be developed for particular purposes, including monopropellants (single chemical liquids which decompose to give hot gas), hybrid solid-liquid rockets, engines with controllable thrust levels for landing. Relatively little improvement can be expected in the exhaust velocity, even with quite exotic propellant combinations, and it is this which primarily determines the performance. Many advances in simplicity, reliability, and structural weight can be expected, but a "breakthrough" in performance of chemical propulsion seems unlikely.

One area where great improvement is possible is in "aerospace" vehicles, which use air-breathing engines (turbojets or ramjets) for

a portion of the boost phase of flight. Since only the fuel need be carried in the vehicle, much greater efficiency is possible in the region up to 10,000 feet per second (7,000 miles per hour) which is one-third of orbital velocity. If sufficiently large, high-speed aircraft engines and airframes could be built, they could be used as flyable, recoverable boosters. In combination with rocket propulsion such "planes" might even be powered into orbit (the so-called "aerospace plane"), although this seems a very formidable task.

NUCLEAR PROPULSION

Nuclear energy can be a very compact type of almost limitless energy, and it is natural to seek some way of utilizing it for space propulsion. Any form of rocket will require some form of propellant to provide the thrust by being expelled from the vehicle, but with a separate energy supply, this could be used much more effectively (i.e., with higher exhaust velocity). There are many methods of nuclear propulsion, with efficiency and complexity generally increasing together. Emphasis here is on those which are closest to becoming a practical reality.

The simplest and most straightforward way of using nuclear power in a rocket is to replace the liquid rocket combustion chamber with a nuclear reactor to supply heat to the propellant. The reactor is an array of solid nuclear fuel elements containing a fissionable fuel. When the reactor is brought to power, the heat generated in its fuel is transferred directly to the liquid propellant which is pumped through the reactor. The liquid is vaporized, heated to a very high temperature, and expelled through a nozzle to provide the thrust. Since the heat energy is supplied by a source independent of the propellant (rather than by the propellant's chemical energy), one has a freer choice of propellant.

By choosing hydrogen, which has the lowest molecular weight, one can readily achieve exhaust velocities of 25,000 to 30,000 feet per second, about twice those of the best chemical propulsion system. This high performance is partially offset by the heavier dead weight (10 to 15 percent necessitated by the reactor and H_2 tankage) and by the complications arising from the nuclear radiation emanating from the reactor. Nevertheless, the high performance is invaluable for missions in the interplanetary class and useful for less ambitious ones.

The nuclear reactor is basically a simple device and its chain reaction can be easily controlled through the movement of neutron-absorbing materials in the core (the fuel-bearing region) or the reflector (an outer layer of material which helps to keep the neutrons from escaping). Since there is no combustion, explosions are unlikely, and the nuclear engine should prove to be quite reliable from

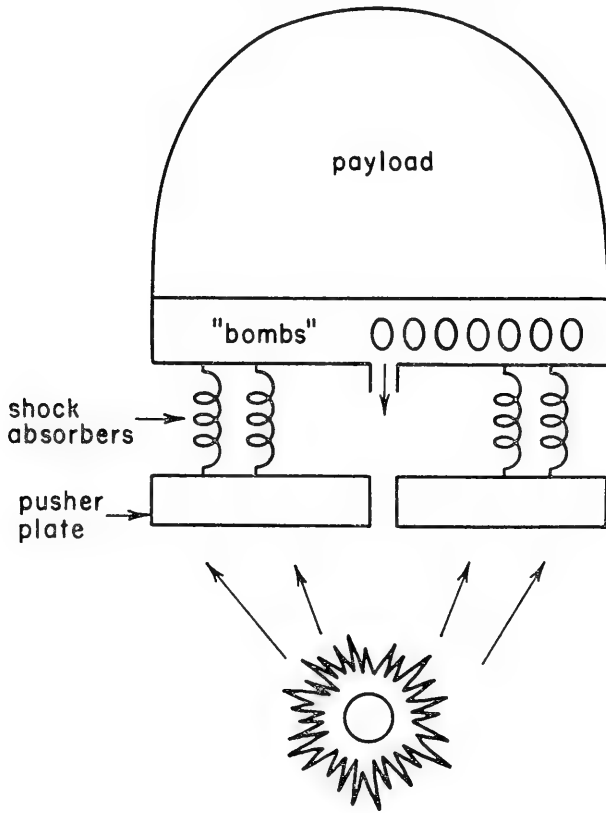

FIGURE 3.—A nuclear explosive-propelled vehicle. The nuclear explosive heats the propellant, which impinges on the "pusher plate," transferring momentum to the vehicle. A set of shock absorbers smooths out the force on the payload.

that standpoint. To obtain the high thrust and high exhaust velocity, the reactor must run at much higher power and temperature than do ordinary power reactors, but this is partially ameliorated by the short lifetime (about 10 minutes) required of rocket reactors. Each cubic foot of the reactor core must generate energy equivalent to the electricity used in many thousands of homes. Furthermore, it must do this while much of the reactor core, several cubic feet and several thousand pounds, is at the temperature of an electric light bulb filament (2,000 to 3,000° C.)! This is far above the melting points of most common materials (such as steel, quartz sand, and most refractory materials) and limits the choice of fuel elements to very few. Graphite (the most familiar), tungsten (used in lamp filaments), and a few metal carbides are about the only candidates. These must contain the fissionable material in a refractory form such as uranium oxide or carbide, which also have high melting points.

The liquid hydrogen presents several difficulties. First, it is only one-fourteenth as dense as water, or most chemical fuels) and thus requires relatively larger and heavier tankage. Secondly, it boils at -423°F. , which is close to absolute zero (-459°F.), and thus requires special insulating and handling techniques. It is cold enough not only to liquefy air, but to freeze it solid. Nevertheless, hydrogen is being used as a liquid fuel in the chemical rocket program, and techniques are being developed which should make its use routine.

The nuclear radiation presents a number of problems, but these can be met with straightforward solutions in most cases. It has been shown that even with regular launchings in the atmosphere, the worldwide contamination would be negligible. Hazards for manned operations must be minimized, but the problems may not be very different from those associated with chemical propulsion. Manned space flight may require extensive shielding against space radiation, which will be effective against the nuclear engine as well.

The exhaust velocity for nuclear propulsion is about equal to the velocity increment needed to achieve earth orbit, and therefore a single nuclear stage is capable of going into orbit with considerable (about 20 percent) payload. For difficult missions, only about half as many nuclear stages as chemical stages need be used, increasing reliability and decreasing launch costs. Finally, operation in space reduces many of the radiation problems and weight penalties associated with nuclear propulsion (lower thrust, lower weight engines can be used, lighter structured H_2 tanks employed).

ADVANCED PROPULSION SYSTEMS

Since the nuclear heat exchanger engine uses less than 0.1 percent of the fission energy available, we can see that only the beginnings of nuclear propulsion have been touched upon. The problem lies not in obtaining the energy as much as in dealing with the higher temperatures involved when this energy is transferred to the propellant. An additional incentive for seeking temperatures above $3,000^{\circ}\text{C.}$ is the disassociation of the H_2 molecules into H atoms; disassociation occurs over a range of temperatures, which allows much greater storage of energy in the propellant at these temperatures. This could lead to exhaust velocities of up to 50,000 feet per second. There has been hope of making gaseous core reactors, operating at up to $10,000^{\circ}\text{C.}$, but the problem of separating the gaseous fuel from the propellant appears insurmountable if reasonable thrust is desired. One possibility for circumventing the material temperature problem is the use of small nuclear explosions in what might be called an "external combustion engine." The nuclear explosive heats the propellant behind the vehicle. The propellant impinges on a large,

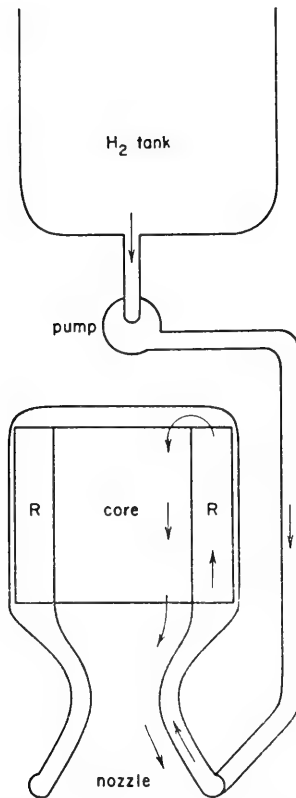

FIGURE 4.—Simplified schematic of a nuclear propulsion system. The H_2 propellant is pumped from the tank, cooling the nozzle and reactor reflector (R), before being heated in the core and expelled through the nozzle.

heavy “pusher plate,” transferring momentum to the plate which is coupled to the rest of the vehicle through a shock-absorbing system. Space ships utilizing such a propulsion system could carry millions of pounds of payload throughout the solar system with quite small nuclear explosives.

There are no workable methods of utilizing nuclear fusion (thermonuclear) energy for space propulsion presently in sight.

There is another class of propulsion devices which will ultimately rely on nuclear energy as the power source and which is best termed “electrical propulsion.” This includes a wide variety of engines which heat and/or, more importantly, accelerate the propellant electrically. By accelerating the propellant directly, one can get it to very high velocities (50,000 to 500,000 ft./sec.) without raising its thermal (random molecular motion) energy. One volt of electrical potential corresponds to 10,000°C. of thermal energy. The propellant can consist of electrically charged ions, fine particles, gases, etc., which are accelerated by electrical or magnetic fields using the same

principles applied in "atom smashers" and television tubes. There are two major problems associated with these engines. First, although their exhaust velocity is very high, they are limited to very small total thrust compared to the weight of the engine and power supply. Thus they can be used only in space where the vehicle is already in orbit and a very small acceleration (less than one-thousandth that of the earth's gravity) acting over a long period (months or years) is acceptable. Secondly, the long period of operation has several unfortunate consequences. Electrical power sources must be available which are very light in weight and capable of operating many months to several years with little or no attention. This leads to a small nuclear reactor as the only energy source with either a turbine-generator or a thermoelectric system to convert the reactor's heat to electricity. The latter, with no moving parts, would be preferable for a long-lived operation. For electrical propulsion, the power/weight of the energy source is the measure of performance rather than the exhaust velocity. The long period of thrust and low acceleration also implies long periods spent in the radiation belts and in transit to planets, which is undesirable for manned flight. Nevertheless, the high exhaust velocity makes this form of propulsion attractive for very high velocity missions such as exploration of the solar system with probes or manned vehicles. Both the engines and the power sources (which are the crucial components) are being developed.

There are other low-thrust propulsion systems which may be of interest for scientific payloads. One type would use solar energy to heat hydrogen with a plastic mirror system replacing the reactor as the energy source. The weight of aluminized plastic film and the relatively low energy rate in solar radiation limit this to low thrust/weight ratios. A very intriguing propulsion technique, based on the momentum carried by solar radiation, has been called "solar sailing." Here a very large aluminized plastic sail is used to catch and reflect sunshine much as ship sails catch the wind. The accelerations are small, but significant as has been shown by the effects of the sun upon the large Echo balloon satellite, which also demonstrated that present materials could withstand the space environment for long periods. Note also that the "propellant" is composed of particles of light ("photons") supplied by the sun and thus the solar sail need not carry any propellant or ever need refueling.

PERFORMANCE COMPARISON

There is as much variety in space propulsion as in surface transportation, and consequently there are varied performance levels and areas of application. The method of propulsion used in practice is dependent upon availability, cost, and other criteria, as well as performance simply on a gross weight basis. Table 2 gives approximate

TABLE 2.—*High-thrust propulsion system parameters*

	Solid	Liquid RP-O ₂	High energy H ₂ -O ₂	Nuclear H ₂
Exhaust velocity, ft./sec.-----	8, 000	10, 000	13, 500	27, 000
Percent dead weight-----	8	5	7	15

representative parameters for four propulsion systems currently under development. The gross weights of vehicles to send a 10,000-pound payload on various missions are given in table 3. A 10,000-pound payload was chosen for consistency and as a reasonable manned vehicle size, although the more difficult missions may require greater payload for radiation shielding and life support systems. Results are scalable to other payloads. The necessity for staging leads logically to the use of early, low-power versions of advanced propulsion systems in upper stages resulting in hybrid vehicles with intermediate performance. Each replacement of a chemical by a nuclear stage leads to reductions of two and one-half in vehicle gross weight as can be seen in table 4 for the lunar mission. Thus the booster size can be reduced and the payload increased considerably with nuclear upper stages. For manned vehicles, a chemical last stage would be desirable to act as an escape vehicle, and for the shielding its propellant would provide.

There are no unclassified performance figures available for the nuclear explosion scheme, and low-thrust nuclear-electric propulsion performance depends crucially on the specific weight of the power plant. If the desired values can be achieved, orbital start electric spacecraft could carry about one-third of their gross weight as payload on interplanetary round trips.

To summarize the situation, most of these propulsion systems can be used exclusively for any vehicle, but combinations will be used which reflect their attributes and state of the art. Liquid propellant rockets will be the most used of the 1960's, with high-energy propel-

TABLE 3.—*Performance of high-thrust systems*

Mission	Vehicle gross weight for a 10,000-pound payload				
	ΔV , ft./sec.	Solid	O ₂ -RP	H ₂ -O ₂	Nuclear H ₂
Earth orbit-----	30, 000	780, 000	280, 000	130, 000	43, 000
Lunar round trip--	60, 000	60, 000, 000	8, 000, 000	1, 700, 000	190, 000
Martian round trip-----	90, 000	-----	-----	22, 000, 000	800, 000

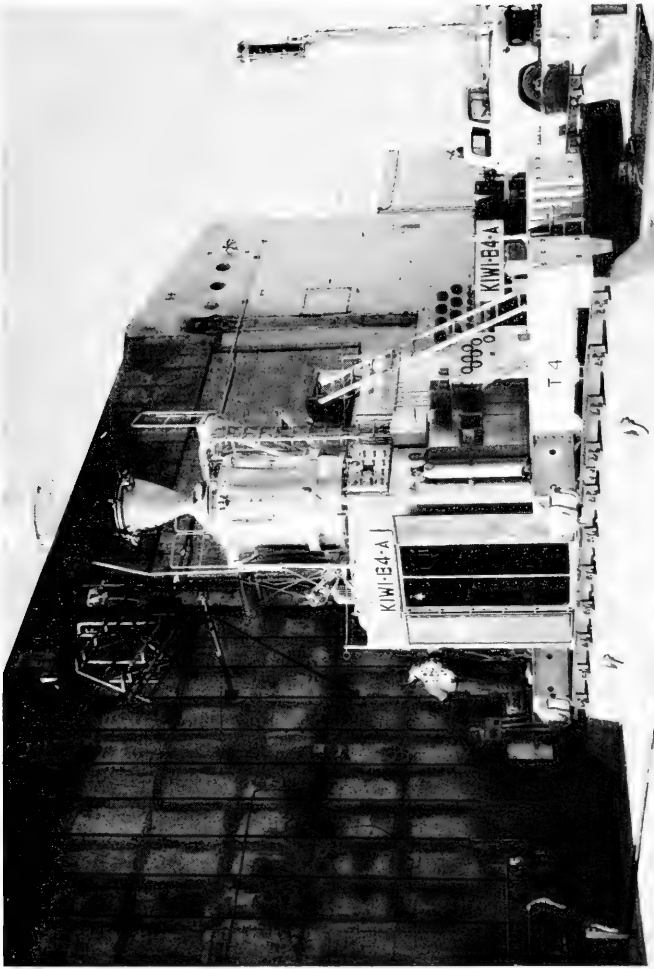

Kiwi B4-A, one of the nuclear rocket reactors being prepared for testing at the Nevada Test Site.
(Courtesy of the Los Alamos Scientific Laboratory.)

TABLE 4.—*Vehicles for a lunar mission—55,000 pounds landed on the lunar surface*

Vehicle	All chemical 4 stages	3 chemical 1 nuclear (3d stage)	1 chemical 2 nuclear upper stages	All nuclear 2 stages
Vehicle gross wt/lbs.....	10, 000, 000	4, 000, 000	1, 700, 000	860, 000
Vehicle dead wt.....	500, 000	220, 000	110, 000	125, 000
Propellant volume, ft. ³	200, 000	100, 000	80, 000	160, 000

lant being used in upper stages. Solid propellant rockets will be used for small final stages (e.g., retro rockets), low total cost, low payload research rockets, and possibly as large, first-stage boosters. Nuclear propulsion will be used in upper stages for difficult missions (lunar and interplanetary). The low-thrust electric propulsion systems will be limited to orbital start interplanetary missions.

AUXILIARY POWER SUPPLIES

Up to the present, electrical power has been supplied to spacecraft mainly by chemical batteries or solar cells. The former are relatively heavy per unit of output, and have short lifetimes. The latter are limited to low powers which will fluctuate with the spacecraft's orientation and position, and are affected by radiation. Some of these difficulties are relieved by using the two in conjunction, allowing the solar cells periodically to charge the batteries, which supply continuous power. Nuclear energy represents a way to circumvent the lifetime and power limitations. One method, which has already been put into practice, is to use the heat generated by radioactive isotopes to supply energy to thermoelectric generators. These convert heat into electricity in the same manner as do temperature-measuring thermocouples. Radioisotope sources are somewhat limited in power (several hundred watts) but can have lifetimes ranging from 100 days to 100 years or more in practice, depending upon the isotope chosen.

For high powers (kilowatts) and long times (years) nuclear reactors are the only practical source. A nuclear electric power supply must include power conversion equipment, radiators to reject unusable heat, and possibly some shielding, as well as the reactor. This leads to system weights of the order of 1,000 pounds, useful only in large payloads. At present, only rotating electric generators are sufficiently developed to handle the high power. These will have a metal vapor (such as mercury) heated by the reactor, to power a turbine which drives a generator. The vapor is condensed and cooled in the radiator to complete the cycle. Eventually, high-power thermoelectric conversion systems will be developed with lower weight, higher efficiency, fewer moving parts, and greater reliability than the turbo-generator system.

STATE OF THE ART AND PROSPECTS

In 1962 most large space boosters used liquid propellants with exhaust velocities of less than 10,000 feet per second. Our largest operational vehicle, the Atlas-Agena, can place over 5,000 pounds in orbit compared to 14,000 pounds for the Russian vehicle, which is therefore probably a similar system of two or three times the size of the Atlas. A high-energy liquid propellant (hydrogen-oxygen) upper stage (Centaur) is being developed for the Atlas which will double the orbital payload and allow sending appreciable payloads to the moon and planets. Table 5 presents information about vehicles in use or being developed by the NASA.

TABLE 5.—NASA space vehicles

Vehicle	Payload, lbs.		Type
	Orbit	Escape	
Scout.....	150	-----	Four solid propellant stages.
Thor-Agena B.....	1, 600	-----	Two liquid propellant stages.
Atlas-Agena B.....	5, 000	750	Two liquid propellant stages.
Atlas-Centaur.....	8, 500	2, 500	Centaur uses H ₂ fuel.
Saturn C-1.....	20, 000	5, 000	Interim vehicle.
Saturn C-5.....	200, 000	88, 000	H ₂ -O ₂ upper stages.

Larger engines and vehicles are being developed for the 1960's to implement the manned lunar exploration program. The Saturn C-1 first stage, which had successful flight tests in 1962 uses eight RP-oxygen engines giving a total thrust of 1.3 million pounds. With non-optimum high-energy upper stages it will be able to place 20,000 pounds in orbit. The optimized Saturn C-2, which was to have used this first stage and would have put 50,000 pounds in orbit, has been dropped in favor of a much larger advanced Saturn C-5 vehicle. Its first stage will be powered by five F-1 engines with a thrust of 1.5 million pounds each. This vehicle, with high-energy chemical upper stages, will place 200,000 pounds in orbit, and hopefully be capable of manned lunar missions. Nuclear propulsion will probably be first tested and used in an advanced Saturn upper stage. With experience gained in the military rocket programs the solid propellant rocket groups have been working on larger engines for use as boosters for space vehicles. A vehicle is under development which has two 120-inch-diameter solid rockets strapped in parallel to a Titan missile for space applications with payloads comparable to those of the Saturn C-1.

Thus in the 1960's the advances in the chemical propulsion field will be principally in switching to the high-energy propellants in upper stages and making larger sizes of the present vehicle types. Nuclear propulsion is in the early stages of engine and vehicle development.

Several reactor tests (Kiwi A series) were held in 1959-60, using graphite fuel loaded with enriched uranium and gaseous hydrogen as the propellant. During 1961-62 further tests (Kiwi B series, pl. 1) were held, including the use of liquid hydrogen and components (e.g., pump and nozzle), more appropriate to a flyable engine. Effort is going into a flight test vehicle which will probably be flown in the mid and late 1960's.

Development of various engines and power supplies for electrical propulsion is under way, with plans to test the engines for short flight periods in space in 1962 and 1963, using the Scout solid rocket as a booster and chemical batteries for the power supply. More extensive tests and use will come in the mid-1960's and depend primarily on the nuclear electric power sources. Nuclear explosion propulsion is at an early stage of research, but the scheme has been checked with a 3-foot diameter, 300-pound scale model, using 3-pound high-explosive charges.

We can expect liquid-fuel chemical rockets to be the workhorses in the 1960's, with nuclear upper stages for many missions, and possibly solid propellant first stages. Electric propulsion may be used, starting from orbit, for deep-space missions. Some of the more advanced schemes, such as nuclear explosion propulsion, may come to fruition near the end of the decade.

The Early History of Radar¹

By R. M. PAGE

Director of Research,

U.S. Naval Research Laboratory, Washington, D.C.

[With 4 plates]

TECHNOLOGICAL innovation grows out of contemporary technology, which in turn rests on the research and scientific discoveries of an earlier day. Only when clear distinction is made between innovation, contemporary technology, and contemporary scientific knowledge can lines of interdependence be meaningfully drawn.

The combination of five basic ideas constitutes the innovation which is radar. They are (1) that electromagnetic radiation at high radio frequency be used to detect and locate remote reflecting objects, (2) that the radiation be sent out in pulses of a few microseconds duration, separated by "silent" intervals very many times the pulse duration, (3) that pulses returned from reflecting objects be detected and displayed by receiving equipment located at the point of transmission, (4) that distance be determined by measuring in terms of an independent time standard the time of flight of pulses to "target" and back, and (5) that direction be determined by use of highly directive radio antennas.

We first identify the scientific knowledge underlying these ideas. Faraday and Maxwell had established the theoretical possibility of the electromagnetic field. Hughs had demonstrated its existence at radio frequency. Hertz had demonstrated that radio waves behaved as light waves, obeying the known laws of propagation and reflection. Appleton and Barnett had demonstrated that radio waves could be used in interferometer fashion to determine apparent height of the ionosphere. Their method used phase velocity to measure the difference in length of two propagation paths. Swann and Frayne had suggested and Breit, Tuve, and Taylor had demonstrated that radio waves could be used to measure ionosphere height by observing the relative flight time of pulses of radio transmission. Their method used group

¹ Reprinted by permission from *Proceedings of the Institute of Radio Engineers*, vol. 50, No. 5, May 1962.

velocity to measure the difference in length of two propagation paths. Various experimenters in radio, including Breit and Tuve of the Carnegie Institution, working with ionosphere measurements, engineers of the British Post Office working with short-wave radio, and engineers of the Bell Telephone Laboratories working with television, had observed that aircraft flying near their receivers or transmitters created noticeable disturbances in the radio propagation field. This was regarded merely as interference with their experiments, and otherwise ignored. These constitute the elements of scientific knowledge basic to the idea of radar. Since radar was not in any way an objective in the discovery of these facts, since no problem was recognized for which radar was the proposed solution, and since radar was only one of many technological innovations dependent on these same scientific discoveries, it is not proper to ascribe to any of the named discoverers any responsibility for the origin of radar by virtue of their discoveries.

Our next step is to identify the contemporary technology out of which radar grew. A catalogue of the state of the art in radio engineering in the 1930's would be both tedious and superfluous. Certain elements have a degree of specificity to radar, however, and require special mention. The cathode-ray tube, devised by the German scientist Braun in 1897 and used on an experimental basis in the early 1920's, became generally available as a laboratory tool in the early 1930's. In 1900 Nikola Tesla suggested the use of electromagnetic waves to determine relative position, speed, and course of a moving object. In 1903 Huelsmeyer applied for a patent in Germany on an anti-collision device for ships, based on directive transmission and reception of continuous waves at very short radio wavelengths. Transmitter and receiver were shown on the same ship, but separated as widely as possible. In June 1922 Marconi again suggested the use of radio as an anti-collision device. In 1923 Loewy filed a patent application in the U. S. Patent Office for a radio object detector employing the Fizeau principle. The transmission consisted of chopped CW, with approximately equal intervals on and off. A target would be detected when its reflection coincided with the intervals between transmission. While Loewy's disclosure appears at first to anticipate radar, it fails to meet the requirements for radar, since range indication is ambiguous, and the presence of one target would jam the system for all other targets. Thus it gave no operational advantage over Huelsmeyer, except the possibility of locating transmitter and receiver close together. In 1925 Breit and Tuve proposed a radio pulse method, which they credited originally to Swann and Frayne of the University of Minnesota, for probing the ionosphere. In cooperation with Taylor, Young, and Gebhard of the Naval Research Laboratory the method was used for the first time in that same year. Although this has been said to demonstrate the basic principles of

radar, it fails to meet the radar criteria on several counts. The pulses were much too long, being about half a millisecond. This would blank out the first 50 miles of range. The ratio of pulse spacing to pulse duration was too low, being only four or five, therefore subject to saturation by a very few targets. The receiving equipment was not at the point of transmission, so time of flight of radio pulses to target and back could not be measured in terms of an independent time standard. Only the difference in length of two propagation paths was measured, and direction was not indicated. These deficiencies from the radar viewpoint were imposed by the state of the art in 1925. They detracted nothing from the excellence of the method or the apparatus for probing the ionosphere. In 1930 patent applications were filed by Wolf and Hart for a radio pulse altimeter. The disclosures were based on the technology of the ionosphere probe, and were therefore subject to some of the same limitations. No development of radar apparatus resulted from these disclosures. In November 1933, Hershberger (U.S. Signal Corps) proposed a method essentially similar to that of Loewy and then did some work on microwave generators in a vain attempt to obtain the power required for useful echoes. In 1936 the French liner *Normandie* was equipped with a microwave anti-collision device similar to that of Huelsmeyer.

It is now obvious that contemporary technology contained much that was suggestive of radar. However, none of the art described contained all five elements necessary to radar, and no radar development resulted from any of it. It is therefore inappropriate to trace the development of radar to any of these proposals or related developments.

The first incident that led ultimately to radar was the accidental observation by Taylor and Young in September 1922 that a ship interrupted some experimental high-frequency radio communication across the Potomac when it intercepted the propagation path between transmitter and receiver. Taylor and Young had for many years been employed by the Navy, and were keenly aware of the problem of screening Naval forces from penetration by other ships in darkness and fog. Though the observation was unrelated to their experiment, the application was obvious to them, and they immediately proposed that high-frequency radio transmitters and receivers be installed on destroyers to detect the passage of other ships between any two destroyers in radio contact. Obviously this was not radar. It did not even involve reflection of radio waves, and was in no way related to Marconi's suggestion, as has sometimes been inferred. It is identified with radar here only because Taylor and Young later originated the first radar development project, and this incident started them thinking in terms of detection of moving objects by radio.

The second incident was another accidental observation, this time by Hyland, a colleague of Taylor and Young. During experiments on high-frequency radio direction finding in June 1930, he detected a severe disturbance of the propagation field by an airplane flying overhead. Hyland was also an experienced Navy employee, and was sensitive to the potential threat of military aircraft and the need for warning devices against them. The observation again was unrelated to his experiment, but the application was obvious, and he immediately proposed that high-frequency radio be used for aircraft warning.

On Taylor's recommendation a project was established at the Naval Research Laboratory in January 1931 for "Detection of Enemy Vessels and Aircraft by Radio." Work on this project continued for several years. The "beat" method was employed, in which transmitter and receiver were widely separated and shielded from each other, transmission was CW, and reception observed the fluctuating signals, called "beats," when an airplane flew through the radio propagation field. Detection ranges of 40 miles were obtained in these experiments.

The required wide separation of transmitter and receiver precluded the use of the beat method on ships and limited its usefulness to the protection of large land areas such as cities and military bases. Since this was exclusively the responsibility of the Army, it was proposed in January 1932 that the Army take over the development for its use in that function. Subsequently, Navy interest in the problem lagged until Young suggested to Taylor that the pulse method be tried. Young's proposal combined for the first time all five elements essential to radar. Ultimately, Taylor accepted the proposal and assigned to

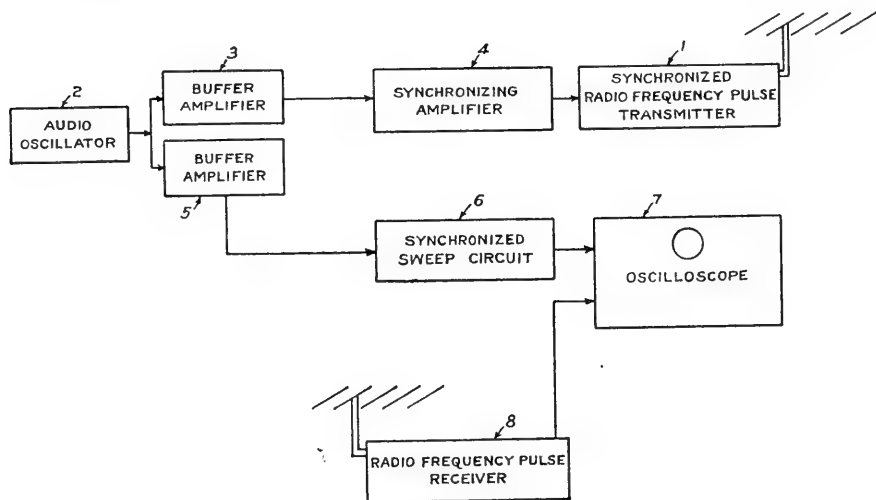
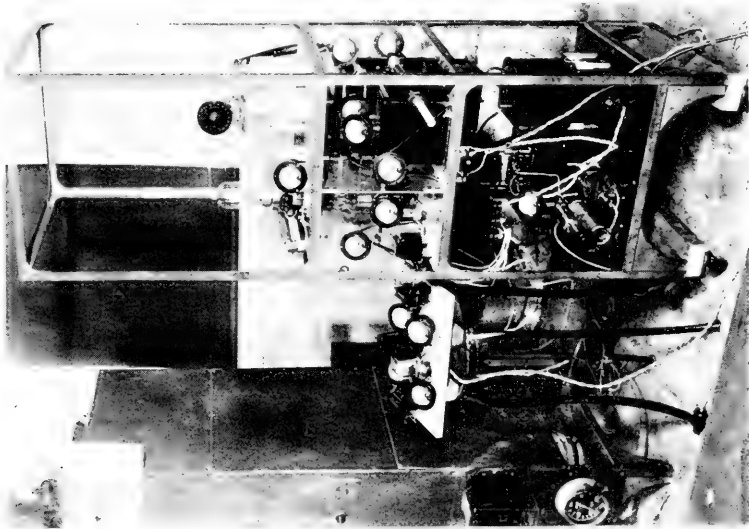

FIGURE 1.—Block diagram of radars operated in 1936. The block diagram for the radar tested in December 1934 was similar to this one.



1. Original 28-Mc radar transmitter with synchronizing keyer. 17,000 v on exposed wires and condensers on top shelf. April 1936.



2. 28-Mc transmitting antenna suspended between 250-foot towers. 1936.

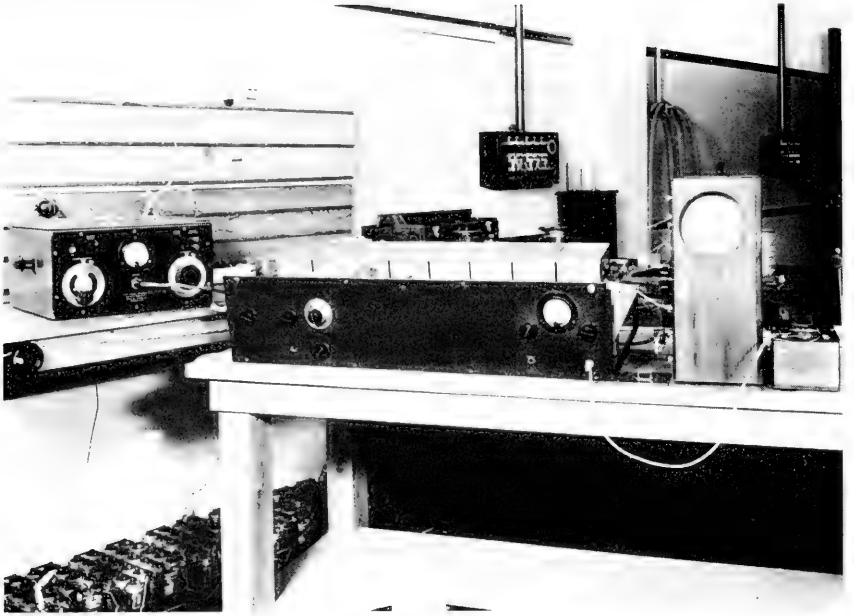

1. Original 28-Mc receiver with indicator on test bench showing (left to right) standard signal generator, receiver, indicator, audio output meter. 1936.

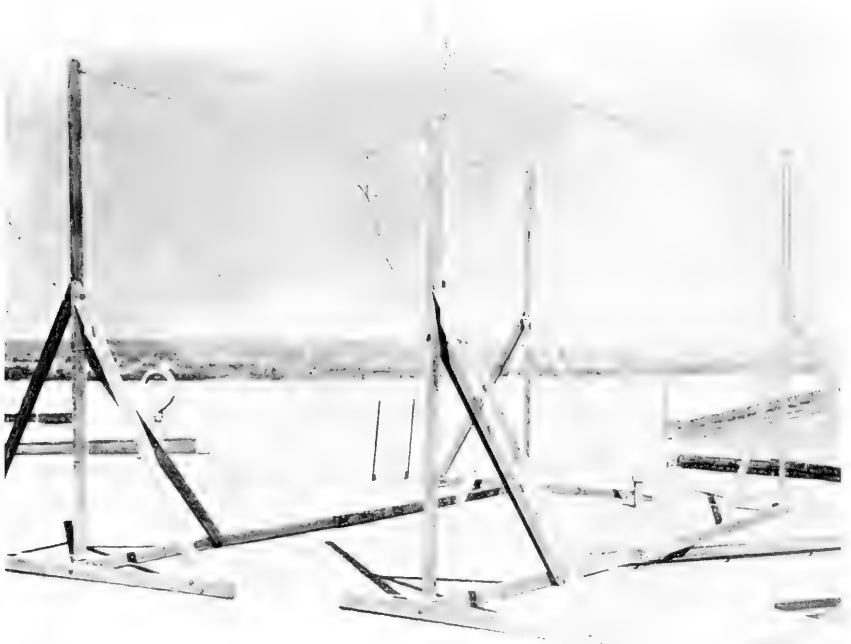

2. Original 28-Mc radar receiving antenna; $\lambda/2$ dipole with $\lambda/2$ reflector. April 1936.

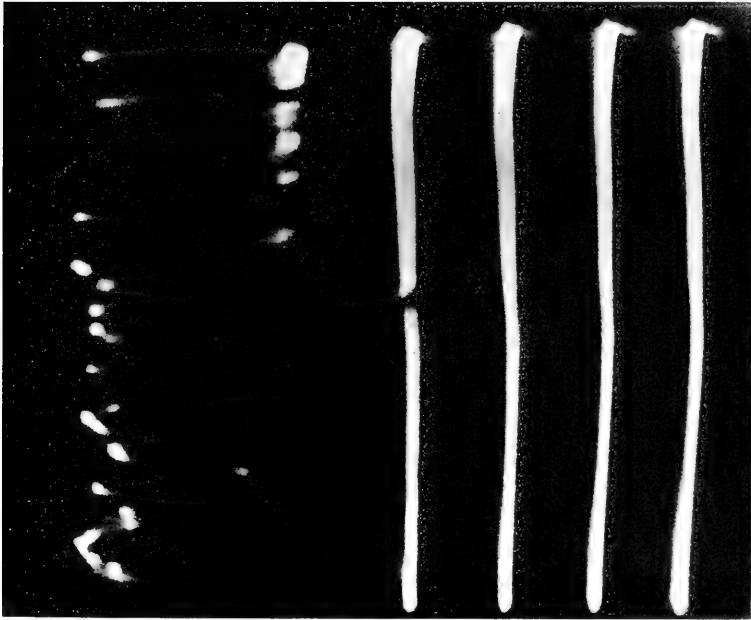

1. Echoes of ground clutter (first line, 10 miles) and airplane (second line, range about 15 miles) with 80-Mc radar installed with duplexer in field house. 5-Line sweep, 10 miles per line—total 50-mile time base. December 1936.

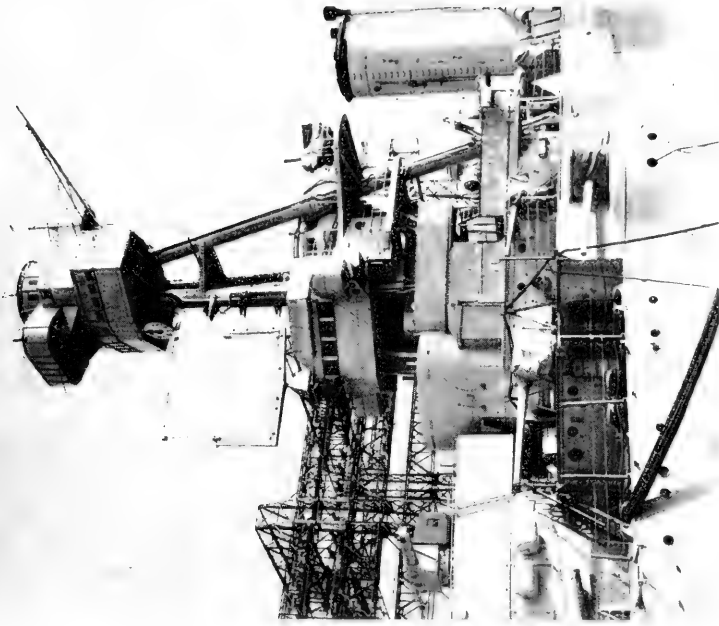

2. XAF antenna installed on USS *New York* at the Norfolk shipyard. December 1938.

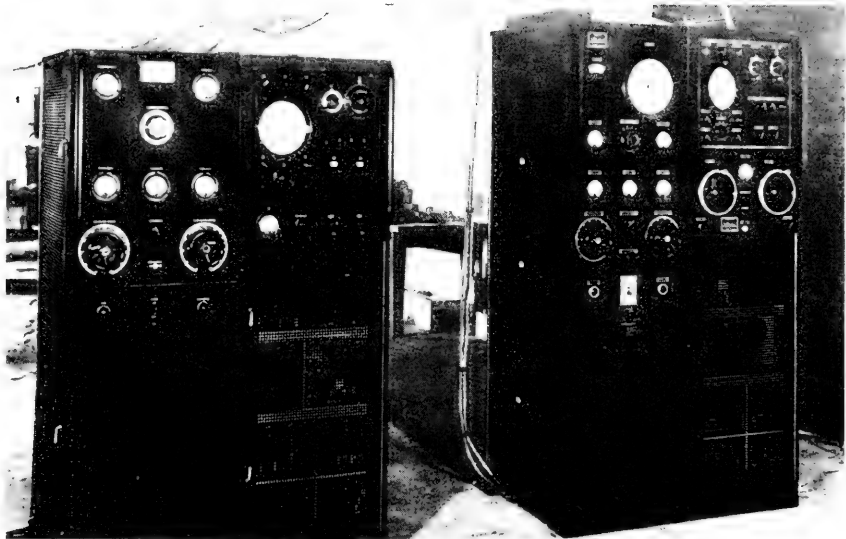

1. The XAF radar (left) and the CXAM radar (right). Summer 1940.

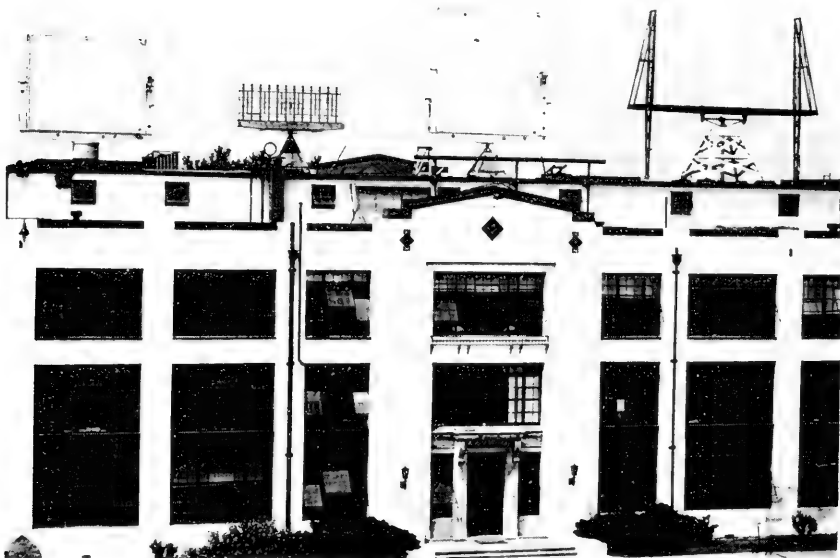

2. Penthouse roof, Bldg. 12, showing (right to left) pre-XAF, XAF, 400-Mc, and CXAM antennas. Pre-XAF is hand driven; all others are motor driven with remote control. Summer 1940.

the author, working under Young's supervision, the task of developing pulse radar. The author's work on this task was started on March 14, 1934.²

The first step was to develop an indicator to display the outputs of transmitter and receiver. A suitable sweep circuit was built for a commercially produced 5-in. cathode-ray oscilloscope. The next step was development of a pulse transmitter. The transmitter frequency of 60 Mc was chosen because that was the frequency then used in the beat method. Pulse length was slightly under 10 μ sec., and pulse spacing, 100 μ sec., these being chosen as appropriate experimental values. The keyer was an asymmetric multivibrator. The antenna was a single half-wave horizontal doublet with a single resonant reflector. The pulse power was estimated to be between 100 and 200 w. The first question to be resolved was whether echo pulse energy could be detected during the intervals between transmitted pulses, since synchronous detection, characteristic of the beat method, was known to be more sensitive than asynchronous detection, characteristic of the pulse method. Autocorrelation and crosscorrelation were unheard of in those days, and the trade-off between time and bandwidth disclosed by Hartley,³ as well as the significance of average energy, was not too well understood. The only sure recourse was to try it, and skepticism was great. A broad-band high-gain experimental communications receiver was borrowed and connected to a second antenna similar to the transmitting antenna. Coupling between the two antennas was appreciable, and the transmitted pulse caused the receiver to ring for 30 to 40 μ sec. However, when a small airplane flew across the beam at a distance of about a mile, the received signal caused the receiver output following the transmitted pulse to fluctuate violently between zero and saturation. This test was completed in December 1934. Although synchronous detection prevailed owing to the transient ringing of the receiver, the great amplitude of the response left no doubt that an asynchronous detector would also have responded to the reflected pulse. The result was accepted as evidence that echo signals could be detected during the intervals between transmitted pulses, and development of a superior radar receiver was immediately undertaken.

Radar imposed four severe requirements on the receiver which were not encountered in conventional receivers of the time. Close proximity of receiver and transmitter subjected the receiver to paralyzing overload, from which recovery to full sensitivity in the incredibly short time of a few microseconds was mandatory. The first design requirement was to eliminate grid blocking. This was achieved by using

² Schooley, A. H., Pulse radar history, Proc. Inst. Radio Eng. (Correspondence), vol. 37, p. 405, April 1949.

³ Hartley, R. V. L., Transmission of information, Bell System Techn. Journ., vol. 7, p. 535, 1928.

a tuned grid circuit with the grid returned to the cathode through the tuning coil. Grid coupling capacitance was then reduced to a minimum by using maximum inductance to capacitance ratio in the tuned circuit, and loading the tuned circuit to the proper Q value with the driving plate resistor.

The second design requirement was to minimize the ring time of tuned circuits from the transmitter-induced high signal level. This was achieved by returning grids to cathodes without bias, thus limiting the level to which the circuits could be driven by the transmitter.

The third requirement was fast response to amplify the short pulse echoes. This meant tailoring the Q values of all tuned circuits so that the composite Q of the receiver would match the pulse length. This was accomplished with the help of the appropriate equation published by Mesny.⁴

The fourth requirement was complete absence of regenerative feedback in the presence of high gain. A communication receiver of that day was considered stable if it did not oscillate. Equivalent Q , however, is a sensitive function of feed-back, and response characteristics are readily altered by feed-back long before the point of oscillation is reached. This requirement was met by using a superheterodyne receiver, limiting voltage gain on any one frequency to one thousand, and changing intermediate frequency as required to accomplish an overall voltage gain on the order of 10^7 . In addition, extreme precautions were taken in shielding, filtering, and common point grounding.

The receiver was intended for a 5- μ sec. pulse. The overall response was 90 percent of steady state in 5 μ sec. This characteristic was independent of gain up to the point where thermal noise at the input filled the cathode-ray screen.

A new transmitter of the self-quenching or "squegging" type was built to go with the new receiver. The transmitting antenna was a 4×4 -wavelength curtain array with resonant reflector. The receiving antenna was a single half-wave doublet with single resonant reflector. The frequency was 28.6 Mc, with pulse length of 5 μ sec. and pulse recurrence rate of 3720/sec., giving a range scale of 25 statute miles. The system went on the air in April 1936. The receiver recovery to full sensitivity following the transmitted pulse appeared to be instantaneous. Beautifully sharp echoes from aircraft were observed almost at once, and within a few days they appeared all the way to the 25-mile limit of the indicator.

The spectacular success of the experiment was followed by a greatly intensified effort. A primary objective was to reduce the size of the equipment so it could be used on ships. The 28.6-Mc antenna was

⁴ Mesny, R., Time constants, build-up time and decrements. *l'Onde Elec.*, vol. 13, pp. 237-243, June 1934.

about 200 feet square. Reduction in directivity of antenna pattern was not desired. A smaller antenna therefore meant higher frequency. On July 22, 1936, a small radar was put in operation on 200 Mc. In that same month the first radar duplexer was successfully tested, also on 200 Mc, enabling both transmitter and receiver to use the same antenna. These two quick developments made it possible to put radar on a ship for tests at sea. The first seagoing radar tests were made in April 1937, on the U.S.S. *Leary*, an old destroyer of the Atlantic Fleet. The success of these tests led to the development of the model XAF, designed for Naval service at sea. Extensive tests on the U.S.S. *New York* in 1939 disclosed operational values beyond all dreams. The XAF was made prototype for the model CXAM, which was in service on 19 ships, the only U.S. Naval radar in service on December 7, 1941. It made an excellent wartime record.

This is a brief outline of the main stream in the early development of radar, resting on a sequence of related events from 1922 to 1941. Up to the summer of 1935 it was a single stream. At that time two other streams started, both remarkably parallel to the main stream. The one in England, sparked by the proposal of Watson-Watt in February 1935, and conducted under the aegis of the Royal Air Force, was completely independent of the American developments until 1940, at which time the two countries pooled their resources. In the technological trade, America gained the uniquely British cavity magnetron, and Britain gained the uniquely American duplexer. The trade was not as one-sided as may have been inferred in some of the postwar literature. The pooled resources formed the technological capital for the newly formed National Defense Research Committee in the superb development of microwave radar by the Radiation Laboratory of the Massachusetts Institute of Technology. The other stream, in the U.S. Army Signal Corps, sparked by the dynamic leadership of Col. Roger B. Colton, was independent in part, but received much stimulation, both competitive and cooperative, from the more advanced work of the U.S. Naval Research Laboratory. It is one of the most remarkable coincidences in history that the three streams of radar development, operating more or less independently, issued in three vital but nonoverlapping employments, each requiring basically different designs. At the war's beginning the finest mobile ground-based radar came from the U.S. Army Signal Corps, the finest airborne radar came from the Royal Air Force, and the finest Naval radar came from the U.S. Navy.

Modern Glass¹

By S. DONALD STOOKEY

Corning Glass Works, Corning, N.Y.

[With 3 plates]

A NEW world is suddenly unfolding to the startled glass technologist as he gazes into his 6,000-year-old crystal ball. As his eyes gradually adjust to seeing in molecular detail the familiar transparent solid turns out to hold a frozen mass of hidden fairy-tale princesses, powerful sleeping giants and unknown creatures of all kinds, condensed to molecular size and trapped in an unexplored labyrinth; each waiting to be brought to life by the proper magic word.

In more practical language, we are learning that glass consists literally of chemical species in a frozen state of suspended animation, somewhat as free radicals are trapped by freezing them. By using the proper catalyst—which may be high-energy radiation or internally precipitated colloids or heat, or a combination of these—a really astonishing variety of electronic, chemical, and physical changes can be initiated and controlled, resulting in a multitude of new materials. Some of the current discoveries are completely reversing traditional concepts. For example:

Glass strengthening techniques now in the laboratory may soon change our traditional concept of glass as fragile and brittle to one that's strong and flexible.

Long known as an electrical insulator, glass in some of its new forms becomes an electronic conductor.

Distinguished from most other solids by its noncrystalline amorphous structure, glass now is found to be a perfect medium for *controlled* crystallization, and has become the spawning ground for a growing number of unique new crystalline materials—as shown in plate 1, for example.

Famous for its impermeability to liquids and gases, high silica glass has been found to be selectively permeable to the smallest gas molecules such as helium, neon, and hydrogen; it can be used as a molecular sieve.

¹ Reprinted by permission from *International Science and Technology*, No. 7, July 1962.

Although it is a completely rigid nonreactive material below its annealing temperature of 500 to 600 degrees, yet glass permits rapid diffusion and exchange of certain monovalent ions such as those of silver, copper, sodium, lithium, and potassium, well below the annealing temperature.

THE NATURE OF GLASS

Let's start our more detailed description of the newly evolving technology of glass by discussing our present concepts of its chemical and physical nature. Immediately it becomes necessary to say that no two experts agree on the subject of the molecular structure of glass. For example, the proceedings of the most recent All-Russia Glass Congress report that the main emphasis of Russian glass research for the preceding 5 years was on glass structure. So what you read here should not be taken as a consensus of all glass scientists, or even two of us.

Molten silica is an extremely viscous liquid. It can be visualized as a three-dimensional polymer whose basic structure is a network of tetrahedral silicon dioxide molecules, figure 1, joined to one another by oxygen bonds at the corners in random manner. Figure 2 shows this random network in two dimensions; in the molten state, the chemical bonds are continually breaking and re-forming. This molten glass is a universal solvent, capable of incorporating almost every chemical element in its structure. Some elements can replace silica and become part of the network; but most (for example, sodium and calcium) become an ionic plasma moving through holes in the

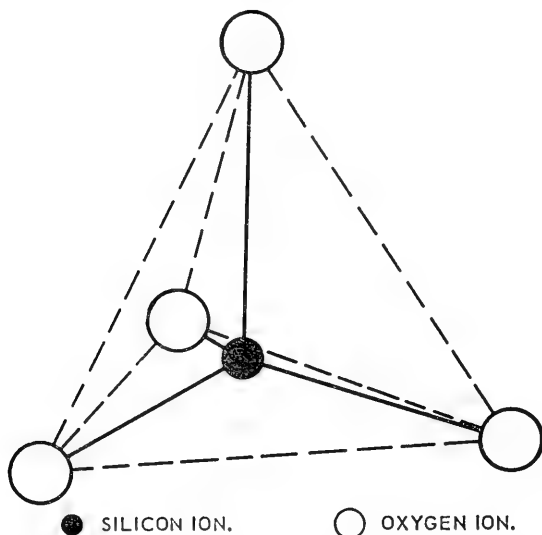

FIGURE 1.—The silica tetrahedron, basic ingredient in glass, has four ions of oxygen, one of silicon.

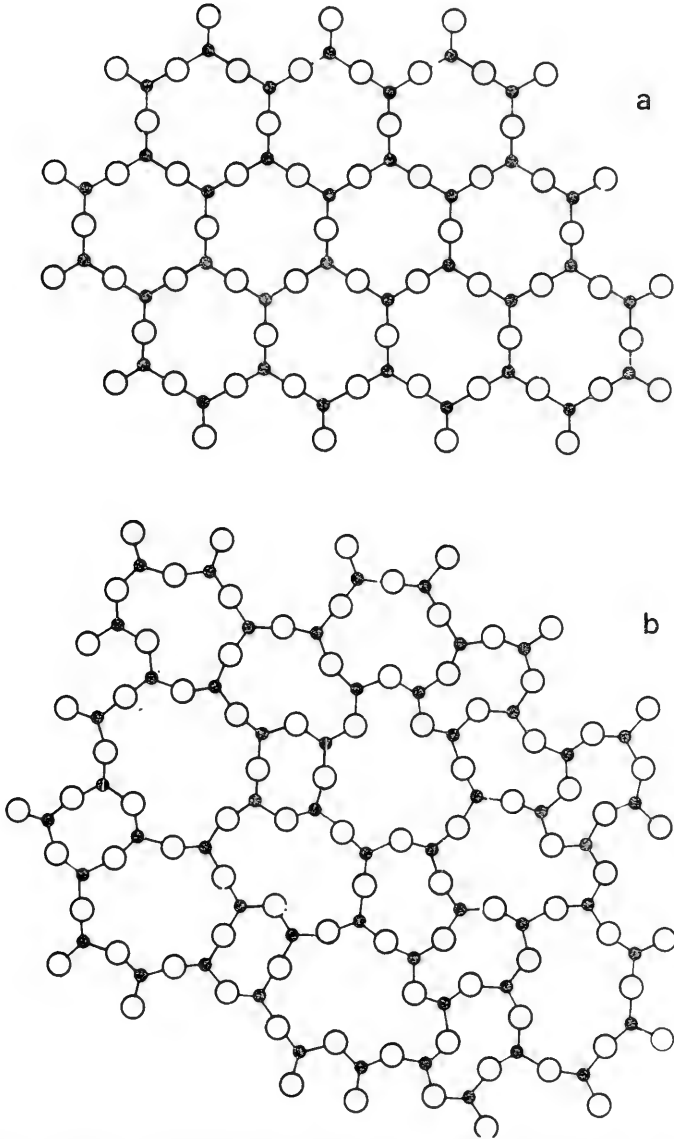

FIGURE 2.—Schematic two-dimensional representation according to Zachariasen of structures of SiO_2 network former: *a*, crystal; *b*, glass.

polymer network, loosely bonded to the silica through oxygen bonds, as shown in figure 3. We can picture the sodium ions as high-temperature fish swimming through a three-dimensional net whose meshes become gradually more rigid and smaller in size as the material cools. Such “network modifiers” greatly increase the high-temperature fluidity by breaking some of the silicon-oxygen bonds.

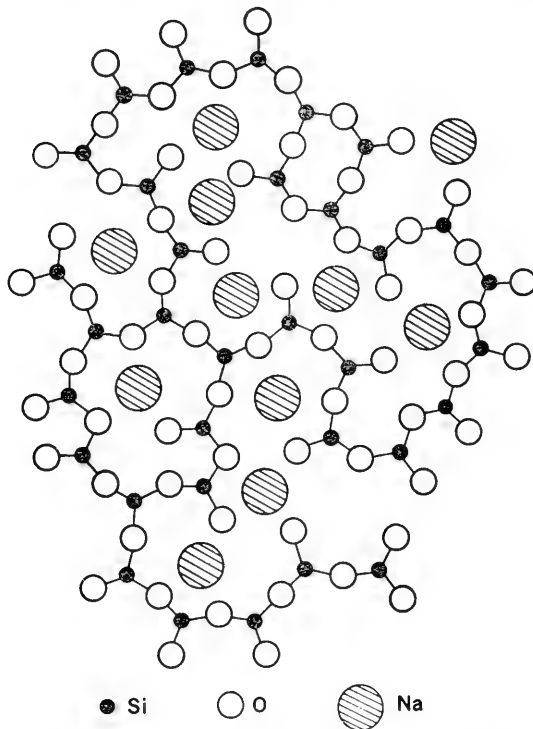
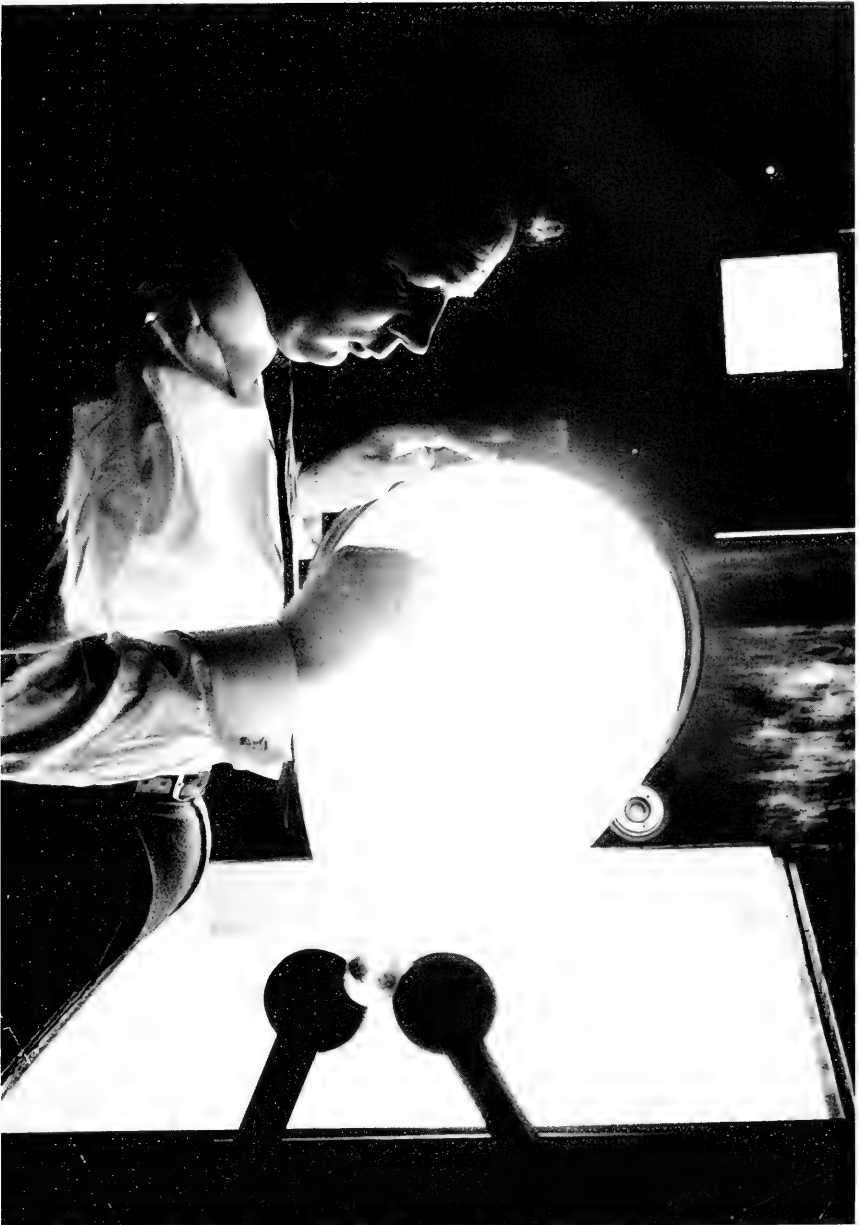

FIGURE 3.—Schematic two dimensional representation according to Warren of the structure of soda-silicate glass. The silicons are here shown to be bonded to only three oxygens.

As the molten glass cools, the network becomes more and more rigid until, usually at 400° to 600° C., it is completely solid. The plasma, however, usually does not “freeze” at such a high temperature as the network, so that at temperatures where the glass is completely rigid, diffusion and chemical reaction can still occur among the modifier ions. At still lower temperatures, but still above room temperature, the plasma also freezes so that no translational motion of molecules or ions can occur. At room temperature, high-energy ionizing radiation can produce electronic transitions, but not molecular rearrangements.

We can see then that the simplest glasses, except for one-component glasses like plain fused silica, are molecular two-phase systems although they are amorphous by any macroscopic or microscopic observation. In more complex glasses such as the alkali borosilicates, two interpenetrating polymer networks can be present, one containing mostly silica, the other mostly boric oxide. At low temperatures these two networks tend to separate into really discrete phases, so that submicroscopic channels or droplets of alkali borate glass are present in a silica matrix. This behavior is the basis of high-silica glass, which is made by heat treating a special alkali borosilicate



One of the new glasses that can be changed to crystallized glass-ceramic. Here it is shaped into a missile nose cone. In its transparent glassy state, undergoing inspection at right, it is ready for heat treatment to form millions of tiny nuclei and cause crystals to grow on these centers. The matured glass-ceramic has great resistance to erosion and thermal stress.

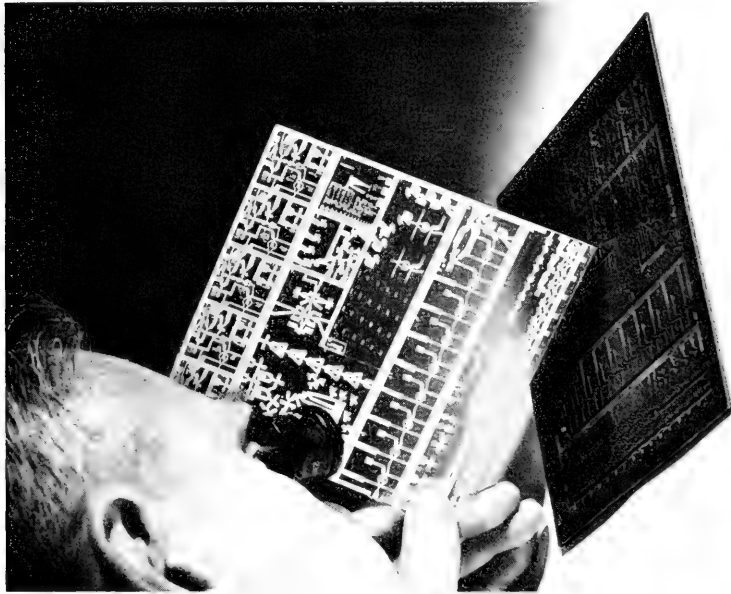

1. In a photosensitive glass, detailed patterns can be reproduced on exposure to light and heat treatment. Exposed areas dissolve in acid more easily than clear glass, so that pattern—here ports, chambers, and channels for fluid amplifier circuits—can be etched. Lower panel is ceramuned for greater strength.



2. Light-weight mirrors for airborne and satellite-borne telescopes are constructed from fused silica because of its negligible dimensional change with varying temperature.

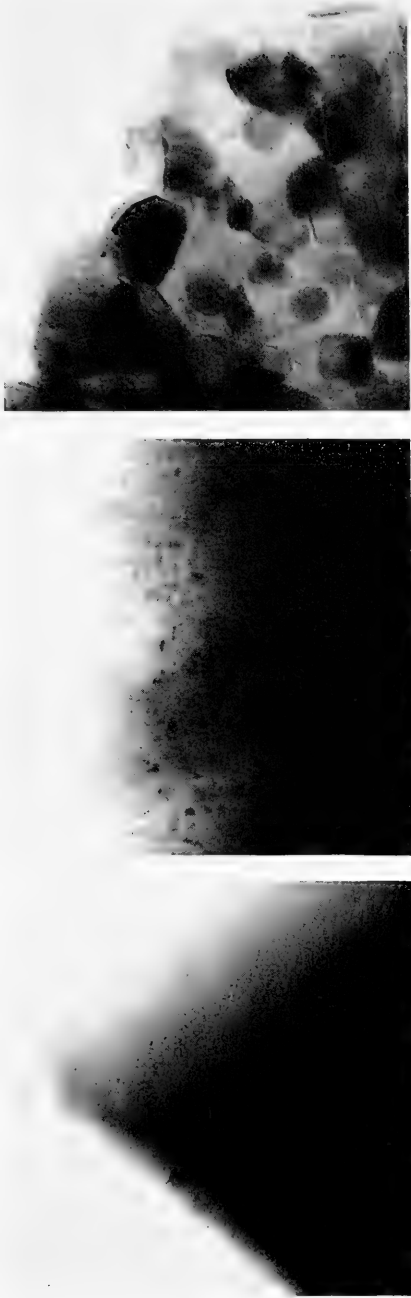

Electron micrographs show conversion of amorphous glass to crystalline glass-ceramic. At left is a flake of essentially amorphous glass containing dissolved nucleating agents. Heat treatment produces nuclei which initiate growth of crystals (100 angstroms across) in center photo. At right, crystallization is almost complete, with crystals now grown to 600 angstroms across. Further treatment coalesces crystals into larger ones. Magnification: 165,000 X.

glass to induce this channel-type phase separation, leaching out the alkali borate with acid, then heating the porous silica skeleton until it shrinks and consolidates as reconstructed 96 percent silica glass.

Such structural complexity is compounded by constituents that may interact in oxidation-reduction pairs or precipitate from solution as crystals. Small wonder that scientists disagree on "a" glass structure, and that few scientists are rash enough to explore this untidy jungle—neither truly liquid nor truly crystalline, but related to both.

Having been one of the foolhardy explorers into this wilderness, and having been invited to elucidate recent developments in glass from a personal point of view, I will take the liberty of emulating Sindbad the Sailor and tell you some of the discoveries in which I have taken part and how they came about.

GLASSES THAT RESPOND TO LIGHT

A good starting point is an early foray of mine into glass research, the purpose of which was to investigate and improve upon the "opal" glasses. These did not turn out to be melted gem stones, as I had first guessed, but opaque or translucent white glasses containing colloidal inclusions, usually crystalline, that scatter light.

Literature survey disclosed, among other things, the recipe of an early German glassmaker calling for ground deer bones to make "bone-ash" opal. Such romantic findings are part of the fascination of research in a medium that has thousands of years of history. (Bone-ash opals, in which calcium phosphate is the insoluble phase, are still manufactured.)

I was soon struck by the apparent similarity between the behavior of certain opal glasses containing sodium fluoride and that reported for the rare and beautiful gold and copper ruby glasses. All these glasses remain clear when they are first cooled, but develop opacity or color by precipitating colloidal particles when they are reheated. Meanwhile, R. H. Dalton of our laboratory had recently discovered that a copper ruby glass, irradiated with ultraviolet light while in its colorless state, developed a darker red color after reheating.

Jumping to the erroneous conclusion that, therefore, similar exposure of a sodium fluoride glass would result in a photosensitive opal, I found that ultraviolet light had no effect whatsoever on this glass.

The answer to this puzzle proved to be that the sodium fluoride precipitation results from a simple supersaturation, with crystal nuclei forming at such low temperatures that the glass must be reheated in order that crystals can grow. The gold and copper rubies, on the other hand, were found to develop their color in a complex sequence of chemical oxidation-reduction reactions, of a temperature-

sensitive type perhaps unique to glass. The metal dissolves as an oxide in the melt, is frozen in an unstable oxidized state as the glass cools, then is slowly reduced to insoluble metal colloid by polyvalent ions in the glass as the glass is reheated at low red heat. Some of the polyvalent reducing agents are oxides of tin, selenium, antimony, and arsenic. Ultraviolet light promotes the reduction of copper, by producing photoelectrons which then combine with copper ions in the glass.

This knowledge made it possible to develop photosensitive copper ruby and gold ruby glasses, which remained colorless even on reheating, except in the areas exposed to ultraviolet light through a photographic negative.

Then it occurred to me that these photographically produced metal crystals, if they were precipitated in a glass supersaturated with sodium fluoride, might trigger the growth of sodium fluoride crystals and give me the photosensitive opal glass I had failed to produce before. This proved to be true; not only could sodium fluoride, but several other kinds of crystals be *nucleated* in three-dimensional photographic patterns. The translucent windows in the north wall of the United Nations Assembly Building are made of photosensitive opal glass with a marble pattern produced in this manner.

A year or so later, in the early days of television, we were confronted with a different practical problem: how to drill a quarter-million small, precise holes through a glass plate, to make an aperture mask? On a long-shot chance, I tested all the photosensitive opal glasses and discovered that the crystallized photographic pattern in one of them, a lithium silicate glass that had been shelved as useless, was much more readily dissolved in hydrofluoric acid than was the surrounding clear glass. Before long we had a plate of glass with a hexagonal array of small holes; and this led to the development of chemically machineable glass. This glass is finding increasing use in the electronics industry because of its capability of being mass-produced in precise complex shapes like those shown in the panels illustrated in plate 2, figure 1.

AN ACCIDENT LEADS TO GLASS CERAMICS

Chance, in the form of a runaway furnace, now took a hand. A plate of photosensitive glass that had been irradiated was accidentally heated to several hundred degrees higher than its usual developing temperature. The plate, which we had expected would melt to a pool of glass, altered instead to a hard, strong crystalline ceramic—the first member of a now rapidly growing family of crystalline ceramics made from glass, the Pyrocerams. This was not an isolated case; my

colleagues and I soon found that the principle of nucleation-controlled crystallization of glass can be very broadly applied. Plate 3 shows three stages in the process of nucleation and crystallization in a glass ceramic.

Meanwhile, a search for materials suitable as radomes for supersonic missiles made for the Navy by the Johns Hopkins Applied Physics Laboratory, singled out some of the new glass-ceramics as being almost unique in meeting the requirements of strength, resistance to supersonic rain erosion and thermal shock, and radar-transmitting properties. This led to pilot production and testing of radomes for the Terrier and Tartar missiles now standard on the missile ships of the Navy. Use of new glass manufacturing methods, developed in continuous-tank production of optical glass, resulted in radomes that can be mass-produced uniformly and not individually tailored to meet the boresight tolerances required for accurate aiming of the missile. One of these is illustrated in plate 1. More and more varieties of radomes, ultrahigh-frequency windows, and antennas are being made of glass-ceramics.

The strength, chemical resistance, and thermal shock resistance of some of the low-expansion glass-ceramics suggested that they could be valuable for domestic use as well as for defense; and we developed the now-popular heat-resistant ceramic utensils for cooking and serving food. A new high-strength glass-ceramic tableware will soon be commercial.

Still newer glass-ceramics are now in the development stage, each tailor-made for a special area of use. One, having exceptionally high dielectric constant, is being developed for capacitors; another, containing crystals of an electronic semiconducting oxide, will be used for high-temperature resistors. And a third variety of glass-ceramics, highly crystalline, contains crystals so small that they do not scatter light, and this glass-ceramic is as transparent as glass. The crystals are beta-eucryptite, a strange mineral which shrinks, instead of expanding as do most crystals, when heated. The resultant glass-ceramic has a negative coefficient of expansion.

STRONGER GLASSES WITH CRYSTALLINE ARMOR

The latest chapter in this story will be found in a paper presented by my colleagues and myself at the International Glass Congress in Washington, D.C. This paper describes two methods, still in laboratory stage, of producing glass armored by a transparent skin of the negative-expansion eucryptic glass-ceramic. This armored glass has

a bending strength of 100,000 p.s.i. compared to less than 10,000 p.s.i. for commercial annealed glass, and maintains most of its strength after abrasion. We believe that these glasses can belie the reputation for fragility and brittleness that now is deserved by glass.

Since lack of strength has been the Achilles' heel of glass, it is worth examining the reasons for it to help us understand the new cures. The key to both the strength and the weakness of glass is in its amorphous structure. We can regard any piece of glass as a single molecule, a three-dimensional polymer whose strength is equal to the interatomic bond strengths. Therefore, as long as the surface is free from flaws, glass is fantastically strong. Fibers have been measured at one million p.s.i., quarter-inch diameter rods at 400,000 p.s.i. in tension. By contrast, the strongest steel alloys have tensile strengths in the 200,000 to 400,000 p.s.i. range. Compressive strength of glass is also of the order of hundreds of thousands of pounds per square inch.

Why then is glass so weak? Unfortunately, any contact with solid surfaces produces surface scratches. These become sites of highly concentrated stress when the surface is put into tension; and since the glass does not flow to relieve the local stress, a relatively low overall tension is sufficient to extend a scratch into a catastrophic crack.

An obvious way to maintain high strength is to protect the surface from abrasion, by coating with rubbery plastics or with slippery silicones before it has become scratched. These methods are in fact being employed for some types of glass containers, and for "armored" industrial pipe. Such plastic coatings serve another useful purpose, in preventing loss of the contents if the glass breaks.

A most promising principle for strengthening glass has been known for many years, and is practiced in the form of "chill tempered" glass. The principle, stated simply, is that tensile strength increases proportionately with the previously induced compressive stress in the surface layer of glass.

In chill tempering, an object is cooled rapidly from just below its softening point. Since the inner portion cools more slowly than the surface, it continues to contract after the surface is essentially rigid. Thus, compressive stresses develop in the surface layer with compensating tensile stresses in the interior.

Chill-tempering is capable of inducing compressive stresses up to about 20,000 p.s.i. under favorable circumstances, but is limited to relatively thick glass and simple shapes because of heat-flow problems, and its strengthening effect is permanently lost if the glass is reheated above 400° C.

New methods of inducing stress are free from these limitations, and in addition can induce much higher compressive stress, well over 100,000 p.s.i. The two methods of chemical tempering or armoring

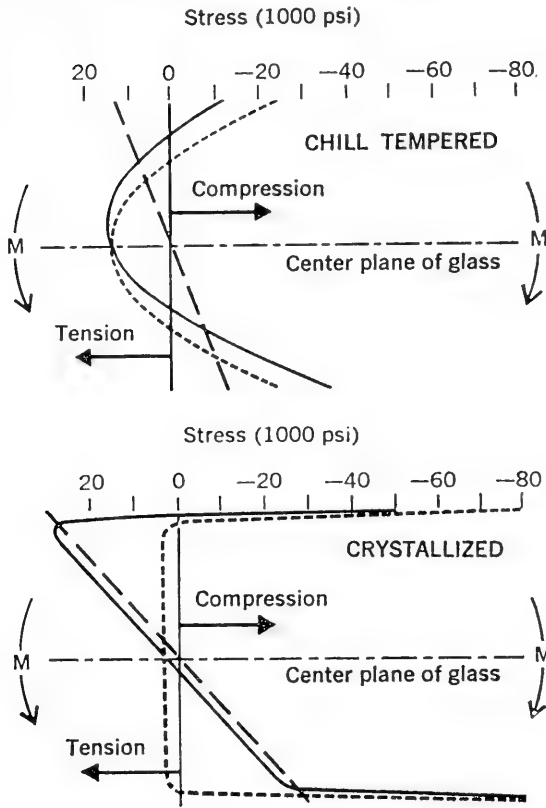

FIGURE 4.—Two ways to strengthen glass both depend on canceling tensile stress on surface by pre-stressing in compression. In diagram, dotted line is the pre-stress. Dashed line is stress created by external bending load M . Solid line shows net stress. Note that surface stress in crystallized glass stays much farther into compression range than in chill-tempered glass.

mentioned earlier both involve forming transparent polycrystalline layers within the surface of glasses of appropriate chemical composition. The crystallized skin, which is grown at a high temperature, has a negative thermal expansion and thus expands as it cools. The shrinking of the internal glass induces an extremely high compression of the skin, resulting in high strength. Figure 4 shows how this technique compares with chill-tempering.

One of the new methods employs surface-nucleated crystallization of a lithia-alumina-silica glass. The other, more complex, begins with a soda-alumina-titania-silica glass, replaces the sodium ions in the surface by lithium ions at high temperature—by immersion in a molten lithium sulfate bath, and ends with titania-nucleated crystallization of eucryptite crystals at the surface of the glass.

OTHER USES FOR ION EXCHANGE

The application of ion exchange in strengthening glass is only one of many examples of ionic and molecular diffusion and exchange, unfamiliar to most of us, that play significant parts in the manufacture and uses of glass.

The modern glass manufacturer immerses carbon electrodes into his continuous tank of molten glass and helps to heat it more uniformly by using the glass melt as a resistance; and he heats and seals glass parts by taking advantage of the ionic conductivity of glass at elevated temperatures.

The familiar red-stained chemical glassware and the yellow fog lenses of auto headlights are colored by reactions in which copper or silver ions replace an equal number of sodium ions in the glass surface at high temperature and are then reduced to colloidal metal by hydrogen or other reducing gases.

Even at room temperature, the performance of glass electrode pH meters depends on ion exchange between hydrogen ion in the solution being tested and cations in the glass electrode immersed in it. New glass electrodes have recently appeared on the market which also measure sodium and potassium ion concentrations, and even calcium concentration determinations have been reported. One of the significant papers of the Glass Congress is being presented by George Eisenman, a medical doctor who is learning to interpret the structure of glass from glass electrode potentials in solutions of various cations. He hopes that glass electrodes can be used to understand the way in which cations such as sodium and potassium move through living tissues, since such movement is crucial to many metabolic processes.

NEW INSIGHT INTO NUCLEATION

The discoveries in the photochemistry and crystallization of glass described earlier have aroused the interest of a number of scientists researching the fundamental mechanisms involved in the earliest stages of a photochemical reaction or of crystallization.

An example is the finding by R. D. Maurer of Corning that the smallest stable gold particle capable of growing into a gold crystal consists of 3 or 4 atoms; and that the smallest silver particle capable of nucleating the growth of a lithium silicate crystal is 80 angstroms in size. Such information can be valuable in testing theories as diverse as the theory of the photographic latent image, or the quantitative theory of nucleus formation in phase changes such as condensation of vapor or crystallization. Perhaps it is coincidence, perhaps not, that other investigators had previously found the "critical nucleus size" of supercooled water vapor—the smallest-size stable droplet capable of growing—to be also about 80 angstroms.

Considering the fact that every change in state of matter—condensation of vapor to a liquid or a solid, crystallization or evaporation of a liquid, formation of a new crystal from an old one, every chemical reaction—must be initiated by formation of nuclei of the new phase, it is amazing that so little fundamental research has been done on the subject of nucleation. One reason for the dearth of experimental research may be the difficulty of holding the submicroscopic nucleus still and preventing its instant alteration to a larger particle before its properties can be studied. If this is so, the new glass-ceramics may become a useful medium for this important research because the crystallization process can be initiated, controlled, or halted at will simply by cooling the glass (see pl. 3).

By thus being able to examine the nuclei in situ, it becomes possible to make measurements of their number and size—a difficult procedure by condensation methods. This will permit a comparison between various theories of nucleation kinetics, since all such theories include the critical nucleus size and nucleation frequency as fundamental parameters. This is true even of Willard Gibbs's early formulation relating the thermodynamic work required to form the smallest (critical) stable particle of a new phase.

CAN GLASS BE ELECTRONICALLY CONDUCTIVE?

All the electrical charge carriers in glass have traditionally been believed to be metal ions. One disadvantage of ionic conduction in glass is that movement of ions through the glass by diffusion alters the glass composition. This means the electrical characteristics of the glass can constantly vary with time. For example, glass conducting direct current by ion exchange can become "polarized" so that the conduction process becomes blocked.

Much research is being directed toward overcoming such problems. Researchers in England (J. E. Stanworth), Holland (H. J. I. Trap and J. M. Stevels), and the U.S.A. (A. David Pearson et al. of Bell Telephone Laboratories) are currently reporting electronic conductivity in a variety of glasses. Some of these contain high concentrations of vanadium pentoxide; others contain a single element additive in two or more valency states; and still others are low-melting, nonoxide glasses combining arsenic, tellurium, and iodine.

Undoubtedly there will be controversy as to whether these are truly amorphous glasses or whether the electrons originate in a crystalline component. Here again, the thorny question of molecular structure arises. It may be that an intermediate structure exists that permits electronic conductivity—a structure in which the molecules are more nearly ordered, as they are in crystals.

STRONG GLASS IS FLEXIBLE

We all think of glass as being rigid and brittle. In reality it is more elastic and flexible than spring steel. The reason that we have not been able to use this valuable property, except in glass fiber, is again the low strength. When we have mastered the strength problem, we have automatically gained the important bonus of flexibility and elasticity. Glass springs, flexible windows, and other manifestations of these properties are within sight. Already, tempered glass springs have been flexed for millions of cycles without the work-hardening or fatigue that occurs in metals.

While glass is elastic, it is completely nonmalleable and nonductile except at high temperatures. Ductility implies an irreversible yield or flow under stress, lead metal being a good example of ductile material. If we could give glass a little ductility, it would help a great deal in decreasing the complete, "catastrophic" nature of the break, as well as preventing very high local stresses from building up without relief by flow.

So far, there seems to be no practical solution to this problem. It may be that current work by J. A. Pask at the University of California and others on the ductility of single crystals of the alkali halides and magnesium oxide will shed some light on this problem, particularly with respect to the glass ceramics. However, the step from single crystals to polycrystalline materials is sure to be great.

OLDEST GLASS GETS NEW RESEARCH

Fused silica is a one-component glass, simply silicon dioxide, and as such is one of the simplest and oldest glasses in existence. Traditionally, it has been made by melting quartz sand, but many modern applications for this material require a purity and homogeneity beyond that provided by this simple method.

High-purity silica can now be made by high-temperature hydrolysis of silicon tetrachloride. The products of this reaction are pure silicon dioxide and hydrochloric acid. The silica condenses out continuously as a growing disk of optical-quality, amorphous glass. The HCl passes off as vapor.

Where is this improved material utilized? Recent research has shown that the small gas molecules of helium and hydrogen, normally blocked by glass, diffuse readily through high silica glass. Hence, serious thought is being given to use of such glass as molecular sieves for separation of helium from natural gas. Hydrogen diffuses more slowly than its molecular size would suggest, the reason being that it reacts chemically with the glass.

High-purity silica crucibles are employed in manufacture of pure single-crystal silicon for transistors. The same high-purity material is the heart of acoustical delay lines used in computers, because its

attenuation of sound waves is uniquely low. Thus, an electrical signal can start a sound wave bounding around inside a specially shaped piece of silica until the acoustic energy is needed to generate a second signal. This high-purity silica glass is also transparent to the whole optical spectrum from the vacuum ultraviolet (185 millimicrons) to the near infrared, and is not discolored—as many glasses are, including less pure silica—by exposure to high-energy radiation, so that it is useful in special optical instruments employing light in the uv range.

The Great Earthquakes of May 1960 in Chile¹

By PIERRE SAINT-AMAND
*U.S. Naval Ordnance Test Station,
China Lake, Calif.*

[With 10 plates]

INTRODUCTION

During the period of May through June 1960 there occurred a series of earthquakes and seismic sea waves² of catastrophic proportions that devastated large areas of Chile. An eruption of Volcán Puyehue occurred. A minor eruption of Volcán Calbuco began on January 25 of the following year, and the uplift and subsidence along the coastline caused by the earthquake and the subsequent tsunami rendered all marine navigational charts of the affected areas obsolete. All small boats, several ships, and all docking facilities were destroyed. The times of high and low tides in the Gulf of Chiloé were changed.

Apart from the physical changes of the terrain, the damage to industry, private property, utilities, and communications was both widespread and catastrophic in its effect. Recovery will take many years and vast sums of money. Known deaths from the earthquake numbered about 500, and, from the maremotos, about 1,000. The number of injured ran into thousands, and there are still numbers of persons missing and unaccounted for.

Except for some notable instances of local initiative, the communications systems broke down and rumor magnified the incidents and damage far beyond the facts; until communications and news media were restored, various degrees of chaos prevailed in isolated areas, compounding the difficulties of relief efforts. Despite the incredible conditions and persistent bad weather, some semblance of normality

¹ Reprinted by permission, in modified form, from Technical Article 14, Michelson Laboratories, U.S. Naval Ordnance Test Station, China Lake, Calif., August 1961.

² In geological terminology, known by the Japanese name "tsunami" or the Spanish name "maremoto." These names will henceforth be used in this article.

was restored within 2 weeks by the Herculean efforts of the Chileans and the relief expeditions of their North and South American neighbors.

THE FIRST PHASE

The first large shock of this series of earthquakes occurred at about 6 a.m., local time, on the morning of Saturday, May 21, 1960, the anniversary of the famous battle of Iquique. This shock, magnitude $7\frac{1}{2}$ (on the Richter scale), had its epicenter in the peninsula of Arauco (fig. 1), a projection of the Chilean coast lying to the south of Concepción. This earthquake left a zone of intensity of about VIII on the Modified Mercalli (MM) scale, having a length of some 100 km. and a width of about 40 km. Nowhere was there a clear-cut zone of extremely high intensity. From this it was possible to conclude that the focus of the earthquake had a depth of 50 km. or more beneath the surface of the earth. The damage from this earthquake was largely confined to the city of Concepción (pl. 1, figs. 1 and 2) and to the chain of coal-mining towns situated along the Arauco Peninsula. There was some damage to towns in the central valley and to roads and railroads.

All day Saturday aftershocks were felt in the epicentral area, and the activity continued through Sunday. At about 2:45 p.m. on Sunday a strong but not seriously destructive shock was felt. Over all of southern Chile people became alarmed and left their homes to go into the streets. They were still standing in the streets when at about 3:15 p.m. the *remezón* struck. This fortunate circumstance saved the lives of many thousands of people, who, had they remained indoors, would surely have been killed by the fall of houses and of architectural gingerbread as they fled to the streets.

The motion of the ground during the *remezón* was as if one were at sea in a small boat in a heavy swell. The ground rose and fell slowly with a smooth, rolling motion, smaller oscillations being superimposed on larger ones. In Concepción cars and trucks parked by the side of the road rolled to and fro over a distance of $\frac{1}{2}$ m. while they bobbed up and down in response to the movement of the ground. The tops of the trees waved and tossed as in a tempest. Some already damaged buildings fell. The earthquake itself was silent; not a sound came from the earth. The period of vibration was of the order of 10 to 20 seconds or more. The shaking lasted fully $3\frac{1}{2}$ minutes and was followed for the next hour by other shocks, all having a slow, rolling motion. It was learned later that in all parts of the affected zone the movement was similar. Nowhere did anyone report the short, brusque movement typical of a locality near an epicenter. In the Region of the Lakes, for example at Llifen, the movement began smoothly and continued for some 2 minutes, just as in other localities, when, suddenly, a loud subterranean noise was

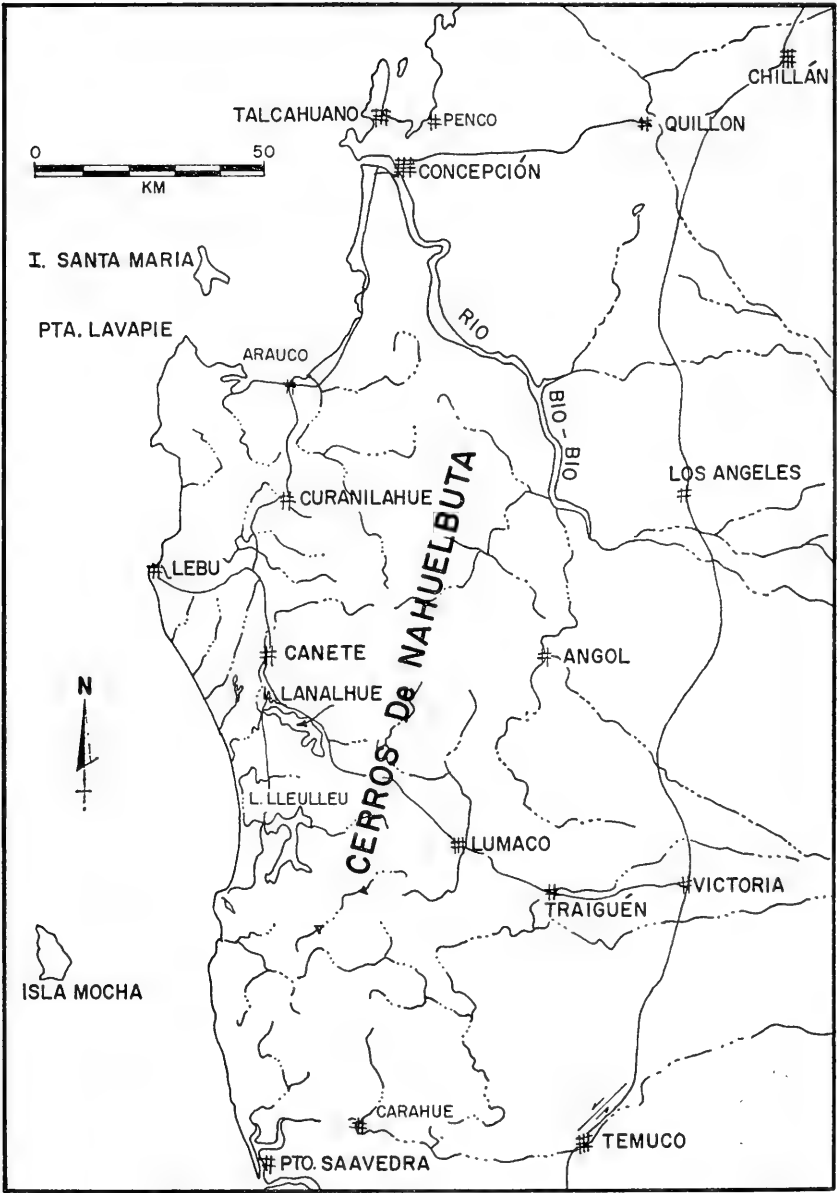

FIGURE 1.—Sketch map of northern region of the earthquake zone.

heard, followed by a sharp jarring motion and a more rapid, less regular vibration of the earth. Similar reports were obtained at other points to the east of the Lakes, and it seems from these that another earthquake took place here, between Lago Villarrica and Lago Todos los Santos (figs. 2 and 3), while the ground was still shaking from the first shock. Similar reports were received from Maullin, Ancud, and Puerto Montt (figs. 3 and 4).

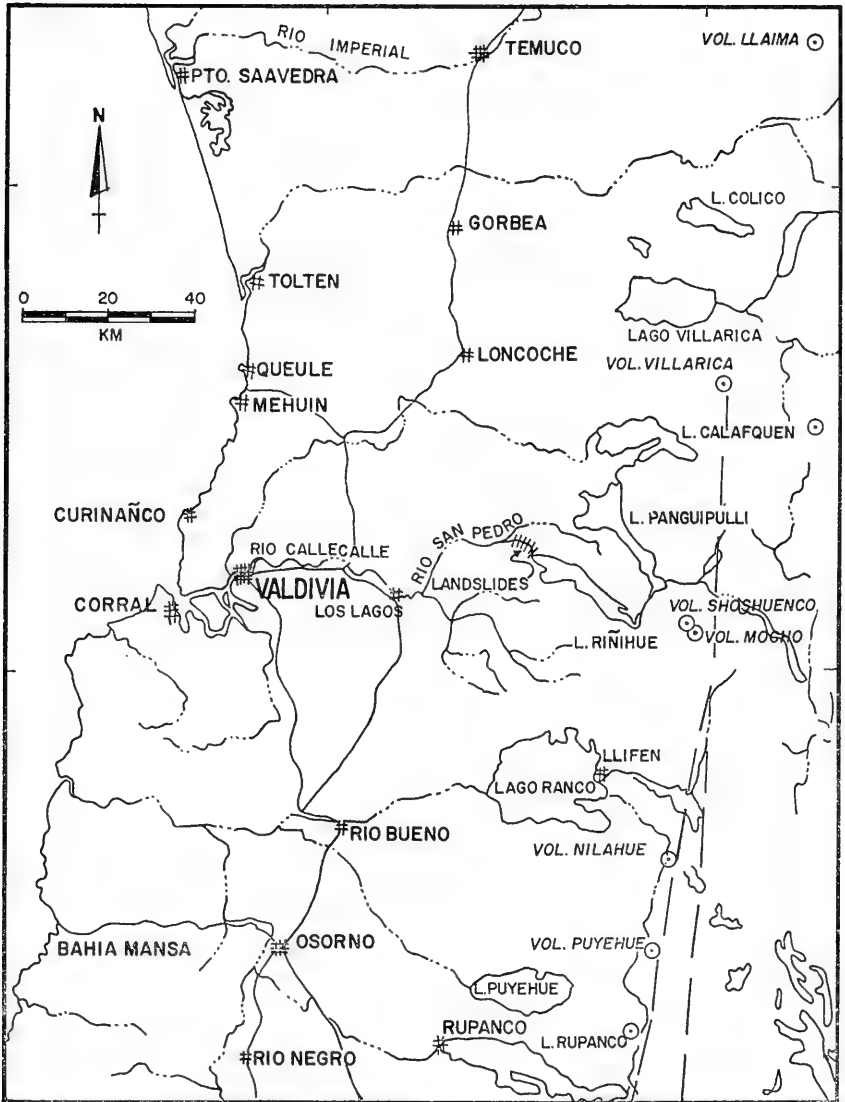

FIGURE 2.—Sketch map of central region of the earthquake zone.

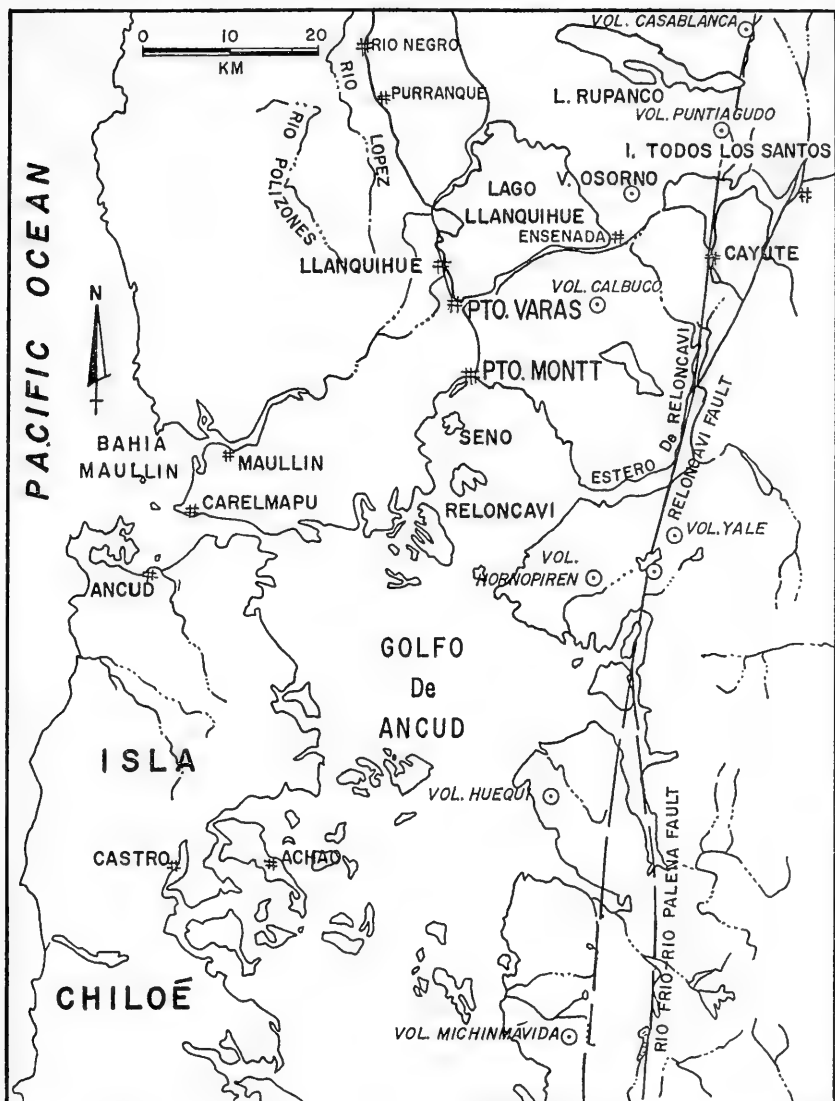

FIGURE 3.—Sketch map of southern region of the earthquake zone.

Owing to the sparse settlement of the southern part of the affected zone and the difficulty of access, little is known of the effects of shaking there. A number of severe landslides occurred in several places, notably near the settlement of Puerto Cisnes on Isla Magdalena. It has not been established whether this was produced during the main shock or during one of the larger aftershocks.

The seismograph at Concepción was completely destroyed by the first shock and thus was useless. However, the station at Santiago

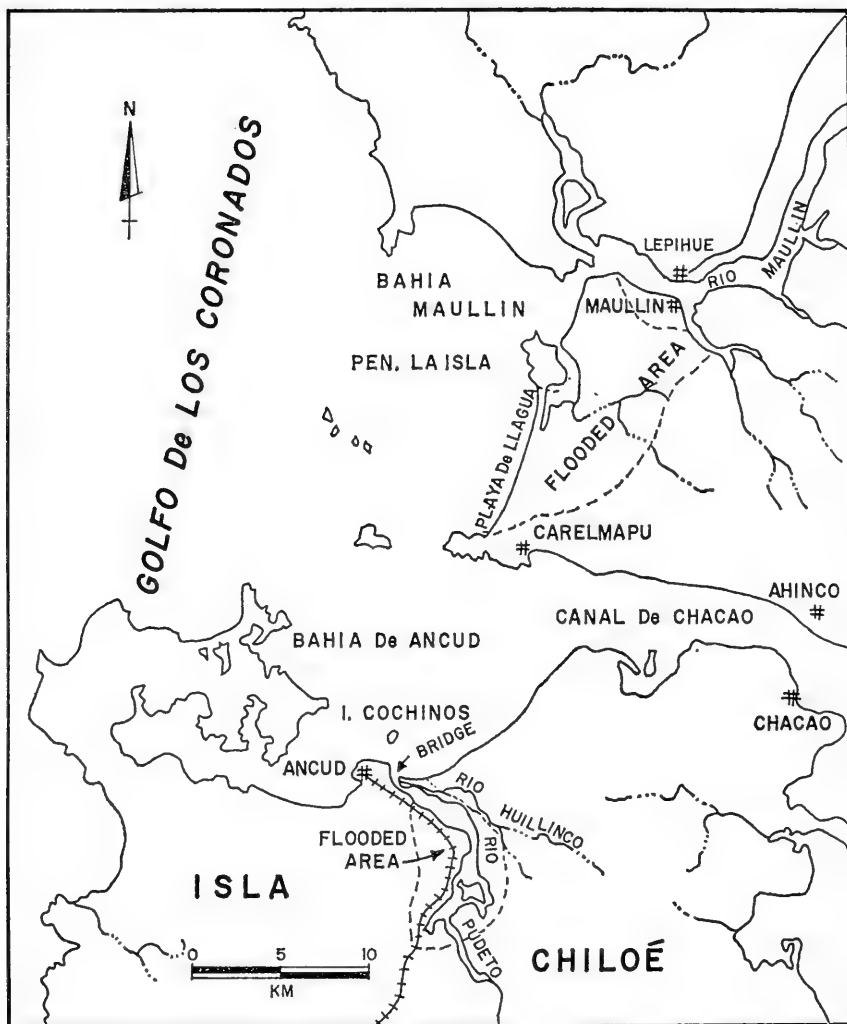

FIGURE 4.—Sketch map of Isla Chiloe and surrounding area where extensive damage occurred.

continued recording tremors every hour or so for the first day. Dr. Cinna Lomnitz and his colleagues at the Instituto de Sismología interpreted these as being to the south and situated over a distance of 400 to 1,000 km. Over a period of several days the area of the activity spread southward, and strong shocks were felt on the Peninsula de Taitao. It was sufficiently clear, by this time, that Chile was being subjected to an earthquake swarm of major proportions and that the active area comprised a width of some 160 km. and a length of almost 1,600 km.

INVESTIGATIONS

As soon as it was possible to organize properly and equip field parties, the Instituto de Investigaciones Geológicas (ILG), the Chilean Geological Survey, under the direction of Don Carlos Ruiz, and the Escuela de Geología under the direction of Don Humberto Fuenzalida, working in unison, divided the south into four parts and sent four trucks, each with a group of geologists, into each of the areas. They remained for about 3 weeks, making observations of earthquake damage and recording all the geologic effects that could be observed. Each group carried food, water, gasoline, and camping equipment.

A fifth expedition was sent by private plane to make an aerial examination of the epicentral region and to study the needs of the people in the region so that aid could be distributed more effectively. The plane was placed at the disposal of the investigation by its owner, Vernon Goakes, son of Harry Goakes, chief of the U.S. ICA Civil Air Mission to Chile.

Subsequently, personnel of the U.S. Geological Survey, the International Cooperation Administration, the U.S. Department of State, the University of California, and various other organizations joined the Chilean groups in the field work. Scientific personnel from Mexico, France, West Germany, and Japan came to do what they could to help. The U.S. Coast and Geodetic Survey, the California Institute of Technology, and the University of California at Los Angeles all contributed information. The results of the observations by these people are summarized in this article. A detailed study of structural damage was undertaken by members of the Earthquake Engineering Research Institute and will be published elsewhere.

DISTRIBUTION OF INTENSITY

There were two zones of high intensity. One zone lay along the coast from about Puerto Saavedra to the south of Isla Chiloé. The intensity varied in this region from MMVIII to IX, with occasional high points where landsliding and settling of overloaded ground destroyed parts of some of the larger cities (pls. 2 and 3, and pl. 4, fig. 1). The intensity in the central valley was less—VI to VIII. There, comparatively little damage was noted except near river banks where landslides destroyed a number of buildings, and the railroad and highway were interrupted. A second zone of high intensity, coincident with the Reloncavi Fault (fig. 3), was found to the east of the Lakes. Here, a long narrow band some tens of kilometers wide and several hundred kilometers long suffered from a rapid high-intensity shaking. The two zones converged toward the south.

In the Lakes Region landslides occurred in thousands of localities. Waves were produced in the Lakes by the earthquake, and an oscilla-

tion of over 1 meter in height was noted on Lago Panguipulli (fig. 2). All the smaller lakes were muddied by the movements of the waters, by the landslide material carried into the lakes by the slides themselves, and by the rivers.

The strongest shaking observed occurred on Isla Chiloé, where, over an area of 10 by 30 km., many trees, both green and dry, were snapped off by the ferocity of the shaking. In some instances the branches of dry trees were snapped from the trunk and fell to the ground in a circle around the trees. Some trees fell to one side or the other, pulling their roots from the swampy ground.

The ground was cracked in many places in the south, usually by landslides. Lurch-cracks were observed in many places near Puerto Montt and on Isla Chiloé (figs. 3 and 4). The Longitudinal Highway was cracked in many places, usually by the settling of fill. Near Puerto Varas a small car that was being driven along the road at the time of the earthquake sank into the soft subgrade that was exposed when the concrete surface of the road floated off to the sides. This was caused by a liquefaction and subsidence of the subgrade and the soil upon which the road was built (pl. 4, fig. 2). A person who had been pushing a handcart was subsequently found buried in the resolidified mud.

The towns of Valdivia and Puerto Montt (figs. 2 and 3) were extensively damaged by small-scale landslides and by earth flows. The soil in both localities, being a fine-grained, water-soaked silty clay, became liquid when subjected to the shaking of the earth. In the harbor of Puerto Montt the motor ship *Puyehue* was caught in an alluvion, a current of sand and mud that flowed from a nearby dock area into the bay, thus creating for itself the unique distinction of being the first ship in history to go aground in a landslide. Unable to remove the ship, but undaunted, the owners converted it into a hotel.

Application of the MM scale to this earthquake is practically impossible. The damage was done by the main shock and by a large number of subsequent shocks. People became so confused that, in interrogation, it was difficult to establish exactly what happened when. One aspect in which the scale is not adequate concerns the effects of long-period waves. The long-period movements were certainly of great amplitude and produced small but persistent accelerations. These were responsible for the liquefaction of the soil in many places. The secondary effects, produced by landslides, soil creep, soil flow, and the settling of structures into the overloaded soil, were sufficiently impressive to assign MM intensity XI and possibly XII in some localities, where less than a kilometer away in any direction an alarmist could not have assigned an MM intensity greater than VII. Figure 5 shows the author's best guesses as to intensity.

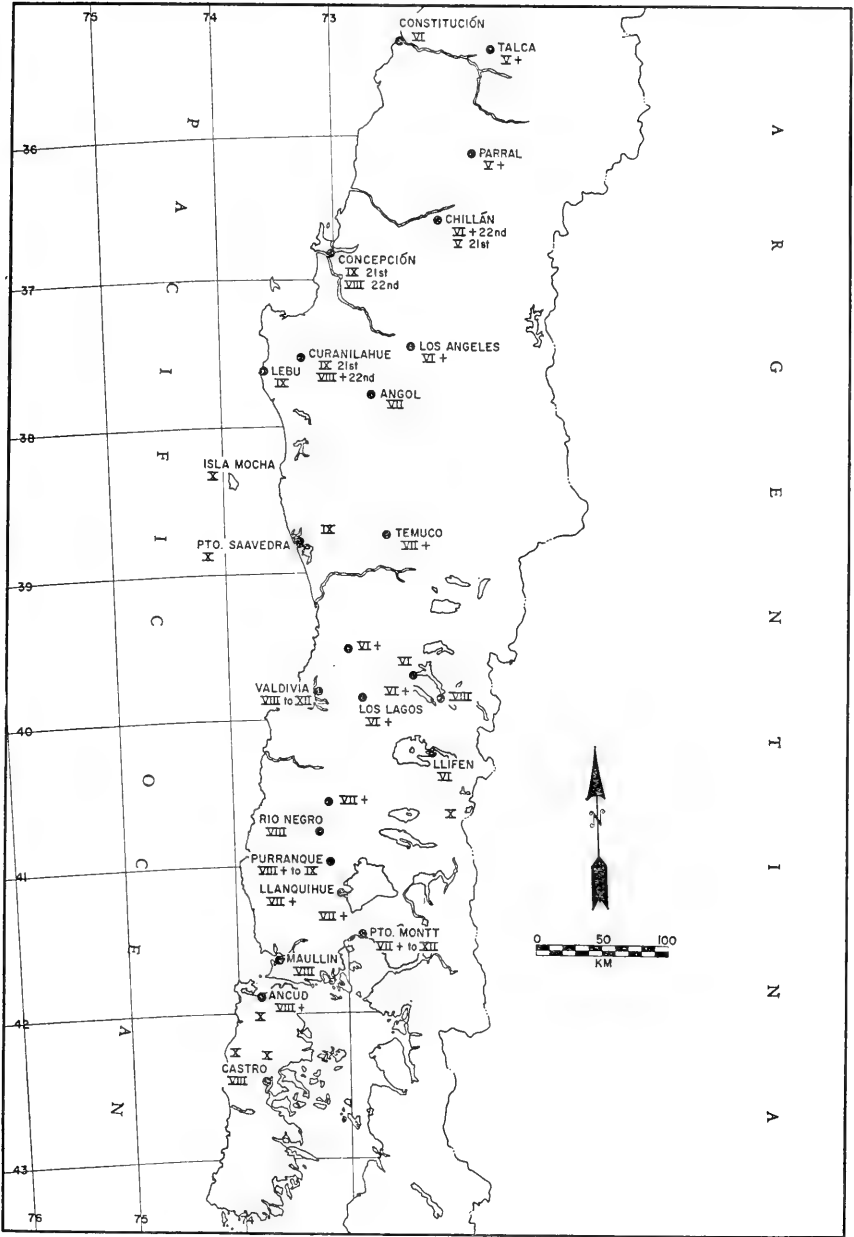

FIGURE 5.—Author's estimate of MM intensities of affected areas.

ARRIVAL OF THE MAREMOTO

The inhabitants of the coastal towns, upon running outdoors at the arrival of the temblor de advertencia some 15 minutes before the large shock, noted that the sea was disturbed and that a small oscillation seemed to be taking place. Being experienced in this sort of thing, they continued to watch the ocean. During the big shock the sea was disturbed, and in some instances it rose a little; in others, it fell. Then, suddenly they noted that the sea was beginning to retreat from the shores, exposing the ocean floor to distances well beyond the lowest tides. When this happened, the fire alarms were sounded, and firemen and carabineros systematically went through the streets warning everyone of the impending danger. The people fled afoot and on horseback to the hills and waited. Those on horseback made repeated trips to save the old and infirm. After 15 to 30 minutes, the sea returned, advancing upon the shore in a wave that was, in places, over 20 feet high. The wave rushed over the land, covering and carrying away the houses, killing the animals that could not be evacuated, and carrying off some of the people who, for one reason or another, had not left their homes. Plate 5, figure 1, shows the remains of Puerto Saavedra (figs. 1 and 2). In Queule (fig. 2), according to press reports, nearly 500 people were lost because they returned to their houses too soon or because they had failed to notice the warning of the receding water.

In several villages along the southern coast, such as Carelmapu (fig. 3), the mariscadores, or shellfish collectors, took advantage of the recession of the sea to wander over the exposed sea floor collecting shellfish in their baskets. When they had collected more than the usual quantity of mussels and locos, they returned to the shore, climbed upon the hills, and waited for the water to return. The waves continued all afternoon. The third or fourth wave was reported as the highest. Several days later, a group of mapuchis or Araucanian Indians sacrificed a 7-year-old boy to the gods of the sea to calm the remorseless surf.

The maremoto carried away all coastal docking facilities and sank innumerable small boats. About 200 people were lost on Isla Chiloé (fig. 3), where, fearing the earthquake, they took to small boats to escape the shaking earth. In Ancud, for example, the sea withdrew past Isla Cochinos (fig. 4), carrying the small boats with it. Upon the return of the sea in a thunderous breaker, all were lost.

Several larger ships were sunk near Valdivia. One notable example is the M.V. *Canelos*, which may still be seen obstructing the Río Valdivia. A ship of 3,000 tons was washed onto the beach on Isla Mocha.

The sea wave produced the most serious effects from Concepción to the south end of Isla Chiloé. The maximum height seems to have

been between Puerto Saavedra and Bahía Mansa (fig. 2). The height at which the wave arrived depended greatly on the configuration of the sea coast.

The maremoto was observed at Cumberland on the island of Mas a Tierra in the Juan Fernandez group, located some 480 km. west of Valparaiso. There, it began as a lowering of the sea, at about 4:15 p.m., local time, followed in about 10 minutes by a rise of $1\frac{1}{2}$ m. The sea oscillated several times, doing essentially no damage. Cumberland Bay is sheltered somewhat by the island, and so the portion of the wave received was, in part, only a diffracted wave; however, the island rises abruptly from the deep and has essentially no sloping submarine platform. Hence, it can be said that the actual sea wave at this distance was more than 2 m. in amplitude.

On the Isla Mocha (fig. 1) the maremoto began as a withdrawal of the sea (so it was reported). However, the shaking there was so fierce, with cows, horses, and people falling to the ground, that it is quite possible that no one noticed the first movements of the water. The sea seemed to "stand still, backing up against itself, the water boiling as it withdrew." When it returned, it reached at least $\frac{1}{2}$ km. inland on the eastern shore, destroying the government radio station and the docks and scattering the remains of a two-story fieldstone building located 500 m. from the shore some 200 m. up the gentle slope. As the sea withdrew, it clawed grooves out of the grass, exposing the shell-rich soil beneath in parallel furrows 1 m. wide and 20 m. long. A private pilot, hunting on the island, had left his plane parked on the beach. Feeling the lurching of the earthquake, he realized what was going to happen, and ran to his plane. Starting the motor, he raced, without waiting to warm the engine, into a frantic takeoff; but, just as the plane became airborne, a wave reached it. The plane was carried to some trees where the quick-witted pilot leaped from the craft to cling to a tree. The plane was carried out to sea.

Damage to vegetation from the tsunami was also noted on the western shore, and, although no detailed observations were made there, the waves did not seem to reach as high as on the eastern shore.

A very readable account of the maremoto, written by Captain Andrade[1]² of the Chilean Navy Hydrographic Office, details the effects of the maremoto all along the coast. A more recent manuscript by Sievers, at the same office, gives more complete information.

ERUPTION OF VOLCÁN PUYEHUE

At 2:45 p.m. on May 24 the crew of a U.S. Air Force plane, returning to Santiago from Puerto Montt, piloted by Col. William R. Calhoun, USAF, noticed that an explosion was taking place on the side of

² Numbers in brackets refer to the list of references at end of article.

Volcán Puyehue (fig. 2). The same plane had passed the volcano at 1:30 p.m. on the trip south. At the time they saw the eruption a cloud of ash and steam had ascended to at least 20,000 feet, and the volcano was in an explosive phase of its eruption. Large smoking rocks flew through the air, and the gigantic explosions, heard inside the aircraft, reminded the crew members forcibly of their wartime experiences with anti-aircraft fire.

The eruption continued for several weeks. Ash and steam were emitted along the length of a fissure about 300 m. long, situated on the northwestern flank of the crater of Puyehue itself (pl. 8, fig. 2). The zone of fissuring was about 100 m. wide. Steam emerged from 8 or 10 bocas, and volcanic ash from one or two larger orifices. The ash falling near the holes made a small cone around the larger of these orifices. The ash from the volcano made a beautiful panache against the sky and was driven by the wind over the mountains where it fell, giving the landscape the aspect of a fresh fall of somewhat sooty snow. For several days ash fell in the central valley, and some alarm was expressed by farm owners who feared for their pastures. Fortunately, no harm was done.

The ash eruption was followed by the discharge of a viscous lava, making several flows about 1 km. in length. The eruption seemed to be terminated when the area was visited on July 22; the lava, although still hot, was no longer in motion.

The local newspapers, in an unparalleled burst of enthusiasm, reported that 12 volcanoes had exploded and that 2 new ones had been formed. Lava was reported to be flowing down the sides of several of these volcanoes, and towns were said to have been buried. Because of the bad weather and poor visibility in the central valley, the inhabitants of the valley towns all believed that the volcanoes were, indeed, erupting and were concerned by the situation for a period of several weeks. Newspapers and news magazines all over the world repeated and enlarged on these stories.

The last eruption noted in this region was that of Volcán Nilahue (fig. 2), located on Cerro Carran (and sometimes referred to by that name). Nilahue, situated some 20 km. north of Puyehue crater, erupted in July and August 1955,³ discharging ash and dust [2]. The last eruption previous to this one seems to have been that of Volcán Rininahue, some 3 km. to the south, in 1907. The last eruption ascribed to Puyehue proper was in 1905, according to Gutenberg and Richter [3].

Las Azufreras, a fumarolic area on the northwestern flank of Puyehue, erupted in 1921 and January 1922 with a large outpouring of lava [4]. Cassertano⁴ points out that the location given by

³ Unpublished IIG manuscript by Carlos Klohn.

⁴ Personal communication to Pierre Saint-Amand, dated 1960.

Krumm [5, 6] is erroneous. The 1960 eruption was probably from the same fissures as the 1921 eruption.

An eruption of Volcán Calbuco, certainly a part of this same seismic crisis began on January 25, 1961, with the emission of steam clouds and the production of earth tremors was reported by Erick Klohn. On February 1 the first of a series of three lahars swept down the slopes of the volcano and into Lake Llanquihue. Several small streams of lava were emitted in late February and on March 10th a large explosion occurred, accompanied by emission of ash and ejection of large bombs.

A new volcano was reported by an Argentine helicopter pilot to be erupting on the coast about 40 km. north of Valdivia near the town of Curinanco (fig. 2). A crater several meters high was reported to have formed and was apparently throwing rocks and ash into the air. A submarine eruption was reported near this cite by bush pilots several days after the earthquake, but the fact could not be confirmed. There does not seem to have been volcanic activity in this area before. None of these reports was confirmed, and it is suspected that what was observed was a sand-blow, or mud volcano.

Sand-blows, or mud volcanoes, were observed in many places and were usually taken to be new volcanoes; however, these are effects of vibration and soil compaction on subterranean water and have nothing to do with real volcanoes.

FAULTING

The careful ground and aerial search made by the field parties did not disclose any clear-cut cases of faulting, that is to say, large displacement of the land surface, such as have been observed in other earthquakes. In several places to the east of the Lakes, specifically on the eastern side of Lago Calafquen (fig. 2), large cracks were found in the ground that could have been produced either by faulting or by landsliding.

Weischet [7] reported a fault near Mehuin (fig. 2) that strikes N. 53° E. and shows 1½ to 3 cm. left lateral movement with about 3 cm. of sidewise separation. He reported a length of at least 300 m. He shows a photograph and discusses what is obviously a type of fault trace observed near Ensenada on Lake Llanquihue (fig. 3). The general trace runs N. 13° E. for "hundreds of meters," and shows no apparent lateral movement. Unfortunately, the trace is on alluvial terrain. The same material is discussed by von Bauer [8].

In one of the astonishing accounts of the earthquake, a faultlike trough some 30 km. long and 300 m. deep was reported to have formed in the Lakes Region. A systematic search did not reveal this feature, and it is probable that it was a misinterpretation of a more conven-

tional terrain feature such as a river bank seen under conditions of poor visibility, or perhaps it was simply an invention.

CHANGES IN LAND LEVEL

Some bona fide changes of land level occurred. The western side of the Arauco Peninsula seems to have been uplifted $1\frac{1}{2}$ meters, exposing a new beach at Lebu [9]. The uplift at Lebu appears to have decreased slightly with the passage of time (pl. 5, fig. 2). When visited in October, the uplift was between $\frac{1}{2}$ and 1 m. Fitzroy [10, 11] in 1835 reported similar behavior of Isla Santa María, a few tens of kilometers to the north. A flight over Santa María revealed that no change had resulted from this earthquake. Isla Mocha has risen about $2\frac{1}{2}$ m. above its former level. Rocks, formerly buried, are now exposed, and places where people had to dive to collect sea urchins are now washed by the surf. The waves now break on a wave-cut platform, the old beach is high and dry, and the intervening space is covered with dead shell fish. The foundation of the dock is currently out of water, as may be seen in plate 6, figure 1. Some small islets to the south of Isla Mocha are now united and are surrounded with skirts of wave-cut rock (pl. 6, fig. 2). There seems to have been no change in elevation in the months following the earthquake, and the uplift seems to be permanent. Evidence of previous changes is abundant on the uplifted terrace forming the flanks of Isla Mocha. Andrade [1] reports that Isla Guafo also rose a like amount and that Isla Guafito is now connected to Isla Guafa by dry land.

In general, however, the coast southward of the Arauco Peninsula dropped between 1 and 2 m. This was first noticed when the maremoto failed to recede after its last oscillation. In Puerto Saavedra, the streets remained covered with water for several days, but 5 days later they had almost completely dried off. The sea, however, remains higher than it was in many places, and large areas of land near Maullin and on Isla Chiloé (fig. 3) are still covered with water and will probably remain thus. The beach, Playa de Llagua, is now covered, and the Peninsula La Isla (fig. 4) is now, indeed, an island. Lebu, Isla Santa María, Isla Mocha, the Arauco Peninsula, and the Puerto Saavedra may be located on the map in figure 1.

On Isla Chiloé, the Río Pudeto and Río Huillinco (fig. 4) now cover parts of the railroad and highway (pl. 8, fig. 1) several kilometers from their former shores. Evidence of submersion may be seen all along the western side of Isla Chiloé.

FLOODING

Not only was there considerable flooding caused by the subsidence of whole blocks of the continent on a tectonic scale, but there was also flooding produced by the rivers. The soil along the river banks

and in the valley was compacted and settled, placing the land surface lower than before. The earthquake shook water out of the ground, and the normal discharge of the rivers was greatly augmented. All these factors, coupled with the almost continuous rain, put a number of rivers in full flood and added to the problems of the inhabitants (pl. 7).

Among the landslides produced, one was especially notable both for its size and the amount of damage done. This slide took place on the Río San Pedro about 4 km. downstream from Lago Rinihue (fig. 2 and pl. 9, fig. 1). The slide was some 3 km. in length and consisted almost entirely of clay. An oversteepened bank on the north side of the river slid over the old river channel along a bed of water-saturated clay.

The slide dammed the river, and the level of Lago Rinihue rose about 20 m. before the stream overflowed the natural dam (fig. 2). Engineers of the National Power Co. worked feverishly to cut a channel across and around the slide to prevent additional rising of the lake. The drainage from several nearby lakes contributing to Rinihue was shut off artificially in order to prevent excessive rise of the water in Rinihue. The dam was opened in July and the lake drained, causing a flood of the sort that occurs every few years during seasons of heavy rain.

LUMINOUS PHENOMENA

Several people reported luminous phenomena associated with the earthquakes. The most interesting reports come from the Arauco Peninsula, where, it was reported, people in Canete (fig. 1) saw a luminous glow in the air associated with these larger aftershocks. The phenomenon was described by a pilot who, with three passengers, was trying to sleep in his plane. The plane bounced around a great deal during the night, sliding some 4 m. southward over the slippery surface of the field.

The light was described as coming from the air, beginning abruptly with the sound from the aftershocks, and rising to a fairly constant level in less than 1 second. It continued for perhaps 40 to 50 seconds, dying out more slowly, with a decay time of a few seconds. It was seen only during the stronger aftershocks. The light was described as a "fosforescencia del aire de un color azulverdoso." The effect seemed brightest at the horizon to the south and east. The sky was quite clear. There was no electric power available anywhere on the peninsula, which could have caused the phenomenon, all the power having been shut off because of the earthquakes.

The pilot also reported changes in compass headings during this time, but this might have been due to jostling of the aircraft or to imagination. This account is reported here as being typical of in-

stances of light seen during earthquakes. The slight overelaboration of the report indicates a possible element of invention. The phenomenon is probably psychological in nature, but it certainly merits study.

GEOLOGY

The geology of the southern part of Chile is largely unknown in detail. Muñoz-Christi [12] has discussed the region, and, recently, Sr. Luis Aguirre of the IIG has compiled a map of the outstanding features of the region. An excellent discussion of the orography is to be found in Fuenzalida [13].

At latitude $37\frac{1}{2}^{\circ}$ S. the country consists, on the Arauco Peninsula, of Tertiary marine, estuarial, and continental deposits placed, it appears, unconformably over schists and phylites of unknown but possibly Pre-Cambrian age. These sediments contain most of Chile's coal. The peninsula is cut every few kilometers by strong northward-trending faults of varying vertical displacement. The largest of these, the Arauco fault zone, may be followed from Concepción across the peninsula as a discontinuous break. A branch of this fault passes to the west of Lago Lanalhue, the lake being dammed by uplift of the peninsular block along this fault.

The Santa Fe fault zone, actually an ancillary member of the Arauco fault zone, passes through the town of Lebu. It shows clear-out strike-slip topography, modified, of course, by the deeply weathered colluvium. This zone almost certainly moved during the earthquake or during an aftershock. Small landslides developed along its length, and cracks could be seen from the air on the hills on either side. The bridge crossing the Río Lebu was ruptured over the fault zone, but, unfortunately, no record was made of the displacement before repairs were made.

The faulting in the Arauco Peninsula is exceptionally well developed, and when aerial photographs or good maps are available, it will be an important area to study. Some idea of the complexity of the faulting may be had from Fenner and Wenzel [14].

To the eastward, in the Cerros de Nahuelbuta, one encounters the southern end of the coast-range batholith of probably mid-Cretaceous age. This batholith terminates at about Traiguén (fig. 1). Southward, except for miniscule outcrops south and west of Corral, the batholith does not reappear in the coastal hills for 7 degrees of latitude. The coast range is cut by a number of north-south faults of considerable extent. These form the boundaries of the central valley.

One gigantic fault passes near the town of Lumaco (fig. 1) and is very notable because of the complex geomorphology of the region. The Río Lumaco flows into a closed basin, forming a large, swampy area. The basin is bounded on the east by the Lumaco fault. This fault is almost invisible from the ground but is quite obvious from the

air. It is cut off on the south by a large, northwesterly trending fault that forms the valley in which the town of Capitán Paistene lies. The interesting thing is that the batholith appears to be dextrally offset for several tens of kilometers along this fault. More detailed mapping in this area might reveal whether this were a real offset.

The central valley at this latitude is narrower than in the region of Chillán, and southward of Victoria the valley is replaced by a series of low hills. The valley is a broad, graben-like depression bounded on the east by the frontal scarp of the Andes. The valley in the region of Chillán is thought to be filled with several thousand meters of sediments of glacial and fluvial origin [15].

The frontal scarp of the Andes is markedly straight and abrupt, being bounded by a series of subparallel north-south faults of great vertical displacement.

The Andes, here, are composed of andesite porphyries and sediments derived therefrom, of probable mid-Cretaceous age, covered in part by effluvia of Recent volcanoes and intruded occasionally by masses of Andean granodiorite and diorite. These are folded and faulted. The mountains have a general level of about 2,000 m., some volcanoes reaching over 3,500 m. The eastern side of the Andes is bounded by a series of north-south faults forming large blockranges with a descent, in some places gradual, in others abrupt, to the Argentine pampas.

At about latitude $39\frac{1}{2}^{\circ}$ S. the coast suffers an embayment. The coast range, here composed entirely of the metamorphic sequence, has degenerated to a series of low hills extending to within a few kilometers of the line of lakes. The central valley is absent, except for a narrow strip between the hills and the lakes Rinihue, Pangipulli, and Calafquen (fig. 2). The character of the Andes, here, is different. The average summit level of the hills is about 1,000 m. less than that of those to the north.

The change begins at about Volcán Llaima (fig. 2). A line of lakes, apparently bounded on the west by a system of faults and lying in partially glaciated valleys, extends to the south like beads on a string. The next "lake" comprises Seno Reloncavi and the Golfo de Ancud. A line of active and dormant volcanoes rising above the dissected, mesalike surface of the Andes dominates the eastern sky lines.

The mountains here, as those farther north, are composed of the same volcanic-sedimentary sequence, partially covered with lavas and intruded by granitic rocks. The outstanding difference is that the intrusive rocks form almost the entire range, the batholith now being confined to the Andes rather than to the coastal range. The question arises, has the batholith been offset by some gigantic sinistral-shear system, or is it a different batholith from that of the coastal hills?

At about latitude 41° S. the coast range again consists of a series of low hills of metamorphic rocks. The central valley is broad; and the Andes Mountains are more clearly defined. Farther south the coastal range becomes the Isla Chiloé and the Archipelago de Los Chonos. The lake basins join with the central valley to form the inland waterway of the archipelago. At about the Peninsula de Taitao the coastal range merges with the Andes, and the central valley again becomes indistinguishable, except as a troughlike channel marking the great faults in Estuario de Los Elefantes, in Canal Moraleda, and in Canal Errazuriz. The faults at this point swing seaward and are lost beneath the ocean.

This region has a topography similar to that of southeastern Alaska, where glaciers have scoured out the ground rock in the fault zones leaving the structure of the region clearly exposed [13]. Long faults abound. The fault of Estuario de Los Elefantes has, near Laguna San Rafael, recent escarpments in the alluvium several tens of meters in height.

Another important fault begins about Volcán Michinmavida (fig. 3), passes through Estuario Reloncavi, Cayutue, and Lago Todos los Santos and continues northward below or near Volcán Puyehue. The fault is marked by a long, troughlike valley with volcanoes on either side that, occasionally, obstruct the valley. This general zone, with a similar line slightly west along which volcanoes Shoshuence, Villarica, Llaima, Lonquimay, Calafquen, and Antuco are found (fig. 2), extends to the region of Lago Laja and possibly farther north. Klohn⁵ has described this lineament as a volcanic fracture zone. The topography is strongly suggestive of strike-slip faulting in the past, although it may no longer be active as a strike-slip fault. This complex of faulting marked the eastern edge of the active zone during this sequence of earthquakes. A similar, possibly related, fault connecting with this one is clearly indicated by the courses of Río Frio and Río Palena.

The offshore topography is quite interesting. A long, narrow ocean deep parallels the Chilean coast and is bounded on the east by a great scarp running roughly parallel to the coast. For example, along latitude 41° S. the sea deepens gradually, reaching a depth of some 1,000 m. 60 km. from shore; 18 km. farther offshore the depth becomes 3,562 m.

During the last 2 years a study of faulting in Chile has been undertaken in collaboration with Prof. Clarence R. Allen, of the California Institute of Technology, with emphasis upon work in the Atacama Desert of northern Chile. In general, the faulting in the northern and central parts of the country consists of two conjugate systems, one

⁵ Oral communication from Carlos Klohn to Pierre Saint-Amand, dated 1960.

a right-handed strike-slip system oriented roughly parallel to the coast, the second a left-handed system oriented about 60 degrees to the eastward of the other. These faults are presently active.

Another observation is that the Chilean coast is, in general, submerging along these great faults. The faults inland, in the coastal mountains and in the central valley, move primarily horizontally; those in the Andes also slip horizontally, but there is, as well, a strong component of vertical uplift on these with the mountains continuing to grow with the passage of time. Those faults at the edge of the coast show a tendency to permit the oceanward block to drop obliquely beneath the sea, sliding northward as it goes down. There is ample evidence that certain portions of the coast and even some extensive areas such as the Mejillones Peninsula are rising. However, lack of Recent or Tertiary marine sediments along the flanks of the coast range counterindicate post-Cretaceous submergence and subsequent uplift. The faulting along the coast must be nearly vertical in order to produce the extremely straight coast line.

The observations, while valid for northern Chile, have not been proved for southern Chile. In the discussion that follows it is implicitly assumed that the same facts hold true, although it must be remembered that this may not be so. For example, the peninsula of Arauco and a portion of the offshore platform are obviously rising while the coastal strip itself is sinking, perhaps forming a new submarine central valley.

There is always a concentration of activity at either end of the active fault zone with, usually, a section of reduced activity along the main fault. The active area is bounded by a rough quadrilateral some 350 by 1,000 km. The maximum energy released by the earthquakes subsequent to the main shock was near the Arauco Peninsula. The length of the fault that actually moved must have been about 1,200 km. This is analogous to the great Kamchatka earthquake of 1952 [17].

From the strain distribution, it is obvious that the most energy came from the eastern block. This and the greater extent of the deformed zone on the eastern side indicate a greater energy storage in the eastern block, or a fault that dips under the blocks to the east. The changes in elevation of the coast line and islands are such that the fault seems certainly to lie between Isla Guafo, Isla Mocha (fig. 1), and the coast. Also the arguments adduced on the basis of the tsunami indicate an origin near the coast.

The energy radiated by the large earthquake was distributed along this fault and not solely at the epicenter. This means that towns to the south of the epicenter felt the quake more severely than those to the north. The distribution of intensity, as shown by a high intensity

all along the coast from Puerto Saavedra to the south end of Isla Chilóé (figs. 2 and 3), with the observed intensity a maximum at the coast, is quite in accordance with these factors.

The fault movement began in the north and progressed southward. This tended to focus the energy of the surface waves southward and to decrease the period of waves in that direction. Prof. Hugo Benioff,⁶ of the California Institute of Technology, indicated that the fracturing was definitely of a progressive type and that the period of the surface waves, as recorded in Peru, was much greater for the waves arriving by the short arc than for those that went all the way around the world before arriving.

Recent work by Aki [18], using Rayleigh waves, indicates that the aftershocks of the earthquake took place on dextral strike-slip faults, if the faults are parallel to the coast. Benioff, Press, and Smith [19] independently show from seismological observations that the faulting was progressive and that the fault slipped over an extent of 1,200 km.

Aki makes the interesting comment that the faulting in aftershocks near the ends of the zone is predominately dextral strike-slip, and those with vertical movement lie in the central part of the disturbed zone. This speaks clearly of continued tearing at the ends and of vertical readjustment of a secondary nature; perhaps, in part, isostatic in the central part, from which the horizontal shear forces have been temporarily relieved.

It is probable that the first earthquake took place on the Arauco fault near the town of Curanilahue (fig. 1) at a depth too great to permit surface breakage. This quake caused a redistribution in the forces in the earth, causing another part of the fault, just offshore, to move. It is more than likely, considering the distribution of aftershocks, that the great earthquake was produced by slippage along about 1,200 km. of the fault.

The Reloncavi fault probably moved next, and subsequently a series of others in the central valley and coast ranges slipped, giving rise to the many aftershocks. The Reloncavi fault zone seems to mark the eastern side of the area of earthquake occurrence during this series of seisms.

Following further activity on the Reloncavi fault, or a branch thereof, a fracture was opened that was sufficiently large to permit lake or ground water to seep to the level of the hot rocks below, and steam, hot gas, and rock dust escaped through the fracture on the side of Volcán Puyehue (fig. 2).

The volcanoes may well be caused by the divergence between the various fault zones; any tendency of the seaward blocks to drift northward would reduce the pressure on the sides of the block containing

⁶ Personal communication to Pierre Saint-Amand, dated 1960.

the lakes, permitting it to rift and crack, and forming openings for the escape of lava.

ORIGIN OF THE MAREMOTO

In general, the sea withdrew for a period of 10 to 20 minutes and then returned. There were several successive waves, of which the third or fourth seemed largest. The period of the waves was about 20 minutes. In almost all places, the first movement was a withdrawal of the water. In Bahía Mansa, however, the first movement was reported as a rise. A small rise may have preceded the drop in Maullin (fig. 4).

Watanabe and Karzulovic [20] have tried to indicate the epicenter of the earthquake by assuming a velocity for the maremoto and calculating the distance run from some points on the shore, using a velocity altogether too high. Following their lead and using calculated velocities, the following argument is adduced.

The velocity depends on the depth of the water as shown by Airy [21] and elaborated by Lamb [22]:

$$V = (gh)^{1/2}$$

where V is the velocity of the wave with respect to the shore and h is the depth of the water. Although the velocity may reach speeds of 600 km./hr. in the deep sea, the velocity nearer to the shore will be much less. Figure 6 shows the approximate position of a maremoto wave as a function of time from the coast of Chile, using depths given by the charts of the Department of Navegación e Hidrografía of the Chilean Navy. Since the time of arrival of the big wave was between 10 and 20 minutes after the main earthquake, the approximate origin of the sea wave must be nearer to shore than the position indicated by the dashed line.

The times involved in the advance and retreat of the waves are short, being possibly nothing more than that the period of the wave and the distances from the coast are near that of the length of the waves. Hence, such calculations may be meaningless. The shore may have been in the zone of production of the wave. Also, the time rate of change of velocity is high, and the equation does not account for the drag of the bottom nor the change in shape of the wave in shallow waters.

It appears from the foregoing discussion that the wave may have been created in two ways:

1. The dropping of a large block of land offshore could explain the wave, except that the primary movement in Bahía Mansa seems to have been a rise. Perhaps vertical displacement of gigantic blocks

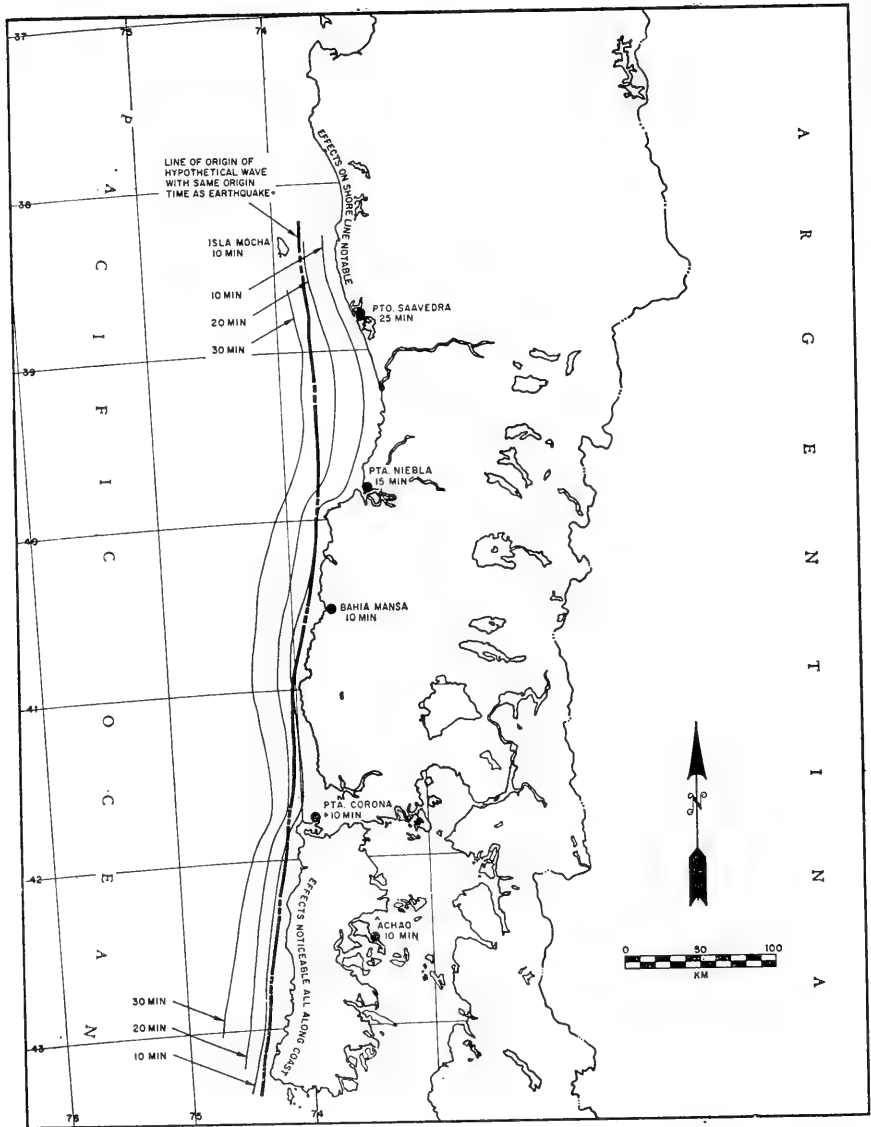

FIGURE 6.—Distance from shore that a wave can travel in indicated times, and estimated position of Maremoto if it began at the same instant as the earthquake.

of the sea floor, during the displacement of the fault, produced a part of the movement.

2. Benioff has, for years, been proposing that tsunamis are generated by the coupling of surface waves in the earth to sea waves [3, 17, 19]. The strain seismograph records from Nana, Peru, show that waves of the correct period existed. The waves may have been produced by a flexing, due to vertical fault movement, or by a vertical warping produced by frictional and inertial forces during strike-slip



1. Concepción 5 minutes after shock of May 22, 1960.



2. Cleaning up rubbish in the streets of Concepción 10 minutes after the main shock.



1. Ship-loading equipment and buildings along Valdivia waterfront severely damaged, caused by slumping.



2. The public square in Puerto Montt. Liquefied soil caused the statue to sink.



1. Damage to Malecón and park in Valdivia resulting from failure of retaining wall and artificial fill.



2. Dock area in Puerto Montt.



1. Damage to good-quality, wood-frame houses in Valdivia caused by solifluction and sliding of the houses toward a small, now abandoned stream channel to the right.



2. Road construction in swampy area near Puerta Varas. The undamaged road can be seen in upper left.



1. The tsunami washed away many houses in Puerto Saavedra. The shoreline is now $1\frac{1}{2}$ meters higher than before, inundating some streets.



2. Dock at Lebu, here $1\frac{1}{2}$ meters out of water, decreased to about $\frac{1}{2}$ meter in 5 months.



1. Dock at Isla Mocha destroyed by tsunami and former shoreline raised $2\frac{1}{2}$ meters. Before, top of concrete was awash at low tide. Picture taken at high tide.



2. Raised beach at Isla Mocha.



Upper: Submergence on the Valdivia riverfront. Lower: Extensive flooding and water damage at Valdivia.



1. Mouth of the Río Pudeto, showing the effects of inundation. Note remains of bridge, the deck of which was washed away by the tidal wave, the submerged road, and the farmlands.



2. View of side of fissure, 100 by 500 meters, on Volcán Puyehue. Note the several bocas and the ash on the ground.



1. Flooded sawmill on Lago Riñihue.



2. Firemen issuing emergency water rations to citizens of Puerto Montt.

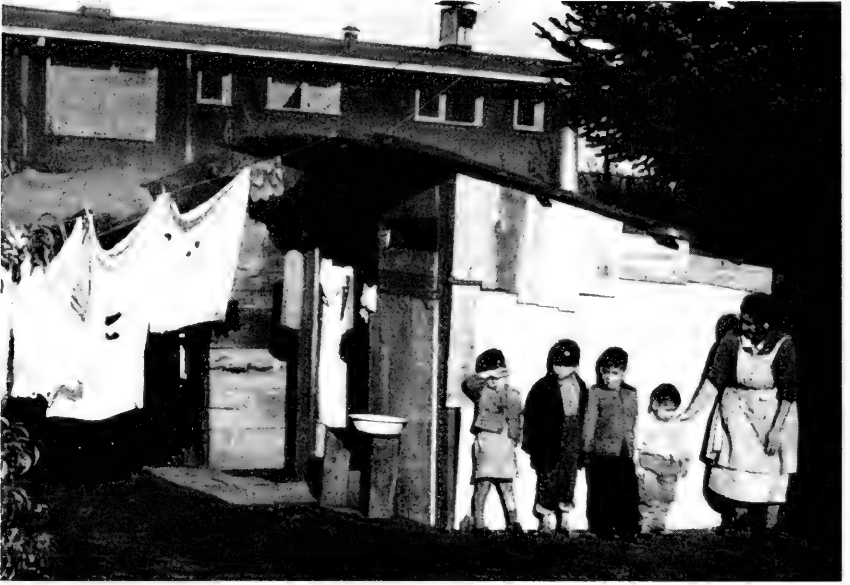

1. Packing boxes serving as a temporary shelter for a family in Valdivia.



2. Damnificados being evacuated from Puerto Montt by American Globemasters.

movement. The very long period waves are probably not ordinary surface waves, as pointed out by Prof. F. Press.

The waves produced by this earthquake were gigantic and of extremely long periods. The whole earth was set in vibration in its fundamental mode and in many of the harmonics thereof. These oscillations continued for a period of some 2 weeks, exhibiting a *Q* factor (or dissipation function) of 170 for 35-minute waves and 380 for 6-minute waves [19]. Both spheroidal and toroidal oscillations were observed. The spheroidal oscillations showed a "Zeeman type" splitting caused by the rotation of the earth.

It is not unlikely that the surface waves, combined with the free oscillations of the earth, produced movements of the earth below the water and along the coast. The land rose and fell—like the chest of a person breathing deeply while on his back in a bathtub—in such a way that the land rose from the sea, the water running off, and then slowly fell, letting the water surge over the subsiding land. Support for this impression comes from the almost simultaneous appearance of the wave at points all along the coast, including, for example, Achao (fig. 3), a small town on the landward side of Isla Chiloié where the tsunami began about 10 minutes after the earthquake [1]. If the waves were produced solely in the Pacific, the disturbance would not have reached Achao for possibly an hour. Isla Chiloié and the contiguous sea bottom must have participated in the production of the tsunami.

SEISMIC HISTORY OF SOUTHERN CHILE

The region affected by the recent earthquakes has been repeatedly subjected to similar events. Greve [23] has summarized his labors and observations, those of Montessus de Balore, and those of the staff of the Instituto de Sismología at Santiago, from 1520 to 1946. In these 426 years there have been 47 notable earthquakes between Santiago and Castro. No notice was taken of the millions of tremors of nondestructive size. Of these 47 earthquakes, 7 have been roughly comparable in magnitude to the main shock of May 1960, and 8 have been associated with tsunamis or similar disturbances of the sea. Of special interest is the seism of 1575, which appears to have had a similar zone of influence, even to having produced a landslide in Río San Pedro.

SUMMARY OF EFFECTS

As of June 1960 large destructive aftershocks were still occurring at intervals of a few days. Many of these were strong enough to have caused a disaster in a more populous region. Shocks in excess of magnitude 6 were sufficiently common that people no longer took much notice of them. These aftershocks will continue for a period of years.

The final count on the dead, missing, and homeless is not yet in, but it is clear that well over 1,000 people were killed, mostly by the tsunami. Several hundred people are still missing, and well over 400,000 new houses are needed. The basic industries in many parts are damaged, and years will be required to complete the reconstruction. Damage totaling over \$417,000,000 (U.S.) was done, according to a report issued by the Corporación de Fomento in mid-August 1960.

The complications of an earthquake of this extent are unforeseeable in total, but it may be learned what needs to be done to prepare for such a disaster. The past is, in this case, the key to the future.

Sorely needed public services failed, and makeshift measures had to be adopted. Among the most important losses were the following:

1. The potable water supplies for Concepción, Valdivia, Osorno, and Puerto Montt were destroyed in whole or in part. Water was delivered by firemen (pl. 9, fig. 2). Recourse was had to old wells, small springs, creeks, and other sources of questionable quality. Filtered river water was subsequently furnished in the larger towns.

2. Electric power was unavailable for at least a week in the aforementioned cities, and for months in outlying towns.

3. Sewage systems were destroyed in part in all the above cities.

4. Medical services were interrupted by serious damage to the hospitals and concomitant loss of equipment, making necessary the introduction of portable hospital units. Most victims were killed outright. Very few were injured and, fortunately, no epidemic began, primarily, because of cold weather and a resistant population. These factors reduced the need for medical care.

5. Roads and railroads were severely damaged. About 500 km. of the Longitudinal Highway will have to be rebuilt because of the failure of subgrades and fills. The railroad was interrupted in various places, but most severely between Osorno and Puerto Montt. Over 6 months were needed to put it in good condition; meanwhile, heavy truck traffic all but destroyed the remains of the roads, and the small waterlogged airfields were soon made into dangerous expanses of mud. Bridge damage was extensive.

6. Dock facilities were largely destroyed by the maremoto, from Lebu, where the docks were lifted out of the water, to Castro where land-sliding destroyed most installations.

7. A breakdown in communications was brought about by the loss of electricity and damage to installations, making accurate reporting of conditions impossible. The loss of the public press prevented the spread of accurate news, a most necessary service. Rumors and civic unrest were most notable in places without newspaper or radio. Reinstatement of communications rapidly alleviated these conditions.

8. Municipal and governmental leadership is the most important loss of all. Plans should be made ahead of time, delegating certain

specific duties to certain people and agencies; all control should remain in local hands. Two outstanding examples of excellent leadership by local authorities occurred in Puerto Montt and Temuco. Here the Intendentes and their assistants immediately organized all the civilian and military agencies, while they themselves retained control of the government. The people were put to work helping themselves and were permitted to move freely while doing so. The prompt and courageous action by these public officials prevented civic disorder and maintained a general air of healthy cooperation during and after the disaster.

9. Losses to homes and public buildings were, of course, grave. Approximately 1 million people were living with neighbors, in makeshift shelters, sleeping in the rain, etc. Plate 10, figure 1, shows a shelter occupied by a family of five in Valdivia.

10. The closing of schools and the appropriation of them for use as emergency shelters were very harmful to the morale of school-age children.

At present, the investigation of the earthquake is being carried out by several teams of engineers, geologists, seismologists, psychologists, and others who are trying to establish norms for reconstruction, and seeking to determine safe places to rebuild and safe techniques for the new edifices and services. A systematic attempt is thus being made to see that the next earthquake in the south will not produce the same type of catastrophe. A number of preliminary reports are available from the IIG, detailing the relation between damage and surficial geology. A list of these is to be found among the references [9, 24-32].

INTERNATIONAL ASPECTS OF THE EARTHQUAKE

The way in which the Chilean populace rose to the immediate emergency was striking. Within a few hours, groups were gathering food, clothing, household articles, and money to send to the stricken area.

The way in which other countries rose to the occasion was equally impressive. Every country in South America, including the Caribbean republics, sent aid in the form of food, clothing, and medicine. They all furnished transportation, including airplanes and helicopters.

The United States began an airlift, bringing materials to Santiago and Puerto Montt, where they were redistributed to the larger fields by Canadian and South American transports. Private pilots, commercial airlines, and crop dusters gave their time and aircraft freely to move the material to outlying districts.

The U.S. Globemasters were also used to remove refugees from the southern area to Santiago (pl. 10, fig. 2).

The material aid that Chile received from its good neighbors was great. Germany offered to finance the rebuilding of Valdivia. Holland offered to rebuild Tolten. Cuba sent two shiploads of sugar. The United States and Canada sent medical teams, field hospital, and supplies. President Eisenhower granted \$20 million for immediate relief, and Congress subsequently voted \$100 million for economic reconstruction. Lamentably, only tens of millions have been used.

Spiritual aid and moral encouragement were equally important, and hemispheric solidarity was reaffirmed, as it was in 1906 when Chile sent a relief mission to San Francisco, Calif., following the famous earthquake that devastated that city.

REFERENCES

1. ANDRADE, ALBERTO. El maremoto del 22 de Mayo de 1960. Bol. Información Dept. Navegación e Hidrografía de la Armada de Chile, Año 16, No. 56, 11 pp., Aug. 31, 1960.
2. COFRE, CAUPOLICÁN. Erupción del Volcán Nilahue. An. Facultad Ciencias Físicas y Matemáticas, Univ. Chile, vol. 13, p. 73, 1956.
3. GUTENBERG, BENO, and RICHTER, CHARLES F. Seismicity of the earth, 267 pp. Princeton Univ. Press, 1949.
4. BRUGGEN, JUAN. Fundamentos de la geología de Chile, pp. 286-289. Santiago, Chile, Inst. Geogr. Militar, 1950.
5. KRUMM, FEDERICO. Sociedad Científica Argentina, An., Tomo 96, p. 191, 1923.
6. KRUMM, FEDERICO. Geol. Rund., vol. 14, p. 146, 1923.
7. WEISCHET, WOLFGANG. Contribuciones al estudio de las transformaciones geográficas en la parte septentrional del sur de Chile por efecto de sismo del 22 de Mayo de 1960. An. Facultad Ciencias Físicas y Matemáticas, Univ. Chile, Publ. No. 15, vol. 17, p. 23, 1960.
8. BAUER, PETER PAUL VON. Augenzeugenbericht zum Erbeben vom 22 Mai in Ensenada, Sudchile. Erdkunde, vol. 19, 1960.
9. ALVAREZ, LEONARDO. Informe sobre los estudios realizados en la zona comprendida entre la Península de Arauco y Valdivia, con motivo de los sismos ocurridos el 21 y 22 de Mayo de 1960. Santiago, Chile, Inst. Investig. Geol., 1960.
10. FITZROY, R. Sketch of the surveying voyages of His Majesty's ships *Adventure* and *Beagle*, 1825-1836. Geogr. Journ., vol. 6, pp. 311-314, 1836.
11. FITZROY, R. Narrative of the surveying voyages of His Majesty's ships *Adventure* and *Beagle* between the years 1826 and 1836, vol. 2, pp. 402-418. British Admiralty, 1839.
12. MÚÑOZ-CHRISTI, JORGE. Geología de Chile. In Geografía Económica de Chile, 428 pp., Santiago, Chile, Imprenta Universitaria, 1950.
13. FUZALIDA, HUMBERTO. Orografía. In Geografía Económica de Chile, pp. 35-43. Santiago, Chile, Imprenta Universitaria, 1950.
14. FENNER, R., and WENZEL, O. El Terciario Carbonífero de Arauco. An. Primer Congreso Panamericano Ingeniería de Minas y Geología, vol. 3, pt. 2, pp. 1000-1029, January 1942.
15. LOMNITZ, CINNA. Investigaciones, gravimétricas en la región de Chillán, Bol. No. 4, Santiago, Chile, Inst. Investig. Geol., 1959.
16. SAINT-AMAND, PIERRE. Two proposed measures of seismicity. Seism. Soc. Amer. Bull., vol. 46, No. 1, January 1956.

17. RATH, MARCUS, and BENIOFF, HUGO. The aftershock sequence of the Kamchatka earthquake of November 4, 1952. *Seism. Soc. Amer. Bull.*, vol. 48, pp. 1-15, 1958.
18. AKI, KEIITI. Further study of the mechanism of circum-Pacific earthquakes from Rayleigh waves. *Journ. Geophys. Res.*, vol. 65, No. 12, pp. 4165-4172, December 1960.
19. BENIOFF, HUGO; PRESS, FRANK; and SMITH, STEWART. Excitation of free oscillations of the earth by earthquakes. *Journ. Geophys. Res.*, vol. 66, No. 2, pp. 605-619, February 1961.
20. WATANABE, TAKEO, and KARZULOVIC, JUAN. Los movimientos sísmicos del mes de Mayo de 1960 en Chile. *An. Facultad Ciencias Físicas y Matemáticas, Univ. Chile*, vol. 17, pp. 23-64, 1960.
21. AIRY, SIR G. B. Tides and waves. Article 208 in *Encyclopedia Metropolitan*, 1845.
22. LAMB, SIR HORACE. *Hydrodynamics*, pp. 262 and 730. New York, 1945.
23. GREVE, FEDERICO. Determinación del coeficiente de seguridad antisísmico para las diferentes zonas de Chile. *An. Facultad de Ciencias Físicas y Matemáticas, Univ. Chile*, vol. 5, No. 5, pp. 3-19, 1949.
24. THOMAS, HERBERT; BOWES, WILLIAM; and BRAVO, NELSON. Informe geológico sobre los efectos del terremoto del 22 de Mayo 1960 en la ciudad de Puerto Varas. Santiago, Chile, *Inst. Investig. Geol.*, 1960.
25. THOMAS, HERBERT; BOWES, WILLIAM; and BRAVO, NELSON. Informe geológico sobre los efectos del terremoto del 22 de Mayo 1960 en la ciudad de Río Negro. Santiago, Chile, *Inst. Investig. Geol.*, 1960.
26. THOMAS, HERBERT; BOWES, WILLIAM; and BRAVO, NELSON. Informe geológico sobre los efectos del terremoto del 22 de Mayo 1960 en la ciudad de Llanquihue. Santiago, Chile, *Inst. Investig. Geol.*, 1960.
27. THOMAS, HERBERT; BOWES, WILLIAM; and BRAVO, NELSON. Informe geológico sobre los efectos del terremoto del 22 de Mayo 1960 en la ciudad de Maullin. Santiago, Chile, *Inst. Investig. Geol.*, 1960.
28. GALLI, OLIVER; SÁNCHEZ, CARLOS; and SÁNCHEZ, JOAQUÍN. La geología y los efectos de los terremotos de Mayo de 1960 en Concepción y Alrededores. Santiago, Chile, *Inst. Investig. Geol.*, 1960.
29. GALLI, OLIVER; SÁNCHEZ, CARLOS; and SÁNCHEZ, JOAQUÍN. Redacción entre la geología y los efectos de los terremotos de Mayo de 1960, en la ciudad de Castro y Alrededores, Chiloé. Santiago, Chile, *Inst. Investig. Geol.*, September 1960.
30. GALLI, OLIVER; SÁNCHEZ, CARLOS; and SÁNCHEZ, JOAQUÍN. Relación entre la geología y los efectos de los terremotos de Mayo de 1960, en la ciudad de Ancud y Alvededores, Chiloé. Santiago, Chile, *Inst. Investig. Geol.*, September 1960.
31. DOYEL, WILLIAM W.; MORAGA, ALDO; and FALCON, EDUARDO. Relaciones entre la geología de Valdivia (Chile) y los danos causados por los terremotos del 22 de Mayo de 1960. Santiago, Chile, *Inst. Investig. Geol.*, August 1960.
32. DOBROVOLNY, ERNEST; LEMKE, RICHARD; BOWES, WILLIAM; THOMAS, HERBERT; and BRAVO, NELSON. Relación entre la geología y el dano producido por el terremoto del 22 Mayo de 1960, en Puerto Montt, Chile. Santiago, Chile, *Inst. Investig. Geol.*, August 1960.

The Rim of the Reef¹

By E. YALE DAWSON
*Allan Hancock Foundation,
University of Southern California*

[With 8 plates]

DREDGE DOWN! The gears of the bow winch mesh; the great spool turns, and the steel cable pays out as the biological dredge is lowered into the tropical sea. Fifty fathoms below is a submerged, flat-topped mountain, the Gorda bank. We are here to seek what lives on that submarine butte.

So it was, 20 years ago, when the research vessel *Velero III* was exploring the strange biota of the Gulf of California. I was, as a fledgling marine botanist, witnessing dredging from a ship for the first time in my career. We were over the bank, and now were blindly scraping off a bit of its surface to bring to light the creatures of the dim sea floor, almost at the uttermost limits of light.

The dredge came up full. Its great bag-load, bulging within a protective chain skirt, was poised for a moment over the sorting screens. The closing cord was cut, and out poured a pile of shiny nodular pebbles, each an inch or two in diameter. But these were strange stones indeed, covered with warts and knobs, and all of a rose-pink color. In fact, there was not a stone in the lot. This was a dredge load of plants—stone plants of the sea—the calcareous red algae known collectively as nullipores.

In the days of lace cuffs and powdered hair, these curious plants were generally considered to be some kind of inorganic, stalactite-like form. They found their way into "collectors' cabinets" of the time along with corals, worm tubes, walrus tusks, and other novelties of the sea. Linnaeus treated them as coral-like animal forms. Indeed, Lamarck coined their name—*nullipore*—to distinguish these forms "without visible pores" from the porous corals. It was not until 1837 that the stones were finally and positively recognized as plants.

Today we recognize calcareous forms in each of the three major groups of marine algae—the green Chlorophyta, the brown Phaeo-

¹ Reprinted by permission from *Natural History*, vol. 70, No. 6, 1961.

phyta, and the red Rhodophyta. Among marine green algae, calcified forms occur only in a few families, largely confined to warm seas. Indeed, relatively few genera and species of green algae are calcareous. Nonetheless, in their tropical habitats these plants are often remarkably abundant, and sometimes are among the most conspicuous members of the local marine community. Thus, on some of the gently shelving, intertidal flats of Okinawa, one wades ankle deep in a veritable meadow of *Acetabularia*—acre upon acre of almost pure stands of these remarkably beautiful little green parasols. In the sandy bays of Cuba, the Bahamas, and south Florida, one finds an abundance of the strange Neptune's shaving brush (*Penicillus*), the little Christmas-tree-like *Rhipocephalus*, and the delicate green, fan-like *Udotea*. Among the coral heads and rubble flats on the bottoms of the vast atoll lagoons of Kwajalein or Eniwetok, mounds and mats of *Halimeda* grow in such persistent plenty that the lagoon floor sediments are largely built up of the accumulated fragments of these jointed plants.

Then there are the strangely and intricately fashioned species of the family Dasycladaceae: *Dasycladus*, *Bornetella*, and *Neomeris*. These are tiny little plants, often inconspicuous, but sometimes the most striking members of an undersea flora. I remember diving one day in a warm island lagoon in the Gulf of California and being impressed by great, round boulders on the bottom that were studded with little glistening, upended "worms" of a brilliant emerald color—the green alga *Neomeris*. Many members of this family are known from the fossil record and have contributed to the formation of limestone rocks.

Among the brown algae, calcareous species are few, confined largely to the tropical genus *Padina*, whose interesting, fan-shaped representatives may be found in almost all warm seas. *Padina* commonly has concentric bands of superficial calcium carbonate alternating with bands of delicate yellow-brown hairs and underwater sometimes stands out as the most gracefully formed and artfully patterned plant of the sea floor.

In red algae, as in the other two groups, the occurrence of calcified forms is limited to a few families. One of these, however—the Corallinaceae—is of wide distribution. The only other important calcareous genera of red algae are *Galaxaura*, *Liagora*, and *Peyssonnelia*. These occur mostly in the tropics, but are seldom abundant or conspicuous.

Thus, the Corallinaceae includes the overwhelming majority of the calcareous plants of the world. They occur from the Arctic to the Antarctic and from the highest and most inhospitable intertidal levels to the cold, dim depths of ocean at the extreme limit of light penetration. Sometimes a score of species may live in a single habitat. Again,



Air view of Marshall Island atoll, showing surf on reef's algal rim and tiny islets built upon the reef flat.

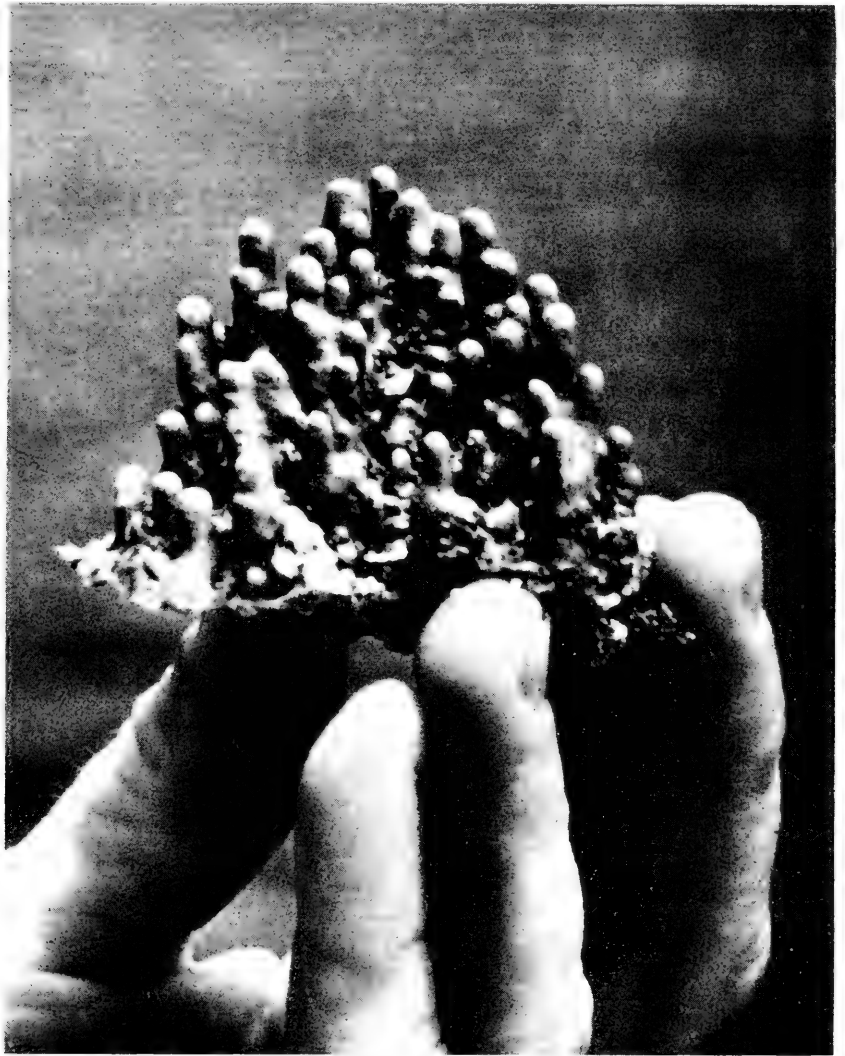

Nullipore fragment typifies one of the many kinds of stony plants that grow on seaward margins of reefs.

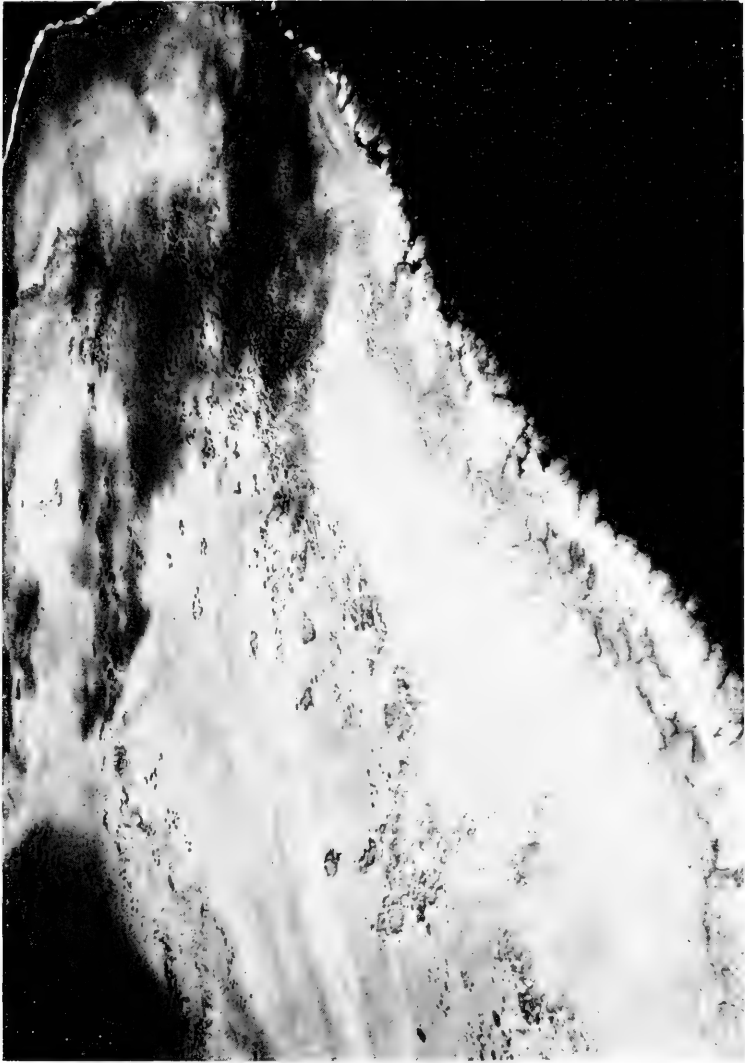

Tongatabu, in the South Pacific, is an example of combined building action of coral animals and the calcareous algae.

REPRODUCTION OF RED ALGAE

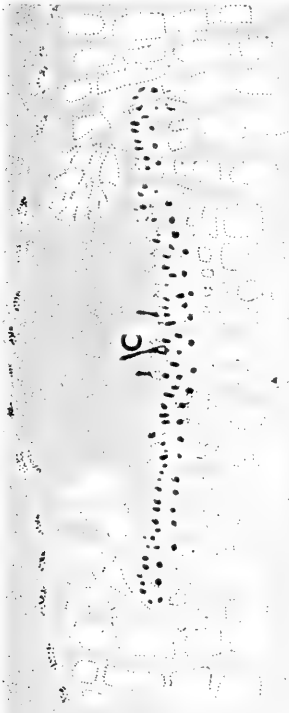

TETRASPORES grow into separate male and female plants. Larger female conceptacle produces reproductive organs called carpogonia (C, above). Meanwhile, the conceptacle of male plant, below, discharges non-motile spermatia (D).

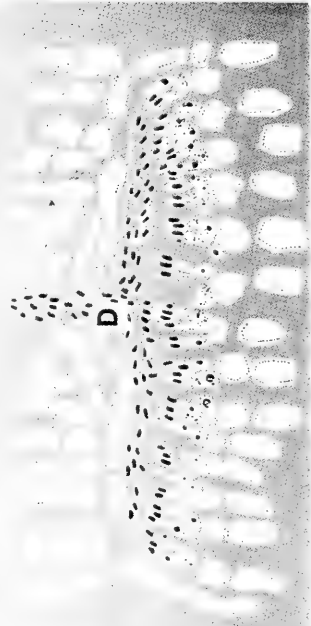

LITHOPHYLLUM, a calcareous red alga, reproduces by an alternation of generations. Here, tetraspores (A) form in conceptacles borne on non-sexual plants, and are then released into the water through exit pore (B) in cavity.



TRICHOCTYNE—sensitive, tubular, hairlike extension (E)—forms on each carposonium in female conceptacle, *above*, readying it for fertilization. In fertilized female cell, *below*, early stage in carpospore (F) development is seen.



CARPOSPORES mature (G), are discharged through pore into sea water. They germinate on some rocky surface that is as yet unoccupied, and a new generation of non-sexual plants begins to develop, starting the cycle over again.





Elevated margin of the seaward reef on Majuro Atoll in the Marshall Islands is almost totally made of red algae.

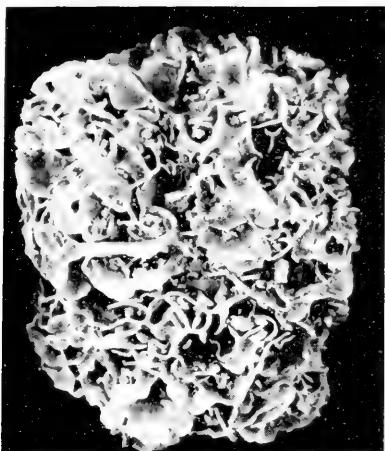

1. One of the intricately sculptured species of *Lithophyllum* widely associated with algal reefs in the Pacific.



2. Palmyra Island, a small eastern Pacific atoll with an irregular array of narrow islets scattered over the broad reef flat and new sand islets in the upper left.

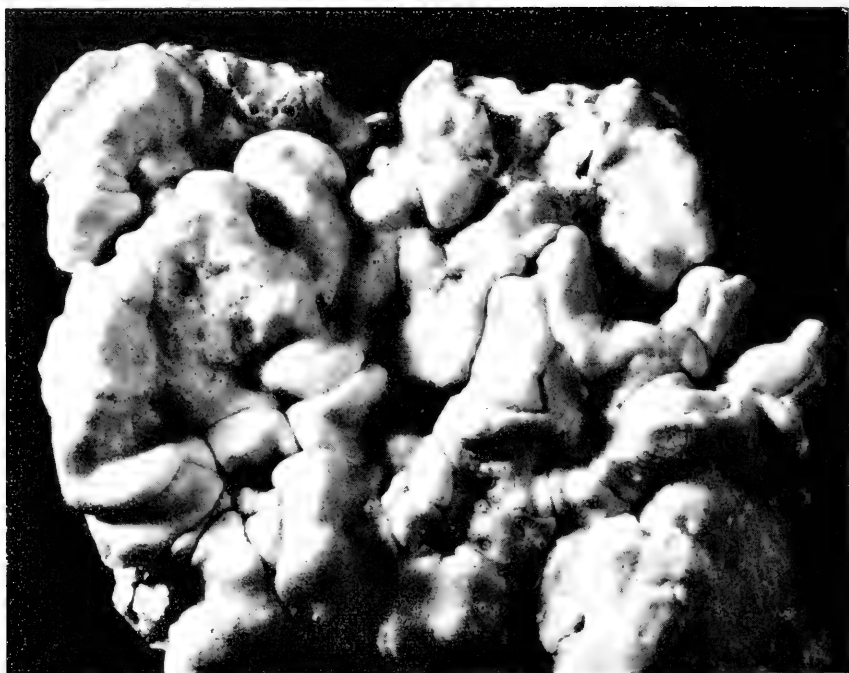

1. Recently discovered calcareous alga is *Lithophyllum reesei*, found on the west coast of Mexico. Shapes of algae are nearly as numerous as are species.



2. Lush vegetation on Palmyra Atoll, in Line Islands of Pacific, is rooted in the reef flat's calcareous sand and gravel.

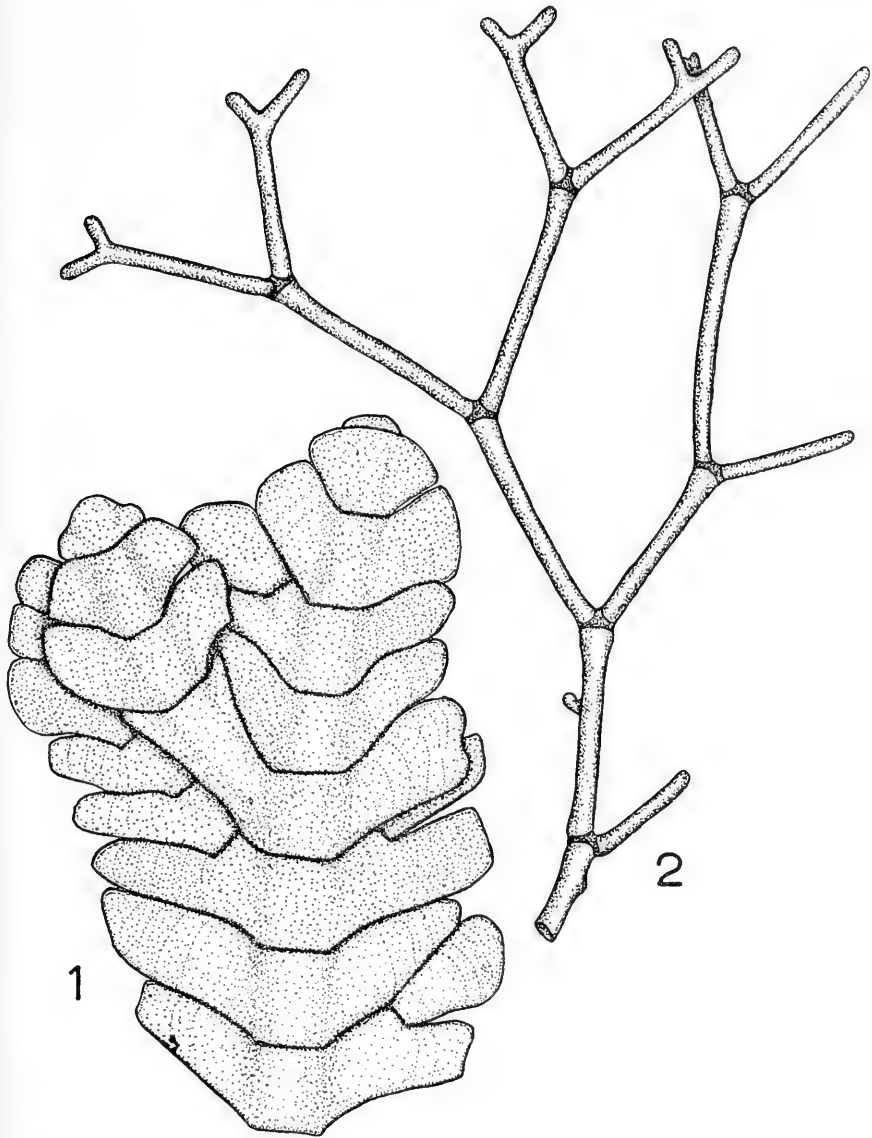

FIGURE 1.—*Bossiella*, with segments of wingnut shape, is found in California coastal waters.
 FIGURE 2.—*Jania* genus includes this species of dainty, branched red alga of warm waters.

one species may dominate a region to the near exclusion of other forms of vegetable life.

Despite the rigidity and often brittle character of many calcareous algae, the structural differences from the usual, fleshy forms are essentially eliminated by the application of a few drops of hydrochloric acid. Removal of the carbonate reveals the typical cellular structure of the plant, hitherto obscured by encrustation.

The stony material laid down by the living cells of the plants is largely calcium carbonate, although some magnesium carbonate is present. This takes the form of calcite in the Corallinaceae and of aragonite in the other red algae. While the encrustation first appears in pectin-bearing layers of the cell walls and then extends into the cellulose layers, the living protoplast of the cells always remains enveloped by an uncalcified membrane.

In the segmented corallines, some groups of cells remain completely uncalcified, thus forming flexible joints between rigid segments. Such a delicate, erect, bushy plant as *Corallina* is admirably suited to surf shock and agitation—hardly less so than is the rigid, rock-encrusting *Lithophyllum* with which it may grow.

The calcareous red algae, like most of the members of this large plant phylum, fulfill their life history by means of an alternation of generations (see pls. 4 and 5). That is to say, a given plant does not reproduce one of the same kind as itself. Instead, it gives rise to a different generation of plants, and these, in their turn, repeat the first generation. These generations are of two kinds: one is sexual, and consists of separate male and female plants. The other is asexual, producing spores that germinate to grow into sexual plants.

At maturity, the asexual plants form small, domed cavities on their exterior surfaces. These asexual conceptacles produce small, red structures consisting of four spores in a row (tetraspores). The spores are released into the water by means of one or more exit pores from the cavity. The released spores then settle down, germinate, and grow into new plants. Some grow into male and some into female plants which, except for reproductive details, look very much alike.

The male plants produce quite small conceptacles in which are formed exceedingly minute, non-motile, male cells (spermatia). These, usually only $\frac{1}{4000}$ of a millimeter in diameter, are released into the water through a pore in the conceptacle roof.

Meanwhile, the female plants have produced much larger conceptacles, on the floors of which stand minute receptive organs called carpogonia. Each carpogonium has a sensitive, tubular, hairlike extension, called a trichogyne. This organ probes the empty space beneath the conceptacle pore, waiting for the stimulus of contact with one of the many male spermatia that are then drifting freely about in the surrounding water.

By what mechanism the drifting, but nonmotile male cell enters the tiny pore of the female conceptacle to accomplish the sexual union we do not know. When a spermatium does make contact with a trichogyne, however, its nucleus enters the carpogonium, effects sexual fusion, and so begins the development of a new generation. Strangely, this new generation remains as a distinct parasitic plant

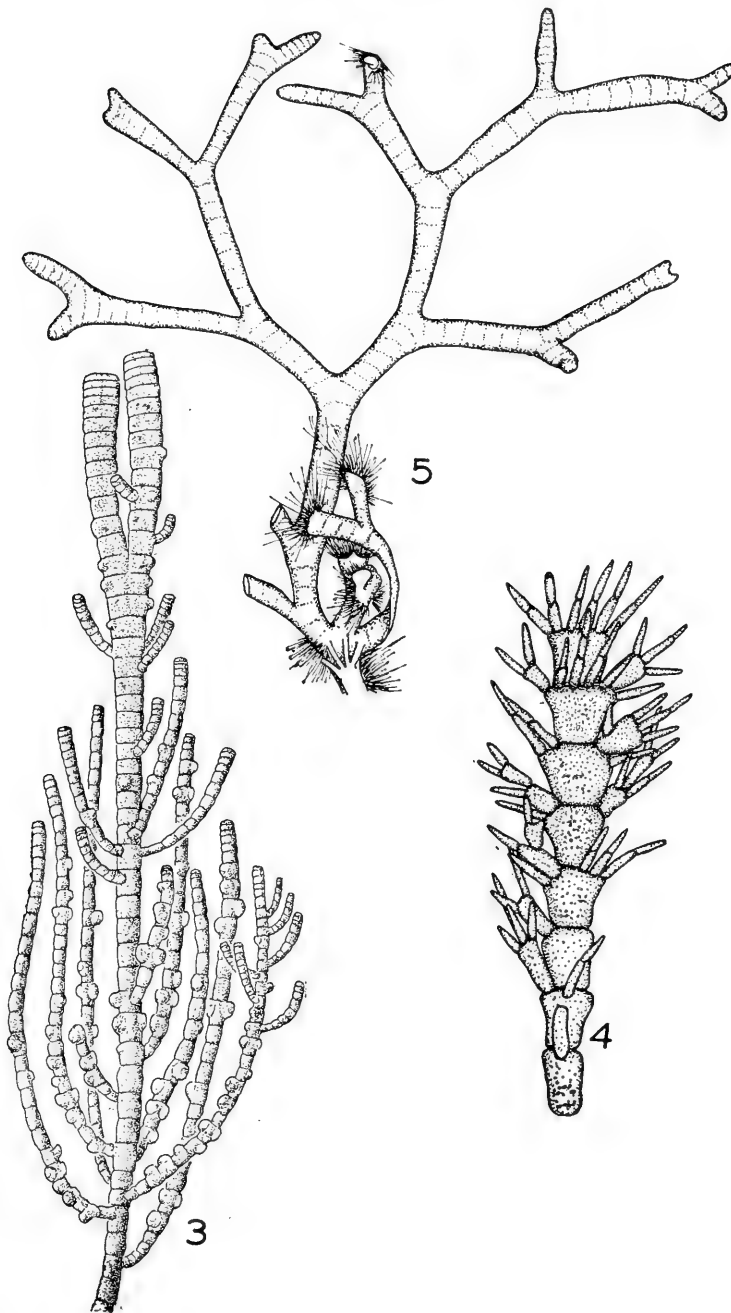

FIGURE 3.—*Lithothrix*, a red alga of the northeast Pacific, has unusually short segments. FIGURE 4.—*Corallina polysticha* is a rare, jointed red alga from Guadalupe Island, Mexico. FIGURE 5.—*Galaxaura acuminata*, a nonsegmented red alga, is a tropical Pacific species.

within the female plant. There it grows into a small mass of cells and produces a special group of spores inside the old female conceptacle. Each of the spores must now be released in its turn—through the same pore by which the male cell entered—into the sea water outside. There it finds a rocky surface yet unoccupied, upon which to spread the first cells of a new, non-sexual generation.

Calcareous members of the red algal family Corallinaceae are the most prevalent of the stone plants, so widely distributed that they form part of the marine flora of every maritime nation of the world. In the glacial fiords of Norway or Greenland one finds thriving beds of nullipores. Crustose corallines cover wave-beaten rocks from Kamchatka to Chile, and from Newfoundland to Kerguelen. Delicate, flakelike forms live on the leaves of turtlegrass in Cuba, and on eelgrass in Japan. The jointed bossiellas dwell no less successfully in the cold, clean tide pools of Vancouver Island than beside sewer outfalls in southern California. The dainty jantias are equally prominent in spongy, algal turfs on the reef flats of East Africa and in those of Micronesia. Despite the ubiquity of these plants, they have been little studied and remain among the least-known organisms of the sea.

Since plant scientists have generally neglected the calcareous algae, their importance in many natural phenomena has been little recognized. This is particularly true of one of the most extraordinary of all marine geological phenomena—the tropical “coral” atoll. The story of the calcareous algae’s contribution to the formation and growth of the atoll is so remarkable and so little known that it seems particularly appropriate to tell something of it here.

During the last century, a number of naturalists made visits to the coral reefs of the Indo-Pacific region and, from their observations, theories of atoll origin and growth were developed (Natural History, March and April 1959). Charles Darwin, James D. Dana, Sir John Murray, Alexander Agassiz, Reginald A. Daly, and others interpreted the atoll from a geological or zoological standpoint. But each investigator failed in every instance fully to recognize the importance of calcareous algae as controllers of reef development. It was not until Sir Edgeworth David’s South Pacific expedition (1896–1898) that evidence was obtained to establish the significance of plants in this relationship. Since then only an occasional marine botanist has written on the subject and expanded the knowledge of the role algae play in atoll formation. As a result, some long-standing and widespread misconceptions are still prevalent.

Some of the pertinent facts are: First, nullipores have been found to be among the principal components of atoll reefs in a great majority of cases. In some instances, they are almost the only visible components, to the virtual exclusion of coral animals.

Second, the principal cementing agent in the reefs is the nullipore.

Third, calcareous algae have been found actively working at depths of 600 feet.

Fourth, the seaward margins of actively growing atoll reefs are often covered by a pavement-like growth of *Porolithon*, a species of nullipore.

Fifth, borings to depths of several thousand feet indicate the consistent presence of great quantities of nullipore material throughout the reefs.

The most striking first impression of many atolls is of their enormous size. Tens of thousands of servicemen have visited the vast lagoons of Kwajalein or Eniwetok, 30 miles or more across, surrounded by dots and lines of vegetation-clad islets. But these atolls have not always been so large. They grew, and are still growing.

One also finds small atolls, such as Palmyra in the Line Group, and nearby reefs, such as Kingman, that barely break the surface of the water. All these are related within the atoll phenomenon. To understand an atoll's development, it must be considered as a kind of dynamic, living organism. It is, really, a vastly complex association of living things, all dwelling together in a marvelous balance, each plant and animal contributing to the life and growth of the whole atoll and to the delicate balance maintained between construction and destruction.

As a possible point of departure in the development of an atoll, consider a reef such as Kingman, consisting of an association of coral animals and coralline algae, growing on a slightly submerged sea mount. Let us say that the reef is 5 acres in extent and barely breaks the surface at low tide. Now, somewhat different optima for growth and persistence exist among the corals and the nullipores with regard to the surf that breaks over the reef. The rigid, branched, brittle corals tend to break and fragment under severe wave action. But the massive, reef-forming nullipores are unaffected by the pounding surf. In fact, the stronger the surf the better they grow, for one of the principal factors for their growth is the availability of oxygen for their respiration during the dark hours of the night, when their photosynthetic pigments are inactive.

Accordingly, on this 5-acre reef, the first organisms to grow above the water surface, creating a condition of surf, will also create conditions that tend to favor the growth of the nullipores and to reduce the upward extension of the coral. Herein begins the formation of an atoll from a reef, for the nullipores grow into the breaking surf. As they do so, the intensity of the surf becomes greatest around the margins of the reef. Here the nullipores grow upward and form a rim slightly above sea level. This rim, which breaks the impact of

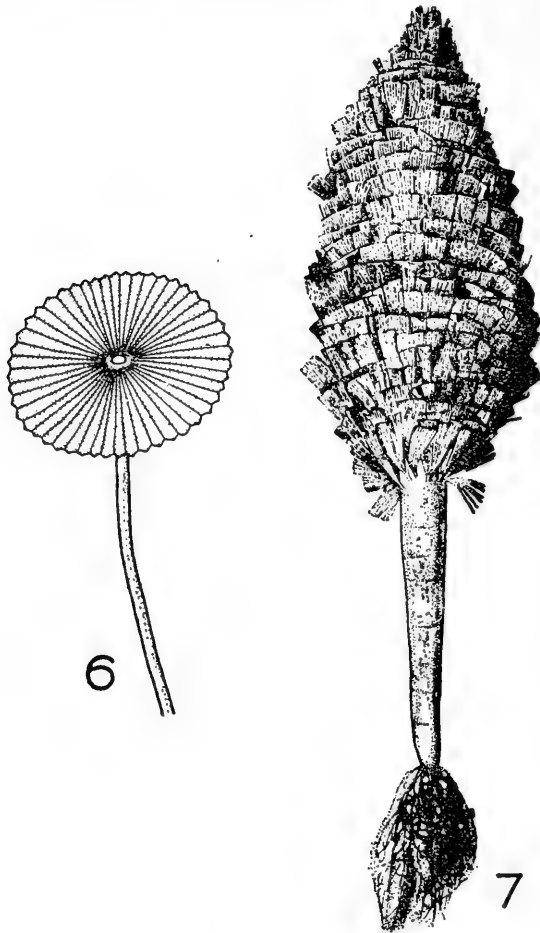

FIGURE 6.—*Acetabularia*, a handsome, tropical green alga, is shaped like a gay umbrella.
 FIGURE 7.—*Rhipocephalus* is a small, "treelike" green alga found on the Caribbean shores.

the waves on all sides, provides a relative calm over the inner part of the reef. If the sea level is rising, or the sea floor subsiding, a lagoon develops within the slightly elevated ridge, aided by the destructive process of solution resulting from the action of carbonic acid derived from the respiratory carbon dioxide produced by the life of the lagoon.

The rate of outward growth of the reef margin reflects differences in surf and in available growth nutrients, due to wind and currents. As a result, the young, dynamic atoll usually takes on a somewhat elliptical shape.

Reef margins are extended seaward in three ways: by the growth and cementing action of the nullipores, by the often profuse growth of corals on the outer front, or face, of the reef below the surf zone, and by the infinitely slow build-up of a vast talus slope of nullipore

and coral fragments to the abyssal sea floor. Whenever the reef ridge dissolves down to a level that permits the sea waves to pour in over it, the increased supply of oxygen for nighttime respiration encourages the growth of the pavement algae by which it is built up again.

The seaward advance of the nullipore ridge, whose height above sea level is controlled by desiccation, leaves behind it a reef flat that stretches between the ridge and the central lagoon. Storms cast up boulders and debris from the reef margin and the talus slope onto this reef flat.

Until such a pile of sand and rubble appears on the reef flat, all rain water is dissipated into the open sea. With sufficient material to confine it, however, the fresh rain water stands in the sand at sea level, floating on the salt water below it, and mixing only very slowly. As a pool of fresh water forms in the sand, seeds (carried to the islet by wind and sea) sprout and penetrate to the water supply, and thus the island vegetation comes into being. Sea birds come, and as they feed on the fish of the reefs and lagoon, and nest in the vegetation, they convert animal life of the sea into fertilizer for the land. The birds thrive, trees and shrubs grow, and gradually humus forms on what at first was only barren sand and rock.

In all this atoll growth, the calcareous algae play an important role, spreading their crusts over the rubble and the sand, cementing and binding the reef margin, and advancing—ever so slowly, but steadily—into the waves.

What's Happening to Water?¹

By CHARLES J. ROBINOVE
U.S. Geological Survey, Washington, D.C.

[With 1 plate]

What is happening to water? In the early days of the United States, when the population was small and widely scattered, water was not a problem. Most people took water from streams or from dug wells for their personal use or for town distribution systems. Waterpower developments were made on streams in which water wheels could be run for mills. The total use of water in the United States and the average use per individual were not high, and the demands upon the total water supply of the country were small. The problems of water supply through the 19th century were not great—enough water was available for most users. If the supply might be short in one area, it could be supplemented from another; if the quality of surface water was poor for a particular industry, the ground water in the immediate area might be usable.

Since that time the American way of life has changed. Water is used for countless purposes, many of which were not dreamed of 50 years ago. The same water may be used over and over again in processes where it is not consumed, such as waterpower or cooling, or it may be consumed by irrigation or industry.

Today, the problems of water and water conservation are paramount in the minds of many people in the United States. Large organizations, both within and outside the Government, are concerned with the investigation of water resources, the development of water, and the proper management of water. More and more we hear that water is the "limiting factor" in developments of irrigation, industrial, waterpower, and municipal projects. It is apt to quote here the words of Oscar E. Meinzer, who, in an article entitled "Our Water Supply" in the 1937 Annual Report of the Smithsonian Institution, said, "Deprived of water, all plants and animals would perish.

¹ Publication authorized by the Director, U.S. Geological Survey.

Deprived of water, the human race, with all its thought and emotion and spiritual aspiration, would come to prompt oblivion.”²

The American people have become alert to the importance of water in our life and economy. The news media—television, radio, and newspapers—carry stories about pollution of streams, falling water tables, short supplies of water, and the decreasing number of sites left for major waterpower development. Stories are calculated to awaken the reader to the problems of water in the United States and to his responsibility to be aware of these problems and to take part in their solutions. In many instances the stories are exaggerated, but the problems are real.

In 1960 nearly 270 billion gallons of water per day, or about 1,500 gallons per day per person, was used in the United States (MacKichan and Kammerer, 1961). Of this total, 61 billion gallons per day was consumed and was not available for reuse. The estimated and projected withdrawals of water from 1955 to 2000 indicate that in 1980 our use of water will be more than double that in 1960 (fig. 1). The estimates for 1980 and 2000, however, may be greatly in error if reuse of water is practiced more widely and intensively than it is now.

The water that we use comes from many sources which may be shown as parts of a general picture of water movement on the earth.

THE HYDROLOGIC CYCLE

The major reservoirs of water on the earth are the oceans, and they form one link in what is known as the “hydrologic cycle.” The hydrologic cycle describes the circulation of water from the ocean into the atmosphere; the movement of atmospheric moisture across oceans and over the continents; the precipitation of moisture as snow and rain; the flow of water in streams and lakes; the evaporation and transpiration of water from the surface back into the atmosphere; the movement of water beneath the surface of the ground; and the discharge of water back into the ocean to continue its endless journey. The hydrologic cycle is continuous and cannot be easily separated into its various phases, and in turn its phases are made up of endless and complex details. Water in any one phase of the cycle cannot be treated as a single subject. It must be considered in relation to its total natural environment, to its use by man, and as a function of time.

Let us begin by considering the moisture in the atmosphere. Water evaporates from the surface of the ocean. It rises in the air and is borne by winds over the landmasses, where a part of it condenses and falls as rain or snow. In the western United States most moisture is brought from the Pacific Ocean and carried east. When winds from the Pacific Ocean meet the west coast, the warm moisture-laden

² Meinzer, O. E., Our water supply. *Ann. Rep. Smithsonian Inst. for 1937*, p. 292, 1938.

air is lifted high over the mountains and becomes cooler. The cool air cannot contain as much water vapor as warm air and so the moisture falls as rain or snow on the western slopes of the coastal ranges and the Sierra Nevada. East of the coastal ranges and the Sierra Nevada the air is drier; there is less moisture to precipitate and fall; and as a result, the region between the coastal areas and the Rocky Mountains is arid or semiarid. The lifting and drying effect of the continental mass is again shown as the air reaches the Rocky Mountains. Precipitation is greatest on the western slopes of the Rocky Mountains; the drier air moves across the mountains to the eastern slope, where the precipitation is less.

Precipitation in the central part of the United States increases as additional air masses moving from the Gulf coast, the Atlantic, and the Arctic region bring moisture-laden air over the continent.

Water is abundant in the United States. If all the precipitation that fell within the limits of the 48 conterminous States during an average year were to be spread evenly over the country, it would stand 30 inches deep. However, as the pattern of air movement indicates, this precipitation is not spread evenly over the United States. Some areas receive only a few inches of rainfall during the year, while others receive as much as 100 inches.

The water represented by the average 30-inch depth is about 4,800 million acre-feet per year, or about 4,400 billion gallons per day. This is an enormous amount of water, but unfortunately not all of it is available for our use. Of the 30 inches of water, about 21½ inches is evaporated from open water areas or is transpired from the soil and the leaves of plants and thus returned to the atmosphere. Only part of this 21½ inches supports cultivated crops, native grass, and forests; the rest is evaporated or used by nonbeneficial plants.

The remaining 8½ inches of rainfall moves over the ground to streams as "direct runoff," or seeps to the water table to become "ground water," later to discharge into streams as "ground-water runoff." Of the 8½ inches, man withdraws from streams, lakes, reservoirs, springs, and wells the equivalent of about 2 inches (but in part this represents the same water used over again) and uses it for municipal and rural water supplies, industry, and irrigation. About half an inch evaporates or is transpired, in part as a result of the activities of man (principally irrigation) and in part by natural means in the Great Basin. The remainder joins the "unused" water to make a total of about 8 inches flowing into the oceans. Actually, the "unused" water is used too, though not "withdrawn"—for hydro-power (to an extent equivalent to nearly twice the average stream-flow), for dilution of sanitary and industrial wastes, for navigation, and for recreation and fish and wildlife.

The general disposal of the 30 inches of precipitation received is shown diagrammatically on plate 1, in which the quantities are rounded off to whole numbers.

The 8½ inches of runoff represents, virtually, our manageable water supply. Management of water consists of solving the general problem—national, regional, or local in scope—of how to obtain perennial supplies of water of usable quality at a reasonable price at desired locations for specific uses. Each area of the Nation has several water problems that require solutions, and these may differ greatly from those in other areas of the country.

WHAT WE KNOW OF THE HYDROLOGIC CYCLE

Much is known about the fundamentals of hydrology and the laws that govern the occurrence and movement of water on and below the surface of the earth. Research directed to finding these facts has been a continuing and accelerated program throughout the United States and elsewhere and has been carried on by governmental agencies, universities, and foundations. A great deal has been learned, but a great deal more remains to be understood.

The mechanics of precipitation of water from atmospheric vapor as rain, hail, and snow is fairly well known. However, we still do not understand the distribution of precipitation in time and space well enough to predict how much rain or snow will fall where and when—to say nothing of being able to influence them. Stations for the recording of precipitation and temperature are scattered throughout the United States, but most of them are in heavily populated areas. However, much of the precipitation falls where the population is small and scattered, such as the mountainous areas of the West, which furnish a large part of our water, and records from these areas are spotty and inadequate. More has to be learned about the distribution of precipitation in these areas before we can understand and predict our primary source of water (Langbein and Hoyt, 1959, p. 41).

When water reaches the land surface, a portion soaks into the ground and is stored as soil water which is available for the growth and nourishment of plants. This zone of soil moisture may at times be completely saturated with water—that is, all the pore spaces between the grains of soil and rock may be filled with water, or they may be only partially filled. We need to know more about the mechanism of the filling and draining of the soil-moisture zone. We also need to know a great deal more about how much water is extracted by crop plants and native plants from this soil-moisture zone and how much water is evaporated from the land.

Between the zone of soil moisture and the water table is the zone of aeration. Water in excess of the amount (“field capacity”) that the

soil can hold moves downward under the force of gravity. The mechanics of the movement of water in this zone are complex and not so well understood as the movement of water in some other phases of the hydrologic cycle. Because water must move through this zone, which is not saturated with water, in order to enter the saturated zone where the ground water moves laterally through completely filled pore spaces, further research on the mechanics of water movement in the zone of aeration is essential.

Fluid movement in the zone of aeration involves movement in three phases; water, water vapor, and air. Water is retained in the zone of aeration as films of water surrounding particles of the rock or completely filling some of the void spaces between the grains. Water completely filling the voids can move downward until it reaches the water table as ground-water recharge. Downward movement of water in the zone of aeration is primarily in the water phase; the transfer of water vapor does not contribute significantly to ground-water recharge.

A particular ground-water reservoir, such as the Dakota Sandstone of the northern Great Plains, may underlie tens of thousands of square miles, while another ground-water reservoir, such as the sand beds underlying Long Island, may be confined to relatively small areas. The movement of ground water in small aquifers (water-bearing beds or strata) may be only part of a large pattern of ground-water movement throughout a larger area. The effects of water use and development must be studied in both large and small areas in order to understand fully the regimen of ground water.

Water moves through ground-water reservoirs until it is discharged as springs, by seepage into streams and lakes, and through withdrawal by man. Such discharge allows a continual movement of water through aquifers and provides room for recharge. The amount of water moving through the ground and the total amount of water removed from the ground-water reservoir in any specific period of time are known only approximately. The water that seeps into streams and lakes provides the base flow of the streams—that is, the low flow that is sustained through the driest part of the year. If water is diverted from a ground-water system and withdrawn for use, such as irrigation, or the water is evaporated back into the atmosphere, the base flow may be reduced substantially or even eliminated. The complex interrelationship of water on the surface and under the ground is one part of the hydrologic cycle which we need to study more intensively in order to make the best use of both sources of water.

Evaporation and transpiration are two phases of the hydrologic cycle that are difficult to study quantitatively. Only in the last few years have instruments and mathematical techniques been developed

to measure and calculate the rate and amount of evaporation from open water and land surfaces and the transpiration of plants. Evaporation may be estimated by measuring the loss of water from open pans on the land surface, but application of the evaporation rates to lakes and swamps can be misleading. Recent studies of energy budgets and heat transfer provide more reliable means of calculating total evapotranspiration than we have had in the past. In the future we may look to measurement of atmospheric moisture at elevations high above the ground and to the use of instruments carried in aircraft to give us gross figures on the total evaporation from a particular area.

The water on and below the surface of the ground is not pure; it contains varying amounts of different chemical substances in solution. The amount of material that is carried in solution by the water depends upon the solubility of the rocks with which the water comes in contact and the length of time of contact. Research into the physical and chemical properties of water and rocks and the interrelations of the water and the dissolved mineral matter are of extreme importance because of the uses to which we put water. Industries, municipalities, and irrigation all require water that is within certain but different limits of chemical quality. Ground water at a particular place generally has a fairly constant chemical quality, but water in streams in the same area may vary greatly in chemical quality during the year. The constancy of ground-water quality is an attractive feature for consumers whose water-quality requirements are not flexible.

WATER PROBLEMS OF THE UNITED STATES

It is easy to see that we cannot manage water as a whole throughout the Nation, because water problems are not the same everywhere. We have therefore oversimplified the major water problems in the following discussion. The general problem of water in the United States can be broken down into six problems of major importance which plague the Nation's water resources. Plate 1 shows the major areas affected by the problems listed.

The first problem, and one that comes most quickly to mind, is that of deficient supply—not enough water. Deficient supply is primarily a problem of the southwestern United States, although, as with other problems, it occurs in some areas elsewhere. In such areas, the total supply of water is not sufficient for the demands made upon it. Deficient supply may be in part an economic problem. Water may be available, but the cost of obtaining it can be prohibitive.

The Navajo country of Arizona, Utah, and New Mexico covers about 25,000 square miles and is a good example of an area of deficient supply. It is sparsely settled and probably never will have the problems of an increasing population similar to those of the nearby cities

of Phoenix and Tucson. Nevertheless, a stable water supply is needed for those who live and work in the Navajo country. Few streams are perennial—the Colorado and San Juan Rivers on the west and north sides of the Navajo country are the principal exceptions, but water from these generally is not available because the streams are deeply entrenched in canyons and the water contains large amounts of sediment. The meager supplies on the reservation come from small and undependable reservoirs on intermittent streams and deep but dependable wells. On an average, only about 10 gallons of water per day is available for human consumption (U.S. House of Representatives, 1953, p. 126). A larger and more dependable water supply can be assured only by a program of storage of runoff, promotion of the growth of plants that would use less water or be of more economic value than the present native species, and use of the ground-water reservoirs to the maximum capability, if such is economically feasible. Such a program would be expensive and would require more information on the Navajo country than is now available.

The second major water problem is that of variability. The available water supply may be less than the demand during drought years and greater than the demand during wet years. The average water supply may be able to meet the average demands, but this statement is small consolation to a user of water who must face several years of drought during which he cannot get enough water to meet his needs. This problem gives rise to the often asked question "Is our total water supply decreasing?" The answer to this is "No!" We may have less water at a certain place at a particular time but at other times we may have more water than we can use. Thus, droughts have been of serious proportions in the Central Plains in the 1930's and in a large part of the country in the 1950's, but at other times these regions have had surpluses of water.

Water supplies vary throughout a single year also. Irrigation in the West demands large and dependable water supplies during the growing season, but the natural stream runoff varies greatly during that time. Storage of surface water in reservoirs to regulate the flow for irrigation, together with the use of stored ground water, can even out the usable supply and allow its release when needed.

The distribution of the water supply is the third problem of major importance. The distribution problem means that the supply exceeds the demand in one part of a region and is less than the demand in another. For example, northern California has large supplies of water and the demand for water is small; southern California, in contrast, has a limited supply but its large, ever-expanding population and industry need ever-increasing amounts of water.

The Los Angeles River furnished the municipal water supply for the city of Los Angeles from the founding of the city in 1781 until

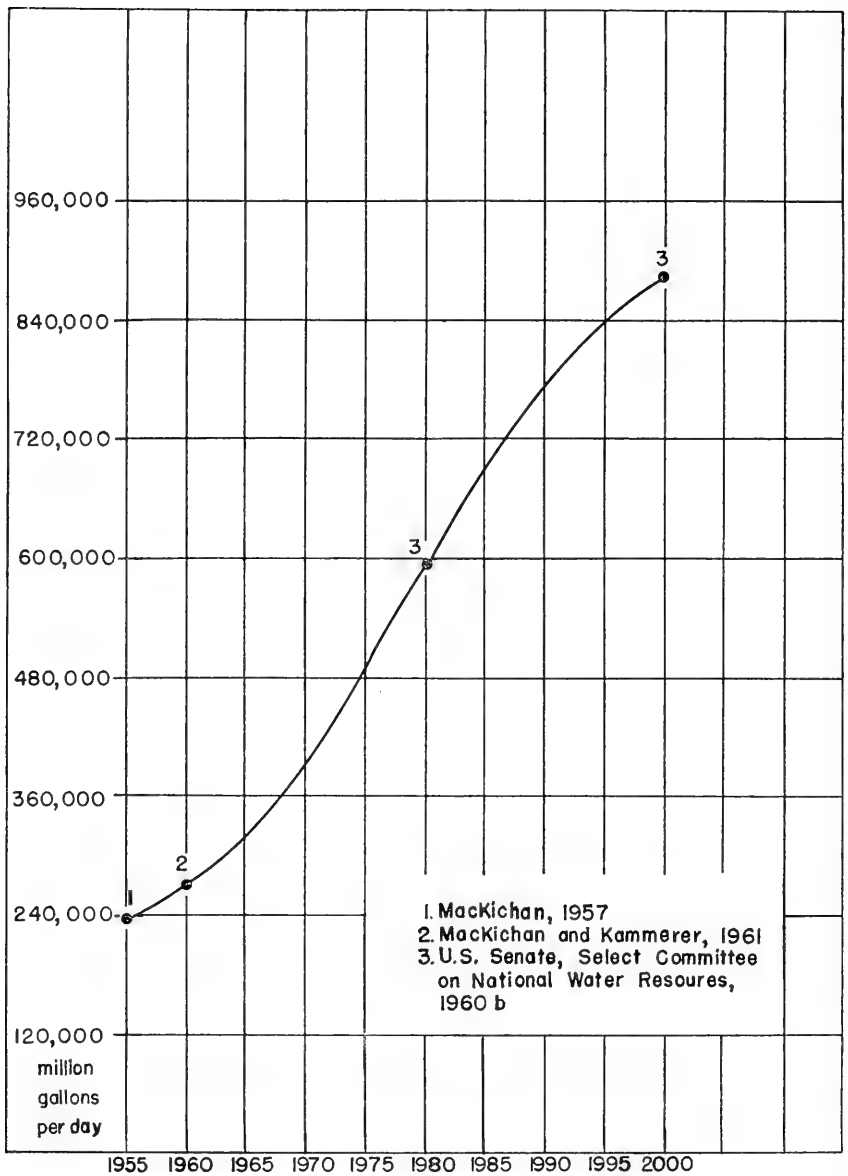
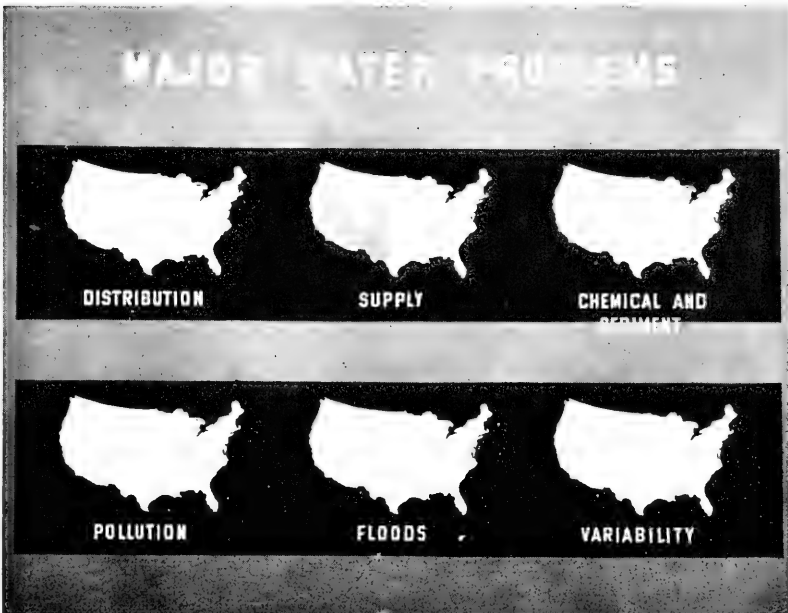

FIGURE 1.—Estimates of total withdrawals of water (excluding waterpower), 1955–2000.



1913. By 1900 the local water supply was obviously going to be inadequate for the anticipated population growth, and other possible sources of supply outside the local area were investigated. As a result, a 215-mile aqueduct was built to import water from Owens Valley on the east side of the Sierra Nevada. By 1930 the population of the coastal basins near Los Angeles had increased to over $2\frac{1}{2}$ million. To supply the growing population, the Colorado River was tapped and an aqueduct, 240 miles long, with a capacity of 1,500 cubic feet per second of water, was constructed by the newly formed Metropolitan Water District of Southern California and began delivery of water in 1941. The Metropolitan Water District now supplies water to Los Angeles and surrounding cities with a combined population of over 7 million and also supplies water to San Diego County.

At present the State of California plans to store and divert water from the upper Feather River drainage area in northern California for use in the Central Valley, San Francisco Bay area, and southern California. The magnitude of these efforts to provide water for municipal and other uses is testimony to the expense and effort needed to adjust the natural distribution of water to sustain the life and economy of southern California.

In many regions the quality of water is the fourth major water problem. Water quality is determined by the dissolved chemical constituents and by the sediment carried in the water. The chemical quality of water is extremely variable, and in some parts of the Nation the water has always been "poor"—that is, unusable for most purposes because it contains excessive amounts of dissolved minerals. Much of the water in the ground is of poor quality—possibly more water of poor quality than of good quality is stored in the ground. A person may say that his water is $99\frac{4}{100}$ percent pure, but such a statement is only figurative. The amount of dissolved minerals in natural water is measured in p.p.m. (parts per million), that is, parts of mineral constituents per million parts of water. A water that could be said to be " $99\frac{4}{100}$ percent pure" would contain 5,600 parts per million of dissolved mineral matter and would be unfit for drinking. Drinking water usually should have no more than 500 p.p.m. of dissolved minerals. Sea water usually is about $96\frac{1}{2}$ percent "pure."

Sea water may mix with surface and ground water and thus impair the quality of the fresh water. The sea water off the coast opposite New York City has a normal chloride content of about 18,500 p.p.m. The tidal estuaries of streams flowing into the Atlantic Ocean near New York City have somewhat lower salinities, from about 2,000 to 16,000 p.p.m. of chloride, because the fresh water of the streams is mixed with the sea water. The ground water in parts of Queens

County, Long Island, is fresh and contains less than 100 p.p.m. of chloride. In parts of Kings County and southern Manhattan, however, the chloride content of the ground water has become as high as 15,000 p.p.m. This indicates contamination of the fresh ground water by encroachment of sea water (Perlmutter and Arnow, 1953, p. 37). Pumping of fresh ground water may cause a reversal of the gradient of the fresh ground water, which usually moves from the high land areas to the ocean. The reversal of the gradient allows the sea water to enter the fresh ground-water reservoir.

A large body of salty ground water beneath southwestern Nassau County and southeastern Queens County, Long Island, probably is encroaching landward at a rate somewhat less than 100 feet per year (Perlmutter, Geraghty, and Upson, 1959, p. 417).

Salty ground water cannot be used for municipal water supply, but it can be used by industry, principally for cooling and air conditioning. The problem of continued encroachment of sea water can be and is being solved either by reducing the total amount of ground water pumped or by pumping the water out of the ground, using it for cooling, and pumping it back into the ground. This recirculation is a water-conservation measure that can reduce the total amount of water removed from the ground-water reservoir and thus slow down the rate of salt-water encroachment.

The sediment carried by streams and deposited in reservoirs also affects its quality. Although some waters have small concentrations of sediment, they may, because of the great total volume of water, carry a large total sediment load. A reservoir built on a river that has a large sediment load may eventually be filled with silt and other sediment and become unusable for further storage. Sediment is also a major problem to the operators of municipal and industrial waterworks, which must have facilities capable of removing sediment from water before the water can be used.

Some major reservoirs have lost sizable parts of their capacity owing to accumulation of sediment carried by streams flowing into the reservoirs. The sediment load of the Colorado River near the United States-Mexico boundary was 180 million tons per year before construction of dams on the main stem of the Colorado. After Hoover Dam and other dams were built, the sediment was impounded in the reservoirs instead of being transported to the delta at the mouth of the river. Lake Mead, the lake behind Hoover Dam, has filled with sediment at a rate slower than originally estimated, but reservoir capacity needed for storage of water has nevertheless been lost. In addition, the loss of the normal sediment load of the river below Hoover Dam has changed the regimen of the stream and allowed it to cut its channel deeper than if it carried its normal sediment load.

Natural water of poor quality must be distinguished from water polluted or contaminated by man and his agencies. The poor natural chemical quality of water is a problem that is not easily coped with, but a great deal can be done to avoid and correct pollution of water in streams and below the surface of the ground. Pollution, the fifth major problem, consists of permitting the entry into streams, lakes, and ground-water reservoirs of materials that are harmful and cannot readily be removed by normal water-treatment processes. These include organic and inorganic waste from municipalities and industries, which may, for example, temporarily lower the dissolved oxygen content of water in streams and lakes to a point where no fish or other aquatic life can live in the water.

Waste must be disposed of, of course, and disposal of waste into flowing streams has been a practical method for many years. However, the streams must have a large enough flow to dilute the waste, and when the wastes become a large enough percentage of the stream-flow so that the quality of water is objectionable, the stream is polluted. The solution to the pollution problem lies in determining the best way of handling the waste material. We cannot stop waste disposal—we must learn to control it and perhaps handle it without having to use large quantities of water for waste dilution.

The Potomac River, which is the source of water supply for the Nation's Capital and other communities, has been polluted by the municipal and industrial sewage discharged into the river and its tributaries. Aquatic vegetation and fish cannot thrive in its polluted water. Recreational activities such as swimming and boating bring people into contact with polluted water, constituting a health hazard. The prevention of future pollution and the control of the present pollution are goals that can benefit all users of the Potomac. Steps have already been taken to cut down or eliminate the discharge of raw sewage into the Potomac River; many cities now treat the sewage before disposal.

The estuary of the Potomac is narrow and deep and extends from Chesapeake Bay upstream to Washington. The river in this estuary receives pollution from other streams flowing directly into it and from sewage of cities adjacent to the estuary. The large size of the estuary combined with a back and forth movement of tidal surges prevent the pollutants from discharging into the sea fast enough, and the pollutants are therefore concentrated in the estuary, raising the temperature of the water and increasing the concentration of organic material. Within a few years no raw sewage will be discharged into the Potomac, but the problem of concentration of pollutants may still remain. Perhaps it will be necessary to dispose of sewage without discharging it into the river. Pumping sewage into ground-water reservoirs has been suggested as a pollution-abatement measure along the Potomac.

Even if this proved to be hydrologically feasible, which is not likely, care would have to be taken to ensure that the ground water did not become polluted.

The sixth major water problem, that of floods, probably gains the greatest public attention because floods are often of disaster proportions. Floods are a normal part of a river's life. The flow of a river generally ranges from the low flow, which is maintained principally by ground-water seepage into the stream, to a bank-full stage which occurs on the average of about twice a year. Higher flows, which may occur about every 10, 50, or 100 years, depending upon local conditions, can only be carried outside the channel of the river on the flood plain. Floods can be controlled by the construction and use of water-storage reservoirs, which tend to even out the annual fluctuation to a more or less steady flow. However, the construction of reservoirs solely for flood control is not always economically practical, and for that reason multipurpose reservoirs must be designed. These can be partly emptied and used for storage of flood water, which is later released for hydroelectric power generation, navigation, irrigation, water supply, and the dilution of waste reaching the river downstream from the reservoir.

The extent to which floods can endanger life and damage property is well illustrated by the floods of August 13-19, 1955, on the eastern and northeastern coasts of the United States. Hurricane Connie crossed the coast of North Carolina at about noon on August 12, moved north along the coast, across eastern Virginia, northeastward across central Maryland, Pennsylvania, and the southwestern tip of New York, and entered Ontario on August 14. Scattered floods occurred as a result of this hurricane, but its most dangerous effect was to saturate the soil to its capacity, which meant that further heavy rains would cause high runoff. Three days later hurricane Diane crossed the southern North Carolina coast, moved northward across southeastern Pennsylvania, crossed New Jersey, and swept out to sea south of Long Island on August 19. Heavy rains occurred in a broad band along the coast, an area that includes the most industrialized and densely populated part of the United States. The ground, still wet from the rains of August 12-14, could absorb only a small part of the rain; consequently, the rest ran off in the stream channels and flood plains, causing disastrous floods. In spite of flood-control reservoirs, property damage amounted to almost \$500 million, and some 200 persons were killed or injured. The floods reached new record maximum discharges at 129 of the 287 stream-gaging stations in the flood area (Bogart, 1960). Predictions of maximum expected floods are based on statistical analyses of the frequency and magnitude of previous floods, and the recorded data on such record-breaking floods as those of 1955 will make possible wiser planning of future flood control.

These, then, are the six major water problems of the country. Much is known about the natural regimen of water and about the effects of man's use of water, but nevertheless we need to know a lot more. The various water problems have been solved, in part and temporarily, in many ways. Technology can aid in the avoidance or correction of water problems; dams have been built to regulate river flow to alleviate floods, to provide water for consumptive use, and to furnish hydroelectric power; and municipalities and industries treat their sewage to prevent pollution. Water has been diverted hundreds of miles, even across the Continental Divide, to areas where natural water supplies are inadequate. But what will happen to water in the long run? How can we as a Nation use our water supplies wisely and with the greatest benefit?

CAN WE SOLVE OUR WATER PROBLEMS?

The solution or avoidance of water problems can be achieved only through sufficient knowledge of basic hydrologic processes, adequate basic facts on water occurrence throughout the Nation, and experience in dealing with water problems.

An understanding of the physical and chemical regimen of water is a prerequisite to the proper use of water and the correction or alleviation of water problems. The expression "balance of nature" is often used in the field of natural history and conservation to refer to the relations of living organisms with each other and with their environment. By analogy this expression is also applicable to the hydrologic environment when not affected by man. The amount of water in each of the phases of the hydrologic cycle is relatively constant over long periods of time of the order of thousands of years. For example, the amount of water discharging from a ground-water reservoir is equal to the amount of water entering the reservoir if no changes in the system are made by man.

Man's diversion and consumption of water upset the balance of the hydrologic cycle. Readjustment may take generations or even thousands of years. But the natural system must be thrown out of balance in order to provide water for man's use. Man must have water, but he must realize the consequences of water development in order to get the greatest benefit from his use of water.

There are three stages in the development of water resources of a particular area, whether it is a small drainage basin or the entire Nation. The first stage is use of the available water for needed purposes without planning or anticipating future expansion of water development and the consequent problems.

The second stage begins when problems such as deficient supply or pollution are seen to be serious. In this stage the problems are recognized and data on the hydrologic system are collected and analyzed to

determine the best ways of furthering development of the water supply as well as of minimizing the problems. Development in the second stage usually consists of stopgap measures to alleviate the major problems—stopgap primarily because of economic and sociological limitations.

The third stage, water management, consists of comprehensive planning and development of an area's water resources with the goal of providing the greatest benefit from the water and the minimization of water problems. The knowledge of how to manage water depends on the results of research in the fundamentals of the hydrologic cycle. For example, we must know the amount of water interchanged between the land surface and the ground-water reservoirs through the zone of aeration. Research is put into practice in the description and appraisal of hydrologic systems in specific areas, such as Long Island, where surface water, ground water, and the ocean all must be considered in evaluating the availability and usability of water. Principles of water management are based upon the existing physical and chemical regimen of water and are modified as needed by economic, legal, and sociological factors.

The development of water can then be adjusted to an optimum level at which maximum usability of water is assured with a minimum of bad effects on the resource and the users. Facts and sound principles of water management are not enough, however, to make these adjustments effective. Experience in the utilization and management of water is an additional vital factor in the conservation of water which allows us to profit from our mistakes.

Water management, the ultimate step in the development of water resources, has not yet been reached for any area. As we develop the water resources of the country and pass through the various stages of development, we must recognize that management of water will become a greater and greater tool in the full development of the Nation. A "laissez faire" attitude of water use must be a thing of the past, and we must recognize our responsibility to manage our resources wisely.

If we could visualize an imaginary electronic computer programed with sound principles of water management, into which we could feed all the facts on the water resources of an area, data on the present and expected use of water, and the sociological and economic facts allied with the development of water, perhaps we could push a button and get the solutions to the water problems. Unfortunately, we do not have such a computer and maybe we never will have. But it is certain that the continuation of scientific and engineering studies of the basic principles of the hydrologic cycle together with complete appraisals of the available and usable water resources of the Nation

can lead ever closer to the ultimate goal of water management and conservation for any area in the Nation.

LITERATURE CITED

- ACKERMAN, E. A., and LÖF, G. O. G.
1959. Technology in American water development, 710 pp. Baltimore, Johns Hopkins Press.
- BOGART, D. B.
1960. Floods of August–October, 1955, New England to North Carolina, 854 pp. U.S. Geol. Surv. Water-Supply Pap. 1420.
- LANGBEIN, W. B., and HOYT, W. G.
1959. Water facts for the Nation's future, 288 pp. New York, Ronald Press Co.
- MACKICHAN, K. A.
1957. Estimated use of water in the United States, 1955, 18 pp. U.S. Geol. Surv. Circ. 398.
- MACKICHAN, K. A., and KAMMERER, J. C.
1961. Estimated use of water in the United States, 1960. 44 pp. U.S. Geol. Surv. Circ. 456.
- MEINZER, O. E.
1938. Our water supply. Ann. Rep. Smithsonian Inst. for 1937, pp. 291–305.
- PERLMUTTER, N. M., and ARNOW, T.
1953. Ground water in Bronx, New York, and Richmond Counties, with summary data on Kings and Queens Counties, New York City, New York, 86 pp. New York Dept. Conserv., Water Power, and Control and Comm. Bull. GW–32.
- PERLMUTTER, N. M., GERAGHTY, J. J., and UPSON, J. E.
1959. The relation between fresh and salty ground water in southern Nassau and southeastern Queens Counties, Long Island, N.Y. Econ. Geol., vol. 54, pp. 416–435.
- U.S. HOUSE OF REPRESENTATIVES, INTERIOR AND INSULAR AFFAIRS COMMITTEE.
1953. The physical and economic foundation of natural resources, pt. 4. Subsurface facilities of water management and patterns of supply type area studies, 206 pp.
- U.S. SENATE SELECT COMMITTEE ON NATIONAL WATER RESOURCES.
1960a. Water resources activities in the United States—water facts and problems, 44 pp. 86th Congr., 1st Sess., Comm. Print 1.
1960b. Water resources activities in the United States—water supply and demand, 131 pp. 86th Congr., 1st Sess., Comm. Print 32.

The Opening of the Arctic Ocean ¹

By Lt. Comdr. JAMES T. STRONG,² U.S. Navy

[With 4 plates]

FAR-REACHING voyages under the Arctic ice by nuclear submarines are now common enough to attract little interest. For the many who regard them as stunts, there now seems little reason to continue them. That they may well herald a new phase of naval operations, as important as any our Navy has ever seen, is perceived by only a few.

Until 1958 the Arctic Ocean was untraveled by ship. Polar bears, seals, and fishes shared this vast area with rare human intruders who traveled there by air or on foot or by sled at great effort. A few powerful armored icebreakers probed the edges of the perpetual icepack. These ships and others entered the fringes of this region at great risk; frequently they were trapped and remained until rescued at great cost.

Then *Nautilus*' crossing of the entire Arctic Basin under the icepack proved the feasibility of travel there by submarine. Within two years, succeeding voyages have removed all the major questions in under-ice navigation and the nuclear submarine has opened 5 million square miles of ocean to travel by ship. Before considering the implications of this breakthrough, a brief review of the conditions under which it occurred will be profitable.

The trip of U.S.S. *Nautilus* from the Pacific across the Pole to the Atlantic is well known. Earlier in 1957, *Nautilus* had prepared for this voyage by a brief but productive probe under the ice to within 180 miles of the Pole. Shortly after *Nautilus* crossed the Pole, the nuclear-powered submarine *Skate* arrived there on an intensive voyage of discovery. Among other significant achievements, *Skate* demonstrated the ability of submarines to surface in the open-water leads,

¹ Reprinted by permission from Proceedings of the United States Naval Institute, vol. 87, No. 10, October 1961. Copyright 1961 by U.S. Naval Institute.

² A graduate of the U.S. Naval Academy in the Class of 1948A, Lieutenant Commander Strong served in U.S.S. *Cochino* (SS-345) which burned and sank in Arctic waters in 1949. Subsequently, he has served in U.S.S. *Sarda* (SS-488), U.S.S. *Trout* (SS-566), U.S.S. *Stickleback* (SS-415), and U.S.S. *Bashaw* (SSK-241). He is presently (1961) a member of the crew which commissioned U.S.S. *Seadragon* (SS(N)-584) and sailed her from Portsmouth, N.H., to Pearl Harbor by way of the Northwest Passage and the North Pole.

and she also proved the existence of these leads throughout the Arctic pack during summer months. In March 1959, less than 7 months later, *Skate* proceeded to the Pole a second time. During this severest of all seasons in the Arctic, *Skate* developed a procedure for surfacing blind through the ice which completely covers the Arctic Ocean during the winter darkness.

In February 1960 *Sargo* became the third of the "ice boats" to undertake what many consider was the most hazardous task of all. Building on knowledge gained from *Nautilus* and *Skate*, and utilizing prototype equipment to guide her around shoals and deep ice, *Sargo* operated for many days in shallow waters under the unfavorable circumstances of complete ice coverage and round-the-clock darkness.

Several questions remained after *Sargo* successes. Could nuclear submarines operate under ice in proximity to icebergs without fear of colliding with this deep draft ice? Could nuclear submarines operate under the ice in the restricted waters between land masses? If a nuclear submarine could operate in narrow, shallow passages under the ice and in the vicinity of icebergs, it seemed likely that there were usable passages in the islands of northern Canada that should be sought out and used. Several ice-blocked straits crossed this area, but whether they were passable by submarine was not known.

Much had been learned about icebergs since the establishment of the International Ice Patrol in 1913 after the tragic sinking of *Titanic*. Icebergs are the droppings of glaciers which exist on many of the Arctic islands. The weight of centuries of snowfall shoves the glacier down the island slopes toward the sea where huge pieces break off, becoming icebergs. Time and pressure and temperature have converted snow to very hard ice by the time it reaches the sea. Once afloat, it may wander in Arctic waters under the effects of current and—to a lesser extent, wind—for years while a slow erosion occurs. Whenever currents take it into warmer waters, disintegration occurs within a few days.

Most of the world's icebergs occur in Baffin Bay. Greenland is by far the most important source; here 12 large glaciers alone have been recorded as calving 2,300 bergs in 1 year. Icebergs do not normally occur in the Arctic Ocean so that previous nuclear submarine expeditions have not confronted them.

A new nuclear submarine, U.S.S. *Seadragon* (SSN-584) was having her post-shakedown shipyard availability at Portsmouth, N.H., at this time. *Seadragon* was scheduled for transfer to the Pacific Fleet at an opportune moment, and so it was decided to fit her with ice equipment and send her to Pearl Harbor by way of a Northwest Passage, if one could be found. On August 1, 1960, *Seadragon* sailed northward.

On August 9, *Seadragon* entered Baffin Bay, traveling at deep depths and at a speed of 14 knots. Attempts to locate icebergs reported to be disintegrating in the warm waters to the south had been unsuccessful. As the ship approached an area where several bergs were reported, speed was slackened. On August 10 *Seadragon* surfaced on the edge of a large area of loose sea ice which stretched as far as the eye could see to the north. This was what remained of the solid pack which had covered all of Baffin Bay the previous winter. Less than 2 miles away was a small piece of a berg—known as a bergy bit. Small compared to a full-sized berg, this bit was later computed to weigh 2,500 tons. At the limit of visibility to the north was a shape that must be an iceberg.

The bergy bit was a perfect target to use for final adjustments of the ship's iceberg detection equipment. Carefully the ship was coned under the bit for the first time—then again and again until the iceberg detector and the men who must use it were ready for bigger game. Going deep, the ship then headed in the direction of the full-sized berg.

Seadragon was surfaced in the open water before the berg, having traveled under 12 miles of loose pack. Slowly she approached the berg like the legendary David must have stalked his giant. Knowing that the underwater size was much greater than apparent, the Captain stopped the ship while still a mile away. The dangers of hitting a berg are well known to seamen. Ships that collide with icebergs are invariably severely damaged or lost. The above-water portion measured 74 feet tall with a 313-foot waterline. The submarine slowly circled the berg, surveying and photographing every angle. The berg was blocky on one side like the breastworks of a fort, while the reverse was hollowed out like the back side of a shield. The berg was clearly weathered, showing the multiple waterlines characteristic of the state of accelerated disintegration. It would not be safe to approach close or send a party to this berg. A huge ice slide or rotation of the berg due to a change in center of gravity might occur as happened later on two other bergs.

After all possible study had been completed on the surface, *Seadragon* submerged. As expected, the iceberg detector traced out a huge underwater body in the direction of the berg. Except for size, it looked to the sonar no differently than the bergy bit earlier. But could the detector identify the berg as deep draft ice compared to shallow draft sea ice? The iceberg detector indicated that the berg was between 100 and 200 feet in draft. One theory held that the draft would be somewhere between one and five times the above-water height. Studying the above-water height and shape of the berg, the ice experts estimated the draft to be between 150 and 200 feet. There was no other way to check the iceberg detector measurement—or the theory—than to pass under the berg and let upward-beamed fathometers measure

the distance precisely. At *Seadragon's* depth, the berg should clear by more than 200 feet. Beyond these prosaic reasons for passing under the berg was the urge to be the first submarine to do so. This magnificent crew had brought their ship 2,500 miles to find this berg. All were eager to conquer it in every way. A few runs were made at the berg to test equipment operation at every angle and speed, then *Seadragon* headed directly for the berg.

After many hours of preliminary steps, the long-awaited trip under the berg seem anticlimatic. The upward-beamed fathometer traced out an irregular bottom with a draft of 108 feet. A total of six runs were made under this berg in different directions to produce a complete picture of its shape. The maximum length of the underwater shape proved to be 822 feet compared to the 313-foot measurement above water. While proving her ice equipment, *Seadragon* corrected and proved many of the theories concerning the undersides of icebergs.

Soon the ship was operated routinely at speeds up to 20 knots with sure knowledge that every berg would be easily seen and avoided.

During the week that followed, 12 icebergs in all were selected and measured off. Six were passed under a total of 22 times. Six were too deep to be passed under safely. At one time in an area south of Kap York, Greenland, the bergs were so dense that 45 were in sight at the same time and the radar scope showed them to be undiminished in number beyond the range of visibility. Icebergs were clearly no hazard to a properly equipped nuclear submarine. In proving this fact, invaluable scientific information about the undersides of icebergs was produced to an extent never before possible.

Her first task completed, *Seadragon* turned west. In approximately the same position, 121 years earlier, a young English naval officer named William Edward Parry had directed his ships *Hecla* and *Gripper* in the same direction. He had entered a body of water called Lancaster Sound which was shown on his chart as a bay without an exit to the west. He was soon aware that it was not really a bay, but a strait, possibly the Northwest Passage, that he and many before him had sought.

It was a Northwest Passage and Parry lived to be knighted and have Parry Channel named after him. It took 121 years and nuclear power to see it navigated fully, however. In the winter this channel is completely ice covered. In the summer the eastern end, Lancaster Sound, is usually ice free. The western end, McClure Strait, and narrow center, Barrow Strait, are usually covered with rugged pack ice relentlessly forced there from the Arctic Ocean under pressure generated by the usual Arctic wind circulation. Parry was fortunate to have found the channel in a good year, the mildest ever recorded.

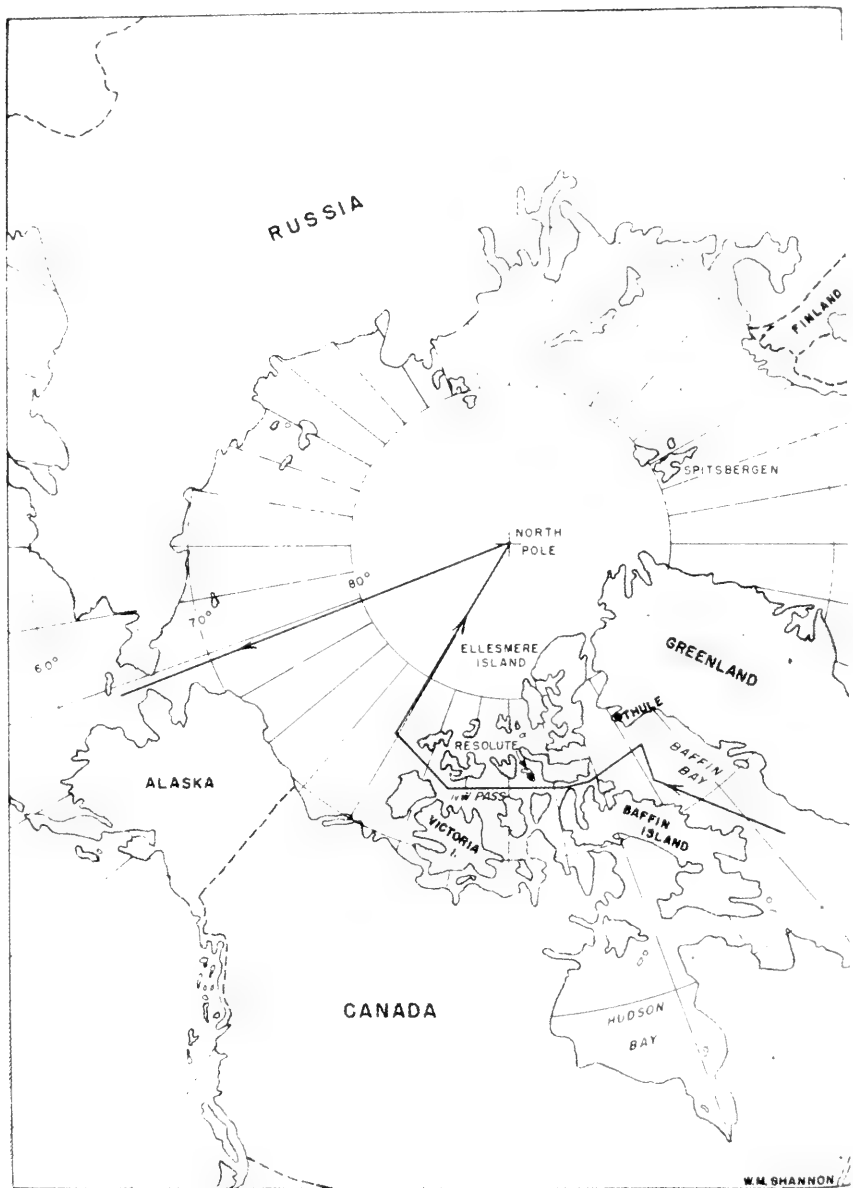

General route of USS *Seadragon's* August 1960 Arctic cruise.



Underside of ice as photographed by diver.



Frogman from *Seadragon* takes first pictures under the North Pole.

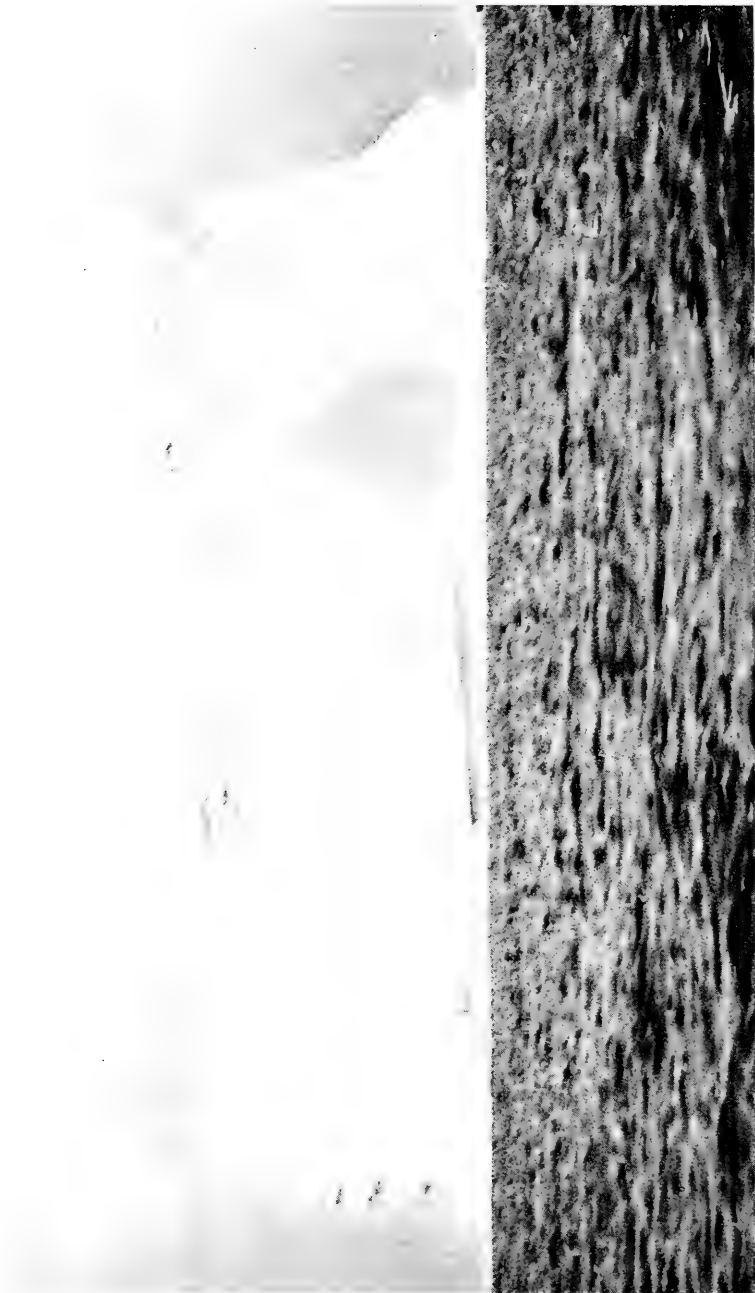

The largest iceberg encountered by *Seadragon* on her Polar voyage.

He managed to travel all the way to Melville Island before being stopped by the pack. Here he wintered and returned home to a hero's rewards the next summer.

Because the usually unfavorable ice conditions keep ships away, Parry's soundings were all that existed in the main section of the channel. Ships since that historic voyage had traversed sections of the channel inshore in relatively shallow waters where the winds and presence of land frequently left channels through the ice. The many soundings along the coasts clearly revealed that a submerged submarine could not pass there. The half dozen or more soundings sparsely spread along the center of the Barrow Strait narrows indicated that the depth here was shallow as compared to the ends of Parry Channel. Five islands exist in the narrows, while another island and several shoals were marked as "existence doubtful" or "position doubtful." The best passage between the islands, or whether a passage even existed, was by no means clear from the chart. Whether the passage would be deep enough to pass a submerged submarine under the heavily ridged ice that normally was there was clearly uncertain.

On the morning of August 17, *Seadragon* submerged at the western end of Lancaster Sound and proceeded into the rapidly shoaling waters of Barrow Strait at slow speed. During the 3 days that followed she was never far from the bottom below or the surface above. The bottom proved to have many shoals that appeared on the fathometer trace with little warning. Grounding or collision with ice above was narrowly escaped many times by turning or changing depth rapidly. Although there was some ice on the surface, a lucky wind condition had cleared most of the ice from the Strait, permitting a more thorough survey than expected. *Seadragon* surfaced six times within the strait for navigational fixing to locate her survey accurately on the area's charts. The fixes revealed that several of the charted islands were 5 miles out of position. On August 19, the task was complete. Islands and shoals were carefully and accurately plotted on the chart. There was a channel there deep enough for any future nuclear submarine to follow, winter or summer, favorable ice or not. The survey had proved without reservation that the electronic equipment on *Seadragon* was capable of leading her through restricted channels between land masses.

At high speed, *Seadragon* entered the deep, unsounded waters of Viscount Melville Sound, passed the North Magnetic Pole, passed under the edge of the ice pack pushing into McClure Strait, and entered the Arctic Basin—all without surfacing once. Proceeding under the pack to the North Pole, the ship was surfaced frequently for scientific studies, tests of military equipments, and sightseeing by

the crew. Departing the Pole on August 27 *Seadragon* continued this routine until emerging from under the ice north of Bering Strait. A brief stop was made at Nome, Alaska, and on September 14 *Seadragon* arrived at Pearl Harbor.

The final questions answered, all of the Arctic is now open to navigation by any nation having nuclear submarines. This is possible through the miracle of nuclear power. A hundred and nineteen years ago, Sir William Edward Parry could not have predicted *Seadragon's* voyage as he struggled through an icebound channel for the first time in a sail-driven wooden ship, misguided by a vexed magnetic compass. Neither can we predict today the nature of the change that will have occurred in the Arctic a hundred years hence. But change it most certainly will.

The Queen Elizabeth Islands of the Canadian Archipelago are rich in minerals. As those new materials become more valuable and as science makes them easier to obtain, commerce will surely move into the Arctic and flourish. *Seadragon's* route through the Parry Channel and many others yet uncharted will some day be important commercial routes just as they are today routes of military significance. Passenger routes across the Arctic of great importance are already in daily use in the air.

The idea of increasing importance of the Arctic is not a new one. Many years ago that venerable Arctic explorer and writer Vilhjalmur Stefansson gathered together the impressive evidence for this thesis in a book called "Northward the Course of Empire." This book traces the center of civilization from its inception in a tropical climate, observes its slow movement north to temperate regions, and predicts an eventual center far to the north of where it exists now.

Across the Arctic Ocean from Canada there is already considerable activity. North of the 60th parallel, 6 million people live under Soviet direction, while north of the same parallel in Canada and Alaska live only a few hundred thousand. Just south of the Arctic Circle, Archangel has a population of 300,000, while the northernmost city of comparable size in North America is Vancouver, which is 15° farther south. Geography has aimed the great waterways of the Russian heartland to the north. While the Ob, Yenisei, and Lena Rivers may never approach the same position of importance that the Mississippi River holds in the commerce of North America, they nevertheless are important commercial routes to north-central Asia. The northern sea route across the top of Eurasia is of growing importance as the main path for freight between the river systems and the population of the Soviet North. It is of increasing strategic significance as the only secure waterway between Soviet Pacific forces and the rest of the Soviet Union. The Russian interest in this route has

produced the largest icebreaker fleet in the world. The more modern vessels of this fleet include four 11,000-ton *Stalin*-class ships and three Finnish built 5,500-ton *Kapitan*-class ships. The much heralded nuclear-powered, 16,000-ton *Lenin* will join the fleet soon.

For many years the Soviets have been systematically studying the science of the Arctic on a scale far beyond that of the Western World. Since 1937 this work has been carried out in the far north by groups of scientists established on ice floes. Since the floes drift very slowly, the scientists can thoroughly and deliberately carry out their studies over a long period of time. The pattern for this exploration was set by the first party in 1937 led by Ivan Papanin who is now one of the most celebrated of polar explorers. Papanin and his three comrades were landed by aircraft on a floe at the North Pole. Nine months later, the floe had drifted clear of the ice and the party was removed by an icebreaker east of Greenland. Since that time, a series of eight expeditions have used aircraft to land men and equipment on the ice. The slow drift of the ice has carried them around this previously inaccessible region while they pursued their studies and research. Several of these expeditions manned their floes winter and summer for more than a year. During 1959, two of these stations, NP6 and NP8, were drifting in the Arctic.

While the drifting stations conducted long-time studies, the techniques and equipment developed to land the parties were used to extend the area of observations by short-time observations. During the 10 years after 1947, Soviet aircraft landed at more than 100 points all over the Arctic Ocean for brief hydrographic, oceanographic, meteorologic, and cyrologic observations.

The nuclear submarine has proved to be a very efficient means for the gathering of certain scientific information in the Arctic on six cruises since 1957. This information has to a certain extent closed the gap that has existed between the Soviet exploration in the Arctic and the modest amount accomplished by all other countries. In 1960 it would appear that even though the Soviets have a far greater experience and interest in the commercial, scientific, and military opportunities of the Arctic, the United States has a fortunate, if temporary, advantage in the area because of her unique possession of nuclear submarines.

The Arctic air has been a scene of large-scale military air operations ever since the U.S. and Soviet Air Forces began looking at each other across the Pole after World War II. The Arctic is ready for the first time for a corresponding interest by the two navies of these countries. The voyages of *Nautilus*, *Skate*, *Sargo*, and *Seadragon* have marked this area as the exclusive domain of the nuclear submarine. The Soviet submarine force—the largest submarine force in the world by a factor of more than three times—will most certainly soon have nuclear

submarines. With their demonstrated interest in the Arctic commercially, scientifically, and strategically, the Soviets can be expected to direct their nuclear submarines north and under the ice.

The advantage to be gained by naval forces operating under the northern ice is fairly obvious. First, such a submarine force is secure from their traditional surface and air enemies. Second, ship targets in this area are especially valuable since there are few if any overland roads or rails to support the area, and air transport is practicable only to a limited extent. The sinking of a very few ships could cause whole areas to wither from lack of supplies. Third, the Arctic Ocean occupies a strategic position second to none. The search for missile-launching points clearly marks the Arctic Ocean as ideal for targets both in North America and Eurasia. The development of the Polaris submarine and its Soviet equivalent is bound to increase the desirability of operating submarines in the Arctic.

Beyond the three direct considerations is a subtle fourth consideration of great importance. Neither the Soviet Union nor the United States could possibly accept the establishment of an unfriendly Arctic nuclear submarine force without establishing a similar force. A nuclear submarine will be the only weapon able to counter a nuclear submarine under the Arctic ice in the foreseeable future.

The nuclear submarine is not per se an Arctic ship of war. It must be specially equipped, trained, and provided with information and procedures for offensive Arctic operations. The voyages of *Nautilus*, *Skate*, *Sargo*, and *Seadragon* have been nonmilitary in nature. Much remains to be done before nuclear submarines are ready for offensive naval operations in the Arctic. The equipment and environmental information already obtained by these submarines is a broad base to build on. The conclusion that their efforts have placed the United States several years in the lead because of voyages over a period of 3 years is not valid, however. The voyages so far accomplished have been widely spaced. Any determined opponent having several nuclear submarines and the published knowledge of these voyages could duplicate and exceed them quickly. It is possible to produce an Arctic naval force equal to that of the United States in a relatively short period of time.

History may well mark this period as a time of utmost significance in the Arctic. If accelerated naval penetration of this area does not result, it will be only because the challenge and opportunities that exist were ignored.

The Place of Genetics in Modern Biology¹

By GEORGE W. BEADLE

President, The University of Chicago

[With 1 plate]

Many years ago Dr. William Morton Wheeler, a distinguished and admired professor of biology and Dean of the Bussey Institution of Harvard University, wrote a small essay² in which he said, "Natural history constitutes the perennial rootstock or stolon of biologic science. . . . From time to time the stolon has produced special disciplines which have grown into great flourishing complexes. . . . More recently another dear little bud, genetics, has come off, so promising, so self-conscious, but alas, so constricted at the base." I am sure Professor Wheeler was convinced that this bud would be abortive.

More recently there appeared in *Science*³ a related essay by a distinguished and likewise much admired biologist, Sewall Wright, who was a graduate student at the Bussey Institution during Wheeler's time. After quoting the above words, Wright points out that, far from aborting, the little bud genetics has flourished mightily and has in many respects replaced natural history in the sense that it has become the rootstock of all biological science and has bound "the whole field of biology into a unified discipline that may yet rival the physical sciences."

Why such a change in 36 years? For despite the fact that Wheeler was not above giving his friends and colleagues in genetics a bit of ragging, he was basically serious. There has been a great change. We have come to recognize that genetics does in fact deal with the very essence of life. This is why at the present time in the biology laboratories of M.I.T. there are physical chemists, biophysicists, biochemists, microbiologists, virologists, zoologists, and other varieties of biologists devoting much effort to the study of genetic material.

I should like to begin a development of this thesis that genetics is the keystone of modern biology by reminding you that every one of us—you and I—starts development as a tiny sphere of protoplasm,

¹ Eleventh Annual Arthur Dehon Little Memorial Lecture. Reprinted, with additions and modifications, by permission of the Massachusetts Institute of Technology.

² *Science*, vol. 57, p. 61, 1923.

³ *Science*, vol. 130, p. 959, 1959.

the almost microscopic fertilized egg; and that somehow in this small sphere there must be contained the specifications, the directions, or the architectural blueprints for making one of us out of that bit of jelly-like material. Of course, the process by which this happens is enormously complex, and we do not yet understand very many of the details. But we do know that a substantial part of these directions is wrapped up in the centrally located nucleus of the cell. These directions are the material heredity that we received from our parents.

In addition to this set of directions in the nucleus, there must be more. There must be an architectural organization of the rest of the cell—the cytoplasm—and this is indispensable. And for the carrying out of the directions there must be a proper supply of raw materials in the form of food—perhaps 10 or 20 tons—for the egg to grow and differentiate into a mature person. Time, too, is essential—16, 20, 25 years, or more. Finally, there must be a proper environment, initially a very precise one. Later, as we develop the ability to regulate our own environments, we become less fussy. The environment adds to the information in the original egg. This is particularly impressive in our own species, for in addition to all the other environmental information fed into us during development we are continually bombarded with a cultural inheritance—language, art, music, religion, history, science, and so on—that in man supplements biological inheritance to a far greater degree than in any other species.

All these factors are essential to our development, and many of them continue throughout life. In these halls I do not need to emphasize the significance of cultural inheritance, for it is a primary function of M.I.T. to add to that cultural inheritance and to teach us how more effectively to pass it on in a manner that will be cumulative from generation to generation.

What I wish to talk about are the directions in the nucleus. What are they and how do they specify that from this minute cell one of us will come? I shall ask five questions about these specifications:

First, how do we get them and how do we transmit them? I shall dispose of this one briefly, for it is answered by classical genetics—the Mendelian genetics now found in every elementary textbook of modern biology. You know about classical genetics: about blue eyes, brown eyes; curly hair, straight hair; good hemoglobin, bad hemoglobin; and so on.

Perhaps you know less about the remaining four questions:

How are the specifications written—that is, what is the language of genetics?

How are the specifications replicated? From the time we start development as a fertilized egg until we transmit them to the next generation there are perhaps 16 to 25 successive replications of these specifications, depending on whether the carrier is female or male.

Each time the material is replicated it doubles, so 20 replications represents more than a million copies. How does replication occur with the precision necessary to avoid intolerable numbers of mistakes?

How are the specifications—the directions or the recipe for making us—translated? This is an enormously difficult question, and I shall say right now that we know very little about it.

How are specifications modified during the course of evolution? Most of us believe in organic evolution, and we want to know how we have come to be different from our ancestors. In other words, what is the nature of the mutation process?

A few years ago, seven or eight years ago, we would have had a very difficult time answering the four questions that I have just asked. We did not know enough, and we did not have many good clues even as to how we might go about searching for answers to these questions. But within the past half-dozen years or so excellent clues have turned up. In 1953, shortly before the M.I.T. Dorrance Laboratories of biology and food technology were opened and dedicated, there occurred an important turning point in modern biology. What was it and what does it have to do with answering the questions I have posed?

By this time it had become quite clear to a number of biologists that a particular chemical substance called deoxyribonucleic acid was important in transmitting hereditary information in bacteria and in viruses. Since the cells of all higher plants and animals contain deoxyribonucleic acid, it seemed probable that this substance served to carry genetic specifications in all living systems.

I shall attempt to explain how and why this substance, DNA for short, is important. And I shall try to do it without considering the details of its rather complex chemistry. DNA has been known for a long time. And it was known to consist of long chainlike molecules made of four kinds of units called nucleotides. But it was not known exactly how DNA molecules were internally organized until 1953, when two investigators—Dr. James D. Watson, now at Harvard University, and Dr. Francis H. C. Crick of Cambridge University—succeeded in formulating a structure that has proved to be substantially correct.

From the information then available from classical organic chemistry, from X-ray diffraction studies, from analyses of the relative proportions of the four kinds of nucleotides, and through ingenious model building, Watson and Crick proposed the structure illustrated in figure 1.

This Watson-Crick structure was at once exciting to the biologists. Why? Because it suggested such plausible answers to the four questions: How is genetic information written? How is it replicated? How is it translated? And how does it mutate?

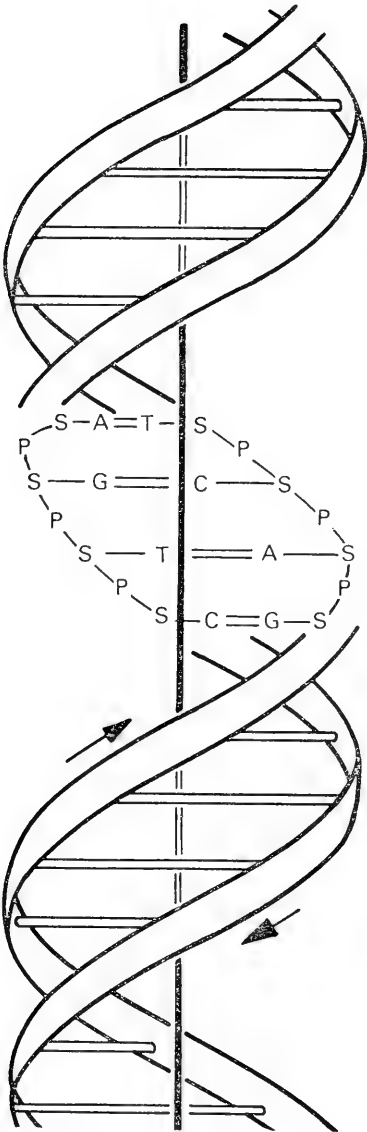

FIGURE 1.—The Watson-Crick structure of DNA schematically represented. The parallel spiral ribbons represent the paired polynucleotide chains. Hydrogen bonding is represented by transverse parallel lines. P=phosphate group, S=sugar unit, A=adenine base, T=thymine base, G=guanine base, C=cytosine base. Arrows indicate that polynucleotide chains run in opposite directions as specified by the sugar-phosphate linkages. Redrawn from Watson and Crick (1953).

How does the model help answer these questions? The key to the structure of DNA is that its molecules are double in a special way. There are two parallel polynucleotide chains wound around a common axis and bound together through specific hydrogen bonding.

You can more easily visualize the essential features of DNA if you will imagine a four-unit segment of it pulled out in two dimensions as follows:



Here the four letters represent the four nucleotides; and the colons, hydrogen bonds. In fact, you can very nicely represent such a segment with your two hands. Place your forearms vertically before you and parallel. Fold your thumbs against your palms and place homologous finger tips together as though they were teeth on two combs vertically oriented in a single plane, tooth tip to tooth tip. In this arrangement the two index fingers represent the A : T nucleotide pair and so on.

Imagine many fingers along your forearms—of four kinds corresponding to the nucleotides A, T, C, and G. The four kinds of fingers or nucleotides can be arranged in any order on one arm but must always have the complementary order on the other. T opposite A, A opposite T, G opposite C, C opposite G. Thus if one knows the sequence of nucleotides in one chain, the sequence in the other can be determined by the simple rule of complementarity.

This structure suggests that genetic information is contained in the sequence of nucleotides; in other words, DNA is a kind of molecular code written in four symbols. One can think of the code as a sequence of nucleotide pairs or of nucleotides in a single chain, for it is obvious that the double chain and the two single component chains all contain equivalent information. In essence the two complementary chains are analogous to forms of a single message, one written in conventional Morse code, the other in a complementary code in which each dot is changed to a dash and vice versa.

Let us now ask the question: how much information is packed away in the nucleus of a human egg? It is estimated that there are about five billion nucleotide pairs per single cell. How much information does this correspond to in terms of, say, information spelled out in the

English language? Francis Crick has expressed it this way: If you were to make an efficient code for encoding messages in English in the four symbols of DNA, and with this started encoding standard library volumes of 500 pages, 500 words per page in this DNA code, you could get the contents of 1,000 such volumes in the DNA in the nucleus of a single fertilized egg cell. This is another way of saying that it requires the equivalent of about 1,000 large volumes of directions in the egg nucleus to specify that a human being like one of us will develop properly from it, given a cytoplasm, proper food, and a suitable environment.

Said in another way, that is the size of a genetic recipe for building a person.

This is supposedly the way the genetic information is carried from generation to generation—in a language we might call DNA-ese. Each gene is a segment of DNA of perhaps three or four thousand nucleotides.

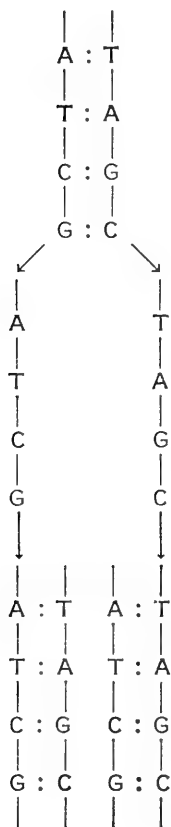

Now let us ask about the replication. The double structure of DNA suggested immediately to Watson and Crick how this could happen. If, during cell division, the two chains were to come apart, obviously each could serve as a template for picking up additional units to make new half chains. And this is happening in each of us right now. In many cells nucleotides are continually being made from food components. The replication of DNA according to this scheme can be illustrated as shown at the left.

You can represent the process with your hands. Indicate the double molecule as already directed as paired hands. Take the two hands apart. Imagine free fingers (nucleotides) moving around at random. Each single hand serves to select in proper order the one-fingered units necessary to make a complementary hand. The right hand is a template for making a left hand and vice versa. So with a double molecule, represented by a pair of hands, two single molecules arise by breakage of hydrogen bonds, with each then directing the synthesis of a new complementary single partner.

This process of replication takes place with every cell division and, as we shall see, with a high degree of precision.

This hypothesis by which two identical bipartite molecules arise from a single such double molecule is very satisfying in its simplicity and elegance. If true, it is presumably the basis of all biological re-

production at a molecular level. Can the hypothesis be tested? The answer is yes. In fact, several kinds of experiments can be and have been made to see if the hypothesis agrees with observed facts.

In one kind of experiment DNA units are labeled with radioactive phosphorus. Each nucleotide has one phosphorus atom, and a certain number of its phosphorus atoms can be made radioactive by growing an organism, say a bacterium, in a medium containing radioactive phosphorus for several generations until it becomes equilibrated. Then both chains of its DNA molecules will be labeled. If the bacteria are then allowed to multiply in a medium in which there is no radioactivity, the two chains of each DNA molecule, both labeled, should come apart, each then directing the synthesis of an unlabeled partner. The new double molecules should then be labeled in one chain but not in the other. In the next generation the labeled chain should separate from the nonlabeled one. With synthesis of non-labeled partners by these, there should be produced labeled and non-labeled double molecules in equal numbers. The observed results are consistent with this expectation.

Another way of doing essentially the same experiment is to replace the normal nitrogen atoms of DNA with "heavy" nitrogen, the stable isotope N^{15} instead of the usual N^{14} counterpart. DNA molecules so labeled become heavier but not larger. Hence they are denser. DNA containing only N^{15} can be cleanly separated from that containing N^{14} in an analytical centrifuge cell in which an appropriate density gradient is established. In such experiments it is found that bacteria containing DNA fully labeled with N^{15} , if allowed to multiply once (double in number) in a medium containing only N^{14} , give rise to descendants in which all the DNA molecules are "hybrid" as though one nucleotide chain of the double molecules contained N^{15} and the other N^{14} . This, of course, is what is predicted by the hypothesis. In a subsequent generation, also in N^{14} medium, half the DNA molecules are hybrid and half are fully light. Again this is what would be expected if the hypothesis is correct.

While experiments of this kind do not prove that the Watson-Crick hypothesis of DNA replication is correct, they do strongly suggest it.

An even more dramatic way of testing the hypothesis is the one used by Professor Arthur Kornberg and his associates, now at Stanford University. They have devised a test-tube system in which there are present the four nucleotides A, T, C, and G as triphosphates, a buffer solution, magnesium ions, and a polymerizing enzyme. DNA molecules added to this system appear to be replicated. Is the new DNA like the primer molecules added? One important observation suggests it is. The ratio of A:T nucleotide pairs to C:G pairs of the product is like that of the primer DNA. It is not easy to see how this could be if the primer were not being copied in a precise way. On

the other hand, if DNA having known biological activity (as determined by ability to transform the genetic constitution of a bacterium) is used as a primer, both the product and the primer added end up being inactive. Why this is so is not known, but it is strongly suspected that the polymerizing enzyme added contains a small amount of depolymerizing enzyme that breaks up DNA chains and thus destroys activity.

Again, the Kornberg synthesis does not prove that the hypothesis is correct. It is just possible that an unkind nature could have evolved a system that would do just exactly what the hypothesis predicts but by a different mechanism.

About the next question: How is genetic information translated? How do we develop from that minute egg cell? These are enormously difficult questions, and we know relatively little in detail about the answers. They involve the whole of development, differentiation, and function. There are working hypotheses—widely used and useful ones—that suggest how some of the steps occur.

We know that in our bodies there are many thousands of kinds of protein molecules—large, long molecules made of amino acids and very specific in their properties. One, for example, is hemoglobin. It is built of 600 amino acids strung together in a particular way. There are two kinds of chains of amino acids per hemoglobin molecule, each in pairs, with each chain about 150 amino acids long. And we know that there are segments of DNA—two, we postulate—in our chromosomes that say how to build the two protein subunits.

A widely used working hypothesis assumes that against a single chain of DNA there is formed a chain of another kind of nucleic acid, called ribonucleic acid or RNA. RNA like DNA, is built of four nucleotides. The DNA code is translated into a complementary sequence of RNA. RNA then moves from the nucleus into the cytoplasm. There it is incorporated into microsomes, submicroscopic structures in which protein synthesis occurs. In the microsome, RNA units are believed to serve as templates against which amino acids are lined up in proper sequence.

Amino acids, derived from the proteins in our food, are first activated by enzymes and subsequently hooked to small carrier segments of RNA that serve to carry the amino acids to their proper places on the microsomal RNA templates.

For each amino acid there is a specific carrier RNA, made up of about 80 nucleotides. Each of the 20 carrier RNA's contains a coding unit of 3 nucleotides presumably complementary to a 3-nucleotide coding unit in the template RNA in the microsome. When all coding units in the template are matched by their complements, the amino acids are lined up in proper order along the template and are joined

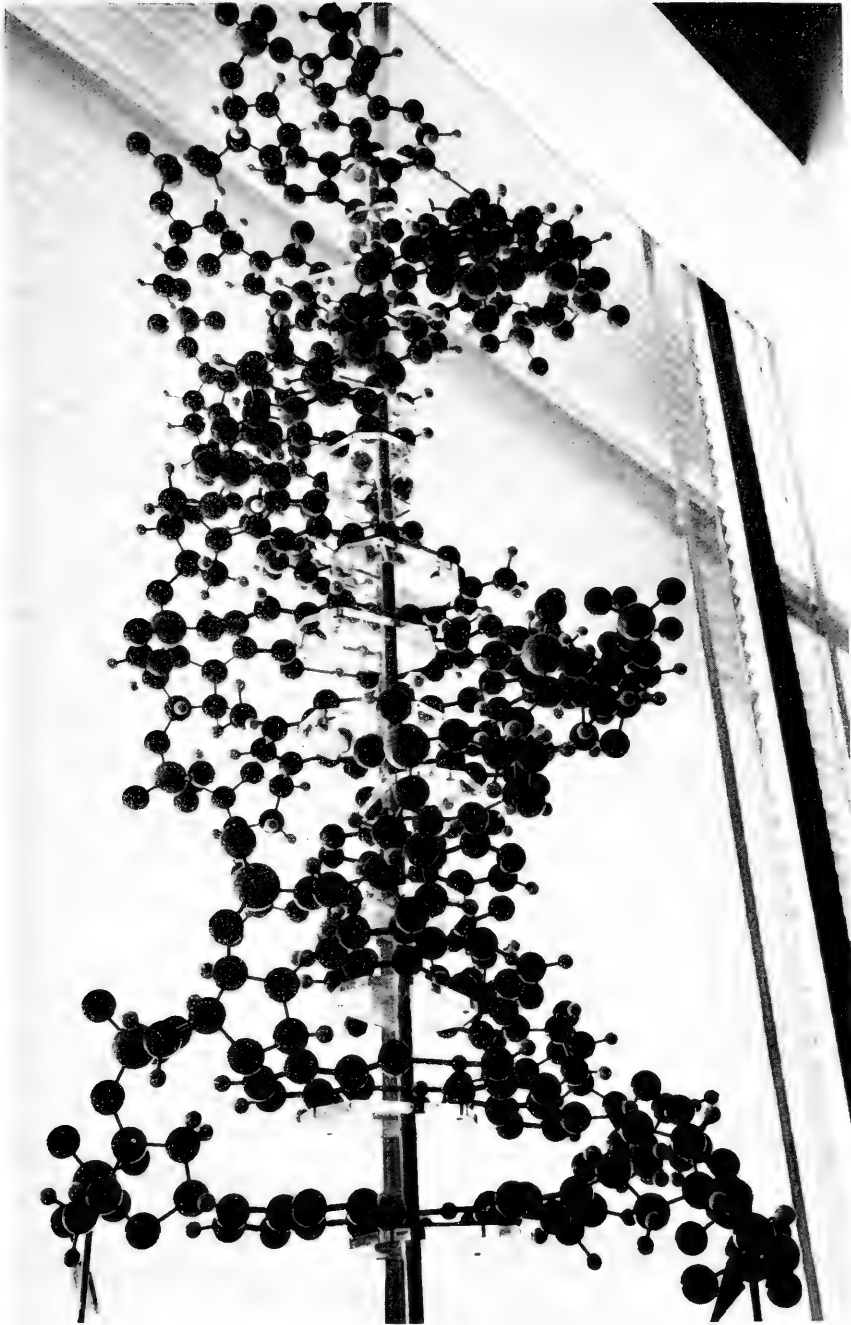

DNA molecule model.

chainlike through peptide linkages. The resulting protein then peels off the template and the process is repeated. For hemoglobin, for example, there are assumed to be two DNA segments, one for each of the two protein chains, and two RNA templates.

Protein synthesis can be carried out in a cell-free system in which are present ribosomes, template RNA, carrier RNA, amino acids, the requisite enzymes, and other necessary components. By means of radioactive labels it can be shown that proteins are synthesized stepwise beginning at the free amino end and ending up with a free carboxyl group in the last amino acid to be added to the chain. Thus there is a good experimental evidence suggesting that the translation process does occur as postulated.

A large number of proteins serve as enzymes or essential components of enzymes. Enzymes catalyze chemical reactions that would otherwise occur at rates so low that life processes would essentially cease. For each enzyme protein there is supposedly a segment of DNA information in the nucleus—a gene—and corresponding microsomal RNA templates in the cytoplasm of those cells active in synthesis of that particular enzyme protein. An important question of present-day biology is concerned with the nature of the mechanism by which the 4-symbol code of DNA is related to the 20-symbol code of proteins. It is obvious that single symbols of DNA cannot stand for amino acid, for there are only 4. Likewise pairs of DNA symbols will not do, for there are only 16 such pairs if the DNA molecule is read in one direction. If one reads in one direction and uses 3 symbols per amino acid, there are 64 possibilities.

Recent genetic evidence strongly suggests that the code is indeed a triplet code read in one direction from a starting point on the template RNA. Each successive triplet normally encodes an amino acid. Thus if we assume a segment of a template beginning: UCG UUU
UGA UUA UGU UUG - - -, where U (uracil nucleotide) replaces A in the DNA code, the amino acids arginine, phenylalanine, glutamic, tyrosine, valine, and cysteine might be incorporated by the successive underline triplets. The order of nucleotides is determined by making use of synthetic template RNAs. Thus such an RNA template consisting of . . . UUUUUUUA incorporates only phenylalanine and tyrosine. Tyrosine appears to be at the carboxyl end of the polypeptide so synthesized (preliminary reports from S. Ochoa's laboratory). Thus the triplet encoding tyrosine must be read UUA. Now from mutational replacement of amino acids in proteins such as occurs in hemoglobin on mutation from normal hemoglobin to sickle cell hemoglobin in which one glutamic acid unit in the chain is changed to glutamic acid, one can deduce the nucleotide sequence in the code

triplets for other amino acids. Thus if it is assumed that the order of the G, U, and A nucleotides in the glutamic acid code is UGA, then the lysine triplet which is known to contain two A and one U nucleotide must be UAA, thus



assuming the mutation responsible resulted from a change of a single nucleotide.

Study of intra-coding-unit recombinants reveals nucleotide sequence just as classical crossing over indicates gene order and permits the assignment of a unique linear order to genes in a chromosome. This method is being used by Dr. Charles Yanofsky and coworkers.

There is good reason to believe that the genetic code is degenerate in the sense that a single amino acid may be specified by more than one triplet.

The task of deciphering the total genetic code is well along toward solution and one may confidently predict that it will be completed in the near future.

My fourth question concerns the nature of mutation. How is genetic information modified during the replication in a manner that permits organic evolution?

During DNA replication, mistakes are occasionally made. Presumably, during replication a nucleotide does not pick up a complementary partner as it should but instead picks up a noncomplementary one. It has been postulated that such mistakes result from an improbable tautomeric form in which a hydrogen atom is in an improbable position at the exact moment the nucleotide picks up a partner. A wrong partner is therefore selected. In the next round of replication the "wrong" partner will pick up what is its complementary partner, and this will result in substitution of one nucleotide pair for another. This is somewhat like a typographical error. In typographical errors it is possible to have extra letters, too few letters, one letter substituted for another, or transposed letters. Presumably similar kinds of mistakes can be made in genetic information during replication. In fact, there is genetic evidence that these four basic types of mistakes do occasionally occur.

How often do such mistakes occur? Quite infrequently, we believe. From the time one receives a set of directions in the fertilized egg until one transmits it to the next generation—and remember this is perhaps 17 to 20 successive replications of information equivalent to about 1,000 printed volumes—a significant and detectable mistake is made perhaps about once in a hundred times. This is clearly a high order of precision.

What happens to such typographical errors as are made? First of all, it is clear that the DNA molecules will replicate just as faithfully whether the information in it makes sense or not. Its replication is a purely mechanical one, it seems. Therefore mistakes in genetic information will be perpetuated.

It is obvious that if there were no way of eliminating errors in such a process, such errors would accumulate from generation to generation. Perhaps an analogy will make this clear. If a typist types in a purely mechanical way, never proofreading, never correcting, and types successive copies of the same material always from the most recently typed copy, she will accumulate mistakes at a rate dependent on her accuracy until eventually the sense of the original message will be entirely gone. In the same way this would have to happen with genetic information if there were no way of taking care of mistakes. With genetic information something does happen that takes care of mistakes. By extending the analogy perhaps I can make clear what does happen. The typist, typing mechanically, can correct a mistake by a second random typographical error, but obviously the probability of this is extremely low. It is likewise so with genetic information, and it is clear therefore that this is not the principal way in which mistakes are prevented from accumulating. Let us pretend the typist has an inspector standing beside her. When she makes a mistake, he says, "Throw that one away. Put it in the wastebasket and start over." If in the next try she makes no mistake, he says, "All right, now you may type another from the one you have just finished." Each time she makes a perfect copy he allows her to go ahead, but each time she makes a mistake he insists she throw the copy away. That is what happens with genetic information. The inspector is analogous to natural selection. Bad sets of specifications in man are eliminated by natural selection.

A more dramatic term for elimination of unfavorable specifications by natural selection is "genetic death," as used by Dr. H. J. Muller. Individuals developed from unfavorable specifications do not reproduce at the normal rate, and ultimately a line so handicapped dies out. To avoid progressive accumulation of mistakes from generation to generation, it is obvious that every error in replication that is unfavorable must be compensated for by the equivalent of a genetic death. That is why geneticists are concerned about factors that increase the mutation rates.

You may quite properly ask, "Are there no favorable mutations?" The answer is yes, there are occasional favorable mutations; they are, in fact, the basis of organic evolution.

However, because many mutations involve subtle changes that may be favorable under special circumstances of environment or over-all

genetic constitution, it is not easy to estimate the proportion of favorable to unfavorable mutations. Theoretical considerations and a certain amount of experimental evidence agree in indicating that the great majority are unfavorable. Organisms are in general already so highly selected for success in their normal environments that the chance of further improvement by random mutation must be very small. Perhaps an analogy with a fine watch will dramatize the point. Assume the watch is very slightly out of adjustment. A random change brought about, say by dropping it, could conceivably improve the adjustment. Clearly, however, the chance of making it run less well or not at all is enormously greater. Now let us extend our typing analogy. Assume our inspector exercises judgment. When the typist makes an error that improves the original message, he passes it. Thus improved messages will replace their ancestral forms and the improvement will be cumulative. Something like this happens with living systems. Specifications improved by occasional favorable mutations are preferentially reproduced and thus tend to replace their ancestral forms. This is natural selection.

In recent years many factors have been found to increase the frequency of mutations. High energy radiation that penetrates to the cell nucleus is mutagenic in proportion to its amount. A number of chemical agents are likewise mutagenic. It is now possible, for example, to alter nucleotides in known chemical ways that will produce mutations. Oxidation of amino groups of nucleotides with nitrous acid is one way. It is encouraging that biochemists and geneticists who study the mechanisms involved are beginning to be able to predict successfully the types of mutations that are most likely to be produced by specific chemical agents. It is not, however, possible to do this specifically for certain genes only.

Let us now turn to the general question of evolution. What do mutations have to do with the processes by which evolution occurs? It is especially appropriate at this time to discuss this aspect of my subject, for, as you know, this is the hundredth anniversary of the publication of Darwin's "Origin of Species."

Organic evolution is interesting and important in many respects. For one thing, it is not logically possible to accept only a small amount of it, for one cannot imagine a living system that could not have evolved from a very slightly simpler system. Starting with man, for example, and working backward toward simpler systems one sees no obvious stopping place. Our ancestors were presumably a bit simpler than we. Early in man's evolution there were primitive men. And before primitive man there were prehuman ancestral forms capable of evolving into true man. This is true however one defines man. The point is that no matter what living system one thinks of, another is conceivable that is one mutation simpler or different. And so one

can go backward in the evolutionary process to simpler and simpler forms until finally one begins to think of systems like present-day viruses, the simplest of which consist of little more than nucleic acid cores (DNA or RNA) and protein coats. One can easily imagine that before systems of this type there were smaller and smaller systems of nucleic acid and protein capable of replication and of mutation which in turn had ancestors consisting of only nucleic acid.

We know that nucleic acids can be built up from nucleotides and these from simpler precursors. In a lecture delivered a few days ago in this auditorium, Prof. Melvin Calvin talked about the origin of some nucleotide precursors and presented evidence suggesting that some such compounds, or their relatives, are found in certain meteorites. It is assumed that these were formed by natural chemical reactions that went on and are still going on outside living systems. Presumably precursors of nucleotides were formed through such reactions. Professor Calvin also mentioned the evidence that amino acids are made from such simple inorganic molecules as methane, ammonia, hydrogen, and water under conditions assumed to have obtained on primitive earth. It is, I believe, justifiable to make the generalization that anything an organic chemist can synthesize can be made without him. All he does is increase the probability that given reactions will "go." So it is quite reasonable to assume that given sufficient time and proper conditions, nucleotides, amino acids, proteins, and nucleic acids will arise by reactions that, though less probable, are as inevitable as those by which the organic chemist fulfills his predictions. So why not self-duplicating viruslike systems capable of further evolution?

I should point out that nucleic acid protected with a protein coat has an enormous selective advantage, for it is much more resistant to destruction than is "raw" nucleic acid. Viruses can be stored for years as inert chemicals without losing the capacity to reproduce when placed in a proper environment. Of course present-day viruses demand living host cells for multiplication, but presumably the first primitive life forms inhabited environments replete with spontaneously formed building blocks from which they could build replicas.

Before molecules like methane, hydrogen, water, and ammonia there were even simpler molecules. Before that there were elements, all of which nuclear physicists and astrophysicists believe have evolved and are now evolving from simple hydrogen. That is why I say if you believe in evolution at all there is no logical stopping place short of hydrogen. At that stage I'm afraid logic, too, runs out.

The story can, of course, be repeated in reverse. When the conditions become right, hydrogen must give rise to other elements. Hydrogen fuses to form helium, helium nuclei combine to give beryllium-8, beryllium-8 captures helium nuclei to form carbon, and carbon

is converted to oxygen by a similar process. In this and other known ways all the elements are formed. As one goes up the scale, the number of possibilities rapidly increases. As elements begin to interact to give inorganic molecules, the number of possibilities becomes still greater. I do not know how many inorganic molecules are possible, but I do know there must be a very large number. With organic molecules the number becomes truly enormous, particularly with large molecules like proteins and nucleic acids. For example, there are something like 4 raised to the 10,000th power ways a modest-sized DNA molecule can be made. There appears to be no stage at which there is a true qualitative change in the nature of evolution. The number of possibilities goes up gradually, the complexity goes up gradually, and there appears to be no point at which the next stage cannot be reached by simple mutation.

Let us suppose we have a small piece of DNA protected by a protein coat and capable of replication in the presence of the proper building blocks and a suitable environment. During replication, the system will occasionally make mistakes. It is a mutable system. Given sufficient time there will eventually occur a combination of mutations of such a nature that the protein coat will become enzymatically active and capable of catalyzing the formation of a nucleotide or amino acid from a slightly simpler precursor. If this particular building block happens to be limiting in replication, the mutant type will obviously have a selective advantage. It can replicate in the absence of an essential building block by making it from a simpler precursor. If two such units with protein coats having different catalytic functions combine to form a two-unit system, they will be able to make two building blocks from simpler compounds and will be able to survive under conditions in which their ancestral forms would fail. In the same way it is not too difficult to imagine systems arising with successively three, four, five, and more units with every additional unit serving a catalytic function. With each additional unit the total system would become one step less dependent on spontaneously preformed precursors. With perhaps ten thousand such units the system might be able to build all its necessary parts from inorganic materials as we know present day green plants do.

How many units to reach the stage of man? Perhaps one hundred thousand units carrying out one hundred thousand functions are necessary. However many it is, we know they carry the specifications for the development of a complex nervous system by which we supplement blind biological inheritance with cultural inheritance. We reason, we communicate, we accumulate knowledge, and we transmit it to future generations. No other species we know of does this to anything like the same degree. We have even learned about organic evolution and are on the verge of learning how to start the process.

I pointed out that in the Kornberg system with the four nucleotides present, nothing happens unless a primer is added. That is not entirely true. After a delay of some three or four hours something does happen even without a primer. What happens is that a DNA molecule is spontaneously formed. It differs from most naturally occurring DNA in that it contains only two of the four nucleotides. Now if this two-unit co-polymer is used as a primer in a new system, it immediately initiates the synthesis of co-polymers like itself. In other words, it starts replicating. Remember, it arose spontaneously. If you believe in mutation—and you must if you accept scientific evidence—you must believe that if you start with a two-unit co-polymer and let it undergo successive replications, there will eventually occur a mutation with which a pair of nucleotides will be replaced by the pair originally excluded in the process. This conceivably could have been the origin of the four-unit DNA of all higher organisms.

Knowing that we now know about living systems—how they replicate and how they mutate—we are beginning to know how to control their evolutionary futures. To a considerable extent we now do that with the plants we cultivate and the animals we domesticate. This is, in fact, a standard application of genetics today. We could even go further, for there is no reason why we cannot in the same way direct our own evolutionary futures. I wish to emphasize, however—and emphatically—that *whether* we should do this and, if so, *how*, are not questions science alone can answer. They are for society as a whole to think about. Scientists can say what is possible and perhaps something about what the consequences might be, but they are not justified in going further except as responsible members of society.

Some of you will, I am sure, rebel against the kind of evolution I've been talking about. You will not like to believe that it all happened "by chance." I wish to repeat that in one sense it is not chance. As I have said, the mutations by which we believe organic evolution to have occurred are no more "chance" reactions than those that occur in the organic chemist's test tube. He puts certain reactants in with the knowledge that an expected reaction will go on. From the beginning of the universe this has been true. In the early stages of organic evolution the probabilities were likely very small in terms of time intervals we are accustomed to think about. But for the time then available, they were almost certainly not small. Quite the contrary; the probability of evolving some living system was likely high. That evolution would go in a particular direction is a very different matter. Thus the *a priori* probability of evolving man must have been extremely small—for there were an almost infinite number of other possibilities. Even the probability of an organism evolving with a nervous system like ours, was, I think, extremely small because of the enormous numbers of alternatives. I am therefore not at all

hopeful that we will ever establish communication with living beings on other planets, even though there may well be many such on many planets. But I do not say we should not try—just in case I am wrong!

Some of you will no doubt be bothered by such a “materialistic” concept of evolution. Ninety years ago in Edinburgh, Thomas Henry Huxley faced this question of materialism in his famous lecture on the physical basis of life. And it has been faced many times since—for example, a few years ago by Dean George Harrison of M.I.T. in his book “What Man May Be.” What Huxley said can be said today with equal appropriateness. He said in effect that just because science must by its very nature use the methodology of materialism, scientists need not necessarily be materialists. A priest wears material clothes, eats material food, and takes his text from a material book. This does not make him a materialist. And so it need not with a scientist. To illustrate, the concept I have attempted to present of the origin of life and of subsequent evolution has nothing to do in principle with the problem of ultimate creation. We have only shifted the problem from the creation of man, as man, to the creation of a universe of hydrogen capable of evolving into man. We have not changed the problem in any fundamental way. And we are no closer to—or further from—solving it than we ever were.

The Shark That Hibernates¹

By L. HARRISON MATTHEWS, F.R.S.

Scientific Director, Zoological Society of London

THE basking shark is among the largest of living fishes for it reaches a length of nearly 30 feet and a weight approaching 4 tons; only the great whale shark of tropical seas exceeds it in length and bulk. Basking sharks are found in all the oceans of the world except the coldest, but it is not certain, although it is probable, that they are all of one species; those that live in the North Atlantic belong to the species *Cetorhinus maximus*. The basking shark is common in the seas of western Europe, at least during the summer months, and is conspicuous when it approaches the shore and swims so near the surface that its enormous back fin sticks out of the water. The habit of swimming slowly at the surface has given rise to the common name of the animal (although it does not literally bask) and to the alternative local name of sailfish. In spite of its great size, comparative abundance, and frequent conspicuousness little was known of the anatomy and less of the natural history of the species until recent years—and many questions have still to be answered.

My own special interest in the basking shark dates from 1947, when Dr. H. W. Parker and I were invited by Maj. Gavin Maxwell to visit his shark fishery in the Hebrides to study its biology. Our investigations produced much unexpected information.

The body of the basking shark is fusiform or cigar shaped, with the greatest diameter about one-third of the body length behind the tip of the snout. Two large triangular fins are set on the back, the front and larger one nearly 6 feet high a little in front of mid-length, the smaller one nearer the root of the tail below which there is another small triangular fin. The tail fin is very large and is asymmetrical, the upper lobe being the bigger; it is crescentic in outline and measures 6 feet or more from tip to tip. The paired pectoral fins are also very large, their leading edges measuring between 5 and 6 feet. In life they are held more or less horizontally and act as planes supporting the front part of the body which, without them, would be driven

¹ Reprinted by permission from the *New Scientist*, No. 280, March 29, 1962.

downward by the action of the tail fin. The paired pelvic fins are much smaller and lie well back toward the tail. The tip of the snout is bluntly pointed, and the front of the mouth lies about 18 inches behind it; at this point the tubular nostrils lie on each side of the midline, and a little behind and above them the comparatively small eyes. The mouth is enormous and measures about 3 feet across when open. The most conspicuous feature of the head region, however, is the series of gill openings, five on each side. As in all sharks the spaces between the gill arches open separately on the surface and are not concealed by a gill cover as in the bony fishes. In most sharks the spaces appear as slits at the side of the "neck," but in the basking shark they are so large and extend so far around the sides of the "neck" that those of opposite sides almost meet on the upper and lower surfaces—it is surprising that so little tissue is sufficient to prevent the head falling off.

The color of the basking shark is dark gray, almost black, with an inconstant amount of light gray or white along the center line of the belly. There are darker patches on the background color, and when there are many they are arranged as indefinite longitudinal streaks. The skin is entirely covered with small placoid scales, or denticles, shaped like minute thorns about a millimeter long with the points facing backward. The skin feels smooth to a hand passed over it from before backward, but exceedingly rough to one passed in the reverse direction. It is also plentifully supplied with mucus glands, so that during life a film of slime covers the entire surface to the summits of the denticles. The skin covering the body is continuous with that lining the mouth (on which, however, the denticles are very much smaller), but where the skin passes over the jaws the denticles are enlarged and form the teeth. The teeth are unlike those one expects to see in the mouth of a shark—there is no fearsome array of pointed blades, sharp as razors—for they are no more than about 5 millimeters long and are arranged in four to seven rows so that they look like a rather coarse rasp.

The teeth alone show that the basking shark is no fierce predator, and indeed all its anatomy and habits are highly adapted to its very specialized method of feeding. Like the great whalebone whales this shark is a plankton feeder, and although it is one of the biggest fishes in the sea its food consists of minute creatures barely visible to the naked eye. Like the plankton-feeding whales, too, the basking shark is provided with a special apparatus for straining its food in bulk from the sea water. Fishes breathe by pumping a stream of water over the gills, where some of the oxygen dissolved in the water passes through the exceedingly thin covering membrane into the blood in the underlying capillaries, and the carbon dioxide in the blood passes out into the water. The stream enters the fish's mouth and passes out

through the gill slits between the curved gill arches of bone or cartilage on which the gills are borne. The gills are complexly folded, so that they have a very large surface area through which exchange of gases between blood and water can take place; in a basking shark 7 meters long this area is approximately 270 square meters. In some fishes, including the basking shark, the gill arches carry, in addition to the gills, structures known as gill rakers. The rakers of the shark resemble long bristles set along the edge of the gill arches with their free ends pointing toward the mouth cavity; there are 1,000 to 1,300 of them on each side of all the 5 gill clefts. The rakers, which are highly modified placoid scales, are flexible but stiff, and are calcified toward their bases, and there is a mass of mucus glands at their attachment to the arch. Muscle fibers connected to their bases can erect the rakers so that they stand out and project across the space between adjacent arches. When the fish opens its mouth the rakers spring up and form a fine sieve through which the water has to pass before it flows over the gills.

When feeding near the surface the basking shark cruises slowly at about 2 knots with the mouth widely open, filtering the plankton out of the sea water and at the same time automatically respiring. The gill slits are widely opened and the whole pharyngeal region is greatly expanded and characteristically fanned out. The area of the open mouth is at least $\frac{1}{4}$ square meter so that, at 2 knots, 1,484 cubic meters of water are filtered per hour—well over a thousand tons. When the mouth is periodically shut the gill slits close and the rakers fold down on to the arches so that the plankton entangled in the mucus secreted over them passes into the mouth and is swallowed. The back of the mouth is covered with papillae which at the gullet are complexly branched and knobbed and form a valve that closes the back of the mouth—they look strangely like a huge cauliflower filling the passage. The stomach is very large, and when the fish is feeding, it contains about half a ton of tomato-red mush of plankton of which, however, only about 30 percent by weight is organic matter, much of it being mucus derived from the fish itself.

The first stages of digestion take place in the stomach and the small planktonic Crustacea are broken up into minute fragments; they are concentrated on passing into the narrow pyloric loop of the stomach where great quantities of water are removed, for the content of this organ is a firm paste resembling anchovy paste in color and consistency—and, somewhat, in taste. On leaving the pylorus the gut contents enter a small sac, the bursa entiana, in which the oily fraction is separated. The sac is filled with bright red oil, the color being produced by the astacene derived from the crustacea. It is difficult to understand how the oil can be retained in the bursa while the solid contents of the gut pass on, but so it is. The food from which the oil

has been extracted, passes on as a brownish-yellow chyme to the duodenum and spiral valve, where digestion is completed under the influence of the bile and pancreatic secretions. The oil in the bursa is taken up by the cells of its lining and finally transferred to the liver after undergoing metabolic change.

The liver is comparatively enormous, its two huge lobes weighing together about a ton, no less than a quarter of the total weight of the fish, by far the greater part of its weight being due to the oil. In the economy of the fish the liver acts as a hydrostatic organ so that the total density of the fish, which possess no air bladder, approximates to that of the sea water. In the economy of man the liver is the fish's undoing, for the oil is easily extracted and has a commercial value—without this wealth to be had for the taking, the basking shark would be of no interest to the fisherman. On the west coasts of Ireland and Scotland the basking shark had been for centuries the subject of a cottage industry until the introduction of paraffin about the middle of the last century. A moderate number of them were taken annually with primitive gear worked from small boats in order to obtain illuminating oil for winter nights. Petroleum killed this fishery and for long the sharks were seldom molested but in recent years commercial fishing on a larger scale has been developed.

Basking sharks appear off the British coasts in some abundance during the spring and depart in the early autumn—whence they come and whither they go is unknown. But even in the winter occasional fish are seen and sometimes caught or stranded on the shore. There is a very peculiar thing about these winter strays—they have no gill rakers; in every way the fish are normal except in the complete absence of rakers from the gill arches. Careful dissection, however, reveals that under the skin of the gill arches a set of rakers is in course of being developed. As the rakers are homologous with scales and teeth which are replaced as they are worn out, there is no reason why they too should not be replaced when necessary. When fully developed they erupt through the skin of the arches much as we cut our second set of teeth.

Why should this replacement be necessary? And how does the shark feed when it has no rakers? During the warmer months the fish feed luxuriously on the rich summer plankton, gulping it down by the ton; but in winter the pastures of the seas are bare and there is little nourishment to be found. The power needed to propel a feeding shark of average length at its feeding speed of 2 knots is about 0.33 h.p.; the heat equivalent of this is 212 calories per hour. Allowing 40 percent efficiency to the shark's muscles in doing work, and 80 percent to its tail as a propeller—a very generous allowance—a shark 7 meters long would need to take each hour food with a calorific value

of 663 calories to give merely the energy required in swimming to collect the food. Even if we multiply the recorded density of plankton in the North Sea in November by three, the shark's intake could be only 410 calories per hour under the most favorable conditions, and it would be losing on the deal. So it solves its problem by throwing away its rakers worn by a season's use, refraining from feeding, sinking to the bottom and hibernating. At this moment there are probably great schools of these enormous fish quietly resting on the bottom of the sea, perhaps in the heads of the canyons at the edge of the continental shelf, with their metabolism running at its lowest level while they grow their new gill rakers ready for browsing on next summer's crop of plankton.

The "basking" of this shark is probably connected in some way with its breeding as well as its feeding. The fish do not invariably swim straight ahead; sometimes two or more are seen to follow each other about in comparatively small circles, apparently indulging in elephantine gambols which may be a form of nuptial behavior. However that may be, it is certain that pairing takes place in the early summer, though it may also take place at other times. As in all elasmobranchs, or cartilaginous fishes, fertilization is internal, and the sperm is transferred to the female by means of modified parts of the male's pelvic fins called the claspers. Each clasper of the basking shark is about 4 feet long, and its skeleton is rolled into a scroll that forms a tube through which the sperm passes. The sperm is unlike that of other fishes, for it is not a suspension of spermatozoa in a fluid medium but is concentrated into spermatophores. The lower part of the genital duct of the male is a large ampulla, a cavity of complicated internal structure in which the sperm entering the fore end are gathered into small masses around which a thick envelope of firm transparent gristly substance is laid down. The core of each spermatophore into which the sperm are concentrated is about 1 cm. in diameter, but the thickness of the envelope is such that the diameter of the spermatophore is from 2 to 5 cm. About 5 or 6 gallons of these peculiar bodies are tightly packed inside each ampulla, and float in a watery fluid.

The presence of great quantities of spermatophores inside the females in May showed that copulation was occurring then. Furthermore, the clasper of the male bears a movable spur armed with a hard curved claw that evidently serves to maintain the clasper in position within the common vagina of the female. Although many of the females examined in May contained no spermatophores they carried large internal lacerations made by the claws. The spermatophores are received into a capacious uterus where a secretion acts upon them and rapidly dissolves their hard envelopes, thus releasing the sper-

matozoa from the cores and setting them free to make their way up the genital tract.

There are two uteri, one on each side of the abdominal cavity. They are lined with a vast number of small tags or trophonemata that in many other elasmobranch fishes secrete nourishment for the young, which develop inside the uterus until they are ready to be born alive. By analogy, therefore, it is believed that the basking shark is viviparous. On the other hand, the ovary of the basking shark is strikingly different from that of other elasmobranchs, which produce only a few large yolky eggs, whether or not development takes place within the mother. The ovary of the basking shark produces a very large number of minute eggs containing a comparatively small amount of yolk, and in this particular resembles that of most bony fishes. It contains at least 6 million eggs 0.5 mm. or more in diameter, the largest not more than 5.0 mm. in diameter. They appear to be ripe at the latter size, and are released from the ovary through a complex system of branching canals. It is improbable that they grow larger before being released, for the upper part of the oviduct, in contrast to the enormous uterus, is extremely constricted. It has tough inelastic walls giving a canal only 2 to 3 mm. in diameter, so that even an egg no more than 5 mm. in diameter must undergo considerable distortion in passing through this narrow passage.

The basking shark thus shows the paradox of a large ovary containing great numbers of minute eggs as in fishes that spawn, and a large uterus lined copiously with trophonemata (threadlike projections for nourishing embryos) as in viviparous elasmobranchs. Nevertheless it is probable that the fish is viviparous—no elasmobranch is known to spawn, and in those that lay eggs there is a large nidamentary gland which produces the albumen and the shell, and there is no proliferation of trophonemata in the uterus. The basking shark has a small, almost rudimentary, nidamentary gland, and a great profusion of trophonemata.

The paradox could readily be resolved were a pregnant female examined; but no pregnant female has ever been seen. It is evident, therefore, that after insemination in the early summer the females must, before any embryo is recognizable, refrain from basking and either swim near the bottom or leave inshore waters, or both. Where and when the young sharks are born is unknown, but the smallest specimens recorded measured about 6 feet in length; evidently that is the size at which they are born. They have always been found in early summer, and consequently it is possible that they are born during the inshore movement of the adults at that time.

There is space only to mention a final point among the many unanswered questions about this elusive fish. In the commercial catch,

which is presumably a random sample, the females outnumber the males by 30 or 40 to 1. It is unlikely that these figures are the true sex ratio of the population. Where are the other males? Do they habitually swim at greater depths, and come to the surface only in quest of the females? Are they shyer of the predacious fisherman? Or is there a social structure in the population so that dominant males herd harem schools of females and keep their rivals at a distance? Some fortunate naturalist may one day be able to find the answers to this and many other riddles about these interesting creatures.

Man in a World of Insects¹

By DWIGHT M. DELONG

Professor of Entomology, The Ohio State University, Columbus

Numerous scientific scholars have attempted to define or name the present age of biological development in line with past evolutionary ages. The geologist has referred to it as "the age of man." Others have referred to it as the Psychozoic Era. This is undoubtedly the result of the general belief that man is the dominant and superior type of animal on the surface of the earth and that he is capable of conquering or subduing every other form of life.

Of course we are extremely egotistic. Many of us believe that the world was created for us and that everything on the earth is intended in some way, directly or indirectly, for our use or benefit. But the truth is that man is only one of the recent products of organic evolution. It is true that man has become the dominant type of vertebrate animal, but he must constantly be aware of, and compete with, the dominant type of invertebrate, "the world of insects," which comprises four-fifths of all the animals on the earth, some 800,000 species, and which man has never subdued. One author has referred to this era as the "age of insects," another writes of the "insect menace," and a recent film which is an excellent portrayal of this struggle is entitled "The Rival World."

When primitive man arrived on the earth as a product of evolution, he found it already occupied and well populated with insects. This has been proved to us by the paleontologist, with his undisputable evidence of fossil records. The paleontologist tells us that insects are recorded in the late Paleozoic, which was some 200 million years ago, and at that time they were well developed, so that they must have appeared much earlier. There cannot be the faintest doubt that millions of years must have been required for the evolution of the insect world as it existed in the upper Carboniferous period. This historic evidence leads us to believe that insects came into the world some 300 million years ago or more, became highly developed through

¹ Presidential Address, 69th annual meeting of the Ohio Academy of Science, Antioch College, April 22, 1960. Reprinted by permission from the Ohio Journal of Science, vol. 60, No. 4, July 1960.

rapid multiplication by means of quickly developing, short cycle generations, and by rapidly evolving through ages of time they have become highly adapted and perfectly fitted through mutation and selection to every natural condition on the earth.

The mammals in general and man in particular arrived in this insect world long after the insects had taken possession of practically every habitat on the earth. Primitive man arrived not more than a million years ago—some authorities say about one-half million. Modern man has been here not more than 50,000 years. He is not so well adapted as the insect; he is a comparative newcomer. He spends his time and efforts converting the materials of the natural world into man-made structures and plantings. Unlike the insect, he does not attempt to live in the natural world as he found it.

The evolution of the insects was apparently not always successful for in the late Carboniferous period we find enormous cockroaches and dragonflies with a wing spread of more than 2 feet which apparently have long since been lost as failures in a competitive organic world. But see the successful mutants which have arisen from these ancestors! The present-day species of roaches are the German, American, Oriental, and others, which inhabit our homes and kitchens, invade our restaurants, markets, and night-clubs, and are carried everywhere in trucks, steamships, airplanes, and other conveyors in all type of receptacles, whether they contain food, clothing, or other materials.

Insofar as historic records are available, man has in all ages since his arrival on the earth been tormented by the ravages of insects upon him directly or upon his food and possessions. On the other hand, he has often turned to the insect as a source of nourishment to sustain life. The authors who wrote the Bible point out the occurrence of many insects—ants, bees, locusts, lice, fleas, hornets, flies, and moths, for example. They describe the terrific populations of migratory locusts (grasshoppers) which completely destroyed the crops and devastated the fields. This is similar to the devastations of the forage crops of our own Plains States by migratory grasshoppers—the Rocky Mountain locust—in the middle of the 19th century.

The ant and the bee are cited in the Bible as examples of industry and aggressiveness. They are carved on Egyptian monuments. Grasshoppers, and honey and manna as insect products, are listed as foods which were apparently largely responsible for the sustenance of the children of Israel while they were sojourning in the wilderness. Honey was a marketable product several thousand years ago; it was used in sacrificial offerings and was believed by the ancient people to have medicinal qualities.

The majority of insect species have no economic status and are seen only incidentally by man. They are considered as neutral. The remaining forms could be divided into two groups, the constructive and the destructive. If man attempts to evaluate the role of his insect associates, he will need to enter them on the ledger as either assets or liabilities, namely, those that benefit him or those that do him harm. We speak of many insects as being beneficial to man, and although we may be reluctant to admit it, we are actually dependent upon insects for much of our food supply, either directly or indirectly. In fact, the peoples of the world could not be fed today except for their assistance.

INSECT ASSETS—THE CONSTRUCTIVE

Insects and pollination.—Biologists in general have agreed that one of the major benefits derived from insects is the production of crops which result from their services as pollinating agents. It would be difficult to estimate the value to man of pollinating insects, but the sum is enormous. It has been demonstrated that at least 50 agricultural crops depend on flower-visiting insects for pollination, or yield decidedly more abundant crops when bees are present. This list as reported by the U.S. Bureau of Entomology and Plant Quarantine includes most of the important fruits and vegetables, forage crops, legumes, and certain special crops. The real value to man is the production of seed and fruit. Without insects to effect pollination, many species of plants will not set seed or produce fruit no matter how well they are cultivated, fertilized, and protected from diseases and pests.

Although the honey bee is the most important pollinating insect, it is but one of many species of bees necessary for the perpetuation of flowering plants. Various species of flies, beetles, and other insects also visit flowers and to some extent pollinate them. The Bombyllidae are particularly known for their pollinating habits. The importance of the honey bee is especially noted because it and certain wild bees must obtain nectar and pollen in order to nourish both the young and adults. This is not the case with other pollinating insects.

Furthermore, agricultural development has seriously interfered with the balance in nature by demanding enormous acreages for cultivation. The nesting places of wild and native pollinating insects have thus been destroyed. As a result the burden of pollination has been increased to such an extent that wild bees are no longer adequate or dependable. Honey bees must be introduced seasonally in certain specific areas for pollination, and they have thus become the most numerous of the flower-visiting insects. It is essential, nevertheless, to work to conserve our native pollinating insects, since some species of native bees are more efficient, bee for bee, than honey bees and will work under more adverse conditions.

Insect products.—Certain insects are of benefit to man by their direct production of materials which serve as his food, or from which he can manufacture marketable products.

The honey bees produce some 250 million pounds of valuable and nutritious food each year in the form of honey. They also produce several million pounds of wax which is used in a great variety of industries, including both wartime and peacetime products. Wax is used, for instance, in the sealing and coating of shells, for ignition apparatus, in the manufacture of cosmetics, in candles for religious purposes, in dental supplies, in pharmaceutical salves, in carbon paper, in confections, in printers' ink, in engravers' wax, and in the lubrication of dies for drawing sheet-metal tubes and cylinders.

In the Orient a pure white wax is produced by scale insects of the genus *Ericerus*, and in the semiarid regions of Mexico and the southwestern United States wax is produced by scale insects of the genus *Tachardiella*.

Other commercial products of lesser importance or monetary value are produced by other scale insects. Notable are the lac insects, which occur in many of the tropical and subtropical countries such as Ceylon, Formosa, India, the East Indies, and the Philippine Islands. These insects encase their bodies with a secretion which encrusts the limbs and twigs of trees upon which they live with a resinous deposit one-fourth to one-half inch thick. This substance is melted, refined, and placed on the market as shellac and is also used extensively in the manufacture of paints and varnishes.

Certain other scale insects known as cochineal insects are common on cacti in Mexico. Their bodies are collected, dried, and used by the native Indians for the preparation of a crimson or vermilion dye. In the 19th century a cochineal manufacturing industry was established in the Canary Islands where it flourished until 1875.

Insects as food.—Indirectly, insects are of great importance to the food supply of man the world over, as they supply the basic or initial food materials that are transformed into the bodies of food animals, especially birds and fishes, whose flesh later finds its way to our tables. These insects are as much a part of the food chain for fish and fowl as corn is a part of the food chain for the bacon, ham, or beef that we eat.

While the value and acceptability of the bodies of insects as food for man might be questioned, there are many instances where they have been or are being used. Our close neighbors, the people of Mexico, utilize several types of insects as food. The larval stage of a large hesperid skipper which lives in the maguey or century plant may be purchased alive in the markets in lots of 10 or 12, tied in a small sack made from the thin membrane of the maguey plant, or they may be purchased in cans put up by commercial canning com-

panies. At one of the regular meetings of the Columbus Entomological Society in 1941 these larvae were served as refreshments and some 75 persons partook of them upon this occasion. Other insects used as human foods in Mexico are the eggs of certain aquatic Hemiptera, particularly Corixidae and Notonectidae, which are utilized for the production of an edible meal known as "ahutle." In towns near Lake Texcoco dried cakes containing these insects may be purchased in the markets.

Certain California Indians obtain in quantity from Mono Lake and other highly alkaline and saline lakes a brine fly, *Ephydra hians*, in the pupal stage, which is dried and furnishes a highly nutritious food known as "koochabe."

In the Old World, grasshoppers have been eaten by man for centuries, native tribes commonly roasting them. In the Belgian Congo, dried termites are sold in baskets at the native markets, and termite queens are roasted or fried in fat. Termites are also eaten in the oriental Tropics. Certain of the larvae of various large beetles are also roasted, fried, or boiled by the natives of several of the tropical countries. The Laos Indians of Siam feast upon both adults and larvae of one of the dung beetles. Of the many specific types of insects which have been utilized as food, one of the most curious is the giant water bug, *Lethocerus*, which, being large in size, is steamed and then picked like a lobster.

Silk production.—Fiber for cloth is also furnished by an insect. The silkworm has for many years been considered the second most commercially important beneficial member of the insect world. From modified salivary glands it has furnished the raw materials for large industries in both Asia and Europe, where caterpillars are reared and raw silk is produced. This has been an especially important industry of the Orient.

The Chinese silkworm, *Bombyx mori*, has been reared in quantity in captivity for so many years that it is at present impossible for it to exist without human care. This rearing involves extensive hand labor, making silk a costly fiber. The industry is valued at millions of dollars, but its existence is seriously threatened at present by the manufacture of synthetic fibers which are rapidly and largely replacing silk and by the growing trend toward the formation of democracies in the Orient, under which conditions the high cost of labor will make the price of silk prohibitive.

Insects in medicine and surgery.—Man has recognized the medical value of certain insects and for some time has used their products as therapeutic agents. Cantharidin has been produced from the bodies of blister beetles and is used in the treatment of certain conditions of the urogenital system. The importance of this drug was probably not fully realized until World War II when shipments of insects for its

manufacture could not be obtained from Europe. The pharmacists then became disturbed when they learned that different species of beetles contained different percentages of cantharidin and that the species in the United States yield very small percentages. Cantharidin has not been, and apparently cannot be, produced on a commercial scale from native blister beetles.

Another example of the value of insects in medicine is the use of blow-fly larvae to render aseptic and hasten the healing of surgical wounds caused by osteomyelitis. In a field dressing station in France during World War I a young surgeon observed severe shrapnel wounds containing infestations of fly maggots and noted the subsequent rapid recovery of the soldiers so infested. After returning to the United States he was responsible for the experimental treating of wounds with fly larvae of *Lucilia serricata* and *Phormia regina* reared under aseptic conditions. Through this treatment a therapeutic agent, allantoin, has now been developed and fly maggots are no longer being used. At present allantoin is being used in the treatment of osteomyelitis and other deep-seated wounds in which there is decaying tissue. The fact remains that it was through the use of fly maggots and a study of their physiologic action that a modern medical treatment was developed for a condition which was previously very difficult to cure.

Insect parasites and predators.—Some of the most valuable insects are those which live upon or within other insects, particularly noxious plant-feeding species, and thus destroy them. We usually classify these as parasites and predators. Both types are important, although the parasites are much more complex in their biology and adaptations.

Predation is a common mode of sustenance of many types of animals, including man. The development of predation in insects is hard to trace, but we know that it existed in certain forms such as the dragonflies, which were major types of insects in the late Carboniferous and early Permian periods. The habit of predation is found generally throughout the insect orders. In many species and groups, however, predation may not be beneficial to man. This is especially true in the case of the large group of aquatic predatory insects. Even when the predatory habit is beneficial, such as the aphid-feeding habit of the tree crickets, the benefit is often offset by an injurious habit such as egg-laying in twigs or stems which causes untold injury to the plant or crop.

There are many groups in which predation brings enormous value to man. This is particularly true of those insects which feed upon colonies of aphids or attack caterpillars upon the ground. Most of these have insatiable appetites and are therefore important factors in the control of the insects upon which they prey. The following data will bear out this statement:

A ladybird beetle, *Coccinella californica*, according to Clausen, requires 475 aphids at the rate of 25 a day for development and, after transforming into an adult beetle, eats 34 per day during its remaining life. Perhaps the greediest coccinellid species recorded is *Chilocoris similis*, which Nakayama has found consumes on an average 1,563 aphids per individual during its lifetime. In the case of the aphid lion, *Chrysopa californica*, a larva may consume 141 aphids during its larval development. The syrphid fly larvae have equally voracious appetites. Two species reported by Curran, *Allograpta obliqua* and *Syrphus americanus*, consumed 265 and 474 aphids, respectively, during their larval development.

The ground beetles, one of the largest families of Coleoptera, often attack larger insects. Their importance lies in the fact that here is a predacious group which covers the surface of the earth, continuously patrolling it and devouring untold numbers of insects, particularly caterpillars whose life cycle is such that they must drop to the ground as full-grown larvae and penetrate its surface twice, once to pupate and again to emerge. This offers the opportunity to our carabid patrolmen to see that few pass or repass without being apprehended. Considering the large numbers of prey that are destroyed by a single individual during the course of its life, we are forced to admit that predatory insects play a primary role in checking the increase of destructive forms and are thus of great value to man.

Insect parasites.—Insect parasitism is extremely diverse and may in some instances verge on predatism, scavengerism, and commensalism. In addition to this there is a wide range of parasitic behavior among the truly parasitic species. This is probably due to the fact that parasitism has arisen independently in various groups of insects although certain parallel developments have occurred among these different types.

One group of parasitic insects is known as ectoparasites and these are predominantly blood-sucking species such as mosquitoes, black flies, horse flies, blood-sucking lice, bed bugs, other Hemiptera, etc., which attack vertebrate animals. With few exceptions these are not beneficial to man.

The entomophagous parasites are usually forms that feed inside the bodies of their insect hosts and either destroy them or render them sterile so that they are not able to reproduce. These parasites occur in several orders, and one insect order, the Strepsiptera, is composed entirely of parasitic species. These develop internally as parasites of bees, wasps, and certain Homoptera.

By far the greatest number of parasites are Hymenoptera, and probably half or more of the known species of this group are parasitic on other insects. Certain minute forms like *Trichogramma* will parasitize insect eggs, and an individual parasite can develop to maturity

within the egg of the host. Others such as the braconoids or ichneumonids may parasitize the larvae. The larval parasites are frequently quite specific, and a high percentage of the host species may be destroyed. As an example of this type of parasitic control, the soil under a tree or plant may be so completely covered by the empty cocoons of braconid parasites that the surface appears white. An experience encountered a few summers ago is further evidence of the percentage of parasitism. An attempt was being made to secure a number of normal sphinx moth larvae on catalpa. Several hundred individuals were collected from a small area of concentrated plantings, and during the examination of some 300 specimens not a single larva was found free from parasites.

These parasites are of enormous value to man in the continuous combating of almost every important economic insect pest. Many other insects would probably become important pests if it were not for the parasites that constantly hold them in check. One of the most interesting and remarkable examples of the importance of insects as natural enemies is the almost exclusive use of insect parasites and predators in the control program of orchard insects in the fruit area at Kentville, Nova Scotia, Canada.

Insects as scavengers.—The insect scavengers are those which feed upon decomposing plants or animals, or on dung. Such insects assist in converting these complex organic materials to simpler chemicals which are returned to the soil where they are available to plants for the production of new organisms.

Carrion-feeding insects such as blow flies, carrion beetles, rove beetles, skin beetles, and others are of value in removing or often burying carrion. Dung beetles of several families and dung flies hasten the decomposition of dung. Insects such as termites, carpenter ants, wood-boring beetles, and other wood feeders are important agents in hastening the conversion of fallen trees, logs, and stumps to soil. The galleries of these insects serve as avenues of entrance for fungi and other organisms of decomposition which hasten the breakdown of the wood.

We have observed the organic cycle in nature since our earliest recollections and as a result have accepted this condition without further thought. The value of insect scavengers can be best emphasized by asking how long we would be able to survive in a world where dead bodies of plants and animals were not broken down and returned to soil and where the earth's surface would as a result in time become covered to a depth of several feet with such organic waste. These insect scavengers are indeed essential to maintaining a balance in nature.

Importance of soil insects.—Many types of insects spend part or all of their lives in the soil, where many life activities and processes

are carried on. Many forage above the surface, carrying organic materials below, where new tunnels or burrows are continuously made. The soil is thus aerated and continuously enriched by their excretions and the decomposition of their dead bodies. In this manner soil insects improve the physical properties of the soil and add to its organic content. We should hasten to add that soil insects vary greatly in their feeding habits, and some that are root-feeding forms in the larval stage, such as white grubs and wireworms, are quite injurious and are of much more harm than benefit to man. There is no question, however, that many soil-inhabiting forms are beneficial and are of value to man.

Insects destroy noxious plants.—A survey of insect feeding habits has established the fact that a large proportion of insects feed on plants but only a small number of these are considered pests. Many of the others may be beneficial by destroying cacti, noxious weeds, or undesirable deciduous plants. It often happens that when a plant is introduced into a new geographic area it thrives to such an extent that it becomes a pest. In some cases plant-feeding insects have been introduced to bring this plant under control. The pricklypear cacti (*Opuntia* spp.) were at one time introduced into Australia, and by 1925 they had spread over some 25 million acres to form a dense, impenetrable growth. In 1925 a moth, *Cactoblastis cactorum* (Berg.), the larvae of which burrow in the cactus plants, was introduced into Australia from Argentina. As a result of the continuous feeding of these moth larvae the dense cactus growth is now reduced to about 1 percent of the area it occupied in 1925.

Weed-feeding insects are not always beneficial. In some cases the weeds may serve only as an early seasonal food plant for the production of large populations which will later in the season attack and injure cultivated plants or crops. This type of problem is seen in the case of sugar-beet leafhopper. On the other hand, the insect may change its food preference from a wild to a cultivated host. The Colorado potato beetle, for example, originally fed on wild species of *Solanum* and later changed to potato.

The esthetic value of insects.—The brilliant colors and color patterns of insects have been utilized by artists, jewelers, and designers. Some of the butterflies, moths, and beetles have provided basic patterns in many types of art. Because of their larger size their patterns are more often observed, but some of the smaller insects are just as brilliantly colored. For instance a tropical leafhopper, *Agrosoma pulchella* (Guerin), has a brilliant black, white, and red pattern of bars or stripes which is frequently used in Mexican and Central American art. The ecology and abundance of this insect account for its use in color designs there. It occurs in the lower tropical areas on shrubbery and is commonly found along streams where the natives launder their

clothing. When white garments are spread upon the shrubbery to dry, these brilliantly colored leafhoppers hop upon the clothing, where their conspicuous color is emphasized by the white background.

Insects are also used in making jewelry. In some tropical countries the natives make necklaces of "ground pearls," the wax cysts of female scale insects of the genus *Margarodes*. The wings of morpho butterflies, brilliant bluish butterflies occurring in South America, are often mounted under glass and made into trays, pictures, and certain types of jewelry. Showy insects mounted in plastic or under glass are sometimes made into such things as paperweights and book-ends.

During the past few years the department of fine arts at Ohio State University has annually requested certain of these insects with brilliant coloring or exquisite patterns for use in its laboratories, so that students specializing in fine arts might become acquainted with this source of material and might have an opportunity to use some of these designs in their period of training.

The recreational value of insects.—Insects are fascinating animals when one takes the time to observe them or begins to study them carefully. Therefore, many persons find in the study of insects a stimulating hobby and a means of recreation, just as intriguing and beneficial as any other type of nature study. The interest in insect study leads to collecting and field study and to observations of habits and interrelations of insects with insects, insects with plants and with other biologic forms. The collecting, hiking, field activity, and mountain climbing serve as an excellent form of recreation. The scientific and educational values of such collections are also very important phases of the use of insects as a hobby. Some of the finest collections of certain groups of insects that we have in the world today have been formed in this way and are often handed down for several generations. Several of these have been developed in the United States, but this country has fallen far behind the European and Asiatic countries in the practice of collecting insects as a hobby. This practice is found especially in Japan and certain of the central European countries. Scientists from these countries who have visited the United States during the past few years have expressed their astonishment at the lack of interest by the American people and the comparatively few amateur entomologists found in our country.

INSECT LIABILITIES—THE DESTRUCTIVE

The liability side of the ledger is illustrated by the insects which destroy crops, eat through the wood of houses and other buildings, make attacks upon supplies of food in pantries and larders, and pierce the skin of our bodies, thereby injecting deadly disease organisms into the blood. Insects eat, steal, or destroy one-third of everything which man grows and stores for the future. This includes

fields of corn and wheat, orchards of fruits, fields of potatoes, peas, and tomatoes, vineyards, citrus groves, and all other types of crops. Some wood-boring insects attack and fell our forest trees. Others inject disease-producing organisms into certain trees, causing Dutch elm disease, phloem necrosis, or oak wilt, which take their toll of our forest and shade trees. Lumber used in buildings is continuously attacked and destroyed by termites and powder-post beetles.

Insect-borne diseases of man.—The most direct and fatal attacks are by those insects which feed upon the blood of man. The world health authorities, working through the United Nations and gaining knowledge and statistics from all the nations of the world, are authority for the statement that insects are the cause of one-half of all human deaths, sickness, disease, and deformity.

The anopheline mosquitoes alone are responsible for injecting into man's blood stream the protozoans which cause malaria—a scourge which infests one-sixth of the human race and kills somewhere in the world a man or woman every 10 seconds. In like manner the *Aedes* mosquitoes are vectors of organisms causing yellow fever, a much more deadly human disease although not as widely distributed throughout the world.

The *Simulium* or black flies, which occur in certain tropical areas around the world, inject into man's blood the microfilaria roundworms causing blindness (onchocerciasis) in man. Large segments of the native populations are often totally blind.

The tsetse fly is one of the most deadly of the blood-sucking flies, causing the usually fatal sleeping sickness in man. Several million square miles of Africa have been so completely dominated by this insect that man has not been able to inhabit this area. The wild game animals serve as reservoirs for the trypanosomes which are carried to man by these flies.

REASONS FOR THE SUCCESS OF THE INSECT WORLD

What is the character of these rivals which humanity must surely hold in check if it is going to be successful as a species? The following reasons could be cited to explain why the insect type has become so highly evolved, adapted, selected, and so dominant and successful on the surface of the earth:

1. The body is enclosed within an exoskeleton which is composed of chitin. Its essential chemical elements, carbon, hydrogen, and nitrogen, are easily and abundantly available from green plants in the form of nitrogenous sugars. A body covering of this type limits the insects to small size but affords great strength due to direct muscle attachments. It also favors diversified mutation and all types and extremes of protection through form, color, and thickness of the armor. This skeleton is always properly developed, insofar as diet is concerned,

in spite of the fact that usually no parent is present to select the diet and feed the young. In contrast the human infant must be carefully nourished during his early life in order to obtain a proper skeletal structure and a healthy body.

2. Insects are the only winged invertebrates, and this fact, combined with other survival characteristics, has given the insects dominance of the earth which even other winged forms like the birds cannot dispute. With wings, insects can quickly abandon habitats when they become unsuitable. Aquatic insects have winged stages in their life cycles which solve the problem of desiccation, or in many instances they can develop wings in time to avoid death which might be imminent in many habitats. Fish and other aquatic forms usually perish under similar adverse circumstances.

3. The temperature of an insect's body usually follows closely the external temperature to which it is exposed. In order to adjust for seasonal changes the composition of the protoplasm is such that it can function as a hydrophylic colloid, to the extent that it can absorb and bind the free water of the body. Thus by a short period of conditioning, insects in every life stage, depending upon the species, can be subjected to freezing and subfreezing temperatures, and a certain percentage can survive long periods of low temperature. This adaptation to a condition of hibernation is one of the most important survival factors in the world of insects. This is the means by which most insects are fitted into a natural world and thus solve the problems of changing seasons. During the winter their bodies are quiescent and the metabolic rate is extremely low. When food is not available, they are able to survive without it.

Man on the other hand, who maintains a constant body temperature, must have fuel in order to retain a normal temperature during periods of low climatic temperature, as well as warm clothing to protect his body and a good supply of food to maintain a normal high metabolic rate and a continuous supply of internal heat and energy.

4. Metamorphosis in insects is a condition allied in a way to the previous factor. Different biologic stages of activity and inactivity are often selective adaptations to seasonal conditions or feeding habits. The common cattle pest, the horn fly, is a good example of this. The only place that the larvae are able to complete their growth is in fresh cattle droppings. In hot, dry, summer weather these droppings soon desiccate. If and when they do, the maggots die. The selection factor here has produced a short maggot or growing stage of from 2 to 4 days.

Or take the case of a specialized plant-feeding larva which attains great size during its short larval period. As a young apprentice of entomological research working with the United States Department of Agriculture in the tobacco-growing sections of Tennessee in 1915,

I was assigned the task of finding how much leaf tissue a tobacco horn-worm larva would consume between the time it hatched from the egg and the time it became a quiescent pupa. From the data I obtained and from the studies of subsequent workers, we can conservatively say that a single larva (tobacco worm) consumes in 28 days of larval growth, food weighing approximately 50,000 times its birth weight, and the larva increases in size during this period approximately 12,000 times its birth weight. Equally surprising is the case of a silkworm larva which consumes its weight in food each day.

5. To these characteristics should be added the factor in insects of great biotic potential—the power of the insect to reproduce rapidly and establish enormous populations. This potential factor has been stressed by the theoretical estimates of many of our honest and reputable entomologists, who estimate, for instance, that under optimum conditions a single cabbage aphid together with its accumulating descendants could, if enough cabbage were available, produce in a single growing season enough aphids, weighing one milligram each, to form a mass weighing 822 million tons or 5 times the weight of the total human population of the world. While this does not occur, the potential danger is always present in man's world of insects; and here or there, from time to time, where environmental resistance is restrained, the chinch bug, the Japanese beetle, the Mediterranean fruit fly, or some other specific form, will produce populations which get out of hand in spite of man's knowledge and continued efforts to subdue them.

Consider the potential of a common rainbarrel, which has been observed to produce in excess of 100,000 mosquitoes in a single season. Regarding this potential, we should bear in mind that an average of only 1 percent of the previous season's populations survives the period of wintering.

Certain insects, such as the digger wasps, in the absence of food preservation by low temperatures, habitually paralyze their prey by stinging them and then depositing their eggs upon these victims which are used to provision their galleries or burrows. In case these paralyzed insects should die the venom acts as a preservative and they will not decompose for periods of several weeks or even months.

The insect heart is a very unimportant structure in connection with respiration or oxidation. So heart disease, the great killer of humans, could not occur in an insect. In like manner, insects have no lungs, no liver, and no kidneys. The respiratory system composed of a complex network of tracheal tubes is adapted to all types of aquatic life and is tolerant of both air and vacuum pressure and of high altitude flight, and is more tolerant to radiation than vertebrate animals.

Also, consider the fact that in insects the infants, when born, usually take care of themselves; there is seldom parental care. Add to this

the fact that there is no old age in insects. When their work is finished, they die. There is no retirement, no social security, no old-age pensions, and never a feeble grandparent. All these problems have solutions in a world of insects as a part of their adaptation.

ADAPTATIONS

Not only did man find these populations of insects in the world, but he also found extreme adaptations of these species by millions of years of survival selection. The extent to which insects will become adapted is amazing, and often shocking, at least when you use your imagination as to what might happen in the future. These adaptations occur in morphology, all phases of the biological cycle, habits, and physiology. The following are a few examples of these adaptations.

The legs of insects are adapted in various groups for running, swimming, digging, grasping, and holding prey or, in the case of blood-sucking lice, grasping and holding onto the hairs of mammals. In the case of surface-swimming gyrimid beetles, their eyes are divided so that one portion of the eye is above the surface of the water and the other is below.

In many insects which have hypermetamorphosis, the larva when first hatching from the egg may have well-developed legs and be able to seek out an egg mass upon which to feed; but when moulting to a second instar the legs become quite small and inadequate for locomotion. This condition is also seen in the scale insects which have an active first instar crawler stage and then become sessile and lose their legs in the second and succeeding instars.

Many interesting adaptations are seen in egg production. In some insect parasites we have a condition which is known as polyembryony. The female lays a single egg which eventually produces many individuals. In the cannibalistic aphid lion the survival factor is apparently accomplished by the eggs being laid on stalks, and thus brothers and sisters are protected from the first of the brood to hatch. Females of the giant waterbug, genus *Abedus*, glue the eggs to the back of the male, where they remain until hatching.

Certain insects are adapted to extremes of climate. The grylloblattids prefer temperatures of 0° C. and apparently are unable to live at temperatures which are more than a few degrees from this point. They normally occur at the edge of melting glaciers. At the other extreme, certain insects live in hot springs with temperatures of 120° to 124° F.

There are many diversified adaptations in feeding habits and physiology among insects. The clothes-moth larvae feed upon animal fiber (carotin) only and never have available water as such. The water needed by the body is obtained through metabolic processes,

and the water released in the body from this source is conserved by the process of excretion and the production of dry fecal pellets. Stored-grain insects conserve water in a similar way.

Gall insects, belonging to several orders, demonstrate another interesting phase of nutrition and interrelationship. In this case the insect produces a stimulus which is so specific that each individual of a gallmaking species will cause the plant to produce the same type of abnormal growth, inside of which the immature insect feeds, grows, and develops to maturity. Conversely, every different species of gall-maker on the same plant will stimulate the plant to produce its own specific and uniform type of abnormal growth.

One of the most amazing adaptations is found in the ephydrid flies which live in saline, alkaline, or other solutions of extreme degree or variation. Certain of these occur in ocean water, in the Great Salt Lake, in the Bohemian salt mines, in pools of crude oil in California, and some have been found living in medical-school cadavers preserved in strong solutions of formaldehyde.

An interesting survival factor is also displayed in the sexton beetles belonging to the Silphidae. These live in the bodies of exposed dead animals. The eggs are laid and the larvae develop in these carcasses, but the larvae must have soft, moist tissues to complete their growth. In hot dry weather these carcasses will desiccate rapidly, but the species is preserved by the action of adults, which dig the soil from under the carcass and gradually, but rather quickly, bury it.

To the best of our knowledge the caddis-fly larvae were the first organisms to demonstrate the use of nets to capture aquatic micro-organisms. The dragonfly naiads, by the intake and repulsion of water to bathe the gills in the rectal cavity, gave us the first example of jet propulsion; and the paper wasps of the hornet group were the first to make paper from wood pulp.

NATURAL BALANCE

It is impossible to predict what role the insects might have played in the world without the advent of man. There is no question but that they had existed for millions of years and had become well adapted. Our observations, however, of areas of the world uninhabited by man have proved that natural conditions are usually well balanced until man's arrival. The number of insects and their interrelationships, parasites, predators, etc., the diversity of plants, and many other factors keep populations well balanced. When man arrives he cuts down forests, cultivates fields containing many kinds of wild plants, and changes the fields to extensive acres of one kind of plant or crop. This upsets the balance and produces extensive populations of what we term economic insects.

The chinch bug is a good example. The corn belt was originally a grassland with an *Andropogon Climax* vegetation. This was the native food plant of the chinch bug which sucked the juices of the grass and hibernated in the adult stage in the clumps of dead grass at the base. Man decided he could raise the finest corn and wheat here. He plows out the *Andropogon* and plants two crops which he fertilizes and cultivates, causing them to grow rapidly, to be succulent and highly attractive to insects, and these two crops fit perfectly into the two seasonal generations of the chinch bug, spring on wheat, summer on corn; and then he wonders why these enormous populations destroy his crops.

In like manner man changes the course of streams, impounds water, constructs artificial barriers, and in general changes natural conditions, and in so doing he destroys the original balance.

THE STRUGGLE FOR DOMINANCE

When we view man as a competitor in the insect world, attempting to subdue his invertebrate rivals, we must face up to certain facts and considerations. The insect is an animal without intelligence, or at least the ability to think, which has come to its present position of dominance in the world by mutation, selection, and adaptation. As pointed out, it is highly adapted to most conditions in the world.

If there is any doubt concerning its ability to overcome anything adverse which is devised for its destruction, we have only to look upon the chemical developments and history of the past two decades. Man has devised the most deadly chemicals he could find in the chlorinated hydrocarbons and organic phosphates which at first seemed to wipe out completely populations of house flies, roaches, body lice, and most agricultural insects for months at a time. In 5 to 10 years time these chemicals have proved ineffective on the descendants of these same insects.

When D.D.T. was first used, a prominent biologist stated that the house-fly problem was forever solved. In 5 years from that date, we were rearing them in our laboratories in screen cages which were white with coatings of D.D.T. painted on the wire screen. Where does man hope to go in his fight with selective adaptation or tolerance of this type?

Man, on the other hand, is an intelligent animal with the ability to think, and his choice of adaptation has been in this direction. In man we visualize another type of biologic experiment in the world. We see the development of an entirely different type of animal body with a different type of appendage, the hands. With these he makes tools with which to make gadgets and devices for obtaining materials and directing the forces of the earth, thus converting or changing the

natural world around him. At the moment his greatest efforts seem to be in the direction of producing mechanisms of all kinds, including missiles, bombs, and devices for the exploration of outer space.

His intelligence drives him to an expanding horizon of activity so that he vigorously competes with other men and other races in order to control greater resources and materials in the world and command greater areas of influence. This leads to cold and other types of war, and to the potential destruction of man and his valuable possessions and international relationships.

Could it be possible that man has not been here long enough to be properly established, since only about half a million years have elapsed from *Pithecanthropus* to present-day man, and modern man has been here a comparatively short time? At the present moment in world affairs a sudden misunderstanding or misstep might, in view of the world's present stockpile of bombs, eliminate man from large areas of the world in a single stroke. The insect populations under similar conditions would have a much greater chance of survival.

If this does not happen, what will be the fate of man in the next million years, attempting to live in a world full of established insects? The laws of evolution should work to improve the human race, but will this happen or can it happen in the world as we know it? In order to meditate upon this thought it is necessary to recall that man is dual in nature. He must conform to his animal nature in order to meet his physical requirements, but he wishes at the same time to be a spiritual creature in order to survive the physical world. He thus becomes involved in religious theories and doctrines, and he becomes confused and perplexed by biological laws, theories, and concepts. How far will religious prejudice, archaic concepts, and ecclesiastical dictatorship deter man from a sane pattern or philosophy of biological existence? Can intelligence direct the religious to augment the biological? If so, when may we expect it?

The biologist in his rational moments studies the laws of genetics as they apply to insects. He experiments with these in order to obtain and study certain gene combinations and marvels at what has happened in their evolution and adaptation. He applies the principles he discovers for the improvement of farm crops and farm and domestic animals, but he has not applied these basic biologic laws when he considers the human species and the possible and certain improvement of the peoples of the world. In the present world, he dares not.

Man, then, has not competed and cannot compete with the insect upon the same plane. It is a case of man's intelligence against biological adaption, and repeatedly intelligence has lost skirmish after skirmish.

We could reflect that nothing in the whole range of biological and paleontological study shows anything to equal the insect in its persistence and its potential complement of characteristics, which would seem to assure its continued progress even if the experiment of the human species would prove eventually to be unsuccessful. We are reasonably certain from the past and present that the insect will persist and probably increase its position of dominance in the world. Can we predict the same for man? Will it be possible for man to become humane with man in time to solve the problems which face him? Will his intelligence lead to adaptive survival or destruction?

Can intelligence solve such problems as the rapidly increasing populations of the world with its many and diversified facets, the depletion of farm lands, the decreasing supplies of natural resources, the destruction of the wild populations of pollinating insects and the natural enemies of insects, the failure and diminution of more and more of our promising insecticides, the increasing ravaging of crops, and the increasing spread by modern travel of insect-borne diseases of man? Can intelligence cope with and solve the international political situation, especially when this is linked with increasing stockpiles of bigger and more deadly bombs and missiles for human destruction? If it cannot, the insect may eventually win and eliminate man from its world, and Dr. W. J. Holland's prophecy that—". . . the last living thing on the globe will be some active insect sitting on a dead lichen which will represent the last of the life of the plants" may be fulfilled.

Tropical Fruit-Fly Menace

By L. D. CHRISTENSON

Entomology Research Division, U.S. Department of Agriculture

[With 6 plates]

Insects occur in almost endless variety. More species exist—some 800,000 have been described—than all other kinds of animals put together.

Insects can breed so rapidly that they would soon overrun the earth if uninhibited. They are among the strongest of man's competitors for food for his table, for animal and plant fibers to make his clothes, for lumber to build his shelters, for flowers that grace his table, sometimes even for the game he seeks in field and forest. Diseases spread by insects kill or make seriously ill millions of people each year.

Our six-legged rivals consume vast quantities of food so desperately needed by hungry people in many parts of the world. Some years ago Dr. L. O. Howard, eminent pioneer in the science of entomology, stated: "There is a third way of assisting in the feeding of the world aside from birth-control or the stimulation of plant food or the invention of new food, and that is the stopping of waste. Probably the greatest of these wastes is the tremendous but unnecessary tribute that we pay to insects." Despite important advances in insect control in the years since Dr. Howard arrived at these conclusions, there is still truth in them today. If we did nothing about insects, our agriculture would revert to an uncertain gamble because of frequent insect plagues. In modern times insects cause damage to crops, livestock, forests, fabrics, houses and other buildings amounting to nearly \$4 billion each year in the United States alone.

Among the most noxious, and at the same time most interesting, insect families are the so-called tropical fruit flies, family Tephritidae. This is a large family comprising some 4,000 species distributed throughout the world. The wings and bodies of many are beautifully adorned with yellow, brown, or black markings. Some fruit flies attack the ovaries and seeds of plants; others lay their eggs in fruits and vegetables. Most are strong fliers. The Mexican fruit fly (*Anas-*

trephe ludens (Loew)), after following air currents across deserts for more than 100 miles each year, invades the lower Rio Grande Valley of Texas, where it causes an annoying quarantine problem. The oriental and other fruit flies may fly from one Pacific island to another, sometimes across 35 miles or more of open sea.

The losses caused by tropical fruit-fly larvae as they feed and live in the fruits of host plants accord these flies high rank among the world's foremost plant pests. Well known is the Mediterranean fruit fly (*Ceratitidis capitata* (Weidemann)), which has invaded our country three times within the span of the last four decades. Eradication in 1929-30 cost about \$7½ million plus many million pounds of citrus that was destroyed to eliminate breeding. In 1956-57 this fly's elimination cost nearly \$11 million. In 1962 early detection with strong lures developed by research reduced the cost of another eradication campaign, which appears to have been successful, to less than \$2 million. The olive fruit fly (*Dacus oleae* (Gmelin)) takes a toll of nearly a third of all olives produced on countless trees in the Mediterranean area each year. When we consider that olives and olive oil comprise a substantial part of the caloric intake of people living there, and that Greece alone has an estimated 75 million olive trees, this loss is indeed appalling. In every continent—Africa, Asia, Australia, Europe, North America, and South America—tropical fruit flies are obstacles to efficient fruit and vegetable production.

What to do about tropical fruit flies and how to detect invasion by them are problems that have received serious attention by research scientists and farmers for a long time. Probably one of the earliest control measures was the use of fermenting juices or wine in bottle traps, which attracted some of the flies. After entering the traps, they fell into the liquid and were drowned. Such lures were never very successful, even though trap designs and formulations were gradually improved.

In another early control procedure, materials that the flies like to eat were mixed with poisons. The first of these poisoned baits were developed in Italy and South Africa. The bait materials were usually sweet substances such as brown sugar or molasses, or fermenting wheat bran. The most effective toxicants for use with them were arsenicals or other inorganic compounds. Unfortunately, mixtures such as these were often harmful to foliage or left excessive residues on the ripening fruit. Sometimes they were applied to cut sprigs of foliage from other trees, or on tied-up bunches of weeds of broomstraw, which, after treatment, were suspended in the canopies or host trees to be protected. This poisoned-bait method, known as the Berlese method after the Italian scientist who first used it in olive orchards in an attempt to control the olive fly, was also only partially successful.

Sanitation measures, including the picking up and destruction of infested fruits and vegetables and the bagging of individual fruits to prevent infestation, also produced some benefits.

Man's attention soon turned toward parasites and predators in the hope that these might reduce tropical fruit-fly infestations to a tolerable level. Repeated worldwide searches for natural control agents in areas where tropical fruit flies are indigenous revealed many promising species. When these were introduced into areas with unusually serious tropical fruit-fly problems, some became established, but none has reduced infestation to a level where it would no longer be of some concern to those who grow highly susceptible fruits and vegetables for profit. Yet the benefits from partial control by these natural control agents have more than justified the expense of parasite explorations and research. A cooperative biological-control program against the oriental fruit fly (*Dacus dorsalis* Hendel) in Hawaii, in which Federal, State, and private research agencies participated, has been a noteworthy example.

At the conclusion of World War II the oriental fruit fly was accidentally introduced into Hawaii—how, no one knows exactly. Entomologists searched throughout the tropical and subtropical world for effective parasites. About 60 species were sent to Hawaii, where they were studied under quarantine conditions to make certain that no secondary parasites—these are parasites of parasites—would be introduced. Several dozens of the introduced parasites were released, and a dozen or so became established. Some of the new natural control agents were immediately successful, but too often this control was only fleeting. Only one parasite, *Opius oophilus* Fullaway, a species that attacks both the eggs and young larvae of the oriental fruit fly, has been able to maintain significant sustained effectiveness. Before *O. oophilus* was introduced, nearly all fruits of preferred hosts of the oriental fruit fly in Hawaii were infested. The new parasite reduced this infestation by at least half, and the number of fruit-fly maggots in individual infested fruits was much less. The result was the saving of large quantities of fruits and vegetables growing in backyard gardens and on farms. With fewer adult fruit flies near transportation centers where they might enter airplanes or ships, there was much less opportunity for these flies to be transported to lush breeding grounds in citrus orchards in continental United States. This was an important quarantine benefit.

Fruit growers in continental United States, and most of the people who purchase fruits and vegetables in supermarkets, would not countenance the amount of infestation the introduced parasites still permit in Hawaii. Nevertheless, we are grateful for the good they have done. There is still hope that someday a completely adequate biological-control complex can be attained. Our growing knowledge of

insect diseases and their use in supplementing the work of parasites and predators may speed us along the road toward this goal.

Entomologists sometimes do strange things. Not so long ago, in a woodlot near Florence, S.C., at a time near midnight, on seats arranged as though in a theater, several scientists watched the responses of male tobacco hornworm moths (*Protoparce sexta* (Johannson)) to virgin female moths confined in small cages suspended at intervals throughout a much larger cage. From time to time, one or more of the male moths in the large cage would become agitated and then fly about one of the small cages containing a virgin female moth. This was evidence that a sex attractant had been produced by the female moth. The particular female inciting the male response was quickly removed, the tip of its abdomen containing the recently secreted sex attractant clipped off with scissors and the abdomen tip then placed in a preservative. Chemists are analyzing the attractant in the hope they will be able to determine its chemical formula and to synthesize it for use in programs to eradicate or control the hornworm in tobacco or tomato fields. We need to discover all possible attractants for insects, for they provide means of early detection of invasion by new pests, methods for measuring the effectiveness of programs to eradicate incipient infestation, and they may have usefulness as direct control agents.

Thus far, all efforts to find strong chemical sex attractants in tropical fruit fly females have failed, and there are reasons for believing that the two sexes are brought together by fruit or vegetable odors rather than by chemicals secreted by the female flies. A short-range sex attractant, sounds emitted by the flies, or other unknown stimuli may then induce mating. Despite the apparent absence of strong natural sex attractants, tropical fruit flies are nonetheless among the most responsive of all insects to chemicals. Certain complex mixtures such as protein hydrolysates, fermenting liquids, and botanical extracts are known to attract both males and females. Numerous compounds are attractive to males only. Why there should be so many more male than female lures and why the response of the males to certain compounds should be so much more compelling than the response of females can only be speculated upon.

Strongest of all tropical fruit-fly lures is methyl eugenol, which attracts male oriental fruit flies and is eagerly consumed by them. First discovered in India more than 50 years ago, its potential usefulness was not realized until many years later when L. F. Steiner, U.S. Department of Agriculture scientist, mixed this lure with a poison and then impregnated the mixture on cane-fiberboard squares. When the squares were exposed in fruit-fly areas in Hawaii, results were spectacular. Fly abundance quickly declined to such an extent that the feasibility of eradication with this technique was suggested.

In a large-scale test of this male annihilation method on an isolated group of islands in the Western Pacific, conducted by the U.S. Department of Agriculture, with the U.S. Navy distributing the poisoned lure on small pieces of cane fiberboard from a flying boat, and the Trust Territory of the Pacific Islands furnishing laboratory facilities on Guam, near extinction of the oriental fruit fly was achieved. Interruptions in treatment schedules probably prevented eradication. Even though the fly was not eliminated, suppression of the population density to only about 30 flies or so per 1,000 trap days at one point in the experiment, in contrast to the many thousands of flies caught before treatments were started, was a noteworthy accomplishment. The results provided assurance that use of frequent traps baited with methyl eugenol in southern California, where three oriental fruit flies were found a few years ago, was a sound procedure. It is unlikely that any infestation present would have been able to expand or develop.

Although no specific compound comparable in effectiveness to methyl eugenol has been found for the Mexican fruit fly, which causes quarantine and control problems along our border with Mexico each year, the best attractants found for this fruit fly are fermenting or protein hydrolysate liquid mixtures, to which both sexes respond. Although thus far only moderately effective, these lures have had significant usefulness by providing effective detection systems in regulatory and eradication programs. Whether they will eventually prove to be strong enough to have direct control usefulness remains to be determined.

Now let us turn for a moment to insecticides for tropical fruit-fly control. There are individuals who take every opportunity to condemn insecticides, but without them, production of adequate supplies of food would be difficult in our country. Insecticides must satisfy stringent safety requirements before they can be registered for sale. Harmful amounts on or in foods are not tolerated, and any material that is even remotely suspected of being able to cause cancer or other diseases, on the basis of acceptable evidence, is quickly banned. Probably nowhere in the world today is there a more healthful and abundant variety of food than that present in our markets.

Entomologists hope that someday it will be possible to grow plants and livestock without insecticides, not because they consider insecticides to be a hazard to public health when used properly, but because pests frequently develop resistance to such treatments, the work of beneficial parasites and predators may be interfered with, and residue and application problems are associated with their usage. The development of less objectionable insecticide treatments and nonchemical methods for insect control has occupied high priority in the research on tropical fruit flies for many years.

A significant step forward was the discovery, again by L. F. Steiner in Hawaii, that deposits from a bait spray containing protein hydrolysates and a mild phosphatic toxin such as malathion attract tropical fruit flies and are consumed avidly by them, with ensuing fatal stomach-poison action. Only small amounts of actual toxicant per acre are needed for control. The knowledge that protein hydrolysates contain elements essential to the development of sexual maturity and fecundity of fruit flies was the discovery of Dr. Kenneth S. Hagen, a University of California Agricultural Experiment Station scientist. Amazingly successful, this new protein hydrolysate bait spray has been used to eradicate one extensive Mediterranean fruit fly infestation and appears to have eliminated another in Florida. A similar bait spray is being used to prevent establishment of the Mexican fruit fly in southern California. Research conducted by J. G. Shaw, another U.S. Department of Agriculture scientist working in Mexico, proved the bait spray to be effective against this fruit fly. The same bait spray, sometimes modified, is now known to be effective against a number of tropical and temperate-zone fruit flies in other parts of the world.

Few could have guessed years ago that knowledge of the nutritional requirements of tropical fruit flies obtained by Dr. Hagen would lead to a safe control method that could be applied by air over cities and towns as well as on crops.

If 10 pairs of normal insects are placed in a cage and 100 males that have been sterilized by exposure to gamma radiation from a cobalt ⁶⁰ source are then added, there will be a strong decrease in the fertility of eggs laid by the normal females. If sterile males continue to be added at the same high, overflowing ratio at frequent intervals, fewer and fewer normal females may be produced in each subsequent generation. Soon the entire population may be extinguished. This exciting noninsecticidal method of insect control was conceived by E. F. Knipling, director of U.S. Department of Agriculture's Entomology Research Division, and first successfully used on the screw-worm fly (*Callitroga hominivorax* (Coquerel)), a serious pest infesting wounds of cattle.¹ The method requires the rearing and sterilization of large numbers of insects and their later distribution throughout the area inhabited by the pest. The new technique has eradicated the screw-worm fly throughout Florida and other Southeastern States with savings to the cattle industry of about \$20 million each year. The fly-rearing and sterilization factory used in this first large-scale operation of the sterilization principle cost about \$1 million and had a capacity of 50 million sterile flies per week. The fleet of

¹ See article entitled "Screwworm Eradication: Concepts and Research Leading to the Sterile-Male Method," by E. F. Knipling, in the Annual Report of the Smithsonian Institution for 1958, pp. 409-418.



Mediterranean fruit fly, a persistent threat to our subtropical agriculture which has been eliminated from Florida on two occasions. A campaign to eradicate a third accidental infestation appears to have been successful. (Photo by L. D. Christenson.)



Opius oophilus, oriental fruit-fly parasite extraordinary. Introduced into Hawaii from southeast Asia, this parasite reduced infestation in fruits and vegetables by more than half and lessened the risk of fly hitchhikers reaching mainland citrus areas. (Photo by L. D. Christenson.)

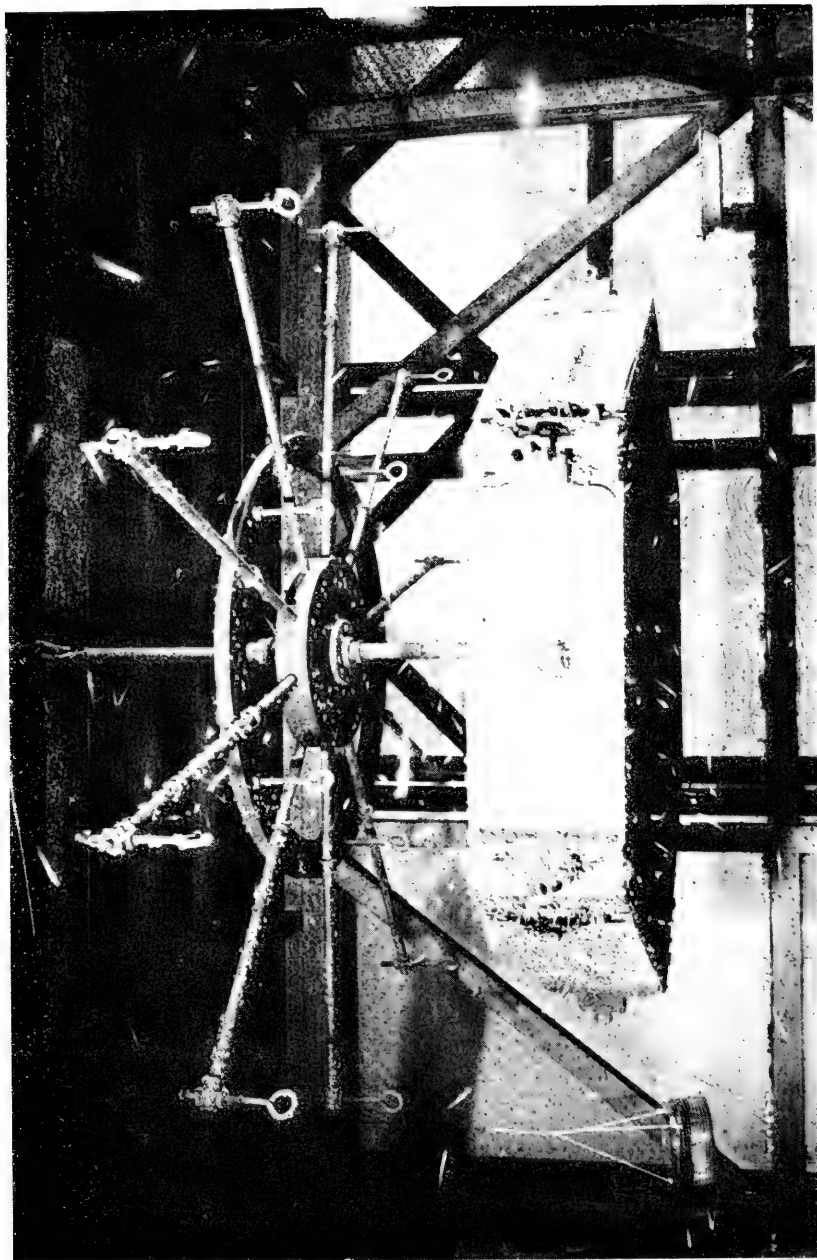

Candidate fruit-fly attractants are screened in a large cage containing many millions of flies. Materials may be placed in glass traps, or applied to an absorbent surface on a slowly revolving wheel, as in the photograph. (Photo by R. Wenkam, Honolulu.)



Large quantities of experimental fruit flies are needed for tests of the radiation sterilization method. These cages at the Honolulu fruit-fly laboratory contain adult flies which supply large quantities of eggs. (Photo by R. Wenkam, Honolulu.)



Oriental fruit flies ovipositing through pinholes made in ice-cream cartons inserted inside stock cages at Honolulu fruit-fly laboratory. (Photo by R. Wenkam, Honolulu.)



Dehydrated carrot medium in which fruit-fly larvae are reared, an invention of University of California scientists and later modified by U.S. Department of Agriculture entomologists, is mixed with water and nutrients in a large hopper and then poured in trays. The fruit-fly eggs are added to the surface of the carrot medium. (Photo by R. Wenkam, Honolulu.)



Preparing the fresh carrot larval medium required by the Mexican fruit fly. (Photo courtesy Rockefeller Foundation, Mexico City.)

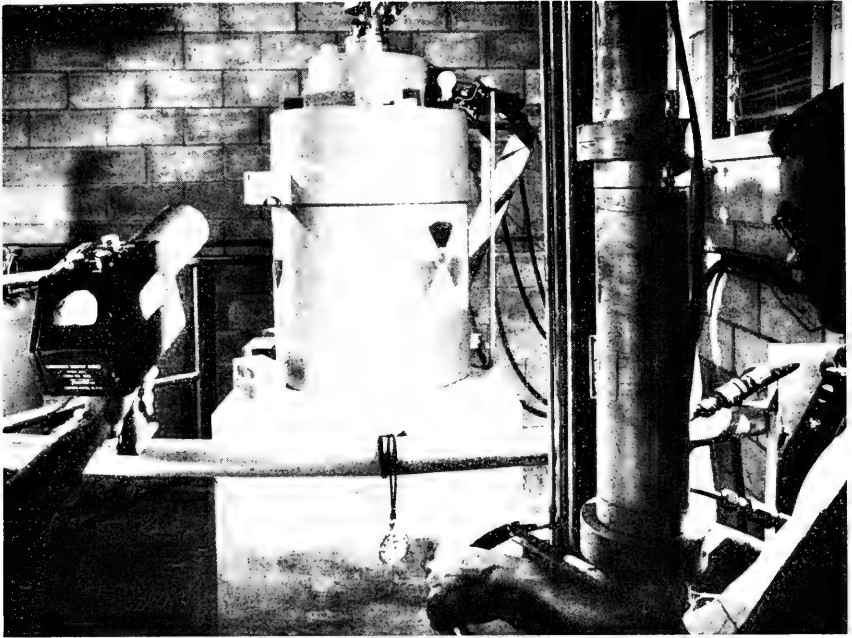

Fruit-fly pupae are exposed to gamma radiation inside the sealed lead cask. Adults emerging from treated pupae are sterile. (Photo by R. Wenkam, Honolulu.)



In fruit-fly radiation sterilization experiments, sterile fly pupae are placed in small aerated boxes with honey water for food. After all flies have emerged a few days later, the boxes are distributed over the experimental area with an airplane. (Official photograph, U.S. Navy.)

airplanes distributing the sterile insects flew several million miles. An even larger screw-worm fly factory has been constructed in Texas. There is hope that this fly can be eliminated from all of the United States and eventually even from the entire North American Continent.

Soon after the concept of radiation sterilization to control insects received publicity a decade or so ago, work to determine its possible application to tropical fruit-fly problems was initiated in Hawaii by the writer and L. F. Steiner. At first it was believed that single-mating habits were a prerequisite for successful application of the method. Tropical fruit flies mate more than once. The first cage experiments with the oriental fruit fly revealed a strong effect on fertility of eggs when normal flies were overflooded with sterile individuals. Pilot tests on the Mediterranean fruit fly in Hawaii and the Mexican fruit fly in Mexico, the latter tests conducted by R. H. Rhode, soon demonstrated that overflooding of semi-isolated tropical fruit-fly populations with sterile flies will inhibit population growth. In an isolated-island oriental fruit fly test on Rota in the Western Pacific about 40 miles north of Guam, sterile flies in small boxes were dropped from a U.S. Navy flying boat, and others were allowed to emerge in special emergence trays suspended from trees. Despite sustained releases, sometimes as many as 10 million sterile flies per week, the desired amount of overflooding of the oriental fruit fly population could not be achieved because of the abundance of wild hosts, the strong reproductive potential of the fruit flies, losses during distribution, the effects of predation after release, and natural mortality before the flies attained ability to mate. A definite seasonal upturn in infestation in preferred hosts in the spring and early summer of 1962 was the final signal for termination of the experiment.

The results of the radiation sterilization test on Rota, the first large-scale test of its kind on an insect that breeds copiously on abundant wild hosts, did not prove that this technique will not work. The test taught us that for some tropical fruit flies it may be necessary to reduce wild populations by other means so as to bring them within reach of the sterile-fly release method. A new experiment on the melon fly is now in progress on Rota, where insecticides are being used to reduce the wild flies to low numbers before the sterile flies are introduced.

Other research on the radiation sterilization of tropical fruit flies is underway in Central America, Egypt, and Greece. Within a few years we should have a good answer to the question of whether this technique is effective against these insects. A method such as this, which can eliminate an insect species from large areas, or even from entire continents, needs to succeed only occasionally, as with the screw-worm fly, to merit recognition as one of man's greatest accomplishments.

Tropical fruit flies can also be sterilized with chemicals, but materials so far available are not safe enough to apply to fruit-fly environments in nature. Chemosterilants should soon achieve eradication if enough of the wild tropical fruit flies could be rendered sterile during a sustained period.

What will the future bring in our war on tropical fruit flies? We will still need to study insecticides and bait sprays, improve formulations, and make further progress in the direction of safety and problem-free application. Insecticides mixed with baits provide at present our only known means of abating fruit-fly emergencies. Highly coveted are completely effective nonchemical methods for control or eradication. Such methods may come sooner than we think, but no matter what we do about tropical fruit flies, the odds are that they will remain a worthy challenge for many years to come.

The Soil as a Habitat for Life¹

By Sir JOHN RUSSELL

*Late Director of the Rothamsted Experiment Station
Vice President of the British Royal Agricultural Society*

[With 5 plates]

The dark and seemingly inert structure of a lump of soil would not at first sight seem to constitute a likely habitat for life. Even in the 1880's and 1890's, when bacteria were found as regular inhabitants playing an important part in the nutrition of plants, nothing larger was supposed capable of existence in the soil. Later investigations at Rothamsted, however, showed that active protozoa were present as well as bacteria, and in 1919 a team was set up there to study these and other organisms also found—algae, fungi, and small invertebrates—not simply as individual groups, but as a mutually interdependent population.² Lack of resources brought the scheme to an end, but work on individual groups continued, and has recently been greatly extended, especially on the small invertebrates.

ORGANISMS IN THE SOIL

As usual, every advance shows that the field is much wider than had been expected. The old estimates of the numbers of active bacteria in farm soil at Rothamsted ranged from about 3 to 10 million per gram; modern estimates are 3,000 million or more. It is difficult to visualize either the size or the numbers of bacteria in the soil. One of the best illustrations I know of the size of bacteria was given by S. G. Paine when he estimated that a quarter of a million of average size could sit on the period at the end of this sentence. Estimates of their weight per acre to a depth of 6 inches have ranged between 1,500 and 3,000 pounds at Rothamsted, and up to 4 tons on a Swiss grass field—which is considerably greater than that of the animals grazing on it. The numbers and variety of the soil animals

¹ Reprinted by permission, with some substitution of illustrations, from *Discovery* for December 1961.

² Russell, E. John (ed.), *Microorganisms in the soil*. Longmans, 1923.

are also much greater than suspected. The smallest are usually the most numerous: the protozoa, nematodes, and arthropods, roughly in that order.

They are also the most active, consuming more food and more oxygen per unit of bodyweight than the larger ones. The protozoa vary greatly in size, and weight is a better standard of comparison: in Stöckli's experiments and at Rothamsted their weight was 3.4 percent of that of the bacteria. The nematodes range from about 4 to 17 million per square yard, mostly in the top 4 inches of soil. The majority are free living, but some are parasitic on plants: these have been the most fully studied.

The chief arthropods are the mites and springtails. The mites range considerably in size: between 12,500 to 100,000 of them could be packed into a drop of water. Salt found about 100,000 per square yard in the top 6 inches of grassland, and about 40,000 in the second

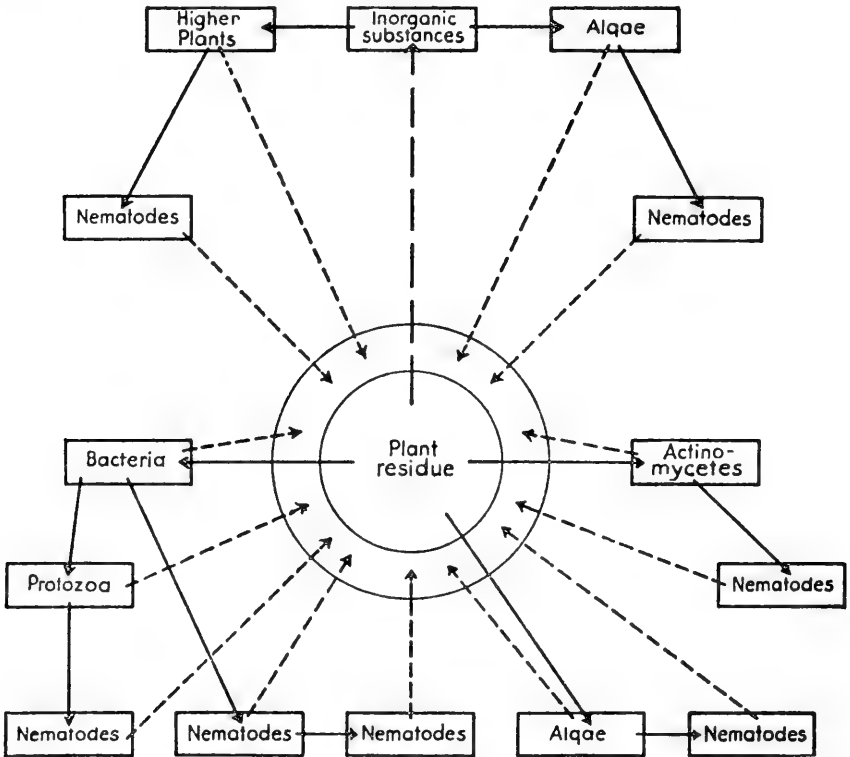

FIGURE 1.—The food cycle of free-living nematodes. The inner circle represents the part of the soil organic matter derived from plant residues; the surrounding ring indicates the contribution made by the dead bodies of soil population. Solid line means "enter into"; light broken line, "turn into when dead"; heavy broken line indicates that several stages are involved. (C. Overgaard Nielsen.)

6 inches. The total number of arthropods per square yard to a depth of 12 inches was about 220,000, some 70 percent being in the top 6 inches. The springtails are less numerous than the mites but are of particular interest because of their antiquity. They are wingless and appear to be survivors of the days before insects developed wings—a primeval race left stranded in the march of evolution. A fossil insect closely resembling a present-day springtail has been found in the Lower Devonian rocks in Scotland going back some 300 million years, and 40 or 50 million years before the first winged insects appeared in Upper Carboniferous times. Some species dwell near the surface of the soil and are usually brightly colored; others live several inches lower down and are colorless, without eyes, and very sluggish in their movements; the Protura are also low-level dwellers.

But the soil population comprises many other kinds of animals, such as enchytraeids, earthworms, myriapods, larvae, etc. Kühnelt in his recent book³ lists some 700 species in all, but there are certainly more: as methods improve the list is extended. A. Macfadyen puts the number at up to 1,000.

STRUCTURE AND PROPERTIES OF SOIL

In order that these varied organisms can live in the soil, these conditions must be satisfied: they must have living space, air, water, food, suitable temperature, and sufficient freedom from harmful factors to live long enough to reproduce themselves in numbers adequate for race survival. Two important properties of the soil make this possible: its content of organic matter and its peculiar structure. The organic matter is derived from the remains of plants that grew on the soil and died there; they were drawn into the soil by worms and other animals and served as food and energy suppliers for the soil population—the energy being ultimately derived from sunlight by photosynthesis; F. Raw has studied this in detail. The quantity and nature of the organic matter determine the size and character of the soil population; nonacid soils of deciduous forest carry the largest and most varied populations grassland soils may be lower in the scale and arable soils lower still.

The unique structure of soil results from the properties of its constituents. Most of it—often 90 to 97 percent of dry soil—consists of mineral particles derived by weathering or disintegration from the parent rocks. Those between 2 mm. and 0.02 mm. in equivalent diameter, usually chemically inert and unchangeable, are called sand and constitute the framework of the soil. Those lying between 0.02 and

³ Kühnelt, E. W., *Soil biology with special reference to the animal kingdom*. Faber and Faber, 1961.

0.002 mm. diameter, the silt, are mainly inert and somewhat indeterminate in character. The particles below 0.002 mm. diameter are, however, in the main strikingly different from the larger ones. Their parent material was decomposed by weathering agencies and the resulting products, collectively called clay, are chemically reactive, and their small size gives them a very large surface area/weight ratio compared with larger particles. The clay is colloidal and is a powerful absorber of water. A light sandy soil may contain only about 3 to 5 percent and a good, easily workable loam about 7 to 15 percent, but a heavy clay may contain 30 to 60 percent, even occasionally 70 percent. At these high values the soil becomes almost unworkable. Calcium carbonate varies more in amount than any other soil constituent and is especially important, as it is slowly leached out till finally the soil becomes acid and its character as a habitat changes completely. The population alters and becomes less diversified.

The mineral and organic components of the soil become thoroughly intermingled through the activities of the larger soil animals, particularly the various kinds of worms which eat their way through the soil: in particular the clay and organic matter becomes so closely united that no mechanical separation is possible. The particles do not normally remain separate but are built up into fairly stable crumbs which may be 2 or 3 mm. in diameter, honeycombed with cells and passages. It is not known how this is achieved—clay, organic matter, plant roots, earthworms, and other soil organisms are all involved; but it is one of nature's most vitally important processes, for without crumb formation little plant growth would be possible and indeed most soils would long ago have been blown or washed away. Farmers and gardeners have learned empirically how to assist crumb formation, but they have not discovered how it comes about. More investigation is greatly needed: soil erosion is one of the world's most serious problems.

The soil particles are irregular in shape and do not fit compactly: empty passages and pores remain as they do between soil crumbs. In addition passages are left as roots decay or as soil animals force their way through the soil, and cracks form as the clay shrinks. In an ordinary farm or garden soil the empty spaces are so numerous that in spite of their small size they add up to an almost unbelievably large volume; at Rothamsted about half of what looks like a solid lump of Rothamsted's clay soil is really empty space. R. J. B. Williams and G. W. Cooke found that many of the pores range in size from about 200 to 400 microns, but in the Woburn sandy soil, much poorer in clay and organic matter, they are mostly below 200 microns in equivalent diameter, and the total pore space is only about a third of the volume of the soil.

SOIL WATER SUPPLY

Pore spaces become more or less filled with water after heavy rain. Much of it drains away under the action of gravity when the rain ceases, but surface forces which are far more powerful than gravity retain a considerable quantity depending on the sizes of the pores: only those above 30 microns equivalent diameter lose water by drainage. After drainage ceases water may still occupy two-thirds or more of the pore space—roughly equivalent to some 30 to 40 percent of the total volume of the soil. It coats the walls of the spaces with a thin layer which allows the development on them of bacterial and fungal colonies, and is deep enough to allow bacteria, protozoa, nematodes, and rotifers to move about in it. Plant roots can suck out much of this water: those of our common plants can exert pulls of about 10 atmospheres or 300 feet of water. But some water still remains; R. K. Schofield has shown that the last of it requires for its removal a suction of the order of 10,000 atmospheres—equal to a column of water 60 miles high.

GASES IN THE SOIL

Air occupies the soil pore space not taken up by water. Measurements in progress by J. C. Hawkins indicate that under a mature potato crop the oxygen consumption may be of the order of 6 to 13 liters per square meter per day, of which the soil population took between a third and three-quarters, the lower amount on a sandy soil and the higher on a fen soil. Air diffuses so rapidly into and out of normal soil that quantities of this order are readily supplied; the air 6 inches down in the soil of a Rothamsted wheatfield differs little in oxygen content from the atmosphere, though it contains somewhat more carbon dioxide. There were greater differences on the grassland, but apparently insufficient to affect the soil organisms; these are more numerous than on arable land.

HAZARDS TO THE SOIL POPULATION

These are many and drastic. The acidity consequent on the absence of calcium carbonate profoundly alters the soil population, cutting out many members and favoring others. Earthworms disappear, but whether owing to the acid or to lack of calcium is not clear. Severe drought is harmful, but its effect is negligible deep in the soil; bacteria and protozoa can escape by passing into a resting condition.

The greatest hazard to the soil population appears to be the widespread predacity of its members and the constant and varied warfare that prevails. The larger prey upon the smaller: protozoa, certain nematodes, mites, and springtails all prey upon the bacteria, while the protozoa and nematodes are consumed by mites, which in turn are consumed by other arthropods—and so the tale goes on. The predacity

is not always indiscriminate. B. N. Singh at Rothamsted has shown that the soil protozoa are very selective in the bacteria they feed upon, taking some species readily and refusing other. Fungi also comes into the struggle: some are taken by predators, some are themselves predatory, capturing nematodes either by hyphal nooses or sticky networks, or producing sticky spores which are picked up by the nematodes. The victim's body is then penetrated by an outgrowth from the fungus, and its proliferations absorb the body contents (see pl. 5). C. L. Duddington has made interesting studies of these groups. There is also vigorous chemical warfare: some of the fungi eliminate competitors by discharging poisonous antibiotics. These have been studied by S. D. Garrett and F. W. Brian; it is not known how they affect the soil fauna. Some of these enchytraeids, according to Jegen, poison the nematodes on which they feed and then consume the decomposing mass. Some plants excrete from their roots poisons to kill parasitic fungi, others, curiously enough, excrete stimulants that arouse destructive pests from dormancy; potatoes thus become infested with wart disease and parasitic nematodes.

There are numerous cases of external parasitism and of phoresis (transport of smaller animals by hosts), and internal parasites occur in the larger animals, such as earthworms, but there is no record of their occurrence in the small animals, so Dr. Macfadyen tells me. This seems extraordinary: is it possible that they are there, but too small to be seen with an optical microscope? Soils contain such entities, the phages. They attack and dissolve bacteria and actinomycetes, but very selectively, each group attacking only certain strains of one group of their victims. They are far smaller than bacteria, about 0.01 to 0.1 microns in diameter, and can be seen only by an electron microscope. They are a class of virus, and are able to reproduce themselves although they consist only of DNA enclosed in a protein coat. They are studied by J. Kleczkowska at Rothamsted Experimental Station.

Bacteria appear to have the most enemies but are saved from extermination by their colossal power of reproduction and their small size, which presumably enables them to find refuge in the minute recesses of the soil. This is fortunate because they are very efficient scavengers and can produce and secrete enzymes which will decompose many harmful organic substances; they also oxidize the poisonous ammonia contained in the secretions of predators that feed on organisms rich in nitrogen, such as bacteria, which may contain 3 to 15 percent. This scavenging action of bacteria is assuming increasing importance now that farmers are using increasing quantities of organic poisons to control weeds, pests, and plant and animal diseases; these poisons get into the soil and if they accumulated might do seri-

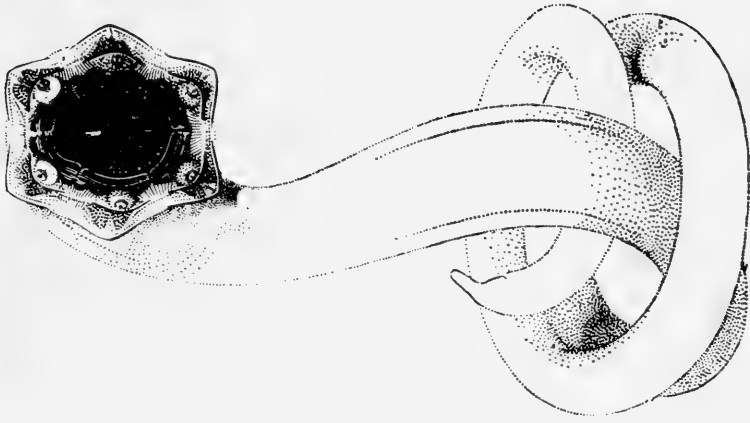

2. *A. predaceous* nematode (a monoch) poised to strike its prey. (After Cobb, 1917, Soil Science.)

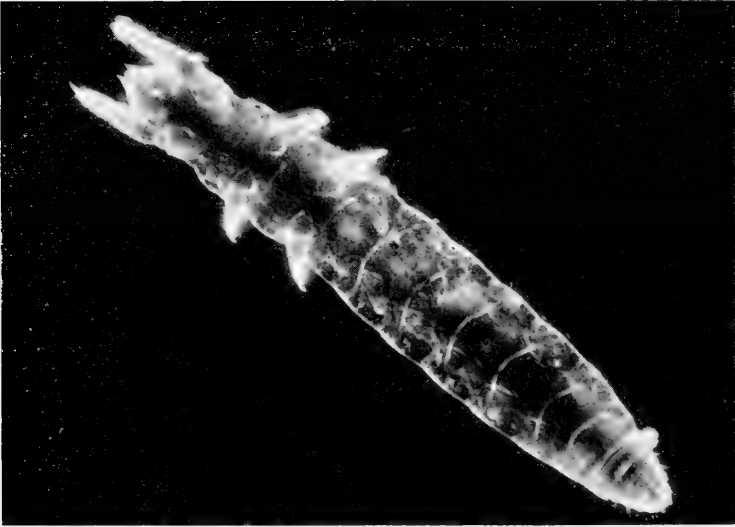

1. *A. Protura*, one of the most primitive organisms found in the soil. (Photo, P. W. Murphy and H. F. Woodward.)

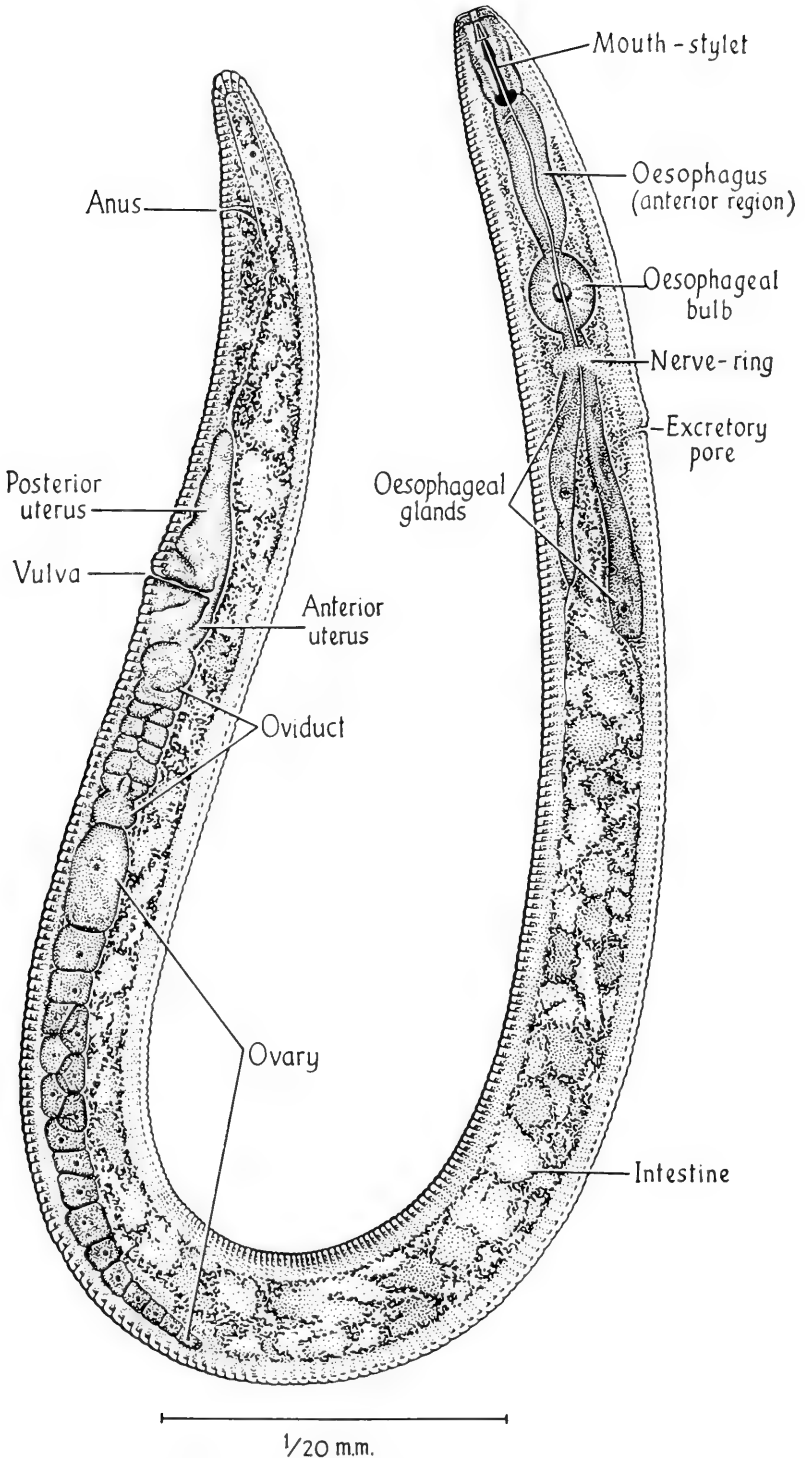

Meadow nematode: free-living (*Pratylenchus pratensis*). (Drawing by C. G. Doncaster.)



1. *Pseudotrifia ardua* (Koch), a medium-sized oribatid mite. Up to 100,000 mites may be found in the top 6 inches of a square yard of soil and some 40,000 in the second 6 inches. (Photo, P. W. Murphy and H. F. Woodward.)

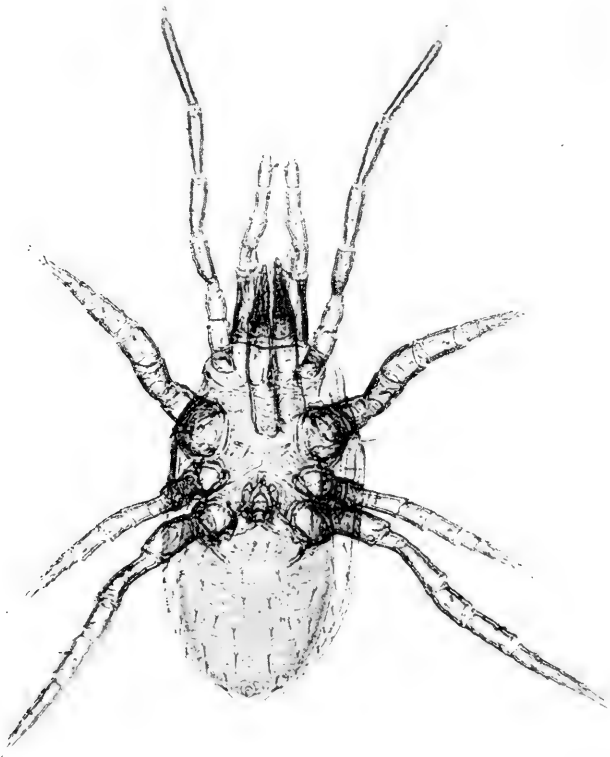

2. *Pergamasus runcatellus* Berl., a large oribatid mite. (Photo, P. W. Murphy and H. F. Woodward.)

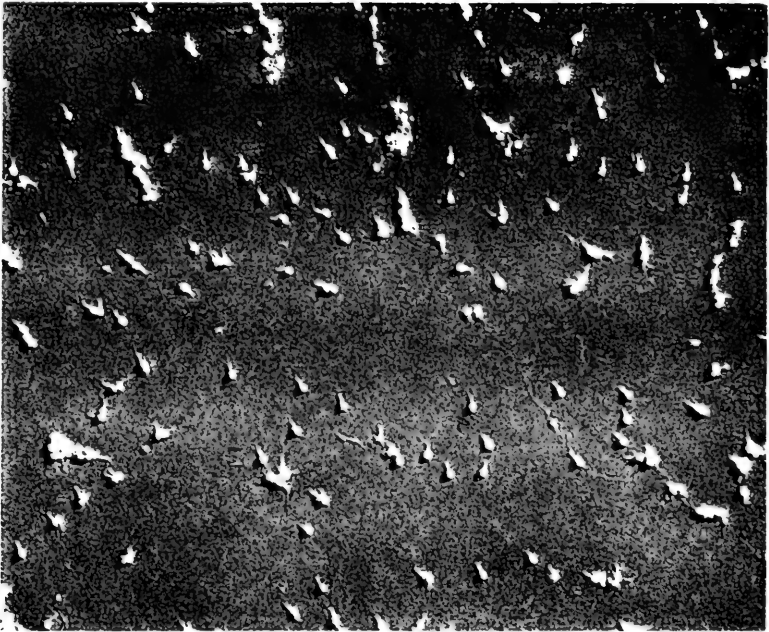

1. A soil phage, which destroys bacteria. Phages are a class of viruses; they consist of DNA surrounded by a protein covering, and they are capable of multiplying. (Electron-micrograph by E. Van Slogteren.)

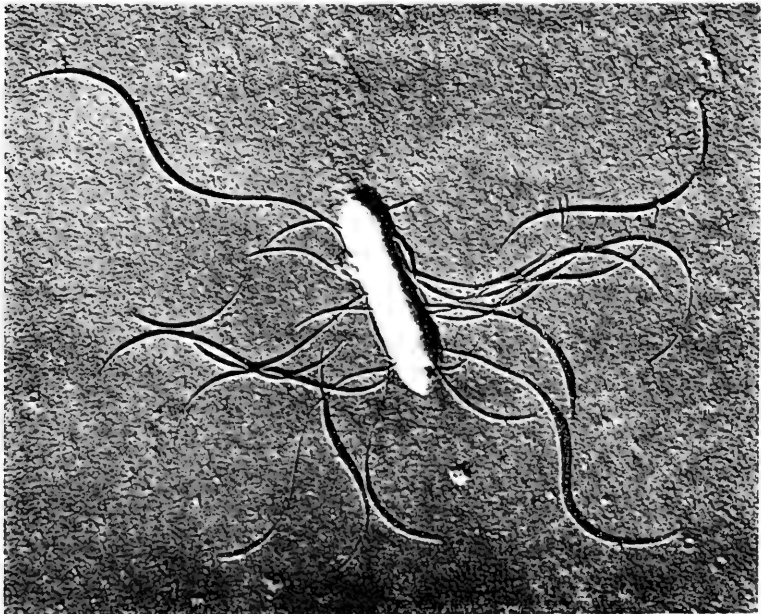

2. *B. hyacinthi*, a soil bacterium. (Electron-micrograph by E. Van Slogteren.)



Nematodes captured by a predaceous fungus. This consists of microscopic threads (hyphae) to which are attached small 3-celled rings. If a nematode thrusts its body into a ring, the cells of the ring expand inward, so gripping the nematode. Hyphae from the ring then grow into the nematode and absorb its contents. The photograph shows two captured nematodes; the one on the left is still alive; the other has been dead some time. (Photo by C. Duddington.)

ous and unexpected harm. The soil bacteria can decompose many stable types including benzene and naphthalene compounds; the formula should be designed to insure destruction when their work is done.

FOOD CYCLES IN THE SOIL

The ultimate source of food for the soil population is the dead vegetation falling on the soil surface and dragged in by the larger animals. Some organisms feed on it directly, some at second hand, some even more indirectly. The process has been studied by the foresters, and considerable work is now being done on grassland and on arable soils. W. Kühnelt, in the book already mentioned, describes the process as seen in a Swiss forest. In the first stage the forest litter is attacked by numerous members of the population. Bacteria and many of the animals take the carbohydrates and proteins which they can digest, and the fungi feed on the celluloses in the wood, which other organisms cannot take. In the second stage, organisms of the first stage are devoured by the predators. In neither stage do the organisms assimilate all the material they ingest: the rest is excreted. But the excretions still have some food and energy value and in the third stage they are consumed by the coprophagous or dung-eating organisms; this process is repeated while any utilizable material remains. Kühnelt states that among the tipulid larvae some of the smaller individuals consume the excreta of the larger ones—a monstrous piece of economy. The feces of many soil animals are rich centers for germination and growth of microorganisms.

The process appears to be of the same pattern on grassland and on arable land. Earthworms and other large animals begin operations by dragging the plant material into the soil and ingesting it. The decomposition is intensified by the vast numbers of bacteria in their guts which seem to find conditions there more favorable than in the soil outside: oxygen absorption and carbon dioxide evolution are much increased by the presence of these larger animals in the soil. Other actions are stimulated also: in the Arnheim experiments the introduction of a millipede into a soil culture increased fungus germination 400-fold. These are examples of what A. Macfadyen has called the catalytic action of the soil fauna. The small animals take over as in forest soils.

CONCLUSION

The most remarkable part of the story is the conclusion. The final unconsumed and indigestible material and excretions constitute the soil humus (most important for plant growth), and the simple salts to which much of the digested material has been reduced are nutrients essential to plant growth. They were taken up by the plant while it lived, they helped to build up the plant tissues, and now at the end

they are back in the soil ready to nourish a new generation and start the cycle again. The population on the surface of the soil, including ourselves, is thus entirely dependent on the population, mostly invisible to our eyes, living within it.

Much of our agricultural effort is really an attempt to help the soil population prepare the food for the next generation of plants. Plant residues—grass and clover leys, straw mixed with animal manure—are ploughed into the soil so that the soil population can get at it more easily. E. W. Russell⁴ compared the number of calories of human food produced with the number in the organic matter supplied per acre to the soil population: 13 million calories had been given, which would have sufficed for 12 persons for a year, but the calories in the human food produced numbered 2 million, sufficient for the needs of two persons only. More economical procedures are now known, but even the best are extravagant, and much research is needed to insure a more equitable distribution.

It will ultimately be necessary to obtain control of the soil population so as to insure more efficient working in our interests. For this purpose the soil population must be studied as a whole and not in isolated groups. Fortunately the subject is attracting increasing attention and much good work is now being done. Considerable progress may be expected in the near future.

⁴ Russell, E. W., *Soil conditions and plant growth*, 9th ed., Longmans, 1961.

The Evolution of the Echinoderms¹

By H. BARRACLOUGH FELL

Victoria University of Wellington, New Zealand

[With 3 plates]

Sea stars, sea urchins, and sea cucumbers are obviously interrelated in some way, for they share many common characters. Their origins and ancestry, however, have long remained a baffling enigma, for no intermediate forms between sea stars and other echinoderms have hitherto been recognized, and the relationships suggested by known fossils have seemed to conflict with those suggested by embryology. Recently a promising line of inquiry, based on comparative study of growth-gradients, has given a very different aspect to the problem. The investigation, reported in detail elsewhere (see references), has led to the isolation of several surviving members of supposedly extinct groups of sea stars, and the information yielded by these now suggests that sea stars (both brittlestars and starfishes) arose from a different stock from that which gave rise to sea urchins and sea cucumbers. This, in turn, implies that the conventional phylogeny of echinoderms is in need of some revision. A brief sketch of these ideas follows.

CONVENTIONAL CLASSIFICATION

The Echinodermata are, of course, well known for their conspicuous radial symmetry. They are also to be reckoned among the most numerous animals in the sea, as evidenced by the large numbers taken in trawls, and by photographs of the sea floor. Fossils show that they have been important faunal elements since the Cambrian. Although they are so notable for radial symmetry, we now know of at least one quite varied group of Paleozoic echinoderms with no trace of radial symmetry, the Homalozoa. Thus, a modern diagnosis of the Echinodermata would not include radial symmetry as a fundamental feature, stressing rather the unique crystalline calcite features of the skeleton, and the presence of a multipurpose hydrovascular system.

¹ Address delivered to the Jubilee Congress of the Australian and New Zealand Association for the Advancement of Science held at Sydney in August 1962.

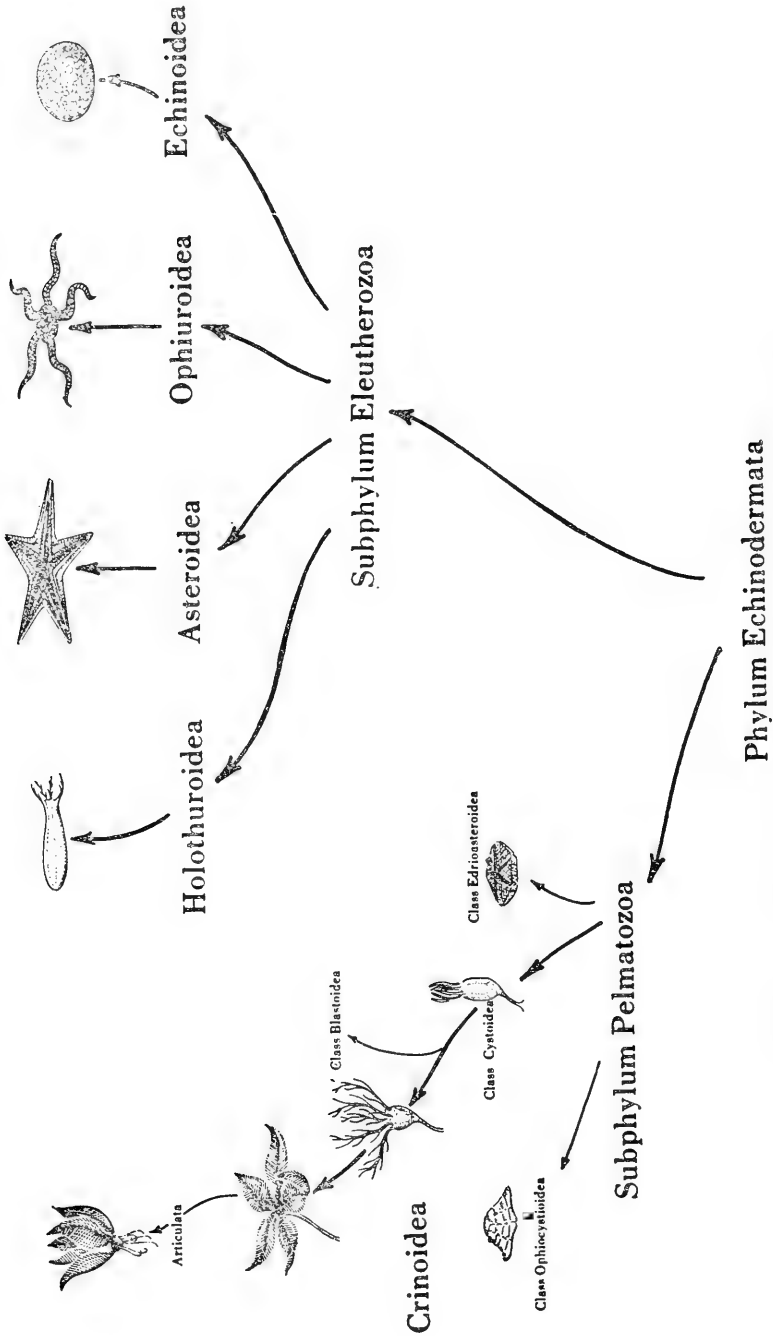

FIGURE 1.—Conventional classification of the radially symmetrical echinoderms.

Nonetheless, the vast majority of echinoderms do exhibit radial symmetry, and it is the radially symmetrical members that I wish to discuss here.

Figure 1 sets out the major divisions of the phylum, arranged in accordance with the conventional classification. On the left are the crinoids, which, with certain other fossil groups, comprise the subphylum *Pelmatozoa*. These forms are attached to the substrate for at least the earlier phases of the life history; they have a U-shaped gut, so that the mouth and anus lie side by side on the upper surface, and they employ a ciliary feeding mechanism which sweeps small particles along radial food grooves to the central mouth. The other four groups of echinoderms form the subphylum *Eleutherozoa*, free-living animals not attached to the substrate, with either a blind gut or a straight gut, the mouth being on the lower side, and equipped with jaws or similar structures, permitting a much coarser mode of nutrition. They comprise the *Holothuroidea* or sea cucumbers, the *Asteroidea* or starfishes, the *Ophiuroidea* or brittlestars, and the *Echinoidea* or sea urchins. All *Eleutherozoa* are viewed as descended from some common, though unknown, ancestry. This classification has been in vogue for many years, but there are grounds for suspecting that it is incorrect. However, before setting out on a necessarily abbreviated review of the evidence, we may first take note of certain views introduced by embryologists earlier in this century.

LARVAL FORMS

Figure 2 shows in schematic form a phylogenetic arrangement of *Eleutherozoa* as suggested by a comparison of their larval forms. Sea urchins and brittlestars share a larva called the *pluteus*, as seen in the upper two rows. Strictly speaking the larvae of the two groups are not the same, but they are certainly very similar and distinguishable from all others by their paired, rodlike arms. On the other hand, sea cucumbers and starfishes have larvae which lack rodlike arms, barrel-shaped forms with ciliated bands or lobes; in the simplest form, such a larva is called an *auricularia*. It is shown in the two lower rows. On the right you see the adult forms into which they metamorphose, and on the left the earliest larval stage of all, the *dipleurula*, from which all the larvae can be derived. Crinoids have a different type of larva, not shown in this diagram, but which we will discuss briefly a little later on.

The following phylogenetic relationships have been inferred from such evidence: *Ophiuroids* and *echinoids* are supposed to descend from some common ancestor while *asteroids* and *holothurians* would presumably be derived from another common ancestor. Both of these double lines, together with crinoids as a third line, would be envisaged as derived ultimately from a common *dipleurula* ancestry.

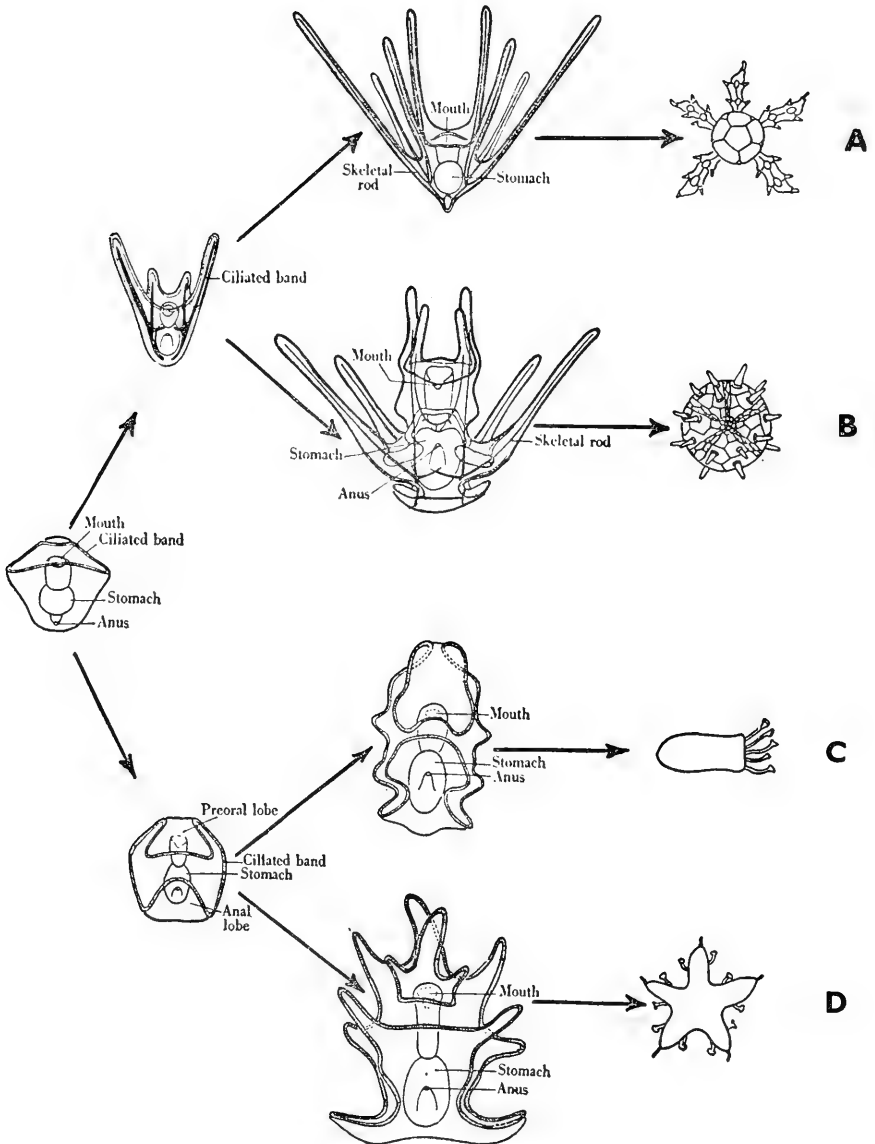

FIGURE 2.—Conventional phylogenetic arrangement of the free-living extant echinoderms, as suggested by their larval forms. A, Ophiurozoa, and B, Echinozoa, both groups having the pluteus-type larva. C, Holotherozoa, and D, Asterozoa, both groups having the auricularia-type larva. On the left is the dipleurula larva, from which all the other larvae arise during development.

Further, since the tornaria larva of enteropneusts closely resembles the auricularia, it was inferred that hemichordates arose from the same hypothetical auricularia ancestry as led to holothurians and asteroids. This necessarily implies a closer relationship between ophiuroids and echinoids than occurs between ophiuroids and asteroids, an inference so divorced from other evidence as to make the theory unattractive to students of echinoderms, few of whom have supported such speculations.

In 1948 attention was focused on some obvious weaknesses in the embryological theory. One of them is illustrated in figure 3, which shows how quite divergent types of larval development can occur within single groups, in this case ophiuroids. Some have a pluteus larva, others have a vitellaria or yolk-larva, similar to the larva of crinoids, and others again have no larva at all, not even a vestige of one. Thus, differences in mode of development do not necessarily indicate different origins, for obviously all ophiuroids are more closely interrelated to one another than to other echinoderms.

Figure 4 illustrates another criticism; quite unrelated assemblages can share common larval forms. Here we see diagrammatic life histories of a crinoid (on the right), an ophiuroid (on the left), and a holothurian (above), so arranged as to bring the common larval form, the vitellaria, into proximity. Obviously none of these can be closely related, yet all share a similar larva. On the basis of this

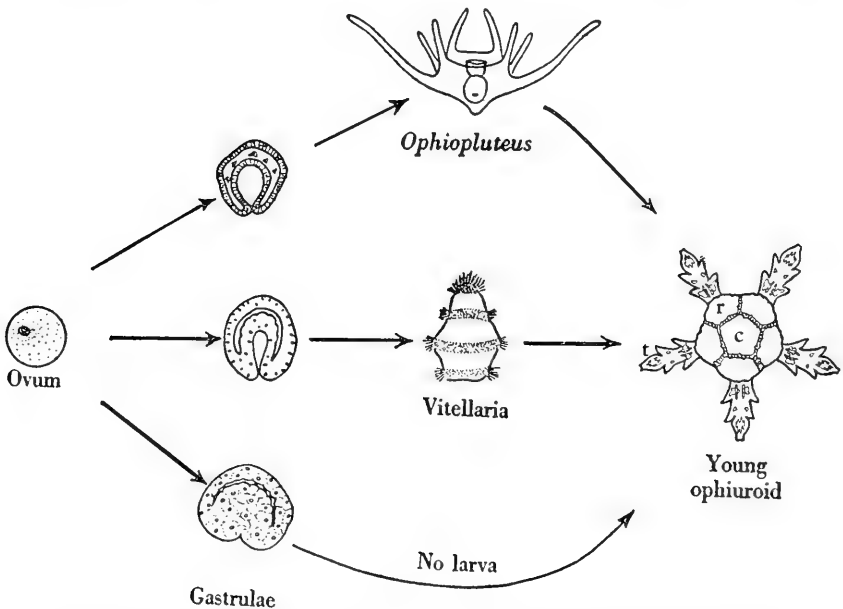

FIGURE 3.—Divergent types of development in the life histories of related echinoderms (Ophiuroidea).

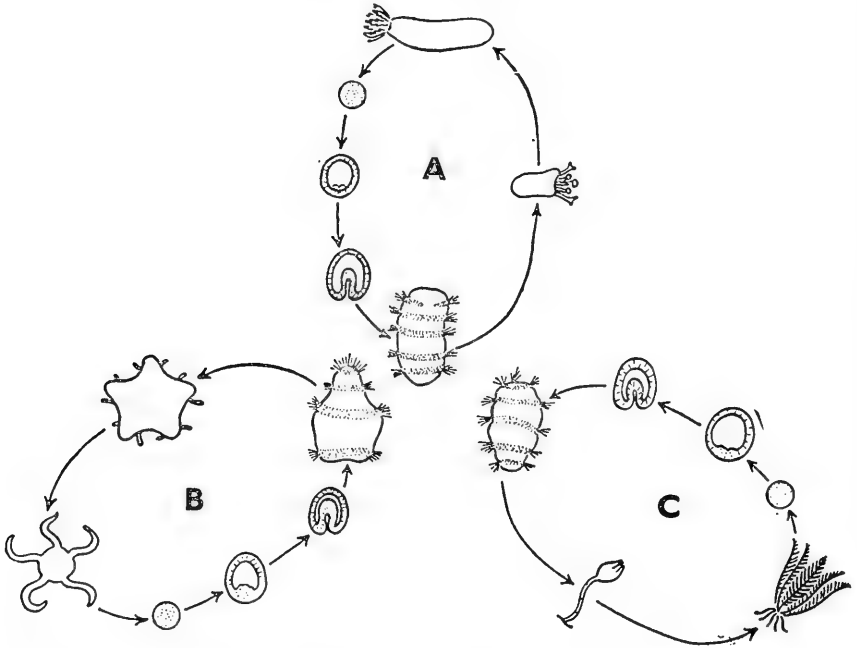

FIGURE 4.—Convergent types of development in the life histories of unrelated echinoderms. A, a sea cucumber (*Cucumaria*). B, a brittlestar (*Ophioderma*). C, a crinoid (*Antedon*).

evidence Caswell Grave had suggested as long ago as 1903 that a yolky egg and a vitellaria, or yolk-larva, may be an ancient feature of echinoderms, and that larvae such as the pluteus must be only specialized later developments. As, however, some ophiuroids with partly direct development have a vestigial pluteus, this has been taken as evidence that direct development is secondary and that yolk-larvae are a special kind of modified form without wide significance. Until last year no answer could be given to that objection, but, as will be mentioned later in this discussion, the impasse now seems to be soluble.

Certain serious objections to the embryological theory were also raised by comparative anatomy and paleontology. Fossil evidence already available in 1948 implied that ophiuroids had arisen from some generalized lower Paleozoic stock of sea stars, from which modern starfishes must also have descended. Echinoids and holothurians, according to the evidence of fossils, seemed to have been derived from ancient pelmatozoans, and certainly could not be related to the star-shaped groups in the strange way which the embryological evidence implied. Even at that date no paleontologist could have doubted that asteroids and ophiuroids arose from a common ancestry, yet the embryological evidence, still cited by one author of a textbook as late as 1955, implied a closer affinity between ophiuroids and echinoids. Obviously more definite evidence was needed.

FOSSIL SOMASTEROIDS

This evidence, as is now apparent, was first placed in our hands in 1951, though its full significance was not apparent till quite recently. Figure 5, A–F, shows the lower Ordovician sea star *Chinianaster*, of which the late W. K. Spencer published the first detailed description in that year. Spencer recognized it as the type of an entirely unknown kind of sea star, evidently antecedent to both ophiuroids and asteroids, and characterized by the frondlike structure of the arm, in which transverse rows of rodlike ossicles, which he called *virgalia*, lay on either side of a double axial series of ambulacral ossicles.

Figure 5, G, shows *Villebrunaster*, another of these ancient sea stars and, like *Chinianaster*, from the lower Paleozoic of Europe. Spencer, as a paleontologist, was well aware of the fact that fossils indicate that ophiuroids and asteroids had a common ancestry, and so, in common with other echinoderm paleontologists, he employed a classification in which both groups are placed together in one class called Asterozoa or Stelleroidea. Until 1900 the same classification had also been used by zoologists, and Lankester's *Treatise* published in that year had retained it; for it was not until the next decade that embryological theories came to the fore. Spencer, who was not an embryologist, recognized, of course, that the animals he had before him were members of the Asterozoa, though they obviously could not be referred to either of the known subclasses Asteroidea and Ophiuroidea. He therefore proposed for their reception a third subclass, the Somasteroidea, antecedent to the other two subclasses. You will see from the illustrations that both genera show a broad, petal-shaped arm, extremely flattened and leaflike, with each adjacent pair of arms separated by a deep interradian cleft, the disk region quite small, and the mouthparts obviously very simple and derived from the adjoining elements in the base of the arm skeleton.

Spencer also recognized another kind of somasteroid, shown in figure 5, I, the genus *Archegonaster*. It too had the characteristic transverse rows of *virgalia*, but was more starfishlike in appearance, because the arms were fused broadly at the base, and the outermost *virgalia* had been converted into a marginal series of large plates defining the outline of the animal. Also the innermost *virgalia*, adjoining the axial ambulacral ossicles, carried spines and evidently corresponded to the plates called adambulacral plates in modern starfishes. Spencer thus concluded that starfishes had been derived from somasteroids, and although he did not say so, he left it to be inferred that ophiuroids also must have arisen from somasteroids. He believed that somasteroids must have had ciliary food grooves between the rows of *virgalia*, and that their mode of nutrition would have resembled that of pelmatozoans.

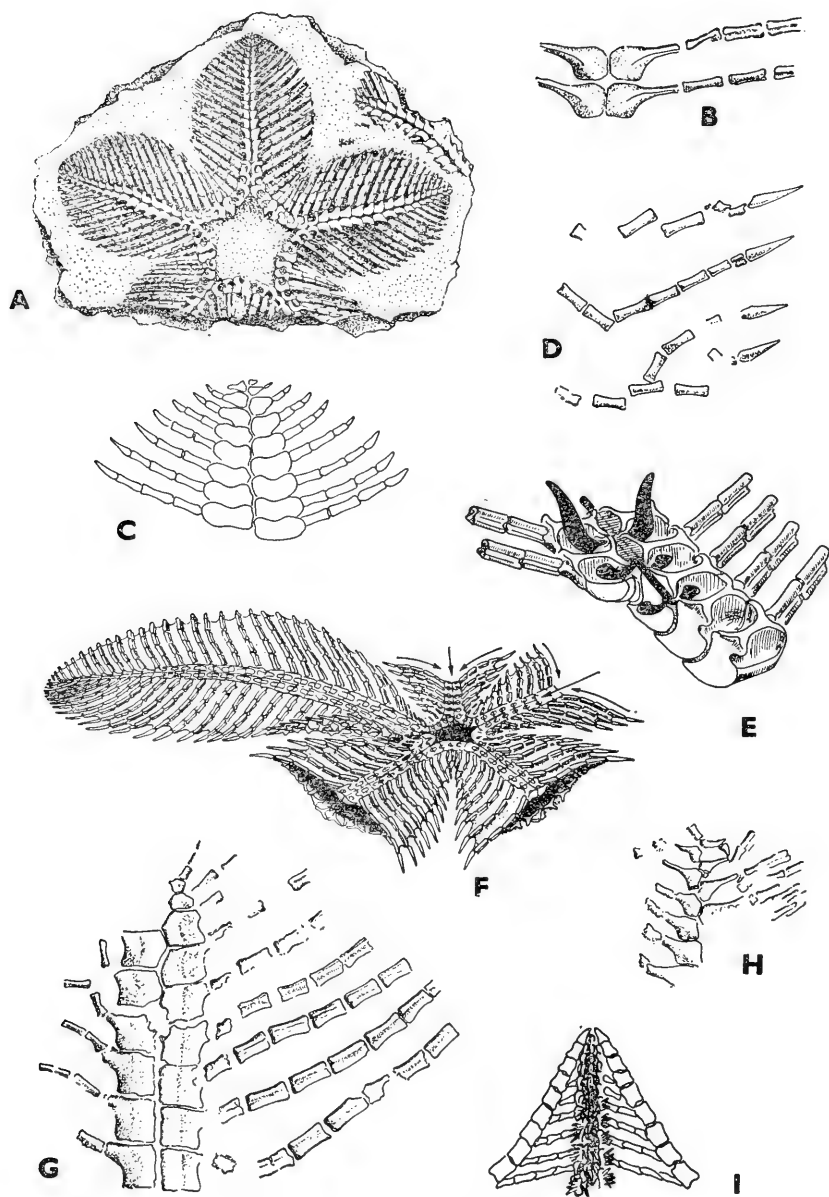

FIGURE 5.—Fossil somasteroids of the Ordovician period. A-F, H, *Chinianaster*; G, *Villebrunaster*; I, *Archegonaster*. For description, see text.

Figure 5 shows some details which have recently been elucidated on material of *Chinianaster* and *Villebrunaster*. In figure 5, B, the ambulacral ossicles are seen to be arranged in opposite pairs; this is the condition in the middle and base of the arm. In figure 5, H, however, they are seen to be placed alternately; this is the condition in young specimens of *Villebrunaster*, and at the tip of the arm in older specimens. In figure 5, D, are seen rows of virgalia in *Chinianaster*; they terminate in a spine-shaped virgalium. In figure 5, G (*Villebrunaster*), virgalia are seen overturned on the right side and erect in the normal position on the left; from this specimen, and others, it has become clear that each fully developed virgalium was shaped like a segment of a tram rail, while in the growing region they were nearly cylindrical rods.

Figure 5, E, shows a more detailed reconstruction on the basis of the type material of *Chinianaster*, and of other specimens since discovered. It explains the relation of the ambulacral ossicles to the adjacent virgalia. Tube-feet were evidently placed in cup-shaped depressions on the lower side of the ambulacra, here sketched upside-down, as in ventral aspect. The arm had a frondlike structure to the very tip, as seen in figure 5, C.

Figure 5, F, is a general reconstruction of *Chinianaster*, seen in ventral aspect, to incorporate these data. The arrows show the direction of the inferred ciliary currents in the food grooves between the rows of virgalia, and along the main radial groove leading to the mouth. The material on which these details have been studied was generously placed in my hands by Prof. Georges Ubaghs, of Liège.

Referring again to *Archegonaster*, figure 5, I, the more starfishlike of the somasteroid fossils: Note the buttresslike appearance of the virgalia, especially near the ends of the arms, where they seem to make a bridge between the marginal plates and the axial ambulacral plates. This illustration, published by Spencer in 1951, remained with me as a dimly remembered image after I read his paper. Meantime I had embarked on a long series of dissections of modern genera of starfishes, searching for characters which might enable a better correlation between the Paleozoic sea stars and the modern forms, and thus lead to a more satisfactory classification. It happened that one of the genera whose skeleton I had prepared some years prior to 1951 was *Persephonaster*, illustrated in figure 6, E. The dissection was used for a number of years in our practical classes, but although students had several times questioned me about the rodlike ossicles between the ambulacral ossicles and the marginal series (for no such rods were mentioned in the textbooks), I am afraid a good many years went by before it dawned upon me one day that there was something oddly familiar about these so-called superambulacral ossicles. Of course, as must now be obvious to you, they present a remarkable

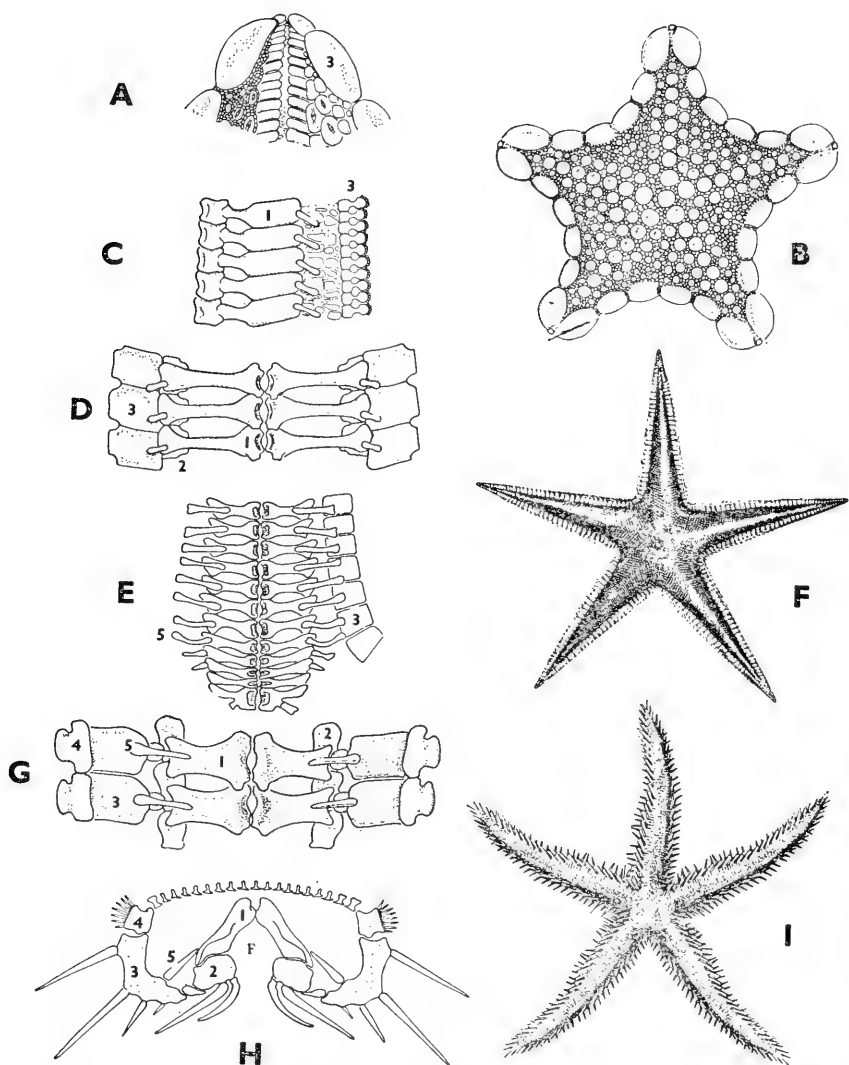

FIGURE 6.—Patterns of the skeleton in representative asteroids, illustrating the growth axes described in the text. A, ventral aspect, and B, dorsal aspect, of *Pentagonaster* (Goniasteridae); C, *Leptychaster*; D, *Astropecten*; E, F, *Persephonaster* (all Astropectinidae). G, H, I, *Luidia*; G, dorsal internal aspect of endoskeleton; H, transverse section of arm (Luidiidae). Abbreviations: 1, ambulacral ossicle; 2, adambulacral ossicle; 3, inferomarginal ossicle; 4, supermarginal paxilla; 5, superambulacral ossicle; P, ambulacral furrow.

resemblance to the virgalia of *Archegonaster*. Now *Persephonaster*, as seen in figure 6, F, is a typical starfish, related to the well-known genus *Astropecten*, and differs quite considerably from any known somasteroid. However, it seemed worth while to ascertain whether rodlike superambulacral ossicles occur in other genera. It did not take long to establish the fact that such ossicles occur only in the families Astropectinidae and Luidiidae, and only in some of the members of these two families do they have a rodlike form. The next point I investigated was whether the skeletal ossicles ever form transverse series.

Figure 6 shows representative examples of the kind of arrangement of the internal skeletal elements that occurs in various starfishes. Dissections indicated that in every family except one the ossicles conform to patterns such as appear in the upper diagrams, figure 6, A-E. The gradients are essentially longitudinal ones, the ossicles differentiating in series not coordinated transversely, but instead longitudinally, retaining this arrangement throughout life. In some of the Astropectinidae, as in figure 6, D, E, a tendency to transverse arrangement is apparent, since the marginal longitudinal gradient is nearly, though not quite, in phase with the axial gradient differentiating the ambulacral ossicles, and the other gradients are nearly coordinated also. But in the one remaining family, the Luidiidae, an exact correlation occurs between all gradients, and thus the ossicles differentiate not only in longitudinal gradients, but also in transverse series.

SURVIVING PLATYASTERID STARFISHES

Figure 6, G, shows these features in *Luidia*, as seen in dissection from the dorsal side. It is clear that the ossicles all differentiate under a double intersecting system of longitudinal and transverse gradients. However, this is also a character of all known ophiuroids. Thus, the Luidiidae could now be set apart from all other asteroids, and the character which distinguished them was one which they shared with ophiuroids. It was further very significant that Luidiidae have a blind gut, with no anus, just as in ophiuroids, and have no suckers on the tube feet; these two latter characters are shared by some Astropectinidae, a family which (as we have just seen) also has rodlike superambulacral ossicles. I was now convinced that the Luidiidae must be the most ancient type of surviving asteroids, and that Astropectinidae represent a transitional phase between Luidiidae and other asteroids. Could it be that Luidiidae are also transitional forms, linking the ancient somasteroids with asteroids? It would be too long a story to relate step-by-step here, but this is an appropriate place to interpolate a later finding, in which I was assisted by an idea sent to me by my colleague C. W. Wright of London,

by which it can be demonstrated that luidiid skeletal structure had already appeared in the lower Ordovician sea star *Platanaster*. Thus, though Luidiidae have until now been thought to be a modern group without fossil representatives, on the contrary they are now seen to be truly living fossils of the antiquity of Platanasteridae. Edward Llhuyd, who first recognized that featherstars are surviving sea lilies in a paper published in 1699, is honored by the Latinized version of his name, Luidius, from which *Luidia* is derived. How justly named that genus is! To return to my subject, however, it was obvious that *Luidia* could not be directly related to somasteroids, for, as seen in figure 6, H, the cross section of the arm shows a very deep furrow excavated on the lower surface, bounded by the ambulacral ossicles, and housing the tube feet. All starfishes have this feature, called the ambulacral groove. It is really the diagnostic character of Asterozoa. It is produced by the erection of the ambulacral ossicles, which stand *upon* the adambulacral ossicles, and it serves the gross feeding which typifies starfishes. Somasteroid fossils did not exhibit this structure, for the ambulacral ossicles are recumbent. Again, as seen in figure 6, I, the body of *Luidia* differs considerably in form from that of a somasteroid, for the arms are long and strap-like, as in many modern starfishes.

We may now consolidate the data so far. Figure 7 sets out in simplified schematic form the different patterns of growth gradient fields so far established in the various Asterozoa. On the right is the pattern typical of all asteroids except Luidiidae; it is dominated by longitudinal gradients. In the center is the pattern seen in Luidiidae and all Ophiurozoa, with dominant longitudinal gradients intersected by short transverse gradients. On the left is the inferred gradient field of a chinianasterid somasteroid, in which dominant

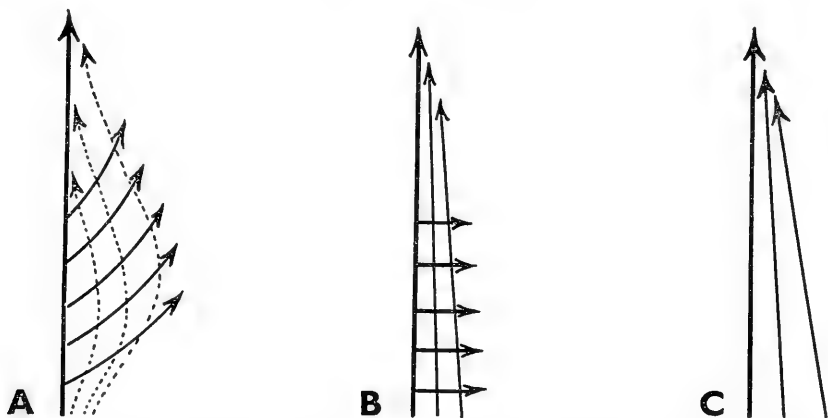

FIGURE 7.—Growth-gradient fields in Asterozoa. A, somasteroids (found also in pinnulate crinoids). B, Platyasterida and Ophiurozoa. C, Asterozoa, other than Platyasterida.

transverse (or obliquely transverse) gradients are intersected by subsidiary longitudinal gradients, shown by dotted lines, and swinging outward near the base to produce the petaloid outline of the arm. This pattern, incidentally, is also seen in crinoids. No patterns of this type, in fact none of the patterns illustrated, are found in any other echinoderms. On the evidence so far, it appears likely that the left-hand pattern is the oldest, that the middle pattern arose from it, and that the right-hand pattern arose from the middle pattern. Independent evidence, which space excludes from citation here, shows that the soft structures of the arm indicate a similar sequence.

To refresh your minds as to the gradients in somasteroids, glance back at figure 5 and note how the gradient field is perpetuated in the adult skeleton, which preserves the gradient patterns under which it must have been produced during development.

A SURVIVING SOMASTEROID

Now, having isolated Luidiidae as the most archaic surviving type of asteroid, the obvious next step was to examine each of the surviving representatives of that family. One of the genera dubiously referred to the family is *Platasterias*, recorded from west Mexico 91 years ago and about which little is known.

Figure 8, A, shows the original lithograph published by Gray in 1871. Some features immediately arrest our attention—the petal-shaped arms (unknown in any other living asterozoan), the evident flattening of the animal, and what appears to be a transverse arrangement of the underlying internal skeleton. Notice that one of arms is represented by a regenerating stump. The authorities of the British Museum, in which the type specimen was deposited, generously allowed me to dissect this regenerating arm as soon as they received a statement setting out the grounds for suspecting it might throw important light on the affinities of Chinianasteridae.

Plate 1 shows this same arm, with the regenerating tip, in oblique ventral aspect, after some superficial dissection. Of course, it is at once apparent that *Platasterias* is not only a somasteroid, but one more closely related to the Chinianasteridae than is *Archegonaster*. Apart from the characteristic transverse rows of virgalia, it has the ambulacral plates in a recumbent position, with a long lateral wing (labeled 1), resting nearly horizontally along the first virgalium (labeled 2)—note that in this aspect the arm is upside down. Between the transverse rows of virgalia are the very grooves which Spencer had inferred in his fossils, leading into the narrow and shallow radial groove (numbered 3), below the ambulacral ossicles, and leading to the mouth. A preliminary account of this specimen has since been published (Fell, 1962a).

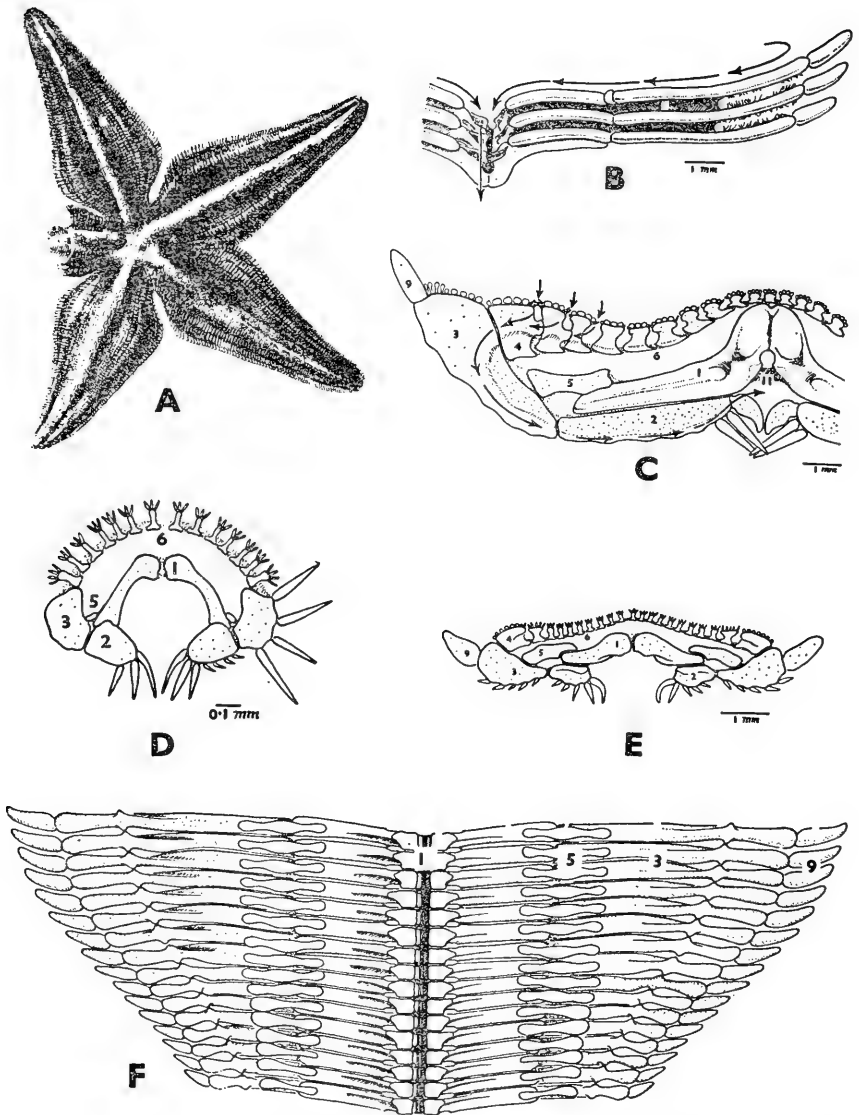
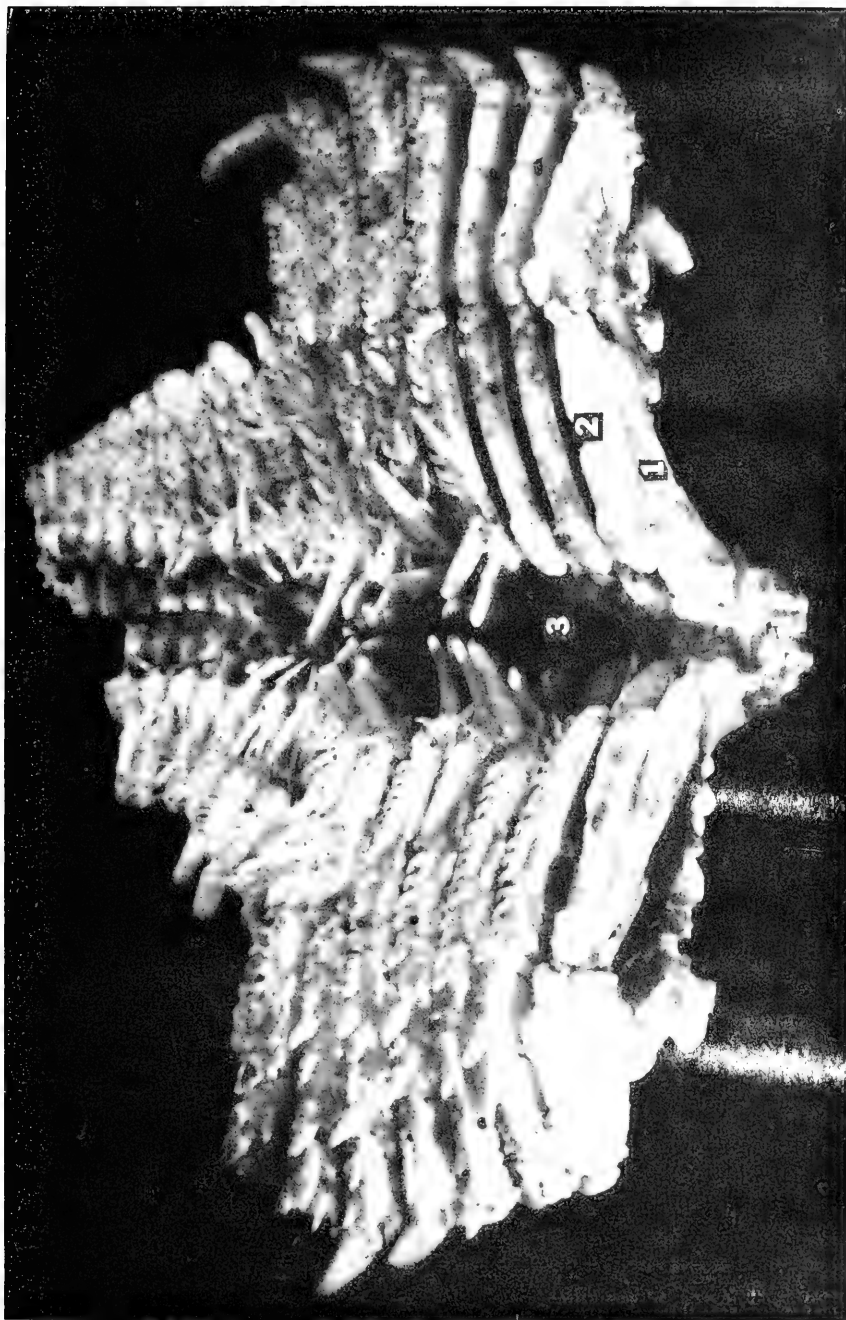
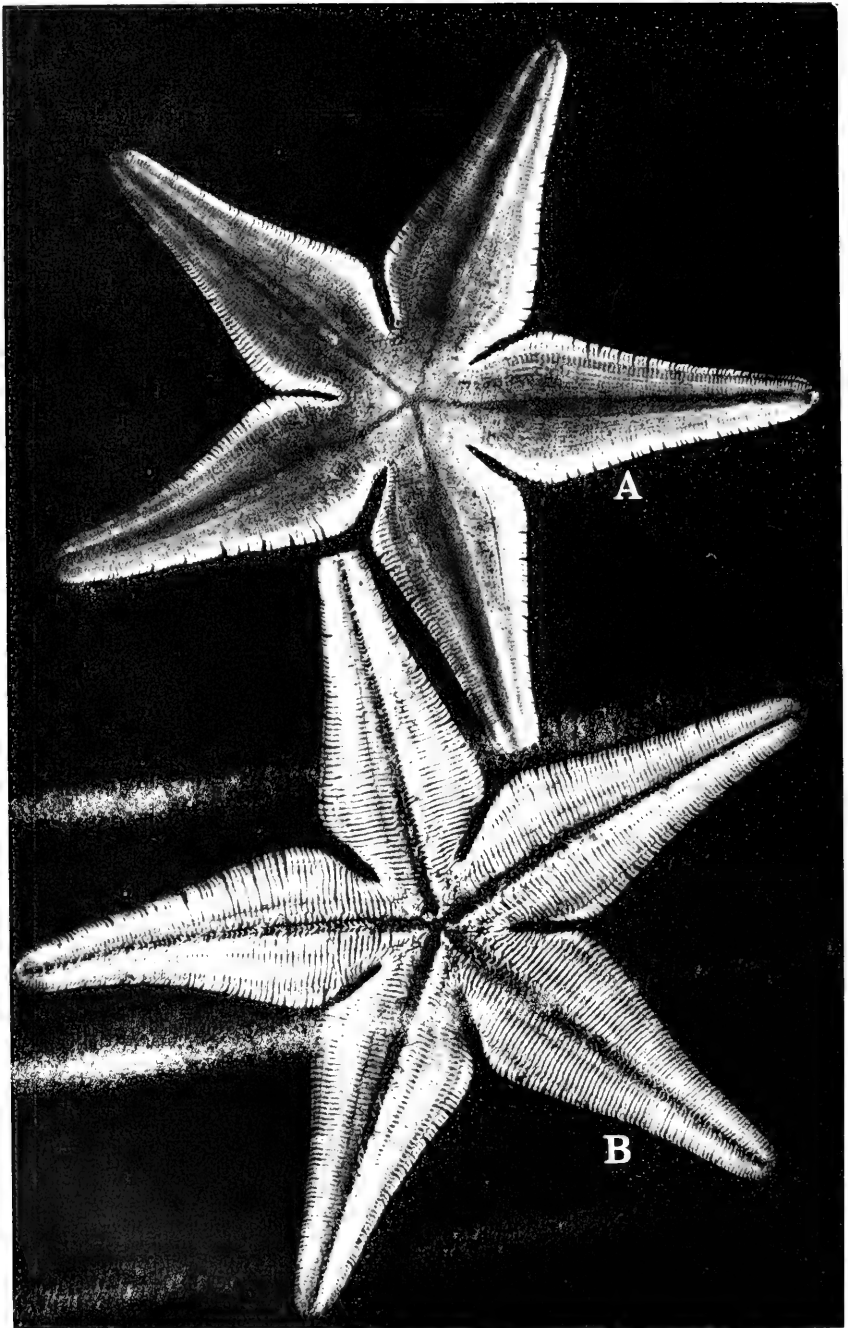

FIGURE 8.—A-C, E, F, *Platasterias latiradiata* (Somasteroidea); D, *Luidia* (Asteroidea, Platyasterida), cross section of extreme armtip. For explanation, see text. Abbreviations: 1, ambulacral ossicle; 2, first virgalium (V-1, or adambulacral ossicle); 3, third virgalium (V-3, or inferomarginal ossicle); 4, superomarginal paxilla; 5, second virgalium (V-2, or superambulacral ossicle); 6, dorsal surface of arm; 9, fourth virgalium (V-4, or inferomarginal radiole); 11, adductor of ambulacral ossicles.



Phaenaria latreutiae, holotype. Regenerating arm, dissected in ventral view. 1, recumbent ambulacral ossicle; 2, ventral sclerite; 3, radial coxal vein. (Photography by M. D. King, Victoria University of Wellington.)



Pliocystis latiradiata. A, dorsal aspect; B, ventral aspect. \times two-thirds. Material ex *Tchern III* (Corinto), courtesy F. C. Ziesenheim. (Photo by M. D. King, Victoria University of Wellington.)

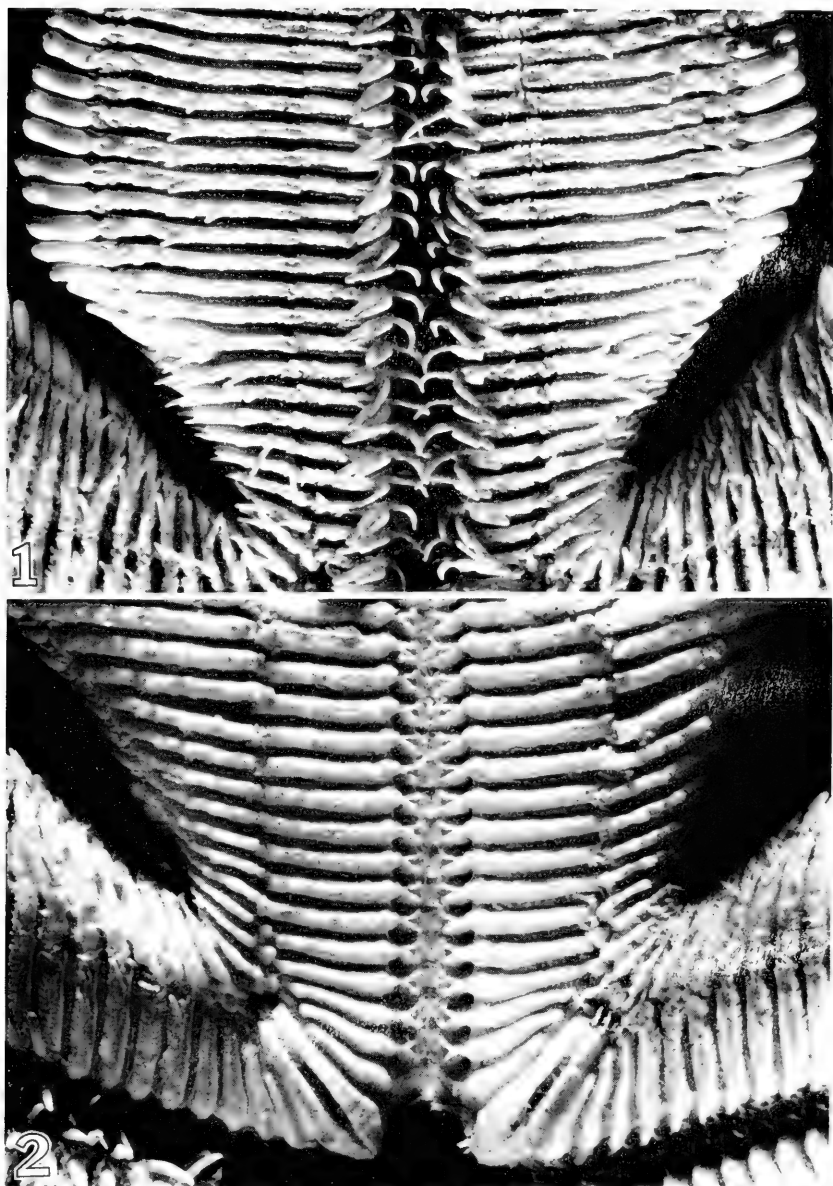

Platasterias latiradiata. 1, ventral aspect. 2, endoskeleton. Material ex *Vaero III* (Corinto), courtesy F. C. Zieshenne. (Photo by M. D. King, Victoria University of Wellington.)

Inquiries were now directed to institutions on the west coast of America, requesting a search for new material. This was forthcoming almost immediately, for by good fortune some material had been taken in 1939 off Nicaragua by the Allan Hancock research vessel *Velero III*, though not recorded. Plate 2 shows one of the splendid examples generously placed at my disposal by Capt. F. C. Ziesenhenné. On the lower surface, seen in plate 2, B, the pinnule-like rows of virgalia are evident even without dissection. The specimens showed that *Platasterias* is able to feed on animals as large as small amphipods, some of which were found wedged in the narrow grooves of the arm, and in the mouth.

Plate 3(1), also from ventral aspect, illustrates the dominant transverse gradients of the arm and the general chinianasterid facies of the animal. The soft-part characters include small tube feet without suckers, a blind gut with no anus, and as expected a madreporite placed at the edge of the disk, as in fossils.

Plate 3(2) is a dissection of the skeleton, in ventral aspect, with the lateral food-grooves exposed between the rows of virgalia. The jaws are derived from ambulacral elements.¹ A difference from Chinianasteridae is seen in the establishment of the virgalia in four longitudinal rows, the homologies of which with asteroids are easy to recognize. This photograph also shows some details of the radial groove. The conspicuous Y-shaped processes had also been observed in the fossils, though their significance was unknown. *Platasterias* shows that a transverse adductor muscle lies between the adjacent forks of the Y's on either side of the groove, and its action is to raise the groove by approximating the ambulacrals. Thus now we can understand how the fossil forms would feed, for hitherto it was puzzling that the lateral grooves seemed to lead into a flattened radial region. As we now see, the groove is raised or lowered by the muscle, and the fossils, being compressed, are in the lowered condition.

Figure 8, C, shows the adductor muscle in the middle of the cross section (numbered 11), in the roof of the radial groove. The structure of *Platasterias* implies ciliary currents, as suggested by the arrows, and the cilia that produce them are almost certainly located on the delicate microspines shown in the grooves on the right of figure 8, B, a ventral view. However, detailed study of wet material has not yet been carried out.

Figure 8, E, is a cross section of the arm tip in the regenerating arm, the youngest stage so far investigated. The ambulacral ossicles are here completely horizontal, and the outer wing is evidently growing between the two first virgalia, in such a manner as to wedge the second one upward, thus producing the superambulacral ossicle.

¹ Not from proximal virgalia, as originally reported (Fell, 1962)

Figure 8, F, shows the general layout of the arm skeleton, in internal aspect, dissected from above. The occluded second virgalia of each row form conspicuous series, the origin of all the asteroid skeletal elements from virgalia being most precisely indicated, so that the exact homology of every plate can be stated in terms of a code-numbering system which has been proposed for the purpose.

Returning now to the asteroid dissections, there are some other points of interest. In figure 8, D, is the youngest stage of the arm in *Luidia* as seen in cross section near the extreme tip. Already at this early stage the ambulacral ossicles are completely erected, as in all asteroids, and in contradistinction to the corresponding section in *Platasterias* (fig. 8, E), where the ambulacral ossicles are quite horizontal. Figure 9, A, illustrates the jaws of the asteroid *Persephonaster* (those of *Luidia* are quite similar). In each jaw there is a T-shaped plate overlying a larger pair of plates, here colored in with black and forming the actual jaw. The large plates forming the greater part of the jaw are really a displaced pair of ambulacral ossicles, as will now be shown.

ALL STARFISHES FUNDAMENTALLY PINNATE

In figure 9, B, a general dissection of the arm base and adjacent jaw is shown for *Platasterias*, in ventral aspect. The ossicles A1, A2, and A3 which make up the structure have been derived from the adjacent ambulacral series of the arms on either side. This can be demonstrated by comparing the jaw with that of the young stage of the oldest and most generalized asterozoan, namely the somasteroid *Chinianaster* of the Cambro-Ordovician (fig. 9, C, D), and that of the more advanced somasteroid *Villebrunaster* of the same age (fig. 9, E). The puzzling T-shaped plate of *Platasterias* and primitive asteroids would seem to represent tegmental plates of the earlier somasteroids, covered over by outward growth of the plate A1; this latter plate is already sending out a small interradiial extension in *Villebrunaster* (fig. 9, E), and evidently a further extension of the process led to the condition seen in *Platasterias*. The jaw of *Chinianaster* shows some curious resemblances to the base of the arm in crinoids. For example, in crinoids two of the arm-joints at the base of the arm tend to fuse together, to produce a double joint, termed a syzygy. The inner of the two successive elements forming the syzygy is termed a hypozygal, and it carries no pinnule; the outer element is called the epizygal and, unlike the hypozygal, it does carry a pinnule. The pinnule of the epizygal is often larger than the others, and serves as a special feeding organ, being then termed an oral pinnule. It is of great interest that the second and third ambulacral joints of *Chinianaster* are soldered together to make a syzygy, and that the hypozygal carries no pinnule, while the epizygal carries an

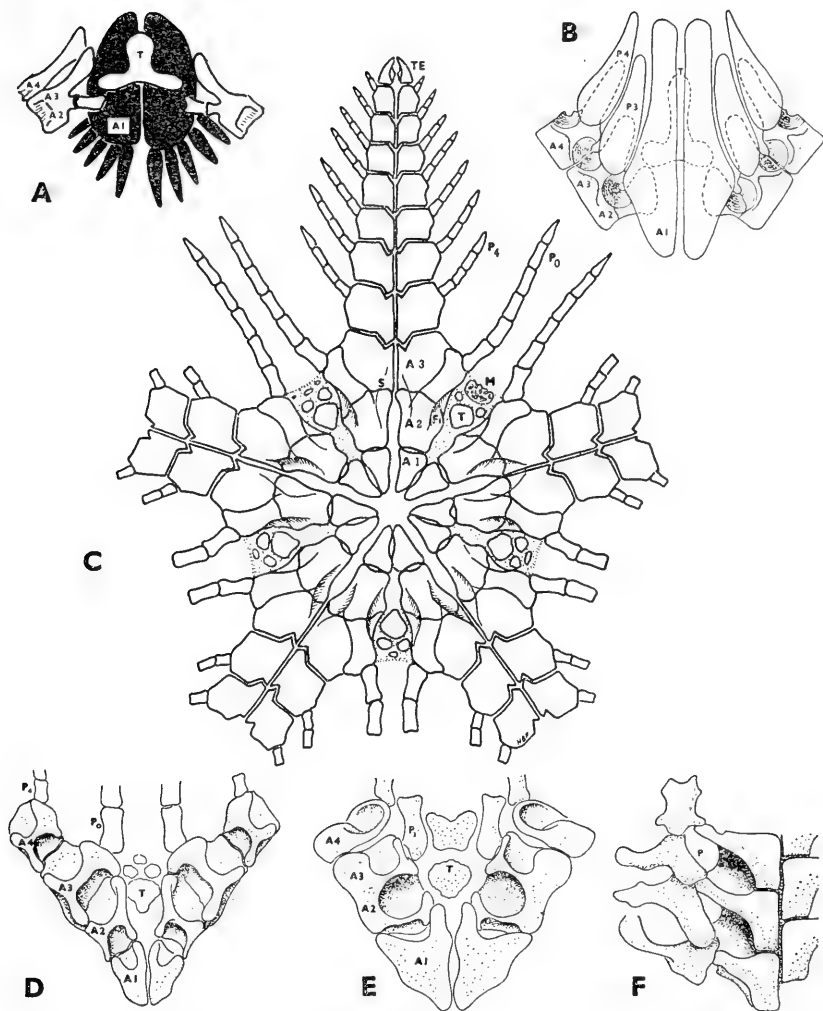

FIGURE 9.—A, jaw of an asteroid, *Persephonaster*. B, jaw of the somasteroid *Platasterias*. C, juvenile stage of the Cambro-Ordovician somasteroid *Chinianaster*, X 8. D, ventral aspect of the jaw of juvenile *Chinianaster*. E, ventral aspect of the jaw in the Cambro-Ordovician somasteroid *Villebrunaster*. F, *Ampullaster*, an Ordovician somasteroid in which the tube-foot rested on a sunken shelf, with a pore for an internal ampulla bounded by the wings and adjacent adambulacral virgalia.

A1, A2, A3, A4, first, second, third, and fourth ambulacral elements, A1 forming the jaw angle-plate. F1, facet for interradiar muscle of jaw. M, sieve-plate. P₀, oral pinnule. P₃, P₄, pinnules of third and fourth arm joints (in the case of *Platasterias* and *Villebrunaster*, modified into fixed metapinnules). S, line of syzygy between A2 and A3. T, terminal or T-shaped plate. TE, terminal pair of ambulacral ossicles.

enlarged, and evidently movable, pinnule—apparently an oral pinnule.

Another interesting parallel is that the ambulacral ossicles of *Chinianaster* are solid, block-like structures, like the arm-joints of crinoids. *Chinianaster* had pointed tube-feet (preserved in some of the fossils), and they were carried in basin-shaped depressions on the lower side of the arm, one basin between each adjacent pair of ossicles (fig. 9, D). In the more starfish-like somasteroids, however, there grew out a lateral wing from each ossicle, and the basins for the tube-feet became a mere shelf, which sank inward between successive wings. In the Ordovician genus *Ampullaster*, and to a lesser extent in the contemporary somasteroid *Villebrunaster*, the shelf led to a definite internal opening, labeled P in figure 9, F. The pore was evidently for an internal extension of the base of the tube-foot, a small reservoir called the ampulla. *Platasterias* has a small ampulla, and starfishes generally have a large one. The Ordovician somasteroids *Villebrunaster* and *Ampullaster* also have the innermost virgallium somewhat enlarged, forming a definite adambulacral plate, as in starfishes; and the outermost virgallium in these genera was transformed into a marginal plate. Thus, many features of modern starfishes were already developed in some of the lower Paleozoic somasteroids. These facts have only recently become known, the earlier descriptions of fossil somasteroids having been very inadequate. It is clear that no sharp boundary separates the starfishes from the somasteroids, and that the mosaic-like pattern of the skeleton of modern starfishes arose from the frond-like pattern of the somasteroids.

Refer again to figure 7, and note the three main phases in the transformations of the gradient patterns, which are simplified in the diagrams, so as to stress the main features.

Figure 15 gives a representative series of arms of genera illustrating these three main patterns, though it also shows that there are no hard and fast boundaries between them. In figure 15, C (*Chinianaster*), and D (*Platasterias*), there are dominant transverse gradients and petaloid arm form. Figure 15, E, is *Platanaster*, a lower Paleozoic asteroid in which the petaloid arm is retained, but the transverse and longitudinal gradients are now equally evident. Next follows *Luidia* (fig. 15, F), where the gradients are still as in *Platanaster*, but the arm has now lost its petaloid form. On the extreme right (fig. 15, G) is *Plutonaster*, an astropectinid, in which the transverse gradients are disrupted by longitudinal sliding of the elements, and the base of the arm has expanded by the insertion of new elements, the actinal intermediate series.

Figure 10 presents a corresponding series of cross-sectional views of arms of representative genera, ranging from somasteroids above to

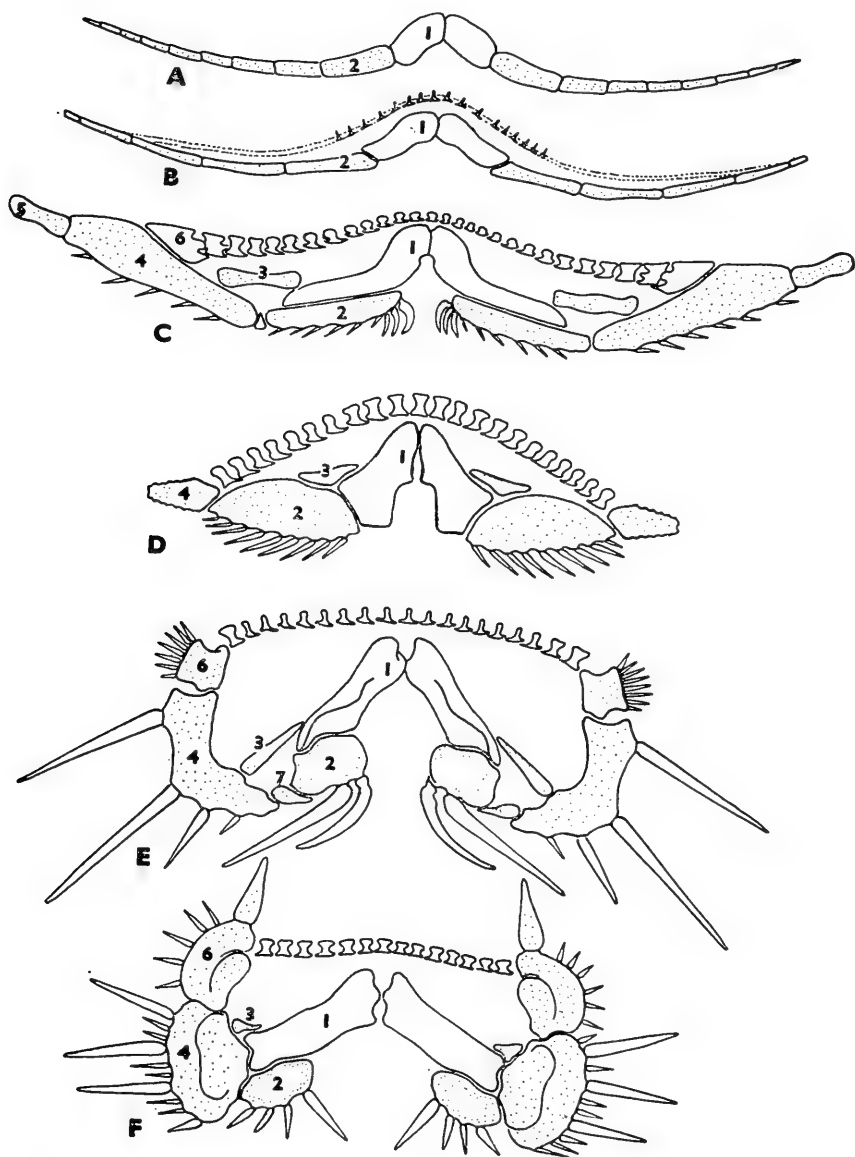

FIGURE 10.—Sequence of cross sections of the arm in: A, biserial crinoid; B, *Chinianaster*; C, *Platasterias*; D, *Platanaster* (Platyasterida); E, *Luidia*; F, *Astropecten*. Abbreviations: 1, ambulacral (brachial) ossicle; 2, virgalium-1; 3, virgalium-2; 4, virgalium-3; 5, virgalium-4; 6, superomarginal paxilla. (Homologies of virgalia are as given in caption to Fig. 8.)

various grades of asteroids below. Space will not permit detailed analysis, but note the gradual conversion of originally slender virgalia into massive blocklike elements in the later grades, and the simultaneous erection of the ambulacral ossicles upon the proximal virgalia (or adambulacrals, as they now become) to produce the elevated invaginated furrow of asteroids. Although many details, including all the soft parts, have had to be omitted from this condensed account, I think it will by now be clear how the asteroids can be traced back, without any sharp break, to the ancient lower Paleozoic somasteroids. We can, I believe, trace them still farther back, but first of all, what of the Ophiuroidea?

PINNATE STRUCTURE IN BRITTLESTARS

It would be tedious and unnecessary to attempt here to trace the ophiuroids backward in time in such detail, and of necessity this part of the topic must be cut to its bare essentials. Glance again at figure 5 to refresh your memory of the essentially pinnate structure of Ordovician somasteroids. Since we have ascertained that the ambulacral ossicles alternate near the tip of the arm, and in the young stages of *Chinianaster*, it follows from Jackson's so-called "law of localized stages" that the opposite condition of the ambulacral ossicles must have been derived from an original alternating condition. This alternating condition was retained in *Archegonaster*, in some Paleozoic asteroids, and in some of the Paleozoic ophiuroids. One very important point emerges. It has been shown how asteroids have arisen from a former pinnate grade of organization, represented by somasteroids, and that the most primitive asteroids preserve pinnate features in the arm. Now, if ophiuroids, as we suspect, arose from a similar ancestry, they too should exhibit evidence of pinnate structure. A considerable number of genera were accordingly dissected, in search of such features, and the results are illustrated by the representative genera shown in figure 11. Except for figure 11, E, which shows an Ordovician genus with alternating ambulacral ossicles, all illustrations are of surviving genera. The pinnate structure is self-evident, and it is indeed strange that so little attention has been paid to such evidence hitherto, almost the entire classification having been based on superficial characters not requiring dissection. The condition D, in the middle, shows the final simplification, as seen in the vast majority of surviving genera. Yet even in this simplified state, the homologies of the ossicles are easy to determine. In fact, the entire skeleton in ophiuroids can now be equated with known structures in somasteroids.

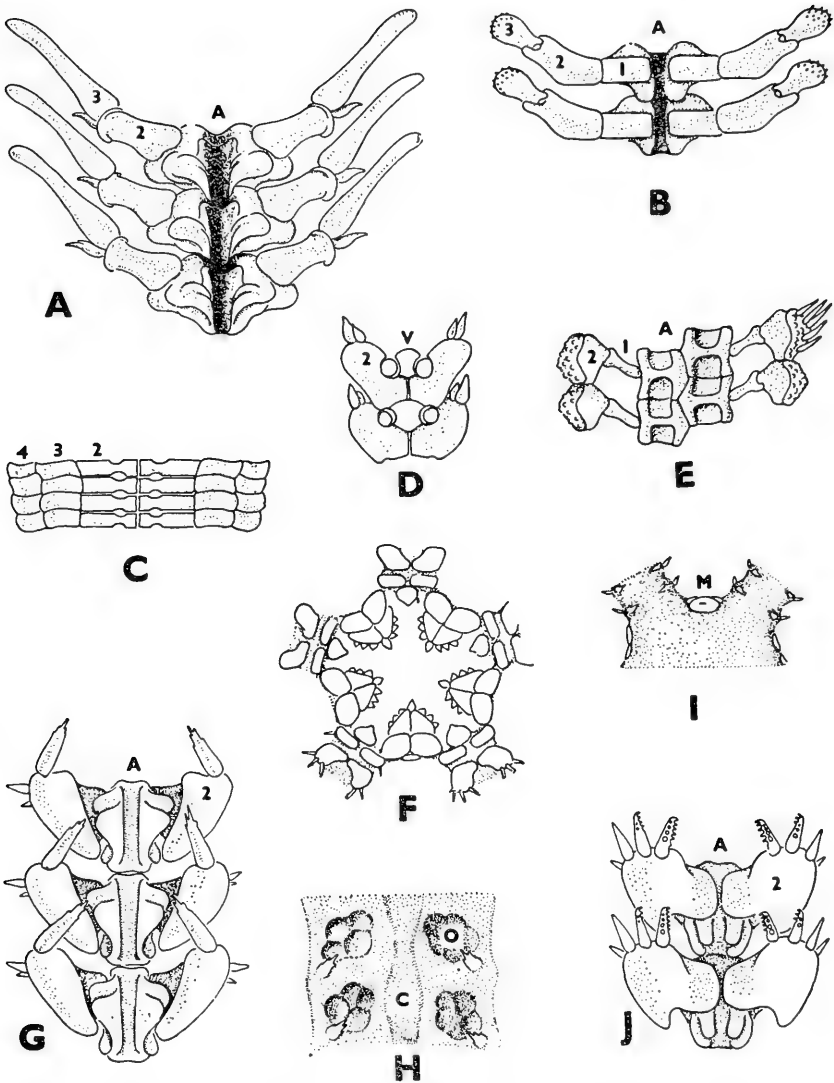

FIGURE 11.—Archaic brittlestars (Ophiuroidea), showing persistence of pinnate structure of somasteroid type, and presence of reproductive and alimentary organs in the arms; for further explanation see text. A, *Asteronyx*. B, *Trichas* *er.* C, *Astrophyton*. D, modern type of brittlestar (*Ophiomastus*) for comparison; E, *Eophiura*. F–J, *Ophiocanops* (Oegophiurida). Abbreviations: A, ambulacral ossicles (fusing to form vertebrae); C, caecum of stomach extending into arm; M, madreporite; V, ventral arm plate; 1, first virgulum (V-1, sublateral plate); 2, second virgulum (V-2, lateral plate); 3, third virgulum (V-3, primary radiole); 4, presumed fourth virgulum (V-4). In *Astrophyton* the ambulacral elements are concealed beneath the second virgalia. F shows the disk in ventral aspect, G the arm skeleton in dorsal aspect, H the arm *in toto* in dorsal aspect, I the disc in dorsal aspect, J the arm skeleton in ventral aspect, all in *Ophiocanops*.

A SURVIVING OEGOPHIURID

Now, in the discussion hitherto, I have restricted the argument to hard parts. It is however, possible to correlate the soft parts with the skeleton and to make some inferences as to what the soft parts probably were like in the ancient forms. In figure 11, F-J, is shown one of the most interesting results of such correlation, for the animal illustrated proves to be another living member of a group of echinoderms hitherto believed to have died out in the middle Paleozoic. It was isolated in this way: Once it was established that Luidiidae represent an ancient grade of asteroids, it became evident that the original condition of the reproductive glands must have been a serially paired disposition of separate gonads along the arms, not in the disk as in modern forms. Further, *Platasterias* showed that the caecum of the stomach, which extends into the arms in asteroids, is also present in somasteroids, and must therefore be another ancient character. Now in one surviving genus of ophiuroids, *Ophiocanops* of Indonesia, Mortensen (1932) had already shown that serially paired gonads occur in the arms, and that there is a stomach caecum in each arm, as in asteroids. Also, in those ophiuroids where conspicuous pinnate structure occurs in the skeleton, I found that the gonads enter the arm. Hence there were compelling reasons for believing that *Ophiocanops* must be a very archaic form, for it had even more archaic characters than did the pinnate ophiuroids which I had dissected. Could it be that this genus was wrongly classified?

A few months ago (1962), with the kind cooperation of the Copenhagen Zoological Museum, I was enabled to dissect the skeleton of a paratype of *Ophiocanops*. It proved to have all the characteristic features of the mid-Paleozoic Oegophiuroida. There are neither dorsal nor ventral arm plates (fig. 11, G, J), the madreporite lies at the edge of the disk (fig. 11, I), there are no bursae and no genital plates, and most parts of the skeleton can be homologized with somasteroid elements. It is therefore now apparent that the possession of a stomach caecum in each arm, and serially paired branchial gonads, is really part of the diagnosis of these ancient ophiuroids. The original radial groove of somasteroids is still present, but is covered over by a sheet of integument on the ventral side of the arm (fig. 12, A, B). This must surely be regarded as most encouraging evidence that the general lines of our hypothesis are fundamentally sound, for this is the first time that we have been able to infer from the *soft parts*—I stress *soft parts*—that a certain form must fall in a fossil assemblage, itself known only from hard parts. The hard parts of *Ophiocanops*, when dissected, provided the proofs of the whole hypothesis, for they exhibit the predicted archaic condition already known from the Paleozoic fossils. These data have been privately studied by my col-

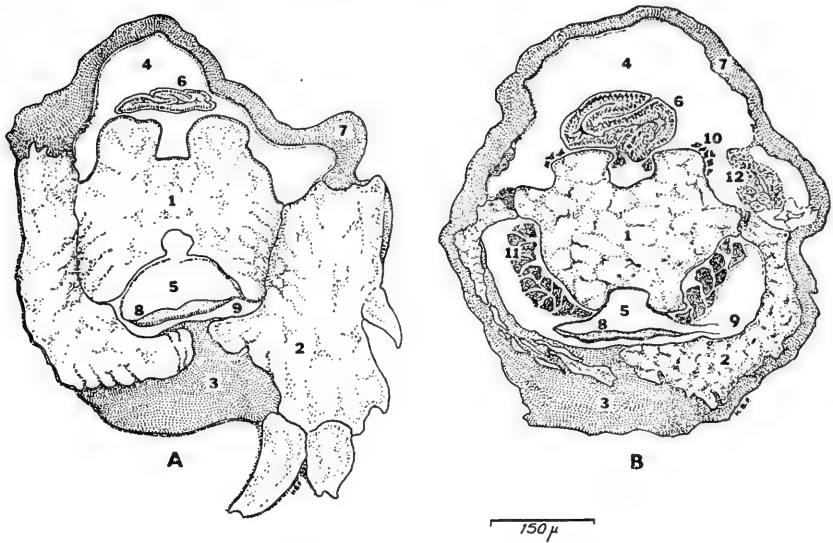

FIGURE 12.—*Ophiocanops fugiens* (Oegophiurida), cross sections of the arm showing ordinal characters. Abbreviations: 1, vertebra; 2, lateral plate; 3, ventral tegumentary muscle; 4, dorsal coelom; 5, ventral coelom (ambulacral vessel possibly destroyed, lost during sectioning, apparently very small if present); 6, dorsal caecum of stomach; 7, dorsal integument; 8, radial nerve; 9, subneural ("epineural") canal; 10, dorsolateral muscle; 11, ventrolateral muscle; 12, ovary and part of oviduct. (Drawings from sections cut by A. G. Clark, from specimen in Copenhagen University Museum.)

leagues C. W. Wright and Georges Ubachs, and both at once informed me that they concur with my conclusions, and that *Ophiocanops* is indeed another example of the unsuspected persistence of archaic Paleozoic groups.

Figure 13 illustrates cross sections of the arm in three major groups of ophiuroids; A shows one of the lower Paleozoic Stenurida, such as *Eophiura* (also shown in fig. 11, E, in ventral aspect). In figure 13, B, is a typical oegophiurid, and comparison with figure 12 indicates that the ventral groove (labeled 4) would be sealed over by muscle, not open (as hitherto supposed). Figure 13, C, shows a typical member of the Ophiurida, the last order to appear in the fossil sequence, and the one to which all modern forms are assigned (save for *Ophiocanops*).

ALL ASTEROZOA FUNDAMENTALLY PINNATE

Returning once again to our main theme, which is the phylogeny of the echinoderms, it is now to be stated that all known star-shaped echinoderms are fundamentally pinnate forms, and can be traced back to somasteroid ancestors. A detailed analysis of the inferred evolution sequence is given in another paper (Fell, in press). It follows that the apparent differences between the pluteus larva of

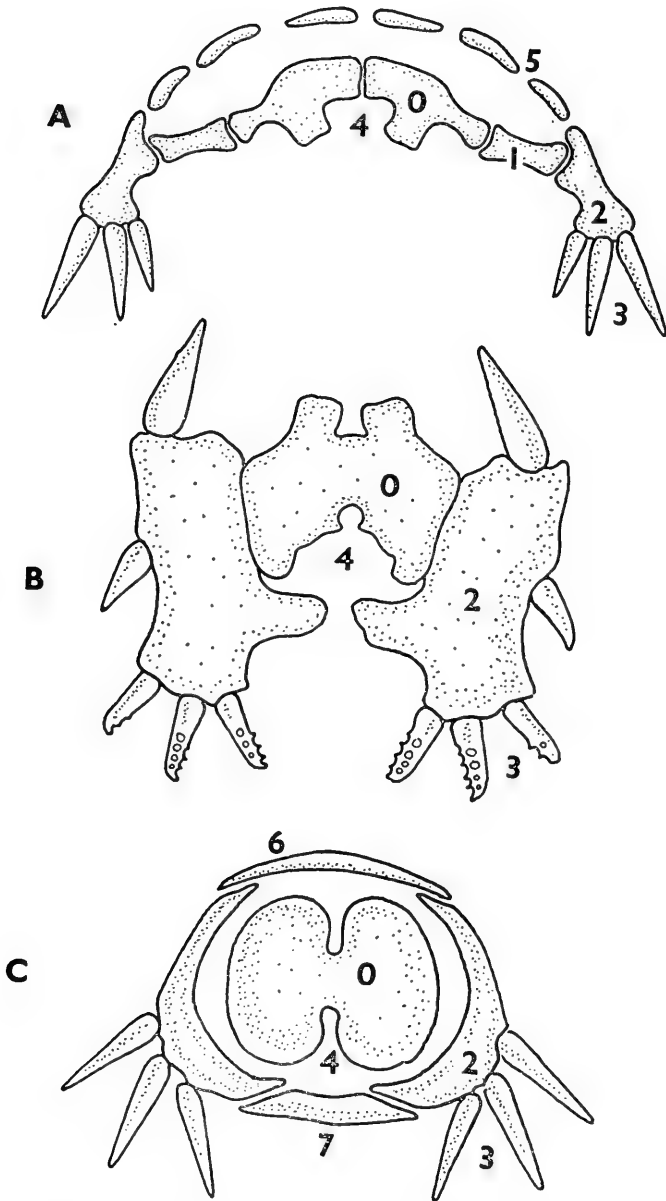

FIGURE 13.—Skeletal characters of three orders of Ophiuroidea. A, Stenurida. B, Oegophiurida. C, Ophiurida. Abbreviations: 0, ambulacral element (vertebra); 1, virgali-um-1 (sublateral); 2, virgali-um-2 (lateral); 3, spines of lateral plate; 4, radial groove; 5, primitive plates of dorsal integument; 6, secondary dorsal plate; 7, secondary ventral plate. Compare with Figure 12.

ophiuroids and the auricularia larva of starfishes cannot have any broad phylogenetic significance, and by the same token the close resemblance of the pluteus larva of ophiuroids to the pluteus larva of echinoids cannot mean any relationship between echinoids and ophiuroids. Not the slightest trace of any fossil intermediate between ophiuroids and echinoids has ever been found, whereas we have found abundant and overwhelming evidence of the direct relationship of ophiuroids and asteroids through common pinnate somasteroid ancestors, whose fossil remains we now possess in considerable number and variety.

A further point now emerges, which goes some way toward solving the impasse mentioned earlier, by which it appeared that indirect development must be older than direct development, since some forms with direct development have vestigial larvae. Although we still know nothing of the embryology of *Ophiocanops*, many features of its anatomy declare its affinity to the Ophiomyxidae, a group of ophiuroids in which absolutely direct development occurs, without any trace of a larva at all. On the other hand, those genera of Ophiuroidea which have vestigial larvae have now been shown to fall in families of relatively late derivation, from groups which have pelagic larvae. They are groups with numerous secondary features in the skeleton, far removed from the archaic forms with somasteroid-like features. Thus it is now extremely probable that there are two quite distinct types of direct development in ophiuroids, one ancient, with no vestige of a larva, the other secondary and showing both by the vestigial larva and by the characters of the skeleton that it is of late origin. I now suspect that the pluteus larva will eventually be proved to be a feature evolved by ophiuroids *after* the separation of ophiuroids from the somasteroid line, and that the pluteus of echinoids is an entirely independent development of that group. It is most urgent to ascertain the nature of the development in *Ochiocanops*, as also of course in *Platasterias*.

An analogous situation exists in regard to pedicellariae, which can be proved to have originated in the Asterozoa as a late development, subsequent to the differentiation of the Luidiidae. They occur in no other subclass of Asterozoa. It is thus obvious that the superficially similar pedicellariae of echinoids are an entirely independent development, most of which has occurred subsequent to the differentiation of the Cidaroida, which are the oldest surviving echinoids.

ORIGIN OF ASTEROZOA

We can further elucidate stages in the evolution within the Asterozoa by interpolation between fixed points on our frame of reference. What happens if we now attempt to extrapolate backward, in search of the ancestry of the somasteroids themselves?

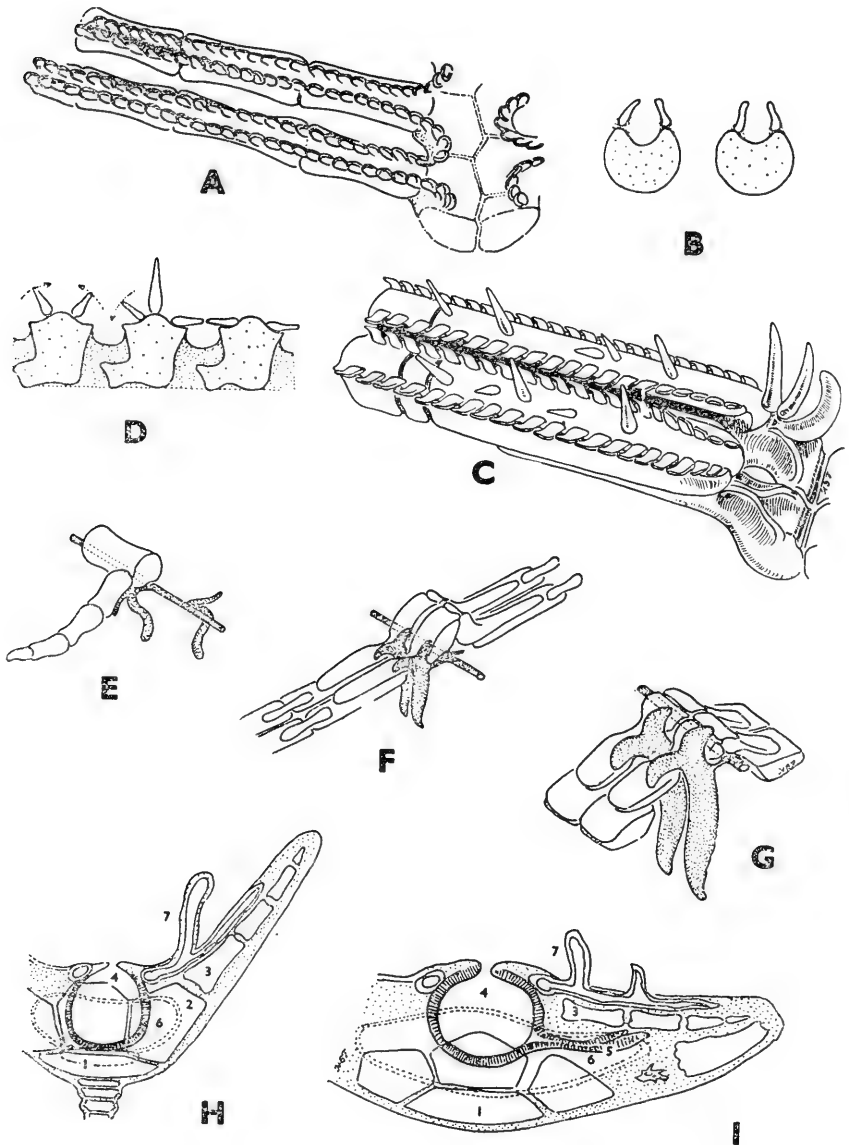

FIGURE 14.—A, biserial crinoid. B, cross section of pinnules in A. C, *Platasterias*, and D, cross section of metapinnules of same; E, developing pinnule and tentacle in young crinoid; F, tentacles (tube-feet) in *Platasterias*, G, tube-feet in *Luidia*. H, optical section of developing pentacrinoid stage of young crinoid; I, similar aspect of young asterozoan. Abbreviations: 1, centrodorsal; 2, radial plate; 3, proximal brachial (ambulacral) element(s); 4, stomach; 5, caecum of stomach; 6, perivisceral coelom; 7, tube-foot (tentacle).

In ventral view, the arm in *Platasterias* exhibits transverse grooves between the rows of virgalia, and the grooves are seen to be guarded by rows of cover plates, held in connective tissue webs on either side of the virgalia, forming a sort of fringe. In the natural position, these fringes constitute the floors of the transverse ciliary grooves. But these webs are erectile. In plate 3 (1) we see a specimen in which the grooves are naturally exposed, when the webs are erected. The similarity to the condition in crinoids is quite striking. In figure 14, A, B, we see, above, two adjacent pinnules in a biserial crinoid, in which the cover plates and webs are seen forming the food groove on each pinnule, leading to the radial food groove. Biserial crinoids are now extinct. They differ from other crinoids in having two alternating series of brachial ossicles forming the arm. Below, in figure 14, C, D, is seen the corresponding region in *Platasterias*, with the cover plates in the normal down position. It does look rather as though the somasteroid condition must have arisen from the crinoid condition by the growth of interpinnular integument, forming new grooves *between* the pinnules, instead of *on* the pinnules, while the cover plates and webs accordingly turned outward, so as to cover the new interpinnular grooves. The opposite condition of the ambulacral ossicles, as already argued, must have arisen from an earlier alternating arrangement, as seen in some of the fossil somasteroids, and as seen also in biserial crinoids.

Figure 15 shows the relationship which may now be inferred between the crinoid arm and the arm of somasteroids and asteroids. Ophiuroids have been omitted only for lack of space. In figure 15, A, on the left is the normal monoserial arm, as seen in most crinoids. Pinnules are given off to left and right alternately. Students of crinoids have already demonstrated how the next stage, the biserial arm, arose from that. But this same stage (fig. 15, B) is almost precisely what we arrive at if we extrapolate backward from the chinianasteroid figure 15, C, using the frame of reference we have now established for all Asterozoa. We may therefore infer that the hypothetical "protosomasteroid" must have been a pinnulate pelmatozoan, and since crinoids are the only known pinnulate pelmatozoans, the ancestor of somasteroids must be identified as some crinoid.

Figure 14, E-G, which can only be briefly mentioned here, shows how the tube-foot in *Platasterias* (center) can be regarded as intermediate between the tentacle at the base of a pinnule in a young crinoid, and the much larger ampullate tube-foot of *Luidia*. In the young crinoid, when the pinnule begins to grow out, the radial water vessel produces at first only one tentacle; the others are added along the pinnule later. In the asterozoans only one such structure ever arises at the base of each row of virgalia. Ophiuroids have tube-feet

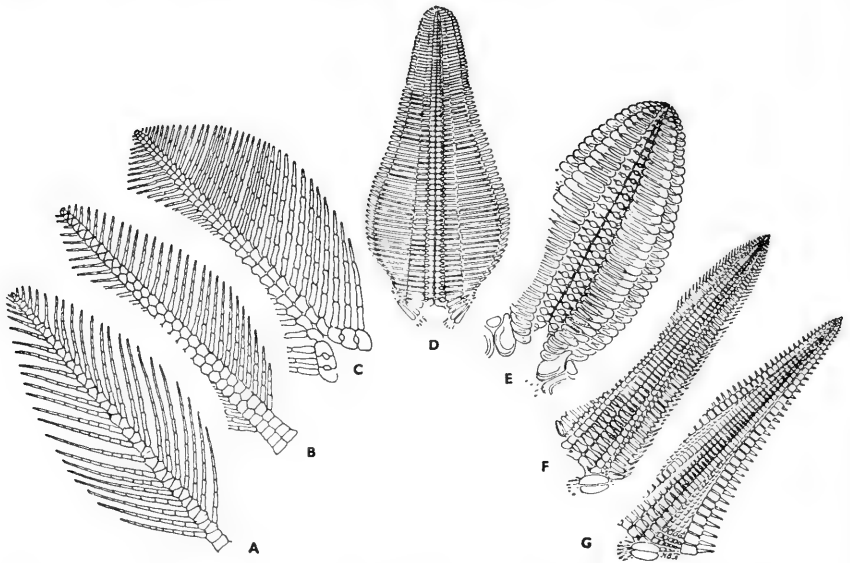

FIGURE 15.—Inferred relationship between arms of crinoids, somasteroids, and asteroids, in which dominant transverse growth gradients are gradually replaced by dominant longitudinal gradients. A, monoserial crinoid; B, biserial crinoid; C, chinianasterid somasteroid; D, platasteriid somasteroid; E, *Platanaster* (early platyasterid asteroid); F, *Luidia* (later platyasterid); G, *Plutonaster* (astropectinid asteroid).

that differ little from those of crinoids. It is evident that suckers are completely lacking, save in the late stages of development of specialized Asterozoa. On the other hand, in echinoids, where suckers also occur, they are already present in the oldest grades of echinoids known to us, and dwindle in some late secondary groups of irregular urchins. Thus the affinities of the asterozoan tube-foot must be nearer that of Pelmatozoa than that of echinoids.

Figure 16 compares the embryology of the disk region of asterozoans with that of crinoids. Here again there is no space to go into details here, but it must suffice to state that essentially identical plates develop in both groups, in essentially the same sequence; but whereas the crinoid proceeds to elaborate them, the asterozoan nearly always discards them, or supplants them by later structures. Even in those asterozoans which in the adult have a naked disk, without plates at all, a complete series of calyx plates develop in the young stage, only to vanish again. In the upper two rows are shown two main types of calyx (with and without persistent basal plates), in each case left-hand and middle examples are young crinoids, and the right-hand member of each row is a comparable asterozoan. However, the calyx in the third row is no crinoid at all, but the ophiuroid *Ophiopyrgus*, of which the single known specimen now lies in the British Museum, and was reexamined recently at my request by Miss Ailsa Clark,

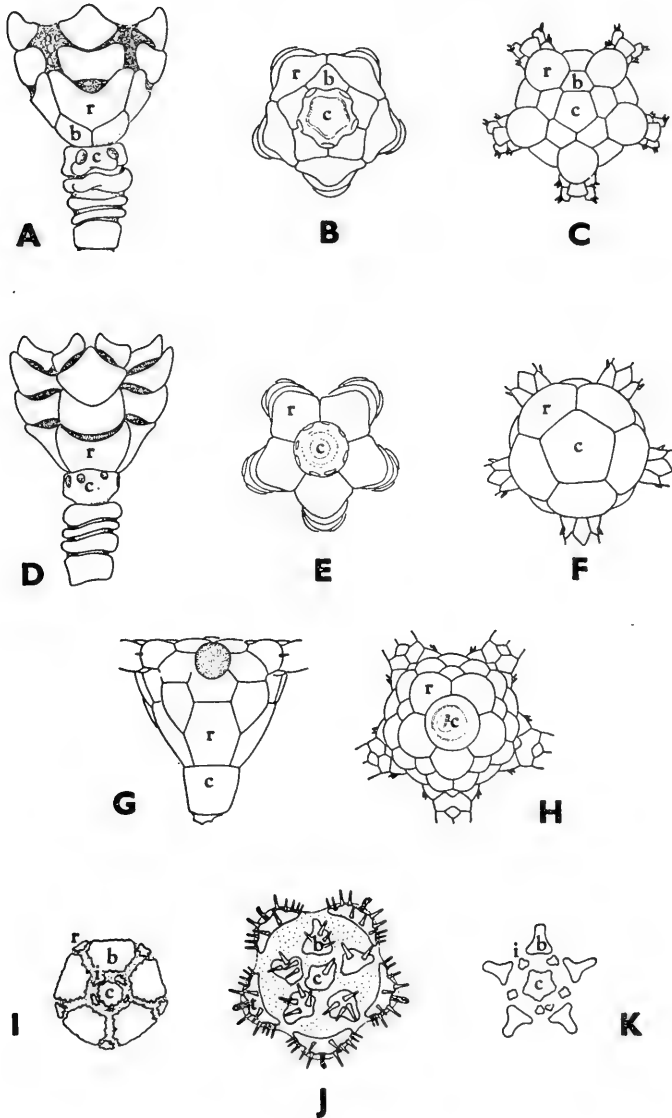

FIGURE 16.—Calyx in crinoids and asterozoans, at comparable early stages of development.

A, lateral aspect, and B, dorsal aspect, of *Promachocrinus*, showing basals. C, corresponding calyx in the ophiuroid *Ophiosteira*. D, E, similar views of the pentacrinoïd stage of *Eumorphometra*, with suppressed basals, and F, corresponding calyx in the ophiuroid *Ophiomastus*. G, H, corresponding calyx in the ophiuroid *Ophiopyrgus*. I, calyx of young crinoid showing late (postbasal) development of infrabasals. J, K, late (post-basal) development of infrabasals in asteroid *Asterina*.

whose sketches are here used. You will note that the centrodorsal even seems to have a vestige of a stalk, though Miss Clark could not be sure what the structure may represent. Perhaps an asterozoan may yet survive with a stalked pentacrinoid stage. The bottom row of illustrations shows how infrabasals develop in crinoids and asterozoans at early stages of development. Thus, exactly comparable variations in the structure and modification of the calyx occur in young crinoids and in young asterozoans at equivalent stages, the radials, basals, and infrabasals being evidently subject to the same laws. Young stages of hundreds of species of asterozoans are now known, and every one without exception has been found to have a calyx. The conclusion is surely inescapable that the skeleton in crinoids and asterozoans is built to the same fundamental plan, namely a cup-shaped central body, dominated by meridional gradients, from which radial gradients emerge and tend to become pinnate.

Figure 14, H, compares the pentacrinoid stage of a crinoid with the equivalent stage in an asterozoan (fig. 14, I). In the crinoid, the main radial gradient passes from the radial plate of the calyx (numbered 2) directly into the first brachial ossicle (numbered 3), and so outward through the successive brachial ossicles. Thus the arm plates rest upon the radial plate of the calyx without any interruption. Consequently, the gut is necessarily restricted to the central region of the body. In the asterozoan, on the other hand, the first arm ossicle (that is, the ambulacral ossicles, here numbered 3) is dislocated adorally, so that all the brachial ossicles come to lie in a nearly horizontal series, separated by a gap from the radial plate of the calyx. During development the two first arm skeletal elements actually migrate into the jaw, to which they contribute, while growth of the disk and insertion of secondary dorsal plates widens the gap between the original radial plate and the first arm ossicle. Thus it is that the gut can send a caecum outward into the arm, carrying with it as it goes an envelope of perivisceral coelom. Thus it is by no means difficult to understand how the asterozoan arm could arise from the pelmatozoan arm, for in the very life span of asterozoans still living we can observe the action of the processes we postulate. That the earlier embryologists were unable to interpret the data in this way was because they had studied only genera of families which we now can prove to have been late derivatives, loaded with secondary dorsal and ventral plates, completely concealing the course of the original radial gradients. Thus secondary plates, such as asteroid carinals and ophiuroid dorsals, and terminal plates of the arms, were mistakenly supposed to continue the series started by the radial plates of the calyx. In fact, no carinals and no dorsals ever develop in the groups of asteroids and ophiuroids which have now been isolated as the archaic ones, and none whatever occur in somasteroids. Terminal

plates are a post-chinianasterid development, not part of the calyx. It is highly probable that the origin of asterozoans from crinoidlike ancestors came about through a dislocation of the main radial gradient of each arm, so that proximal brachial elements were deflected adorally, to give rise to the jaw. The change in feeding habits which the acquisition of jaws made possible would lead to the change in orientation, though some asterozoans still retain the ancient attitude, in which the mouth is directed upward, and the arms sweep through the overlying water.

MAJOR GRADIENT PATTERNS IN ECHINODERMS

Figure 17 illustrates diagrammatically the two major patterns of dominant gradients which may be recognized in echinoderms. The upper diagrams show the essentially meridional pattern established in young echinoids and young holothurians. During metamorphosis, the hydrocoel encircles the gut, and then sends out five meridional water tubes which encircle the body. Thereafter the whole skeleton and nervous system, as well as the hydrocoel itself, differentiate under the same meridional gradients, and new meridional ones are established in the interradial. The lower diagrams show the contrasted system based on dominant radial gradients. This is found in young crinoids, asteroids, ophiuroids, and somasteroids. Instead of growing along meridians, the water tubes are thrust outward in the horizontal plane, as five spokes radiating from the mouth, carrying the body wall and coelom with them, as five finger-shaped processes, which become the arms. The whole skeletal, nervous, and hydrovascular system thereafter differentiates under the influence of these five major radial gradients, with pinnate gradients arising as a secondary lateral growth from the main radial gradients, these pinnate gradients suffering all manner of slipping and dislocation as already inferred, eventually giving rise to radial longitudinal fields in late asteroids. The calyx alone retains the ancient meridional system.

Thus, I would now argue that the clue to the phylogeny of echinoderms lies in the postmetamorphic stages, which alone are directly comparable with, for example, the young stages of Crustacea. A newly metamorphosed sea star bears the same relation to its adult as say a nauplius or metanauplius does to its adult. On the other hand a pluteus or an auricularia is a totally different kind of creature, with different symmetries, orientation, and habits. The phylogenetic perplexities which led to such sterility in echinoderm studies came in when secondarily evolved larval forms were mistakenly taken to be ancestral patterns of development. This supposition did not elucidate one single fact of echinoderm phylogeny, and only led to the complete divorce of echinoderm paleontology from echinoderm embryology.

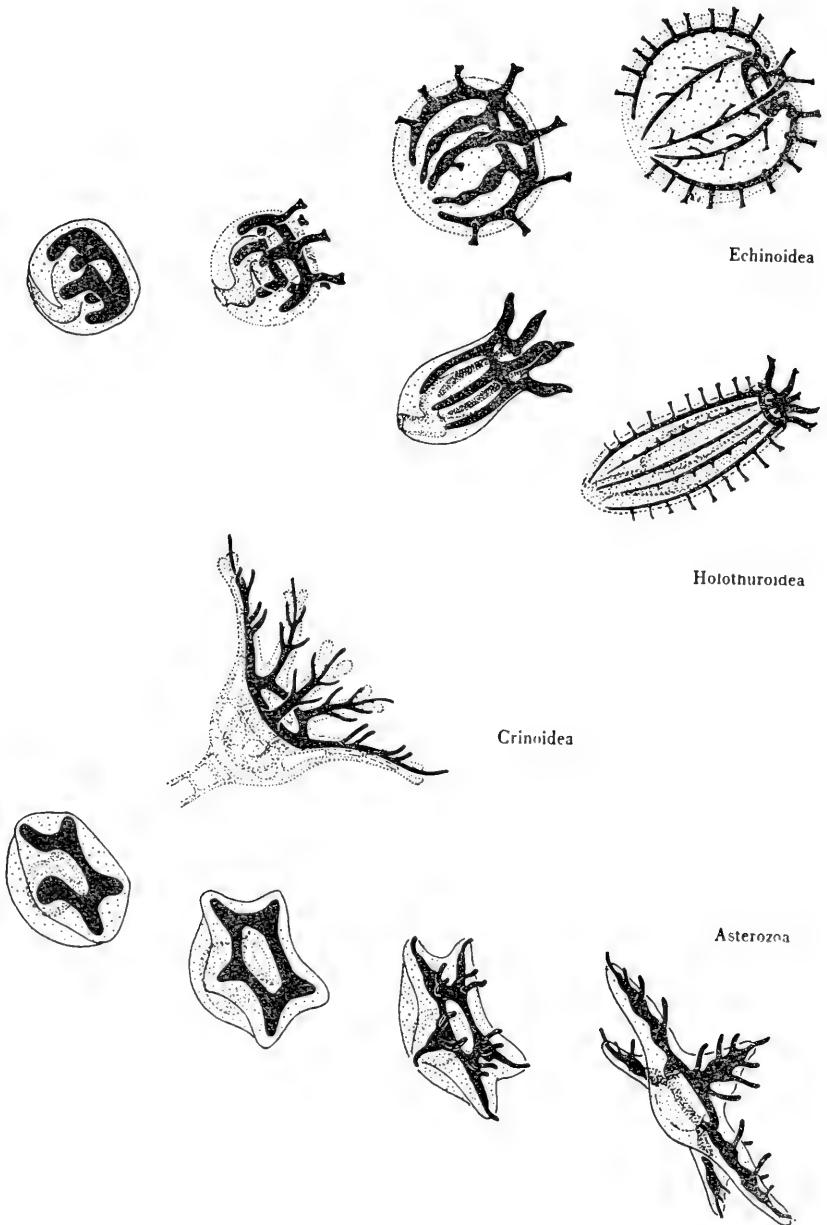

FIGURE 17.—Dominant gradient patterns established by the hydrocoel, and subsequently adopted by the other organ systems, in echinoderms. Early postmetamorphic stages lie to the left, and succeeding stages in the named groups appear on the right. Above, meridional gradients (Echinozoa). Below, radial gradients (Crinoidea and Asterozoa).

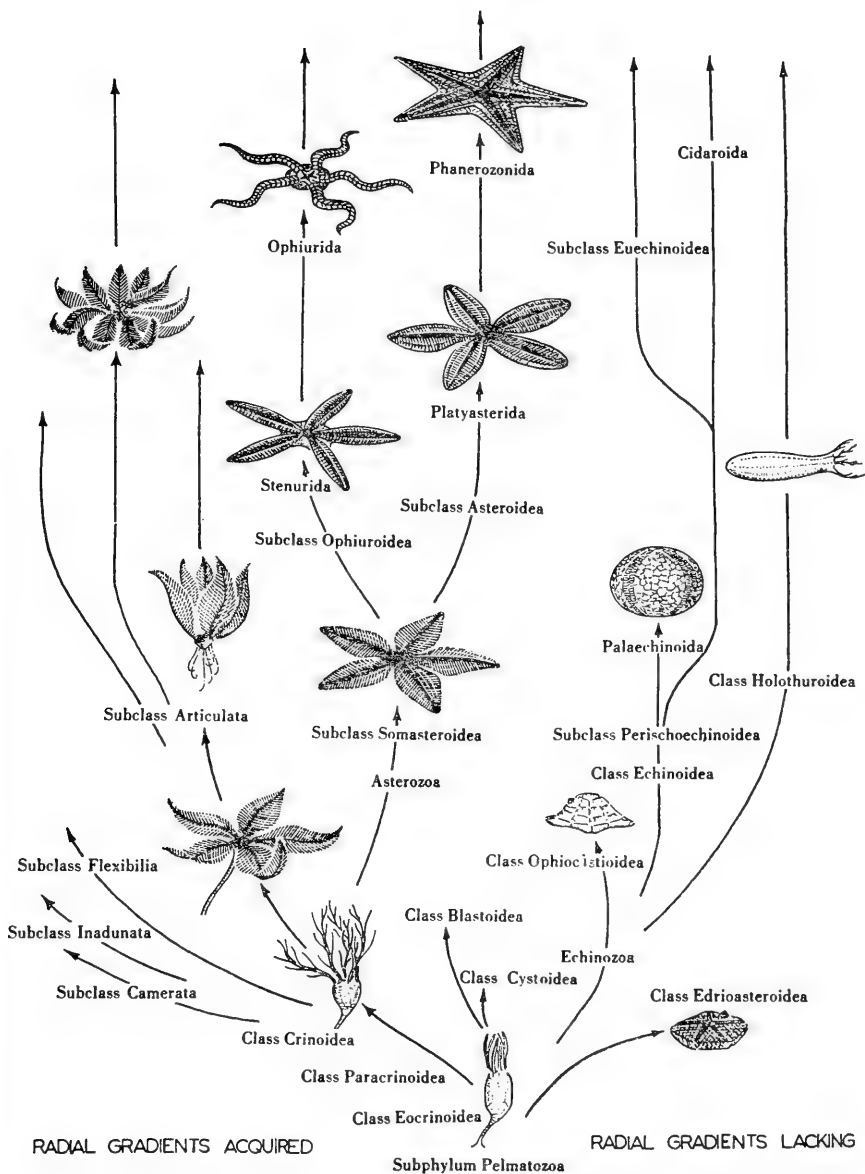

FIGURE 18.—Classification of echinoderms based on growth gradient fields in postlarval stages, as inferred from the evidence summarized in this paper.

The two should not be at loggerheads in this way, and need not be, if the data are handled in the way here advocated.

If the postlarval stages alone are a guide to phylogeny in echinoderms, as I have always believed and advocated, the entire picture returns to its focus, and acquires once more that definition which it lost when larval embryology took control after 1900. The clarity of the picture enables predictions to be made and, as now twice demonstrated, the predictions can be tested and confirmed.

It is now evident that the conventional classification into Eleutherozoa of all free-living echinoderms is inadequate. The assemblage is made up of two quite different stocks, of different age and different derivation, and to maintain Eleutherozoa as a formal unit of classification will merely conceal the true relationship between included and excluded classes.

PHYLOGENY

Although the details are not quite finalized, figure 18 indicates the general proposals which now seem reasonable. It is proposed to replace the old subphylum Eleutherozoa by two new subphyla, the Asterozoa and Echinozoa, whose content is illustrated in the diagram. Their inferred relationships are approximately indicated on the diagram, in which, of course, the time scale is necessarily distorted. No such proposals can possibly be definitive, and we may be sure that many modifications will become necessary with new discoveries. I am confident, however, that by abandoning the Eleutherozoa as a unit, and by transferring the stress to dynamic processes governing the growth of postlarval stages, the way will be opened to a more fruitful line of investigation in future. As for the larval stages themselves, surely they can only be secondary, late-evolved stages of development, specially adapted to meet temporary conditions in a planktonic phase of development, so that they are examples of "clandestine" evolution, giving no direct indication of the structure or the habit of the ancestral stocks from which echinoderms descend.

REFERENCES

(Note: References prior to 1962 are given in the first item below.)

FELL H. BARRACLOUGH.

In press. Phylogeny of sea-stars. *Phil. Trans.*, ser. B.

1962a. *Science*, vol. 136, pp. 633-636.

1962b. *Univ. Kansas Paleont. Contr.*, Echinodermata: vol. 6.

1962c. *Zool. Zhurn. Akad. Nauk. S.S.S.R.*, vol. 41, No. 9.

1962d. *Publ. Seto Marine Biol. Lab.*, vol. 10, No. 2.

1962e. *Tuatara, Journ. Biol. Soc. Victoria Univ.*, Wellington, vol. 10, No. 3, pp. 138-140.

1962f. *Native sea-stars of New Zealand* (A. H. and A. W. Reed).

Mangroves: Trees That Make Land

By WILLIAM M. STEPHENS

[With 4 plates]

WHEN Columbus discovered the New World he noticed a strange kind of tree growing in shallow salt-water lagoons, its trunk held above the surface by arching, stiltlike roots. In the Gulf of Batabano, on Cuba's south coast, Columbus wrote in his ship's log that the trees were "so thick a cat couldn't get ashore."

A century later Sir Walter Raleigh, while searching for the land of El Dorado, found the same kind of tree at the mouths of rivers in Trinidad and Guiana and noted that the trees had "oysters upon the branches." The oysters, he said, were "very salt and well tasted" and were found only "upon those boughs and sprays, and not on the ground."

Tourists who visit tidal areas in the Tropics where mangrove trees flourish continue to be astonished at the spectacle of oysters "growing on trees." These coon oysters, which attach themselves to the prop roots of the red mangrove, where they are often exposed at low tide, are not generally considered a delicacy today, except, perhaps, to raccoons, but they are quite edible.

The tree described by both Columbus and Raleigh was the red mangrove (*Rhizophora mangle*), which is found throughout the New World Tropics. Closely related species grow in Indo-Pacific regions. All trees of the genus *Rhizophora* have the distinctive prop roots, that look to some observers like the legs of monstrous spiders wading in shallow water. They are, according to some botanists, the only "true" mangroves. Red mangroves are important land builders, pioneer trees that start new islands and extend old shorelines. They are always found in or near the water. Other mangroves (of which there are only two in the New World: the black mangrove, *Avicennia nitida*, and the white mangrove, *Laguncularia racemosa*) are usually found farther inland.

¹ Reprinted by permission from Sea Frontiers (Magazine of the International Oceanographic Foundation), vol. 8, No. 4, October 1962.

TREE THAT MIGRATED INTO THE SEA

Botanists are in disagreement over what constitutes a mangrove, since the name "mangrove" itself relates more to habit than form. Generally speaking, mangroves are plants that can live in loose, saturated, salty soils; they have respiratory roots and produce seeds that are more or less viviparous—that is, the seeds germinate while still attached to the parent tree. Some scholars suggest that mangroves are primitive plants that evolved in shallow seas and never managed to move inland. But as mangroves belong to the highest order of plants, the fruit-bearers, the prevailing opinion is that these unique trees developed on land and later began their return to the sea.

In one sense they have completed their return to the sea and might be considered marine plants; for the red mangrove is capable of living, growing, and reproducing without the aid of either "land" or rainfall; it can exist hundreds of miles from the nearest true shoreline (but must, of course, be in quite shallow water for its roots to find a foothold).

But in another sense mangroves cannot be considered strictly marine plants, for they grow best in brackish water—near the mouths of rivers, for example—and can sometimes be found in virtually fresh water. Laboratory tests, in fact, show that some mangroves can live and grow for years in water that has no detectable trace of salt.

The way in which the red mangrove, *Rhizophora mangle*, propagates itself is quite remarkable. When each fruit matures, the embryo of a new plant begins to grow inside it. A slender, spikelike root emerges and grows to a length of 6 to 12 inches while still hanging from the tree. When it falls, the seedling, which resembles a green wooden dart whose lower end has been dipped into copper paint, may stick into mud and send out rootlets and soon become anchored to the spot. But most seedlings will float away with the tide before secondary roots develop.

The seedlings may drift for hundreds—or even thousands—of miles, remaining alive for a year or longer and sometimes even producing secondary roots and top growth while afloat. At first they float in a horizontal position, but as they grow older they swing more and more to the vertical. After a month most are floating vertically, the root end downward, ready to take root if it comes into contact with the bottom.

The saltier the water, the longer the seedlings will float. Even those that eventually sink may occasionally survive, since tests show they may live a year or longer while totally submerged. If they sink in water no deeper than 2 or 3 feet, they may root in the bottom, send a thin shoot to the surface, and then produce leaves.

The mortality of seedlings is undoubtedly high. In one afternoon of prowling through a Florida mangrove swamp at low tide, hundreds

of seedlings were found that had begun to rot and seemed to be dead. There were about a hundred that had recently rooted and had already produced a pair of leaves at the apex, and literally thousands more that had recently fallen and would probably grow if the tides shifted them to a somewhat erect position or carried them away to a less-crowded spot. Some of these fresh seedlings produced rootlets in a week's time after they were placed in upright cans of mud. This was in September, at the end of the main seed-producing season in south Florida. Most seedlings are produced in July and August, although some are produced all year.

MILLIONS OF YOUNG

Dr. John H. Davis, of the University of Florida, to whom any writer who discusses mangroves owes a considerable debt, states that an "average vigorous red mangrove tree produces over 300 seedlings during a summer season, and probably over half of these float away from the swamp." Obviously, then, many hundreds of thousands of seedlings—if not millions—are set adrift each year in Florida alone.

Ocean currents are undoubtedly responsible for the wide distribution of mangroves. The three American species are found on the west coast of Africa (where they probably originated) and, interestingly, on both coasts of Central America and in the Galápagos Islands. How they got into the Pacific is a perplexing question. Most botanists doubt that the seedlings migrated around Cape Horn, and fossil records indicate that mangroves evolved after the Panama land bridge rose. In recent years the American red mangrove has also been found in Hawaii, where mangroves are not native but where both Old World and New World species now grow. It has also been reported from Fiji, Tonga, and even from atolls in the Indian Ocean.

Once the seedling becomes anchored, it grows rapidly, its height increasing as much as 2 feet the first year. During the second year it sends out prop roots, which extend outward from the trunk in successively widening circles. After 3 or 4 years the tree is braced so securely that it can withstand almost any storm. In addition to the main prop roots, aerial roots may drop from branches, forming secondary trunks with their own prop roots.

TREES AND CORAL REEFS

Mangroves are often popularly associated with coral reefs, but while corals and mangroves do in fact exist in close proximity—particularly in Indo-Pacific regions—they thrive best under quite different conditions. Reef-building corals need clear ocean water which contains little sediment and is in continual motion, while mangroves do best in still, protected, sediment-laden water. Corals require fairly salty water and may be harmed by a drastic change in salinity in either

direction. Mangroves prefer brackish water but can tolerate a wide range in salinity from virtually fresh to extremely salty water. Reef corals cannot live long in water that falls below 70° Fahrenheit, while mangroves thrive in much colder water. At Galápagos, for example, the water temperature is frequently in the 50's, owing to the cold Humboldt current, yet all three species of American mangrove are found growing. On the other hand, a drop in air temperature to 25° Fahrenheit is almost certain to kill mangroves—while, of course, a drop in air temperature per se has little or no effect on corals, unless followed by a drop in water temperature.

Although, obviously, the conditions under which corals and mangroves can exist together are far from the optimum conditions for either, both play important roles in creating tropical real estate—and, in a sense, they often work together. Normally, the corals must first do their work, however, producing conditions where mangroves can grow.

Young mangroves must have protection from waves and currents. On beaches exposed to surf, or on bars and flats where currents are strong, the seedlings cannot gain good footholds. They may root in such areas and hang on for months but are almost sure to be killed or swept away by wind, water, or shifting sands before reaching maturity. If, however, a shore or a shoal is protected by a coral reef, the mangrove seedlings can establish themselves.

MANGROVES MAKE NEW LAND

Thus mangroves may become established on the inside of a coral reef, where relatively still water is found, sedimentation is rapid, and debris accumulates. These, of course, are conditions that live corals cannot tolerate; so the mangroves take up where the corals leave off. As the reef corals continue to grow outward, toward the sea, the mangroves grow along the rubble-strewn inner edge, trapping in their great spreading roots the seaweed, sponges, shells, chunks of dead coral, and other material that washes over the reef. By reducing the flow of water, the mangroves aid further in the buildup of sand, marl, and other deposits.

As the mangrove colony increases, broken limbs and roots from the trees decay and form peat; and the land may be further built up by calcareous algae and the shells of mollusks and crustaceans that live among the roots. Birds may roost in the trees and leave deposits of guano. Other species of mangrove may become established in the swamp, as well as other salt-marsh plants. As the land becomes higher, coconuts may float ashore and take root, as well, perhaps, as the seeds of the sea hibiscus, or mallow. In Indo-Pacific areas, screw-pines and casuarinas are frequently found near the mangroves, while in the Americas the seagrape is often present.



1. Oysters grow on trees in southern Florida, particularly on the prop roots of mangroves. At low tide they may be completely exposed, making it easy for the seafood fancier to pick his dinner. (Photo by the author.)



2. Seeds of the red mangrove germinate while still attached to the parent tree. Each fruit sends out a long, slender primary root that reaches a length of 6 to 12 inches before falling. After dropping from the tree, these seedlings may stick in the mud and soon develop secondary roots. Most seedlings, however, are carried away by tides and currents and may drift for months before sinking or floating into shallow water where they can take root in the bottom. (Photo by the author.)



1. These mangrove seedlings, having begun their germination while still hanging from the parent tree, have dropped into water shallow enough for them to take root. A vast number of the seedlings are carried out to sea or fall into water too deep. (Photo by the author.)



2. Two species of mangroves are seen growing together in Biscayne Bay, 10 miles south of Miami. Black mangrove (*Avicennia nitida*) on the left has an extensive underground root system and sends up numerous pneumatophores, or breathing roots, that project from the mud and sand. Red mangrove (*Rhizophora mangle*) on right has characteristic prop roots and aerial roots. (Photo by the author.)



1. Red mangroves (*Rhizophora mangle*) have aerial roots dropping down from their branches as well as the characteristic prop roots. Coon oysters are seen growing on parts of the roots that are submerged at high tide. (Photo by the author.)



2. A forest of red mangroves (*Rhizophora mangle*) on Florida's Biscayne Bay at low tide. (Photo by the author.)



Eugene Shinn, an oil company geologist, examines algae in a shallow area where sedimentation is rapid, and where the start of a new island can be seen in the background. This picture was taken on the Atlantic side of Elliott Key, 25 miles south of Miami, Fla. Trees are red mangroves. (Photo by the author.)

In this manner—and over many, many years—an island may be formed on the leeward side of a coral reef.

Similar results may be produced near the mouths of rivers. (Here there are no corals, of course, for corals cannot live in brackish water.) Mangroves become established along the shores of rivers and on shallow bars formed by sand and mud carried downstream by the current and deposited at the mouth of the stream. Hundreds of mangrove keys may be formed near the mouth of a single river. Over a long period of time some of these keys may rise above the reach of high tide, producing conditions for the growth of mahogany, oak, and other hardwoods. A dense hammock may develop which may eventually become a part of the mainland.

1,500 ACRES OF TREE-MADE LAND

The land-building properties of mangroves are substantial in areas such as south Florida, where sedimentation is great. During his study of Florida mangroves, Dr. J. H. Davis found that about 1,500 acres of new land had been formed in Biscayne Bay and Florida Bay over a period of 30 to 40 years. (For the purposes of this estimate, Dr. Davis considered mangrove swamps to be land.) During this study it was found that the soil of many inland hammocks in the Everglades is composed largely of mangrove peat.

One of the greatest mangrove forests in the Western Hemisphere—and possibly in the entire world—is found in southwest Florida. Extending from the southern tip of the mainland up the Gulf coast to Marco, the forest includes the area known as the Ten Thousand Islands and the mouths of numerous rivers draining the Everglades. The actual number of mangrove islands is unknown, since the islands constantly merge and new ones are constantly born. Unlike the low, twisting trees of most mangrove swamps, the trees in this forest often grow straight and tall—near the mouth of the Shark River are red mangroves 80 feet high—but occasionally a tremendous tree extends almost horizontally for about 100 feet, its trunk supported by hundreds of aerial roots. Such trees may have been blown down in storms of many decades ago. Other trees, killed by hurricanes, stand upright, stark and white, like bleached skeletons.

Even the strongest winds rarely uproot the mangroves, but hurricanes may shake the trees so violently that the bark peels off, exposing the soft cambium layers to salt spray and waves, quickly killing the trees. The great storm of 1960, Hurricane Donna, killed thousands of large mangroves in southwest Florida—trees that had withstood dozens of previous hurricanes.

When observed from seaward a mature mangrove forest is like a massive green wall. Up close, twisting waterways are seen between the islands, often virtual tunnels with merging branches forming a

canopy. Exploring these islands on foot is a memorable experience—though few visitors leave their boats. The dark interior is a seemingly impenetrable maze of slimy roots growing from the mud and often armed with razor-sharp oysters. The air is humid and still, and the odor of peat and muck is strong. Even in the dry season, at low tide one may sink past his knees in the soft soil.

Sometimes there is dead silence in the swamps; other times there may be the constant whine of insects, the clicking of the shells of bivalves, the rustle of scurrying crabs, and perhaps the haunting cry of a limpkin. Pools of water are often rust-red, caused by tannic acid produced by the red mangroves. This tannic acid is believed to prevent teredos from infesting the submerged roots.

EVEN BEES LIKE MANGROVES

The larger trees will usually be found away from the shore. And here the black mangroves are often seen. The black mangroves have no prop roots, but the roots often form strong buttresses at the base of the trunk, and then, extending for long distances under the soil, they send up myriad pneumatophores—breathing roots—that project from the soil like pencils. The flowers of the black mangrove are rich in nectar, and bee keepers often place their hives in the swamps to obtain the highly prized mangrove honey. The smaller white mangroves, which also sometimes have pneumatophores, are seen in many Florida swamps, along with twisted, gnarled buttonwoods.

In many parts of the world, the timber of mangroves is economically important. The thick bark of the red mangrove is widely used in tanning leather; and in Jamaica the government has found it necessary to restrict the stripping of bark. A Trinidad botanist has estimated that a single red mangrove with a girth of eight feet (which is a giant of the species) will yield 1,000 pounds of bark. The heartwood of all three American mangroves is used in furniture work.

Perhaps the greatest importance of mangroves in Florida is their value in stabilizing and preserving shorelines. Many sections of shore might be washed away in severe storms without the protection of these unique trees. Studies might show that many shorelines now suffering erosion could be stabilized by plantings of mangroves.

The History and Relationships of the World's Cottons

By Sir JOSEPH HUTCHINSON

Professor of Agriculture, University of Cambridge, England

STUDENTS of the cotton plant enjoy the enormous advantage of a comprehensive work of reference: in 1907 Sir George Watt [27]² set out all that was then known of the botany of the plant and much of its agricultural history. Modern work on the crop began with S. C. Harland's analysis [11] of the nature of the species distinctions among the cultivated cottons, and led to studies of their origin and evolutionary history [15, 19]. Harland's work was, in addition, a major contribution to genetics.

Harland's study of the genetic nature of the species distinction led to the acceptance of four, and only four, species to embrace the whole vast diversity of the cultivated cottons. Between these four the primary distinction is in chromosome number. Two species, *Gossypium herbaceum* and *G. arboreum*, are diploid, with $n=13$ chromosomes; they are confined to tropical and subtropical regions of the Old World. Two species, *G. hirsutum* and *G. barbadense*, are tetraploid, with $n=26$ chromosomes, and it has been shown that, of this complement, half is homologous with the complement of the Old World diploids, and half with the complement of species of the genus growing wild in the New World. The tetraploid species were confined to the New World until they were spread, along with other New World crop plants, over the Old World in recent times.

These four species all bear lint hairs on the seed. The wild species of the genus also bear hairs on the seed, but these are short and scanty, and of a type that could not be spun. The term "cotton" is properly restricted to the lint-bearing species.

The commercial cottons of the present day are almost all short-term annual plants. They belong to a genus of perennial shrubs, and the primitive forms of the cultivated species are perennial shrubs; the

¹ Reprinted by permission from Endeavour, vol. 21, No. 81, January 1962.

² Figures in brackets refer to list of references at end of article.

annual forms have been bred and brought into use only in historic times. For a study of the development of the cottons, therefore, the primitive perennials, both wild and cultivated, are the natural starting-point. Primitive perennial types of the cultivated cottons are not difficult to find. The modern textile industry, consisting of great mills dependent for supplies on the cultivation of fairly uniform types over large areas, is of very recent origin, and in all the older cotton-growing countries the remnants of the old textile crafts are still to be found. The craftsman—spinning, weaving, and dyeing the cloth in traditional ways and on a small scale—draws his raw material from small plots, or occasional plants grown in gardens or house compounds. It was from these relics of village crafts that the primitive forms of the world's cottons were collected. They are to be found over wide areas in India and southeast Asia, in the Sudan and West Africa, and in the West Indies, Central America, and northern South America. They occur less commonly in the Pacific islands and even in northern Australia.

These cottons readily run wild and establish themselves in waste places and hedgerows, and on the margins of cultivated land. Watt and other early writers regarded many of them as truly wild, and ancestral to the cultivated cottons. In collecting, it became apparent that there was no line of demarcation between the wild plants of waste places; the occasional plants of house compounds and gardens that grew from carelessly scattered seeds but which were regularly harvested; and the true crop plants of neighboring fields. It then became important to decide whether the wild plant was the original from which the cultivated form was developed, or whether it arose as an escape into natural or seminatural vegetation from cultivated lands.

As our knowledge increased, so the number of forms that could be regarded as independent of human influence diminished. A. Chevalier [4] stated that, of the cottons now to be found in West Africa, none occurs in undisturbed vegetation, and all show signs of having reached their present habitat as cultivated plants. In the Sudan and Ethiopia [21], it is also clear that the cottons exist in association with man, and not wild in natural vegetation. Moreover, in no locality in India are the uncultivated forms of cotton to be found growing in anything like natural vegetation. They have, in fact, all the characteristics to be expected of the abandoned relics of the crops and crafts of an earlier culture.

The situation is similar in the New World. S. G. Stephens [17], collecting cottons in Central America, found that it was useless to look for material anywhere but in villages and on village lands. In the West Indian islands also, the cottons are to be found growing as commensal plants, preserved and harvested for domestic use even if not deliberately sown. There are a few reports of New World cottons

now growing wild in natural vegetation. J. B. Hutchinson [13] has given an account of the "*algodón brujo*" of the Salinas de Cabo Rojo in Puerto Rico, and O. F. Cook and J. W. Hubbard [5] recorded the existence of the plant they described as *G. morrilli* on coastal dunes beyond the limits of agriculture in northwestern Mexico. The success of primitive types of cotton in establishing themselves on waste land is such that it would be expected that they would sometimes spread into undisturbed natural vegetation, and Stephens [17] has given an account of the transition that is to be observed in Yucatan from domestic cottons to the ecotype that is established on the coastal sand dunes of the Progreso area; there, considerable specialization to the exposed maritime situation has taken place.

In South America also, accounts by E. K. Balls [19] indicate that the cottons found growing outside the present limits of cultivation are escapes and not truly wild plants. Even in the Galápagos Islands, the evidence from both herbarium material and from accessions established in the living collection is that there is a continuous range of form, from those closely similar to cultivated types in western South America to types evidently closely adapted to survival in the wild.

The evidence for the view that types of cotton now found wild are escapes from cultivation is so widespread, and the number of forms for which an origin by escape from cultivation cannot be demonstrated is so small, that in 1947 J. B. Hutchinson, R. A. Silow, and S. G. Stephens [15] set out to account for the origin and development of the cottons on the assumption that the whole process had gone on under domestication. This extreme view is no longer tenable [18], but truly wild cottons are so rare that the differentiation of the modern cultivated cottons is best considered in terms of the cottons that are now, or recently have been, cultivated. Consideration of these early cultivated cottons leads directly to the study of the origin and spread of the annual cottons. In fact, the success of the cottons as crop plants has depended very largely on the comparative ease with which annual types have been selected from the original perennial shrubby forms. The branching pattern of the cotton plant, with vegetative branches arising from the lower part of the stem and fruiting branches from the upper, lends itself to the development of annual forms. By selection of plants giving rise to fruiting branches low on the main stem, the vegetative period of the plant can be reduced, and flowering brought forward far enough to allow a crop to be matured on a spring-sown plant before the onset of cold autumn weather.

COTTONS OF AFRICA AND ASIA

Perennial cottons are confined to areas where there is no winter frost, since all cottons are frost-susceptible. Though they can survive a long dry season, the development of extensive commercial crops in areas of

seasonal drought has been much more successful with annual cottons. Consequently the development of annual types has made possible vast extensions of the area in which the plant can grow, and the subdivisions that have arisen in each of the cultivated species are best described as geographical races. In the cottons of the Old World, annual forms were first developed in *G. herbaceum* (fig. 1). In this species the most primitive, and only truly wild, form is race *africanum*; this is a perennial shrub found on the southern African bushveld across a belt of country from Mozambique to Angola and southwest Africa [18]. The most primitive cultivated forms are those found as occasional perennial plants in fields and gardens in Ethiopia [21], in southern Arabia, and on the coasts of southern Baluchistan; these are included in the race *acerifolium*. Inland in Iran, a characteristic group of annual forms has arisen, named race *persicum*. Farther north, where the summers are shorter and the winters colder, the species has given rise, by progressive adaptation to shorter seasons, to the *kuljianum* cottons of Central Asia that will mature a small crop in three months from sowing. The annual *persicum* cottons from Iran spread into western India, and provided the first annual cottons in Indian agriculture. The introduction can be dated, since it has been shown [19] that when Dr. Hove collected in

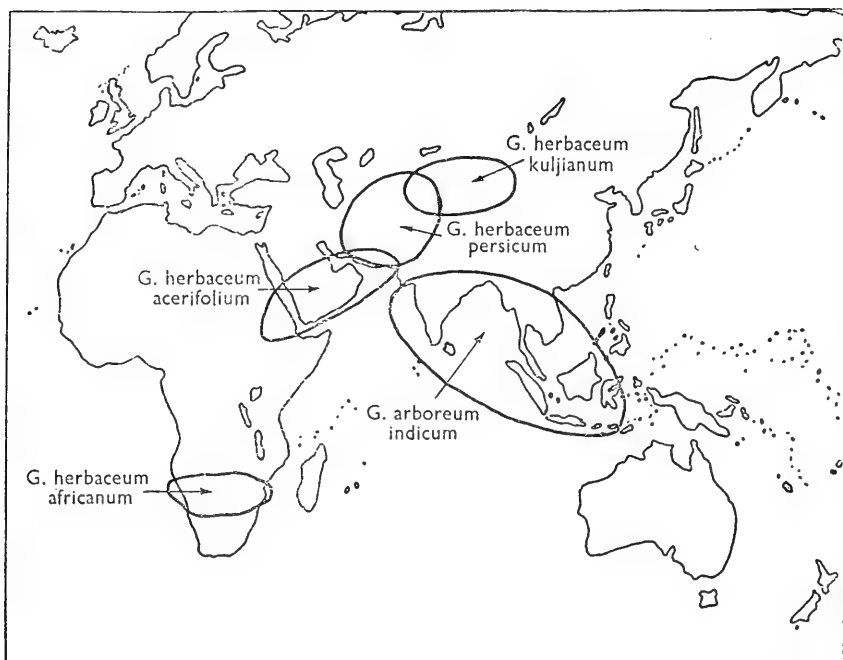

FIGURE 1.—Distribution of the Old World cottons at time of Marco Polo (13th century).

Gujerat in 1787, the annual form was new to the country, where it provided an alternative to the perennial *G. arboreum* known as Rozi.

The history and relationships of the Indian species, *G. arboreum*, were somewhat more difficult to unravel, since the greater part of the development of the species took place under the influence of an important and expanding textile industry in a country where communications were comparatively good and exchange of seed was easy and frequent. Thus, on the one hand, the geographical races are not so well separated or so distinct as in *G. herbaceum*, and on the other, there has been a much greater development of agricultural forms adapted to particular regions and specific needs.

Silow [23] showed that race *indicum* of peninsular India was more closely related to the cottons of the species *G. herbaceum* than are other races of *arboreum*. Race *indicum* includes both perennial and annual forms; there is good evidence that the perennial forms are primitive. The Reverend E. Terry, who accompanied Sir Thomas Roe on his mission to India at the beginning of the 17th century, reported that "those shrubs bear that Wood three or four years ere they supplant them" [27].

The cottons of northern India and Pakistan are distinct from those of peninsular India. Perennial forms are still to be found occasionally in remote places in Rajputana, and in those parts of the Ganges valley where cotton is not grown commercially but is appreciated as a useful plant for household purposes. This northern form spread widely both eastward and westward. Perennial forms in Assam and Burma are derived from it, and westward it has provided the material out of which the common Old World perennial cotton of Africa has developed. The African form, now known as race *soudanense*, was probably the cotton grown by the people of Meroë, an ancient Nubian kingdom, who were the first in Africa to spin and weave cotton [16].

The selection of annual types in the *arboreum* cottons was no more difficult than it had been in the herbaceums, and with the expanding trade of the 19th century annual forms of *arboreum* were developed; these not only supplanted their perennial ancestors, but spread into areas where cotton growing had formerly been unimportant. The new overseas trade in cotton and cotton goods brought with it changes in demand also. Manchester had supplanted the Indian village artisan as the supplier of the great bulk of cotton cloth. A large export trade in raw cotton grew up, but it was to countries farther east rather than to Manchester, and the export demand was for quantity rather than quality. It happened that the annual types selected in the Ganges Valley from the northern arboreums possessed a higher "ginning out-turn" (proportion of lint to seed) and a lower quality than those selected from the indicums of peninsular India. These northern annuals were sufficiently distinctive to be regarded as a geo-

graphical race (*bengalense*), and they spread south into the peninsula at the expense of the indicums. Thus there arose a problem that was to beset the Indian cotton industry for many years. Quantity drove out quality, and by misclassification, adulteration, and other malpractices, the reputation of quality-producing areas was ruined, and coarse high-ginning types were spread. Only with the establishment of the Indian Central Cotton Committee in 1921 and the control of cotton movements under the Cotton Transport Act was the situation brought under control and the better-quality cotton protected.

The development of annual *arboreum* cottons was not confined to India. They were selected independently in Burma, though they do not appear to have become so widespread there as in India. In southeast Asia, colonists from peninsular India brought perennial cottons with them, probably of the *indicum* type, and in Indonesia some annual types have arisen. But the great development of annual cottons in the Far East was in China (fig. 2). According to Watt [27], cotton was grown in Chinese gardens as an ornamental shrub toward the end of the seventh century; cultivation as a field crop began in the 11th century. The Chinese must have been among the first to develop annual forms of *arboreum*, since most of their crop is grown in areas where winter cold would preclude the growing of perennials on a field scale. The Chinese *arboreums* of the present

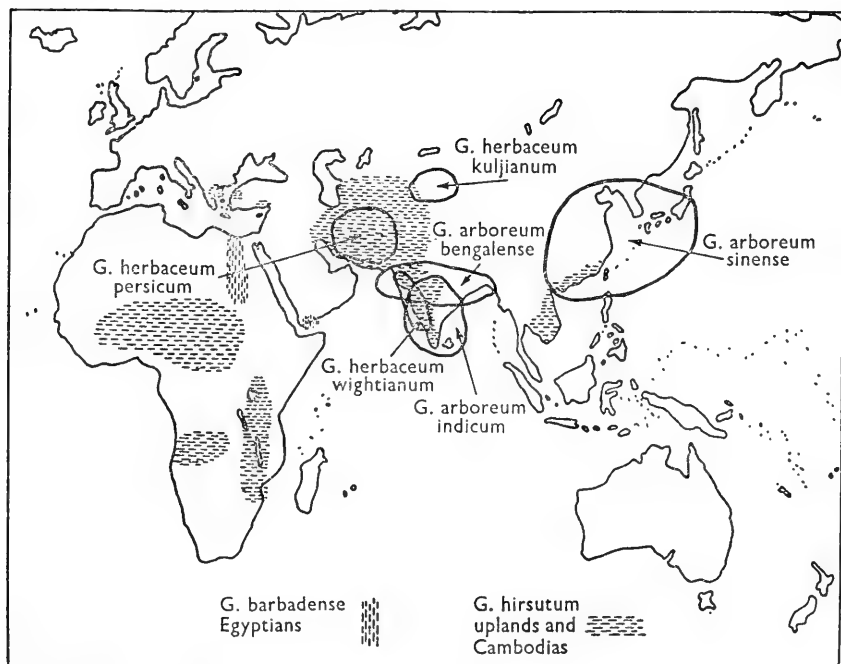

FIGURE 2.—Distribution of annual cottons in the Old World in 1960.

day—race *sinense*—are the earliest-fruited forms in the species, and have developed a distinctive character that marks them off from the two main Indian types, *bengalense* and *indicum*.

COTTONS OF THE NEW WORLD

Cotton was grown and used extensively in South and Central America when the New World was first discovered (fig. 3). It is impossible now to assess adequately the relative importance of the southern and the central regions. From the coastal strip in Peru, a great

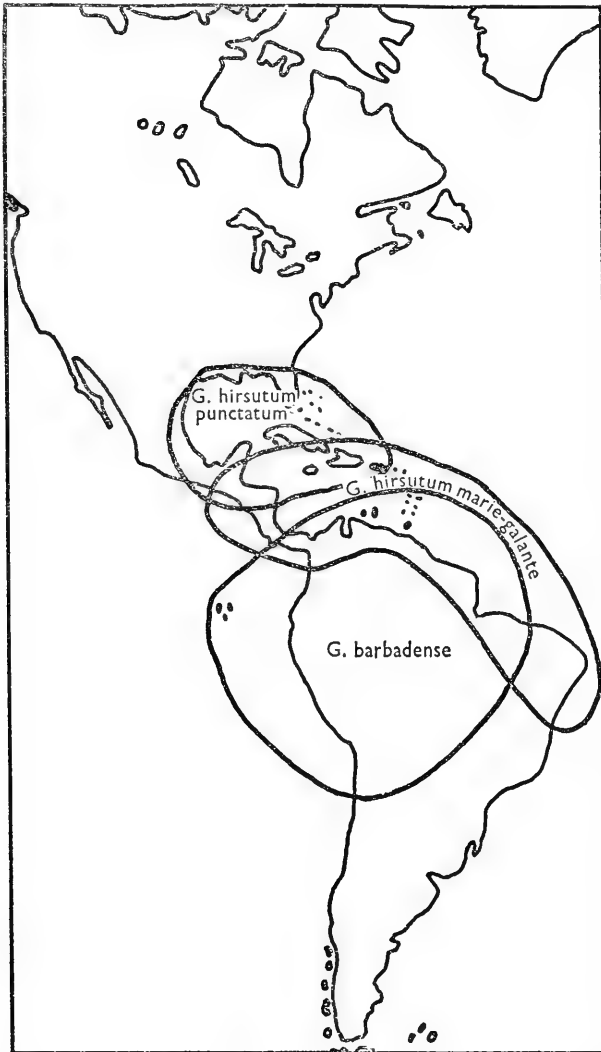

FIGURE 3.—Distribution of the New World cottons at the time of Columbus.

wealth of cotton fabrics of outstanding design and technical competence has been recovered, preserved by the dry soil of the desert graveyards. From the moister climates of Central America, nothing comparable has survived, though it is known from the historical records that cotton provided clothing for the people. As in the Old World, so in the New; the ancient cottons were perennial shrubs. Perennials of the South American *G. barbadense* spread throughout the continent as far south as northern Argentina, but apart from a Brazilian form with large leaves, large flowers, and large bolls and seeds fused into a kidney-shaped mass, there are no well-defined geographical races among the perennials of *G. barbadense*.

Differentiation among the perennials of *G. hirsutum* is much more pronounced. Two important perennial races were early recognized. One of these, race *marie-galante*, includes the largest cottons of all. On the coasts of the Spanish Main, from Panama to Trinidad, and thence north to the Greater Antilles and south to northern Brazil, very large shrubs or small trees up to 20 feet in height are to be found in houseyards and in small cultivations, and sometimes wild among dry coastal vegetation. These were the basis of the early cotton cultivations of the West Indies, and the imprint of human selective forces is still to be detected in their modern descendants [26]. Outside the Americas, race *marie-galante* is known only from Ghana [16], where it was introduced from the West Indies by the Basle missionaries.

The second important perennial race of *G. hirsutum* is race *punctatum*, a much smaller, bushy cotton, to be found round the coasts of the Gulf of Mexico from Yucatan to Florida and the Bahamas. It has been recorded infrequently from Cuba, Haiti, and Puerto Rico, but not from Jamaica or the Lesser Antilles. Race *punctatum* was introduced into West Africa about the end of the 17th century. There it was very successful, and spread across the continent south of the Sahara, completely replacing the Old World cottons as a raw material for the local spinning and weaving industry. It was also introduced into the island of Bourbon (Réunion) by the French, and taken thence to the Malabar coast of India by the East India Company. In the 1930's it was still to be found mixed with a perennial form of *G. arboreum* race *indicum* in the Nadam crop of Madras. British settlers took it to northern Australia; their settlement was a failure, but the cotton survived, and was collected about 1930 from the neighborhood of Port Essington.

Between 1945 and 1948 three expeditions collected extensively in the center of origin of *G. hirsutum* in Central America. Apart from a very few, apparently introduced, forms of *G. barbadense*, all the cottons collected were forms of *G. hirsutum*. This material revealed a geographical differentiation formerly unsuspected. Northern Gua-

temala and Yucatan were occupied by typical race *punctatum*, with the specialized form collected by Stephens on the coastal sand dunes near Progreso (see above)—race *yucatanense*—representing the escape of an exceptionally specialized form into natural vegetation. The second well-known race, race *marie-galante*, was represented in collections from Salvador and southern Guatemala. These plants, though evidently belonging to *marie-galante*, were smaller bushes than the large forms of the Spanish Main and the Lesser Antilles. They still possessed the characteristic dominance of the main stem that makes the development of tree forms possible, and distinguishes *marie-galante* from the bushy, much-branched *punctatum*.

In Central Mexico in Oaxaca, Puebla, and Morelos the perennial cottons were bushy forms with very broad and intensely hairy leaves. These were named race *morrilli*. In the state of Guerrero it appears that a race—*palmeri*—of pyramidal shrubs with deeply dissected leaves and strong anthocyanin pigmentation is almost universal. Last among the perennials is a strong-growing, lax shrub found in a rather small area round the coasts of the Gulf of Tehuantepec.

One other race, *latifolium*, was found in the state of Chiapas in Mexico and in neighboring regions in Guatemala. This is an annual cotton. It is not an early-fruited, specialized agricultural type, and it may persist for more than one year. But, as distinct from the perennial races, it gives its major crop in the first year. There are two main forms: a small-fruited form that occurs throughout the area, and a large-fruited, large-leaved form found in the vicinity of the town of Acala in the state of Chiapas in Mexico. This race appears to be the foundation stock of all the annual *G. hirsutum* cottons. In Central America it has spread into the territories of races *morrilli* and *palmeri*. There, the advantage of annual cottons for commercial cultivation has led to the spread of the neighboring annual form, and natural hybridization with the local perennial has led to the emergence of an annual with some of the characters of its perennial predecessor.

The spread beyond Central America has been enormous (fig. 4). First came the colonization of the Cotton Belt of the United States of America. The source of the first introductions is not known, but there are numerous records of subsequent introductions from Mexico, at intervals down to the time of the discovery of the big-bolled types from Acala which have given the modern very high-yielding commercial types of that name now grown in Arizona and California.

The annual *hirsutum* cottons of the United States became known as "Uplands" (to distinguish them from the "Sea Island" cottons of the coastal islands, which belong to *G. barbadense*), and their development coincided with the development of the cotton industry in Lancashire. As an index of the rate of growth of the crop, in 1784 Customs

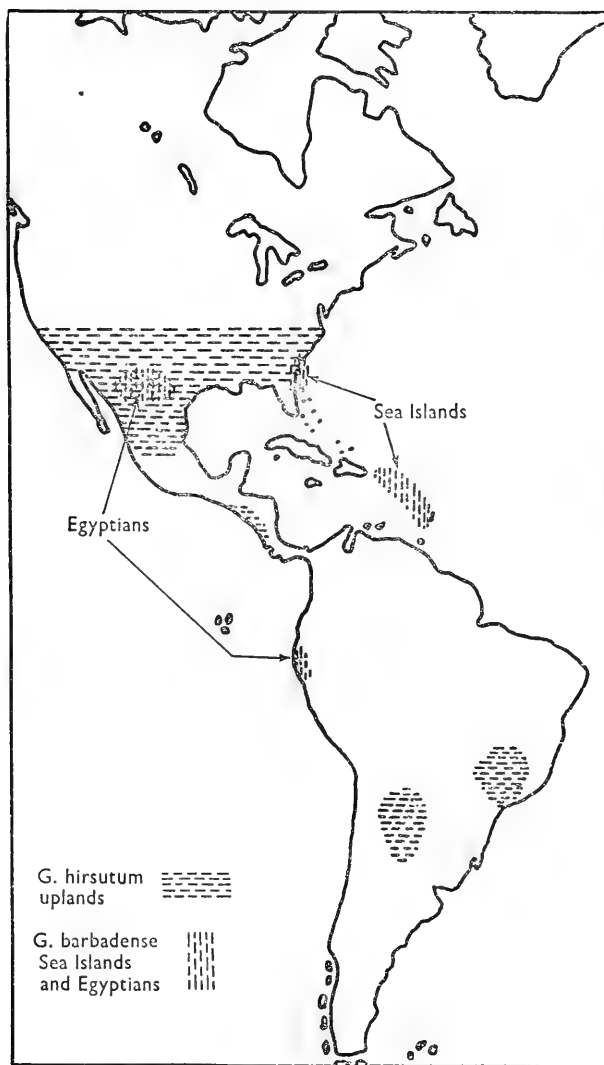

FIGURE 4.—Distribution of annual cottons in the New World in 1960.

officers in Liverpool seized eight bags of cotton on the ground that so much could not have been produced in America. In 1912–13 Great Britain consumed over three and a quarter million bales of American cotton.

The natural desire of other countries to share in the wealth of this export trade, together with such special stimuli as the cotton famine in Lancashire caused by the American Civil War, led to the introduction and trial of Upland cotton in most tropical and subtropical countries of the world. The modern Russian crop in Central Asia is composed of Upland types. Apart from the Nile Valley, all cottons grown in

Africa are now Uplands. In India and Pakistan, Upland cottons were first introduced at the time of the American Civil War. They were a dismal failure, owing to the attacks of the jassid pest. Upland cottons went out of cultivation as a crop, but persisted as occasional plants in crops of Old World cottons. Under the shelter of the Old World types, Upland types were not altogether eliminated, but those with some of the leaf hair that gives resistance to jassid attack were favored. Fifty years later, it was possible for agricultural botanists to select, from the mixed crops, Upland types that had sufficient resistance to be grown satisfactorily in pure stands. This was the beginning of the successful establishment of Upland cotton as a crop in India. A different source of American-type cottons for use in India was discovered in the second decade of the 20th century. Madras cotton-spinners drew the attention of Government botanists to a very useful type of cotton they had been able to import from Cambodia. Seed was obtained, and became the foundation stock of what is now known as the Cambodia crop of South India. Cambodia is a *latifolium* type; its outstanding characteristic is the extremely dense coat of long hairs on the leaf, which gives it very high resistance to jassid. It appears to have been derived from direct introductions by the Spaniards from Central America to the Philippines. The Central American cottons are short-day plants, and when grown in the long summer days of northern latitudes they do not fruit until autumn, and consequently they lose their crop when the frost comes. The establishment of the Uplands in the United States depended on the selection of types tolerant of long days and able to mature a crop before the onset of cold weather. Consequently, Upland cottons, wherever they have been taken, are unaffected by day length. The Cambodias, on the other hand, though early fruiting in the short days of Madras, become progressively later-fruiting as they are taken farther north, and have in consequence never been successful in competition with Upland types in central or northern India or Pakistan.

The *latifolium* cottons have become the dominant cottons in the world's crop. United States commercial varieties of Upland have formed the basis of the cotton crops of Africa, of most of South America, and increasingly of Central America. Uplands and Cambodias are invading the Chinese crop, and where cotton crops are developed in southeast Asia, they will undoubtedly be based on these types, and on hybrids between them.

The development of annual cottons in *G. barbadense* took place later than in *G. hirsutum*. The *barbadense* cottons of the Sea Islands of South Carolina arose from an introduction from either the Bahamas or Jamaica in 1786. In the Sea Islands only annual cropping was possible, and so the type introduced must have been one that was already capable of producing a worth-while crop in the first year.

Types are known among the *barbadense* cottons of western South America that fruit early enough, are independent of day length, and are of good enough quality, to have provided a source from which the annual cottons of the Sea Islands might have been derived [14]. The route by which they reached the Carolinas must remain a matter for speculation.

The outstanding character of the Sea Island cottons is their very high quality. Though a wide range of fine cottons is now available in other groups, no other cottons have been bred to the quality of the best of the "superfine" Sea Islands. Sea Island cotton has always been a small crop. In the first decade of the 20th century it was introduced into, and became established in, some of the islands of the Lesser Antilles, but the main crop in the United States was virtually extinguished when the boll weevil, spreading across the Cotton Belt from Mexico, reached the eastern seaboard.

EGYPTIAN COTTON

There was a prosperous and growing market for fine cottons throughout the 19th and the first half of the 20th century, and it was largely supplied by another race of annual *barbadense* cottons, the Egyptian cottons. Cotton-growing in Egypt based on *barbadense* cottons was initiated by M. Jumel with perennial types in the years following 1820. The development of the Egyptian crop from this small beginning has been recorded by G. C. Dudgeon [6], and the sources of *barbadense* cottons and the probable route by which they reached Egypt are fairly well understood [16]. Jumel's perennial probably reached the Nile Valley from southern Nigeria by way of the trade and slave routes.

In Egypt, cultivation of a perennial crop called for a radical re-development of the irrigation system. The old basin system, whereby the land was flooded at high Nile and a crop was grown on the water stored in the alluvial soil, made no provision for watering at low river-levels. Canals were deepened to bring the water to the field margins at low river, and lifts were installed. Cotton proved so successful that it provided both the incentive and the finance for the building of barrages on the river and high-level canals, to provide perennial-flow irrigation. Meanwhile, Jumel's perennial was so successful that other cottons were introduced for trial. None of these were satisfactory except Sea Island types, which were grown on a small scale for some years. Being a form of *barbadense* cotton, Sea Island alone of all the types introduced gave vigorous and fertile hybrids with Jumel's perennial. Out of such hybrids, cotton breeders selected types with the annual habit and some of the quality of Sea Island, together with some of the vigor and cropping characteristics of the old perennial. Thus a new race of annual *barbadense*

cottons arose, members of a New World species but bred in, and adapted to, the Nile Valley. Furthermore, the replacement of basin irrigation by high-level flow irrigation having been undertaken under the stimulus of the need for water at all seasons for a perennial cotton crop, the perennial plant was replaced by an annual, and the new irrigation system was used to grow two short-term crops each year instead of one perennial.

THE ORIGIN OF CULTIVATED COTTONS

All four species of the cultivated cottons were established crop plants long before the beginning of historical records. Evidence of their status before the dawn of history is available only from a few specially favorable places. A fortunate accident led to the preservation of a small fragment of cotton fabric and a small piece of cotton string in the neck of a silver vessel recovered during excavations at Mohenjo-Daro in West Pakistan. The fragments, which are believed to date from about 3000 B.C., were made from raw material indistinguishable from the product of the indigenous coarse *bengalense* cottons found in the area at the present day. Both fabric and string were well made, and indicated the existence at that time of a well-established, mature textile craft, of which cotton must have been a familiar raw material.

In the New World, the earliest known textiles were discovered first by Dr. Junius Bird at a site on the north Peruvian coast known as the Huaca Prieta [2, 3]. The Huaca Prieta is a mound made up of the occupation refuse of a people who did not use pottery and did not grow maize. They did grow cotton, beans, and some cucurbits. Their cotton was very short-fibered and very coarse, and among present-day cottons is most closely matched by some of the very coarse primitive *barbadense* cottons of the same area. The textile craft of the Huaca Prieta appeared at first sight to be very primitive, but a recent reconstruction of a Huaca Prieta fabric (J. B. Bird, personal communication) has shown an unexpectedly elaborate pattern worked into the material. Evidently, even at that date (ca. 2400 B.C.), the people of the Huaca Prieta were familiar with cotton, and were far beyond the stage of experimenting with a new raw material.

The use of cotton as a textile goes back far into prehistory in both hemispheres. The archeological record is inevitably incomplete, since cotton fabrics and cotton plant material have survived only in the driest of the areas in which the crop is cultivated. For further evidence on the origin of the cottons it is necessary to study the botany and cytology of the cultivated species and their wild relatives.

The wild members of the genus *Gossypium* are rare shrubs of the semiarid and arid regions of the Tropics. Watt [27] recorded species from Australia, India, North and Central America, and the Galápagos

Islands. Species are now known also from continental South America, Arabia, and Africa; they are listed and described by J. H. Saunders [22]. The wild species do not bear seed hairs that can be spun, and one of the major problems of the origin of the cottons is to account for the origin of lint. The simplest hypothesis is that the four lint-bearing species derived their lint from one common ancestor, and the history of the true cottons will now be reconstructed on this basis.

The chromosome complement in *Gossypium* is basically $n=13$; all the wild species save one are diploid. The two Old World species of the true cottons are also diploid. The two New World species of cotton and one wild species (*G. tomentosum* in Hawaii) are tetraploid. Of the diploid wild species, the African species of the section *Anomala* are comparatively closely related to the Old World diploid cottons. There are two species, *G. anomalum* and *G. triphyllum*, and both have been crossed with the two Old World cottons. The hybrids are moderately fertile, and gene transfer and genetic analysis have been carried out successfully [23]. D. U. Gerstel [9] has shown that the chromosome complement of *G. herbaceum* is very closely homologous with that of *G. anomalum*. The complement of *G. arboreum* differs from those of *G. herbaceum* and *G. anomalum* by one translocation. It is in *G. herbaceum*, therefore, that one would logically look for the wild prototype of the diploid cottons. The *Anomala* are distributed in arid areas on the southern borders of the Sahara and in Angola and southwest Africa. The wild form of *G. herbaceum*, race *africanum*, occurs in natural vegetation right across the dry bushveld and semiarid tracts of southern Africa from Mozambique to Angola. It occupies, in fact, an area adjoining that of the most closely related wild lintless species, but it has no obvious contact with the cultivated races of its own species. It has all the characters that would be expected of the original wild form: the perennial bushy habit and the hard seeds with a marked period of dormancy adapted to survival in the wild, and a coat of rough, wiry lint on the seeds, long enough and copious enough to be spun if nothing better offered, but of the lowest quality in terms of modern textile materials. The only substantial difficulty in regarding it as ancestral to the cultivated cottons is the enormous distance between the natural habitat of *africanum* and the areas occupied by the primitive cultivated form of the species, race *acerifolium*, in Ethiopia and southern Arabia. If *africanum* is ancestral to the cultivated forms, it must have been carried far to the north at a very early date, or its range must formerly have been vastly greater than it is now. Travel up and down the East African coast has gone on from ancient times, and the trade in gold from the area, in what is now Southern Rhodesia, in which *africanum* grows wild, is of unknown antiquity. It seems most likely, therefore, that

the early domesticated forms of *herbaceum* arose from *africanum* types carried by travelers northward to Ethiopia or Arabia.

In considering the origin of the *arboreum* cottons, the most important evidence is that on the morphological similarities and genetic relationships between the perennial forms of *arboreum* race *indicum* and the herbaceums. Perennial forms of *G. arboreum* race *indicum* and of *G. herbaceum* race *acerifolium* are extremely difficult to distinguish unless good fruiting material is available, whereas all other forms can be readily and confidently distinguished in all stages of growth. Silow [24] has shown that the genotype of race *indicum* is more closely related to that of *G. herbaceum* than is the genotype of any other race of *arboreum*. The perennials of race *indicum* are native to western India, and the evidence suggests that the species *G. arboreum* arose by differentiation from a primitive *G. herbaceum* stock introduced into western India. Thus, as far as the Old World cottons are concerned, the origin of lint may be traced to *G. herbaceum* race *africanum*, or something closely related to it.

The problem of the origin of the New World cottons is more difficult. They are tetraploid in chromosome constitution, and their chromosome complement is made up of one set homologous with the complement of the diploid Old World cottons and one set homologous with the complement of the wild diploid species of the New World. They are thus allopolyploids, and a related allopolyploid was synthesized by J. O. Beasley [1] from a cross between *G. arboreum* and the wild Arizona species *G. thurberi*. Chromosome-pairing in crosses between the new allopolyploid and New World cottons was good; nevertheless, the synthetic allopolyploid was not a true New World cotton. It was only partially fertile, and the hairs on the seed coat could hardly be regarded as true lint. Subsequently Stephens [15] showed that the Peruvian *G. raimondii* was morphologically considerably nearer to the type one would postulate to give the characters of the New World cottons when crossed with one of the Old World cottons. He was able to produce two hybrid plants, one from the cross *G. arboreum* × *G. raimondii*, and one from the cross *G. herbaceum* × *G. raimondii*, and showed that they did in fact resemble New World cottons more closely than the *G. arboreum* × *G. thurberi* cross. Unfortunately, he did not succeed in inducing polyploidy, and, despite many attempts, it has not been possible to repeat the cross.

Though *G. raimondii* appears to be more nearly related to the New World diploid ancestor of the New World cotton than is *G. thurberi*, it possesses a number of characters that can hardly have been present in the true ancestral type, and it cannot be as close to the New World ancestor of the polyploid cottons as *africanum* is to the ancestor of the diploids.

In view of the difficulty of making crosses from which synthetic tetraploids might be produced, interest turned in the direction of genome analyses of hexaploids, made by doubling with colchicine F_1 hybrids between New World cottons and wild New World diploids. Stephens [15] first reported on the cytology of a *G. barbadense* \times *G. raimondii* hexaploid, and showed that pairing at meiosis was such as would be expected if the *G. raimondii* set were rather closely homologous with one set of the *G. barbadense* complement. Gerstel [10] conducted a genetic analysis in back-crosses of hexaploids to New World cottons, and showed that segregation in *G. raimondii* crosses gave ratios much nearer to those expected in autopolyploids than did segregation in *G. thurberi* crosses. Such evidence as is available on other wild New World species indicates that they are no more closely related to the allopolyploid New World cottons than is *G. thurberi* [15].

Since the New World cottons originated from a hybrid between two diploids, one of which was closely related to the Old World cottons, it is not necessary to postulate a separate origin for their lint. On the other hand, since the other diploid parent was related to the Peruvian *G. raimondii*, it is necessary to consider how an Old World diploid and a New World diploid could have come together in western South America so that the cross could take place. The first attempt to account for the meeting of the two parents was by Harland [12], who suggested that they came together on a land bridge across the Pacific Ocean. Little evidence has been adduced for the existence of such a land bridge, and it was later suggested [15, 19] that the link was provided by civilized man, migrating eastward from the Old World and taking his Old World cottons with him. Landing on the Peruvian coast, he would find suitable conditions for his simple agriculture in the valleys of the rivers draining the Andes and crossing the coastal desert to the sea. In those valleys, *G. raimondii* grows naturally, and from natural crosses between the introduced Old World cotton and an ancestor of *G. raimondii* arose allopolyploids from which the New World cottons sprang. The hypothesis fitted the known facts, and its usefulness as a working tool was demonstrated when Bird [3] used it to help in the search which led to the excavation of the Huaca Prieta and the discovery of the oldest known textiles in the New World.

An examination of seeds, carpels, and lint from the early Huaca Prieta deposits revealed nothing to suggest the presence of an Old World diploid cotton. Moreover, F. Engel [7] has since shown that habitation sites of the Huaca Prieta type of culture occur over a great stretch of the Peruvian coastline, far beyond the area in which *G. raimondii* now exists.

It may well be, of course, that *G. raimondii* was formerly more widely distributed, or that there were other, related species in the Peruvian valleys. The pressure of the population of coastal Peru on the very limited resources of water and of vegetation is such that the natural flora has been virtually eliminated and other wild species besides *G. raimondii* may have existed in former times. Nevertheless, though restriction of distribution and even extinction may have affected the situation greatly, it cannot be claimed that evidence for the origin of the allopolyploid cottons in coastal Peru has increased greatly since the hypothesis was put forward, and alternative theories must now be examined.

G. L. Stebbins [25] has suggested that the diploid Old World parent reached the New World by way of China and Alaska, and the possibility of an Antarctic route has been proposed. Both the northern and the southern routes are advocated on the ground that at one time mesophytic temperate woodland floras existed that were common to the two hemispheres. *Gossypium* is a genus of xerophytic perennial shrubs adapted to the arid Tropics. No member of the genus would grow in an ecological situation where temperate woodlands existed, and until the modern development of short-term annual cottons under domestication, no member of the genus would survive in a climate with winter frosts. It is therefore reasonable to conclude that contact between Old World and New World species did not come about by migration round the Pacific, either by a northern or by a southern route.

The remaining alternative to a trans-Pacific link is a link across the Atlantic, and Gerstel [9] has recently suggested that this should be considered. He showed that in *G. herbaceum* the chromosome order does not differ substantially from that in the wild African *G. anomalum*, and he concluded that the *G. herbaceum* order is primitive. *G. arboreum* differs from the primitive order by one translocation, and the corresponding chromosome set in the New World allopolyploids differs from that in *G. herbaceum* by two and from that in *G. arboreum* by three. He therefore argued that *G. arboreum* is not in the main line of development from the primitive chromosome pattern to the modern allopolyploids. Since *G. arboreum* is the cotton of the Indian subcontinent and of the western coasts of the Pacific basin, it seemed to him unlikely that the link between the primitive diploids represented by *G. herbaceum* and the New World cottons of South and Central America was to be sought across southeast Asia.

The difficulty of supposing that the allopolyploids arose following migration of an Old World cotton across the Atlantic lies not only in accounting for the ocean passage, but in also understanding how the two parents came in contact after the Old World cottons reached

South America. Not only is the closest known New World wild relative confined to the Peruvian coast, but the whole group of New World wild species of *Gossypium* is distributed west of the continental divide. Nevertheless, certain other fragments of evidence seem to point toward an eastern South American origin for the cottons. Engel [8] has reported that the crops of the ancient preceramic cotton-using cultures of the Peruvian coast include groundnuts (*Arachis*), which originated east of the Andes, probably [20] in northwestern Argentina, suggesting that the cultivators reached the coast from the mountains, and not from the sea. If they came over the mountains, they presumably brought their cotton with them.

Archeological evidence from preceramic cultures in Peru is critical. If it could be shown that the people to whom these cultures belonged came there by sea, the recent-origin theory of the development of the New World cottons would be greatly strengthened, and a search of natural vegetation in remote valleys of the Peruvian coast should be undertaken in the hope of discovering a wild diploid species related to *G. raimondii* with characters more nearly those appropriate to the ancestor of the New World cottons. If, on the other hand, it turns out that the earliest Peruvian cotton farmers reached the coast from the mountains, the wild American diploid ancestor of the New World cottons might be sought east of the Andes, and not on the Pacific slopes. One would naturally look in arid areas for such a plant, and in the regions in which the other crops of the early cotton users originated.

To accept an eastern South American origin for the New World cottons would involve accepting also an ancient and not a recent origin for the allopolyploids. The cultivation of cotton on the Atlantic coasts of Africa is very recent, and it would be necessary to suppose that the parents of the allopolyploid were both wild and came in contact by natural spread. The present distribution of the wild species of *Gossypium* has been interpreted [15] in terms of the distribution of the major land masses before the continents drifted apart. If the main species distinctions in *Gossypium* were already established at that time, and if a suitable wild diploid existed east of the Andes, a type akin to the South African *G. herbaceum* race *africanum* might have come naturally in contact with its counterpart, and the allopolyploid might have arisen in that way. Then Stebbins's contention would be upheld, that the New World cottons are among the oldest, and not the youngest, of the known allopolyploid species.

The trail of speculation about an ancient Atlantic origin for the New World cottons is as long and as scantily supplied with beacons as that about a recent Pacific origin. Nevertheless, speculation of this kind is worthwhile. For example, the original speculation influenced Bird in the choice of the Huaca Prieta as a site for archeological study.

Following Gerstel's suggestion and the archeological indications reported by Engel, it is possible to set out the conditions governing the possibility of a transatlantic link, and to point to two lines of investigation—archeological in Peru and botanical east of the Andes—that might make it possible to decide between the two hypotheses. This is a new and unexpected turn in the inquiry into the origin of the cottons. No mention has been made here of the third allopolyploid, *G. tomentosum*, which is a wild fuzzy-seeded—but not linted—species in Hawaii. Ever since the cytological situation in the genus was set out it has seemed that if the origin and relationship of *G. tomentosum* could be elucidated, the problem of the New World cottons would be solved. Now it appears that the origin of *G. tomentosum* is a separate and probably unimportant problem, and the real interest lies in the Peruvian Andes, and in the origin of the earliest cotton farmers of the Peruvian coast.

REFERENCES

1. BEASLEY, J. O. *Genetics*, vol. 27, p. 25, 1942.
2. BIRD, J. B. *Nat. Hist.*, New York, September 1948, p. 296, 1948.
3. BIRD, J. B., and MAHLER, J. *Amer. Fabrics*, vol. 20, p. 73, 1951-52.
4. CHEVALIER, A. *Rev. Bot. Appl.*, vol. 13, p. 190, 1933.
5. COOK, O. F., and HUBBARD, J. W. *Journ. Heredity*, vol. 17, p. 463, 1926.
6. DUDGEON, G. C. *Min. Agric. Egypt*, 1916, No. 3a, 1917.
7. ENGEL, F. *Journ. Soc. Américan.*, Paris, vol. 46, p. 67, 1957.
8. ENGEL, F. *Journ. Soc. Américan.*, Paris, vol. 49, p. 7, 1960.
9. GERSTEL, D. U. *Evolution*, vol. 7, p. 234, 1953.
10. GERSTEL, D. U. *Genetics*, vol. 41, p. 31, 1956.
11. HARLAND, S. C. *Biol. Rev.*, vol. 11, p. 82, 1936.
12. HARLAND, S. C. *The genetics of cotton*. Jonathan Cape, London, 1939.
13. HUTCHINSON, J. B. *Journ. Agric. Univ. Puerto Rico*, vol. 28, p. 35, 1944.
14. HUTCHINSON, J. B., and MANNING, H. L. *Emp. Journ. Exp. Agric.*, vol. 13, p. 80, 1945.
15. HUTCHINSON, J. B.; SILOW, R. A.; and STEPHENS, S. G. *Evolution of Gossypium*. Oxford University Press, London, 1947.
16. HUTCHINSON, J. B. *Emp. Cotton Growing Rev.*, vol. 26, No. 1, 1949.
17. HUTCHINSON, J. B. *Heredity*, vol. 5, p. 161, 1951.
18. HUTCHINSON, J. B. *Heredity*, vol. 8, p. 225, 1954.
19. HUTCHINSON, J. B. *Application of genetics to cotton improvement*. Cambridge University Press, London, 1959.
20. KRAPOVICKAS, A., and RIGONI, V. A. *Darwiniana*, Buenos Aires, vol. 11, p. 431, 1957.
21. NICHOLSON, G. E. *Econ. Bot.*, vol. 14, p. 3, 1960.
22. SAUNDERS, J. H. *The wild species of Gossypium and their evolutionary history*, Oxford University Press, 1961.
23. SILOW, R. A. *Journ. Genetics*, vol. 42, p. 259, 1941.
24. SILOW, R. A. *Journ. Genetics*, vol. 46, p. 62, 1944.
25. STEBBINS, G. L. *Ecol. Monogr.*, vol. 17, p. 149, 1947.
26. STEPHENS, S. G. *Trop. Agric.*, Trinidad, vol. 21, p. 23, 1944.
27. WATT, G. *Wild and cultivated cotton plants of the world*. Longmans, London, 1907.

Some Mysteries of Life and Existence

By R. E. SNODGRASS¹

Honorary Research Associate, Smithsonian Institution

INTRODUCTION

The anatomists, the cytologists, the embryologists, the physiologists, the biochemists are continually giving us more and more facts about the structure, development, composition, and activities of living things. Yet beyond their farthest advances there still remains in each phase of life an unresolved mystery. The mysteries of life are the various activities constantly going on in living matter, which can be observed, but cannot yet be explained.

The universe itself is one vast mystery. All matter, in a last analysis, consists of the component particles of atoms—protons, neutrons, and electrons. These are united in about a hundred kinds of known atoms, which combine to form innumerable kinds of molecules, gaseous, liquid, gelatinous, and solid. It is the energies inherent in these elementary cosmic units that account for all the activities of matter, both inanimate and animate. The final mystery of the universe and of everything in it, then, is the nature and origin of matter. The basis of life in its simplest form is the chemical interaction of certain kinds of molecules when the latter come together in appropriate conditions. Life, therefore, is one with the movements of the stars and the planets, the heat of the sun, radiant energy, volcanic eruptions, and simple chemical reactions, all of which are manifestations of atomic and molecular energies. While this thought greatly simplifies our concept of the universe, it only magnifies the mystery of it all.

The biologist studies the various phases of life in plants and animals, but generally he regards it as no part of his science to explain the invisible forces that activate living matter. The general public gives little thought to such subjects. We plant a tiny seed knowing that it will give rise to a plant of the kind from which it came, perhaps a huge tree, for example, which will put out thousands of leaves all essentially alike, and repeat the same year after year. We see all this without emotion, just as we see young animals, or even our own children, grow up to be adults of their species. Such things are so com-

¹ Dr. Snodgrass died on September 4, 1962.—EDITOR.

monplace that we take them for granted, not realizing that we live in the midst of mysteries, or that we ourselves are one of the greatest mysteries in nature.

From this paper the reader must not expect to get any factual information beyond what is well known. The discussions that follow are simply ratiocinations about things we do not know, and theories that attempt to explain them.

IN THE BEGINNING

We begin with the most abstruse of all mysteries, the question of how did the universe come into existence. In the book of Genesis we are definitely told that on the first day, whenever that was, the heavens and the earth were created and that, on the third day following, the sun and stars were made. No astronomer can accept this statement. To say the least, the writer got his dates badly mixed, since it is certain that the earth did not float around in space for 4 days before making connections with the sun. Moreover, "creation," as we must now visualize it, did not begin with the formation of stars and planets all ready-made, but with the elemental particles of matter. Since atoms are no longer indivisible units, the first forms of matter should have been protons, neutrons, and electrons.

There are only two possible ways to account for the existence of the universe; either matter was created, or it has always existed. The technique of creation, making something out of nothing, no one has even attempted to explain, and the process is quite impossible for us to understand. On the other hand, that anything can exist without a beginning is something we cannot visualize; "always" is a stretch of time our finite minds cannot grasp. Yet we can hardly conceive of time having had a beginning—we rather confidently speak of eternity in the opposite direction—nor can we think of space as having limits. Time can be limited only by more time, and space by more space. However, there is the theory of some astronomers that radiation from the sun and stars is produced by the annihilation of atoms. In this case, Jeans (1921) points out, the present matter of the universe could not always have been here, and so he postulates that annihilation must be compensated by creation, but he is not explicit as to how the latter takes place. Material existence has to be taken as a fact, but the question of origins will forever remain a double mystery. As said by Jeans, there is "a growing conviction that the ultimate realities of the universe are at present quite beyond the reach of science, and may be—and probably are—forever beyond the comprehension of the human mind." It is a relief to feel that there are things so far beyond us that we need not even try to understand them.

Material existence has to be accepted as a fact, and we can endure perpetual ignorance concerning the origin or beginning of the uni-

verse. The important thing to realize is that, however it may have begun, the universe is still composed of the elemental particles of matter and that the energy with which these particles were originally endowed is the source of all energies and activities, inanimate and animate, later developed as the universe evolved.

Gamow (1952), under the misleading title of the "creation" of the universe, gives us a very good picture of its evolution from a vast, hot, seething, gaseous mass of the primary particles of matter. Later, as the mass began to cool and expand, protons, neutrons, and electrons combined to form atoms, and atoms united into molecules. Cloudlike condensations formed galaxies, condensations in the galaxies became stars, and finally the planets were formed. It is wonderful what atomic physics, mathematics, and imagination can do for astronomy, but still it is disconcerting to find how much of it is theoretical. Urey (1952), for example, lists five theories, beginning with that of Laplace, which have been proposed to explain the origin of the solar planets. Of these theories he discredits all except the idea that the sun was first surrounded by a vast cloud of dust which condensed into the planets. However, we need not here be concerned with cosmic theories; they all have to come out with things as they are, the earth a globe fitted for life, the other planets still to be investigated in this respect.

The earth at last, perhaps 3 billion years ago, acquired a solid rocky crust, but still it was intensely hot, and volcanoes everywhere were throwing out liquid matter from below. All was shrouded in dense cloud masses. Given a billion years to cool, the clouds condensed into torrential rains that filled depressions on the earth's surface and formed the primitive oceans. (Never again until the time of Noah was there such a rain as this.) The rain brought down chemicals from the atmosphere, washed them out of the rocky hillsides, from the volcanic lava, and poured them all into the standing waters. With the clouds dispersed, sunshine floods the earth and ultraviolet radiation penetrates the atmosphere. The stage is now set for the beginning of life.

The picture above presented of conditions on the earth before the advent of life is that visualized by theorists on life's origin. However, as generally in matters incapable of proof, different writers have advanced quite different theories on the nature of the young world (see Urey, 1952).

THE ORIGIN OF LIFE

Ideas concerning the beginning of life on the world are necessarily theoretical, but the biochemists have worked out a theory that is now generally approved or accepted. It is derived from the fact that the basis of all life at present is the chemical interaction of organic sub-

stances in the units of living matter called cells. It is reasoned, therefore, that if similar substances were first brought together in pools of water or along the shores of the primary seas, the same chemical reactions would take place as at present, and thus give the beginning of life. This theory has been particularly well worked out by Oparin (1938, 1961), whose ideas have been so closely followed by others, as by Wald (1954), Adler (1957), and Lehrman (1961) here cited, that fortunately we have only one plausible theory on the subject to deal with, which fact in itself is a good recommendation for it. The general reader may find the theory well presented by Platt (1961) in the Reader's Digest. Briefly reviewed, this modern scientific concept of the origin of life is as follows:

Among the chemicals poured into the waters of the earth by the rains were simple organic compounds freely formed in nature. As time went on, some of these substances came together in small groups forming droplets of organic material in a gelatinous or colloidal state, such as are known as coacervates. When organic molecules get together in a water medium, things begin to happen. Some are broken down into simpler molecules, some of which are thrown out, while others are taken in from the surrounding water and assimilated to restore the internal balance. Thus *metabolism*, the basic activity of life, began on a small scale. Though most of the coacervates were highly unstable and soon went to pieces, those in which a balance of output and intake was preserved endured. These persisting coacervates could now be said to be alive. With feeding, the mass became too large and simply broke into two parts, perhaps as a lump of jelly might be divided. Thus the simple organisms multiplied; those best fitted to survive were preserved by natural selection and became the progenitors of future life forms. In the words of Adler (1957), "through the slow accumulation of changes during hundreds of millions of years, coacervates finally developed that had the complex, delicately balanced, and stable chemical processes that we call life."

Some writers, as Moskin (1962), refer to the origin of life in matter as "creation" of life, but clearly there is no act of creation involved.

The materials that first became living matter had been in existence since the beginning. They were simply brought together under circumstances that allowed their inherent energies to interact in a new way.

The chemical activities of living matter require a constant supply of energy. The principal source of life's energy today is the oxidation of food, but the theorists tell us that when life began and for a long period afterward there was no oxygen or very little in the earth's atmosphere. At this time it is supposed that energy was produced by fermentation, a very slow process, but there were millions of years during which living matter could leisurely develop and improve. It

was not until plants acquired chlorophyll and developed the process of photosynthesis that oxygen was liberated from carbon dioxide and energy became available by oxidation. Thereafter organic substances were produced in abundance by living things themselves, and the life processes were speeded up by the acquisition of enzymes. Since all the earliest known animals were air breathers, the plants must have had the water well oxygenated by the time of the Pre-Cambrian, and made the land habitable for all the air-breathing creatures that came later to populate the earth. There is no doubt that plants are now the ultimate source of all animal food; it is difficult to believe, however, that we are indebted to them also for all the oxygen we breathe today. Another theory contends that oxygen and other gases have seeped through the earth's crust from the interior.

The biochemical theory of life's origin here reviewed should be as convincing as any visionary theory on the subject could be. It is the hope of the biochemists that it may sometime be demonstrated by the artificial synthesis of life in the laboratory. In this event, the mystery of life would not be its origin, but the nature of the chemical forces in organic compounds by which they give life to lifeless matter.

There have been other theories concerning the origin of life on the earth. A fanciful idea that once appealed to the credulous held that germs of life prevailed the universe and that drifting through space they have developed on any planet that offered favorable conditions. This theory neatly avoids the question of life's origin. It may readily be admitted that if the same chemicals and the same conditions are present on some other planet as on ours, life may have appeared there as on the earth. But it is highly improbable that evolution followed the same course and produced higher forms of life comparable to those that have evolved here. The "man from Mars" will probably be found to be just as fictitious as the "man in the moon."

Down to almost modern times a belief has persisted in the spontaneous generation of living creatures, such as the production of maggots from the flesh of dead animals, or the origin of microorganisms from the scum of foul water. Even in the writer's early days we never doubted that threadworms (*Gordius*) found in the old horse watering-troughs were animated horse hairs. Modern biology has callously put an end to all such romance.

From the theoretical primitive forms of life it is still a long way to the organized cell with its nucleus, chromosomes and genes, centrioles, and mitochondria. Unfortunately, however, as Oparin (1938) says, "the origin of the cell is perhaps the most obscure point in the whole study of the evolution of organisms." No intermediate forms are known, and theories have not yet bridged the gap. Viruses are not a primitive form of life because they can reproduce only in other

organisms, and bacteria cannot live alone in nature. If, however, we can once account for the origin of an amoeba, evolution from Protozoa to man is relatively easy.

CELL DIVISION, REPRODUCTION, AND HEREDITY

Since no form of life is individually immortal, there would be no living thing on the earth today if the first living creatures had not devised a means of multiplication. The simplest type of reproduction is the division of a unicellular animal into two duplicating cells, and cell division is still the basis of reproduction in all higher animals. In the simpler Protozoa it begins with a division of the nucleus, followed by a constriction of the cell between the daughter nuclei, and ends with a complete separation of the cell into two cells. In others the mechanism becomes variously more complex until it comes to resemble that characteristic of the Metazoa. In some of the Protozoa the successively formed cells, instead of separating as individuals, adhere in a mass, forming a many-celled animal of a sort, such as *Volvox*, in which there is some coordination among the individuals, but little differentiation of structure, except that certain cells assume the function of reproduction. With the true many-celled animals, or Metazoa, however, the cells are so closely adherent that they practically lose their individualities, and groups of them differentiate into complex organs of various functions.

In some of the lower Metazoa the body cells may retain a reproductive potential sufficient to regenerate lost appendages or even a large part of the body including the head. Among the higher animals this faculty becomes reduced to wound healing. In general, reproduction is the function of special cells set apart for the purpose. The germ cells are differentiated into male and female cells which, with few exceptions, must first unite in pairs before development begins. The combination of the male and female elements in the zygote, or egg, combines hereditary material from two parental sources, and is usually accredited with inducing more structural variations in the adult for natural selection to work on in the evolution of species. Sexual reproduction occurs among the Protozoa, some of which come together in pairs and unite, while others simply exchange nuclear material. Among the metazoic animals and in the flowering plants it is all but universal. Bisexual reproduction, therefore, evidently has had a strong evolutionary influence. Only in a few invertebrates, as in the honey bee, does the unfertilized egg develop.

Since the number of chromosomes in the body cells of the Metazoa is typical for each species, the primary germ cells undergo a reduction division by which the number of chromosomes is halved. Union of the sex cells at the time of fertilization then restores the normal chromo-

some equipment of the species. Sexual reproduction, therefore, is dependent on chromosome reduction in the conjugating cells, but the same thing takes place in every dividing cell. In ordinary cell division, however, the chromosomes are first doubled.

When we turn from the gross structure of an animal to what goes on within its cells, we leave the realm of anatomy for that of biochemistry. Here we find ourselves in a totally different world of life, in fact, in that of life itself, and we encounter phenomena quite different from anything we have experienced before.

The mechanism of cell division in the Metazoa is highly developed in a form known as *mitosis* (see Mazia, 1953). In the resting cell the nuclear chromosomes are long, tangled filaments, but preceding mitosis they condense into darkly staining bodies usually of a definite number in each species. Prior to this the chromosomes have divided each into two, so that now they are present in identical pairs. A small body in the cytoplasm, known as the centriole, then divides and the two parts move to opposite poles of the cell. Threadlike fibers radiate out from each centriole, forming a spindle through the nucleus, which now accommodatingly loses its wall. Some of the threads extend from pole to pole, others attach to individual chromosomes. The two chromosomes of each pair then move to opposite poles as if pulled by the threads, but the mechanism of their movement is not fully understood. Each chromosome group becomes a new nucleus. Finally the cell constricts at the equator between the nuclei and eventually divides into two duplicate cells.

All this coordinated activity observed in the dividing cell appears to take place automatically. It can be followed under the microscope, but there is no visible evidence of what causes the phenomena seen.

The biochemists have shown that the principal substance of the chromosomes in all animals is a chemical known as deoxyribonucleic acid, of highly complex molecules. This acid, called DNA, is truly a most remarkable stuff; it is the "dictator" of all the cell activities, including cell metabolism and the growth of the embryo developed from the egg. Intensive studies of these subjects have been made by the biochemists in recent years. A dramatic example of the creative power of DNA is seen in the infection of a bacterium by a virus. The virus cell discharges its DNA into the bacterium, and here, at the expense of the bacterial cytoplasm, the DNA molecules not only replicate themselves but form complete new virus cells, as many as 200, which are discharged with the rupture of the bacterium (Jacob and Wollman, 1961).

The cytoplasmic changes that differentiate the multiplying cells are said to be done strictly "on orders" from the DNA of the nucleus, and are carried to the cytoplasm by a related substance RNA (ribonucleic acid) catalyzed by enzymes from the DNA. In connection with

nodules (ribosomes) in the cytoplasm RNA then synthesizes the amino acids of the cell into the proteins and enzymes necessary for the specific function the cell is destined to assume.

The fertilized egg is the mother cell of her offspring. To each cell is given explicit "instructions" as to just what is to be its role in duplicating the form and structure of its immediate ancestor. The biochemists are attempting to explain all this, but still it seems one of the most mysterious things in the whole physical realm of nature. As said by Fischberg and Blackler (1961), "Long before men knew anything about cells, much less molecules, they were familiar with one of the most tangible mysteries in nature: out of a simple-looking egg emerges a living organism, complete and perfect in every detail and unimaginably complex. Each organ just the right size and in the right place and contains the right kind of cell to carry on its specialized function. Today we are scarcely less mystified. How does the undifferentiated cell of a cleaving egg turn into a specialized cell of heart, liver, nerve, bone, or muscle?" Needham (1942) gave an exhaustive review of the status of biochemistry and morphogenesis as of 20 years ago, occupying 677 pages based on more than 2,400 citations. Bonner (1962) now gives us an up-to-date account of more recent developments in the biochemistry of the genetic materials. Yet both authors leave us still with the mystery of *how* chemical substances determine and control the development of the egg into an embryo that reproduces the structure of its parents, whether a mouse, a bird, a dog, a man, or an insect. According to Bonner the mechanism of cell differentiation is still unknown. The biochemists, of course, ardently believe that some day the mystery may be dispelled; but let us hope this will not be too soon, for when all the facts of life are known, biology will lose its interest.

The specific factors of heredity we have long been told are bodies called *genes*, thousands of them distributed along the length of the chromosomes. We might then suppose them to be something like seeds in a pod. However, it appears that not yet has a gene been isolated and studied individually. They are parts of the DNA molecules, which the biochemists now regard as the basic material of heredity. That the genes are specific somethings, however, is evident from the fact that changes (mutations) attributed to them are reflected in hereditary changes in the adult. These changes are the structural variations by which natural selection has evolved new species. The genes of a modern animal, therefore, include those that formed it by mutation, and hence they can reproduce its present structure.

We should very much like to understand how the chemical DNA, whether of the genes or the chromosome molecules, or both, can influence the proliferating cells to build up an embryo and finally an adult

of the parent species. The geneticists and biochemists tell us that on the chromosomes of the cell nucleus is encoded the entire plan for the development of the embryo, which serves as a working blueprint for the developing cells. To clarify this somewhat anthropomorphic statement, it must be explained that the language of the code is that of molecular chemistry, which the biochemists are industriously trying to interpret. (See numerous papers in the *Scientific American* during the past 10 years.) The code characters are said to be different combinations of the component elements of the DNA molecules. The message is delivered in the form of enzymes, but the language of enzymes has not been fully translated.

Though the fact of embryonic development from a single cell is commonplace knowledge, that it is done by the chemically guided interaction of cell molecules is almost unbelievable. Yet no other power can be invoked, no outside force normally affects the embryo. Though the chemical basis of embryogeny may be a mystery beyond our comprehension, we have to accept it as a fact. It makes us one with the physical universe. Without DNA we might still be one-celled animals.

When the embryo is once established, DNA seems to delegate its authority largely to *organizers*. An organizer is any part of the embryo that induces a neighboring part to develop in a particular way. The effective chemical substance emitted by an organizer is called an *evocator*. That chemicals can produce specific forms of growth in living tissue is clearly demonstrated in the formation of plant galls by insects. Something injected into the plant by the female insect when she inserts her eggs, or something excreted by the larvae, causes an abnormal growth of the plant tissue into a gall specific of the insect species that caused it.

CELL MOVEMENTS

The free-living Protozoa are one-celled motile animals; in fact it is because of their movements that we recognize them as living things. Simplest of them is the amoeba, a minute shapeless mass of protoplasm, and yet it moves, ingests particles from the water, digests and assimilates those of food value, ejects the others, reacts to external stimuli, and reproduces itself. The amoeba thus performs all the essential functions of the higher animals, but does them in a very simpler manner.

The amoeba moves in any direction by throwing out fingerlike processes of its body called pseudopodia. Since it can project pseudopods from any part of its body, it has no permanent anterior or posterior end. If it comes into contact with a solid object, it turns one way or another, just as would any other living animal. But what is life in such a simple creature? The experimentalists tell us (see Meier and

Schneirla, 1935, pp. 14–23) that in response to the stimulus of touch on the amoeba a chemical reaction is produced that sets up currents in the body protoplasm resulting in the extension of a pseudopod and movement of the body. According to the strength of the stimulus, movement may be toward or away from the point of stimulation. Forward movement is explained by Allen (1962) as due to contraction of the pseudopods. If this is animal life in its simplest manifestation, it is little more than chemical and physical reactions induced in a plastic substance by external stimuli. Other protozoons have become more complex in structure and have developed specific motor organs in the form of vibratile cilia or flagella.

The protozoons all move by some visible motor mechanism, but some cells in the tissue of plants or animals have been described as simply moving in a purposeful direction without giving any evidence of how they do it. Several examples of this are given by Lewis (1940). One is that of spicule-carrying cells in sponges, described by Schröder (1936). The primary spicule is formed as an axial filament in the cytoplasm of a cell, which then dies. Another silica-containing cell now comes up and discharges its silica on the young spicule, which is thus increased in thickness. Other cells then attach themselves to the spicule and transport it to its proper place in the sponge body. It would be useless to ask what motivates or operates these transporting cells.

A still more remarkable example of activity in tissue cells has been ascribed to the flatworm *Microstomum*, described by Lewis from the studies of Kepner, Gregory, and Porter (1938). The worm eats the green freshwater hydra and ingests its nematocysts (epidermal cells with projectile threads). The hydra possesses four kinds of nematocysts, in two of which the threads are stinging, a third kind adhesive, and the fourth grasping. All four kinds of nematocysts are taken into the stomach of the worm and penetrate through the stomach wall into the parenchyma. Here the nonstinging nematocysts are digested and absorbed as being of no use to the worm. The stinging nematocysts, however, are transported by certain parenchyma cells to the epidermis, where they are oriented with the threads directed outward. At the point of contact of each nematocyst with an epidermal cell, the latter becomes pitted internally and externally to allow the discharge of the nematocysts thread. Thus *Microstomum* arms itself with the stinging nematocysts of the hydra as weapons for its own defense. After 100 hours all ingested nematocysts are ready for action, but when the epidermis is fully loaded, the superfluous nematocysts are retained in the stomach and thrown out of the mouth.

“Thus it becomes evident,” the authors point out “that endoderm, parenchyma, and epidermis of *microstomum* cooperate in the manipulation of hydra’s nematocysts.” “In all this conduct,” according to

the senior author, "physical and chemical factors are involved, but some organizer appears to be directing these factors." The "organizer," however, does not visibly appear, nor is it evident what the motor force of the transporting cells may be, even if their activities are directed by an organizer. A further mystery is: how did these coordinated activities originate in the evolutionary history of *Microstomum*, and then become transmitted by heredity? Some zoologists are reluctant to accept this story of *Microstomum* and the nematocysts of hydra, but Lewis (1940) and Tinbergen (1951) quote it without comment.

INSTINCT

A primarily distinctive quality of animals is mobility, only a few having adopted secondarily a sedentary life by attachment to a support. A moving animal encounters differences in the environment, some of which are advantageous to it and others harmful. Movement, therefore, must be capable of regulation. In some way the animal must be sensitive to environmental conditions, and its sensory impressions must be transmitted to the motor system.

The simplest animal movements are those of the Protozoa. They include avoiding reactions to obstructions, the avoidance of unfavorable chemical conditions in the water, and in some cases reaction to light. The protozoons move either by changes in the shape of the body or by the action of external cilia or flagella. Yet they have no specific sense organs, nervous system, or muscles; the one-celled body evidently acts in all three capacities.

The many-celled animals have a great advantage in the potentiality for cell differentiation. This has enabled them to develop specific sensory, conductive, and motor tissues along with efficient organs of locomotion. Their capacity for varied movements, therefore, is practically unlimited. In the lower Metazoa, probably including all the invertebrates, the sensory-nervous-muscular circuit works automatically in response to a sensory stimulus. The resulting behavior of the animal is called *instinct*. Instincts, thus, having a purely physical basis, are acquired by structural inheritance, are not learned, and require no act of consciousness on the part of the animal. Instincts are present also in all the higher animals, but in the vertebrates, with the development of the forebrain, the faculty of consciousness appears, leading to intelligence, and instincts become of less and less importance, until in man they are all but suppressed. Animals guided by instinct seldom make mistakes, but they cannot adjust their actions to changed conditions. Animals with intelligence, on the other hand, are prone to make mistakes or to do the wrong thing, but they *can* correct their errors and adjust their actions to circumstances.

Tinbergen (1951) in his book on "Instinct" discusses animal behavior that subserves the individual, such as locomotion, feeding,

avoidance of danger, fighting, and reproduction. Activities of this nature are mostly direct reflexes to stimuli and might be termed *instincts of intrinsic behavior* because they have to do with the welfare and life of the individual. On the other hand, many animals have constructive instincts for nest-building, cocoon-spinning, web-making, etc. Such instincts may be distinguished as *instincts of extrinsic behavior*. They are comparable to tool-making, house-building, and the manufacture of mechanical appliances by the human species. As a third class of instincts we might include the migratory drive of some animals, such as that of the eels, the salmon, many birds, and some insects.

Intrinsic behavior is common to all animals, varying according to the habits, structure, and sensory equipment of each species. Extrinsic instincts are most highly developed in the insects, spiders, birds, and some mammals. It is of particular interest because the constructural procedure of the animal often closely resembles human workmanship, and yet is unlearned and acquired by heredity.

Examples of extrinsic instinct among the insects are so well known they scarcely need to be cited. They include the familiar cocoon-spinning of the caterpillars, nest-building by the wasps, comb-making by the honey bees, and the construction of above-ground nests by some termites.

The spiders have long been famous for their spinning of silken webs. The types of webs vary from the too familiar formless mass of threads spun by the house spider to the flat orbs of the outdoor garden spiders. Each species of the latter, as noted by Crompton (1950), builds one fixed pattern of web, but the talents of the different species vary. A relatively simple example of a flat web is that of *Hyptiotes paradoxus*, which is a triangle with two inner radii diverging from the apex, and the interradiial spaces filled with cross-threads. The spider's method of making this web is described in detail by Peters (1938), who shows that the spider follows a complex but entirely orderly plan of construction. Clearly she "knows" in advance what the completed web must be like and exactly how to make it. As many separate acts are involved as there are threads in the web, and yet the spider goes from one to the next as if she carries the whole plan in her mind. Still more elaborate and complex are the orb webs of *Aranea*, but even in the spinning of these webs the spider is just as competent and methodical as *Hyptiotes*.

A human workman making a fabric as intricate as a spider's web would have to learn in advance how to do the job, or he first would work out a plan in his mind or on paper. Then he would consciously direct the action of his arms and fingers for each phase of the work. The spider, on the other hand, never learned how to spin a web, or how to make one of the particular pattern characteristics of her

species. Yet to all appearances she regulates her actions just as does the human workman. She is assumed to work automatically like a machine, with no consciousness to direct her operations. Yet at the end of one act something shifts her nerve impulses to the muscles proper for the next act in the series that leads to the completed web.

In some ways other than web-spinning *Aranea* seems to show something resembling intelligence. When an insect lands in the web, the spider comes out of her retreat to inspect it and takes action according to the nature of the captive or its display of activity. An ordinary fly she carries off at once and makes quick work of it. In the case of a grasshopper she is more cautious and deliberates before acting. Then, according to Crompton (1950), she directs the end of her abdomen toward the grasshopper and throws out a mass of silk, not in the form of threads but as a sheet that completely enswathes the victim, which now bound and helpless the spider drags to her retreat and leisurely feeds on its blood. A wasp or a bee is first examined with suspicious caution. The wasp, evidently recognized as dangerous, is either cut out of the web or allowed to escape by its own efforts; a bee may be successfully wrapped up and carried off. Such acts on the part of the spider look like reasoned judgment, but since the spider is not supposed to have reason, her behavior must be merely reactions according to the nature of the visual stimulus. The spider presumably receives a different ocular stimulus from the fly, the grasshopper, or the wasp, each of which activates an appropriate set of muscles. If we accept this explanation we are faced with the question as to how the nerve connections are prearranged in advance to give the proper response. Either the spider deceives us in appearing to act as if she has some slight degree of intelligence, or we deceive ourselves in thinking that she has none.

The ground-living wolf spider, *Lycosa*, spins no web to entangle her prey, but she encloses her eggs in a silken cocoon, which she attaches to her body and drags with her wherever she goes until the young hatch. As observed by Crompton (1950) the mother *Lycosa* now appears to have such a sentimental attachment to her ball of eggs that she will fight to the death to retain it. Yet she does not know her own cocoon from that of another spider, since she will readily accept a substitute, or even an artificial cocoon made of cork. Clearly the female *Lycosa* does not know that the cocoon she so sedulously guards contains the eggs that will guarantee the perpetuation of her species. Her apparent emotional attachment to the cocoon is merely a temporary physiological condition necessary for the security of the eggs during the incubation period, comparable to the development of the milk glands and the physical modification of the uterus during pregnancy in a mammal. In neither case is "maternal instinct" involved.

The moth caterpillar is another noted silk-spinner. Its spinning apparatus is operative from the time it leaves the egg, but only when the caterpillar comes to the end of its feeding life does some internal condition dictate the spinning of a cocoon. Now, without any preliminary practice, each caterpillar knows just how to construct a cocoon like that of its predecessors in which to await its dissolution in the pupa. The cocoon is for the protection of the pupa in which the adult moth will be formed.

Notwithstanding all that has been written on the subject of animal instinct, the physical mechanism of instinctive behavior is still unknown. Simple instincts may be mere reflexes to stimuli, but complex instincts of action and construction, involving a series of coordinated reflexes, are not easily explainable. A single neuromuscular arc may serve for a simple reflex, but it is hardly to be supposed that a complex instinct involves the presence of as many preformed circuits as there are separate acts in the performance. The spinning spider, then, would have to be a complete, automatic web-making machine constructed to run through the whole series of acts involved in spinning the web. Yet the spider has only one set of muscles, and a different action of the same muscles would have to be stimulated for each act. It would seem, therefore, that there must be some mechanism in the central nervous system that determines the muscular reaction for each stimulus. This may be what has been called the "innate releasing mechanism," but giving something a name does not explain what it is.

Some biologists do not like the term "instinct" because it cannot be defined and is often used to mean some mysterious inner sense of the animal. Yet the word is indispensable for convenience in writing about animal behavior; at least it stands for visible facts.

As we ascend the ranks of the animal kingdom instinct plays an ever-decreasing role until in man it is almost abolished, except for a few acts such as grasping and sucking during infancy. Among the birds, however, instincts for nest-building are equal to anything in the insect world or the web-spinning of the spiders. Many of the smaller rodents dig burrows that are specific of their kind, and the beaver is noted for the construction of dams and the building of houses. The house cat, though she has no idea of sanitation, carefully covers her voided feces when out of doors, and will go through the motions even on a wooden floor. Kittens in their play stalk each other and crouch for a final spring, just as did their unknown ancestors hunting prey in the wild.

Finally there is the seeming mystery of instinct inheritance. If, however, instinct depends, as it somehow must, on physical structure and organization, it is no more inherited as such than are physiological activities, which are functions of inheritable physical organs.

CONSCIOUSNESS

The spoken pronoun "I" usually does not refer to the physical body of the speaker, but to an abstract feeling of conscious individuality that is he himself. Yet no amount of introspection will reveal to us what our consciousness is. Small wonder then that the concept of human duality has long prevailed, that a nonmaterial spirit, soul, or *psyche* resides within our physical bodies, which receives sensations from the outer world, is master of the body, thinks, and gives orders to our muscles. All this, however, from a strictly scientific viewpoint is a creation of the imagination; "spirit" and "soul" are mere words without intelligible definitions. Biologically, we might ask how could an immaterial nothing be duplicated from generation to generation? If the mind is not a function of something material, there is no known mechanism of psychic inheritance, or of mental evolution from ape to man.

Since even the strongest advocates of duality of mind and body cannot explain what they mean by consciousness, some psychologists, as Watson (1930), practically deny the existence of consciousness, and hence that it can dictate our actions. The creed of the behaviorists is "Every human action is a mechanical reflex response to a stimulus." Physiology, according to Mitchell (1923), has for its final goal "nothing less than a complete interpretation of life phenomena in terms applicable to nonliving mechanisms—in short, a physico-chemical explanation of life." He admits, however, the goal is yet far away and dim. Lashley (1923) points out that the mechanistic view of human behavior conforms with the general principles of physical mechanics, and makes the animal no exception. The human body, it is argued, is a physical mechanism and must be subject to the laws of mechanics. Therefore, according to this view an immaterial "mind" or "consciousness" cannot modify or guide the actions of the body.

This argument does not seem to negate the existence of consciousness; it simply denies that consciousness has any activating function, and reduces it to brain action accompanying physical activities. According to Herrick (1924) disembodied functions are not recognized in biology as causes of anything. "It is the functioning organ which is the cause, and it seems to be at least a plausible inference that the observed effects of mind on body are in reality effects of one functioning organ (the brain thinking) on other parts of the body." "Consciousness, then, is a factor in behavior, a real cause of human conduct, and probably to some extent in that of other animals."

There can be no doubt that the seat of consciousness is the brain. Consciousness is totally abolished by serious injury to the brain, or by shutting off the blood supply to it. Consciousness is aroused,

except by abnormal conditions in the brain itself, only by the discharge of sensory nerve impulses into the brain cortex. Troland (1926) believes that consciousness is generated in the nerve association centers (synapses) that occupy most of the cortex. However, we do not locate our feeling of consciousness in the brain. A pain, for example, is felt at the point of physical injury, but if the nerves to the brain are deadened by an anesthetic we do not feel a surgical operation or the pulling of a tooth. In the same way our other sensory perceptions are projected to the objects or conditions that stimulate the sense organs. Consciousness is the perception of what we see, hear, or feel. Yet the brain action, whatever it may be, is essential to the conscious sensation.

Human consciousness, then, is merely a mental experience generated in the brain by nerve impulses from the sense organs. A nerve impulse is a wave of metabolism propagated through the nerve, accompanied by an electrical disturbance, and is the same from whatever sense organ it is engendered. The nerve structure may be adapted to its function, but the resulting form of consciousness depends on the particular brain center to which the nerve goes. Our conscious perceptions correspond with the varieties of sense organs we possess.

Our ordinary state of consciousness, when nothing disturbs us, is the sum of all sensory impressions external and internal received at any one time. If the sensory nerves gradually cease to convey messages, we fall asleep and consciousness disappears.

With most of us awareness of our surroundings seems so real that we cannot doubt the reality of consciousness, if only as a sensation. Surely, pain, fear, anger, pleasure are states of consciousness that may induce muscular movements, but few of us can be convinced that our everyday acts are not consciously dictated. Yet we do not know how we perform actions that we ascribe to intent. Picking up a pencil from the table, for example, seems to be a perfectly simple voluntary act, but the human arm, shoulder, hand, and fingers contain more than 40 muscles, and we do not know what muscles we use, or how they are stimulated and coordinated in action to carry out the dictates of our "will."

Though we must admit, then, that consciousness is real and is somehow a product of brain activity, by no effort of the imagination can we understand it. As said by Sperry (1952): "Despite steady advancement in our knowledge of the brain, the intrinsic nature of mind and its relation to cerebral excitation remains as much an enigma today as it was a hundred years ago." The histologists have found no correlation between the histological structure of the brain centers and the conscious sensations aroused in them. As noted by Sperry, "Present-day science is quite at a loss even to begin to describe the

neural events involved in the simplest forms of mental activity." The physiologists know what goes on in our visceral organs; they have not yet been able to fully explore the secrets of the brain.

It must be noted that our forms of consciousness resulting from sensory stimuli give us little or no information about the nature of the stimuli. From our sensation of illumination and color, for example, we should never know that physical light is vibrations of something traversing space that impinge on the eye. What we call sound is a form of consciousness generated by propagated waves of air. Some people, therefore, cannot understand that there is no sound without an ear to hear it. So with odor and taste, which in consciousness are sensations produced by chemical substances. Truly, in our consciousness we live in a world that does not conform with reality. Only the primitive sense of touch gives us some information about the nature of the object felt, its shape, size, and whether it is hard, soft, smooth, or rough.

Consciousness in ourselves has come to be more than the registration of sensory stimuli. It is also the medium of imagination, memory, and reason. This group of faculties constitutes intelligence, and greatly complicates the efforts of the psychologists to rationalize our mental life according to any theory. It is much easier to understand how we see than how we think. There is no doubt that intelligence has developed with the evolution of the vertebrate forebrain, but it is scarcely perceptible below the mammals. The higher mammals can learn by "trial and error," and they exhibit many human emotions, but it is highly doubtful that any but the human species is capable of abstract reasoning.

It is a long-disputed and still unanswered question as to where consciousness begins in the animal kingdom. Since pain is a most acute form of consciousness, it would seem reasonable to believe that any animal that gives vocal evidence of feeling pain must have consciousness. This would include the mammals and birds and perhaps the frogs, but lack of a voice can hardly be taken as evidence of insensitivity to pain. We cannot positively assert that the higher invertebrates do not have some dim awareness of their surroundings or of their actions. It is hard to imagine that an insect or a spider, for example, is merely a mechanism responding automatically to stimuli that in us generate consciousness. Consciousness in other animals, however, is beyond experimental investigation, and probably will long remain a secret of the animals themselves.

The greatest literary crime that can be brought against a writer on animal behavior is indulgence in anthropomorphism—the attributing to animals of human motives and reason. Yet there is plenty of animalism in the human species, and some recent accounts of animals in nature, such as that of the African lioness by Adamson (1960,

1961) and of the otter by Maxwell (1961), suggest that animals may be more human than we have been willing to admit. After all, we have a common ancestry.

Since most of our body structures and our mental faculties have been evolved from our animal progenitors, it is reasonable to suppose that the sensation of awareness arose in some form of life much lower in the scale of evolution than ourselves. Perhaps consciousness began as an adjunct to instinct, but having a high survival value of its own, it underwent evolutionary improvement, gradually eliminating the need of instinct. Finally, consciousness became the basis of the higher mental faculties, and set us apart, at least some of us, from all the other animals.

REFERENCES

ADAMSON, JOY.

1960. *Born free. A lioness of two worlds.* 220 pp., numerous photographs. New York.

1961. *Living free. The story of Elsa and her cubs.* 161 pp., numerous photographs. New York.

ADLER, I.

1957. *How life began.* 128 pp., ills. New York.

ALLEN, R. D.

1962. Amoeboid movement. *Scientific American*, February 1962, pp. 112-122.

BONNER, D. M.

1962. *Heredity.* 112 pp., 41 figs. Englewood Cliffs, N.J.

CROMPTON, J.

1950. *The life of the spider.* 192 pp., 23 figs. New York.

FISCHBERG, M., and BLACKLER, A. W.

1961. How cells specialize. *Scientific American*, September 1961, pp. 124-140.

GAMOW, G.

1952. *The creation of the universe.* 147 pp., 40 text figs., 11 pls. New York.

HERRICK, C. J.

1924. *Neurological foundations of animal behavior.* 334 pp., 131 figs. New York.

JACOB, F., and WOLLMAN, E. L.

1961. Viruses and genes. *Scientific American*, June 1961.

JEANS, J.

1929. *The universe around us.* 341 pp., 24 pls., 24 figs. New York and Cambridge.

KEPNER, W. A., GREGORY, W. C., and PORTER, R. J.

1938. The manipulation of the nematocysts of *Chlorohydra* by microstomum. *Zool. Anz.*, vol. 121, pp. 114-124, 4 figs.

LASHLEY, K. S.

1923. The behavioristic interpretation of consciousness I, II. *Psychol. Rev.*, vol. 30, No. 4, pp. 237-277; No. 5, pp. 329-355.

LEHRMAN, R. L.

1961. *The long road to man.* 192 pp., 53 figs.

LEWIS, I. F.

1940. Cell reactions. *Amer. Naturalist*, vol. 74, pp. 97-106.

MAIER, N. R. F., and SCHNEIBLA, T. C.

1935. Principles of animal psychology. 529 pp., 107 figs. New York and London.

MAXWELL, G.

1961. Ring of bright water. 211 pp., numerous illustrations. New York.

MAZIA, D.

1953. Cell division. Scientific American, August 1953.

MITCHELL, P. H.

1923. A text book of general physiology. 748 pp., 174 figs. New York.

MOSKIN, J. R.

1962. In the next twenty-five years, man will master the secret of creation. Look, special issue, January 1962, pp. 44, 46.

NEEDHAM, J.

1942. Biochemistry and morphogenesis. xvi+787 pp., 328 figs. Cambridge Univ. Press.

OPARIN, A. I.

1938. The origin of life. 270 pp., 8 figs. New York.

1961. Life, origin of. The Encyclopedia of the Biological Sciences (ed., Peter Gray), pp. 561-563.

PETERS, H.

1938. Über das Netz der Dreieckspinne, *Hyptiotes paradoxus*. Zool. Anz., vol. 121, pp. 49-59, 5 figs.

PLATT, R.

1961. When life on earth began. Reader's Digest, December 1961, pp. 194-200.

SCHRÖDER, K.

1936. Beiträge zur Kenntnis der Spicularbildung, der Larvenspiculation und der Variationsbreite der Gerüstnadeln von Süßwasserschwämmen. Zeitschr. Morph. Ökol. Tiere, vol. 31, pp. 245-267, 24 figs.

SPERRY, R. W.

1952. Neurology and the mind-brain problem. Amer. Scientist, vol. 40, No. 2, pp. 291-311.

TINBERGEN, N.

1951. The study of instinct. 228 pp., 130 figs. Oxford.

TROLAND, L. T.

1926. The mystery of mind. 253 pp., 22 figs. New York.

UREY, H. C.

1952. The planets: their origin and development, xvii+245 pp., 16 figs., photograph of the moon. Yale Univ. Press.

WALD, G.

1954. The origin of life. Scientific American, vol. 191, August 1954, pp. 44-53.

WATSON, J. B.

1930. Behaviorism. 308 pp., 23 figs. New York.

Civilization and the Landscape¹

By SYLVIA CROWE

Past President of the Institute of Landscape Architects (British)

[With 4 plates]

The birth of a civilization may perhaps be defined as that moment when men first become conscious of their surroundings. The subsequent history of civilization is the progressive distillation of human consciousness out of the background of the physical world.

If we accept this, then it follows that there can be no civilization without impact on the landscape, and further, that the more complex the civilization becomes the greater this impact will be. One aspect of this has been dealt with brilliantly by Edward Hyams in "Soil and Civilization." Here are set out the interactions of civilization and ecology and the effect on soil, fertility, and balanced landscape of the demands which civilized men make upon their habitat. In precivilization man accepts the landscape as his natural environment; he is just one member of a country's fauna. His impact is no greater than that of other creatures. In too great numbers he will erode his surroundings as too great numbers of rabbits will do, but he is subject to the same natural controls as other creatures, and the landscape, given time, will heal over his depredations.

Nomadic tribes depend on the power of the landscape to regenerate, and both they and their habitat only prosper if the interval between their depredations is long enough for the natural ecology to reestablish itself.

But civilization cannot develop under these conditions. It can only grow by a release of surplus energy which allows man time to think and to create. Therefore its first necessity is to find surplus wealth and to use it to provide leisure and power. To acquire this wealth one civilization after another has raided the landscape's capital, robbing it of trees, fertility, and water. But ultimately no civilization can survive unless it learns to repay this capital and to live on

¹ Reprinted by permission of the Royal Society of Arts, from the first Reflection Riding Lecture. The Reflection Riding Lectures are named after the park of that name in Tennessee.

the income from its natural resources. Our present civilization has carried this destruction of the landscape further than any of its predecessors, and this poses one of the most urgent questions of today: Can we repair the ravages of the past and so manipulate the landscape that it will yield an income on which the people of the world can live? In terms of food production there is little doubt that this could be done. Whether sufficient world resources will be made available to achieve this end is another question.

Throughout history, men's attitude to the landscape has shown sometimes a negative and sometimes a positive approach. The negative approach regards the landscape either as a storehouse to be plundered, or an enemy to be subdued. The positive one recognizes it as an organism of which man is a part, the only thinking part, and therefore the landscape becomes something to be manipulated and cared for, as if it were his own body. The negative approach has resulted in the dust bowls of America and the black country of Britain. The positive approach has produced, among others, the landscapes of Tuscany, of Holland, and of agricultural Britain.

These landscapes show us that good husbandry is the foundation of good landscape, but it is not the whole of it. Parallel to the problem of physical survival runs the more elusive problem of the growth of true civilization, of the widening of our consciousness and awareness, our enjoyment of the whole created world, for without this conscious enjoyment we are little better than ants or machines.

Very early in all civilizations men have wanted to shape their surroundings to their desires. The first manifestation of this desire is the creation of a garden, a private paradise set apart from the hostile world. But in time, with extending consciousness, men look further afield and extend this creative urge to the wider landscape. The chief concern of landscape architecture today is to explore the forms which this creative urge should take, for never before in history has so great an area of the earth's surface been under the influence of the human species.

To understand our present attitude to our surroundings, we must look back to the dawn of western civilization. How did the Greeks regard their landscape? Certainly they venerated it, for they peopled its most sublime aspects with their gods, who gave divine protection to the mountaintops and springs. When they built upon it, the clear thought and exact mathematics of their temples were imposed directly upon the untouched and sublime background. The two were distinct and contrasted. The clear lines of human thought were drawn onto the background of nature's organic growth, forming perhaps the most beautiful of all juxtapositions. Yet though the contrast was strong and clear, it was not insensitive. The mathematics was

inflected, the columns modified to suit the foibles of the human eye; the Parthenon curves imperceptibly to acknowledge the land formation of its hill. Surely the Greeks knew that geometry and organic form are two facets of a single truth.

In direct lineage from Greece, down through the Mediterranean tradition in Italy, in France, and in parts of Spain, we can trace the clarity of the Greek and Latin brain revealed in the ordered lines of logical thought superimposed upon the organic landscape. But other races have approached the landscape in a different way. They have been more conscious of themselves as a part of nature, less ready to stand aloof and impose upon it their thought patterns. The Celt and the Oriental, for instance, both show a strong identification of themselves with nature. Compare the stone walls of Celtic Britain, twisting with the ground form, making a part of the organic pattern, with the stone terraces of Spain, exact and hard, ruled lines which mark the extent of man's domination and run straight and uninflected into the wild hillside. Or contrast the idealized natural landscape of an Oriental garden with the clear, masterful logic of Le Notre's Vaux-Le-Vicomte.

A leaning toward the Celtic and Oriental attitude of identification with nature is, I believe, likely to be more fruitful at our present stage of development than the more detached classical approach.

The impact of human activity on the landscape goes through two stages. In the first stage men's work is placed directly on an untouched background. The background, because it is not interfered with, maintains its natural ecological balance. In the second stage, men adjust the background to accept and complement their work. When the classical tradition reaches the second stage it tends either to overreach itself, as for example in the grandiose pattern of avenues which the 17th-century landowners imposed on the landscape, or, more happily, it makes a concession to the natural approach as in the planting of bosche which merge the formal terraces of the Italian Renaissance gardens into the flanking hillsides. The natural tradition, on the other hand, can extend itself indefinitely, welding, adjusting, but never destroying or contradicting the surrounding landscape.

A superb example of this technique is seen in the estates of 18th-century England. In these it is hard to define the frontier between agriculture, adjusted to man's delight, and pure pleasure grounds shaped as idyllic landscape. This gives to the classical element, confined to the building and perhaps its immediate surroundings, a setting large enough to let it register as a clear statement of human thought seen against a background of natural growth.

The same technique, on a vastly greater scale, can serve us today in recreating an organic landscape, extensive enough to take the patterns of our inventions, as the Greek hills were great enough to take their temples.

We have to find the way to combine these two ideas, man as a conscious part of his natural background and man the mind apart which uses the lines of truth, of logic, and of power to superimpose a new pattern on the landscape, for both these ideas are aspects of the same universal pattern and subject to the same universal laws. The question of the coexistence of these two elements in the landscape is the counterpart of the current argument of science versus the humanities. The answer to both problems is the same, the apparently opposed ideas are both part of one whole, but just as science is only valuable insofar as it helps humanity to evolve into a state of higher consciousness, so the application of science to the landscape is only viable if it encourages the development of a higher and richer form of organic ecology.

For example, the use of science and machinery to irrigate a desert is an enrichment of life and of the landscape, but the use of science to apply indiscriminate poisons is an impoverishment, even if it results in an immediate cash gain.

The problem of introducing men's inventions into the natural ecology has only recently become apparent in its full force. As long as a naturally balanced landscape formed the backcloth to man's activities, it was comparatively easy to adjust this natural background to accept man's works, especially while his chief activity was agriculture, which is only a variation on nature's own theme. But now the fertility of man's inventions has tilted the balance against the organic landscape. It is in any case far harder to find the synthesis between mechanics and the landscape, that is, to fit the inorganic into the pattern of the organic, than to carry out organic changes. Yet the extent of inorganic constructions is constantly growing in relation both to previously untouched natural landscapes and to agriculture. These constructions are no longer incidents seen against an unbroken organic countryside like a single castle on a hill, or a viaduct across a valley. They are sufficient in size and number to wreck a landscape unless they can be assimilated as elements within it. At the same time, the number of men as well as their new mobility is exerting a crushing pressure on the landscape's ecology. This is why it is essential for us to take a more active part in the evolution of the landscape than men have ever done before. To do this we must first study the biology of the landscape and realize its infinite ramifications. Then we must extend our conception of ecology to include the new complex which we are creating with our inventions and the new numbers of the human element. Finally we must understand our-

selves and the civilization for which we are trying to build an environment. Only if we see clearly the goals of our civilization may we hope to achieve a setting for it.

Where the landscape suffers as a result of civilization, either the ideals of that civilization are at fault or it means that the whole truth and implications of the ideal have not been grasped, some angle of life has been neglected, some secondary interest overstressed. This lack of balance is evident both in individual countries and in the world as a whole. For the balanced landscape must be seen as a world concept. If "no man is an island entire of itself," still less is any country. We can no longer countenance the destruction of one part of the earth's surface to supply riches for another; nor the desecration of one part to provide a playground for another.

Yet the action of one country can have repercussions in others far removed from it. For example, the wreckage of three landscapes, in different parts of the world, can be traced to the same cause, an overemphasis on the benefits of industrial wealth. The dust bowls of Australia and America were formed in providing cheap food for the industrial revolution which resulted in the black country of Britain.

But while we need a landscape balanced on a worldwide scale, we need also the full richness and variety of local ecology, without which the evolution of both life and thought must stagnate. There are signs that the moronic idea, so prevalent in the last generation, that any organism not directly profitable to man could be dispensed with, is gradually giving way to the realization that only the full variation of landscapes and of organisms can give the rich textures which make a fully conscious life possible. This dawning realization marks an advance in man's relationship to the landscape. He has left behind the stage of unconscious membership, and the stage of exploitation, and is reaching toward the stage of conscious partnership.

But this fresh outlook, full of hope as it is, is at present only a very small current stirring against a strong running tide. For by far the more obvious forces are still those hostile to the landscape; if not consciously, then through ignorance and apathy.

Pressure of population on restricted areas, greed, the deification of the profit motive, the belief that speed, machines, and mass production are good in themselves, rather than as servants of humanity, all these flaws in our civilization are the cause of scars upon our landscape. They result in soulless housing development, holiday resorts where natural beauty is obliterated under tarmac and tawdry buildings; wildlife, both plant and animal, exterminated for quick profit; advertisements defiling the countryside; industries polluting rivers and pouring waste upon good land. All these things may bring quick cash profit, but they impoverish human life and cause long-term damage to the landscape.

This flood of destruction has been running for over a century and in many places is still spreading at an accelerated pace. The havoc to the landscape is too well known to need reiterating, but perhaps less well known are the re-creative efforts being made in many parts of the world to stem the flood and rebuild a fertile landscape capable not only of feeding but also of refreshing mankind.

Some of the greatest efforts in creative landscape are being made by two small countries, entirely different in climate, geography, and history. Holland and Israel are each building a new landscape, one from the sea and the other from the desert.

In the case of Holland this is nothing new. They have been doing it for 900 years, but their present approach to the problem is new. In the old days their sole objects were to provide fertile land and sweet water and to hold back the sea, and their works of reclamation were carried out mechanically to achieve this with the greatest material economy. But today their object is no longer confined to the production of a food factory. The newly reclaimed polders are also designed as pleasant places in which to live. Social needs, recreation, and beautiful landscape are all added to the basic requirements of mere existence, while the study of every variation in soil potential and local climate is resulting in a varied and organic pattern as opposed to the mechanical outlines of the old polders.²

In Israel the basis of their new landscape is irrigation of the desert; but here again the creation of so many acres of land for crops is not their only consideration. The land is also their home. Step by step with the new fertility go the planting of shade trees, the provision of parks and gardens, the formation of a complete and complex landscape within which men may live full lives.

These two examples show the possibilities of creating a fully humanized landscape, a new habitat, purpose-designed for civilized men with all their varied needs. The conditions have been unusual, for a blank page was presented on which the landscape builders, in both cases people who had already attained to a high state of civilization, could design a setting for a known condition of life. The more usual case is for a landscape and a civilization to evolve slowly together, as has happened in Britain, or for a civilization to grow and then invade a landscape which is already functioning in some degree of natural balance. This was the case in the United States of America.

In the case of Britain, the problem is to find the right adjustment between the new needs of expanding population and the old landscape. We have to reconcile the desire for mobility, increased communications and less arduous work, all goals which require industry

² See "Designing on New Land," by Arthur Glikson, in "Space for Living," published by Djambatan.



1. Reflection Riding. A view of the road known as Reflection Lane.



2. Reflection Riding. The little field along Lookout Creek called Cornish Horizons. Lookout Mountain beyond. (Photo by J. B. Collins.)



1. Reflection Riding. View from the road that winds for 3 miles to Lookout Mountain above.



2. Reflection Riding. A view of Lookout Mountain across the field known as Candy Flats.
(Photos by J. B. Collins.)

and machines, with the desire for peace and community with nature which only the countryside can give, and which can be destroyed by the same machines which give us leisure and mobility.

The lines on which we are attempting to work are becoming clearer, although we are very far from either finding a solution or even attaining general agreement on our aims. As a first step a certain extent of landscape zoning is accepted, such as the designation of National Parks and Areas of Outstanding Natural Beauty. These designations give varying degrees of protection to the old landscape with its established balance, its peace and its quietness. In defense of these values we have official bodies, such as the National Parks Commission, and the Nature Conservancy, and unofficial bodies such as the Council for the Preservation of Rural England. Change comes to these protected landscapes, but in general it comes slowly enough to be absorbed.

Secondly, we are progressively trying to improve the design of our new structures and their relationship to the old landscape. The progress in this direction is shown by the growing number of public authorities and industrialists who take architectural and landscape advice on the design, siting, and setting of their structures, whether these be roads, power stations, reservoirs, factories, or housing.

The third hopeful sign is the beginning of the counterattack on waste areas. Some old slag heaps are being afforested, others cleared away. Gravel pits are being filled or converted into lakes and stocked with fish. Many county councils, who are the planning authorities for their areas, are actively engaged in this work of regeneration.

There is a slight lessening of pollution in our rivers, clean air is already increasing the range of plants which will grow in London, and, most important of all, there is a growing public demand for this cleaning-up process. The movement is very slow, but it is perceptible.

One of the chief causes of failure is that we have not realized that the landscape is one interrelated, biological complex in which water conservation, flooding, afforestation, agriculture, and all the works of man and nature are linked and interacting. If a landscape is to live, all its parts must work together like the cells of an organism. This can only be achieved by overall landscape planning by men who understand the anatomy of the landscape, as a doctor understands the anatomy of the human body.

Perhaps no country has seen such rapid and extensive inroads into hitherto wild landscapes as the United States of America. In her case a land untouched by civilization has been subjected in the course of two centuries to the most rapidly expanding economy the world has ever seen.

As a result the two facets of man's relationship to the landscape, man the destroyer and man the creator and preserver, can be seen

here in acute conflict with each other. While in some places the heritage of a unique landscape is being destroyed by unplanned development, in others new and magnificent landscapes are being created. The T.V.A. stands as a supreme example of a landscape manipulated for the full enjoyment of men as well as for the creation of material wealth, while still conserving the richness of the natural ecology. Yet perhaps America's best-known contribution to the reconciliation of civilization and landscape lies in her national parks. Because of her wealth, America more than any other nation is faced with the problems raised by recreation. Townspeople long for the contrast of wild country and for the release from city tensions which it brings, yet in going to the country they destroy it. In an attempt to reconcile this contradiction, the National Park Service of America is doing two things: First, by care, knowledge, and devoted service, the complete ecology of great areas of natural landscape is being preserved; second, by education within the parks, town people are learning to understand and respect wild nature. Thus landscape reserves are being held inviolate by legislation and protected from their admirers. Necessary and admirable as this service is, it must be regarded as a holding operation; our civilization cannot claim to be truly civilized until the respect now enforced by law is each man's natural reaction to his surroundings. Moreover, the frantic urge to reach the few remaining areas of peace and beauty, which now imperils them, can only be lessened when civilization has learned to make the whole landscape a proper habitat for men.

These few examples from different parts of the world, each with its own problem, show how the idea of adjustment between men and the landscape is slowly growing. It is indeed a discouragingly small effort compared to the vast forces of destruction, but because it is a positive ideal as opposed to a negative, it has the cumulative strength of all living things, which must in the end prevail against inertia.

If this present civilization does not perish, it will be because it has found the way to create a new ecology combining the emanations of men's skill and brains with the ecology of organic nature and has learned to fashion from this a new landscape within which men can function not merely as economic units, but as men.

How Many People Have Ever Lived on Earth?¹

By ANNABELLE DESMOND²

How many people have ever been born since the beginning of the human race?

What percentage does the present world population of 3 billion represent of the total number of people who have ever lived?

These questions are frequently asked the Population Reference Bureau's Information Service. Because of the perennial interest and because of the credence sometimes given to what would seem to be unrealistic appraisals, this issue presents an estimate prepared by Fletcher Wellemeyer, Manpower, Education and Personnel Consultant, Washington, D.C., with Frank Lorimer of American University, Washington, D.C., acting as adviser. This estimate, based on certain statistical, historical, and demographic assumptions set forth in the appendix, should be regarded as no more than a reasonable guess. It assumes that man first appeared about 600,000 years ago, a date which has been proposed for the dawn of the prehistoric era. However, this date obviously is a compromise, anthropologically speaking, between varying extremes.

Since then, it is estimated that about 77 billion babies have been born. Thus, today's population of approximately 3 billion is about 4.0 percent of that number.

Absolutely no information exists as to the size and distribution of prehistoric populations. Presumably they were not large, nor very widely distributed. If the 600,000 B.C. date is accepted as a sound compromise, then only about 12 billion people—less than one-sixth of the total number ever born—are estimated to have lived before 6000 B.C.

Anthropologists and paleontologists differ by hundreds of thousands of years as to when man first walked this earth. Recent discoveries strongly suggest that the life-span of the human species might

¹ Reprinted by permission from *Population Bulletin*, vol. 18, No. 1, February 1962.

² This article was based on a research report prepared by Fletcher Wellemeyer, with the technical assistance of Frank Lorimer, and on supplemental research by Georgia Ogden.—ROBERT C. COOK, editor, *Population Bulletin*.

date back as much as 2 million years. However, this time-scale has not yet been accepted by all anthropologists.

If the "beginning" actually extended a million years prior to 600,000 B.C., the estimated number of births prior to 6000 B.C. would be 32 billion, and the estimated total number, about 96 billion.

Prior to 1650, historical population data are very scanty for every part of the world. Despite this lack of knowledge, ancillary evidence exists which reveals the general pattern of human growth. Throughout the thousands of centuries which preceded the present technological age, human survival was such a touch-and-go affair that high fertility was essential to balance brutally high mortality. The human female—a relatively slow breeder, even among mammals—had to reproduce somewhere near her physiological limit in order for the family, the clan, the tribe, and the nation to survive.

As human culture developed over the ages, the chances of survival tended to improve. When the invention of agriculture provided a more stable food supply, the base was laid for the maintenance of large populations and for their spread into new areas. However, high death rates continued to check population growth.

Until recently, at least a half of all babies born died before reaching maturity. Man's quest for some formula to avert death included magic, incantations, and prayers, but none of these had shown any efficacy against the major killers. Then, with the advance of modern science, the mortality pattern of a million years was broken.

Jenner's dramatic discovery of vaccination for smallpox was the first of a multitude of discoveries destined to defer death, especially in infancy and childhood. This brilliant application of the scientific method to biology and medicine, together with improved agricultural technology, better transportation, and the vast and complex nexus of an emerging industrial culture, set in motion forces which drastically lowered death rates and thereby greatly increased the efficiency of reproduction. In some countries, the birth rate declined also, although more slowly than the death rate. During the 19th century, the industrial countries of the West were the first to experience the transition from high to low birth and death rates. This transition took about 150 years.

These epochal changes profoundly altered the patterns of survival and population growth. In those countries of northern Europe and North America which were the first to exploit effectively the new medical discoveries, life expectancy at birth rose rapidly from 30 years to 40, then to 50, and, by 1960, to 70 years and more. Infant mortality declined drastically: now, 95 out of every 100 babies born in Western industrial countries live to reach adulthood.

Although the power to defer death is one of the greatest advances in man's long history, it has been the principal factor in the accelera-

tion in the rate of population growth during the past century. Now, public health programs reach even the world's most remote villages, and death rates in the less developed areas are falling rapidly. But the traditionally high birth rates—so essential to offset the high death rates of even the very recent past—remain high. Thus, population growth soars.

Therefore, over the long span of history, the rate of population growth has tended to accelerate—almost imperceptibly at first; then slowly; and recently, at a rapid clip. By the beginning of the Christian Era, 200 to 300 million people are believed to have lived on earth. That number had grown to some 500 million by 1650. Then the growth curve took a sharp upward trend. By 1850, world population was more than 1 billion. Today, it is over 3 billion.

The quickening tempo of growth is even more dramatically expressed in doubling time. It took hundreds of thousands of years for world population to reach the quarter-billion mark, at about the beginning of the Christian Era. Over 16 centuries more passed before that number reached an estimated half-billion. It took only 200 additional years to reach 1 billion, and only 80 more years—to about 1930—to reach 2 billion. Population growth rates are still going up. During all of the eons of time—perhaps as long as 2 million years—the human race grew to its present total of 3 billion. But it will take only 40 years to add the next 3 billion, according to United Nations estimates. In certain nations and larger areas, populations will double in 25 years or even less, if growth rates remain unchanged.

This historical review traces the proliferation of the human species through three very broad time-spans: Period I extends from 600,000 B.C. to 6000 B.C.; Period II extends to A.D. 1650; and Period III, to 1962. These time periods are chosen because the dates mark important epochs in man's cultural development.

It should be emphasized, however, that not all portions of the globe experienced simultaneously the cultural and technological advances which mark these different stages of man's history. When the first European settlement was established in Australia in 1788, the aborigines there were in the Stone Age. Even today, some tribes living in New Guinea and elsewhere still remain at that level.

PERIOD I—THE OLD STONE AGE

Period I extends from 600,000 to 6000 B.C. It begins early in the Paleolithic or Old Stone Age and continues to the beginning of the Neolithic or New Stone Age. It is estimated that during this period numbers grew to about 5 million, that man's birth rate was close to 50 per thousand, and that there was an approximate total of 12 billion births.

Little, if anything, is known about population size during this hunting and gathering stage of man's existence. The total land area of the earth is approximately 58 million square miles. It seems reasonable to assume that not more than 20 million square miles could have been used successfully by the relatively few who inhabited the earth at that time. The consensus of competent opinion indicates that, on moderately fertile soil in a temperate climate, about 2 square miles per person would be needed for a hunting and gathering economy.

It must be assumed that there were severe limitations on man's numbers during this period; and that his life cycle and average generation were much shorter than they are today. Man existed for the most part in wandering bands in order to survive. Our ancient ancestors were completely subject to all the vagaries of the weather and the ecological cycle of the game animals on which their existence depended. Food shortages were usually endemic, and the ravages of epidemics were routine—although the wide dispersal of the population tended to localize these hazards. Nevertheless, the picture that emerges is one in which births and deaths were roughly balanced, with births perhaps holding a narrow margin.

THE LONG TIME-SPAN OF PREHISTORY

Anthropologists and paleontologists are gradually putting together, piece by piece, the great jigsaw puzzle that is the history of early man. T. Dale Stewart, eminent physical anthropologist of the Smithsonian Institute in Washington, D.C., points out that only a few fossils of humans who lived in this period have been found. Nevertheless, man's long time-scale is known today with far greater accuracy than ever before, mainly because of the new radioactive dating techniques. According to Dr. Stewart, new discoveries demand new theories or the adjustment of existing theories.

The remains of *Zinjanthropus*, recently found in the Olduvai gorge of Tanganyika by L. S. B. Leakey, Curator of the Coryndon Museum, Nairobi, Kenya, which Leakey believes date back almost 2 million years, probably do not represent the beginning of the line. *Zinjanthropus* has been called man because he was a toolmaker, in the crudest sense. Since his physical form represents a very early stage of human evolution, it is not advisable to assume so early a beginning for purposes of estimating human population growth.

However, it is generally believed that "man" had reached the point of being able to make simple tools and to talk by a half million or even a million years ago. *Homo sapiens* first appeared with great force in Europe sometime between 25,000 and 30,000 years ago, though he presumably emerged much earlier. Very little is known about where he came from or about his connection with the Neanderthal people who were one of many types of man to precede him. By

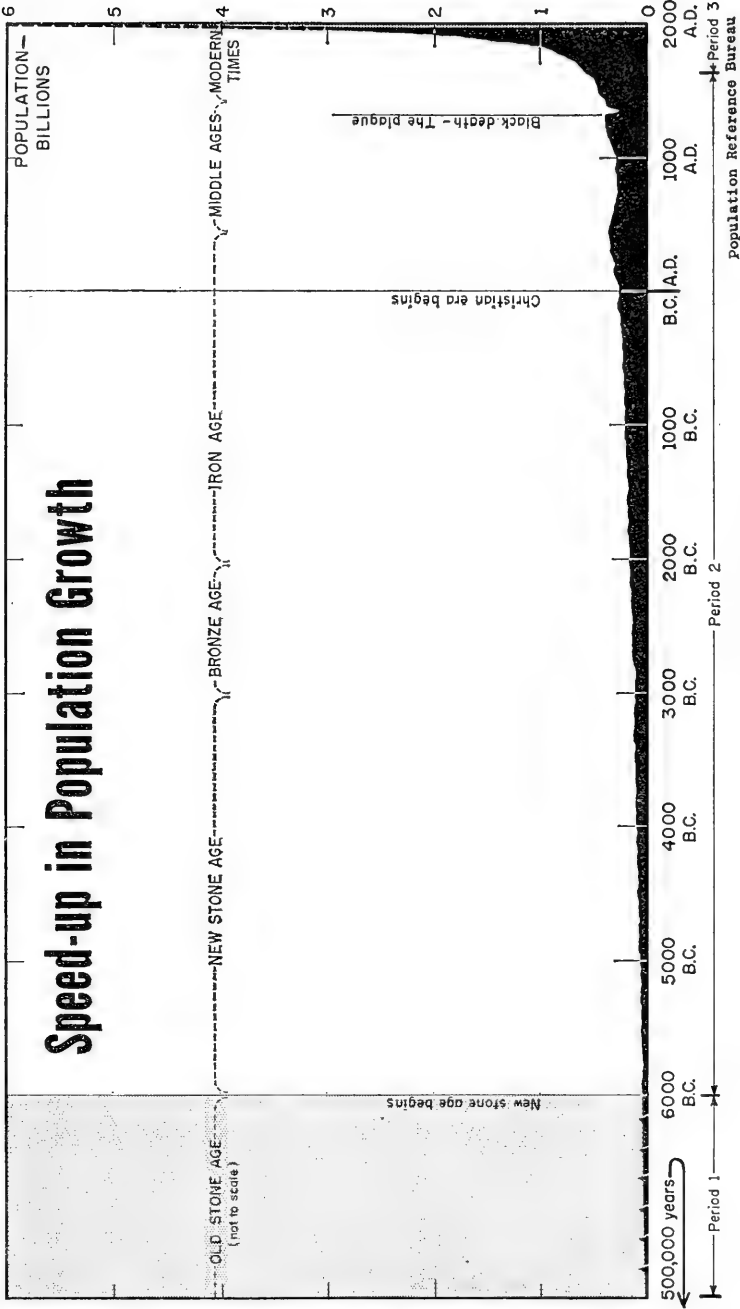

FIGURE 1.—GROWTH OF HUMAN NUMBERS

It has taken all the hundreds of thousands of years of man's existence on earth for his numbers to reach 3 billion. But in only 40 more years population will grow to 6 billion, if current growth rates remain unchanged. If the Old Stone Age were in scale, its base line would extend 35 feet to the left!

20,000 B.C., he had created the first great art in human history: the magnificent paintings and other artifacts found in certain caves in southern France and northern Spain. He engraved and carved bone and ivory with faithful representations of his women and of the animals he knew so well: the mammoth, the bison and others. These were believed to have had magic significance—to bring fertility to the clan and success to the hunter.

No birth rates or death rates have ever been found on the walls of the prehistoric caves. Thus, what is the puzzle of man to the anthropologist and the paleontologist becomes the enigma of man to the demographer. A United Nations Report, "The Determinants and Consequences of Population Trends," published in 1953, presents a comprehensive survey of world population through the whole of man's history. Readers are referred to it for a more complete historical survey than this limited space permits. The report states:

That men, using tools, have been living on this planet for at least 100,000 years, and possibly for over a million years, is proved by various types of evidence. For example, the definitely human skeletal remains found at Choukoutien, China, in association with artificial stone and bone implements and possible indications of the use of fire, were deposited during the second interglacial period, or earlier. There is evidence, also, that several divergent types of men emerged, some of whom had specialized characteristics which place them outside the ancestral line of all living races today. The Neanderthal people, who were dominant in Europe during the last (Würm) glaciation, were apparently such a divergent race.

PERIOD II—6000 B.C. TO 1650 A.D.

Starting with the beginning of the New Stone Age, this period extends through the Bronze and Iron periods, through classical antiquity and the Dark Ages, the Renaissance, and the Reformation. It is estimated that world population increased one hundredfold during the period, growing from 5 million to half a billion, and that about 42 billion births occurred.

It is believed that at the beginning of the era the earth was still very sparsely settled and population was widely dispersed. Vast areas of the globe were not inhabited, partly because the last glaciations had just receded.

It was during this period that man began to *produce* food instead of simply consuming what nature had laid before him. In the Near East, he had already passed the stage of the most primitive village-farming communities which grew out of the earliest agriculture with its domestication of animals. Some of these ancient communities developed into the earliest known urban settlements. The development of agriculture with its settled farming community spread to other areas of the earth during this period. Eventually, it was to change drastically man's pattern of survival and his way of life.

The earliest scene of settled village-farming communities appears to have been in the Near East. Robert J. Braidwood, Professor of the Oriental Institute of Chicago, and Field Director of the Jarmo Project, a recently studied archeological site in Iraq, says:

It is probably very difficult for us now to conceptualize fully (or to exaggerate) the consequences of the first appearance of effective food production. The whole range of human existence, from the biological (including diet, demography, disease, and so on) through the cultural (social organization, politics, religion, esthetics, and so forth) bands of the spectrum took on completely new dimensions.

Braidwood described the hilly piedmont and intermontane regions surrounding the great "Fertile Crescent" which starts in the valleys of the Tigris and Euphrates Rivers, sweeps around to the north to touch southern Turkey and Syria, then curves south to the shores of the Mediterranean and into Egypt. One radioactive-carbon date suggests that this development was well advanced by 4000 B.C.

Sheep, goats, pigs, cattle, and some kind of horselike animal were used by those living in the area. Their plants were wheat and barley. Braidwood notes that some sort of hybridization or mutation, particularly in domesticated plants, must have taken place before certain species could have been moved to other areas. However, they seem to have moved into the Danube Valley by 4000 B.C., and into western Europe by 2500 B.C.

In other words, man was learning to utilize his environment more efficiently; thus it could support more people than ever before. But numbers were still regulated by the food-producing quality of the land. Population grew in times of plenty and declined when food became scarce and when disease decimated large populations, as it did in Europe during the Dark Ages.

During the Bronze Age, man began to use copper and bronze and to build towns, cities, and states. Kings, advanced religions, social classes, writing, and enduring monuments, such as the Nile pyramids, appeared during this period. The Iron Age brought iron metallurgy, the invention of the alphabet, the use of coined money, and the spread of commerce and navigation.

The early and great empires and cultures developed: those of Egypt, Rome, and Greece; of King Asoka in India; of the Han dynasty in China; and, later, the empires of the Mayas and the Incas in the New World. The Hindu, Confucian, Buddhist, Jewish, Christian, Muslim, and other great religions emerged.

THE CITY—PERIOD II

The great cities of ancient times rose in rich valleys adjacent to the Mediterranean, the Red Sea, and the Persian Gulf, along the Indus and the Nile, and along the Yangtze in China. The first great urban

civilization arose about 3500 B.C. in Mesopotamia, along the Tigris and Euphrates. Another grew up in Egypt before 3000 B.C. and still another in Crete. A fourth arose along the banks of the Indus in western India, but whether this grew directly out of Neolithic beginnings or was a transplant of the Sumerian culture of Mesopotamia is a matter of dispute. Urban civilizations developed in China at a later date, and still later in some areas of tropical Central America and in Peru.

The urban societies of Mesopotamia, China, and Egypt maintained complex centralized control of soil and water resources in order to provide irrigation and to control floods. These "hydraulic" civilizations supported very dense populations with highly integrated social systems. The individual peasant was allowed a small land area which produced more food than his family needed. Such civilizations have persisted in Egypt, India, China, and elsewhere to the present day, with little change in the economic basis of life but with periodic rises and declines.

The ancient Mediterranean, Asian, and American urban civilizations appear to have been isolated flowerings of human culture which culminated in "golden ages" and then declined. The archeological record abundantly reveals their wavelike nature. For additional information, readers are referred to an earlier issue of *Population Bulletin*, "The World's Great Cities: Evolution or Devolution?" (September 1960).

THE A.D. ERA OF PERIOD II

The United Nations study previously mentioned states that, at the beginning of the Christian Era, the world's population was likely to have been between 200 and 300 million people. Discussing the lack of historic demographic information, the report states:

Various kinds of evidence indicate that man's numbers became adjusted to the food-producing capacity of the land in ancient times—increasing as it rose and declining as it fell. Unfortunately little of this evidence is of a census type, and most of the remainder does not provide a basis for estimating the number of inhabitants of an area. Large parts of the world's population were subject to some sort of census enumeration near the beginning of the Christian era, but the information available from these censuses has limited value. Roman censuses were taken for administrative purposes and were restricted to "citizens," an expanding category as citizenship rights were extended to outlying regions. Moreover only adult males were included in some of these censuses, while all household members except "children" were included in others. Chinese censuses at about this time provided reports on total population but interpretation of the results involves many difficulties. Elaborate records were kept by the ancient Incas, but their meaning is obscure.

J. C. Russell, Professor of History at the University of New Mexico, who has contributed much to the demographic history of the West,

has traced the population changes within the Roman Empire from the second century A.D. to the year A.D. 543, a period he characterizes generally as one of imperial decline:

. . . However, within the general picture there are great differences in the trends. Actually most of the decrease occurred in western Mediterranean lands: Italy, Gaul, Iberia, and North Africa, together with Greece and Egypt. In Syria the population seems to have held even while in Gaul and Britain something like recovery must have occurred at the end of the period. Eastern Asia Minor and the Slavic area probably increased markedly. The German and Scandinavian spheres apparently held even in spite of emigration. The information about the central, eastern, and northern parts of Europe is so vague and uncertain that there may have been a considerable increase in population. The general rise in temperature should certainly have reduced the semiglacial conditions of the northern countries and made them attractive for grain-growing groups.

In the second and third centuries A.D., Rome suffered two devastating epidemics which have not been identified but their virulence suggests bubonic plague. According to Dr. Russell:

The period from A.D. 543 to 950 probably marks the lowest ebb of population in Europe since the early Roman Empire. It covers the first great attack of the plague, the worst epidemic to strike the area with which we are concerned. Following it came the Mohammedan invasions from the semi-nomadic areas of the lands surrounding the Mediterranean. From the east in the tenth century the Hungarians scourged most of Europe and what they missed was visited by the terrible raids of the Vikings from the north. Some measure of the weakness of the European population is indicated by the feeble defense put up against these invaders by the governments of Europe. . . .

Endemic diseases such as malaria and tuberculosis were prevalent, and the latter was particularly fatal among young people. In fact, the combination of both diseases occurred quite frequently and was highly fatal. Dr. Russell speculates that during the periods of population decline in early medieval Europe, much carefully tilled and drained acreage lapsed into breeding grounds for mosquitoes; and that a period of wet, warm weather about 800–900 A.D. greatly increased the incidence of malaria.

The span of life (extreme length of life) seems to have been around 100 years, as it is now. Those who could avoid infection were likely to

TABLE 1.—*Area and estimates of population of the Roman Empire, A.D. 14*

	Area (thousands of sq. mi.)	Population (thousands)	Persons per sq. mi.
Total empire.....	1, 289	54, 000	41
European part.....	861	23, 000	26
Asiatic part.....	257	19, 500	77
African part.....	171	11, 500	67

§ Source: Reference No. 14 at end of article.

live to considerable ages. According to John Durand, Assistant Director in Charge of Population, the United Nations Bureau of Social Affairs, the best basis for making mortality estimates of the Roman period is a study of tombstone inscriptions for males dying between the ages of 15 and 42. This method corrects the exaggeration of years that humans are apt to indulge in, even on tombstones, and allows for the under-representation of children's deaths. On this basis, Durand concludes that life expectancy at birth for the whole population of the Roman Empire was probably only about 25 or 30 years.

After the year 1000, it appears that population began to increase; and, between 1000 and 1348, that growth was phenomenal, particularly in northern Europe. The Empire of Charlemagne had already capitalized on the upward population movement, and stronger governments began to develop in Germany, Scandinavia, and even in Russia. The Crusades spread Christianity throughout the Middle East and brought contact between the Moslem and Christian worlds.

Then in 1348, the bubonic plague, which seems to have first appeared in the sixth century in Egypt, suddenly erupted in Europe in a more virulent form, taking a frightful toll of lives. Russell states that "the years 1348-1350 saw a very heavy loss of life, 20 to 25 percent in most European countries. The decline continued with later epidemics until the population of about 1400 was near 60 percent of the pre-plague figures. . . ."

Between 1500 and 1700, far-reaching social, economic, and intellectual revolutions began which formed the basis for the modern world. The era of medieval authority was first challenged in northern Italy, at the time of the Renaissance. This was followed by the age of discovery, with voyages around Africa and to the New World. At the same time, the Reformation set the stage for the revival of intellectual

TABLE 2.—*Approximate population of the world and its subdivisions, 1000-1600 (in millions)*

Year	World	Europe	Asiatic Russia	South-west Asia	India	China major *	Japan	South-east Asia, Oceania	Africa	The Americas
1000---	275	42	5	32	48	70	4	11	50	13
1100---	306	48	6	33	50	79	6	12	55	17
1200---	348	61	7	34	51	89	8	14	61	23
1300---	384	73	8	33	50	99	11	15	67	28
1400---	373	45	9	27	46	112	14	16	74	30
1500---	446	69	11	29	54	125	16	19	82	41
1600---	486	89	13	30	68	140	20	21	90	15

* China proper, plus Manchuria and Korea, Outer Mongolia, Sinkiang, and Formosa.

Source: Reference No. 1 at end of article.

development in northern Europe. For the first time since the Golden Age of Greece, the human intellect began to look at the world objectively. This led to the birth of the scientific method: new concepts of the nature of matter, energy, and, ultimately, of life began to capture the minds of men. Out of this intellectual revolution came powerful new insights which were eventually to change greatly man's pattern of living and dying.

In Europe about the middle of the 17th century—after the end of the Thirty Years' War and the period of peace and stability which followed—agricultural methods improved, slowly at first and then rapidly. New crops were introduced and crops were rotated; manure and fertilizers were used more generally; and the soil was cultivated more extensively. Even though these more advanced methods increased food production, the margin of plenty continued to be precarious, especially for those who lived in cities. A comparable agricultural expansion seems to have occurred in China at about the same time.

Unfortunately, little is known about population growth and decline during this period for the vast continent of Asia, particularly for India and China. M. K. Bennett, Director of the Food Research Institute, Stanford University, has recognized the need for a continent-by-continent or region-by-region survey. He estimates that world population in A.D. 1000 was somewhere around 275 million, or "probably less than half of the population of Europe in 1949; . . . that there has been one century, the fourteenth [the century of the Black Death in Europe] in which world population did not increase at all, but declined. . . ."

The earlier "hydraulic" civilizations became subject to disorders which checked and, in some cases, reversed their population growth.

The Americas had an estimated population of 16 million at the time of their discovery by Columbus. Julian Steward, Research Professor of Anthropology, University of Illinois, has estimated the population of the different regions of the American Hemisphere in 1492 as follows:

North America :	
North of Mexico.....	1,000,000
Mexico.....	4,500,000
West Indies.....	225,000
Central America.....	736,000
South America :	
Andean Area.....	6,131,000
Remainder.....	2,898,000
Total.....	15,490,000

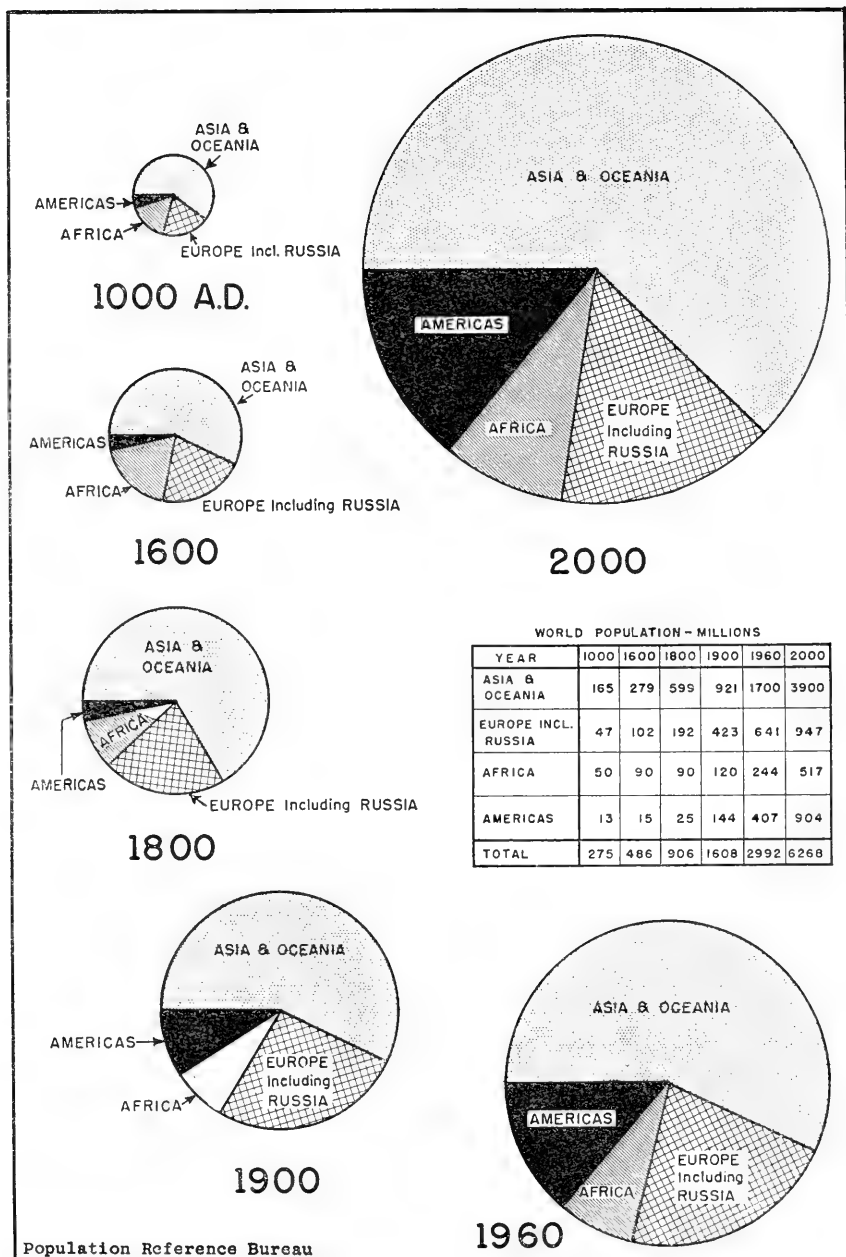

FIGURE 2.—A THOUSAND YEARS OF WORLD POPULATION GROWTH

In A.D. 1000, Asia accounted for 60 percent of the world's population, Europe, including Russia, for about 17 percent, Africa, 18 percent, and the Americas, 4 percent. By 1960, Asia's percentage had declined to somewhat under 60, that of Europe and the USSR had increased to 22 percent, and the Americas, to 14 percent. Africa's portion declined to 8 percent. By 2000, Asia may comprise about 65 percent of the total, Europe and the USSR, 15 percent, the Americas, 15 percent, and Africa, 8 percent. Russia includes Asiatic and European Russia.

PERIOD III—1650-1962 A.D.

If man's existence on earth is viewed as a day, this period is less than a minute. But a fourth or more of all human beings ever born have lived during this brief span.

The period brought a sixfold increase in human numbers: from an estimated half-billion in 1650 to over 3 billion in 1962. There were approximately 23 billion births during this period—over half as many as in the preceding 76 centuries!

World population doubled between 1650 and 1850, growing beyond the 1-billion mark. It doubled again, to reach 2 billion by 1930, in only 80 years. Since that time, the rate of growth has accelerated steadily. Now over 50 million more people are added each year. If the current rate remains unchanged, today's population will double again in less than 40 years.

A steadily falling death rate, especially during the last century, is mainly responsible for the very rapid acceleration in population growth. It is estimated that during 1650-1750 population was growing at about 0.3 percent a year; during 1750-1850, at about 0.5 percent; 1850-1950, at 0.8 percent. Currently, the rate is somewhere between 1.6 and 1.9 percent.

This period brings man through to the modern agricultural-industrial age with its tremendous scientific and technological discoveries which have greatly speeded up the rate of social change in the Western world and which have revolutionized agriculture, industry, communication, transportation, etc. These developments have made possible the support of the mammoth populations in numerous areas of the world. However, many of those technological advances are only beginning to touch the less developed areas where living levels for over half of the world's people are only a little, if any, above what they were during much of the earlier history of the race.

For the world as a whole, the mid-17th century is a bench mark in the pattern of population growth. Then, the upward surge in the numbers of people began. Just why the response to the early stirrings of the modern age was so rapid is not entirely clear, though many of the major factors which stimulated the increase in human numbers can be recognized. In Europe, the frightful famines and epidemics that marked the Dark Ages seem to have decreased, although hunger and disease were still endemic. The discovery of the New World opened the way for great transatlantic migrations to the rich, sparsely settled lands of the Americas. To some extent, this relieved the growing population pressure in Europe and provided a new source of food for the Old World. It also gave impetus to the tremendous growth of populations of European origin—at home and in European colonies—which amounted to a ninefold increase during the period.

TABLE 3.—*Estimates of world population by regions, 1650-1960*

Source of estimates and date	Estimated population in millions							
	World	Africa	Northern America ^a	Latin America ^b	Asia (excluding U.S.S.R.) ^c	Europe and Asiatic U.S.S.R. ^c	Oceania	Area of European settlement ^d
Willcox's estimates:								
1650-----	470	100	1	7	257	103	2	113
1750-----	694	100	1	10	437	144	2	157
1800-----	919	100	6	23	595	193	2	224
1850-----	1, 091	100	26	33	656	274	2	335
1900-----	1, 571	141	81	63	857	423	6	573
Carr-Saunders' estimates:								
1650-----	545	100	1	12	327	103	2	118
1750-----	728	95	1	11	475	144	2	158
1800-----	906	90	6	19	597	192	2	219
1850-----	1, 171	95	26	33	741	274	2	335
1900-----	1, 608	120	81	63	915	423	6	573
United Nations estimates:								
1920-----	1, 810	140	117	91	966	487	9	704
1930-----	2, 013	155	135	109	1, 072	532	10	786
1940-----	2, 246	172	146	131	1, 212	573	11	861
1950-----	2, 495	200	167	163	1, 376	576	13	919
1960-----	2, 972	244	200	207	1, 665	641	16	1, 064

^a United States, Canada, Alaska, St. Pierre, and Miquelon.

^b Central and South America and Caribbean Islands.

^c Estimates for Asia and Europe in Willcox's and Carr-Saunders' series have been adjusted so as to include the population of the Asiatic U.S.S.R. with that of Europe.

^d Includes northern America, Latin America, Europe, and the Asiatic U.S.S.R. and Oceania.

Source: Reference No. 14 at end of article.

The development of the scientific method and the application of this new knowledge to technology stimulated the Industrial and Vital Revolutions which so greatly changed man's way of life throughout the Western world. The Industrial Revolution brought the transition from agrarian to industrial societies—a transition which is beginning only now for large areas of Africa, Asia, and Latin America. The Vital Revolution brought the Western industrial nations through the demographic transition: from high birth and death rates to low birth and death rates.

More facts and learned estimates concerning world population are available for this period since census-taking began during the 17th century. The first censuses were conducted in 1655 by the French and British in their Canadian colonies. Iceland took a count in 1703,

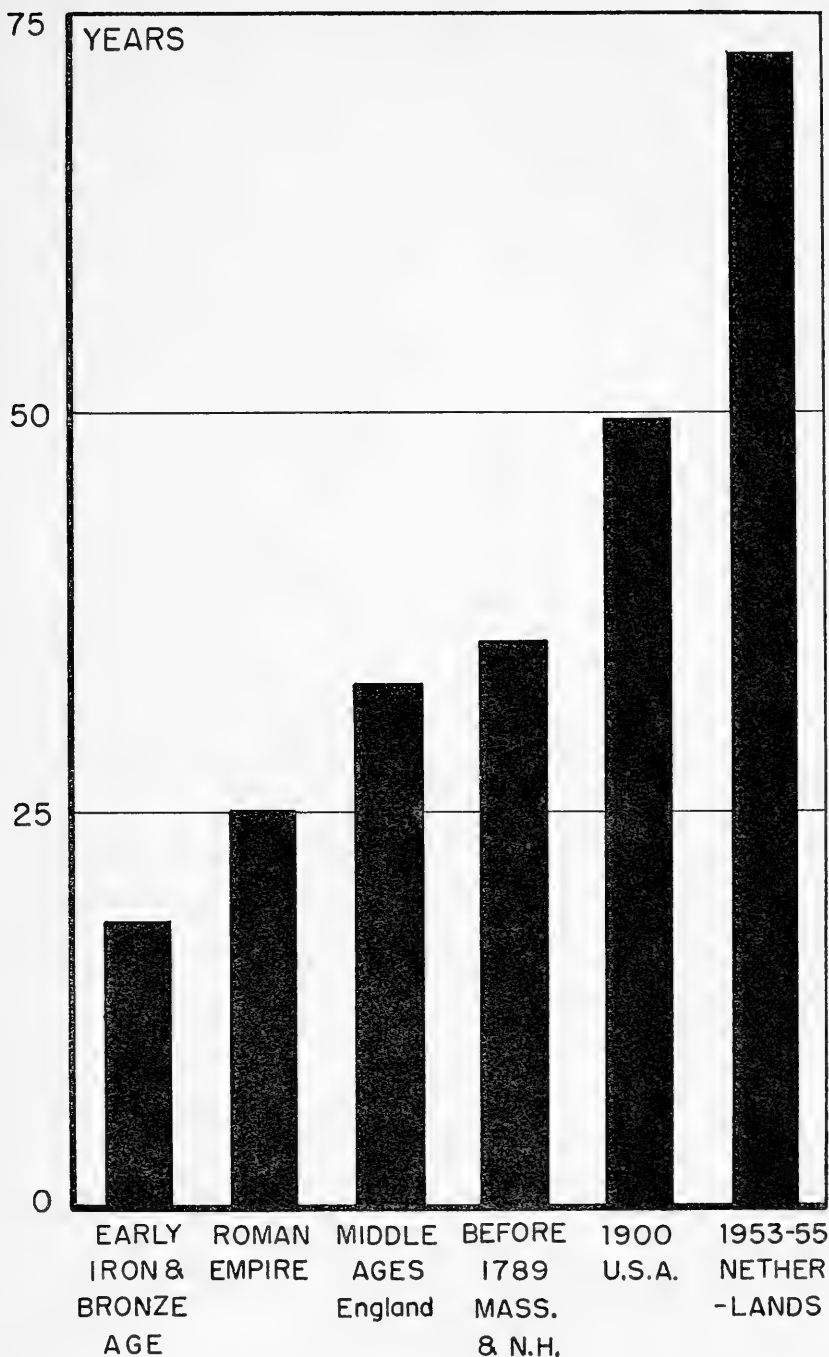

FIGURE 3.—LIFE EXPECTANCY OVER THE AGES

Life expectancy at birth is believed to have been about 18 years in prehistoric times. It has quadrupled today in some of the Western industrialized countries. (Source: *Length of Life: A Study of the Life Table*, by Louis I. Dublin, Alfred J. Lotka, and Mortimer Spiegelman and ref. 15 A.)

Sweden in 1748 and Denmark in 1769. The United States took its first national census in 1790. Great Britain took its first in 1801.

The first estimate of world population ever to be compiled was published in the 17th century by a Jesuit priest named Riccioli who estimated that 1 billion people then inhabited the earth: 100 million in Europe, 500 million in Asia, 100 million in Africa, 200 million in America, and 100 million in Oceania. It appears that Riccioli reported the conjectures of others rather than his own. Other contemporary estimates of the 17th century all range below Riccioli's—one as low as 320 million.

G. King, a 17th-century English scholar, estimating population densities for the various continents, allocated 17 acres per head for Europe, 20 for Asia, 64 for Africa, and 129 for America. This yielded a total of 700 million for the world, or 600 million, rejecting a hypothetical southern continent. If correct land areas as now known are substituted, the estimate would be 874 million. It should be noted that this estimate is two-thirds higher than the estimate of approximately 500 million accepted by modern scholars.

Even though Asia's population continued to increase during the period, its proportion of world population declined from about 58 percent in 1650 to 53 percent in 1920 (excluding the Asiatic part of the U.S.S.R.). Africa's proportion also declined, from 20 percent to 8 percent. But the proportion for Europe, including all of the U.S.S.R., rose from 20 percent to 27 percent. Since 1920, the proportion for Asia and Africa has again increased, while that for Europe has declined.

Today, the combined population of the Americas is about 400 million. Their proportion of world population increased from approximately 2 percent in 1650 to 14 percent at the present time. As previously mentioned, the indigenous American populations were heavily decimated by diseases brought in by Europeans and by wars with early colonizers. Much of the subsequent increase was due to immigration and to the proliferation of the immigrant groups. More recently, the descendants of the indigenous Americans have been increasing rapidly.

THE DEMOGRAPHIC TRANSITION OF PERIOD III

Application of the scientific method to medical technology brought man the ability to defer death. In the Western industrial countries, this has changed his pattern of survival far more rapidly than any other major social development throughout his long history. Similarly, in the Western world, knowledge about the control of fertility is widespread. As the traditional pattern of high birth and death rates changed to one of low birth and death rates, man's reproductive process has become much more efficient.

In the heavily populated, less developed countries of Africa, Asia, and Latin America, the application of scientific techniques to defer death is generally accepted and quite widely practiced; but the control of fertility has not begun to be practiced extensively enough to affect birth rates. As a result, rapidly falling death rates combined with traditionally high birth rates have touched off a surge in the rate of population growth.

Modern public health methods have cut death rates by one-third or more in a single year in some countries. With the drastic decline in infant and child mortality, the proportion of the population under 15 years of age tends to increase. It is now over 40 percent in many of these countries, as compared with about 20 percent in some countries of western and northern Europe.

It is expected that the growth rate will increase even further in many areas of Africa, Asia, and Latin America, as death rates continue to decline. This will surely happen unless effective measures can be devised which will speed up the demographic transition and the rate of social change. Simply stated, acceptable measures must be found to bring birth rates into balance with modern low death rates, thereby completing the demographic transition. Unless birth rates are reduced, population growth rates will continue upward until they are checked eventually by a rise in the death rate.

Although information about the number and distribution of the world's population and vital rates is far more extensive today than at any time in history, there are still large blank spaces in the world's demographic map. Only about half of the world's births and approximately two-thirds of the deaths are formally registered.

Discussing the present rapid rate of population growth, the latest United Nations Demographic Yearbook points out that approximately one-half of the world's population lives in only four countries—China (mainland), India, the U.S.S.R., and the U.S.A.—and that the reliability of world-population estimates depends largely on the accuracy of the information available about the population of these countries:

Similarly the 1950-59 average rate of increase, estimated in the range of 1.5 to 2.0 percent per annum for the four largest populations and 1.6 to 1.9 percent per annum for the remainder of the world, can be placed, in view of possibly compensating errors, between 1.6 and 1.9 percent per annum for the world as a whole. . . .

Actually in view of declining mortality, it is virtually certain that the rate of world population growth has now surpassed 1.5 percent per annum, and quite possible that it has attained 2.0 percent per annum. Because of this decline of mortality, world population certainly increased in the year 1959 by at least 45 million, and possibly by as much as 55 million. Again it is evident that much of the uncertainty is caused by the lack of precise knowledge regarding the population of China (mainland). Large margins of error must also be allowed for in the estimated annual increases in India, in other parts of Asia, and in Africa.

TABLE 4.—Estimated population and vital rates for the world by region, 1950-75

Continent and region (1)	Midyear population (millions) 1959 (2)	Annual rate of increase (percent) 1950-59 (3)	Vital rates 1955-59		Medium projection to 1975 (millions) (6)
			Birth rate (4)	Death rate (5)	
World total.....	2,907	1.7	36	19	3,830
Africa.....	237	1.9	46	27	303
Northern Africa.....	78	1.9	45	26	76
Tropical and Southern Africa.....	159	1.9	47	28	226
America.....	398	2.1	34	14	543
North America.....	196	1.8	25	9	240
Middle America.....	65	2.7	45	18	99
South America.....	137	2.3	42	19	204
Asia.....	1,622	1.8	42	23	2,210
Southwest Asia.....	74	2.5	46	21	116
South-central Asia.....	546	1.8	44	26	737
Southeast Asia.....	208	2.1	44	23	280
East Asia.....	794	1.8	39	21	1,075
Europe.....	423	0.8	19	10	476
Northern and Western Europe.....	141	0.7	18	11	154
Central Europe.....	137	0.8	19	10	156
Southern Europe.....	145	0.9	21	10	166
Oceania.....	16	2.4	25	9	21
Union of Soviet Socialist Republics..	211	1.7	25	8	275

Source: References 15 A and B at end of article.

The Chinese census of 1953 is very difficult to appraise and might introduce an error of as much as 90 million in the present world population!

WHAT IS PAST IS PROLOGUE

Since man first appeared on earth, human arithmetic has moved from a relatively simple exercise in addition to a complicated one of geometric progression. It took all of the vast reaches of time to build today's population of slightly over 3 billion. But it will take only 40 more years for population to reach 6 billion, if the present growth rates remain unchanged.

Life on this earth was a precarious gamble for *Homo sapiens* for hundreds of thousands of years. Driven by his natural reluctance to endure an early death, man ultimately discovered and then perfected the power to defer death. That he has succeeded is a notable tribute to his genius and to his humanitarian and philanthropic instincts.

It is noteworthy that the desire to control fertility has never had the emotional imperatives which brought the power over death. Only modest efforts have been made thus far to discover effective methods of fertility control which would be acceptable to the people of all cultures and religions. Less than modest efforts have been made

to disseminate what knowledge is now available to all the world's people who would benefit from that knowledge. Consequently, during the past decade of rapid death-rate decline in the less developed countries, there has been no measurable reduction in high birth rates; so population growth has increased.

Rapid population growth cannot be maintained indefinitely in any part of the world. If birth rates do not decline in overcrowded lands, death rates eventually will rise to check growth.

The gulf which exists today between the peoples of the world has widened: life is better than ever before for those who live in the Western industrial countries. But the majority of the world's people still live close to the subsistence level, in poverty and squalor reminiscent of the Middle Ages. If the demographic transition to a balance between low birth and death rates could be hastened in the less developed countries, this gulf might yet be bridged in time to avert a Malthusian disaster.

APPENDIX

The statistical and general demographic assumptions used to determine the number of people who have ever been born were provided the Population Reference Bureau by J. Fletcher Wellemeyer, an independent manpower consultant, Washington, D.C., in consultation with Frank Lorimer, American University, Washington, D.C.

The estimate was made on the basis of three time periods:

Period	Number of years in period	Number of births per year at beginning of period	Number of births per year at end of period	Number of births in period (billions)
I. 600,000-6000 B.C.-----	594, 000	"1"	250, 000	12
II. 6000 B.C.-1650 A.D.-----	7, 650	250, 000	25, 000, 000	42
III. 1650-1962 A.D.-----	312	25, 000, 000	110, 000, 000	23
Total-----	-----	-----	-----	77

To obtain the number of births at the beginning and end of these periods, certain assumptions were made regarding birth rates and the size of populations. It was assumed that at the beginning of the Neolithic era the population was 5 million and that the annual birth rate was 50 per thousand. The procedure assumes a smooth increase. The growth was undoubtedly irregular, but the estimates may fairly represent the net effect of the ups and downs.

By 1650 the annual number of births was estimated at 25 million, corresponding to a population of about 500 million. The 1962 world population of 3.05 billion, the number of births and birth rate of 36 per thousand are based on United Nations estimates.

The 600,000 years' duration of the Paleolithic era is based on the assumption that manlike types were then in existence but in very small numbers. Earlier dates have been given a few species by certain authorities, but some of these dates are questionable, and the earlier species may have been considerably less than manlike. The 600,000-year period seems a reasonable compromise between extreme possibilities.

Once the number of births at the dates indicated was determined, the total number of births for each period was calculated at a constant rate of increase for the period.

The estimated rates of increase differ sharply. For the long Paleolithic period, the average annual rate of increase was only 0.02 per thousand; during 6000 B.C. to A.D. 1650, it rose to 0.6; and during 1650-1962, it reached 4.35.

For the figures derived here, the following equation was used:

$$\Sigma B_t = \frac{B_0 e^{rt}}{r}$$

B_0 is the number of births per year at the beginning of the period; t is the number of years in the period; e is the base of natural logarithms; and r is the annual rate of increase during the period.

The value of r is obtained by solving for r the equation $\frac{B_t}{B_0} = e^{rt}$ where B_0 is the number of births the first year of the period, and B_t is the number of births the final year of the period.

SOURCES

In the preparation of this Bulletin, the following sources were consulted. The reader is referred to them for additional information.

1. BENNETT, M. K. The world's food. New York, Harper and Brothers, 1954.
2. BRAIDWOOD, ROBERT J. Near Eastern prehistory. *Science*, vol. 127, No. 3312, June 20, 1958.
3. BROWN, HARRISON. The challenge of man's future. New York, The Viking Press, 1954.
4. CARR-SAUNDERS, A. M. World population, past growth and present trends. Oxford, Clarendon Press, 1936.
5. COLLIER, JOHN. Indians of the Americas. New York, New American Library of World Literature, 1947.
6. COOK, ROBERT C. World population growth. *Law and Contemporary Problems* (a quarterly published by the Duke University School of Law), vol. 25, No. 3, summer 1960.
7. DURAND, JOHN. Mortality estimates from Roman tombstone inscriptions. *Amer. Journ. Sociol.*, vol. 45, No. 4, January 1960.
8. HUXLEY, JULIAN. New bottles for new wine. New York, Harper and Brothers, 1957.
9. KROEBER, A. L. Anthropology. New York, Harcourt, Brace and Company, 1948.
10. RUSSELL, J. C. Late ancient and medieval population. *Trans. Amer. Philos. Soc.*, n.s., vol. 48, pt. 3, June 1958.

11. Scientific American. Issue entitled The human species. Vol. 203, No. 3, September 1960.
12. STEWARD, JULIAN. The native population of South America. Bur. Amer. Ethnol. Bull. 143, vol. 5, pp. 655-668.
13. TURNER, RALPH. The great cultural traditions: Vol. I, The ancient cities New York, McGraw-Hill Book Company, 1941.
14. United Nations. Department of Social Affairs. Population Division.
 - A. The determinants and consequences of population trends. New York, 1953.
15. United Nations. Department of Economic and Social Affairs. Statistical Office.
 - A. Demographic yearbook, 1960. New York, 1960.
 - B. The future growth of world population. New York, 1953.
 - C. Population and vital statistics reports (Statistical Papers, Series A, vol. 13, No. 1). New York, 1961.
16. WILLCOX, WALTER F. (ed.). Population of the earth in international migrations, vol. 2, pt. 1. New York, National Bureau of Economic Research, Inc., 1931.

Bows and Arrows: A Chapter in the Evolution of Archery in America

By PAUL E. KLOPSTEG
Professor Emeritus, Northwestern University

[With 5 plates]

This article, as a first objective, is intended to acquaint the reader with the sports and other pastimes which have to do with the bow and arrow. Among the pastimes, perhaps surprisingly, are the serious theoretical and experimental studies of these ancient implements, which contributed in large measure to the unparalleled increase in their use in this country during the past 30 years. As a second objective, an account of the technological advance which resulted from the studies seems worth presenting, since the development is interesting in its own right and because it is probably unique in sports history.

The sports mentioned are comprised of a variety of ways of using the bow, all of which depend on skillful handling. Other diversions include the collecting of old books and prints, which not only give insight into the practice of archery centuries ago, but also reveal something of the customs of those times. Then, too, there is the collecting of bows, arrows, and associated gear from around the world, and of artifacts which were obviously or presumably related to archery. For a person of my interests, the most interesting diversion, which attracted others of like tastes, is the research and development aimed at understanding the mechanics of propulsion of the arrow and of its flight characteristics.

It is not intended here to review the history of archery, for to do so would go far beyond the scope of this article. For reasons already mentioned, the technical side of archery will be treated more fully than the others. It is the area to which my attention and interest were initially attracted, and the area in which the rapid evolution of archery in the United States took place.

My immersion in archery began in the late 1920's, when a dormant interest in the flight of a projectile was fanned to activity by my undertaking, one summer, to do target practice with arrows. During World War I my work had been largely in experimental ballistics. This may have stimulated a desire to know more about the manner of flight of the arrow, about the way in which energy is stored in the bow, and about the mechanism of transfer of the stored energy to the arrow—in short, about the physics of bows and arrows. One of the chief attractions of archery is the opportunity of applying the findings of science and engineering to the design and construction of bows and arrows.

Because of its venerable age and traditions, a voluminous literature has grown up in archery, especially in English. Less well known in English-speaking countries is the wealth of written records concerning archery in Arabic, Chinese, Persian, Turkish, and other oriental languages. By contrast, little of such writing has been produced in German or French. The collecting of old books and prints and more ephemeral items as well is a possibility not easily matched in any other sport. Its antiquity, its unique role in the history of nations, its science and technology, and its appeal to craftsmanship—the combination of all these is rarely found outside of archery.

Competent estimates indicate that 6 million or more persons in the United States are serious about some form of archery. To discover reasons for such wide appeal, observe that the bow is one of the first if not *the* first of propellant devices invented by man. To what epoch in prehistory its genesis may be assigned is not clearly established, but that game was hunted with the bow many millenniums ago is attested by the rock paintings in the Cueva de los Caballos in eastern Spain. Among prehistoric tribes the bow was the steadfast companion of the family provider, of the group defender, perhaps even of the tribal aggressor. Without doubt it was the principal implement used in the struggle for existence. To this day it plays the same indispensable role among primitive tribes of Africa and South America.

The bow is thus an authentic antique. Its antiquity, along with the fact that the modern bow and arrow are in principle unchanged from their prototypes, invests their use with fascination among sports which employ specialized instruments. Appreciation of this and other attractive attributes helps in part to explain its growth and present large number of followers. Archery has always been more a participant sport than a spectator's, which makes its phenomenal expansion all the more noteworthy. Its number of followers will always remain small in comparison with the crowds who are baseball and football enthusiasts.

Among the diversions which comprise the "world of sports" one comparison is the relative market for the implements used. By this test a participant sport ranks high, for nearly everyone interested in it is a potential buyer for its equipment. Archery, so measured, has arrived as a major sport. Its manufacturers and suppliers are found among the larger business enterprises. Manufacturers of firearms and fishing tackle have entered the primary market. One other indicator which confirms its rank is the rapid expansion of its specialized magazines, the number of recently published books, and the avid collection of old books and other material published in the field.



FIGURE 1.—An English longbow of the 1850's, unstrung. The upper limb, 34" long, is at the left, the lower limb, 34" long, at the right. To provide better grasp, the grip is enlarged by a shaped pad of cork glued to the back of the bow. The bow is made of two strips of wood glued together. The back is probably lancewood; the belly is a dark, hard wood, unidentified, but possibly degame, stained deep brown.

Today's number of archers contrasts sharply with that of only 30 years ago. During this period there has probably been a doubling of numbers every 5 years, which would make the ratio more than 60/1, which seems plausible. Prior to 1930, the number of archers in America was almost too small to be noticed. In the tables of data about outdoor sports, its category was "miscellaneous" or "other." Seldom did the public press carry news about it. Among the reasons for the prevailing popularity of the sport, a major one to be examined is the exceptional improvement of its implements. This new excellence was the first in centuries, the centuries during which makers of bows and arrows blindly and uncritically followed tradition.

Though unchanged in principle, the instruments of archery today differ profoundly in detail from their prehistoric and historic prototypes. They differ radically even from the more recent ones being used during the first few decades of this century. Changes in design, materials, and construction have contributed incomparably to precision in performance, hence to greater accuracy in the hands of the skillful user. Even the fantastic skill attributed to Robin Hood and his outlaws of Sherwood Forest does not surpass that of many of our present-day bowmen. The new designs have undoubtedly served as a potent catalyst both in stirring the latent interest of many potential archers, and in stimulating manufacture of the new bows which, unlike the old, lend themselves to systematic mass production.

Shooting an arrow at a mark such as the bullseye or "gold" of a standard target has much resemblance to measuring a physical constant with the purpose of determining its value to the utmost attainable accuracy. To increase the accuracy in such a measurement,

the first requisite is precision made possible by the use of instruments of greater sophistication. In shooting, these instruments are the bow and arrow which in their present design and construction are indeed sophisticated. To attain maximum precision with them requires:

1. Minimum differences, in successive shots, in the energy stored in the bow at equal lengths of draw.

2. Minimum effects of temperature and humidity on the materials of which the bow and the arrows are made.

3. Minimum differences in dimensions, materials, and shapes of the arrows comprising the set.

4. Arrows of proper spine in relation to the bow. (Spine is a characteristic of an arrow which depends on such factors as stiffness, resilience, mass, and distribution of mass along the shaft.)

5. Exact replication by the archer of all the sequences of action in the process of shooting, i.e., of drawing the bow and "loosing" the arrow.

Requirement 5, which calls for near perfection in the archer's coordination and in the execution of the difficult, interrelated steps in the shooting of an arrow, is to an extent dependent on the other specifications enumerated. His confidence in his ability to perform all the necessary actions properly is increased if he can be sure that these specifications are closely met.

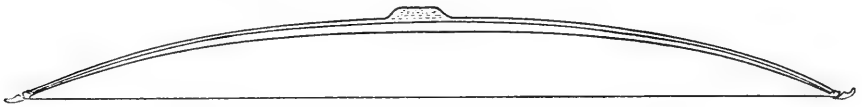

FIGURE 2.—The bow of Figure 1, strung ("braced") for shooting.

In the United States the bow and arrow are used in five main categories of the overall sport. The oldest form, widely practiced, derives from the kind of target shooting long practiced in England. It consists of competitive rounds, variously named, such as York, American, National. Each round consists of certain numbers of "ends" of six arrows each, at several known distances. The York Round, for example, calls for 12 ends at 100 yards, 8 at 80 yards, and 4 at 60 yards for a total of 144 shots. The standard target on a thick straw mat is 4 feet in diameter. Its gold bullseye is 0.8 foot in diameter. This is surrounded by four concentric rings each 0.4 foot in width, having colors red, blue, black, and white going outward from the gold. A hit in the gold counts 9; and the rings, going outward, have values of 7, 5, 3, and 1, respectively.

Clout and wand shooting are variations of the customary rounds. In the former, a target 12 times the diameter of the standard, namely, 48 feet, is laid out on the turf, with its center 180 yards from the shooting line. The arrows are loosed at a high initial angle and come

down steeply to stick in the sod on which the target is described. In wand shooting, a vertical lath 2 inches wide is set up at 100 yards, and hits are counted regardless of their elevation on the wand.

A second category called flight shooting puts a premium on skill in shooting for maximum distance. The bows and arrows are especially designed for the purpose. Another, field archery, requires a course of 14 targets, laid out where possible up hill and down dale, with distances only approximately known, and with targets roughly proportional in diameter to the distances from the shooting stands. Hilly woodland is preferred terrain, with natural hazards, or with artificial ones built in.

Still another bow-and-arrow sport is archery golf, played on a golf course. Bows and arrows are substituted for clubs and balls, and the cup is replaced by a circular disk of the same diameter as the cup, supported vertically. Some historians of sport surmise that the "antient and honourable game" of golf is descended from the old archery game of rovers. In this form of contest the participants, ambling about the countryside, selected a series of marks as they strolled, and scored the total number of shots to hit the marks, low score winning. Archery golf may, in fact, be "rovers reviv'd," in modified form.

The fifth major category, and the one growing most rapidly, is that of hunting wild game with bow and arrow. Most States have long open seasons limited to bow hunting, usually preceding the rifle hunting season for deer. Deer hunting is the most popular version. Hundreds of deer fall annually to the bow, but this is only a small fraction of those still being taken each year with rifles. The word "still" is used by design, because many of today's bow hunters are yesterday's riflemen. Other large game being hunted with the bow includes bobcats, mountain lions, javelina, elk, and moose in this country, as well as black and brown bears. Rabbits, squirrels, and upland birds are among the small game. Carp and gar fishing with the bow and special arrows is becoming increasingly popular.

The requirements for precision shooting where the object is to hit a mark have already been enumerated. These are closely approximated in most modern bows and arrows. Thus any appreciable scatter on a target of six matched arrows may be attributed to the archer's technique, to the variations in his performance in the different shots. Variable and gusty winds increase the scatter, whereas in a steady wind, the effect can be minimized by allowing for drift. With all these factors considered, it seems reasonable to use the comparison of scores of today's champion archers with the corresponding scores of 35 years ago as a measure of improvement in the equipment during the intervening period. Before the improved bows and arrows were

available, it was standard procedure for the archer who was striving for highest score to shoot his matched arrows repeatedly with a given bow, to determine their dispersion pattern, and to fix in his mind the deviation of each arrow, identified by number, from the intended point of impact at various target distances. He also needed to know the effects of temperature and humidity on the performance of his tackle, and make due allowances for them. With these precautions, experts could make fair scores.

The story of how bows and arrows became the objects of study by scientists and engineers, and how the transformation in design from the old to the new came about, begins in the 1920's.

Among those who became the pioneers in studies looking toward improvement, C. N. Hickman is one of the leaders. His training in physics to the doctorate was at Clark University, where he worked with Robert H. Goddard, known as the father of modern rocketry. Soon after the first World War, Hickman was employed at the National Bureau of Standards and soon thereafter transferred to the Washington Navy Yard as research engineer. He seems to have inherited his interest in archery. His grandfather learned it from the Indians, and his father was one of the relatively small number of archers in the United States during the last decade of the 19th and the early decades of the 20th centuries. Throughout his career Hickman has been a confirmed experimentalist in mechanics, with specific and practical objectives, and with exceptional ingenuity in devising and constructing apparatus and systems needed for specialized measurements and mechanical performance.

His exploration of the mechanics of the bow included the design and construction of a shooting machine with which hand shooting could be more closely simulated than in earlier machines of this kind. In it he employed a nonjarring pneumatic release, adapted from the pneumatic bellows used in a player piano. The device makes possible the reduction to minimum of the inevitable small variations in the process of shooting by hand. The machine and his modified form of the Aberdeen Chronograph, on the development of which I was engaged at Aberdeen Proving Ground and in Philadelphia during World War I, made it feasible to measure accurately the short time intervals involved in determining velocities and accelerations of arrows being discharged from bows. Data could thus be obtained for better understanding of the "interior ballistics" of the bow and arrow combination, and of the velocities and retardations involved in the "exterior ballistics" of the missile.

The beginning of my interest in these matters in the summer of 1929 came about through the fact that part of the family's vacation pastime was provided by a beginner's archery set and a homemade target.

First efforts sought to gain skill and improve scores. Practice was guided by an instruction sheet which came with the set. We started with complete ignorance of the techniques, so that improvement began from the zero level. In the course of my self-instruction in the art of "shooting in the bow" my familiarity with physics helped me to recognize the mechanical principles and problems involved in the propulsion of an arrow by means of a bow.

To increase the success of our efforts I bought and read what few up-to-date books on archery could be procured, and subscribed to the single archery magazine then being published, "yclept 'Ye Sylvan Archer'"—the title of which provided a flavor of romantic antiquity and old tradition for a struggling journal by and for amateurs.

The appearance of some of Hickman's articles in this magazine led to a renewal of our acquaintance. A lively correspondence about the physics and engineering aspects of archery developed. My Aberdeen Chronograph and shop equipment became the nucleus of an attic laboratory for which I built a shooting machine and other specialized apparatus. The latter included high-speed flash equipment for obtaining instantaneous photographs of an arrow being accelerated by the bow, and measurement of force-draw characteristics of a bow by photography. I was thus launched, not to say propelled, into experimental studies which were all the more welcome for the diversion they afforded from the serious economic problems following the great depression of 1929. In many respects, my equipment was similar to Hickman's, so that we could easily compare and check measurements and keep our efforts cooperative and complementary.

My publications reporting on these experiments began in 1931, first in "Ye Sylvan Archer," and later in a newly established journal of small circulation, the "Archery Review." Reference to the bibliography shows that several engineer-scientists other than Hickman and myself also published several papers, a few of which appeared in the Journal of the Franklin Institute. Among the authors were English, Higgins, Nagler, and Rheingans.

The topics listed below give a picture of some of the interesting problems with which the research and development efforts dealt; but many questions were only partially answered. There is still plenty of rewarding pastime left in them for anyone who feels inclined to apply his skill to their solution.

1. The effects of the shape, dimensions, relative settings, and angles of limbs on the static force-draw relation as the bow is drawn and the dynamic force-displacement relation as the arrow is accelerated.
2. The static energy-draw relation as the bow is drawn.
3. The velocity of departure of the arrow and its kinetic energy derived from the energy in the drawn bow.

4. The mass-velocity relationship and corresponding mass-energy relationship for arrows of different masses shot from the same bow.
5. Effect of the mass of the string on the initial velocity and energy of the arrow.
6. The efficiency of a bow-arrow combination, i.e., the fraction of the stored energy in the bow which appears as kinetic energy in the arrow.
7. The "virtual mass" of the bow.
8. Factors which affect performance of arrows: their effects on accuracy, and consistency and distance in flight.
9. The geometry and methods of aiming.
10. Psychological factors in shooting.

The list above is representative of some of the questions in the mind of the observant, analytically minded archer who has serious inclinations toward finding the answers. If he does, he has potential guides to improvement in performance of both the archer and his implements, and the search for the answers will have provided pleasant avocation for those who enjoy such pursuits. Our discussion of these matters will be illustrative rather than exhaustive.

Known kinds of bows are numerous. They may have long limbs or short limbs, equal or unequal in length. Cross-sectional shapes of the limbs are various. Materials may be wood, of a single kind, in "self" bows, or of different kinds, glued together in layers. There are "composite" bows, with layers of several kinds of organic materials, or, in modern form, of laminae of wood and synthetic plastics reinforced with fiberglass.

The two representative types of bow from which the kind now generally used has evolved are the longbow, with which are associated centuries of history and tradition, and the oriental, specifically the Turkish, composite bow. Prototypes of the latter are the bows used by the Saracens and by the conquering hordes of Genghis Khan. We have authentic information, dating back to the 15th century, about the Turkish bow. Through the following centuries its design apparently never changed. In the middle of the 19th century, interest in archery vanished with the end of the reign of Sultan Mahmud II, and few if any bows were made in Turkey thereafter.

The English longbow had straight limbs when relaxed, i.e., not strung, except as the limbs might have taken a set from having been repeatedly drawn. The limbs terminated in fitted tips of horn with grooves ("nocks") in which the loops of the string were seated. Limbs tapered in both width and thickness from grip to tip. At any cross section, the limb was rounded on the belly side, toward the string, and more or less flattened on the back, on the opposite side. In the drawn bow the belly is under compression, the back under ten-

sion. Several shapes of cross section are shown in figure 3. Such a limb is said to be stacked.

The grip occupied the region where the tapering limbs merged, and bending occurred throughout the length of the bow. For this and perhaps other reasons, an unpleasant recoil might be felt in the bow hand when the arrow was loosed. The stacked limb, characteristic of the longbow, was a violation of good mechanical principles and did not properly exploit the possibilities of the wood from which the bow was fashioned. On the contrary, it subjected the wood to needlessly high stresses. Indeed, such a bow had to be long to minimize stresses and prevent breakage; hence *longbow*. That the margin of safety in the longbow was recognized as precarious is implied in the saying that a bow fully drawn is nine-tenths broken. This is not true of the modern bow. Another feature of the longbow was that its lower limb was about 2 inches shorter, and stiffer, than the upper. This seems to have been a concession to the bowyer's desire to keep the overall length within tolerable limits and to have the arrow engage the string at the midpoint of the latter. Both desires were satisfied by moving the handgrip in the direction of the lower limb by a couple of inches.



FIGURE 3.—Typical shapes of cross sections of limbs of traditional longbows.

During the known history of the longbow up to the early 1930's the only change in design seems to have been one intended to reduce the aforementioned recoil in the bow hand. The change consisted of making the grip rigid and nonbending by leaving more wood in the handle portion. The limbs then, instead of merging within the grip, made juncture somewhat abruptly with the heavier midsection, where the latter was fashioned into dips which merged into the limbs. The limbs thus became more clearly defined in length. In other respects the design remained frozen.

The original motive for Hickman's work and mine was the conviction, bred by recognition of the theoretical shortcomings of the longbow and by the desire to improve its performance, that much better bows could be made. The improvements that resulted from the work demonstrate the effectiveness of using science and engineering principles as compared with the stagnation inevitable in adherence to tradition. In contrast with these improvements, brought about within a few years, is the frozen design to which bowyers in England and America adhered through the centuries, because they "knew" that it

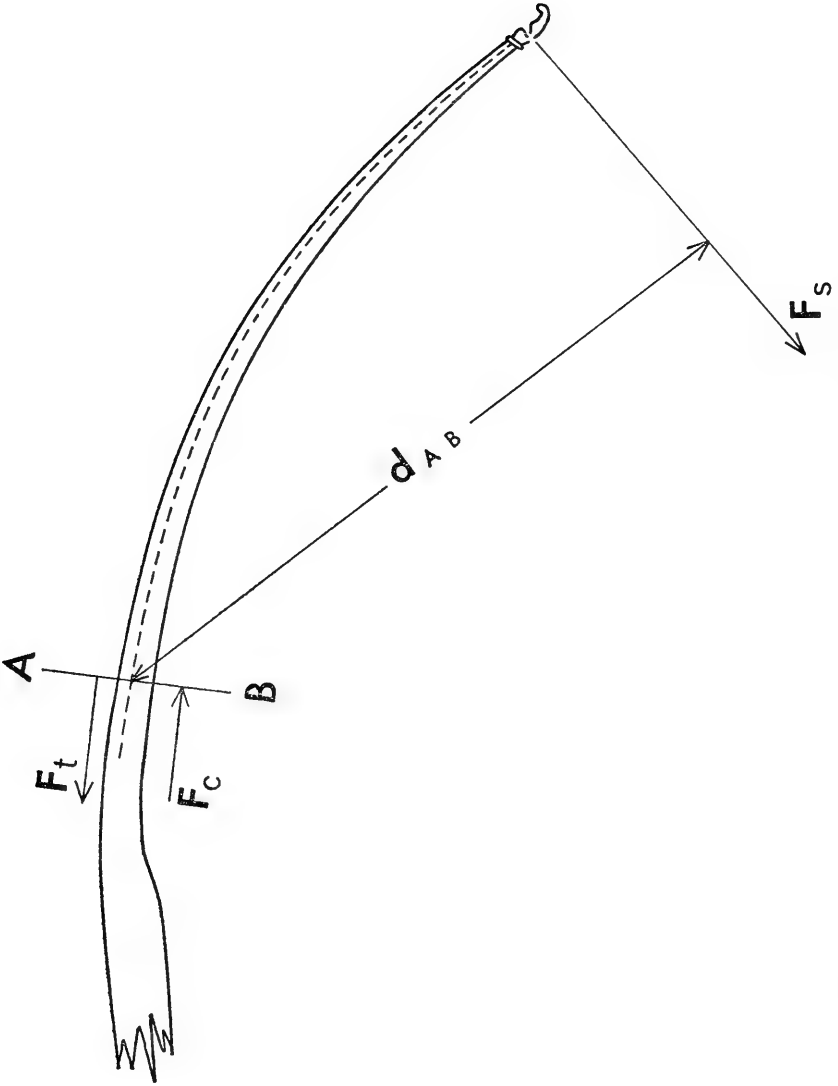

FIGURE 4.—Schematic side view of a bent limb. The dotted line indicates location of the neutral layer.

could not be improved. They must have felt certain that any attempts to improve their product were predestined to failure. I have recollections of pre-1930 bowyers speaking with pride, if not boastfully, of their ability in selecting yew wood for making bows par excellence. But no matter how singularly excellent the quality of the wood they selected, or how well it was seasoned, even the best of their bows required a high initial angle of trajectory for the arrow to hit the target at 100 yards. This did not contribute to high scores, notwithstanding their derogation of the higher velocity and flatter trajectory of the new bows, not attainable with theirs.

It may interest the reader to follow the major steps by which the improvements were achieved. Our point of departure was the longbow, as used in this country prior to the early 1930's which was the English pattern modified with the rigid grip.

Mechanics, that section of physics which deals with static and dynamic forces, with kinematics, and with the properties of materials subjected to stresses, shows that when an elastic beam is bent, it is under tension which causes stretching on the convex side and under compression, causing shortening on the concave side. Somewhere between there is a geometric "layer" of zero thickness which neither stretches nor shortens as the beam is bent. At this "neutral" layer the shearing force between the stretched and the compressed sections is a maximum, and this diminishes to zero as we move outward, at right angles, to the surfaces of the beam.

To illustrate this, consider the limb of a longbow (fig. 4). A force F_s applied to the tip through the string causes the limb to bend in a curve which depends on the force, and on the shape, dimensions, and elastic properties of the limb. At any section AB within some finite radius of curvature, the tensile force is F_t and the compressive force F_c . These forces increase from zero to maximum values as we go outward from the neutral layer. The bending moment at the section is the summation of the tensile and compressive forces over the elements of area on each side of the neutral layer, giving a resultant tensile and compressive force, respectively; the sum of each of these resultant forces, multiplied by the distance of its point of application from the neutral axis of the section, is the bending moment at the section. This is equal to the moment represented by the force along the string multiplied by the perpendicular distance of the section AB from the string: $F_s \times d_{AB}$.

Figure 5 represents a section AB of the limb in figure 4, of a typical longbow. Line CD through the center of mass of the section is the neutral axis. The neutral axes of all the sections define the neutral layer; conversely, the neutral layer contains all the neutral axes of all possible sections. In the section shown, the distance from the neutral axis to the outer surface of the back of the limb is less than the cor-

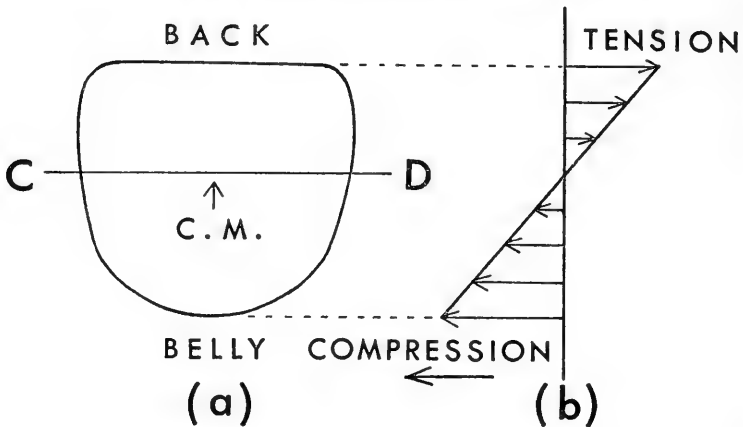

FIGURE 5.—(a) Section of a stacked limb. CD is the neutral axis, containing CM, the center of mass of the section. (b) Force diagram at this section of the stressed limb showing proportionality of fiber stress and distance from the neutral axis.

responding distance to the outer surface of the belly. Since the maximum tension and compression occur at the outer surfaces, the back is subject to lower maximum stress in tension than is the belly in compression. It is a general characteristic of wood, both from the standpoint of intrinsic strength and of imperfections, that it can withstand greater tension than compression without failure. Thus, in a stacked limb, forces to which the wood is subjected are not matched with the strength characteristics of the wood. This confirms the previous statement that in the longbow the qualities of the wood are not properly exploited. From mechanical considerations it would be better to reverse the shape of the limb, so as to make the stacked side the back and the flat side the belly. It is now evident why the longbow must be long to withstand the stresses to which it is subjected in use.

In a working bow, made of wood with suitable elastic properties, the energy in the bent limbs resides in the stresses set up in them as the bow is drawn. When the arrow is loosed, the wood tends to spring back toward its unstressed configuration. The best use of the wood or other resilient material is made when the maximum tensile and compressive forces are constant throughout the length of the limbs, with constant bending moment per unit area at any section. The condition can be approximated in a limb of uniform thickness, rectangular in section, bending in a circular arc. In handbooks of engineering one finds that a cantilever beam of uniform thickness, tapering from finite width at the point of support to zero width at its free end, with loading at the end, bends in a circular arc with light loading and small deflection. Hickman pointed out this simple fact and suggested that a bow with limbs rectangular in section, of uniform thickness and taper, would more effectively utilize the resilient qualities of the wood than does the longbow. Experiments carried on by Hick-

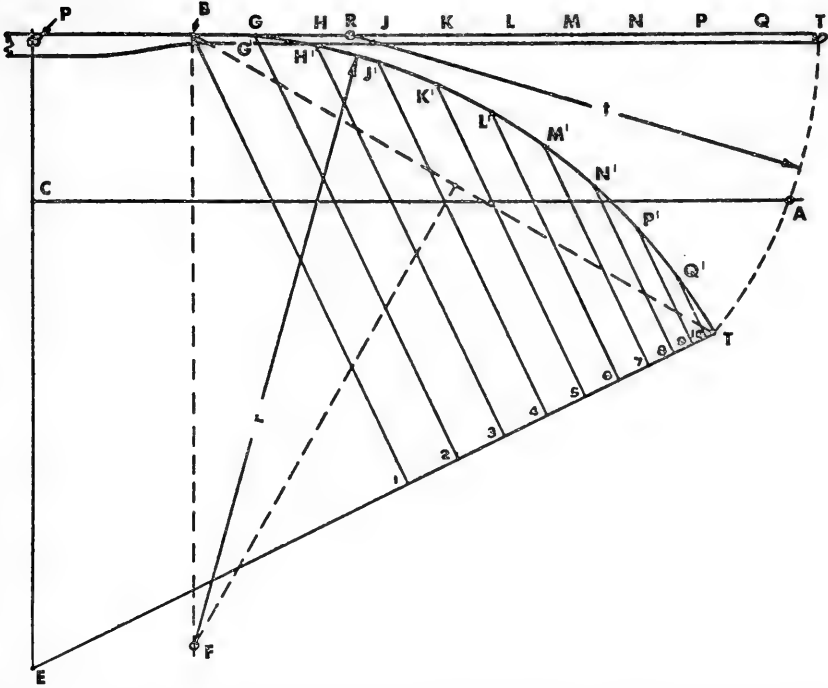

FIGURE 6.—Graphic method of designing a bow. BT , the limb, is divided into ten equal sections. Its tip, in bending, follows the path TT' , a circular arc with center at R and radius r , which is $3/4 BT$ in length. The length of the arrow is EP ; the line CA represents the string on the braced bow, with CP the "bracing height"; ET' represents the string at full draw. Arc BT' represents the bent limb, with radius r , the center of which is located by the intersection of the line BF which is perpendicular to BT , and the perpendicular bisector of chord BT' . Perpendiculars to ET' are dropped from each of the ten equally spaced points B, G', H', \dots, Q' , along the bent limb. The lengths of the perpendiculars are proportional to the respective widths of the limb at each of the ten locations.

man and myself some 30 years ago fully substantiated the point. When the deflection is large, as in a fully drawn bow, the bending moment per unit area is no longer uniform along the limbs. To restore uniformity, widths at different points along the limbs must be corrected so as to bring about the desired result of keeping the bending moment per unit area constant.

Figure 6 depicts a graphic method for determining the correct widths, along its length, for a limb of uniform thickness, to achieve the stated objective. Accordingly, it becomes the basis for the design of a bow with limbs rectangular in section, uniformly stressed.

Hickman showed that when a limb is bent in a circular arc, the path of its tip closely follows a circle having a radius three-fourths the length of the limb, its center being on the limb. This simple construction enables one to draw a circular arc representing the bent limb for any length of draw. The procedure for determining the

relative widths, in terms of the maximum width of the limb at its base, is described in the caption for figure 6.

It is of course impracticable to reduce the width of the limb to zero at the tip. This would have no place for seating ("nocking") the string, and because of the small width, the outermost several inches of the limb would be unstable and tend to twist. Accordingly, in constructing the limb, sufficient width is left in the outermost 3 or 4 inches to provide for a suitable nock and retain stability. To compensate for the extra stiffness due to the added width, the thickness of the end of the limb is reduced so as to approximate bending in this section on the same radius with the rest of the limb. The approximation cannot be close, because of the very small bending moment near the tip. The corners of the limb are chamfered to reduce concentration of stresses.

The new design, shown in plate 3, which in effect loads the limbs uniformly and thus makes optimum use of their elastic properties, made possible a reduction in their length by 10 to 15 percent, while reducing hazard of breakage. A dividend was the possibility of making the limbs of equal length, instead of keeping the lower limb 2 inches shorter than the upper, as in the longbow. This is accomplished by lengthening the rigid middle section sufficiently to provide the same length of rigid section above the arrow as there is in the handle section below the arrow, thereby keeping the bow symmetrical with respect to the axis of the arrow, with the arrow nocked at the midpoint of the string. Both limbs are now alike in dimensions and stiffness. Such a limb has a period of vibration much shorter than that of the equivalent limb of a longbow, the comparison between the two bows being based on their exerting the same static force on the arrow at full draw. The new limbs therefore spring back faster, impart higher velocity to a given arrow, and thus have greater efficiency in transferring their energy to the arrow.

Experiments with bows developed along these lines proved them to be far superior in efficiency to the longbow. Whereas the latter at best transferred 40 percent of its stored energy to the arrow, the new bows, according to measurement made both by Hickman and myself, had above 75 percent. With efficiency about double that of the longbow, it can impart an initial velocity to a given arrow about 40 percent higher than that produced by a longbow.

It seems appropriate at this point to quote from a letter which I received from a distinguished scientist and friend in Washington after I had sent him one of the new bows. He had been finding welcome relief from strenuous responsibilities in military research and development by practicing archery occasionally with the Potomac Archers, where he used a longbow. Upon receipt of the new bow, he tried it, then sent me the following comment:

That is the doggondest bow I ever saw—and apparently that the Potomac Archers ever saw. I took it down yesterday. The club was having an informal

shoot so I snuck off on the side, nocked an arrow, picked a point of aim somewhat nearer than with the older bow, and let er go. I haven't seen that arrow since. I just hope it didn't plug someone. . . . When the gang started shooting at 100 yards, Mr. ————— joined me and helped me try it out. . . . He was drawing only 26 inches, so was losing a lot. But his point of aim at 100 was somewhere about the 40 yard line. He shot a couple, and it pretty well broke up the shoot because the gang gathered around as soon as they saw the flat trajectory. . . .

Publication in the early 1930's of a series of articles on the design and performance of the new bow met with some skepticism by tradition-bound archers, but it also met with widely increasing acceptance. As more archers acquired bows of the new design they were able to verify the published statements about performance. It took only a relatively few years for the longbow virtually to disappear from tournament shooting lines.

In parallel with the acceptance of the bow of scientific design, another circumstance strongly influenced the continuing improvement of bows. In the early 1930's I had begun to make a collection of books on archery, most of which are of English origin, published from the 16th century onward. Among the items in the collection is a complete run of an annual review volume called "The Archer's Register," beginning in 1864 and continuing through 1915. Some of these contained seemingly authentic information as well as some conjecture about the practice of archery in Turkey in the 15th and later centuries. One assertion was the almost incredible one that the Turks had shot arrows a distance of a half mile—incredible, certainly, to those who knew only the limited range of the longbow. My technical interest stirred me to discover whether this might be true, and if so, how it had been accomplished.

In my exploration of Turkish archery, I was fortunate in being able to obtain a book by Mustafa Kani, printed in old Turkish with Arabic-Persian calligraphy, published in Constantinople in 1847, and bearing the title, "Excerpts from the Writings of the Archers." Among the things reported was the construction and methods of shooting the Turkish bow.

Because of my inability to read Turkish, it was fortunate that I later discovered two other publications concerning Turkish bows and arrows, both based almost wholly on the book by Kani. The first was a paper entitled "Concerning Bows and Arrows: Their Use and Construction by the Arabs and Turks," by Dr. Freiherr Hammar-Purgstall, presented before the Imperial Academy of Sciences of Austria-Hungary and published in the proceedings of the Academy. The second, "Bowery and Archery among the Osmanli Turks," by Joachim Hein, was published serially in three successive issues in 1921-22 of the German periodical "Der Islam." These two sources, both in German, which I read easily, were of substantial help in giving



FIGURE 7.—A Turkish archer, early 19th century, holding a composite bow at full draw, ready for loosing a flight arrow. Note that the arrow is drawn several inches within the bow, its tip resting in a guide (siper) strapped to the bow hand. (From "Turkish Archery and the Composite Bow".)

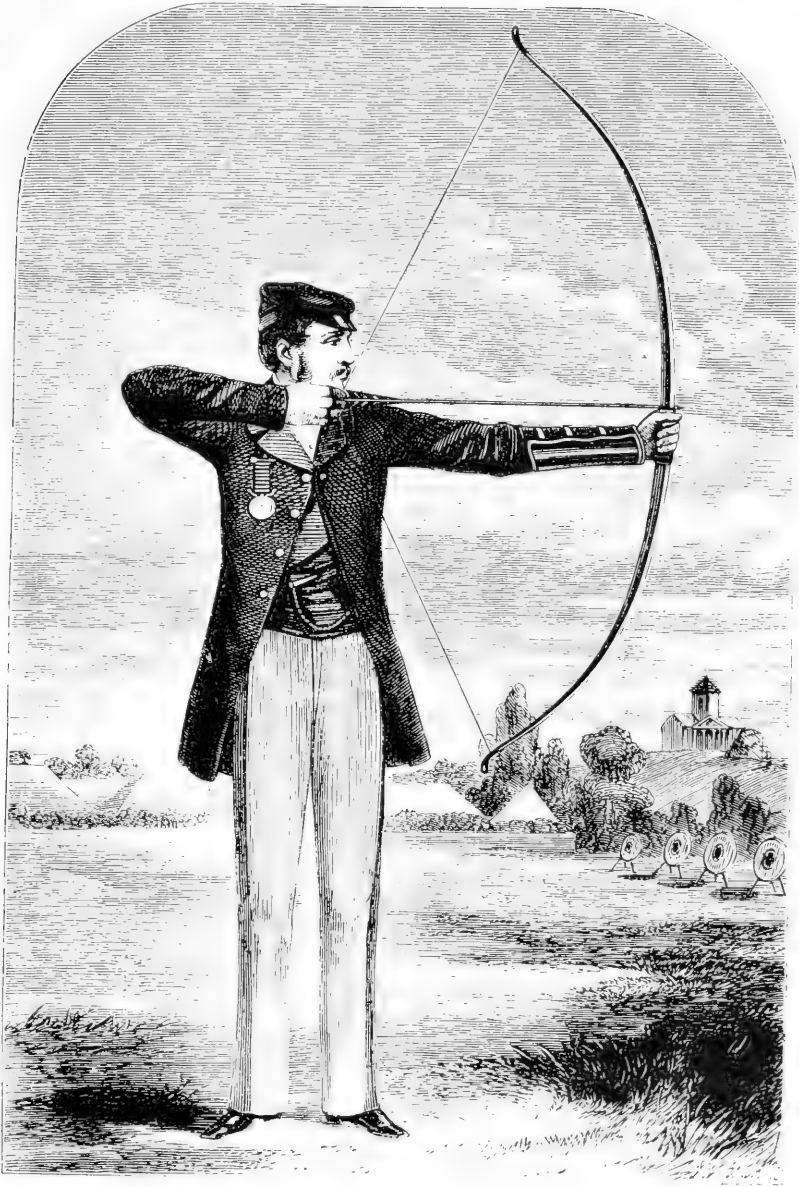

*Yours truly
Horace A. Ford*

An English longbow of the 1850's, like that of figures 1 and 2, at full draw. Reproduced from Horace A. Ford's "Archery in Theory and Practice," 1856. Ford was eleven times archery champion of England.



a



b



c

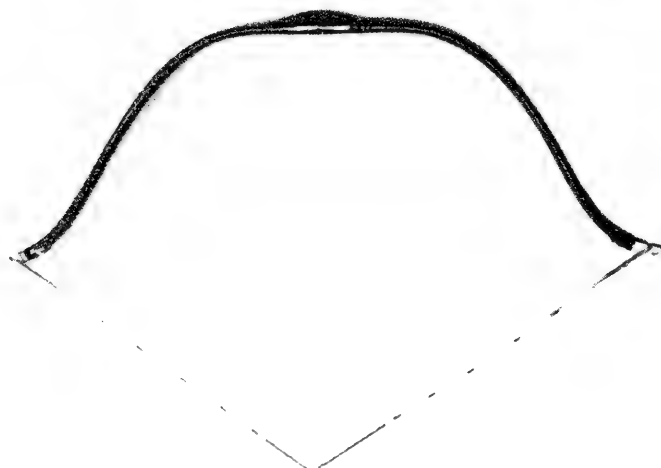

d

a, Modified grip of an American-made longbow to show the change in midsection from that of the English longbow. The midsection is made rigid, with "dips" where the limbs merge with the grip. b-d, A Turkish type composite bow (b) relaxed, (c) braced, and (d) at full draw. (From "Turkish Archery and the Composite Bow.")

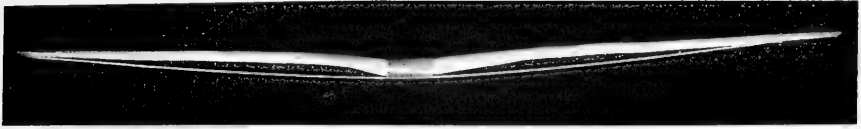

a



b

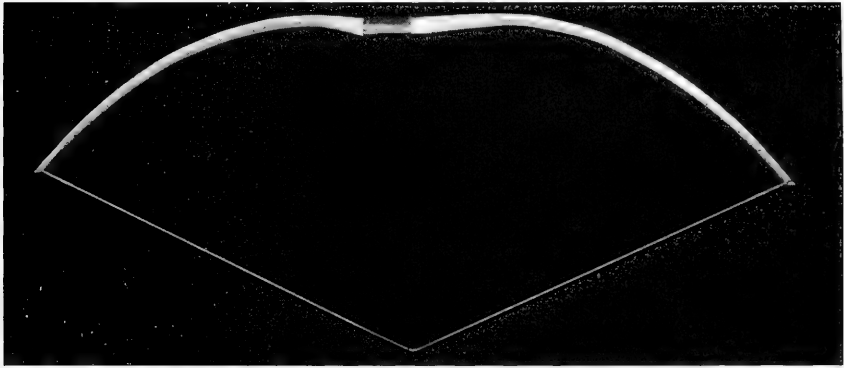

c

A wood bow, of yew, made according to the design of figure 6, shown (a) relaxed, (b) braced, and (c) at full draw. The limbs are straight, and, when drawn, bend in circular arcs. Note how the slightly wavy grain in the wood has been followed by the bowyer, to avoid cutting across the grain. Note also that the limbs are of equal length (28''); the long (15'') rigid midsection; and the symmetry of the bent limbs relative to the position of the arrow.



A modern composite bow (bow of the 1960's) (a) relaxed, (b) braced, and pl. 5, at full draw. Note the length (ca. 20") of the equal limbs, as compared with the 34" length of the upper and 32" lower limb of the English longbow of figure 1, and the rigid midsection, 27" long, which is completely absent in the English longbow. (Photos courtesy of Bear Archery Co.)



(See plate 4 for explanation.)

me insight into Kani's book, which otherwise would have remained obscure.

The result of the study of these two works led to my publishing a book in 1934, with the title "Turkish Archery and the Composite Bow." In it I reported what I had learned from the two German sources, along with comments and explanations deriving from both my practical experience in shooting, and from the research and development I had done. The book, published in a limited edition, proved to be in greater demand than had been anticipated, with the result that it became a collector's item on the day of its publication. A revised and enlarged edition was published in 1947, the centennial year of publication of the book by Mustafa Kani. The book deals exclusively with the Turkish bow, arrows, shooting accessories, methods of practice and of shooting, distance records and other related and pertinent information.

The Turkish composite bow differed profoundly from its English contemporary counterpart. Whereas the longbow was made exclusively of wood, the Turkish bow was "composite," with limbs constructed of materials in layers, so arranged that the compression, tension, and shear in the bent limbs occurred in those materials best adapted to withstand these respective forces. The precise form and construction of the composite bow must have evolved through experience in the use of the weapon, and from the trial-and-error method in construction employed by many successive generations of cooperating bowyers and archers.

The studies of Turkish bows and arrows, and their use in distance shooting, reported in the book on Turkish archery, left no doubt that their record distances were very much greater than any which had been achieved with the longbow. The principal reasons for the superiority were probably:

1. The greater energy storage per unit volume in the stressed limbs of the composite bow, made possible by the judicious use of suitable materials, and the geometry of the bow.
2. The design characteristics of the Turkish bow, such as shorter limbs, strongly reflexed when relaxed; and the setback, or "ears" at the ends of the limbs.
3. The design of the Turkish flight arrow, light yet strong and rigid to avoid buckling under high thrust; stabilizing vanes made as small as feasible, to minimize drag.
4. The use of a relatively short arrow, also designed to reduce drag, drawn several inches within the bow, made possible by the use of a special guiding device worn on the bow hand.
5. The thumb release, to minimize violent bending and deflection of the arrow during and immediately after release.

Many of the American archers interested in flight shooting who

had access to the book on Turkish archery realized the challenge which confronted them in the Turkish records, and proceeded to work at closing the wide gap between those records and the much shorter distances attainable with the longbow, or straight self bow of wood. Prior to publication of the book, some of them had already made changes in the longbow. They used limbs of rectangular section, shortened them to the limit of safety, and provided them with ears. This was the beginning of progress. The wood most frequently used in making flight bows was osage orange, a very strong, hard, resilient North American wood, named bois d'arc by the French explorers because they found it being used by many Indian tribes for bows. Seasoned osage orange wood of good quality has mechanical properties approximating those of horn, making the use of the latter as compression material unnecessary. Sinew fiber was, however, used for backing, to safeguard the limbs against breakage from possible flaws in the wood, and to withstand the high tensile stress which develops in a bend of short radius. They had learned from the book how the Turkish craftsman prepared the sinew and glue, and how he applied the sinew fiber, in a glue matrix, to the bow. With such transitional models of bows, flight distances increased through the 400's of yards into the low 500's.

Research and development during and since the war produced plastics with excellent characteristics for reliably storing and releasing energy through stress loading and unloading. Mass production at low cost of glass fibers was perfected, making long parallel fibers of glass readily available. Strong plastics with fiber glass reinforcement are now in regular if not exclusive use in the construction of bows of all kinds. Except in certain kinds of specialized, custom-built bows, sinew fiber, horn, and osage orange wood have been displaced by the new materials. The bow of the 1960's is composite in the Turkish tradition, though in modified pattern, influenced by the designs which developed from the research studies of the longbow.

Plates 4 and 5 represent one commercial form of modern bow, relaxed, braced, and at full draw. Although resemblance to the Turkish bow is manifest both in appearance and its composite structure, the straight-limbed bow of rectangular limb section had a strong influence upon its development also, as an intermediate phase after the longbow. The limbs are rectangular in section, with adequate width to insure stability against twisting as the bow is drawn. Moreover, the design is aimed at employing the whole limb, including the backwardly curved ends, for storing energy. The lesson learned from the bow with rectangular limb section, bending in circular arcs, is that each limb is "working" throughout, with approximately the same stored energy in each unit of volume of the stressed limb. In the Turkish bow only about one-half the length of each limb is under great stress when the bow is drawn. In the modern bow, which is

composite as is the Turkish, the tensile stress is taken by glass fibers in a matrix of strong plastic, and the compressive stresses by the plastic, perhaps aided by the glass fibers embedded in and bonded to it. The limb is built upon a thin strip of wood, usually hard maple, to both sides of which the plastic with embedded glass fibers is bonded. The limb of the Turkish composite bow was constructed similarly, but, it will be recalled, with horn to take the compression and sinew fibers to take the tension.

One of the outstanding gains of the new construction as compared with that of its precursor, the wood bow with rectangular-section limbs, is the relative immunity to normal temperature and humidity variations. Moreover, the modern composite has little or no tendency to follow the string, i.e., to take a permanent set from being braced and drawn. It may be left braced over long periods, and when relaxed, will resume its original form. A significant test of such a bow was to draw it full and let it snap 260,000 times. After this "abuse" the force at full draw was the same, within a few ounces, as it was when new.

The modern bow has the long rigid midsection which has been mentioned before. It permits using short limbs of equal length, and application of the drawing force to the bow along a line approximating the axis of the arrow as an axis of symmetry. A new feature is the sculptured grip, as seen in plates 4 and 5, shaped not only to fit the contours of the hand, but also to make certain that the force applied by the bow hand is always applied at the same location. An arrow rest, and a marked nocking point on the string insure the proper positioning of every arrow and replication in each shot of the impulse applied to the arrow. These features minimize variations which would introduce inaccuracies in hits. Another important characteristic which makes a similar contribution to accuracy is the absence of energy loss in the limbs from mechanical hysteresis, or internal friction in the materials of the limbs. This is present in most self bows of wood. It is related to permanent set in the limbs, which has been previously discussed.

The modern arrow also makes its contribution to accuracy. For the most part, precision arrows are now made of strong aluminum alloy tubing, precision drawn, with constant physical properties such as stiffness and mass per unit length for each diameter and wall thickness. The wood arrows, which have been largely superseded, suffered from the inevitable lack of homogeneity of wood. Notwithstanding close attention to manufacture, meticulous selection and seasoning of wood, and other handling intended to increase uniformity, complete identity of specifications for every arrow in a dozen could only be approximated. The final step in matching the arrows in a dozen

was that of selection, through measurements and tests, from a large number.

Another point of importance in accurate shooting at long distances, such as 100 yards in the York Round, is that the drag on the arrow must be alike for all. The principal cause of variation in drag has been in the vanes made of turkey feathers, which are easily disarranged or damaged by mechanical impact, and changed in texture and uniformity when wet. In the new designs, plastic vanes are used, with the result that greater uniformity is achieved with smaller effort. Some experimenters and manufacturers have used four or six vanes in place of the usual three. The only advantage is that for the same area of stabilizing surface, the larger number may be made somewhat narrower, and this may have value in preventing contact of the vanes with the bow when the arrow is loosed.

The drastic changes made in bows and arrows during the three decades past have produced emotional reactions among the older archers to whom the legend of Robin Hood was sacrosanct, and who were unable to tolerate innovation. They lived in the old English tradition with the longbow and the arrows made of "old deal." They ridiculed the research and development which pointed the way to better shooting and higher scores. Clearly they were entitled to hold affectionately to the Robin Hood image of archery. However, their predictions about the decline of archery, caused by the newfangled gear, failed of fulfillment. The number of archers has moved from the thousands into the millions. In large part this has come about by leaving tradition behind. The new bows and arrows have added immeasurably to the potential enjoyment of the sport.

A brief compilation of some of the technical considerations involved in the advancement of the art will, I hope, interest many readers, for it helps in following the rationale of the research and development which have been described.

The force-draw relation.—The most obvious characteristic of any bow is the relation between the force and the displacement of the nocking point of the arrow on the string. In graphic form, the relation is expressed as the force-draw curve. It shows the force exerted by the bow on the arrow at any point of the path in which it experiences acceleration.

In figure 8 are shown force-draw curves of bows of the several kinds which are under discussion in this report. These are adjusted to the same maximum force of draw at the same length of draw.

The significance of the force-draw curve in these studies is the fact that from it one obtains the energy in the drawn bow. The measure of the energy is the area enclosed by the graph, the X -axis at zero force and the ordinate at maximum force. The force-draw

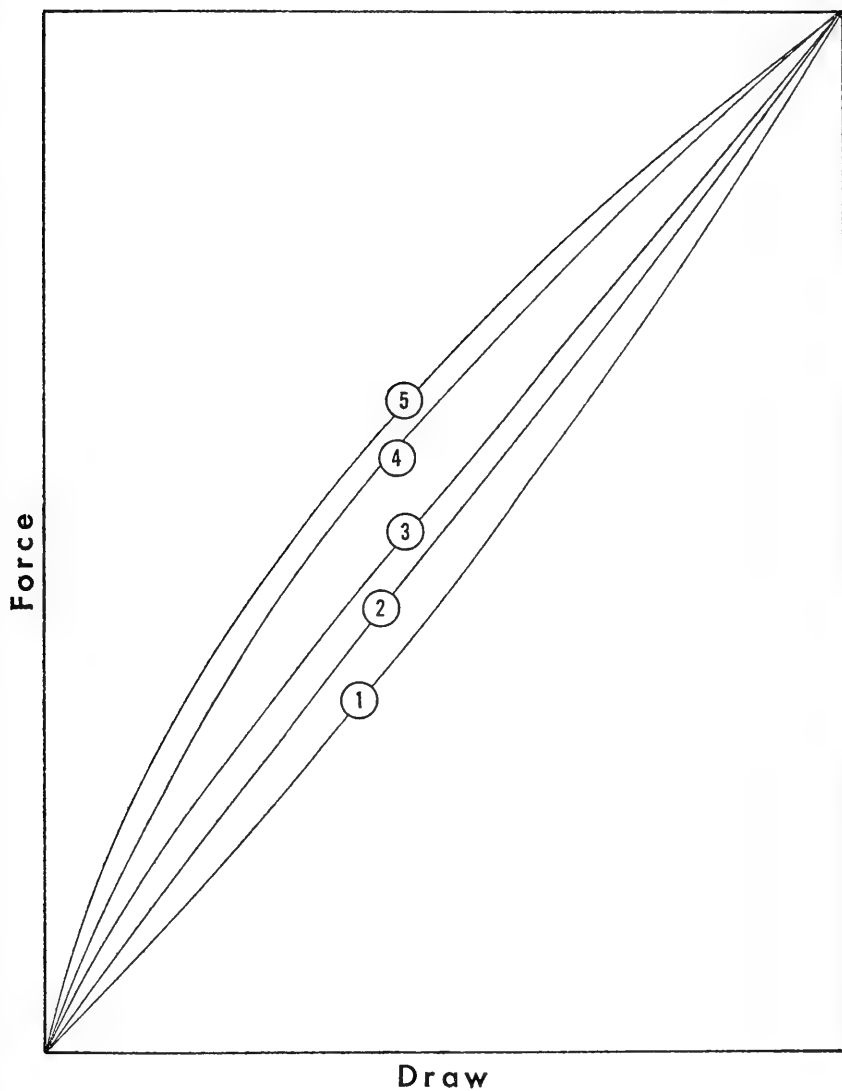

FIGURE 8.—A group of force-draw curves for bows of different types. (1) A short bow with straight limbs; (2) a longbow; (3) a straight-limbed short bow with backwardly curved tips (ears); (4) a modern composite bow, as shown in pl. 5; (5) a Turkish composite bow as shown in pl. 2, *d*.

curve for the longbow approximates a straight line. For a short, straight-limbed bow it curves slightly downward from that for the longbow. Backwardly curved tips produce convexity upward, as do strongly reflexed limbs of the kind employed in the Turkish bow, and some modern bows which employ modifications of such limbs. Hence the energy at full draw is relatively lower in bows with straight limbs than in reflexed bows, or bows with backwardly curving tips or ears. It would appear, therefore, that with substantially higher energy content for the same maximum force, the bows which follow a modified Turkish design, or use backwardly curving tips, are to be preferred to bows with straight limbs. This is indeed true if they are as effective in transferring energy to the arrow.

Velocity-mass relations in arrows shot from a given bow.—An archer, as he gains experience with his bow, will notice—provided he shoots arrows of different weights—that the light arrow takes off with higher velocity than the heavier. This raises questions. First, can one establish a systematic relation between the mass of an arrow and the velocity imparted to it by a given bow? Second, can one find a relation between the mass of an arrow and the energy which is transferred to it from the bow? These two questions, and the search for their answers, lead to some other considerations of interest.

Figure 9 reproduces a mass-velocity curve obtained by plotting measured velocities of arrows of different masses against the mass values, all shot from a bow with given energy at full draw. The solid line is plotted from computed values of v and m , using the relation

$$E = \frac{mv^2}{2} + \frac{Kv^2}{2},$$

simplified to $E = \frac{1}{2}(m + K)v^2$.

The equation says that the energy E in the drawn bow is accounted for by the kinetic energy in the arrow, $\frac{1}{2}mv^2$, and another energy term, $\frac{1}{2}Kv^2$, which represents the part of E which failed to be transferred from the bow to the arrow; it is that part of the energy which is left behind when the arrow leaves the string. This term employs the same velocity v as that of the arrow, and a quantity K which has the dimensions of mass. This I have called the *virtual mass* of the bow.

A physical picture of virtual mass may be drawn as follows. Imagine the bow and string to have no mass, and imagine a mass K to ride "piggyback" on the arrow until the instant the arrow leaves the string. The velocity v is that which corresponds to kinetic energy equal to the energy E , transferred to a mass of $m + K$. The energy carried off by the arrow is $\frac{1}{2}mv^2$, which means that the energy left behind is $\frac{1}{2}Kv^2$. The virtual mass K has been found by many experi-

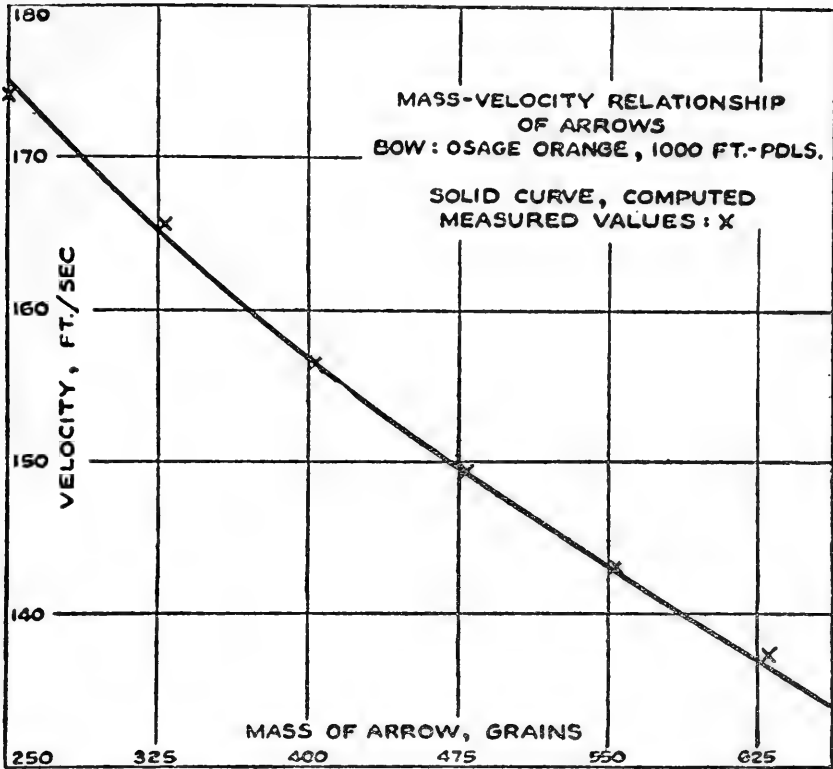

FIGURE 9.—Relation between mass of an arrow and its velocity when shot from a bow having 1,000 foot-pounds of available energy at full draw.

ments to be uniquely characteristic of the bow. In bows of high efficiency, i.e., of high energy transfer, K is small, and vice versa. The virtual mass of a longbow is large. It is much smaller in the "scientific" and the modern bows. This is the more readily understood when we consider that the limbs of a bow must themselves be accelerated by the stored energy in order to impart acceleration to the arrow. The long, heavy limbs of the longbow are sluggish as compared with the shorter and lighter limbs of its successors. Were it possible to transfer all the energy in the bow to the arrow, the virtual mass of the bow would be zero. Theoretically this might be achieved if a bow could be so designed that the limbs had zero velocity in the normal braced position at the instant of disengagement of the arrow. This is an unattainable ideal, but it has been approached to within 10 percent.

In closing this discussion, it is my hope that the purposes set forth at its beginning have been achieved. More detailed exposition of the many technical considerations involved in the design, construction

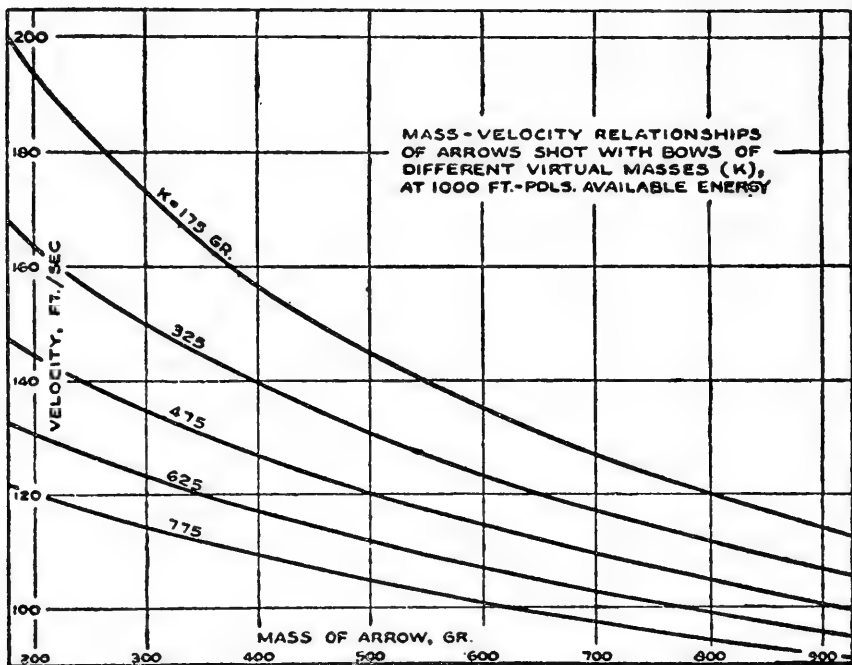

FIGURE 10.—A set of curves relating mass of an arrow to its velocity when shot from bows of different virtual mass but the same available energy.

and use of bows and arrows would far exceed its scope. The appended bibliography may serve as a guide for more thorough exploration of such technical matters as have been enumerated.

BIBLIOGRAPHY

(Abbreviations: S.A., *Ye Sylvan Archer*; A.R., *Archery Review*; A.B.R., *American Bowman-Review*)

CAVANAUGH, JAMES F.

1958. Standardization of procedures in bow testing. *Archery*, June.

ELMER, ROBERT P.

1933. *Archery* (rev. ed.), chap. 15.

1946. *Target archery*, pp. 184 et. seq.

ENGLISH, F. L.

1930. The exterior ballistics of the arrow. *Journ. Franklin Inst.*, vol. 210, p. 805.

HICKMAN, C. N.

1929. Velocity and acceleration of arrows. Weight and efficiency of bows as affected by backing of bow. *Journ. Franklin Inst.*, vol. 208, p. 521.

1930. Formulas for strains and stresses in a drawn bow. S.A., November.

1931a. A portable spark chronograph. *Journ. Franklin Inst.*, vol. 211, p. 59.

HICKMAN, C. E.—Continued

- 1931b. Effect of rigid middle section on static strains and stresses. S.A., February.
- 1931c. Effect of bracing eight on static strains and stresses. S.A., March.
- 1931d. Effect of string weight on arrow velocity and efficiency of bows. S.A., April.
- 1931e. Effect of permanent set and reflexing on static strains and stresses. S.A., May.
- 1931f. Effect of bow length on static strains and stresses. S.A., August.
- 1931g. Effect of weight and air resistance of bow tips on cast. S.A., September.
- 1932a. Effect of thickness and width of a bow on its form in bending. S.A., January.
- 1932b. The neutral plane of bending in a bow. S.A., February.
- 1932c. Fiber stresses in bows. S.A., March.
1937. The dynamics of a bow and arrow. *Journ. Appl. Phys.*, vol. 8, p. 404.

HICKMAN, C. N.; NAGLER, F.; and KLOPSTEG, P. E.

1947. Archery, the technical side (now out of print). *Nat. Field Archery Assoc.*

HIGGINS, GEORGE J.

1933. The aerodynamics of an arrow. *Journ. Franklin Inst.*, vol. 216, p. 91.

KLOPSTEG, PAUL E.

1931. What is the proper cross section for a bow? S.A., December.
- 1932a. Analyzing the bow sight. S.A., January.
- 1932b. Constructing the bow with rectangular limb section. S.A., May.
- 1932c. The effect on scores of errors in aiming and holding. S.A., also A.R., June.
- 1932d. What of the bow? A.R., October.
- 1932e. The flight of an arrow. A.R., November.
- 1932f. A comparison of the point of aim and sight. A.R., July.
- 1933a. A study of points of aim. A.R., January.
- 1933b. Elements of the prism sight. A.R., February.
- 1933c. Photographing the paradox. A.R., April.
- 1933d. Some new light on the paradox of archery. December (and January 1934).
1934. Turkish archery and the composite bow. (Rev. ed., 1947.) (Both editions out of print.)
- 1935a. Getting the most out of the bowstave. A.R., June.
- 1935b. Science looks at archery. A monograph.
- 1939a. A graphic method of designing a bow. S.A., June.
- 1939b. The penetration of arrows. A.B.R., July.
- 1943a. Physics of bows and arrows. *Amer. Journ. Phys.*, vol. 11, p. 175.
- 1943b. The whys and wherefores of cast. A.B.R., August.
1947. Archery. *Encyclopedia Britannica*, 14th ed. (1947 printing).

LOOMIS, A. L., and KLOPSTEG, PAUL E.

1920. The measurement of projectile velocity (Aberdeen Chronograph). *Journ. AIEE*, vol. 39, p. 98.

MCQUITTY, R. M.

1944. Aiming as affected by changes in velocity. A.B.R., June.

NAGLER, FORREST.

1933. Bow design. A.R., June and July.
1935. More about the elliptical bow. A.R., December (and January 1936).

NAGLER, F., and RHEINGANS, W. J.

1937. Spine and arrow design. A.B.R., June and July.

RHEINGANS, W. J.

1933. Debunking spine. A.R., May.

1934. Bow efficiency. A.R., February.

1936. Exterior and interior ballistics of bows and arrows. A.R., March and April.

RODGERS, W. L.

1935. The bow as a missile weapon. Army Ordnance, May-June.

SEAGRAVE, JOHN D.

1958. A survey of methods for measurement of arrow velocity. Archery, February.

Scientific Methods in the Examination and Conservation of Antiquities¹

By A. E. A. WERNER

Department of Research Laboratory, British Museum

[With 4 plates]

INTRODUCTION

It was at the beginning of the 19th century that scientists first began to show an interest in the composition of the metallic alloys used by the ancients. This early work has been reviewed in some detail by Earle Caley [1],² who gives credit to Gobel for recognizing brass as a Roman alloy, to Wocel for being the first to attempt a correlation between chemical composition and the date and place of origin of an object, and to Fellenberg for his series of papers on the composition of prehistoric central European bronzes. These early researches were undoubtedly of value to the archeologist, but they were of a rather spasmodic nature and devoted to specific topics. The intensive application of scientific methods in the field of archeology is of more recent origin; it may, in fact, be said to have begun with the pioneer work of Rathgen round about 1900 when the first laboratory devoted to museum problems was set up in Berlin. Since the First World War, this idea of museum laboratories has spread far and wide on an ever increasing scale. In these laboratories an unique opportunity has been afforded for the chemist or physicist to apply his specialized knowledge to studying the various problems that arise in the scientific examination and conservation of antiquities. This involves the development of a thoroughly scientific approach to conservation and the adoption of scientific techniques aimed at obtaining precise information about the methods and materials used by craftsmen in the past.

We will first consider the question of the conservation of antiquities as seen from the point of view of the scientist. Here there are two main aims: the first is concerned with the diagnosis of the factors

¹ Reprinted by permission from *Science Progress*, vol. 50, No. 200, October 1962. The illustrations (pls. 1-4) are copyrighted by the British Museum.

² Numbers in brackets indicate references at end of paper.

responsible for the deterioration which an object may suffer during its burial in the ground prior to excavation, or when it is exposed to adverse environmental conditions in a museum, and the second is to develop improved methods of conservation which will be based upon an appreciation of the above factors and the use of new synthetic materials.

CONTROL OF ENVIRONMENT

In the belief that prevention is better than cure, one of the first studies undertaken in museum laboratories was devoted to the behavior of archeological materials under different environmental conditions, so as to obtain a clear understanding of the factors likely to cause deterioration. This knowledge could then be used to establish methods of controlling the climate of a museum so that it would be best suited for the preservation of its contents. The chief problem arose in connection with museum objects of an organic nature, e.g., wood, textiles, ivory, etc. Such objects are susceptible to variation in atmospheric conditions, and the factor of paramount importance is control of the relative humidity of the museum atmosphere within prescribed limits. In general, this means that the relative humidity should lie in the range 50 to 65 percent, thus maintaining a reasonable thermodynamic equilibrium between the moisture content of the air and the moisture content of the organic material of which the object is composed. In this way it is possible to avoid excessive dryness which would lead to embrittlement by desiccation or excessive wetness which would lead to mold growth, weakening of moisture-sensitive adhesives such as glue, and, in the case of metallic objects, would encourage corrosion. Another vital point which was realized was the need to ensure adequate air circulation—particularly in storage rooms—so as to guard against the possible formation of air pockets where a high relative humidity beyond the safety limit of 65 percent might be developed [2]. An interesting example of the need to guard against this eventuality is shown in plate 1. A high relative humidity had developed in a basement room where books were stored on steel shelving, and resulted in mold growth becoming visible on the backs of the books. This condition was rectified by adopting methods whereby the ambient relative humidity was reduced to a desirable level, namely 50 percent. Later, when a book adjacent to a hollow steel shelf support was drawn out, it was found that mold was still active on the inside edge of the spine of the book and was growing in such a way as to reproduce the pattern of the holes in the hollow support. This was clearly due to the fact that a pocket of moist stagnant air had persisted inside the hollow support, because air circulation had not been maintained at a sufficiently high velocity; indeed, when the relative humidity of the air inside the support was measured, it was found to be no less than 83 percent. The various

aspects of this problem of museum climate and the methods available for the control of the ambient conditions in museums have been described in a recent number of the journal *Museum* [3].

Sometimes this question of the control of environment may arise in a particularly acute form. Such a case is the problem of "sweating" glass—a phenomenon which shows itself in the appearance of droplets of moisture on the surface of glass objects. These droplets were found by microanalysis to consist of a very dilute solution of sodium and potassium carbonates, produced by the leaching out of alkali ions by atmospheric moisture. The unsightly droplets can be removed by washing the surface of the glass, but the glass still remains potentially unstable and is liable to undergo further deterioration under normal museum conditions. It transpired, in fact, that the only practical method of conservation of such glass objects was to keep them in a dry environment; in practice this meant ensuring that the relative humidity did not exceed 42 percent. This control figure represented the proportion of moisture in the atmosphere when the hygroscopic potassium carbonate just begins to become moist, i.e., when the glass "sweats." The problem was, therefore, solved by constructing special show cases in which the relative humidity was maintained below the critical limit using silica gel as a desiccant [4]. This serves incidentally as a good example of how a scientific evaluation of the cause of deterioration is necessary before a rational method of conservation can be worked out.

NEW MATERIALS IN CONSERVATION

In the past the materials used in conservation were largely those of natural origin such as glues, beeswax, and natural resins. Consequently, many of the techniques evolved as the result of empirical experimentation by restorers were dictated primarily by the properties of whatever naturally occurring material seemed most suitable, and had perforce to be used. Progress was thus constrained within narrow limits. However, advances made in high-polymer chemistry during recent years have resulted in the production of a wide range of synthetic materials. Many of these new materials possess a combination of chemical and physical properties which are not to be found in materials of natural origin, and these can be employed in developing more reliable methods for the conservation of antiquities.

The best way to illustrate the manner in which modern materials can be used in conservation is to select specific examples for consideration. These will serve to show how the correct choice of a new synthetic material makes it possible to carry out conservation work which would have been very difficult, if not virtually impossible in the past, relying solely on materials of natural origin.

The first problem relates to the consolidation and repair of antiquities which are in a fragile state. In this field synthetic resins

are now being used on an extensive scale as adhesives and consolidants. The factor of paramount importance in the choice of a particular material is the amount of shrinkage which occurs when the resin sets. If the degree of shrinkage is excessive, considerable contractile forces may develop and there is a danger that serious distortion of a fragile object may occur. Tests have been carried out on many synthetic resins, and it has been found that the epoxy resins, which set by a condensation reaction that does not involve the loss of any volatile material, show a minimum contraction [5]. These materials are, therefore, particularly suitable in conservation, because they not only set without appreciable contraction, but they are also easy to use because certain of them set *in situ* from the liquid to the solid state at room temperature using a special hardener and catalyst. One example will suffice to show the great advantages of the epoxy resins in the consolidation of fragile objects. In 1958 a number of silver objects of early Christian origin were discovered on the site of the ninth-century church in St. Ninian's Island in the Shetlands. Among these there was a silver hanging bowl, which was of particular archeological significance because it is the only surviving example of a silver hanging bowl found in these islands. The bowl was covered with corrosion products formed by the mineralization of the copper present in the silver alloy, and when these had been removed, the silver which remained was egg-shell thin and brittle so that the object was extremely fragile. It was, therefore, necessary to devise some form of internal support to act as a permanent reinforcement using a material which must have the following properties: (1) it must be colorless and transparent, (2) it must be strong but not brittle, (3) it must adhere well to the silver, (4) it must set without appreciable shrinkage, and (5) it must be easy to apply without using too much heat. The only material which appeared to satisfy these criteria was a cold-setting epoxy resin, which could be brushed on the inside of the bowl as a viscous liquid and allowed to set as the bowl was slowly rotated on a turntable. It was by this means possible to build up a uniform thin layer of clear resin which gave sufficient mechanical strength to the bowl so that it could be handled with safety [6].

The only disadvantage of these epoxy resins from the conservation point of view is the fact that the hardeners used in the formulation of the cold-setting types are amines, and therefore not entirely suitable for the consolidation of bronze objects because of the risk that the hardeners may react with the bronze forming unsightly green or blue compounds. Hence, for the consolidation of bronze objects, it is necessary to employ a different type of synthetic resin. One of these is a special preparation of a polymethylmethacrylate resin manufactured in Germany under the trade name "Technovit."

When mixed with a hardener, this sets in about 10 minutes at room temperature to form a glass-clear solid that adheres well to bronze. The degree of shrinkage is also very slight so that this resin is an almost ideal material for the consolidation and repair of fragile bronzes. Both these techniques provide striking examples of the modern kind of conservation which would have been almost impossible to carry out using the old traditional materials.

One of the attractive features about the use of synthetic materials in the development of new methods of conservation is the fact that many possess an unusual combination of chemical and physical properties not met with in natural products. This obtains with many of the new synthetic waxlike materials, especially the polyethylene glycol waxes, which are produced by the polymerization of ethylene oxide. The members of the series are designated by numbers representing their average molecular weight, and range in consistency from soft materials like Vaseline to white solids like ordinary paraffin wax. Although they are like waxes in appearance, they have the interesting property of dissolving in water, and are, therefore, of interest in certain kinds of conservation work. One of the soft waxes—grade 1500, which is composed of equal parts of liquid grade 300 and a solid grade 1540—can be used to restore flexibility to leather objects that are found to be in a brittle state owing to desiccation [7]. The actual procedure is very simple, as it is merely necessary to immerse the object in the molten wax at a temperature of about 45° C. Another problem which has occupied the attention of chemists in museum laboratories for a long time has been the development of a reliable method for the treatment of wooden objects that are excavated from damp conditions in a so-called waterlogged condition. The actual physical state of such objects will be dependent upon the extent to which the cellulosic component of the wood has been degraded as the result of biochemical attack. If this is far advanced, the wood may be quite soft and will have very little mechanical strength. The treatment of waterlogged wood involves two factors, namely, first the removal of the large excess of water without causing the collapse of the weakened cell-walls, and consequent warping and shrinkage of the wood, and, secondly, some method for strengthening the wood so that the object can be handled with safety. Various attempts were made to solve this problem, but they were found to be either unreliable, limited in scope, or very slow and time-consuming. However, interesting techniques based on the use of synthetic materials have recently been evolved which show a great advance over previous methods. The first of these depends upon the use of the polyethylene glycol wax of grade 4000, employing a special procedure which was worked out in the British Museum Research Laboratory. Details will be found in a publication by Organ

[8] describing the successful treatment of soft, fragile waterlogged wooden artifacts from a site at the Kalambo Falls in Southern Rhodesia, which were of considerable interest because they were considered to be wooden tools of the Lower Paleolithic period and had been estimated by the radiocarbon dating method to be about 53,000 years old. The second method was developed at the Historisches Museum in Berne; in this the material used for consolidation is a special melamine-formaldehyde resin which is produced by Ciba Ltd. under the trade name Arigal C. Details of the actual process have been published by Müller-Beck and Haas [9].

Another new synthetic material, which has been adapted to solve particular problems in conservation, is N-hydroxy methyl nylon, which is formed by the action of formaldehyde on nylon and is produced by I.C.I. Ltd. under the trade name "Maranyl soluble nylon C 109/P" [10]. This dissolves in methyl or ethyl alcohol and the film which is formed upon evaporation of the solvent has certain properties which make it suitable for dealing with particular problems in the conservation of archeological materials. One such problem is the treatment of porous objects—for example, limestone carvings and earthenware tablets or potsherds called ostraka used in ancient Egypt for writing purposes—which have absorbed soluble salts whilst buried in salty ground. When such objects are exposed to fluctuating humidity conditions, as occurs in many museums, these salts are transported to the surface where they crystallize and weaken it so that decorative details of carving, or the writing, may flake off. Before these objects are washed in water to remove the soluble salts, it is essential that precautions be taken to consolidate the surface prior to washing. Since the film of soluble nylon is, first, permeable to water, thus allowing elution of the soluble salts during washing, and, second, is markedly flexible so that it does not exert undue contraction on the frail surface layers, it is ideally suitable for this purpose. This material has already been successfully used in the washing of many hundreds of ostraka. It was also found, incidentally, that this soluble nylon can act as an adhesive when it is necessary to employ a mobile nonaqueous adhesive. Such a case arose in connection with a fragment of a tempera wall-painting from a tomb at Thebes in which the paint was flaking away from the ground layer. Owing to the possible risk of softening the ground layer or activating soluble salts in the plaster support, it was considered inadvisable to use a normal aqueous adhesive such as glue. Instead, a warm 5 percent alcoholic solution of soluble nylon was used; this proved most suitable because it has a relatively low surface tension and readily flows under the detached flakes of paint. Furthermore, the soluble nylon film has a distinctly matt appearance, so that there is no esthetically unattractive sheen on the treated areas. Other uses which have been found for this interest-



Mold growth patterns in books.



The "Mars Sword" X-rayed.

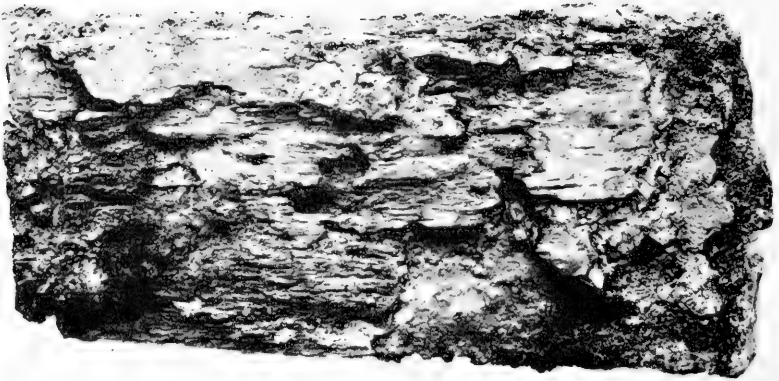

"Mars Sword" as found.



The "Mars Sword." The figure of Mars.



The "Mars Sword." Military standards.



The Enkomi cup as excavated.



The Enkomi cup after cleaning in the British Museum Research Laboratory.

ing new material include the consolidation of friable paint in illuminated manuscripts and powdery patina on bronzes. These examples will suffice to show that the scientific evaluation of synthetic materials of potential value in conservation has led to considerable advances in this field.

SCIENTIFIC AIDS IN CONSERVATION

Another direction in which scientific methods are utilized in conservation is in the use of scientific aids such as metallographic and microchemical analysis and radiography to provide information necessary for the correct assessment of the factors involved in the conservation. Radiography is, for example, frequently used in order to find out if there is any decorative inlay lying hidden under layers of corrosion products. Thus, when a fragment of an iron sword was X-rayed (pl. 2, figs. 1 and 2), it was possible to obtain evidence of an inlay which was present on both sides of the sword. By careful removal of the overlaying layers of rust, it was subsequently possible to reveal the inlay which had been carried out in a material similar to brass, known as orichalcum (pl. 3). Another example which strikingly illustrates the value of radiography in the examination of antiquities was a silver cup which was excavated at Enkomi in Cyprus in the condition shown in plate 4, figure 1, covered with green corrosion products derived from the copper which had been leached out from the alloy. Preliminary examination showed that thin fragments of gold, and also a black powdery material lay embedded in the corrosion layers. Spectrographic analysis of the black material showed the major constituents to be silver and copper, thus indicating a material similar to niello [11]. These findings indicated the probable presence of a decorative inlay, and this was confirmed by X-ray. This was important because it meant that special precautions had to be taken in the choice of chemical reagent for removing the unsightly incrustation without damaging the materials of the inlay. This was achieved using hot formic acid to dissolve the copper corrosion products, when the original decoration round the cup was revealed in surprising freshness (pl. 4, fig. 2).

Another example which illustrates the need for scientific tests before commencing conservation of an antiquity was provided by a silver libation vessel which was excavated at Nuri in the Sudan in a fragmentary condition. Ancient silver is always very brittle, and annealing of the silver to make it ductile is always the first stage in the restoration of ancient silver objects. Normally, this does not present any difficulties, but when tests were carried out on fragments from this Nuri vessel it was found that for this case a special procedure would be necessary. In fact, metallographic examination of a fragment as it was subjected to successively higher temperatures

showed that the alteration characteristic of annealing did not occur until the silver was heated to 900° C., i.e., only 50 degrees below the melting point of silver. However, by carrying out the annealing under strictly controlled conditions in an inert atmosphere, it was possible to restore ductibility to the silver, so that the reshaping and restoration of the vessel could be successfully carried out.

PHYSICAL TECHNIQUES OF ANALYSIS

The analysis of antiquities undertaken in order to provide the archeologist with a knowledge of their composition (which can be used to deduce information about techniques, date of production, and provenance) is a major activity in museum laboratories.

If a sufficiently large sample can be taken, the ordinary methods of chemical—or, more often, microchemical—analysis can be used. However, very often the objects are so precious that the permissible sample may be of the order of only a few milligrams, or, indeed, it may not be possible to take any sample at all. For this reason, physical techniques of analysis of increasing refinement are now being extensively employed. Whenever a small sample can be taken, the well-known techniques of spectrochemical analysis and X-ray diffraction analysis can be used. By these means, results have been obtained which are of considerable value to the archeologist. Thus, for example, in a recent study of Romano-British and Mycenaean pottery, Richards and Hartley [12] used spectrochemical analysis to demonstrate a link between a given pattern of minor impurities and a particular geographical origin. Also, the same technique is being extensively used to determine the composition of ancient bronzes in an attempt to indicate the sources and trade-routes of the contemporary supply of metal. Recently a series of no less than 438 analyses was carried out by Brown and Blin-Stoyle [13] on British middle and late Bronze Age material in order to provide results available for statistical examination.

The technique of X-ray diffraction analysis is used to obtain information about the chemical composition of antiquities and the nature of corrosion products. One example, which clearly shows the value of this technique, is the interesting study which has been recently carried out by Turner and Rooksby [14] in order to determine the chemical nature of materials used as opacifiers in ancient opal glass made over a period of 3,400 years. The evidence thus obtained indicated the different techniques of manufacture used at various periods.

With more precious objects such as Chinese porcelain or valuable coins, it is usually not possible to take a sample for analysis, and it is, therefore, necessary to use methods of analysis which are completely

nondestructive. In this field the work being done by Hall and his coworkers of the Oxford Archaeological Research Laboratory is of outstanding importance. They have succeeded in adapting techniques of X-ray fluorescent analysis and neutron activation analysis to the examination of antiquities. The former technique is admirable for the analysis of the surface of an object; it is rapidly carried out so that a large number of samples can be analyzed in a short time and it is entirely nondestructive. A striking example of the manner in which this technique can be used to reveal important information has recently been published by Young [15]. The problem was to find a means of distinguishing between imported cobalt and native cobalt ores used in making the blue pigment on "blue and white" Chinese porcelain. The imported cobalt ore from Persia was known to be free from manganese, whereas the cobalt ores occurring in China contained a high proportion of manganese. By measuring in less than 20 hours the ratio of manganese to cobalt in the blue pigment on some 80 pieces of porcelain, he obtained results which told a significant story, namely, that imported ores were used from the 14th century until the end of the 16th century, and that native ore did not start to be used until the beginning of the 15th century.

The technique of X-ray fluorescence analysis is confined to the examination of the actual surface layers, and, therefore, with respect to metal antiquities, the results may be misleading because of surface enrichment or the presence of corrosion products. With such, the technique of neutron activation followed by gamma-ray spectrometry has to be employed. This method has, for example, shown its value in the analysis of trace elements in Greek silver coins [16] and in ancient ceramic objects [17] with a view to obtaining analytical information which could be used to establish a link between a given pattern of impurities and a particular location for the manufacture of the objects.

Finally, mention must be made of the latest addition to the armament of physical techniques of analysis which have very recently been applied to the study of antiquities. This is the electron beam microprobe analyzer. The unique feature of this instrument is the fact that the electron beam can be focused very sharply on an area as small as two microns in diameter. This means that it is possible to perform a chemical analysis of objects too small to be clearly seen by the unaided eye. For this reason, Brill and Moll [18] used this technique in their recent study of ancient glass whereby it was possible to carry out a quantitative analysis of the individual layers in Roman millefiori glass, to determine the chemical nature of occlusions in glass, and to examine the products formed as a weathering crust on ancient glass. Such refined analysis was only possible by this technique.

The potentialities of these various refined methods of physical analysis in the examination of antiquities are very great and they are capable of yielding information of great interest to archeologists. There is little doubt that they will in the future be used on an increasing scale. The only drawback to their extended use is the high cost of the necessary equipment.

ARCHEOLOGICAL DATING

As a final illustration of the versatile role played by chemistry and physics in the service of archeology, there can surely be no better example than that of the modern methods which have been developed for the dating of certain classes of antiquities. The first of these is the radiocarbon method due to the pioneer work of Libby, which began in 1946. The principle of this method depends upon the fact that the carbon in all living organisms contains a constant proportion of the radioactive isotope (carbon-14) derived from the atmosphere, and such organisms are thus slightly radioactive. When the organism dies, replenishment of the radioactive isotope by the uptake of atmospheric carbon dioxide ceases, and the existing radioactivity decays at a known rate, determined by the "half-life" of carbon-14 which has been estimated at about 5,700 years. This means that the radioactivity of the sample dwindles to half its value in 5,700 years to a quarter in 11,400 years, and so on. Thus, by measuring the actual radioactivity of an object containing carbon—such as wood, charcoal, bone—it is possible to estimate the time that has elapsed since the death of the organism. Although the amount of radioactivity that has to be measured is extremely small—"modern" carbon having a specific activity of only about 14 disintegrations per minute per gram—it is possible to obtain reasonably accurate measurements by the use of refined techniques. The reliability of the method has been established by applying the method to samples of known age, and finding that the results agree. This method of dating is of paramount importance to the archeologist, who is concerned with the chronology of the prehistoric past, because he now has for the first time reliable absolute dates upon which he can base his system of chronology. There are now many radiocarbon laboratories all over the world, including three in Great Britain, and their lists of dates are published annually in a special Radiocarbon Supplement of the *American Journal of Science*.

The radiocarbon method of dating is, of course, limited to material which contains carbon, and therefore it is of interest that two other methods of dating have recently been suggested, which can be applied to a different class of archeological material. The first of these is known as magnetic dating, and can be applied to baked clay of archeological origin (e.g., the walls of a pottery kiln, or bricks or associated

pottery that has remained in situ). This method depends upon two essential facts. The first is that the secular variations in the direction of the earth's magnetic field—as defined by the magnetic declination and the angle of dip—have been recorded in different centers over the past 400 years, and the second is that this information has also been preserved in baked clay by the phenomenon of thermo-remanent magnetism. Hence, by measuring the magnetic direction in clay that can be presumed to have remained in situ since it was baked (as would be the case with a pottery kiln) and comparing the measurements with the known secular variations, an estimate of the date of baking can be obtained. Details of the method and its archeological applications are given in a recent book by Aitken [19].

The other possible method of dating, which is known as thermoluminescent dating, has been suggested by Professor Kennedy of the University of California. This depends upon measuring the radiation damage produced in clay minerals owing to the presence in them of small amounts of radioactive impurities such as uranium and thorium. This radiation damage consists of defects in the crystal lattice, which act as electron traps. If the clay sample is heated to about 400° C., the excess energy of the electrons is released as visible light, which can be measured by a photo-multiplier. The amount of light is proportional to the amount of damage, which is itself proportional to the length of time during which the radiation damage has been accumulating. For pottery this would be the time elapsed since it was originally fired, and herein lies the value of this dating method in archeology. Potsherds are among the commonest of archeological material, and, unlike the magnetic dating method, the thermoluminescent dating method would not require the finding of the sample in situ. If further research should establish this as a reliable method of dating, it will undoubtedly be of enormous value for prehistoric archeology.

To the archeologist, dating is of vital importance, and the subtle methods which the scientist is now evolving—and may continue to evolve—will be of great value in throwing light on many problems of chronology.

CONCLUSION

The foregoing account of the kind of work that is carried out in a museum laboratory has of necessity been selective, since space has only permitted the discussion of a limited range of problems. No reference has been made, for example, to the use of scientific methods in problems of authenticity. However, the selected topics will serve to demonstrate that the work involved is very varied, both as regards the type of problem itself—whether it be of conservation or of scientific examination—and the new methods of investigation used by chemists and physicists to solve these problems. In this fascinating field of activity,

the newest materials and techniques are being adapted to conserve and to examine the antiquities which are brought to light by the excavation of the archeologist. The concept of museum laboratories has now become firmly established, and the spirit of cooperation thus engendered between the scientist and the archeologist is of mutual advantage. The archeologist learns more about the technical aspects of his material and is assured that the treasures which he excavates will be preserved by the best possible means. In return, the horizon of the scientist is considerably broadened and his field of interest enlarged beyond the confines of his laboratory by the knowledge that his studies are correlated with the historical development of mankind.

REFERENCES

1. CALEY, E. R., *Journ. Chem. Educ.*, vol. 28, p. 64, 1951.
2. WERNER, A. E. A., *Museums Journ.*, vol. 57, p. 159, 1957.
3. *Climatology and Conservation in Museums*, Museum, vol. 13, p. 202, 1960.
4. ORGAN, R. M., *Museums Journ.*, vol. 56, p. 265, 1957.
5. *Ciba Technical Notes*, No. 218, 1961.
6. ORGAN, R. M., *Studies in Conservation*, vol. 4, p. 4, 1959.
7. WERNER, A. E. A., *Museums Journ.*, vol. 57, p. 3, 1957.
8. ORGAN, R. M., *Studies in Conservation*, vol. 4, p. 96, 1959.
9. MÜLLER-BECK, H., and HAAS, A., *Studies in Conservation*, vol. 5, p. 150, 1960.
10. WERNER, A. E. A., *Chronique d'Egypte*, vol. 33, p. 273, 1958.
11. PLENDERLEITH, H. J., *Technical Report in Enkomi-Alasia*, by C. F. A. Schaeffer, pp. 381-389, Paris, 1952.
12. RICHARDS, E. E., and HARTLEY, K. F., *Nature*, vol. 185, p. 194, 1960.
13. BROWN, M. A., and BLIN-STOYLE, A. E., *Proc. Prehistoric Soc.* 1959, No. 6, p. 188; and *Archaeometry*, vol. 2, supplement, 1959.
14. TURNER, W. S. E., and ROOKSBY, H. P., *Glastechnische Berichte*, vol. 7, p. 17, 1959.
15. YOUNG, S., *Oriental Art*, vol. 2, p. 43, 1959.
16. AITKEN, M. J., et al., *Radioisotopes in physical sciences (Copenhagen Conference) RICC/37*. International Atomic Energy Authority, Vienna (1960).
17. SAYRE, E. V., *Application of science in examination of works of art*, p. 153, *Museum of Fine Arts*, Boston, 1959.
18. BRILL, R. H., and MOLL, S., *Proc. Rome Conference Internat. Inst. Conservation*, p. 260, London, 1961.
19. *Physics and Archaeology*. Interscience Publishers, New York and London, 1961.

INDEX

- Abbot, C. G., x
 Accessions, 11, 67, 95, 106, 136, 197, 211
 Bureau of American Ethnology, 67
 Freer Gallery of Art, 106
 Library, 211
 National Air Museum, 127
 National Collection of Fine Arts, 95
 National Gallery of Art, 197
 National Museum, 11
 National Zoological Park, 136
 Adams, Cynthia L., vii
 Aircraft propulsion, A review of the evolution of aircraft powerplants (C. Fayette Taylor), 215
 Allen, Maj. Gen. Brooke E., viii
 American Historical Association, 221
 Anderson, Clinton P., regent of the Institution, v, 5, 37
 Andrews, A. J., vi
 Anglim, J. E., vi, 38
 Antiquities, Scientific methods in the examination and conservation of (A. E. A. Werner), 593
 Appropriations, 5, 6, 197
 National Zoological Park, 6
 National Gallery of Art, 197
 River Basin Surveys, 6
 Archery, A chapter in the evolution of, in America (Paul E. Klopsteg), 567
 Arctic Ocean, The opening of the (James T. Strong), 391
 Astrophysical Observatory, vii, x, 71
 Astrophysical Research, Division of, 71
 Publications, 81, 221
 Radiation and Organisms, Division of, viii, 88
 Report, 71
 Staff, 88
 Table Mountain, Calif., field station, 71
 Avrett, E., viii, 73
 Baker, Thomas G., 27
 Bass, William M., 42, 57, 59
 Bassler, R. S., 41
 Battison, E. A., vii
 Bayer, F. M., 41
 Beadle, George W. (The place of genetics in modern biology), 399
 Bedini, S. A., vii, 41
 Beggs, T. M., Director, National Collection of Fine Arts, viii, 94, 104
 Benjamin, C. R., x
 Biebighauser, Ernest E., 221
 Bishop, P. W., vii
 Blake, Mrs. Doris H., ix
 Blaker, Mrs. Margaret C., 67
 Blanchard, Ruth E., librarian, v, 214
 Bliss, Robert Woods, 94
 Boardman, R. S., vi, 30
 Bory, B. S., vii, 38
 Bow, Frank T., regent of the Institution, v, 5
 Bowers, Alfred W., 60
 Bowman, T. E., vi
 Bows and arrows: A chapter in the evolution of archery in America (Paul E. Klopsteg), 567
 Boyle, W. E., vi
 Bradley, James C., Assistant Secretary of the Institution, v, 94
 Bredin, J. Bruce, ix
 Briggs, R. E., viii, 77
 Brink, A. S., 32
 Brooks, Overton, 5
 Brown, John Nicholas, regent of the Institution, v, 5
 Brown, Lionel A., 60, 63
 Brown, W. L., x
 Buckles, William G., 53
 Bureau of American Ethnology, vii, x, 42
 Archives, 67
 Collections, 69
 Editorial work and publications, 68
 Exploration and fieldwork, 42
 Illustrations, 68
 Library, 68
 Report, 42
 Researches, 42
 River Basin Surveys, 46
 Staff, x
 Burnham, Mrs. Sophy D., 225
 Byrd, Mrs. Mabel A., vi
 Cahill, James F., viii
 Cairns, Huntington, ix, 196, 210
 Caldwell, Warren W., 54, 59, 63
 Campbell, J. M., ix
 Canal Zone Biological Area, viii, x, 180
 Buildings, equipment, and improvements, 184
 Finances, 185
 Plans and requirements, 185
 Rainfall, 183
 Report, 180
 Scientists, students, and observers at, 180
 Visitors, 183
 Cannon, Clarence, regent of the Institution, v, 5, 241
 Cannon, W. F., vii, 40

- Carmichael, Leonard, Secretary of the Institution, v, viii, ix, 1, 99
 Carriker, M. A., ix
 Cartwright, O. L., vi
 Casey, L. S., viii, 122
 Chace, F. A., Jr., vi, 35
 Chafe, W. L., vii, 45, 69
 Chapelle, H. L., vii
 Chase, Mrs. Agnes, x
 Chief Justice of the United States (Earl Warren, Chancellor of the Institution), v, ix, 5, 196
 Chile, The great earthquakes of May 1960 in (Pierre Saint-Amand), 337
 Christenson, L. D. (Tropical fruit-fly menace), 441
 Cifelli, Richard, vi, 31
 Civilization and the landscape (Sylvia Crowe), 537
 Clain-Stefanelli, Mrs. Elvira, vii, 33
 Clain-Stefanelli, Vladimir, vii, 33
 Clark, Ailsa M., ix
 Clarke, Gilmore D., 94
 Clarke, J. F. G., vi, 27
 Clarke, R. S., Jr., vi
 Cochran, Doris S., vi
 Cole, G. H., ix, 23
 Collins, H. B., Jr., vii
 Collins, H. R., vii, 43
 Collins, J. A., Chief, International Exchange Service, ix, 195
 Colombo, G., vii, 78
 Colvin, William B., 60
 Compton, Arthur H., 5
 Conger, P. S., vi
 Cook, A. F., viii, 88
 Cooke, C. W., x
 Cooper, G. A., vi, 29
 Cooper, Mrs. Grace R., vii
 Cooper, Ralph S. (Rocket propulsion), 299
 Cott, Perry B., ix, 196, 205
 Cottons, The history and relationships of the world's (Sir Joseph Hutchinson), 497
 Cowan, R. S., vi, 28
 Crabill, R. E., Jr., vi
 Crawford, Frederick C., x
 Crocker, W. H., vi, 40
 Crowe, Sylvia (Civilization and the landscape), 537
 Cutress, C. E., vi

 Dale, Chester, ix, 196, 197
 Dalquest, Walter W., 33
 Daughters of the American Revolution, National Society of, 221
 Davis, D. R., vi, 40
 Davis, R. J., viii, 78, 87
 Dawson, E. Yale (The rim of the reef), 265
 Day, J. Edward, Postmaster General, member of the Institution, v
 Deignan, Herbert G., ix, 41
 Deignan, Mrs. Stella Leche, 224
 DeFelice, J., viii, 74
 deLint, P. J. A. L., viii
 DeLong, Dwight M. (Man in a world of insects), 423
 Desautels, P. E., vi
 Desmond, Annabelle (How many people have ever lived on earth?), 545
 Dillon, Douglas, Secretary of the Treasury, member of the Institution, v, ix, 196
 Docent service, 38, 224
 Doolittle, Lt. Gen. James H., viii, 223
 Drake, C. J., ix

 Earthquakes, The great, of May 1960 in Chile (Pierre Saint-Amand), 337
 Echinoderms, The evolution of the (H. Barraclough Fell), 457
 Edelen, Mrs. Eloise B., 68, 220
 Edwards, J. L., viii
 Elder, R. A., Jr., vi
 Elstad, V. B., viii
 Esch, Doris A., vii, 41
 Establishment, The, 4
 Ettinghausen, Richard, viii
 Evans, Clifford, Jr., vi, 22
 Evolution of the echinoderms, The (H. Barraclough Fell), 457
 Executive Committee of the Board of Regents, v
 Report, 227
 Exhibitions, 34
 National Collection of Fine Arts, 99, 103
 National Gallery of Art, 203
 National Museum, 34
 Smithsonian Traveling Exhibition, Service, 99
 Exploration and fieldwork, Bureau of America Ethnology, 42
 National Museum, 22
 River Basin Surveys, 42

 Feidler, Ernest R., ix, 196
 Feinstein, Bernard R., 26
 Fell, H. Barraclough (The evolution of the echinoderms), 457
 Field, W. D., vi, 27
 Ewers, J. C., vi, 38
 Finances, 5, 227
 Audit, 240
 Endowments, summary of, 231
 Executive Committee Report, 227
 Freer Gallery, 230
 See also Appropriations
 Finley, David E., 94
 Finnegan, Ellen J., vii, 41
 Fireman, E. L., viii, 74
 Fleming, Robert V., regent of the Institution, v, 5, 241
 Flint, O. S., Jr., vi, 27
 Franklin, F., viii, 77
 Freeman, Monroe E., 224
 Freeman, Orville L., Secretary of Agriculture, member of the Institution, v
 Freer Gallery of Art, viii, x, 105
 Attendance, 111
 Auditorium, 111
 Building and grounds, 110
 Changes in exhibitions, 108

- Collections, 106, 108
 Library, 109
 Photographic laboratory, 110
 Publications, 110
 Report, 105
 Staff activities, 113
 Friedmann, Herbert, ix
 Fruit-fly, tropical, menace (L. D. Christenson), 441
 Fulbright, J. William, regent of the Institution, v, 5

 Garber, P. E., viii, 122
 Gardner, P. V., vii
 Garrick, J. A. F., 27
 Gazin, C. L., vi, 22, 31
 Genetics, The place of in modern biology (George W. Beadle), 399
 Gettens, Rutherford J., viii
 Gibson, G. D., vi
 Gifts. *See* Accessions; *also* Gifts and grants (monetary)
 Gifts and grants (monetary), 185, 197, 240
 Gingerich, O., viii, 73, 87
 Glass, Modern (S. Donald Stookey), 323
 Goins, C. R., Jr., vii
 Goldberg, Arthur J., Secretary of Labor. member of the Institution, v
 Goldberg, L., vii, 71, 87
 Goldberg, Mrs. Arthur, 226
 Grabar, Oleg, x
 Graf, John E., ix
 Graham, D. C., 41
 Grant, Richard E., 29
 Greenwalt, Crawford H., regent of the Institution, v, 5
 Greenwell, F. M., 25
 Greenwood, Mrs. Arthur M., x
 Greeson, O. H., chief, photographic service division, v
 Griffith, F. O., vii
 Grimmer, J. L., viii, 140, 165
 Grossi, M., viii, 79
 Guest, Grace Dunham, x

 Hale, M. E., Jr., vi
 Hamarneh, S. K., vii
 Hamid, S., vii, 76
 Hancock, Walter, 94
 Handley, C. O., Jr., vi, 25
 Harrington, John P., 67, 69
 Harrison, J. H., viii, 92
 Haskins, Caryl P., regent of the Institution, v, 5, 241
 Hathaway, Anthony W., vii
 Hayes, Bartlett H., 94
 Henderson, E. P., vi, 29
 Herber, E. C., x
 Hersey, David, 224
 Hilger, Sister M. Inez, x, 69
 Hobbs, H. H., Jr., vi, 24, 40
 Hodge, P. W., viii, 73, 77
 Hodges, Luther H., Secretary of Commerce, member of the Institution, v

 Hoffman, John J., 59
 Hopkins, P. S., Director, National Air Museum, viii, 131
 Hotton, Nicholas, III, vi, 5, 32
 Houston, C. O., Jr., vii
 Howell, A. B., 41
 Howell, E. M., vii
 Howland, Richard II., vii
 Hull, F. M., ix
 Hume, I. N., x
 Humphrey, P. S., vi, 40
 Hunsaker, Jerome C., regent of the Institution, v, 5
 Huscher, Harole A., 49
 Husted, Wilfred M., 60, 64
 Hutchinson, Sir Joseph (The history and relationships of the world's cottons), 497

 Ide, John J., x
 Insects, man in a world of (Dwight M. DeLong), 423
 International Exchange Service, ix, 186
 Foreign depositories of governmental documents, 189
 Interparliamentary exchange of the official journals, 191
 Packages forwarded, 195
 Publications received, 195
 Report, 186
 Ireland, R. R., Jr., 41
 Irvin, John N., II, ix
 Irving, Laurence, ix
 Izsak, I. G., vii, 79, 87

 Jacchia, L. G., viii, 72, 76, 78, 87
 Jackson, M. H., vii, 41
 James, William R., 166
 Jamme, Albert, ix, 23, 24
 Jellison, W. L., ix
 Jensen, Richard E., 54, 59
 Johnson, D. H., vi
 Johnson, Lyndon B., Vice President of the United States, member of the Institution, v
 Judd, N. M., ix
 Junior League of Washington, 38, 224

 Kainen, Jacob, vii
 Kalkofen, W., viii, 72
 Kendall, E. C., vii
 Kauffman, E. G., vi, 30
 Kellogg, A. Remington, Assistant Secretary of the Institution, v, 41
 Kennedy, J. A., director of personnel, v
 Kennedy, John F., President of the United States, Presiding Officer ex officio, v
 Kennedy, Robert F., Attorney General, member of the Institution, v
 Kier, P. M., vi, 30
 Killip, E. P., x
 Kirwan, Michael J., regent of the Institution, v, 5
 Kitchin, J. W., 32
 Klaphor, Mrs. Margaret Brown, vii
 Klein, W. H., viii, 88, 92

- Klopsteg, Paul E. (Bows and arrows: A chapter in the evolution of archery in America), 567
- Kloster, Donald E., 34
- Knez, E. L., vi
- Kozai, Y., vii, 79, 87
- Kress, Rush H., ix
- Krieger, H. W., ix
- Krook, M., viii, 72, 73
- Lachner, E. A., vi
- Landscape, Civilization and the (Sylvia Crowe), 537
- Lassovszky, Karoly, 88
- Latterell, R. L., viii, 92
- Laughlin, R. M., 46, 69
- Lautman, D. A., viii, 79
- Lawless, B. W., Jr., vii, 38
- Lectures, 223
- Lea, John S., 218
- Leonard, E. C., x, 41
- Lewis, L. C., vii, 40
- Lewis, Wilmarth, 94
- Library, Bureau of American Ethnology, 68
- Freer Gallery of Art, 109
- Main Smithsonian Library, Report, 211
- National Gallery of Art, 208
- Life, The soil as a habitat for (Sir John Russell), 449
- Life and existence, some mysteries of (R. E. Snodgrass), 517
- Liller, William, 71
- Lindsay, G. Carroll, curator, Smithsonian Museum Service, v, 39, 224, 226
- Livingston, Jerry L., 57
- Loehr, Max, x
- Loening, Grover, viii
- Lundeberg, Philip K., vii, 5
- Lyon, Rowland, viii
- MacKay, F. W., x
- MacManus, Ruth B., 216
- Madison, Lee G., 56, 59
- Mallory, Oscar L., 60
- Mamay, Sergius H., 33
- Man in a world of insects (Dwight M. DeLong), 423
- Mangroves: Trees that make land (William M. Stephens), 491
- Manship, Paul, 94
- Marchand, Paul, 28
- Margulies, M., viii
- Marron, Harvey, 224
- Marvin, U. B., viii, 74, 88
- Matternes, J. H., 35
- Matthews, L. Harrison (The shark that hibernates), 415
- McCall, F. J., vii
- McClure, F. A., x
- McCrane, Marion, viii, 166
- McCrosky, R. E., viii, 73, 75, 76
- McIlhenny, Henry P., 94
- McIntosh, Allen, ix
- McNamara, Robert S., Secretary of Defense, member of the Institution, v
- Meggers, Betty, ix, 22
- Melder, K. E., vii, 41
- Mellon, Paul, ix, 196, 197
- Metcalf, George S., 22
- Meyer, R. B., viii
- Michaels, Andrew F., buildings manager, v
- Miller, Carl F., 49, 61, 66
- Mitler, H., viii, 73, 88
- Mitrakos, K., viii
- Moore, J. P., ix
- Morrison, J. P. E., vi
- Morton, C. V., vi
- Moynihan, M. H., resident naturalist, Canal Zone Biological Area, viii, 185
- Muesebeck, C. F. W., ix
- Muller, Jon, 59
- Multhauf, R. P., vii
- Murray, Mrs. Anne W., vii
- Museum of History and Technology, vi, x, 3, 4
- Museum of Natural History, vi, ix, 2, 4
- National Air Museum, viii, x, 121
- Accessions, 127
- Advisory Board, viii, 121
- Exhibits, 122
- Repairs, preservation, and restoration, 122
- Report, 121
- Special events, 122
- Staff, viii
- National Collection of Fine Arts, viii, 94
- Alice Pike Barney Memorial Fund, 97
- Art works lent and returned, 96
- Catherine Walden Myer Fund, 95
- Henry Ward Ranger Fund, 97
- Report, 94
- Smithsonian Art Commission, 94
- Smithsonian lending collection, 97
- Smithsonian Traveling Exhibition Service, 99
- Special exhibitions, 103
- Staff activities, 101
- National Gallery of Art, ix, 196
- Accessions, 197
- Appropriations, 197
- Attendance, 197
- Building and grounds, 209
- Curatorial activities, 205
- Educational program, 206
- Exchanges of works of art, 202
- Exhibitions, 203
- Extension services, 207
- Gifts, 197
- Index of American Design, 208
- Library, 208
- Organization, 196
- Personnel, 197
- Publications, 206
- Report, 196
- Restoration, 205
- Traveling exhibitions, 204

- Trustees, ix
 Works of art on loan, 202, 203
- National Museum, vi, 8
 Buildings and equipment, 40
 Collections, 8
 Docent service, 38
 Exhibitions, 34
 Explorations and fieldwork, 22
 Organization and staff, changes in, 40
 Publications, 218
 Report, 8
 Staff, vi
- National Zoological Park, viii, x, 132
 Animals in the collection on June 30, 1962, 141
 Births, 132
 Collection, status of, 141
 Cooperation, 172
 Exchanges, 138
 Friends of the National Zoo, 167
 Gifts, 136
 Information and education, 167
 Maintenance, construction, and grounds, 177
 Personnel, 166
 Plans for the future, 178
 Police department, 175
 Purchases, 138
 Reorganization, 165
 Report, 132
 Safety subcommittee, 176
 Veterinarian, report of the, 168
 Visitors, 174
- Neuman, Robert W., 53, 59, 64
 Newland, K. E., viii, 122
 Newman, M. T., vi, 24
 Noonan, T. W., viii, 73, 88
- Oehser, Paul H., chief, editorial and publications division, v, 222
 Ostroff, Eugene, vii
- Page, R. M. (The early history of radar), 315
- Parker, Kittie F., x
 Pearce, F. L., vi, 31
 Pearce, J. N., vii
 Pearson, Mrs. Louise M., administrative assistant to the Secretary, v
 People, How many have ever lived on earth? (Annabelle Desmond), 545
- Perry, K. M., vii
 Perrygo, W. M., vi
 Peterson, M. L., vii
 Pleissner, Ogden M., 94
 Pope, John A., Director, Freer Gallery of Art, viii, 103, 120
 Pope, Mrs. Annemarie H., viii
 President of the United States (John F. Kennedy), Presiding Officer, ex officio, v
 Price, D. J., x
 Price, L., viii
- Publications, American Historical Association, 221
 Astrophysical Observatory, 81
 Bureau of American Ethnology, 220
- Daughters of the American Revolution, 221
 Distribution, 215
 Freer Gallery of Art, 110
 National Collections of Fine Arts, 221
 National Gallery of Art, 206
 National Museum, 218
 Radiation and Organisms, 91
 Report on, 215
 Smithsonian Annual Reports, 217
 Smithsonian Miscellaneous Collections, 216
 Special, 218
- Radar, The early history of (R. M. Page), 315
- Radiation and Organisms, Division of, viii, 91
 Publications, 91
 Report, 88
 Staff, viii
- Ranck, Gary L., 25
- Reed, T. H., Director, National Zoological Park, viii, 179
- Reef, The rim of the (E. Yale Dawson), 365
- Regents, Board of, v, 5
 Annual meeting, 17
 Executive Committee, v, 227
- Rehder, H. A., vi
- Research associates, collaborators, and fellows, ix
- Rhodes, Katherine N., x
- Ribicoff, Abraham A., Secretary of Health, Education, and Welfare, member of the Institution, v
- Riesenberg, S. H., vi
- Riggs, R. B., Jr., viii, 75
- River Basin Surveys, 46
 Appropriation, 6
 Fieldwork, 42
 Report, 46
 Staff, x
 Washington office, 49
- Roberts, F. H. H., Jr., Director, Bureau of American Ethnology, vii, 42, 43, 70
- Robinove, Charles J. (What's happening to water?), 375
- Rocket propulsion (Ralph S. Cooper), 299
- Rolf, J., viii
- Rosewater, Joseph, vi, 40
- Roth, Rodris C., vii, 33
- Roth, Waldfried T., viii, 166
- Roy, Edgar L., treasurer, v
- Rudd, Velva E., vi, 28
- Rudmann, Joseph E., vii, 41
- Rusk, Dean, Secretary of State, member of the Institution, v, ix
- Russell, Sir John (The soil as a habitat for life), 449
- Rustgi, O. P., viii, 78
- Saint-Amand, Pierre (The great earthquakes of May 1960 in Chile), 337
- Saltonstall, Leverett, regent of the Institution, v

- Satellite-tracking program, 80
 Sawyer, Charles H., 94
 Sayre, Reginald J., 28
 Schaller, W. T., x
 Scheele, C. H., vii
 Schmidt, John W., 38
 Schmitt, W. L., ix
 Schultz, L. P., vi, 27
 Schwartz, Benjamin, ix
 Schwarzschild, Martin, 223
 Science Information Exchange, 223
 Scientific methods in the examination and conservation of antiquities (A. E. A. Werner), 593
 Secretary of the Institution (Leonard Carmichael), v, viii, ix, 1
 Setzer, H. W., vi, 23, 24, 25
 Setzler, F. M., ix
 Shark that hibernates, The (L. Harrison Matthews), 415
 Shropshire, W., viii, 92
 Skalafuris, A., viii, 72
 Slowey, J., vii, 79
 Smith, A. C., Director, Museum of Natural History, vi
 Smith, G. Hubert, 58, 59, 65
 Smith, H. Morgan, ix
 Smith, L. B., vi
 Smithsonian Art Commission, 94
 Smithsonian Museum Service, 224
 Smithsonian Traveling Exhibition Service, 99
 Snodgrass, R. E., ix, 517
 Snodgrass, R. E. (Some mysteries of life and existence), 517
 Snyder, T. E., ix
 Soderstrom, T. R., vi, 28, 29
 Soil as a habitat for life, The (Sir John Russell), 449
 Soper, C. C., x
 Southworth, R. B., viii, 76, 87
 Squires, D. F., vi, 27, 40
 Stephens, William M. (Mangroves: Trees that make land), 491
 Stephenson, R. L., vii, 56, 62
 Stern, Harold P., viii, 5
 Stern, W. L., vi, 29
 Stevenson, J. A., x
 Stewart, T. Dale, vi, 22
 Stirling, M. W., x, 69
 Stookey, S. Donald (Modern glass), 323
 Stratton, Mrs. Janet, 225
 Strong, James T. (The opening of the Arctic Ocean), 391
 Stroop, P. D., Rear Adm., viii
 Sturtevant, W. C., vii, 44, 45
 Swallen, J. R., vi
 Switzer, G. S., vi
 Talbert, D. G., viii
 Taylor, C. Fayette (Aircraft propulsion: A review of the evolution of aircraft powerplants), 245
 Taylor, Frank A., Director, Museum of History and Technology, vi
 Taylor, Theodore W., Assistant to the Secretary, v, 94
 Taylor, W. R., vi
 Taylor, W. W., Jr., ix
 Tilles, D., viii, 74, 87
 Tillinghast, C. W., vii
 Tobin, W. J., ix, 24
 Tretick, Julius, vii
 Turner, G. T., vii
 Udall, Stewart L., Secretary of the Interior, member of the Institution, v
 Van Beek, G. W., vi, 23, 24, 25
 Veis, G., viii, 79
 Verville, Alfred V., x
 Visitors, 6
 Air and Space Building, 6
 Canal Zone Biological Area, 183
 Freer Gallery of Art, 6
 National Gallery of Art, 6
 National Zoological Park, 174
 Natural History Building, 6
 Smithsonian Building, 6
 Vogel, R. M., vii
 Walker, E. P., x
 Walker, John, ix, 196, 197
 Waring, A. J., Jr. x, 69
 Warren, Earl, Chief Justice of the United States, Chancellor of the Institution, v, 5, ix, 196
 Washburn, W. E., vii, 33
 Water, What's happening to (Charles J. Robinove), 375
 Watkins, C. Malcolm, vii
 Watkins, W. N., x
 Wedel, W. R., vi, 22
 Weiss, Helena M., registrar, vi
 Welsh, P. C., vii
 Wengenroth, Stow, 94
 Wenley Archibald Gibson, 94, 105
 Werner, A. E. A. (Scientific methods in the examination and conservation of antiquities), 593
 Wetmore, Alexander, ix, 25, 26
 Whipple, F. L., vii, 5, 87, 93
 White, J. H., Jr., vii
 Whitney, C. A., viii, 72
 Whitney, John Hay, ix, 196, 197
 Wilding, A. W., chief, supply division, v
 Wilson, Druid, 30
 Wilson, Mrs. Mildred S., ix
 Wood, John, viii, 75
 Woodring, W. P., x
 Wright, F. W., vii, 73, 77, 88
 Wright, James F., viii, 166
 Wurdack, J. J., vi, 28
 Wyeth, Andrew, 94
 Young, Rodney, 223
 Zadunaisky, P. E., vii, 75

SMITHSONIAN INSTITUTION LIBRARIES



3 9088 00947 9627