





Library  
of the  
University of Toronto



76



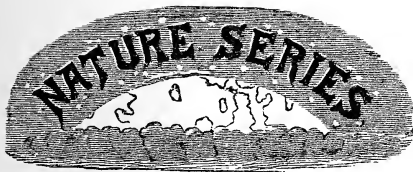

THE APODIDÆ



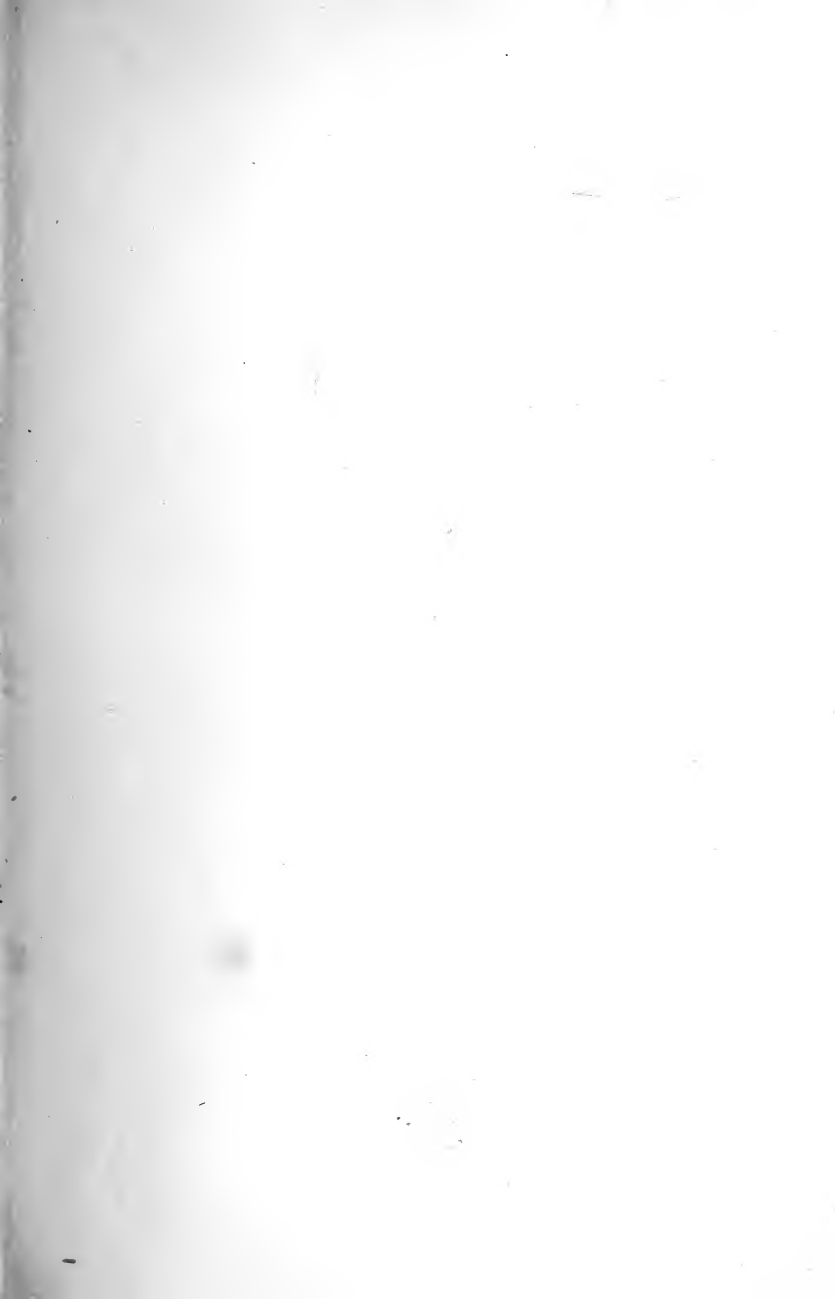

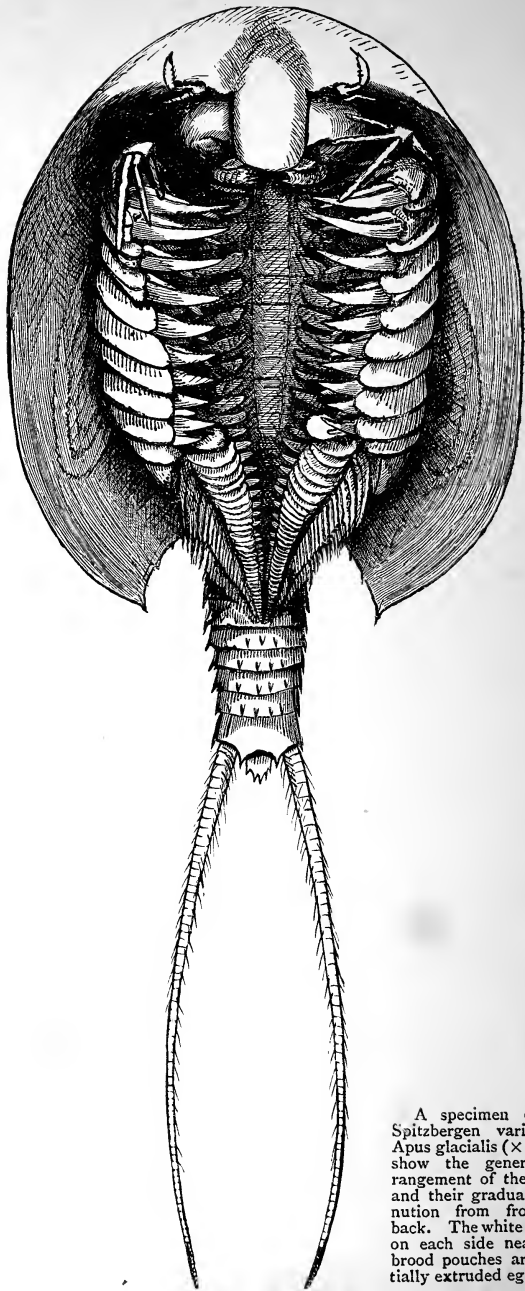

A specimen of the Spitzbergen variety of *Apus glacialis* ( $\times 10$ ), to show the general arrangement of the limbs and their gradual diminution from front to back. The white masses on each side near the brood pouches are partially extruded eggs.

*NATURE SERIES*

# THE APODIDÆ

*A MORPHOLOGICAL STUDY*

BY

HENRY MEYNEERS BERNARD

M.A. CANTAB.

*WITH SEVENTY-ONE ILLUSTRATIONS*

London

MACMILLAN AND CO.

AND NEW YORK

1892

*The Right of Translation and Reproduction is Reserved*

RICHARD CLAY AND SONS, LIMITED,  
LONDON AND BUNGAY.

TO THE MEMORY OF  
DR. ALFRED WALTER  
TOO SOON LOST TO SCIENCE  
AND  
TO THE MANY FRIENDS WHO LOVED  
HIM AS A MAN

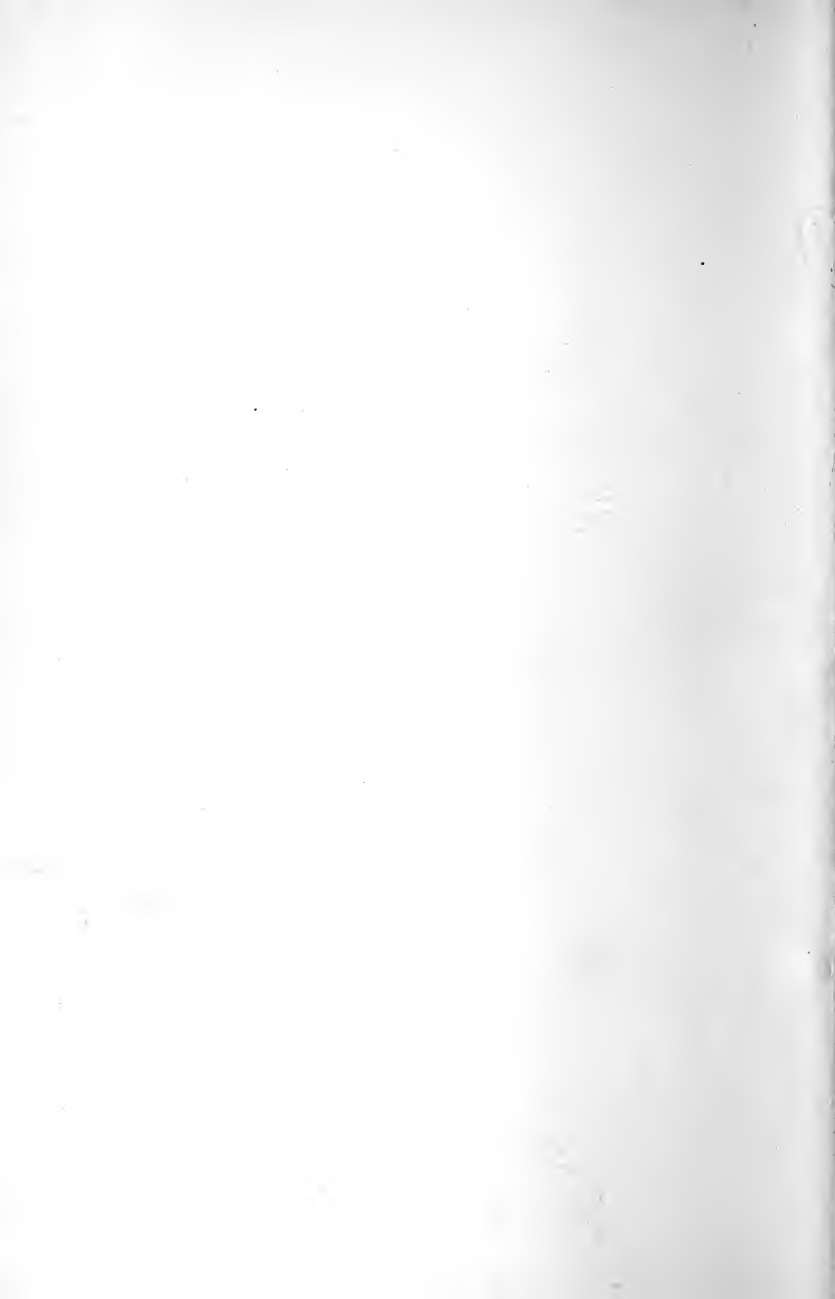



# TABLE OF CONTENTS

	PAGE
INTRODUCTION . . . . .	xi

## PART I

§ I. OBJECT AND LINE OF ARGUMENT . . . . .	I
§ II. THE OUTER BODY FORM . . . . .	11
§ III. THE APPENDAGES . . . . .	26
§ IV. THE MUSCULATURE . . . . .	52
§ V. THE NERVOUS SYSTEM . . . . .	67
§ VI. THE SENSORY ORGANS . . . . .	84
§ VII. THE ALIMENTARY CANAL . . . . .	112
§ VIII. THE CIRCULATORY SYSTEM . . . . .	117
§ IX. THE EXCRETORY AND OTHER GLANDS . . . . .	124
§ X. REPRODUCTION . . . . .	140
§ XI. DEVELOPMENT—THE NAUPLIUS . . . . .	148

## PART II

	PAGE
§ XII. RELATION OF APUS TO THE OTHER CRUSTACEA—	
LIMULUS . . . . .	173
§ XIII. THE TRILOBITES . . . . .	209
§ XIV. THE EURYPTERIDÆ . . . . .	237
§ XV. THE NEW CLASSIFICATION PROPOSED . . . . .	252
§ XVI. PERIPATUS AND THE TRACHEATA . . . . .	279
APPENDICES . . . . .	291
LITERATURE . . . . .	313

## INTRODUCTION

AMONG the numerous interesting zoological specimens brought back by Professor Kükenthal from East Spitzbergen on his return from the Bremen Expedition (1889),<sup>1</sup> was a small species of *Apus*—presumably *Lepidurus glacialis* (Kroyer). Professor Kükenthal very kindly handed these specimens to me for examination. By the kindness of the Rev. Canon Norman, I also received Greenland specimens of *Lepidurus glacialis* (Kroyer), and from Professor Leché, of Stockholm, specimens of the *Lepidurus glacialis* found by Professor Nathorst in West Spitzbergen ; Professor Möbius, the director of the Berlin Natural History Museum, generously sent me speci-

<sup>1</sup> Dr. Alfred Walter, to whom this book is dedicated, was Professor Kükenthal's companion during this expedition. He died shortly after his return.

mens of *Apus cancriformis*, and Professor Biedermann, of Jena, very kindly obtained for me specimens of *Apus cancriformis*, *Lepidurus productus*, and *Branchipus stagnalis* from Prague, especially preserved for histological purposes. An examination of the Spitzbergen specimen led to the conclusion that it was a small variety of *Lepidurus glacialis*, which I propose to call *Lepidurus Spitzbergensis*; the grounds for this determination are given fully in Appendix I.

In studying the anatomy of the Spitzbergen specimens, and in comparing it with that of the other members of the family kindly placed at my disposal by the gentlemen above named, I was gradually led to cast my notes into the form in which they are now published.

It has long been recognised that the Phyllopoda possess many markedly Annelidan characteristics, and that they are therefore, of all living Crustacea, nearest in affinity to the primitive Crustacean. In my study of the Apodidæ I was so much struck by the resemblance between the organisation of *Apus* and that of a carnivorous Annelid, that I finally decided to work entirely along this line. I resolved, by a closer study

---

of each organ and system of organs, to find out as far as possible whether this resemblance was a case of homology or analogy, and, if the former, to endeavour to trace the causes which led to the transformation of the carnivorous Annelid into the Crustacean.

Shrewd conjectures have been made as to the possible derivation of the Crustacea from Annelids, but I am not aware that this point has ever before been worked out in detail, and I should hardly have ventured to undertake such a task had not my study of *Apus* forced it upon me.

My original intention<sup>1</sup> of preparing a comparative anatomy of the Apodidæ thus gave way before the more ambitious attempt to use *Apus* as a key to solve the hitherto unsolved problems as to the origin of the Crustacea, and the true affinities between the various groups.

This resolution, however, was not formed at once. The book is written in the order in which the subject was worked out.

The first part, which deduces *Apus* from a carnivorous Annelid, was all I at first intended to publish. Having never made a special study of *Limulus* nor

<sup>1</sup> Announced in a letter to *Nature*, reprinted in Appendix V.

of the Trilobites, I hesitated to discuss their relation to Apus, and my knowledge of the Crustacea was not sufficient to justify my attempting to form a genealogical tree of the whole class. I intended to content myself with an endeavour to show that in the Apodidæ the process and method of the transformation of carnivorous Annelids into Crustacea was still visible in almost every organ and system of organs. The unavoidable conclusion from this would be, that Apus must be—for some groups at least—the original form.

Here I thought to leave the matter to be followed up by zoologists whose knowledge and experience of the special groups were greater than my own. My curiosity, however, was too great, and after the first part of this manuscript was practically in its present form, I decided to see, by a study of *Limulus* and the Trilobites, whether Apus was to be looked upon as the original form of the modern Crustacea only, or whether it could pass for the original of the whole class, including these archaic forms. This investigation led to the writing of the second part, which was thus an afterthought—an afterthought which, however, gives to the book whatever value it possesses.

The attempted proof in the first part that *Apus* is an original Crustacean easily derivable from an Annelid, however interesting in itself, must have remained little more than a curious morphological study. The appeal made in the second part to palæozoic Crustacea must, however, be decisive as to whether our claims for *Apus* as one of the original forms can be definitely established.

In commencing Part II., it was no small encouragement to find that most of the earlier zoologists, as if by instinct, classed *Apus* with the Xiphosuridæ and the Trilobites. This provisional classification had not, however, held its own, and it was necessary to examine the reasons why it had not done so, and to see if it was not after all justified by the facts. My investigations led me to the conclusion that if *Apus* is deducible from a carnivorous Annelid in the manner described in the first part, there is no possible escape from accepting a similar derivation for the Gigantostraca, as Haeckel has called these ancient forms. I found that, strange as it may at first seem, the very differences between *Apus* and these ancient Crustaceans yielded almost more striking proofs of their having had the same origin and of their close

relationship, than did the many resemblances which have been long recognised as existing between them. The second part thus proves what the first part only rendered probable.

In such an investigation as this a writer is always open to the charge of having interpreted the facts as he wished to interpret them. I cannot of course deny that the speculation was of such absorbing interest that I was not indifferent to the conclusion, and that I therefore naturally seized upon the facts most favourable for the establishment of my argument ; but at the same time I am not conscious of having ignored difficulties. If, nevertheless, I have unconsciously distorted the facts in order to establish my conclusions, I comfort myself by the reflection that those conclusions are of such great zoological importance that they cannot long pass unchallenged.

I may perhaps mention the fact that whereas in the first part I have relied almost entirely upon my own researches into the anatomy of the Apodidæ and of the carnivorous Annelids, in the second part I have had to draw many of the facts used in the arguments from the works of others.

My sincere thanks are due to Professor Ernst



---

Haeckel, in whose laboratory the researches on which the following essay is based were carried out, for the friendly interest he took in them ; and also to Professor Kükenthal for his cordial sympathy and encouragement to proceed in a speculation which claims to solve so intricate a problem as the origin of the Crustacea.

H. M. B.

*Streatham, 1892.*



PART I



# THE APODIDÆ

## *PART I*

### SECTION I

#### OBJECT AND LINE OF ARGUMENT

THE Apodidæ have been known and studied for the last one hundred and fifty years. They have always attracted considerable attention, not only on account of their great size in comparison with other fresh-water Entomostraca, but also on account of their strange and sudden appearance in pools and ditches which owe their water entirely to the rainfall. This also is not all: their morphology has been a perpetual puzzle to zoologists, and they have been classed by some with archaic forms such as the Trilobites and *Limulus*, while by others they have been considered as highly specialised recent forms.

This essay claims by a new explanation of the morphology of the Crustacea, to set this latter point

at rest, and to show that *Apus* must not only be ranked by the side of the Trilobites as one of the primitive Crustacean forms, but that it is itself a true link between the living Crustacea and the Annelida. By careful examination of the organisation of *Apus*, and a comparison of it with that of a carnivorous Annelid, it is possible to show, as will be done in the following pages, that *Apus* is perhaps the most perfect "missing link" which zoology so far possesses, perfect, not only because its morphology is easily deducible from that of a carnivorous Annelid, but also because the mechanical causes of the transformation are apparent. The Apodidæ will in fact be found to afford us the first complete illustration of the rise of one large animal class out of another by the simple and natural adaptation on the part of one single species of the latter to a new manner of life. Close investigation shows the Apodidæ to be both morphologically and biologically an almost ideal transition form.

More or less satisfactory transition forms between most of the great animal classes are now known, but none has till now been discovered between the Annelida and the Crustacea. The object of this book is to satisfy this want, not by the discovery of a new animal, but by a new explanation of one long known and often described.

The established transition forms between the other classes of the animal kingdom still leave much to be desired. Between the Protozoa and Metazoa the transition forms are either claimed by botanists, or else, however probable, are somewhat hypothetical.

Between the Cœlenterata and the Platodes we have rival links. When reading the arguments in favour of the claims of those specialised Ctenophora, the Cœloplana and Ctenoplana, we feel convinced; but, on the other hand, when we study for ourselves under the microscope such a simple Rhabdocœle as *Microstomum lineare*, especially during its changes of shape when moving about under a cover glass, our former conviction fades away, and we see in it a specialised larval form of a Cœlenterate. Between the Platodes and the Annelids the gap seems small, but we cannot bridge it over until we decide whether the segmentation of the Annelids is a kind of axial strobilation, or the natural mechanical selection of internal symmetry. Between the Annelids and the Molluscs we have the claims of *Solenogaster* to attend to; but this animal is unfortunately so rare, that it will be long before we can hope to have any very thorough knowledge of its morphology. Between the Annelids and the Tracheata we have *Peripatus*; this highly interesting animal, has a special claim on our attention, as the Tracheata form with the Crustacea the great class known as the Arthropoda. We shall find that our explanation of the rise of the Crustacea supplies us also with a very probable clue as to the origin of the Tracheata. The Echinodermata and the Tunicata hover almost entirely in the air. And, lastly, we have the giant trunk of the Vertebrata, the roots of which are being eagerly sought in different directions. The claims of *Amphioxus* and of the Ascidian larva are confidently put forward by the

majority of our leading zoologists, but there are difficulties not yet explained which make many restless, and lead them to search in other directions.

In this state of affairs it will be a clear gain and encouragement if we can connect the Annelida and the Crustacea in the way described in these pages, in which we show how a typical carnivorous Annelid (presumably a Nereid, though probably not so specialised as any modern member of that family) can, by a simple and natural adaptation to a new manner of life, be established as the ground type of Apus. We mean a great deal by this expression "ground type," much more than any mere general resemblance of organisation; we mean that every single organ of Apus, where it does not resemble that of its Annelid ancestor, is capable of being deduced from some organ in the latter, and, further, that the causes of the transformation are not far to seek. These are large claims; the following pages will show whether they are justifiable.

Before entering into the morphological and anatomical details upon which our deduction of the Apodidæ from a carnivorous Annelid is based, it will make the task of the reader lighter if we here set out the line of argument.

Many carnivorous Annelids have, as is well known, a protrusible pharynx, armed with teeth, which is shot out for the seizing of prey. We assume that the Annelid from which Apus is derived, adopted a habit of browsing, which rendered this protrusible



pharynx unnecessary, so that it degenerated. The Annelids afford us such a wonderful variety of forms adapted to almost every possible manner of life, that this assumption presents no difficulty. Cambrian and Silurian formations have revealed to the palæontologist abundant evidence that early Chætopods crawled about along the bottom of the seas of those times. That one of these should become specialised for feeding in the manner supposed, is not too much to ask.

The use of the pharynx just described is, as far as we can see, a clumsy method of obtaining food. The loss of it, and the adoption of a browsing method of feeding, might well be a gain. The further development of this habit would lead to a bending round of the head sufficient to enable the animal to use its anterior parapodia for pushing prey into its mouth. In time the bend of the head would become fixed, and the parapodia modified as jaws and maxillæ. The parapodia of at least a certain number of anterior trunk segments would certainly also serve to rake food together into the middle line and forward it towards the mouth. From this very simple and natural modification of a Chætopodan Annelid, we believe that all the Crustacea, living or extinct, can be deduced. To establish this, is the object of this little book, which we have called "The Apodidæ," since it was during our study of these Phyllopods that we first caught sight of the Annelid, so effectually disguised under its Crustacean dress. Although this disguise is so complete as to have eluded all former research, yet when once under-

stood, it is found to be very superficial. We shall be able to show, in the following pages, that the Apodidæ agree in almost every detail of their organisation with such an Annelid, and that any disagreement is chiefly due to further specialisation in adaptation to the new manner of life described.

Commencing with the head, we shall show how the morphology of the typical Crustacean head is easily explained by the bending round of the five anterior segments of such an Annelid for the purpose of browsing.

The trunk of *Apus* will be shown to be a true link between the many-segmented Annelids, and the Crustacea with their small and almost constant number of segments. The rise of the shield will be briefly mentioned, a fuller account of it being reserved till we compare *Apus* with the Trilobites.

The gradual transformation of the Annelidan cuticle into the exoskeleton of the Crustacea, to which many of the changes in the inner organisation of the latter are to be referred, will be found well illustrated by the Apodidæ.

The Annelidan parapodia (with their dorsal and ventral branches) will be shown to be capable of developing every form of Crustacean limb, the reasons for the suppression of one part and the development of another being generally fairly evident, *Apus* again supplying the clue.

Coming to the inner organisation, we shall take in turn, the musculature, the nervous system, the sensory organs, the alimentary canal, the circulatory system,

the excretory and other glands, and, lastly, the reproductive organs. We shall either point out the resemblances in each case between these organs and those of our Annelid, or else show how they can be deduced from Annelidan organs. It will be found that while some of the modifications of Annelidan into Crustacean organs are easy to follow, the explanation of others has to be sought, and may thus appear to be, in some cases, far-fetched.

And here we must remind our readers that it is enough for our argument if we can show that such a deduction is *possible*. It is not essential to our theory that we should show exactly *how* the inner transformations actually took place. Our explanations may themselves be incorrect, but the validity of our argument can only be seriously weakened by showing that a set of organs in Apus could not possibly have been derived from any organs in the Annelida ; or that the improbability of such a transformation is so great that no experienced morphologist would accept it.

We shall conclude the first part of this essay by an appeal to the Nauplius, to see whether it bears out our theory that Apus is the original form of the majority of the modern Crustacea ; or, in other words, whether Apus can itself claim to be the proto-Nauplius of zoologists. We shall endeavour to describe the exact morphology of the Nauplius considered as the Apus larva or the Apus-stage in the development of the other Crustacea.

This will conclude Part I., which we hope will have shown that, so far as such claims can be based purely

upon morphological, anatomical, and biological reasoning, the Apodidæ deserve to take the place we assign them as an almost ideal transition form between the Annelida and the Crustacea. Here, as stated in the Preface, we thought to leave the matter as an interesting suggestion. Fortunately, however, we have the means of testing the accuracy of our conclusions..

Admitting, on the one hand, that the confirmatory evidence as to the truth of our theory given by the Nauplius need by no means be conclusive, we maintain, on the other hand, that the answer which we receive to our appeal to palæontology and to such archaic living forms as *Limulus* must be decisive. Thus we enter upon the second part of our essay in order to obtain a final "yea" or "nay" as to whether our theory is, as a whole, but a morphological *tour de force*, or a fairly close guess at the truth.

We commence with *Limulus*, and show that if *Apus* is to be derived from an Annelid with the first five segments bent round ventrally, *Limulus* must have had a similar origin.

In the second section we venture into the dangerous realm of the Trilobites. The mystery which surrounds these primitive Crustacea is so great, that every announcement of a new discovery bearing upon their morphology meets with more or less scepticism. Nevertheless, we believe that we can prove that our derivation of *Apus* from a bent Annelid reveals the Trilobites also in their true light, as so many attempts of browsing Crustacean-Annelids to adapt themselves to their surroundings—attempts which, in the long

run, proved unsuccessful, for reasons which we shall try to point out.

After briefly discussing the Eurypteridæ, we shall give an outline sketch of a new classification of the Crustacea based upon our theory, showing that while only one group of modern Crustacea admits of derivation from the Trilobites, all the rest, except *Limulus*, can be deduced from the Apodidæ. We shall see reasons for believing that it was the development of the shield, either as bivalve shell, or as a large fold of the tergum of the fifth segment, which led to success in the struggle for existence.

We should here say something as to the preservation of the Apodidæ through so many geological ages. This is explained by the manner of life of the animals. They usually appear in ditches and pools dependent on the rainfall. In such waters they naturally come little into competition with other animals. The dry seasons are bridged over by the eggs being preserved in the mud. In this strange but perfectly natural way, *Apus* has, from the earliest times, been so completely isolated that its preservation presents no difficulty. Its presence in every part of the globe, with almost always the same manner of life, is a sign of its great antiquity.

The fact that no true fossil Apodidæ are found, among the rich yield of Crustacean remains of the Silurian strata, admits of simple explanation. We say no *true* Apodidæ, for we shall find that such forms as *Hymenocaris* and *Ceratiocaris*, though perhaps somewhat more specialised, were probably very closely

---

related to the Apodidæ. Both these points will be discussed more in detail in Part II.

Finally, in a short concluding section we shall show that the method of differentiation which turned the Annelid into the Crustacean throws a flood of light on the origin of the Tracheata, and on some of the morphological differences which separate these two divisions of the Arthropoda.

Several new points in the anatomy of *Apus* will be described and illustrated. Where these do not bear directly upon the subject, they will be given in full in an appendix, so as not to interfere with the course of the argument.

## SECTION II

### THE OUTER BODY FORM

#### THE HEAD

THE comparative anatomy of the Crustacea has long ago established the fact that the Crustacean head must originally have been composed of five fused segments of an annulate body. Our derivation of *Apus* from a browsing Annelid explains the method of this fusion, that it did not take place along the longitudinal axis of the body, but by a doubling of this number of segments upon themselves. This term "doubling" or "doublature" has already been applied to the under sides of the forehead of such animals as *Apus*, *Limulus*, and the Trilobites, but apparently meaning nothing more than the doubling of the forehead, which has both a dorsal and a ventral surface. In reality, however, this "doubling" is the true description of the Crustacean head as shown in Figs. 1 and 2; these should be further compared with Fig. 46, p. 212, which represents a longitudinal section of a Trilobite, where the doubling is very clear.

Owing to the bending on itself of the cylindrical Annelidan body, the original head must have been anteriorly almost completely hemispherical (Figs. 1 and 46). This form of the original Crustaccan-Annelid head

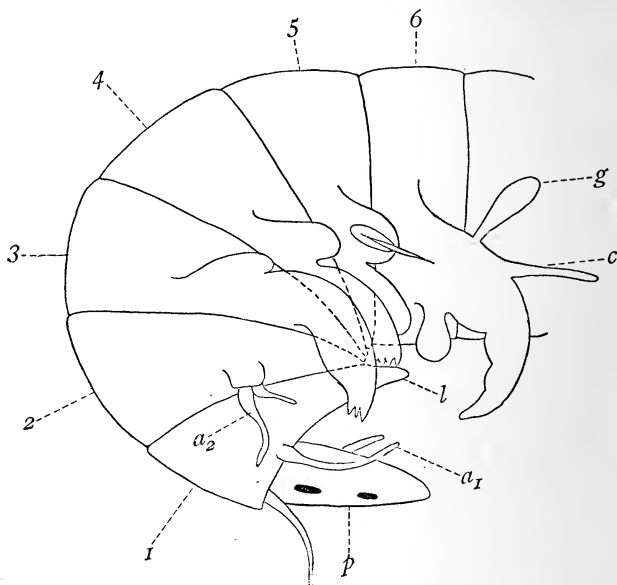

FIG. 1.—Diagram showing the first six segments of a carnivorous Annelid; the first five being bent round; *p*, the prostomium with two pairs of eyes and a median cirrus. *1*, the 1st segment carrying a pair of antennæ, its under edge projecting backwards as the lower lip (*l*). *2*, the 2nd segment with a pair of antennal parapodia. *3*, the 3rd segment with rudimentary dorsal parapodia, the ventral parapodia developing into mandibles. *4*, the 4th segment with a pair of maxillæ, the dorsal parapodium slightly less degenerated. *5*, the 5th and last head segment, the dorsal parapodium with large aciculum and gland. *6*, the 6th segment (1st free segment) with large dorsal parapodium carrying gill (*g*) and sensory cirrus (*c*).

was, however, very clearly modified. In most Trilobites traces of it are still visible in the glabella (Fig. 47, p. 213). In *Apus*, the disguise is very complete, the whole head



being broad and flat. This form is due to a ridge running round the anterior surface as prolongation of the lateral edges of the shell fold. This ridge is of considerable interest, as it appears in almost every Trilobite. We shall later find reason to believe that it was a

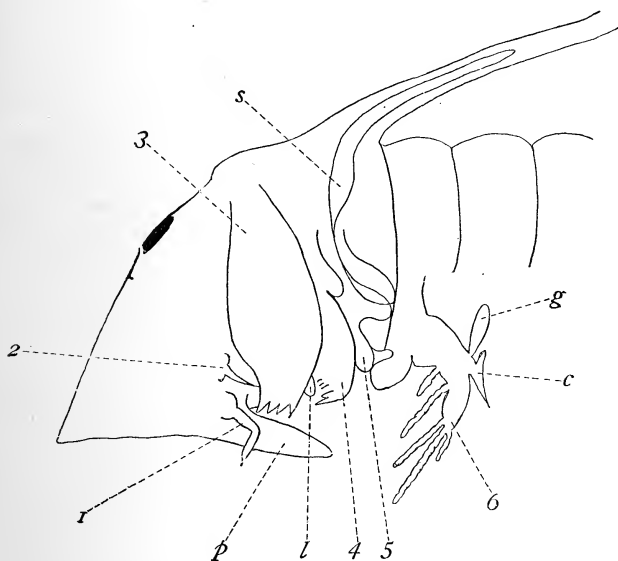

FIG. 2.—Diagram of head and first trunk segment of *Apus*, for comparison with Fig. 1—the lettering the same. In addition: *s*, shell gland (the acicular gland of Fig. 1 drawn into the shell fold). The distances between the limbs are much exaggerated in order to show their forms more clearly.

primary differentiation of the new “head,” *i.e.* the new Crustacean head, composed of five Annelidan segments. Its origin and modifications will be discussed in another place. This form of head is no doubt useful for swimming and perhaps for burrowing in the mud.

Excepting in the number of limbs, all external traces of its having been composed of five segments are obliterated. Internally, however, there are abundant indications of its origin from the bending of the Annelidan segments.

The mouth lies ventrally and faces posteriorly, a fact which, taken in connection with the sharp bend in the œsophagus, to be described later, is enough of itself to suggest the original doubling of the segments. This ventral position of the mouth is an important characteristic of the whole class of the Crustacea, which has not received the attention it deserves.

Projecting ventrally and posteriorly over the mouth is a large upper lip, corresponding with the prostomium of the Annelid ancestor. This upper lip is thus a primitive feature among the Crustacea; it occurs in a more or less pronounced form in most Nauplii, and persisted as a very highly developed organ in the Trilobites, but in the modern Crustacea it is generally more or less rudimentary.

The under edge of the Annelidan mouth would also naturally project backwards as a sharp fold (see Fig. 1, *D*). Such a fold in *Apus*, however, would form an obstacle to the pushing of food forward towards and into the mouth by means of the maxillæ and ventral parapodia of the anterior trunk segments; hence we find it modified into two lateral projections, the middle part of the fold being merely indicated by a low ridge, which is not sufficient to form a barrier across the ventral surface. These two projections have been handed on to the higher Crustacea as the paragnatha.

In the larva of *Euphausia* they develop early as two limb-like projections posterior to the mandibles, and strongly resemble those of *Apus*.

In *Apus*, only the mandibles work between the labrum on the one hand and the under lip on the other. In *Limulus*, however, where the under lip also consists of two projections, the mouth is so stretched in the longitudinal direction that the masticatory ridges of *five* pairs of limbs work as jaws between them and the labrum. That these labial projections in *Apus* and *Limulus* are really homologous with one another, and with the under lip of our original Annelid, will be seen to follow as a necessary consequence of our explanation of their morphology.<sup>1</sup>

The shield is of great size, and stretches back (as a fold of the fifth segment) over the greater part of the body. Laterally it covers and protects the limbs. Posteriorly, it is armed with thorns, and has a keel along the dorsal middle line due no doubt to the central thorn which it supports. The carrying of these thorns, which are now so slightly developed, may have originally been the chief function of the shield in its early stages; Fig. 48, page 215, in connection with which the origin of the shield will be discussed more in detail, illustrates what we imagine to have been the first step in the formation of the dorsal shield. This function has, however, long given place to that of protective covering of the whole dorsal surface and (laterally) of the gills. The lateral edges of the shield are prolonged into the ridge which, run-

<sup>1</sup> Cf. pp. 39, 40, and 194, also Fig. 43, p. 188.

ning round the front of the head, makes the latter broad and flat, obliterates all external marks of segmentation, and effectually disguises its origin out of five Annelidan segments.

The coils of the shell glands form one of the most notable marks of the shield (see Frontispiece). Their origin, position, and structure will be discussed in the section on the excretory and other glands.

#### THE BODY PROPER.

On removing the shield we find a long vermiform annulate body, Fig. 3. In the anterior part of the trunk region the rings correspond in number with the limbs or parapodia; as we approach the posterior region, however, the limbs are much more numerous than the rings. We find two, three, four, or as many as six rudimentary limbs on one ring. The last five rings have no limbs at all. This whole phenomenon, which has hitherto puzzled morphologists, may be explained as follows.

The great length of the original Annelid being of no use to the Crustaccan-Annelid, the hinder part of the body remains in the latter at an undeveloped or larval stage. The rule in the development of Annelid larvæ is that the successive segments form in front of the anal segment, and differentiate from before backward, those furthest from the anal segment being the most developed. In *Apus*, we find in front of the anal segment

five segments with no limbs developed, with no ventral ganglia, and with no organs except the most necessary, viz., the intestinal tube and the musculature. Then follows a row of rudimentary segments, each with a minute pair of limbs and a pair of ganglia, which increase in size and development from behind forward. The rudimentary segments which have become fixed in the adult *Apus* do

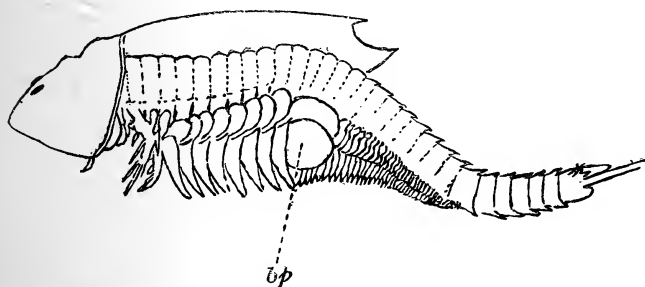

FIG. 3.—*Lepidurus Spitzbergensis*, from nature. The left half of the shield removed to show the vermiform body. The first 14 trunk segments carry a pair of limbs each, the following 10 "rings" carry between them *ca.* 28 rudimentary limbs, and therefore correspond to 28 segments. The last 5 trunk segments (excluding the anal segment) are limbless. *bp*, brood pouch formed by the 11th pair of trunk limbs.

not correspond with the rings of the body; only gradually as they recede from the limbless segments, and thus are more fully developed, do the segments correspond with the rings. The fusing of several rudimentary segments to form one body ring, *i.e.* a muscular segment, presents no difficulty. The Myriapoda afford us several examples of the fusing of true segments to form body rings.

The study of the development of *Apus* has shown

that it grows directly out of the Nauplius by the gradual differentiation of new segments in front of the anal segment, with no metamorphosis worth mentioning. This fact has led to its being compared with an overgrown Nauplius. According to our view, indeed, the Nauplius is only the young Apus, or Apus-stage in other Crustaceans. This steady development of Apus from its larva, as an Annelid develops from the Trochophora, falls in with our explanation of its morphology. Apus, however, differs from its Annelid ancestors in that it reaches its adult shape before its inherited number of segments are fully developed. This fixation of the hinder part of the body at a larval stage can be easily accounted for by the process of natural selection, compactness being a decided advantage to an active free-swimming animal.

The great number of segments, developed and rudimentary, in the Apodidæ is a matter of considerable importance in estimating their true position. In all the other specialised Crustacean groups the number of segments is constant, *i.e.* constant for each group. In deriving such animals with a small but constant number of segments from Annelids with a large and varying number of segments, the ideal transition form would be an animal with a medium number of segments, which is not quite constant and is visibly diminishing. Both these points are specially clear in the Apodidæ. We find that all descriptions of *Apus cancriformis* give a varying number of limbs, which can hardly be due merely to the difficulty of counting them, but more

probably to the fact that the number of rudimentary limbs actually does vary. And even if it should be proved that the same species always possesses the same number of segments developed and rudimentary, the different species of *Apus* and *Lepidurus* are marked by decided differences in the number of segments. Whereas the more specialised Crustacea (the Malacostraca) have either the constant number of twenty or twenty-one segments, the number in the Apodidæ varies between thirty-five and sixty-five. In the Entomostraca the number varies, but never reaches even the lowest number in the Apodidæ. That the number in the Apodidæ is visibly decreasing follows from our explanation of their morphology. The fact that the posterior segments remain fixed, in a larval and undeveloped condition, shows that they are gradually being dispensed with. On this ground alone, then, the Apodidæ deserve to occupy the place, half way between the Annelids and the Crustacea, which we claim for them.

Many of the segments, as already seen, are so rudimentary as to be useless, *i.e.* as movable segments, so that three, four, or even six combine to form one body ring. In the Trilobites we shall find that the posterior rudimentary segments, which were for the same reason immovable upon one another, form together, in many genera at least, a solid tail plate, the pygidium (*cf.* Fig. 49, p. 220).

It is a characteristic of the Crustacea that no limbs develop on the anal segment. In the Apodidæ, this segment is already fully developed; they are the

segments anterior to it which are rudimentary, and which disappear in the development of the higher Crustacea.

The anal segment is provided with two long cercopoda or cirri, projecting posteriorly and slightly ventrally, and two rudiments, probably of similar appendages, on the posterior dorsal surface of the segment. These four together correspond with the four anal cirri found in some carnivorous Annelids (*cf.* pp. 85 and 274). The two cirri are stiffened for the greater part of their length by a thickened cuticle covered with setæ, and showing slight rings of thinner skin. The tips of the cirri are quite thin-skinned, and seem to function as tactile papillæ.

The posterior dorsal surface of the anal segment is sometimes prolonged into a variously shaped caudal plate or lamella,<sup>1</sup> which we shall find to be the homologue of the caudal spine of the Xiphosuridæ.

#### THE CUTICLE AND EXOSKELETON.

The generally thin and flexible Annelidan cuticle of the Apodidæ shows local thickenings which may well be recognised as the commencement of the Crustacean exoskeleton. A closer study of these reveals to us the principles of the original formation

<sup>1</sup> Apodidæ having this characteristic have been classed by Leach as a separate genus, *Lepidurus*. But Dr. Alfred Walter, to whose memory this essay is dedicated, discovered a form in a desert well in Transcaspian Russia, *Apus Hackelii* (Walter), which makes it doubtful whether this division can be sustained. (*Bulletin de la Société Impériale des Naturalistes de Moscou*, 1887.)



of such an exoskeleton. Perhaps the best way to make the subject clear is to discuss and illustrate these principles.

(1) First and chiefly, the cuticle is thickened for the protection of exposed parts. We find the cuticle of the dorsal surface of the head, which, on the bending round of the anterior segments, was left entirely unprotected, and of the upper surface of the shield, considerably thickened; also that of the exposed segments, *i.e.* of those segments which are not covered by the dorsal shield. Underneath the shield, on the contrary, the skin of the body is very thin and flexible, though towards the posterior edge of the shield it begins to thicken. We find the same principle in *Limulus* and the Trilobites, where, under the protection of the thick shield, the cuticle of the ventral and lateral parts remained soft and flexible.

We also find certain parts of the body thickened for protection against other parts. Thus the outer edges of the under lips are thickened for protection against the working of the powerful jaws and of the first maxillæ, between which two pairs of limbs they are placed.

(2) We find local thickenings to counteract the pulls of the muscles, and this in two ways. (*a.*) There are thickened areas such as the ventral and lateral parts of the mandibles, to resist the almost rectangular pulls of the mandibular muscles. In the higher Crustacea such thickenings of the cuticle go hand in hand with the concentration and physiological perfection of the muscle bands, which, instead of being attached

to large irregular areas of a soft cuticle, as in the Annelids and in the trunk segments of *Apus*, are attached to definite firm points. (b.) There are thickened strips to resist the longitudinal pulls of muscles, as along the shafts of the limbs, where, but for such

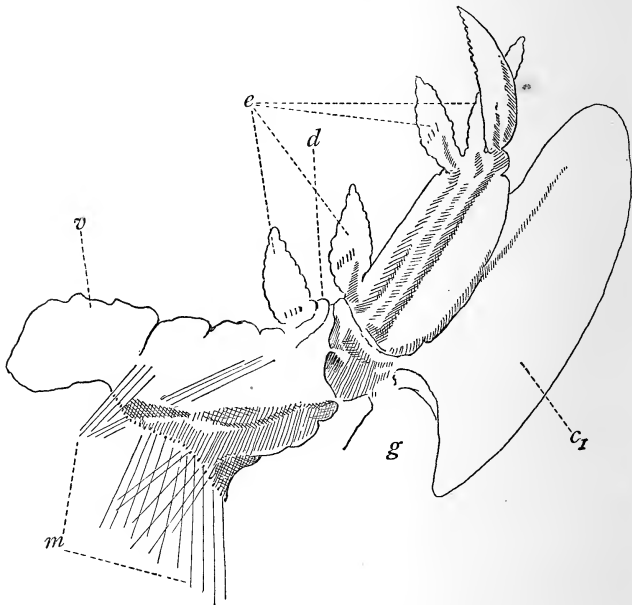

FIG. 4.—Anterior (concave) aspect of a trunk limb of a large specimen of *Apus cancriformis*. The shading shows the commencement of the thickening of the cuticle, the white parts being thin and transparent. The musculature at the base of the limb is slightly indicated. Lettering the same as in Fig. 6, p. 32.

bands, the cuticle of the limb would be drawn into folds (Fig. 4).

(3) There are thickenings for the formation of claws and teeth at the tips or edges of limbs, and of thorns

on exposed angles, edges, or surfaces, as, for instance, round the posterior segments (see frontispiece).

(4) There are thickenings for the formation of rudimentary articulations, especially of the limbs upon the body and of the joints of the limbs on each other. Figs. 4 and 5 give two views of one and the same leg of a large specimen of *Apus cancriformis*. In these

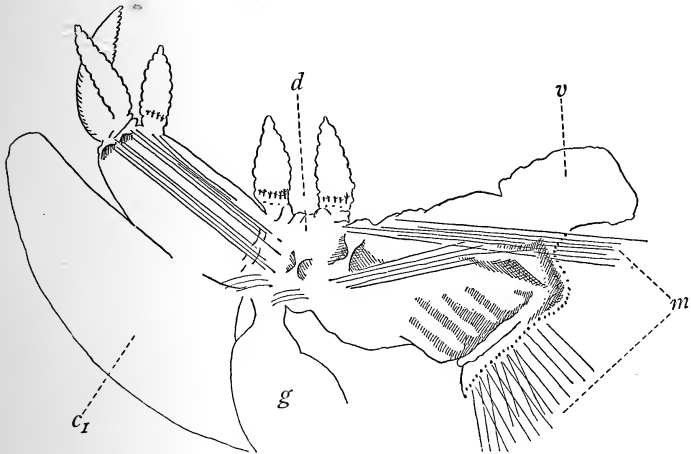

FIG. 5.—Posterior (convex) aspect of the same leg, the skin being nearly all thin and semi-transparent, but showing rudimentary hinges. A few muscles are indicated. Lettering the same as in Fig. 6. On the endites are seen the denticulate setæ referred to on p. 46.

the thickenings forming rudimentary hinges are very instructive, the rest of the cuticle of the leg, with the exception of the thickened strips and areas for the counteraction and attachment of muscles, being thin and flexible. It would be an interesting mechanical problem to try to discover why the bent concave side

of the limb should develop most strongly the exoskeleton, and the convex side the hinges.

We thus find in *Apus* the Annelidan cuticle changing into the exoskeleton of the Crustacea ; the principles of the change being for the most part easily deciphered.

The importance of this gradual thickening of the cuticle for the whole organisation can hardly be over-estimated. As one of the special characteristics of the Crustacea, useful at all stages, it is naturally very early developed, the youngest larva having a cuticle too thick to allow of gradual regular growth. This leads to the habit of moulting, which was doubtless very gradually acquired. The earliest thickenings probably peeled off separately in flakes, as the areas which they covered increased in size. Such half-loosened flakes in all parts of the body would, however, materially hinder the animal in the struggle for existence, and natural selection would soon bring about a shortening of the process, those animals being most successful who were, during life, least encumbered by loosening flakes, *i.e.* who threw them off altogether.

But still more important consequences of the stiff cuticle are to be traced in the *inner* organisation. Some of the greatest differences between the anatomy of *Apus* and that of an Annelid can be traced directly to its development.

The hairs with which the cuticle is covered will be described in the section on the sensory organs.

We thus find in their outer organisation that the

Apodidæ are but slightly modified Annelids, the widening of the head being due simply to a fold of the skin ; and the cuticle being for the most part thin like that of the Annelids, showing, however, localised thickenings in which we can recognise the commencement of the Crustacean exoskeleton.

The hinder part of the body—the trunk—has long been recognised as worm-like, but we here see that the front or head part is also essentially Annelidan, especially in its possession of a prostomium or upper lip. The head of *Apus* differs from that of our Annelid only in the development of the shield and of the ridge-like fold which gives the head its great breadth.

The Annelid character of the Apodidæ, thus visible in the form of the body (*i.e.* of both head and trunk), will be even more clearly seen when we come to consider the appendages.

## SECTION III

### THE APPENDAGES

THE appendages of the Apodidæ have been much discussed, and many attempts have been made to homologise them with the limbs of other Crustacea. From our point of view, we must look to the parapodia of our bent Annelid for the true understanding of these limbs. It is, indeed, generally acknowledged that the Crustacean limb arose from the Annelidan parapodium. But the way this took place has not been worked out. The limbs of *Apus*, however, supply us with a clue. From these Phyllopodan limbs we can work both backwards to the Annelidan parapodium and forwards to the typical Crustacean biramose limb.

Continuing the detailed comparison of *Apus* with a bent Annelid, already begun in the first section, we have now to show that it is possible to deduce the limbs of the former from the parapodia of the latter, and that the modifications which transformed the one

into the other are due to adaptation to the browsing manner of life.

Our deduction of *Apus* from an adult carnivorous Annelid, which gradually adopted the habit of bending round its head, and of using its parapodia for capturing its prey and pushing it into its mouth, gives us at once the general direction along which we should expect modification to take place. First of all we should expect the parapodia along the whole length of the body to be bent round towards the ventral middle line. Further, the dorsal and ventral branches of these parapodia would be somewhat differently developed in adaptation to the various needs of the new manner of life. The ventral parapodia on the three posterior head segments would be differentiated into jaws and maxillæ, while on the anterior trunk segments they would serve to rake food into the middle line and forward it towards the mouth. The uses to which the dorsal parapodia could be put are not so apparent. Since, however, the habit of browsing necessitates a certain amount of locomotion, we may safely conclude that they would be utilised for this purpose. The original Annelid in its Annelidan days no doubt moved in the typical manner of Annelids by the alternate extension and contraction of the body. As, however, the body of our Crustacean Annelid shortened and began to develop an exoskeleton, some other method of locomotion would become necessary. The dorsal parapodia would thus naturally be brought into requisition. The same efforts which brought the ventral parapodia round

towards the ventral middle line might be expected to bring the dorsal parapodia as well, at least far enough round to allow them to assist in locomotion. There is, further, no need to limit the functions of the dorsal parapodia simply to locomotion,—they may at the same time assist in capturing food. Starting from the assumption that it was the habit of browsing which first led to the transformation of the Annelid into the Crustacean, the above is, in outline, the way in which we should expect the Annelidan parapodia to be gradually developed into Crustacean limbs.

It is not possible in this place to bring forward at once all the arguments which, we think, show that this sketch of the rise of the Crustacean limbs out of Annelidan parapodia is a fairly correct account of what actually took place. One reason is, however, here in place while discussing the limbs as a whole. It is only in such primitive Crustacean forms as the Apodidæ and the Trilobites that we find the ventral parapodia retained and functioning as jaws along the greater part of the body, as we assumed for our original Crustacean-Annelid ; the dorsal parapodia of the same segments functioning, in the Trilobites, purely as locomotory organs, in Apus both for locomotion and for capturing food. In the higher Crustacea we find a pronounced division of labour, viz., the perfection of the ventral parapodia round the mouth for mastication, and of the dorsal parapodia in the rest of the body, either anteriorly for seizing food, like the chelate limbs of the Decapoda, or posteriorly for locomotion, like the ambulatory legs



and swimmerets of the same animals, the ventral parapodia on these limbs disappearing entirely.

We shall further find that this division of labour in the modern Crustacea was not discovered by Nature all at once. Many different combinations of the ventral parapodia as jaws, with dorsal parapodia as auxiliary appendages, held their own for long periods. In the long run, however, the typical Crustacean formula for mandibles and maxillæ has, except in *Limulus* and in the Ostracods, which have different masticatory formulæ, alone survived. These efforts of Nature to select the best arrangement of ventral and dorsal parapodia for the transformation of a carnivorous Annelid into an armoured Crustacean will be found tabulated in Part II. p. 250.

Before describing the limbs of *Apus* in detail, we must call attention to several important points, which tend to support their claim to have originated from Annelidan parapodia in the way described.

(1) The limbs of *Apus* are little more than highly developed integumental folds with only rudiments of articulations, either between the different joints of the shaft and its appendages, or between the shaft and the body (Figs. 4 and 5). This absence of developed articulations has already been pointed out by Lankester and others, but its true significance does not seem to have been noticed. It is true that in many small thin-skinned typical Crustaceans the articulations seem to be slightly developed, but in these the whole exoskeleton has been reduced; this does not affect the significance

of their absence in *Apus*, where we find many thickenings of the cuticle which we regard as an exoskeleton—not in the act of disappearing—but in that of appearing for the first time.

The fact that the limbs are little more than folds of the integument, like Annelidan parapodia, is fully borne out by the examination of their musculature, which will be described in detail later. (Sect. IV.)

(2) The course of a line traced through the bases of the limbs of *Apus* agrees well with that of a similar line drawn through the parapodia of our imaginary bent Crustacean-Annelid. Commencing at the anterior antennæ (see Figs. 1 and 2) at the side of the prostomium or upper lip, this line passes in both cases vertically upwards and (for reasons to be given later, see p. 212) slightly outwards; passing through the 2nd antennæ, it bends round to run backwards, trending, however, gradually towards the ventral surface. The close agreement between the courses of these two lines is, morphologically, a fact of great significance. The more ventral trend of the line in the posterior end of *Apus* was to be expected as a necessary adaptation to the Crustacean manner of life, *i.e.*, to the use of the appendages as limbs whose functions were primitively all directed towards the middle line. The position of the antennæ is especially interesting. In the Annelid, these antennæ were originally metastomial, but have become prostomial by the bending of the segments on one another. The assumption of the rise of the Crustacean head from

five bent segments thus offers a clear solution of the difficult morphological problem involved in the prostomial position of these appendages.

(3) As to the great number of the limbs, reminding us of the row of parapodia on each side of the Polychætan Annelids, we need only refer to what was said in the previous section as to the great number of the segments (pp. 16-18).

(4) The marked difference between the head- and the trunk-limbs will be presently discussed in detail, and the differences shown to be exactly what our theory demands. In the meantime we find a gradual change in the trunk limbs as we go from front to back. Though the Phyllopodan type is preserved throughout, the anterior limbs (except the first, which is specialised) are highly developed seizing limbs, the posterior are simplified as rowing plates. There can be no doubt that the more rudimentary limbs, though necessarily repeating the type of those previously developed in front of them, partake more of the character of an integumental fold, like an Annelidan parapodium, than do the anterior limbs with their developed shafts, claws, &c. (*cf.* Figs. 4, 5, and 10).

(5) On placing a typical Phyllopodan limb by the side of a typical Annelidan parapodium, the homologies of some of the parts are very clear. As, however, the establishment of the homologies in detail is not so easy, we shall, in this place, have to content ourselves with merely stating our conclusions. The reasons which led to these conclusions, apart from

those already given in the foregoing pages, will be gradually gathered as we proceed, for we shall find it necessary to return to the subject again and again in the course of the following discussion.

A comparison of a limb of *Apus* with an Annelidan parapodium such as is shown in Fig. 6 *A*,<sup>1</sup> is sufficient to enable us to homologue the shaft and its

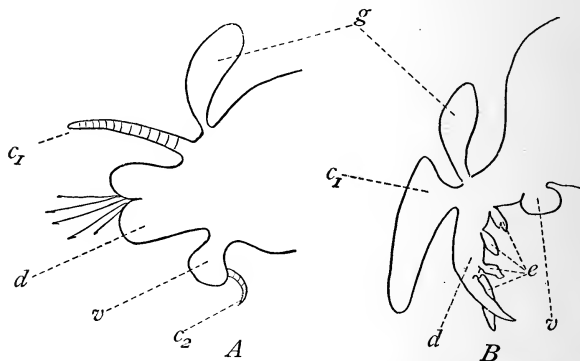

FIG. 6.—Diagram to compare an Annelid parapodium (*A*)<sup>1</sup> with a limb of *Apus* (*B*). *g*, gill; *c*<sub>1</sub>, sensory cirrus of the dorsal parapodium; *c*<sub>2</sub>, ditto of the ventral parapodium; *v*, ventral parapodium; *e*, sensory endites. In all the figures the same letters are used for the homologous parts.

appendages with the dorsal parapodium, the claw being the true tip.

The gnathobase is the ventral parapodium. The position of the gill is the same in both, and the flabellum of *Apus* is clearly homologous with the

<sup>1</sup> Figure *A* agrees fairly well with that given by Ehlers as the parapodium of a young *Nereis*; we have added the gill, and the sensory cirrus of the ventral parapodium. See Taf. xxi. 3 in "Die Borstenwürmer," Leipzig, 1864-68.

sensory cirrus of the dorsal parapodium of the Annelids.

The sensory cirrus of the ventral parapodium ( $c_2$ ) entirely disappears in *Apus*, but is retained in *Limulus* (see Fig. 44, p. 192). Both the dorsal and ventral parapodia in *Apus* carry highly developed setæ, as in the Polychæta, and again, in both, the gill is entirely free from setæ, which would hinder the free exchange of the respiratory medium. It may be noted that many Polychæta have appendages on their parapodia quite as complicated as those on the limbs of *Apus* known as the endites (*B. e.*), whose origin will be discussed later.

Passing from the Phyllopodan to the typical Crustacean limb, we assume that the flabellum is the exopodite, the shaft of the limb is the endopodite, and the ventral parapodium is the masticatory ridge.

I. *The first pair of Antennæ* (Fig. 7 A)—This limb has retained its original position at the side of the Annelidan prostomium or upper lip of the Apodidæ. It has already been pointed out that the bending of the head has changed its position from behind the mouth to in front of it.

The form of this limb needs no special comment ; the bend in it is not a true joint, nor is it provided with any muscles except a few which run into the bulb on which it stands. Its setæ are modified into sensory hairs, homologous with the olfactory hairs of the higher Crustacea.

Morphologically, the first antenna must be regarded

as the sensory cirrus of the parapodium of the first segment, the parapodium itself having disappeared, or possibly being represented by the bulb on which the antenna stands; this latter homology is, however, very doubtful. Though the parapodium itself has disappeared, the gland of its aciculum is probably still present, and functions as a salivary gland. Fig. 29 p. 114, shows the position and form of this gland. A comparison of this figure with Fig. 1 will make it

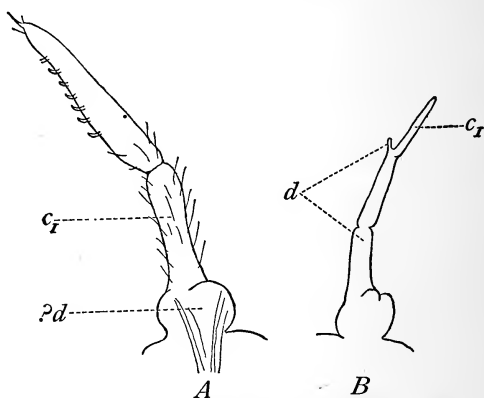

FIG. 7.—*A*. First antenna (*L. Spitzbergensis*) with hooked sensory hairs, homologous with the olfactory hairs of the higher Crustacea. *c*, the sensory cirrus; *d*, the bulb on which it stands, perhaps the remains of the dorsal parapodium on which it stood. *B*. Second antenna (*L. Spitzbergensis*) showing the rudiments of the endopodite, *i.e.* of the distal end of the dorsal parapodium which had been highly developed in the Nauplius, but is degenerated in the adult; *c*, the sensory cirrus.

clear that this gland can be so homologised;—the point will, however, be discussed in detail in connection with the description of the gland itself. From Fig. 1 it will be seen that the acicular gland of the (vanished) parapodium of the first segment could easily open within the mouth, on the under lip.

II. *The second pair of Antennæ* (Fig. 7 B)—The second antenna is so much reduced in the Apodidæ that its absence has often been considered characteristic of the family. In no specimen examined by us has it been wanting. Its position has already been described (p. 30) as agreeing exactly with that of the corresponding antennal parapodium of the Annelids. It has, like the first antenna, been brought in front of the mouth by the bending of the head. Although it is very much degenerated, it shows three divisions, with the slight rudiment of a branch at the end of the second, which is the only trace of its former relatively greater development as a branched swimming limb in the Nauplius. We deduce the limb from the antennal parapodium of the second segment of the Annelida (*cf.* Fig. 7 B with Figs. 1, 2). Its great reduction in the Apodidæ is no doubt due to its being caught, as it were, in the angle of the bend, and further shut in under the shield. In *Limulus*, owing to the greater space under the shield, it is freer to develop into a chelate foot (see Fig. 43, p. 188). In *Branchipus* also, in which the shield has disappeared, it undergoes no such reduction.

The second antenna, like the first, stands on a small bulb which may perhaps be homologous with that of the first antenna, but certainly in this case cannot represent the remains of the parapodium. According to our homologies for this limb (see Fig. 7 *b*) the dorsal parapodium is still present, and forms its proximal half, ending in the minute rudimentary branch shown in the figure. In sections of the basal bulb we found a deep indentation, which led us to

suspect the presence of a rudimentary antennal gland. No such gland, however, could be found, although the indentation may mark the spot where one formerly opened. Whether this indentation, which was very distinct in some specimens, really represents the remains of an opening of an antennal gland or not, we are still able to assume that such a gland, homologous with the acicular gland of the dorsal parapodium, once existed, and has reappeared in the higher Crustacea as the antennal gland. We have, in the Crustacean head three glands derived from three setiparous glands, viz. the gland of the first antenna (?) developed into a salivary gland (in *Apus*), the gland of the second antenna into the well-known antennal gland, and the gland of the second maxilla into the shell gland. The homologous setiparous glands of the mandibles and first maxillæ have quite disappeared, like the parapodia to which they belonged. To these points, however, we shall again refer.

We have given in the Figure (7 *B*) our explanation of the parts of the second antenna. The correctness of this explanation naturally depends on a right understanding of the same limb in the Nauplius. This matter will therefore be further discussed in the section dealing with the development of *Apus*. We may here anticipate our conclusion by saying that, in accordance with the homologies given on p. 32, and indicated in the lettering of Fig. 7 *B.*, the biramose limb of the Nauplius consists of the dorsal parapodium, the distal portion of which forms the endopodite, the sensory



cirrus forming the exopodite. As the larva grows, the endopodite gradually degenerates, leaving the sensory cirrus to form the distal end of the limb which is thus a sensory organ (compare also Figs. 34 and 35).

III. *The Mandibles.*—These are the first limbs which admit of undoubted comparison with parapodia. We find, however, that while the dorsal branch has entirely

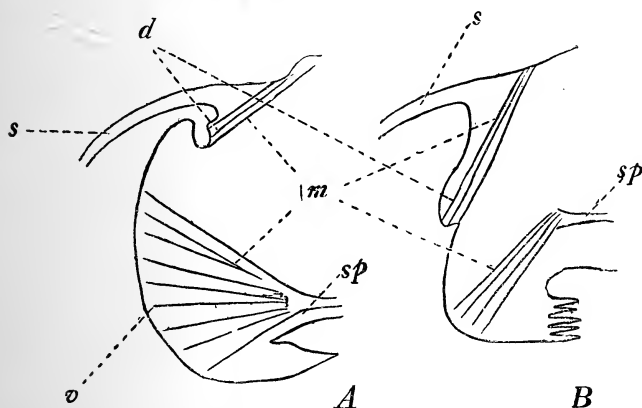

FIG. 8.—*A*, diagram of mandible; *s*, shell-fold. At *d* the dorsal parapodium has disappeared, but is indicated by the musculature. *v*, ventral parapodium forming the mandible itself, the musculature coming from the sternal plate (*sp*). *B*, diagram of 1st maxilla. At *d*, a larger rudiment of the dorsal parapodium is retained than in the mandible.

disappeared, the ventral has grown enormously in all directions to form the powerful masticatory limbs which are such a striking feature in the Apodidæ. That these mandibles are homologous with the gnathobases of the trunk limbs, and therefore, according to our view, with the ventral parapodia of the Annelida, may be seen at once by comparing their muscles with

those of the similar parts of other limbs (see Figs. 8 and 14, p. 59). Muscles also are found which are the remains of the muscles which once ran into the now completely degenerated dorsal parapodia (see section on Musculature, p. 52). The redevelopment in varying degrees of the dorsal parapodium in the mandibles of some of the higher Crustacea, to form the mandibular feelers, or palps (or perhaps feeler- or palp-carriers) is a matter of considerable interest.

We see in these large fleshy mandibles of *Apus* an undoubtedly primitive characteristic. They form a perfect morphological transition between a limb like the parapodium of the Annelida, and the hard specialised jaw of the Crustacea. The "teeth" are only hard protuberances of the cuticle. The setæ are very small and grouped in tufts round the teeth. This limb has no hinge on which it works; it probably moves round its upper dorsal end as axis.

The homologous limb in *Limulus*, *i.e.*, the third, is not so specialised as it is in *Apus*; its masticatory process is not more developed than that of the second antennæ, or of the two pairs of maxillæ, and of the first trunk limb. In *Apus*, only the mandibles work between the upper and lower lips, but in *Limulus* all the masticatory ridges of five pairs of limbs do so. In *Pterygotus* (see Fig. 55, p. 239), the third limb seems to have ceased to function as a jaw, and the powerful swimming limb, the sixth or (morphologically) the first trunk limb, has developed strong masticatory processes, which seem to function as the chief

mandibles.<sup>1</sup> It is difficult to see on what principle this occurs; the advantages gained by using the ventral parapodia of the most powerful limbs as jaws, would seem to be more than counterbalanced by the disadvantage of combining locomotory with masticatory functions; perhaps we might assume that in this case the dorsal and ventral parapodia became separately articulated with the body, so as to secure all the advantages of the division of labour. From what we know both of Crustacean and of Annelidan morphology, there is no difficulty in the assumption of the separate articulation with the body of two parts of the same limb or parapodium.

*The Under Lips.*—These, though not limbs, are best described here, as they have hitherto always been mistaken for limbs or parts of limbs. They owe their origin, as has already been described, to the change of position of the mouth, the under edge of which must naturally project backwards (as shown in Fig. 1, p. 12). This under lip, which was originally a straight ridge, has been cut out in the middle, in order not to form a barrier which would hinder the pushing of food into the mouth by the maxillæ. We thus find, instead of the pronounced ridge right across the posterior edge of the mouth, two limb-like projections, the inner edges of which gradually slope down towards the middle line, the remains of the ridge being easy to follow from side to side in a series of sagittal sections.

<sup>1</sup> The different attempts of the primitive Crustacea to find the best combination of limbs to function as jaws will be found in a table, p. 250.

It is clear that this division of the under lip must have been a very primitive feature in the Crustacean-Annelid. It was absolutely necessary if the ventral parapodia (posterior to the under lip) were to be used for pushing food forwards into the mouth, which habit led the way, according to our theory, in the differentiations which transformed the Annelid into the Crustacean. This early division of the under lip accounts for its appearance as two ventral projections in *Limulus*, where such a form can have no special significance. The mouth in *Limulus* is a long median slit, and instead of only the mandibles and two maxillæ being used as jaws, the ventral parapodia of the four posterior cephalic and the first trunk limb perform the masticatory functions.

We find a divided *upper* lip in some Trilobites (see Fig. 49, p. 220), which offers a curious parallel to the divided under lip of *Apus* and *Limulus*, but must naturally be due to other causes (see however note p. 241).

IV. *The First Maxilla*.—Unlike the mandibles, the first maxilla has retained a small rudiment of the dorsal parapodium in the form of a fold. That this is, in fact, the reduced dorsal branch is clear from a comparison of the musculature with that of the other limbs (see Fig. 8 B). In the higher Crustacea, this limb also may redevelop its dorsal branch as maxillary feeler. The maxillæ work behind the lower lip. The limb itself requires no special description, its form can be seen from the figure.

In *Limulus* the dorsal parapodium is well developed

in addition to the masticatory ridge or ventral parapodium. In the Eurypteridæ, the ventral masticatory part seems to have almost disappeared in *Pterygotus*, (see Fig. 55, p. 239) but to be well developed in *Eurypterus* (Fig. 56, p. 245).

V. *The Second Maxilla*.—This much-discussed limb has retained rather a larger rudiment of the dorsal parapodium than the first maxilla; in it, in fact, the dorsal is the more important of the two branches, the ventral being rendered almost useless by the powerful first maxilla, between which and the ventral parapodium of the first trunk limb it is squeezed (see Fig. 2 and Frontispiece). The dorsal parapodium is reduced to a stump without appendages, but is interesting on account of the aperture of the shell gland at its tip; we are thus able, as already mentioned, to homologise the shell gland with the setiparous sac of the original Annelidan parapodium (see section on Excretion, also Fig. 1, p. 12). The opening of the shell gland on this limb shows it to be the second maxilla, and not a maxillipede, as some authors maintain. An examination of the musculature shows further that this limb belongs to the fifth segment, a long thin muscle band descending into it from in front of the opening of the shield, which is a fold of the dorsal integument of this segment. This muscle band is doubtless homologous with the bands which, in each segment, run from the dorsal integument into its limb (see Figs. 14, p. 59, and 15, p. 60).

The five limbs just described are the typical five

pairs of limbs of the Crustacean head, so marked off for all time by the bending round of the five anterior segments of the original Annelid, and the growth of the shield. The three posterior limbs develop the ventral branches of the original Annelidan parapodia as masticatory apparatus round the mouth ; the dorsal branches are more or less completely degenerated, reappearing, when the antennæ adopt a frontal position, as palps, or palp-carriers. This arrangement of masticatory ridges may have had something to do with the preservation of the modern Crustacea, while the older groups with other, and probably less advantageous, combinations, such as those developed by the Trilobites, have died out.

We find here also the origin of the rule that, among the Crustacea, the dorsal parapodia are less developed on the mandibles than on the first maxillæ, and less on the first than on the second maxillæ. The typical Crustacean mandibular palp consists of the dorsal parapodium carrying its sensory cirrus, both apparently being sensory organs.

The limbs liable to most modification are, naturally, the first two, *i.e.* the two pairs of antennæ. In *Apus* we find the first pair retaining perhaps the original size, the second pair, however, degenerating. In *Limulus* both pairs are well developed as chelate seizing limbs, the second even redeveloping its ventral parapodium as a masticatory ridge. In the *Euryp-teridæ*, other characteristic changes will be noticed, and where possible will be traced to changes in their manner of life. We may here perhaps suggest the

rule, that the more the forehead is pressed against the ground, the antennæ pointing backwards, the more likely would the latter be to degenerate, as in *Apus*, and in the *Trilobites* (?), or by losing the sensory function to become modified as in *Limulus*. On the other hand, the more the animal adopted the swimming manner of life, the more the antennæ would tend to point forwards as sensory organs, and would then undergo further development as such. This we see in some *Eurypteridæ*, *Branchipus*, and *Nebalia*.

The *Apodidæ* thus furnish us with a complete explanation of the way in which the typical Crustacean head is composed of five fused Annelidan segments with their parapodia, and why the limbs of the head differ from those of the trunk throughout the whole class. The former (leaving out the antennæ) develop chiefly the ventral parapodia for mastication, the latter the dorsal for locomotion and for other functions which will be discussed in the following pages. In *Apus* we find a transition between the two, the last head segment having both dorsal and ventral parapodia about equally developed.

The important modifications, however, which the cephalic limbs may present, will be referred to again when discussing *Limulus*, the *Trilobites* and the *Eurypteridæ*, and are tabulated p. 250.

## THE LIMBS OF THE TRUNK.

Passing from the second maxillæ to the first trunk limb, we are struck by a sudden contrast, the former being much reduced, while the latter is highly developed, indeed the most highly developed limb of the whole body. This point is of more than ordinary interest, as we shall find that it throws considerable light on the homologies of the limbs in the Xiphosuridæ, the Eurypteridæ, and the Trilobites, in which animals, from what we learn from *Apus*, we are able to assume that the first large locomotory limbs must be homologous with the sixth pair, *i.e.* with the first trunk limbs. The explanation of the great differentiation of the first pair of trunk limbs, in all these primitive Crustacea, is no doubt to be found in the fact that the sixth segment was really the first free segment, *i.e.* the first segment not used up in any way in the bend which forms the head. Its parapodia were thus free to develop as limbs for locomotion or for some other function unconnected with the mouth (see Fig. 1). The development of the anterior trunk limbs into maxillipedes in the higher Crustacea, has long been considered to be a secondary modification. In the chief point which constitutes them maxillipedes, *i.e.* in the retention of the ventral parapodia as masticatory ridges, they are however the more primitive form of limb. Those Crustaceans, on the contrary, in which the first trunk limbs have lost all traces of the ventral parapodia, and are purely loco-



motory, are the more highly specialised. The maxillipedes are secondary modifications only in the degeneration of their dorsal parapodia which, as the limbs of the first free segment, typically developed into large locomotory limbs.

In *Apus*, the gnathobases of the anterior trunk limbs are retained, and are doubtless functional. In *Limulus* those of the first pair even work in front of the under lips ; the same is true of the Trilobites, and of the Eurypteridæ, in some of the latter they have taken on almost the whole function of mastication.

The extraordinary number of the limbs, and their gradual simplification from before backward, *i.e.*, from complicated Crustacean limbs to parapodium-like swimming plates, has been already discussed and described.

The following points are also of interest. Unlike the limbs of the head, in which, for the purpose of pushing food into the mouth, the ventral parapodia were developed at the expense of the dorsal, the trunk limbs develop the dorsal at the expense of the ventral parapodia.

*Apus* shows its primitive character in that the ventral parapodia do not disappear, but are retained as functional appendages to the limbs for pushing food towards the mouth. In the higher Crustacea, however, they have, as a rule, entirely disappeared, except in a few anterior trunk limbs.

The reason of the greater development of the dorsal than of the ventral parapodia in the trunk limbs of *Apus* may be conjectured ; the greater sweep

was needed both for locomotion and for the purpose of grasping and bringing prey towards the middle line. This bending round of the dorsal parapodium towards the ventral middle line naturally leads to its greater development, at least in the anterior limbs, which function as described ; in the posterior limbs, which have only to assist in swimming, the dorsal branch is not so highly developed, forming with the ventral the swimming plate (Fig. 10).

The anterior limbs are the most highly differentiated from the original parapodia, they are the most Crustacean. On the principle of the division of labour, we find the first limb almost entirely specialised as a sensory limb. Its appendages, omitting the ventral parapodium, formerly considered as an appendage of the limb, are, on the inner side, feelers (called endites) with tufts of sensory hairs on slight protuberances, which are regularly arranged alternately on the two sides (see Fig. 9). The feelers vary in length in different species, and are of importance in classification. The corresponding appendages on the other limbs are leaf-shaped plates with highly developed denticulate setæ<sup>1</sup> on their flat surfaces, and tufts of sensory hairs along their edges. Besides helping in swimming, these sensory endites have been specially developed to assist in the capture of prey. The action of sweeping together prey into the middle line by means of the long dorsal parapodia, requires a fine sense of touch on the under edges of the limbs. The denticulate hairs at the sides of the

<sup>1</sup> See Fig. 5.

endites may have been developed in order to prevent prey from getting away between the limbs, the endites being provided with special muscles to move them. The prey, which the dorsal parapodia succeed in raking into the middle line, is probably held,

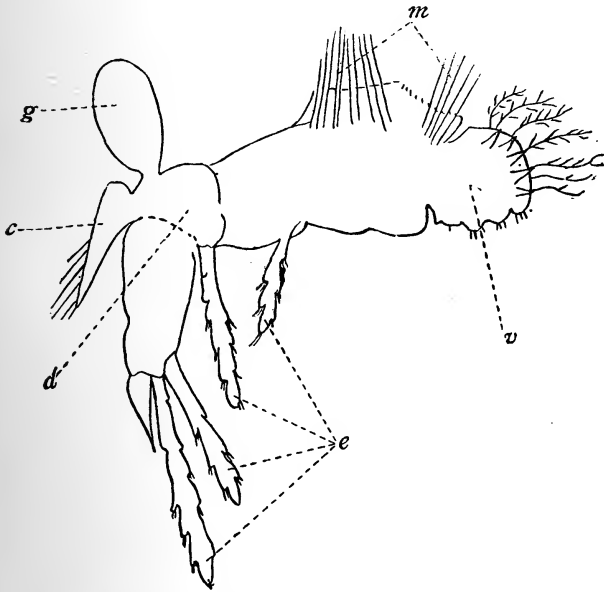

FIG. 9.—First trunk limb (*L. Spitzbergensis*). Lettering as in former figures. *e*, sensory endites.

and perhaps killed, by the ventral parapodia, which are provided with sharp thorn-like setæ, as well as with long sensory hairs (Figs. 9 and 10). We can further judge from their shape and from the direction of

their muscles (see Fig. 12, p. 55) that what the gnathobases held between them would be rapidly forwarded towards the mouth. The disappearance of the gnathobases, excepting on the most anterior trunk limbs—the maxillipedes—in the majority of modern Crustacea, is explained by a change in the manner of life. As the trunk limbs became more and

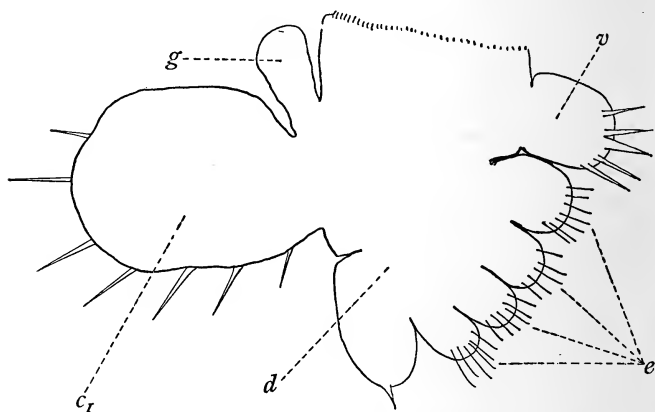

FIG. 10.—The last rudimentary trunk limb (*L. productus*),  $\frac{1}{4}$  mm. in length. Lettering as before. It is seen to be a typical Phyllopodan limb.

more purely locomotory organs, such as ambulatory legs, and as other methods of capturing prey were acquired, the ventral parapodia would degenerate, not only from having lost their function, but as positive hindrances to the free movement of the limbs.

The most distal appendage, on the first limb of *Apus*, is a probably functionless scale (Fig. 9), and in the following limbs it is a toothed claw (Fig. 4), while

in the posterior rowing limbs it is a flat piece forming part of the swimming plate (Fig. 10). What we here call the most distal appendage is, however, according to the homologies described on p. 32, in reality the tip of the dorsal parapodium.

The exites, or appendages on the back of the limb, are always two in number, the distal being a swimming plate (flabellum, homologous with the sensory cirrus of the Annelidan parapodium), much reduced on the first limb but well developed on all the rest, and the proximal a gill which corresponds in position with the gill on the dorsal parapodium of the Annelid.

The limbs themselves have been so often described that it is not necessary here to do more than refer to the drawings (Fig. 9, 4, 5, 10).

Returning now to the homologies here set forth between the Crustacean limbs and the Annelidan parapodia, we find that they differ considerably from those generally put forward. Although as far as I know the point has not been worked out in detail, it is assumed that the exopodite is homologous with the dorsal, and the endopodite with the ventral parapodium. We have here, however, seen that in the typical biramose trunk limb the ventral parapodium has disappeared, perhaps being used up in the formation of the basal joint, and that the limb proper is formed of the dorsal parapodium, the distal end of which forms the endopodite, while its sensory cirrus forms the exopodite.

Such a result might be expected on theoretical

grounds; an integumental fold, developing outwards into a limb in order to fulfil various functions, would require to be provided with sensory organs. Its efficiency could in fact only be secured by its being provided with a fine sense of touch. It is true that in *Apus* the ventral edge of the dorsal parapodium has itself developed organs of touch, viz., the endites. The tip of the parapodium might also have developed its own sensory organs. Economy, however, would certainly lead to the use of whatever sensory organs happened to be already present.

This homology of the flabellum of *Apus* with the sensory cirrus of the Annelidan parapodium, finds some support from a study of its finer structure. Its fringe of sensory hairs, its numerous ganglion cells and conspicuous nerve fibres, show it at once to be a sensory organ. Its flattened shape presents no difficulty, since it is clearly thus modified to help the animal in swimming. Packard thinks that it takes a special share in respiration, but this we do not believe, for the gills, in their inner structure and in their freedom from hairs, show that they are specialised for that purpose.

Further, the consequent homology of the exopodite of the typical Crustacean limb with the sensory cirrus of the dorsal parapodium of the Annelida, receives considerable support from a study of any series of Crustacean limbs, such, for instance, as those given in Lang's *Text-book of Comparative Anatomy*. It is impossible to avoid the impression that as a rule (with no doubt many exceptions) the exopodite is a sensory

organ attached to the limb. We shall see further reasons for this homology in the section on the Nauplius.

In later sections we shall see, further, that although the ambulatory limb of the Decapoda has been derived from the Phyllopodan limbs of their Leptostracan ancestors, yet ambulatory limbs may develop straight from Annelidan parapodia, as we assume to have been the case in the Trilobites. The method of differentiation is the same in both cases, but the fact that the Decapodan limb first passed through a Phyllopodan stage has made a slight difference in the result (see section on the Trilobites).

This brief discussion on the limbs of Apus and of the Crustacea is by no means exhaustive. We have purposely limited ourselves chiefly to our main point, viz., how the limbs of Apus have been derived from the parapodia of an Annelid. In so doing we have naturally had our attention called to several homologies which may not at this stage appear altogether satisfactory, but which will be found to hang together with our whole argument.

## SECTION IV

### THE MUSCULATURE

THE musculature of the Apodidæ is so essentially Annelidan in its arrangement, showing only such differentiations as we should expect would arise from the modification of the body already described, *i.e.*, the bending of the head, that were there no other resemblance between the Apodidæ and the Annelida, it alone would be almost sufficient to establish their relationship.

It may perhaps be interesting to mention that it was the Annelidan character of the musculature of *Apus* which first attracted our attention, and led to the discovery of the other homologies recorded in this volume.

Anteriorly, where the body has been apparently most modified, we should naturally expect that the Annelidan character of the musculature would be least recognisable. This, however, is hardly the case, for just as the head of the Apodidæ can be traced to the anterior segments of an Annelid fixed in the



bent position, the only striking alteration being its development of the sharp ridge round the front as a continuation of the lateral edges of the dorsal fold, so the musculature can easily be traced back to that of a typical Annelid transformed, first by the bending of the body, and secondly by the development of the exoskeleton.

We shall first describe the musculature in a carnivorous Annelid, and see what transformations it would undergo owing to the bending of the five anterior segments. Fig. 11 is a transverse section of such an Annelid. A rather weakly developed circular muscle layer is found immediately under the hypodermis, and under this runs a strongly developed longitudinal muscle layer, the two forming together the dermo-muscular tube. The development of parapodia leads to important modifications, such as the grouping of the longitudinal muscles into four strong bands, two dorsal and two ventral, each being a chain of segmentally arranged muscular bundles marked off by the transverse dissepiments. The circular muscles are also modified, running out laterally, both dorsally and ventrally, into the parapodia.

At the posterior end of the body where the parapodia are less developed, we might expect that the muscle bands would gradually spread out to form a more and more complete dermo-muscular tube, the dorsal bands eventually uniting with the ventral in the last segments.

It is not difficult to describe the changes which would naturally take place in this musculature by the fixing

of the anterior segments in the bent position. The *dorsal* bands in the five anterior segments would be much stretched in order to bend round over the intestine to be attached near the prostomium. The *ventral* bands in the same region would, on the contrary, be much shortened, the bend behind the lip being very sharp. The muscle bands here would

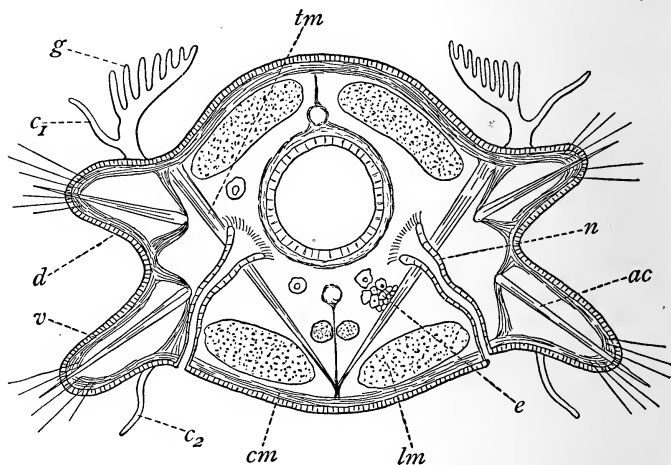

FIG. 11.—Transverse section through the trunk of a carnivorous Annelid, diagrammatic (from Lang's *Text-book of Comparative Anatomy*). *g*, gill; *d*, dorsal; *v*, ventral parapodium; *c*<sub>1</sub>, cirrus of the dorsal parapodium; *c*<sub>2</sub>, ditto of the ventral parapodium; *cm*, circular musculature; *lm*, longitudinal musculature; *tm*, transverse musculature; *ac*, aciculum; *n*, nephridium; *e*, developing eggs, some of which are floating free in the body cavity.

be rendered almost useless, in fact, would be a hindrance, and would therefore degenerate, not, however, without leaving some traces. While the muscular elements disappeared, the sinewy elements would persist as points of attachment for those

muscles which are still functional, *i.e.* those which diverge in the transverse plane.

Let us now compare this sketch with the musculature of the Apodidæ (Figs. 12 and 13). The dorsal longitudinal bands in the head region, after springing across the opening into the interior of the shell fold of the fifth segment, are attached to the forehead by numberless fine fibres of connective tissue, so that it

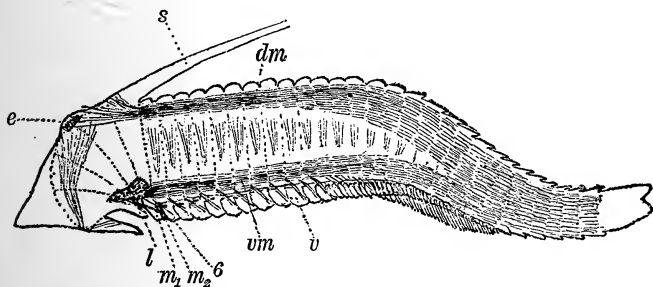

FIG. 12.—Section through a specimen of *Apus cancriformis*, partly diagrammatic, to show the longitudinal musculature. Anteriorly the dorsal bands are stretched round the bend of the head, the ventral bands of the five segments being clumped into a sinewy mass, the sternal plate. Posteriorly the two unite round the body to form a dermo-muscular tube. *dm*, dorsal; *vm*, ventral muscle bands; *s*, shell; *e*, eye; *l*, under lip; *m<sub>1</sub>*, *m<sub>2</sub>*, 1st and 2nd maxillæ; *v*, ventral parapodia of trunk limbs; 6 ditto of 1st trunk limb. The five original anterior segments of the Annelid indicated by dotted lines.

is not at first apparent that the two strong bands which start a little in front of them from very scattered points of insertion on each side of the eyes, running down over the œsophagus to be attached in front of the prostomium, are really a continuation of the dorsal bands. That this is the case, however, is clear from Fig. 13. We see here not only the dorsal bands themselves lengthened to pass round the curve

formed by the bending of the head, but the attachments of the muscles also spread out over a large surface. Further, partly from having no segments to move, and partly on account of the growth of the frontal ridge, they apparently pass through one or two segments without being attached at all.

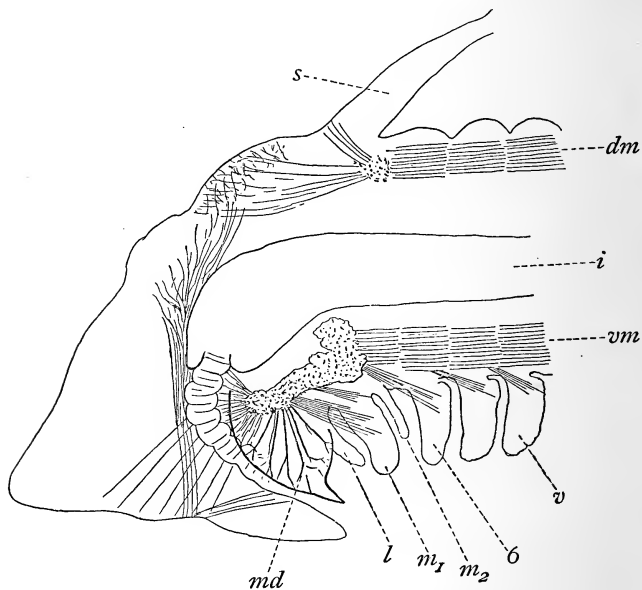

FIG. 13.—Diagram to show the musculature of the head. Lettering as in Fig. 12. *md*, mandibles; *i*, intestine.

The ventral muscle bands of the Apodidæ, on the other hand, on reaching the sharp bend of the head near the lip, are all clumped together into an apparently shapeless sinewy mass; the muscle bands

themselves have clearly disappeared; their sinewy connections, however, being more resistant, and still functional as attachments for the mandibular, maxillar, and œsophageal muscles, &c., have been retained, massed together as described in our imaginary Annelid. This sinewy mass is known as the *sternal plate* or *entosternite*. It is clear that, if the origin we have ascribed to it is correct, it becomes a morphological characteristic of great value, and, whenever met with among the Crustacea in the same position, *i.e.*, within the angle of the bent intestine, must be referred back to the ventral muscle bands of a bent Annelid. We shall see in the second part how important this point is in establishing the relationship between *Apus* and *Limulus*. The Arachnida are, we believe, the only other animals with an entosternite. The origin and significance of it in this case will be discussed in another section.

Again, turning to the posterior end of the body, we find, as we expected, that as we pass from front to back the longitudinal bands gradually widen out, as the limbs are less and less developed, until, in the limbless segments, they unite to form a simple dermo-muscular tube.

Thus, in the arrangement of its longitudinal musculature, *Apus* is a typical carnivorous Annelid with its five anterior segments bent round in adaptation to the browsing manner of life.

On turning now to the circular musculature, we find a more complete differentiation. The circular muscle layer in the carnivorous Annelids is, as a rule,

much more weakly developed than the longitudinal. This is also the case in the Apodidæ, where it is almost entirely confined to the muscular bands which run into the limbs, especially to those from the dorsal surface. In the limbless part of the body, where the longitudinal muscles form a complete dermo-muscular tube, the circular muscle layer has entirely disappeared. The commencement of the formation of an exoskeleton renders it useless. We shall return to this subject in discussing the musculature of the limbs.

The muscles attached on each side, just above the ventral cord, to the membrane which encloses the intestine and genital glands, and forms the intestinal sinus, may perhaps best here be mentioned as in part having arisen from the circular musculature. We shall return to these also when we discuss the circulation and the origin of the above-mentioned membrane.

Two especially interesting groups of muscles, of unmistakably Annelidan origin, deserve particular attention. These are the rows of dorso-ventral muscles (Fig. 14, *dv.*) which pass between the intestine and the genital glands in almost exact correspondence with the longitudinal muscle dissepiments so common among the Annelida (*cf.* Fig. 11, *tm*). In the Apodidæ, these rows are composed of a kind of lattice work of muscle bundles with definite points of attachment, ventrally to the sinewy partitions of the ventral muscle bands and thus indirectly to the body wall, and dorsally to the segmental con-

strictions in the integument. In each segment we find two bands crossing each other diagonally, in addition to those placed between the segments. These strikingly Annelidan dorso-ventral muscle bands of *Apus* are not, as far as we know, preserved in any of the higher Crustacea, being rendered useless by the development of the exoskeleton. Clear traces of

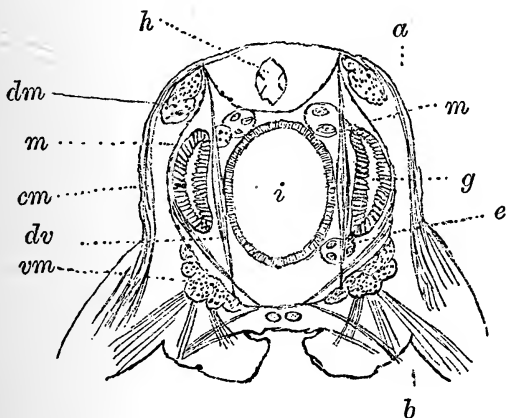

FIG. 14.—Transverse section through *Apus cancriformis*, to show the distribution of the musculature. *h*, heart; *dm*, dorsal; *vm*, ventral muscle bands; *cm*, circular musculature (as shown in Fig. 15, *A*); *dv*, dorso-ventral musculature (cf. Fig. 11, *tm*); *m*, membrane enclosing the intestinal and genital sinus; *i*, intestine; *g*, genital glands; *e*, eggs; *a* and *b* have reference to Fig. 15.

them are, however, found in *Limulus*, where their points of attachment have drawn in the outer integument to form the entapophyses. Their use in *Apus* will be discussed in the sections on circulation and reproduction. They are not developed in the posterior rudimentary segments.

The muscles of the limbs present complications

which might have been expected, when we take into account the transformations which have developed the latter out of parapodia. It will not be necessary to describe the muscles of the more distal parts of the limbs; we must confine ourselves to those which move the limbs on the body, and endeavour to show

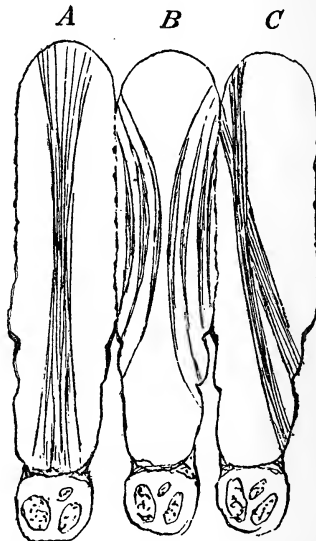

FIG. 15.—Tangential sections through three segments passing between the longitudinal muscle bands and the lateral body wall, diagrammatic, the plane of the section passes through the points *a* and *b* in Fig. 14, *A* to show the circular musculature; *B* to show the arrangement of the longitudinal musculature; *C* to show the crossing of the longitudinal muscle bands.

how they have arisen as simple modifications of the original dermo-muscular tube.

In the first place, we find that the muscles of the limbs have for the most part the same character as those of the trunk, *i.e.*, they are bands with broad



surfaces of attachment. They are, in fact, so far at least as they are composed of longitudinal muscles, nothing but the elements of the dermo-muscular tube drawn out of their position, as may be clearly seen from Fig. 12, which gives a general view of the whole musculature. The same fact might also be concluded from their great number, disorder, and want of concentration. When, however, we have to decide which muscles belong to the circular and which to the longitudinal layer, the following seems to be the

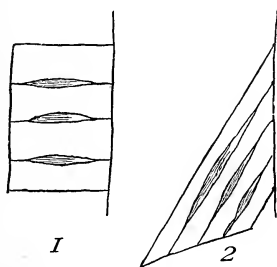

FIG. 16.—Diagram to explain the courses of the muscle bands in *B* and *C*, Fig. 15. 1 represents an Annelidan parapodium in its original horizontal position with three longitudinal muscle bands running into it. 2 represents the same drawn down to form a limb of *Apus*.

principle of arrangement. The muscles which enter the dorsal side of the limb with broad insertions on the soft integument of the dorsal surface (Fig. 15, *A*) are probably elements of the circular muscle layer; their position close under the lateral integument favours this derivation (Fig. 14, *cm.*; *cf.* also Fig. 11). On the other hand, we find on each side of the limb a number of muscle bands with more definite points of insertion; these are attached dorsally to the sides

of the septa (see Fig. 15, *B*), and are probably longitudinal muscles. The order in which these latter groups of muscles occur is significant of their origin, as shown in the diagram (Fig. 16). We find that those which arise most dorsally run the furthest into the limbs, this rule being regularly observed. This order is what we should expect if we assume that these are parts of the longitudinal musculature which ran outwards into the parapodium, the dorsal edge of which was then gradually lengthened, and the whole turned round the body in the transverse plane towards the ventral middle line, as shown in Fig. 16. The dorsal muscle bands will naturally be the most lengthened and reach the furthest down into the limb ventrally. In the case of longitudinal muscle bands running outwards into the parapodia, but traversing them from the anterior to the posterior wall, the same rule would hold and the bands would cross one another, as shown in Fig. 15, *C*.<sup>1</sup>

The musculature running into the ventral part of the limb or the ventral parapodium is more easy to separate into its elements (see Fig. 14). The longitudinal muscles come direct from the ventral muscle bands, and run sloping backwards, as shown in Fig. 12, so that the ventral parapodia or gnathobases which slope away downwards and backwards may be used for pushing food forwards in the middle line. The

<sup>1</sup> We have, however, only once found such muscle bands, and have since repeatedly looked for them in vain. It is not unlikely that our observations relating to them were incorrect, being founded on a series of sections, through which the individual muscle bands had to be followed.

circular muscles of the ventral parapodium are as inferior in development to those of the dorsal parapodium, as the ventral parapodium itself is inferior in development to the dorsal. They consist of only two bands. One passes between the ventral cord and the ventral muscle band, to be attached proximally to the ventral membrane of the intestinal sinus, the other is attached direct to the hypodermis at each side of the ventral cord (Fig. 14). The former muscle will be mentioned again in describing the circulation, in which it perhaps plays a more important part than it does in connection with the limbs.

It is hardly necessary to describe the musculature of the trunk limbs more in detail. That of the head limbs, however, requires special attention, not only on account of the origin of these limbs almost exclusively from ventral parapodia, but also because the masticatory formula of the Apodidæ is, with slight differences, the same as that found in the majority of modern Crustacea, viz., one pair of mandibles and two pairs of maxillæ; although in *Apus*, the second maxillæ are rudimentary.

Commencing with the mandibles, we there find an arrangement exactly the opposite of that described in connection with the trunk limbs. In these latter the muscles running into the dorsal branch are the more highly developed; in the mandibles, however, the dorsal branch is rudimentary, and the muscles running into the ventral branch are the most developed. The closing muscles radiate from the sinewy mass above described, and are

enormously developed in accordance with the great development of the limb they have to move. They evidently correspond with the muscles already described as running into the ventral parapodia of the other limbs, that is with those which come from the longitudinal muscle band. They radiate from the sternal plate, *i.e.* from the remains of the ventral muscle bands of the head segments. At the dorsal extremity of the mandibles, we find the remains of the circular muscles which (see Fig. 15, *A*) were so powerfully developed in the trunk limbs, in two or three bands running between the dorsal middle line and the integument, where the last rudiment of the dorsal parapodium has disappeared (see Fig. 8, *A, d*, p. 37). The longitudinal muscles, attached to the integumental folds between the limbs (see Fig. 15, *B*), are strongly represented, and probably serve both for closing the mandibles and rotating them round their longitudinal axes.

The same description applies with but slight modification to the muscles of the first maxillæ, but in this case, those of the ventral parapodium, though strongly developed in comparison with those of the ventral parapodia of the trunk limbs, are weak as compared with those of the mandibles. Again, a more distinct rudiment of the dorsal parapodium is retained in the first maxillæ than in the mandibles, and into this rudiment a very long and tolerably strong band runs, probably homologous with the circular muscle bands shown in Fig. 15, *A*. The powerful muscles which enable the first maxillæ to

function as jaws are also, like the closing muscles of the mandibles, derived from the sinewy mass, and run slantingly backwards, across the opening leading into the under lip.

The muscles of the second maxillæ are very slightly developed as thin slips running into the dorsal and ventral parapodia; the former, as already described, arising from a point close to the opening of the shell fold.

The rings of muscles round the eyes will be described in the section on the sensory organs, and we shall see that they are developed from the longitudinal musculature, and join the two bands which are attached to the proximal end of the upper lip. Certain bands which run from the sternal plate to the opening of the shell fold, to join the dorsal longitudinal bands, are probably to be referred to the dorso-ventral longitudinal muscle septa.

We find the expected histological difference between the musculature of *Apus* and that of the Annelids, that of the former being striped, that of the latter unstriped. Perhaps the primitive character of the striped muscles of *Apus* may be seen in that the muscle cells form a thick irregular layer of nucleated protoplasm round each bundle of fibres, without any investing membrane or sarcolemma.

This brief chapter by no means exhausts this interesting subject; further study will doubtless reveal other, and perhaps more conclusive, homologies between the muscles of *Apus* and those of a carnivorous Annelid. We have here selected only the

---

most obvious; enough, however, to establish our point that *Apus* may have been derived—at least so far as its musculature is concerned—from such an Annelid as we have described. We thus find that the musculature confirms what we learnt from our study of the outer organisation and of the appendages.

## SECTION V

### THE NERVOUS SYSTEM

THE nervous system of *Apus* does not at first sight seem to support our theory as obviously as does the musculature. This, however, is the case only at first sight. A closer study of it, and a comparison of it with that of an Annelid modified by having its five anterior segments bent in the way assumed, leave but little doubt concerning its origin. The central nervous system of *Apus* can in fact be shown to be the central nervous system of a bent Annelid adapted to the necessities of a new manner of life; the principal modification being due to the migration of the eyes on to the dorso-frontal surface.

Figure 17 shows the general type of the nervous system of a carnivorous Annelid, such as the ancestor of *Apus* may be supposed to have possessed. The longitudinal commissures may perhaps have been somewhat wider apart.<sup>1</sup> We find the brain in the

<sup>1</sup> See however p. 80.

prostomium giving off two pairs of nerves to the two pairs of eyes, and connected by œsophageal commissures with the infra-œsophageal ganglion in the first segment. From this ganglion the nerves to the first antennæ diverge; they may perhaps have been united for some distance with the œsophageal commissures. It is even possible that their

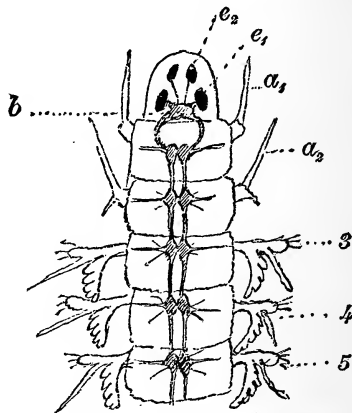

FIG. 17.—Diagram of the first five segments of a carnivorous Annelid to show the arrangement of the nervous system, from above.  $b$ , brain;  $e_2$ , anterior pair of eyes on the prostomium;  $e_1$ , posterior ditto;  $a_1$ , first antennæ;  $a_2$ , antennal parapodium of the second segment.

ganglia may have moved forwards along the commissures towards the brain, as in many Annelids we find the antennæ moved forwards till they appear to be projecting from the posterior edge of the prostomium. The second antennæ, belonging to the second segment, would receive their nerves from the second ventral ganglion, then would follow the nerves to the parapodia of the third segment, &c., in order.



Just as the sharp bending of the head led to a condensation of the ventral musculature into the sinewy mass above described, so it would naturally lead to a fusing of the anterior ventral ganglia, as shown in Fig. 18. We should thus expect to find at

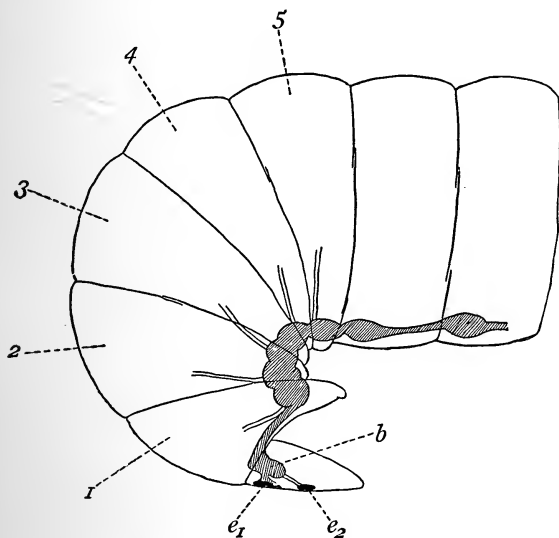

FIG. 18.—Anterior end of the same, bent as in Fig. 1 to show the change in the central nervous system due to the bending of the body.

least the first three or four pairs of ganglia of the ventral chain fused to form one infra-oesophageal ganglion; the outgoing nerves, however, would remain distinct, except perhaps the first antennal nerve, which, as we have said, might have been fused for a short way with the oesophageal commissures, or might even, as

above stated, come almost direct from the brain. The other changes, brought about by the bending of the segments, would be the disappearance of the longitudinal commissures between the four or five fused ganglia, and perhaps a fusion of at least some of their transverse commissures. We shall see in the second part of this book, when we come to compare *Limulus* and *Apus*, that the nervous system of the former, though showing certain special modifications of its own, corresponds, to a remarkable degree, with that of such a bent Annelid, and thus shows even a more primitive state than that of *Apus*.

Now let us consider the modification such a central nervous system would undergo owing to the gradual migration of the eyes on to the dorsal surface. Figs. 19 and 20 are two diagrams to illustrate the change; Fig. 19 supposing the ganglion for the first antenna to come from the infra-œsophageal ganglion, Fig. 20 supposing this ganglion to have already migrated along the commissures to near the brain. The brain, following the eyes, would divide the original œsophageal commissures ( $\alpha_1$ ) longitudinally, thus producing two œsophageal commissures, one ( $\alpha_2$ ) in its original position, innervating the œsophagus and the upper lip, and the other ( $\alpha_3$ ) carrying the brain and the eyes.

This origin of the two œsophageal commissures in *Apus* is especially interesting because it explains *the origin of the sympathetic nervous system* in the Crustacea. Reserving, however, this point for the present, we have to consider the more difficult problem relating to the position of the antennal nerves, and how they

would be affected by this splitting of the œsophageal commissure owing to the travelling backwards<sup>1</sup> of the brain. Taking first the case illustrated in Fig. 19, *i.e.*, assuming that the nerves for the first antennæ branched, in the original Annelid, from the first ventral ganglia, we tried to answer this question theoretically. Our answer, however, was not quite correct. We assumed that the first antennal nerve was originally united with the œsophageal commissures for a short distance, and would remain where it was when the brain dragged away the portion it required for itself. We were doubtless also misled by the position of the first antennæ of *Apus* near the prostomium. These mistakes were very natural. For the second antennæ, however, our answer was correct. We rightly assumed that as the brain and œsophageal commissures moved forwards and upwards, passing through the position occupied by these antennal nerves, the two might unite, so that we described the nerves for the second antennæ as branching off from the brain commissures, this position agreeing best with the position of the second antennæ in *Apus*.

On comparing this theoretical scheme for the antennal nerves with Zaddach's drawings, we found, as stated, that the nerve for the first antenna, which has the more ventral position, branched off from the brain-œsophageal commissure dorsally to the nerve of the second antennæ which has the more dorsal position, so that, if Zaddach's drawings were correct, a slight

<sup>1</sup> "Backwards" is morphologically correct; actually the brain moved forwards and upwards.

crossing of the nerves must take place. Our own examination of the nervous system quite confirmed this, as shown in Figs. 19, 20, and 21. These figures

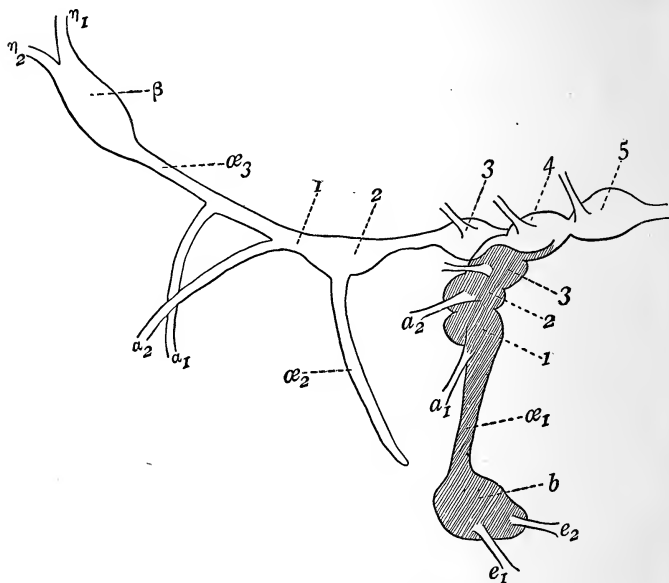

FIG. 19.—Diagram to show the derivation of the central nervous system of Apus from that of a bent Annelid as in Fig. 18; drawn on the assumption that the nerves of the first antennæ of the original Annelid branched from the first ventral ganglion. 1, 2, 3, 4, 5, ganglia of the 1st, 2nd, 3rd, 4th, and 5th segments. *b*, brain of Annelid;  $\beta$ , of Apus;  $\alpha_1$ , oesophageal commissures of Annelid;  $\alpha_2, \alpha_3$ , the two oesophageal commissures of Apus derived from  $\alpha_1$ ;  $\alpha_1, \alpha_2$ , nerves to the 1st and 2nd antennæ of the Annelid;  $\alpha_1, \alpha_2$ , ditto of Apus;  $e_1, e_2$ , nerves to the eyes of the Annelid;  $e_1, e_2$ , ditto to those of Apus.

should be compared with Figs. 1 and 2, which show the positions of the antennæ.

This position of the first antennal nerve tells us, however, nothing definite as to the position of the

ganglion. All we can positively affirm is that, if the ganglion was infra-oesophageal in the Annelid, the proximal portion of the nerve was carried up with the cerebral portion of these commissures

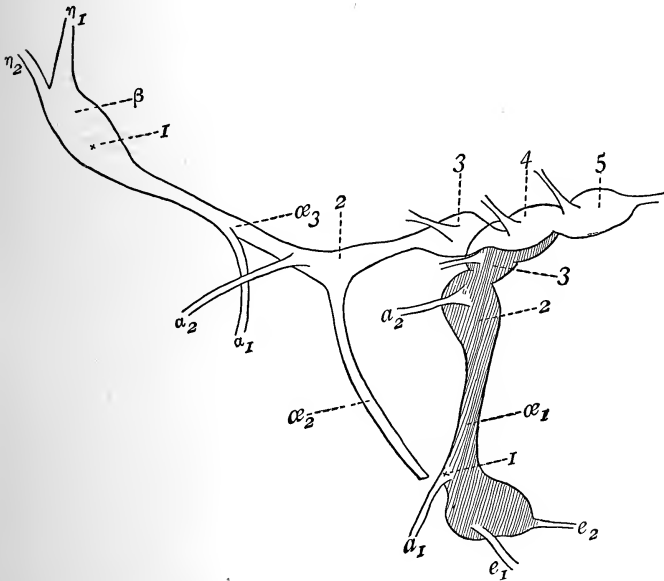

FIG. 20.—Diagram showing the same as Fig. 19, drawn, however, on the assumption that the nerves for the first antennæ in the original Annelid came from the posterior end of the brain. Lettering the same as in Fig. 19.  $\times$  shows the position of the ganglia of the first antennæ according to Pelseneer.

which split off and travelled backwards. This would explain the apparently anomalous position of the points of departure of the antennal nerves from the brain-oesophageal commissure,—they have to cross each other to reach their destinations. As these

commissures travelled upwards, describing part of a circle, carrying up with them the two pairs of antennal nerves, the pair of nerves which originally had the more ventral position would naturally come to occupy the more dorsal position, as shown in the diagram, Fig. 19.

If now we assume, as shown in the diagram, Fig. 20 that in the original Crustacean-Annelid the ganglia of the first antennæ had already travelled up the œsophageal commissures to near the brain, then we have to suppose that these ganglia split away with the brain-œsophageal commissures, although, by so moving off with the brain, they were dragged further from the limb their fibres had to innervate. This latter assumption, as shown in Fig. 20, agrees best with the description of the central nervous system given by Pelsener. He assumes that a group of ganglion cells, in the position marked  $\times$  in Fig. 20, form the ganglia for the first antennæ, and he supports this claim by the fact that the nerves branch backwards, as shown in Figs. 20 and 21.<sup>1</sup> If this reasoning is correct, then we may assume either (1) that the migration of the ganglia had already taken place in

<sup>1</sup> *Quarterly Journal of Micro. Sc.*, vol. xxv. Although inclined to believe Pelsener's view to be correct, his arguments do not seem to us quite conclusive. The results of our own research unfortunately remained neutral. We should much like the point re-examined; perhaps the new method of staining the nervous system of living animals with methylene blue would reveal the actual courses of the fibres. In our own best hæmatoxylin preparations the fibres became suddenly quite confused where the antennal nerve joined the commissure, and we could not say whether they ran on to the brain, or bent back towards the infra-œsophageal ganglion.

the original Annelid, and is inherited by Apus, or (2) that the formation of the compound sensory nervous centre (the syncerebrum of Lankester) has taken place in Apus by the wandering of the first pair of ganglia to join the brain. The former seems to us the more natural conclusion, considering the great difference in the distances between the brain and antennæ of an Annelid, and between the same parts in Apus. We mean that the great distance between the cerebral position of the ganglia of the first antennæ and the antennæ themselves in Apus, which seems unnatural, is best explained by assuming that this cerebral position of the ganglia was derived from the Annelid, where, owing to the proximity of the antennæ to the brain, it is most natural. On the other hand we think the second view the less probable, considering (a) the weak development of the first antennæ in Apus, and (b) the distance of the eyes from the antennæ, and the difficulty of correlating their respective sensations, the eyes pointing forwards and upwards, the antennæ backwards and downwards.

In the higher Malacostraca, with well-developed antennæ placed close to the eyes and functioning as auditory, olfactory, and tactile sensory organs, there would be no difficulty in imagining the migration of the ganglia to have taken place in the course of their development. But, as already stated, it is difficult to imagine this in the case of Apus, and it is easier to suppose that the fusion of the antennal ganglia with the brain had already taken place in the original

Annelid, We may perhaps find some support for this view in the fact that the first antennæ never appear in the Crustacea as anything but uniramosæ which shows that, in the original Annelid, they had long lost all traces of the parapodia to which they primitively belonged, and were nothing but sensory organs projecting forwards on each side of the prostomium.

Some further light might perhaps be thrown on this point by a study of the central nervous system of *Limulus*, which shows in some respects a more primitive condition than that of *Apus*, at least as regards the position of the brain. According to Packard, the fibres of the first antennal nerve do not come from the brain, but from the œsophageal commissures near it. Owing, however, to the great modification of the œsophageal commissures of *Limulus*, in consequence of the lengthening out of the oral aperture, it is doubtful whether this fact supports the view illustrated in Fig. 20, that, in the original Annelid, the ganglia of the antennæ had moved to near the brain.

There are, however, other points which bear on this question. On examining the first section of the ventral cord of *Apus*, we find a long ganglion consisting of two groups of ganglion cells, and joined by two transverse commissures. From the long ganglion, the prostomial-œsophageal commissures run down to embrace the œsophagus. Before reading Pelseneer's paper, we were inclined to consider the front group of ganglion cells, which form part of the long ganglion, as belonging to the first antennæ. It did not occur



to us that they belonged to the prostomial commissures, or stomato-gastric ring, as suggested by Pelseneer, because we considered this ring as no special nerve branching from the cord, but simply as the remains of the original œsophageal commissures.

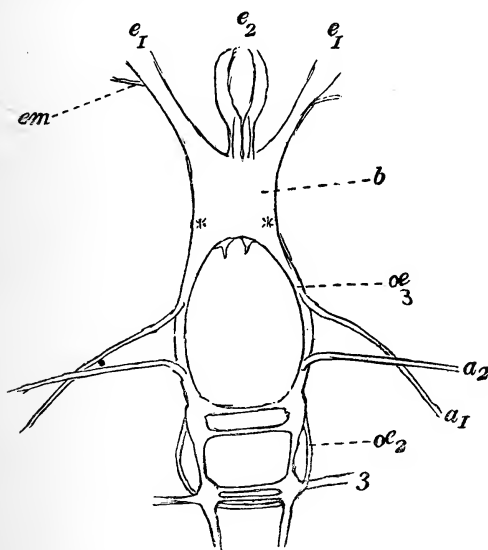

FIG. 21.—Central nervous system of Apus. Lettering as in Figs. 17, 18, and 19. *em*, nerve to the eye muscles;  $e_2$ , the anterior pair of eyes transformed into the unpaired "eye" (cf. § on the sensory organs); \* the position of the ganglia of the 1st pair of antennæ according to Pelseneer.

As for the two transverse commissures, we considered them to represent the two commissures of the two pairs of antennal ganglia. We assumed that each was due to a fusion of two transverse commissures, at least if we might conclude from the fact that the

other ventral ganglia in *Apus* have two transverse commissures, that the transverse commissures of the antennal ganglia were also originally double. On this supposition, passing from the original Crustacean-Annelid to the higher Crustacea, we should have two separate fusions. First, in *Apus*, there is a fusion of the double transverse commissures of the two pairs of antennal ganglia, leaving two transverse commissures, one for each pair of antennal ganglia; then, in the higher Crustacea, these two single transverse commissures of the two pair of ganglia again fuse, so that there is only one transverse commissure joining the œsophageal commissure in front of the infra-œsophageal ganglion. This transverse commissure, which is always assumed to be that of the ganglia of the second antennæ, would be, according to this view, the fused transverse commissures of the ganglia of both pairs of antennæ, though the ganglia themselves have wandered towards the brain.

We can see no inherent difficulty in thus deducing the central nervous system of *Apus* from that of a bent Annelid; none of the assumed transformations are in themselves improbable, if the migration of the eyes is once admitted. We shall return more than once to this subject of the migration of the eyes, especially in connection with the *Nauplius* and *Limulus*, in each case bringing forward fresh evidence in support of the assumption. In the meantime it seems to us that the central nervous system of *Apus*, taken as a whole, bears incontestable witness

to the fact that the eyes have thus travelled on to the dorsal surface. Zaddach's diagram gives the brain and œsophageal commissures a distinct curve backwards, so that they come to lie along the œsophagus, reaching as far back as the mid-gut. The brain lies between the hepatic-diverticula.

In discussing the appendages, we saw how the antennæ, which were originally metastomial, became prostomial by the bending of the head. We now see that the same change of position has taken place in the case of the points of departure of their nerves (at least of those of the second pair). By the sweeping round of the cerebral portion of the œsophageal commissures upwards and backwards, and by their carrying the antennal nerves along with them, these nerves have also acquired a prostomial position.

This derivation of the central nervous system of *Apus* from that of a bent Annelid throws new light upon the fact, established by Claus and Dohrn, and referred to by Balfour with evident surprise, that, in the Nauplius, the nerves for the second antennæ arise from the infra-œsophageal ganglion. This is of course what we should have expected, indeed from our point of view it is necessary to account for the fact that the nerves of *both* the pairs of antennæ do not arise from the infra-œsophageal ganglion. We are obliged to assume that this primitive Annelidan condition was passed through in embryonic and not in larval life, *i.e.*, in an early Annelidan, not in a Crustacean stage.

Of the rest of the nervous system little need be

said ; the Annelidan character of the ventral cord of *Apus* has long been acknowledged as an unmistakable sign of relationship between it and the Annelida. Lankester has also called attention to the fact that the ventral cord resembles more nearly that of a Chætopod than that of a Crustacean. He sees its archaic character in the fact that the longitudinal strands are separated by a considerable interval. This reasoning is however doubtful, because in the rudimentary segments of *Apus* the ganglia in each segment are close together. While it is true that a great interval between the longitudinal halves of the ventral cord of an Annelid is generally supposed to denote an archaic condition, this state in *Apus* has clearly been secondarily acquired. Further, the presence of well-developed parapodia, which were gradually transformed into Crustacean limbs, is conclusive evidence that the Annelid from which *Apus* was derived was not a primitive form. The drawing out of the longitudinal commissures of the anterior ganglia of the ventral cord which, in the bent Annelid, were massed together (see Fig. 18), is clearly a secondary modification, due to the travelling forwards of the brain. It will be referred to again in the next section in connection with the migration of the eyes.

Till now, it has never been quite understood why the ventral cord should suddenly cease with the limbs, so that no ventral ganglia are developed in the limbless segments. The explanation of this we have already seen, viz., that the posterior end of the

body becomes fixed in a larval stage ; the posterior limbs with their ganglia remain quite rudimentary, while the last few segments develop neither limbs nor ganglia.

Some light is also thrown on the morphology of the sympathetic nervous system, which is particularly well developed in the Malacostraca. The second œsophageal ring formed by the sympathetic nerve is, in fact, the remains of the original Annelidan œsophageal ring, after the splitting off of the portion which carried the brain. The present Crustacean œsophageal commissures, together with the ring made by the sympatheticus, formed the original Annelidan œsophageal commissures.

We also get an interesting insight into the morphology of the Crustacean brain. Originally, when still placed in the prostomium, it consisted of the ganglia of the two pairs of eyes, and of whatever other sensory organs may have been on the prostomium, and perhaps also of the ganglia of the first antennæ. These sensory centres (with the exception of the last, which were probably situated on the œsophageal commissures) were but collections of hypodermal ganglia, as is clear from the fact that the pair of longitudinal muscles which traverse the head dorso-ventrally (see Figs. 12 and 13) pass between the brain-œsophageal commissures ( $\alpha_3$ ); this shows that the ganglia must have had a hypodermal position, *i.e.*, must have lain between the hypodermis and the musculature. On the migration of the eyes, the optic ganglia would separate from the ganglia which

belonged especially to the prostomium, taking the antennal ganglia along with them on the commissures which continue to unite the brain with the ventral cord.

The transformation of the anterior pair of eyes into the unpaired "eye" with other sensory functions would bring about secondary complications.

The gradual wandering of the ganglia of the first antennæ along the œsophageal commissures, or, if these were already near the brain, their final union with the same, added further complications.

Lastly, when the antennæ, and especially the anterior pair, adopted a frontal position on the head, and became important sensory limbs carrying olfactory, auditory (? directive), as well as tactile sensory organs, so that their ganglia became large complex sensory centres at the posterior end of the brain, its complication was completed, and it reached the stage found in the higher Crustacea (*e.g.*, Decapoda).

At first sight, this method of deducing the Crustacean nervous system from that of a bent Annelid may not appear to the reader altogether satisfactory. We may therefore perhaps anticipate what we shall describe in its right place, and mention that when we drew Fig. 18, to show where the brain was originally placed in the more Annelidan ancestors of *Apus*, we had quite forgotten that this was *still the place which it occupies in Limulus*. In Part II. we hope to be able to show that, if *Apus* is derivable from a bent Annelid, *Limulus* must also have had the same

origin. This difference in the position of the brain in *Apus* and *Limulus* is one of those cases, referred to in the preface in which the differences between these two animals afford more striking proof of their relationship, through a common origin from a bent Annelid, than any similarity in the position of the brains could have done.

## SECTION VI

### THE SENSORY ORGANS

IN our endeavour to deduce the sensory organs of Apus from those of a carnivorous Annelid, we must not forget that the development of an exoskeleton must necessarily lead to striking modifications. Such modifications, important in all the organs, are especially so in those which, like the sensory organs, lie at the surface in more or less immediate contact with the outer world. We will take the sensory organs in turn, and discuss the changes which took place in them during the transformation of the Annelid into the Crustacean.

The *antennæ*, as sensory organs, admit without difficulty of deduction from the antennæ and antennal parapodia of the first two segments of the Annelid, as we have already seen in the section on the appendages.

The round white spot behind the eyes of Apus has often been taken to be a sensory organ, and we



originally assumed it to be the remains of a frontal cirrus (as shown in Fig. 1) smoothed off to facilitate swimming. We have, however, discovered that its functions are entirely excretory (see Section IX., on the excretory organs, and Appendix III.).

Of the original four anal cirri of the Annelid, two are retained and two are rudimentary. Those retained have developed a ringed cuticle for the greater part of their length, and so far are covered with setæ also arranged more or less in rings, those on the inner side being longer than those on the outer. The tips of these cerci are thin-skinned, and function as tactile papillæ; this is indicated by shading in the drawing of *L. Spitzbergensis* given as frontispiece.

The two rudimentary cirri are reduced to papillæ on the dorsal surface of the anal segment; they are thin-skinned, and surrounded anteriorly by a rampart of thorns; from the centre of each rises a long branched tactile hair.

The whole body is covered with hairs. We have found at least four kinds.

(1) There are very fine hairs in groups of two and three; they are apparently longer (*ca.*  $4\mu$ ) on the intersegmental membranes than on the harder parts of the cuticle (*ca.*  $2\mu$ ). We have found them chiefly on the exposed abdominal segments. It is very doubtful whether they are sensory; their great numbers and minute size render it probable that they serve to prevent the attachment of other organisms which might hinder free locomotion. On the other hand,

this very roughness might favour the attachment of spores.

(2) There are, further, short straight hairs which seemed to be sensory, but all our attempts to trace their elements through the cuticle were baffled; in one place alone, where the cuticle was split from the hypodermis, we saw fine processes connecting the points where the hairs arose with the hypodermis, and these may have been nerve fibres. These short hairs are very numerous, especially in the frontal and dorsal regions of the head.

(3) There are undoubted sensory hairs whose nerves even with a low power are easy to follow into the hypodermis, where they probably join the sub-hypodermal nerve plexus.

(4) The sensory hairs and setæ on the limbs may perhaps be classified as follows.

(a) Tufts of minute hairs on small papillæ round the edges of the endites, and along the outer edges of the gnathobases.

( $\beta$ ) Long feathered hairs on the gnathobases, occurring together with sharp tooth-like setæ, which latter help to give the gnathobases the character of jaws (see Fig. 9, p. 47). The nerves of these highly developed tactile hairs are easy to follow; the ganglia at their roots are compound (see Fig. 31, p. 131).

( $\gamma$ ) A fringe of similarly feathered hairs round the flabella, which we have homologised with the sensory cirri of the dorsal parapodia. The flabella being transparent, the nerves can easily be followed.

( $\delta$ ) Hooked or bent hairs on the first antennæ which we homologise with the olfactory hairs of the higher Crustacea (see Fig. 7, p. 34).

To these may be added:—

( $\epsilon$ ) Fine sensory hairs thickly covering the inner surfaces of both upper and lower lips.

The gill, as already stated, has no hairs, since these would hinder the free flow of the respiratory medium.

Besides these different kinds of hairs, there are stiff denticulate bristles in rows near the bases, on the flat surfaces, of the rhomboidal feelers (the endites), which probably hinder the escape of prey between the limbs (see Fig. 5, p. 23, and p. 46).

While, perhaps, the finer sensory hairs may be homologised with similar tactile hairs in the Annelida, it is not easy to homologise the more highly developed setæ. If any of the original Annelidan setæ have been transformed into the hollow Crustacean hairs, the transformation would have to be described somewhat as follows. The thickening of the cuticle supplying a firm base for the seta, it would not be necessary for it to sink below the integumental surface. Again, the integument not being liable to be thrown into folds like the soft skin of the Annelida, the seta would not require to be movable; hence there is no need for it to project from a sac-like group of secreting cells under the cuticle, provided with muscular attachments. The Crustacean seta is a hollow process of the cuticle secreted by a ring of hypodermis cells, through which the nerve runs into the lumen of the seta. At the base of the hair, the

nerve swells into a ganglion. In the feathered hairs, a fibre runs into each barb, and the ganglion is a regular group of cells (see Fig. 31, p. 131). This nerve may well be the nerve which originally supplied the setiparous gland of the Annelid, and the ring of secreting cells all that remains of the sac itself.

On each side of the under lip is a straight longitudinal row of sensory papillæ. As these are sometimes found thickly clogged with particles of food, they probably border the channel leading into the œsophagus on each side, to hinder juices, &c., from escaping laterally under the mandibles.

#### THE EYES.

We are here brought face to face with a problem of no small difficulty. It is clear that if our theory is true, we have to attempt to explain the development of the eye of *Apus*, *i.e.*, the development of the typical Crustacean eye from that of the Annelids. It is hardly necessary to dwell upon the difficulty of such a task, since it is but too well known that the last word has not been said as to the actual structure of either the Crustacean or the Annelidan eye. Still we cannot turn from the attempt, especially as we hope to be able to show that if we do not go into too many details, and at the same time keep constantly in mind the effect which the development of a thick chitinous cuticle would naturally have upon the hypodermal eye-spots, it is possible to sketch a fairly probable origin of the Arthropodan eye.

We confine our attention at present entirely to the paired eyes, reserving the unpaired "eye" for special description later on. We may here say that, whether this attempt to explain the origin of the Crustacean eye as a visual organ from the Annelidan eye succeeds or not, our theory will not be affected, for there are points in the anatomy of the eye of *Apus*, such as the musculature and the space between the eye and the integument for water, which are easily enough explained on our theory, and which would, we think, be very difficult to explain on any other theory. If then we ourselves fail to trace the rise of the elements of the Crustacean eye, another, better fitted for the task, will no doubt be more successful.

As already stated in the introductory chapter, our original Annelid is supposed to have had (like the *Nereidæ*) two pairs of eyes on the prostomium, which we have called simple eye-spots. Von Graber has shown that these Chætopodan eye-spots are by no means simple structures, but are complicated visual organs. This, however, does not make our task any the more difficult, because we attribute the transformation of the Annelidan into the Crustacean eye chiefly to the thickening of the cuticle, which is one of the Crustacean characteristics of the Nauplius before the paired eyes are formed. The simple hypodermal elements of the Annelidan eye have thus had to develop, in each individual, not under Annelidan but under Crustacean conditions, *i.e.*, under a thickening exoskeleton.

When we come to ask what are the most character-

istic elements in the Crustacean eye, we find them to be (1) the crystal cones, and (2) the retinulæ, *i.e.*, definite groupings of a certain number of retinal and pigment cells (see Fig. 23). In the first of these we have a new structure, whose development must be accounted for; the second may safely be assumed to be merely specialised hypodermal sensory (*i.e.*, visual) cells; we have simply to account for the "retinulation" of these cells, as Lankester calls the grouping of them into retinulæ.

We assume, then, that first of all the crystal cones were but slight irregularities in the thickness and refractiveness of the developing cuticle. Under these irregularities, *i.e.*, under those which either concentrated the light or otherwise favoured its passage, the visual cells would naturally tend to group. We say naturally, because it is clear that, under places through which the light but feebly penetrated, the visual cells would be rendered useless. In process of time, certain definite irregularities of the cuticle would be selected and further developed as lenses, &c., for collecting the light. We find in the eye of *Limulus* the particular form of cuticular development which may have given rise to the crystal cones of *Apus* (*cf.* Fig. 22 with Fig. 23). This fact is particularly interesting because we have already seen that *Limulus* has retained the original position of the brain in the bent Annelid. And here we find the same animal supplying a form of eye which shows clearly a possible origin of the Crustacean crystal cones. We have only to assume that such conical processes

of the cuticle as we find in *Limulus* projecting inwards became separated from the cuticle, and thereby, naturally, surrounded by their secreting hypodermis cells, and we have at once the Crustacean crystal cones and cone-cells.<sup>1</sup>

In the eye of *Limulus* we further find visual sensory cells forming groups or retinulæ at the tips of the cones, these latter having been gradually pushed

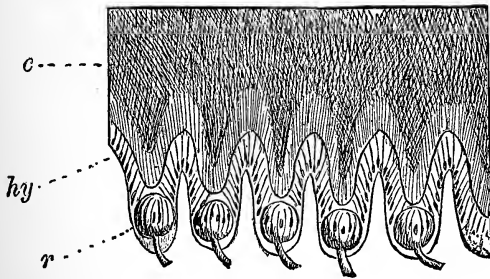

FIG. 22.—Section through the eye of *Limulus* (after Lankester). *c*, cuticle which grows into conical papillæ directed inwards, and pushing down the hypodermis cells (*hy*); at the tips of the cones are found the retinulæ imbedded in connective tissue.

down below the hypodermis into the subhypodermal connective tissue. We find exactly the same in the eye of *Apus* (see Fig. 23), where the crystal cones and the hypodermis cells form the original hypodermis layer, the retinulæ having been pushed down even

<sup>1</sup> Grenacher in his *Sehorgane der Arthropoden* states that the cones in *Limulus* have nothing to do with the Crustacean crystal cones. Our contention here is, however, that some such conicle projections of the cuticle, not necessarily exactly similar to those in *Limulus*, may easily be supposed to have produced the Crustacean crystal cones, by being separated from their cuticle.

below the connective tissue layer. In this way we get the double layer of cells composing the typical Crustacean eye.

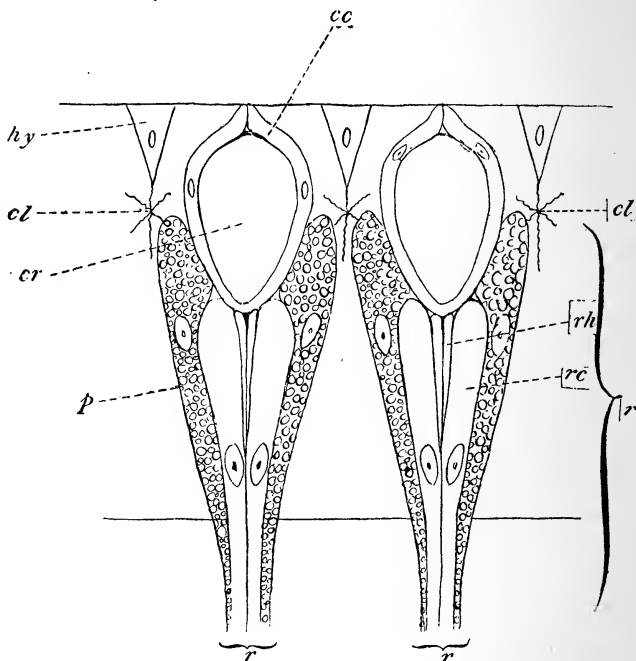

FIG. 23.—Diagram of two single eyes of the paired eyes of Apus. *hy*, original undifferentiated hypodermis cells secreting outer cuticular membrane. *cc*, crystal cone cells = differentiated hypodermis cells secreting the cones (*cr*); *cl*, layer of connective tissue fibres = subhypodermal connective tissue layer; *r*, retinulæ, *i.e.*, groups of sensory (retinal) cells (*rc*), with their rhabdoms (*rh*), and pigment cells (*p*); these belong to the hypodermis, but are thrust down below the subhypodermal connective tissue layer by the cones.

The great advantage of this separation of the cones is not far to seek. The rounding off of the distal ends

<sup>1</sup> See Appendix II. on the pigment in these cells.



of these cones seems one of the simplest methods of obtaining convex surfaces to act as lenses for the reception of the light-rays from all directions. The formation of corneal lenses over these cones is a secondary and, we think, a much more complicated specialisation.

Another possible advantage gained in the separation of the cones from the cuticle is the slight possibility of movement which the separate ommatidia or single eyes would thereby acquire. It appeared clear to us, during our study of the eye of *Apus*, that the separate elements were capable of slight movement, brought about, no doubt, by the layer of connective tissue, which is only indicated by faint lines in the diagram (Fig. 23), but which in reality is very highly developed. The slight attachment of the crystal cone cells to the cuticle would not altogether prevent such small movements as we suppose.

If the Crustacean eye is in this way to be referred to the formation of the exoskeleton, it seems clear that no special value can be attached to similarity of eyes in establishing the relationships between animal groups. The development of an exoskeleton is common to the whole class of the Arthropoda, and there is no reason why very different forms of cuticular irregularity should not be utilised by the visual cells, which would group themselves accordingly in different ways. We thus see no reason whatever for trying to deduce the one form of Arthropodan eye from the other, it being more probable that they are with a few

exceptions independent groupings of the sensory cells under different forms of cuticular irregularities.

Returning to the eye of *Apus*, it is of special interest to find that the eyes of all the Crustacea which we assume to have descended from *Apus* may be referred back to different groupings and modifications of the ommatidia, whose first development in *Apus* we have endeavoured to describe.

The formation of the corneal facets above the crystal cones may be due to a further utilisation of irregularities in the thickness of the cuticle which remains after the separation of the crystal cones. In this way, we think, the gradual development of the Crustacean eye may have gone hand in hand with the thickening of the cuticle to form the exoskeleton characteristic of the class. We have two highly plastic elements, the hypodermis, with its scattered sensory and pigment cells, and the thickening cuticle. We cannot help thinking that it was the latter which, coming between the sensory cells and the source of stimulation, took the lead in the formation of the different kinds of Arthropodan eye.

Before dismissing the subject of the development of the Crustacean eye we feel that some apology is necessary for treating it so shortly and so lightly. We have not attempted to work through the enormous literature on the structure and development of the Crustacean eye.<sup>1</sup> Our object here has been to

<sup>1</sup> While these pages have been passing through the press we have had occasion to read Watase's admirable paper on the "Morphology of the Compound Eyes of Arthropods." It was especially interesting

describe a possible development of the Annelidan eye-spots into simple Arthropodan eyes, that being all that we here need, in our endeavour to show that *Apus* is a very primitive Crustacean, and at the same time but a slightly modified Annelid. What we have here written is a preliminary suggestion as to the probable rise of the Crustacean eye. We hope in another place, and in another connection, to discuss it more fully, dealing especially with the sensory elements and their physiological significance.

Some further morphological details relating to the paired eyes of *Apus* fortunately admit of more satisfactory deduction from the Annelida than does the fine structure of the eyes themselves.

As to their position, we have two remarks to make :

1. We find them on the dorsal frontal surface, whereas in the original Annelid they were on the prostomium. It has already been assumed that, on the fixation of the bent attitude of the five anterior Annelidan segments, they gradually wandered round on to the dorsal surface. There is no great difficulty in this assumption, especially as we have seen, in our investigation of the central nervous system, that the position of the brain and the divided œsophageal commissures indicate that such a wandering of the

to us to find that he had also selected the compound eye of *Limulus* as the nearest type of the primitive Crustacean eye. We do not see what is gained by his assumption of integumental pits. It is not easy to see how the various stages in the development of these pits could have functioned as visual organs.

eyes has taken place. The length of the stalks of the optic nerve, and the secondary drawing out of the longitudinal commissures of the anterior ventral ganglia, point to the same conclusion.

2. We find the eyes close together, *i.e.*, about as near to one another as they probably were on the prostomium. This point is important, because it is often assumed that the eyes of *Apus* have moved together from the sides towards the middle line, whereas, on the contrary, we hold that the eyes of *Apus* have kept about the same distance apart as they were on the prostomium of the Annelid ancestor, and that it is the eyes of the higher Crustacea which wander apart and take up positions at the sides. The gradual reduction of the dorsal shield, in the majority of the descendants of *Apus*, facilitates the wandering to the sides. The case of *Limulus* is particularly interesting. Here, as will be described later, the eyes wandered from the first, not forwards and upwards, but sideways and upwards, so that the brain could not follow as in *Apus*, but, being drawn in two opposite directions, remained where it was, the extraordinary length of the optic nerves showing clearly that the eyes must have wandered considerably.

Almost more interesting, however, are the water-sacs which spread out over the eyes of *Apus*, between them and the integument. These have never, we think, been described before, at least in detail, and here deserve particular attention as lending support to our theory of the migration of the eyes.

Fig. 24 is a diagram of these water-sacs. A small pore, in the shape of a fine transverse slit (see Figs. 24 and 69, p. 303) in front of the eyes, is, in large specimens, visible to the naked eye. This leads

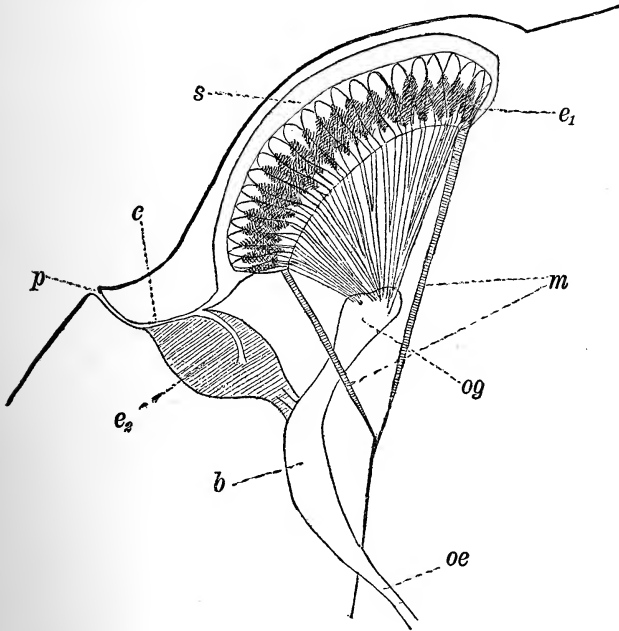

FIG. 24.—Diagram to show the water-sacs over the eyes of *Apus*. *s*, water-sacs; *c*, canal leading into the same; *p*, pore; *e*, paired eye; *b*, brain; *ae*, oesophageal commissure; *og*, optic ganglion; *m*, eye-muscles. The eye is drawn in the section; in reality a median section passing through the pore passes between the eyes; *e*<sub>2</sub>, unpaired eye receiving a branch from the water-canal.

into a canal, which runs along the dorsal surface of the unpaired "eye." Here it widens out considerably, its upper and lower chitinous membranes being in close contact, except in the median line

above the unpaired "eye" (see Fig. 27, p. 105). At the posterior end of the unpaired "eye" it gives off a branch which runs into that organ, as will be described later. The sacs then widen out over the eyes, as shown in Fig. 24.

This water-layer probably facilitates the movement of the eyes by the ring of muscles attached round their rims. It is not improbable that the sacs further serve as lenses, but this cannot be stated with certainty. As for the mechanism by which the water is drawn in and out, a contraction of the whole ring of muscles at once would draw the water in, while a general pressure of the body fluid under the eyes, caused by muscular contractions in other parts of the body, would expel it through the canal.

This whole structure has probably been developed in the following way. The original head showed constrictions between the segments of which it was composed, *i.e.*, folds of the skin projecting inwards. The eyes, in travelling backwards, would necessarily have to pass by these folds. The first fold of all would be that between the prostomium and the first segment. It is clear that the eyes must either be stopped in such a fold, or else carry it back with them. This latter is what we suppose took place at the posterior edge of the prostomium. The eyes came against the fold of the first segment, which generally overlaps the prostomium when the body is at all contracted. Under this the eyes would disappear.<sup>1</sup>

<sup>1</sup> It is clear that while the bending round of the anterior segments would so stretch the dorsal integument as to obliterate all such constrictions.

It would be impossible for them to get further than the posterior end of this fold unless they dragged it after them, and thus, as we suppose, the fold has travelled backwards with the eyes, the front part gradually closing, till only a fine transverse slit is left.

This derivation of the water-sacs receives some support from the ring of muscles round the eyes, which are clearly bands borrowed from the longitudinal musculature. Their sinewy attachment joins the large muscle which runs down from near the eyes to be attached near the prostomium. A comparison of Fig. 24 with Figs. 12 and 13, p. 56, makes the origin of the eye muscles very evident. As the eyes, which are hypodermal structures, travelled backwards, dragging an intersegmental fold back with them, they naturally took along with them some of the longitudinal muscle bands attached to that fold. This accounts for the way in which a hypodermal structure, such as the original Annelidan eye, became an independent organ, movable by a special and apparently highly developed system of muscles.

The development of the stalked eye from the eye of *Apus* appears to us by no means such a simple matter to understand. We are inclined to think that it may have taken place in two different ways: (1) By the gradual projection of the eye itself above the surface of the body (we find such projections of the eye stalks in many Trilobites). (2) By the tions between them, this would not be the case with the fold between the prostomium and the first segment. The labrum of *Apus* was probably at first a movable organ.

gradual diminution of the shield and head, and the sinking in of the sides of the latter till the eyes, with their cones of long muscle-bands (*cf.* Fig. 24, *m*), became movable lateral ridges running dorso-ventrally. Their gradual complete articulation at their bases would then easily follow. This method of transforming the eyes of *Apus* into movable stalked eyes is well exemplified in *Branchipus stagnalis*, which is nearly related to *Apus*. The head region seems in it to be reduced to a small base for carrying the enormous second antennæ and the stalked eyes.

#### THE UNPAIRED "EYE."

This organ, which is just visible as a dark spot between the paired eyes of *Apus*, is often called the "rudimentary median eye of *Apus*." Closer study of it, however, reveals that it is a highly developed sensory organ with definite functions of its own. In describing the water-sacs over the eye, we have already had occasion to refer to it, and we there found that through the canal which leads into these water-sacs its interior is also in open communication with the external world, that is, if the chitinous fold which runs into it is really open at the end. It is better to defer a discussion as to the use of this organ until after an examination of its general structure and probable origin.

Beyond the account of the middle eye of a Copepod by Grenacher, this organ has received very little



attention. It is generally referred to as the x-shaped eye-spot which occurs throughout the Entomostraca, but disappears during larval life in the Malacostraca. It is, as a rule, so small, that investigation of its finer structure is difficult. In *Apus*, however, the unpaired eye is so large that its finer details are made out with comparative ease. This fact is especially important from our point of view, for if *Apus* is really the (or a) primitive Crustacean, then all the unpaired eyes throughout the whole class are in all probability only modifications of that of *Apus*. Hence it is necessary, for a comparative study of these organs, to have some accurate knowledge of their original form. We feel justified in assuming that this organ in *Apus* is in its original form, not only because *Apus* has retained so many primitive (*i.e.* Annelidan) characteristics, but because, as will be described below, this form gives us a clue as to the origin of the organ out of an anterior pair of Annelidan eye-spots. In these pages we must of course confine our attention exclusively to the unpaired eye of *Apus*, describing in order (1) its general structure; (2) its probable origin; and (3) its present functions.

*Structure.*—Two groups of sensory cells, each forming what is in this connection generally called a retina, yield the two side walls of a cavity which is flat at the top and rounded below. The top consists of the chitinous fold, already described as forming the water-sac, while the lower part hangs free in the body cavity. Anteriorly, the cavity runs to a point along the water-canal (see Fig. 25); posteriorly, it ends in a blunt

point very nearly abutting on the brain. The posterior wall of the cavity and the posterior half of its floor are also composed of somewhat similar retinæ. The

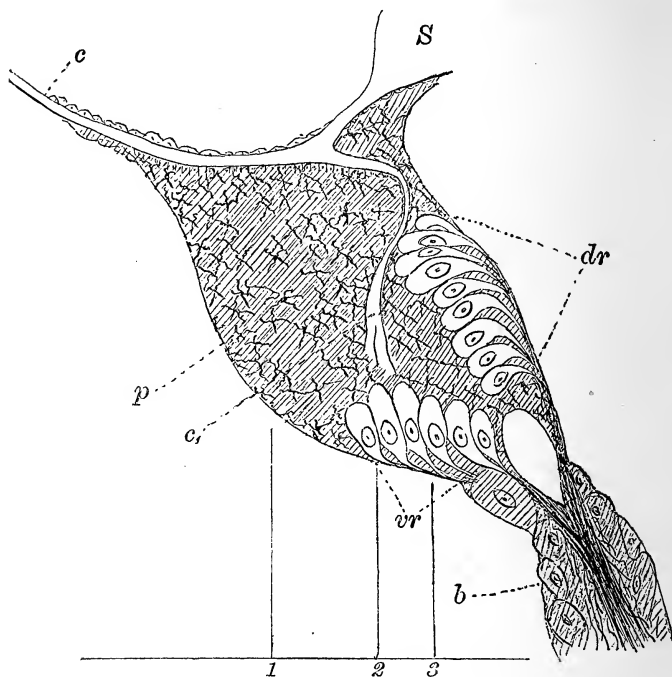

FIG. 25.—Longitudinal median section through the unpaired "eye," diagrammatic. *vr*, ventral; *dr*, dorsal retina; *p*, tangle of pigment cells; *s*, water-space over the eyes; *c*, canal of the same, giving off a branch (*c*<sub>1</sub>) into the interior of the organ; *b*, brain.

sensory ends of all these retinal cells point inwards; the nerves from the outer ends of the cells unite together to run towards the brain, forming from the four retinæ four nerve strands on which the un-

paired "eye" seems to stand on the brain, as on four stalks, between the stalks of the optic ganglia. The stalk of the ventral retina is distinguished by the presence of several enormous ganglion cells, apparently the largest in the whole nervous system of *Apus*.

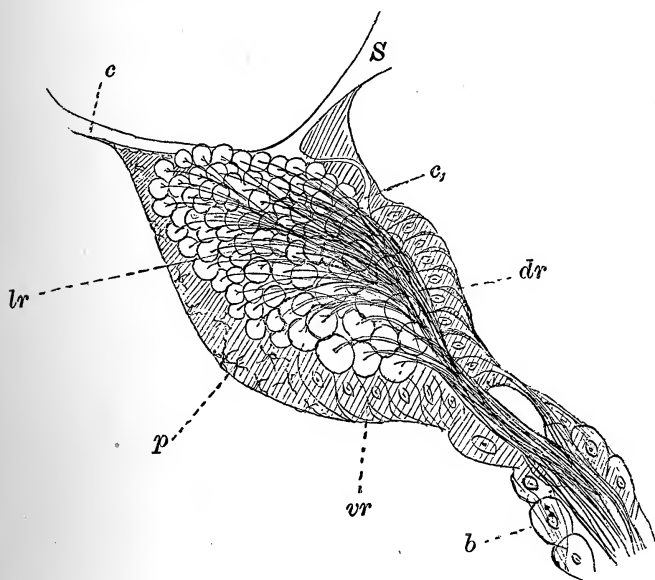

FIG. 26.—Lateral view of the unpaired "eye," diagrammatic. *vr*, ventral; *dr*, dorsal; *lr*, lateral retina; *b*, brain; *S*, water-space; *c*, canal of the same; *p*, tangle of pigment cells. Only the outer ends of the lateral retinal cells can be seen.

A cross section of the posterior end of the organ looks to the naked eye like an X. The retina, bulging in somewhat towards the interior of the cavity, give its lumen this form. (See Fig. 27, 3.) The pigment cells which fill the cavity form a tangle of

pseudopodia without any apparent arrangement. They contain the same minute olive green pigment granules as the other pigment cells, which spread out in great numbers over the subhypodermal connective tissue layer throughout the body. This, however, is not always the case ; some specimens had brown pigment in large granules like those of the paired eyes. Some of the pseudopodia penetrate a long way between the retinal cells, and, at the surface of the organ where there are no retinal cells, the pigment cells with their long processes form together the external surface, the whole structure having apparently no enclosing membrane. The pigment cells, in fact, are nothing more than a plexus of the ordinary pigment cells which spread out irregularly throughout the whole body, among the subhypodermal connective tissue.

In a well-preserved specimen, in which the pigment did not happen to be very dense, the cells were seen to send down processes towards the inner sensory ends of the retinal cells. As these processes were regularly arranged, and free from pigment, it was difficult at first to decide whether they belonged to the retinal or to the pigment cells. We mistook them at first for large cilia belonging to the retinal cells.

It will be seen from the drawings that the retinal cells are not all of the same size. The lateral retinae are composed of two distinct groups, an anterior group of long narrow cells, and a posterior group of short thicker cells. The ventral retina is composed solely of large thick cells, and the dorsal of two groups of

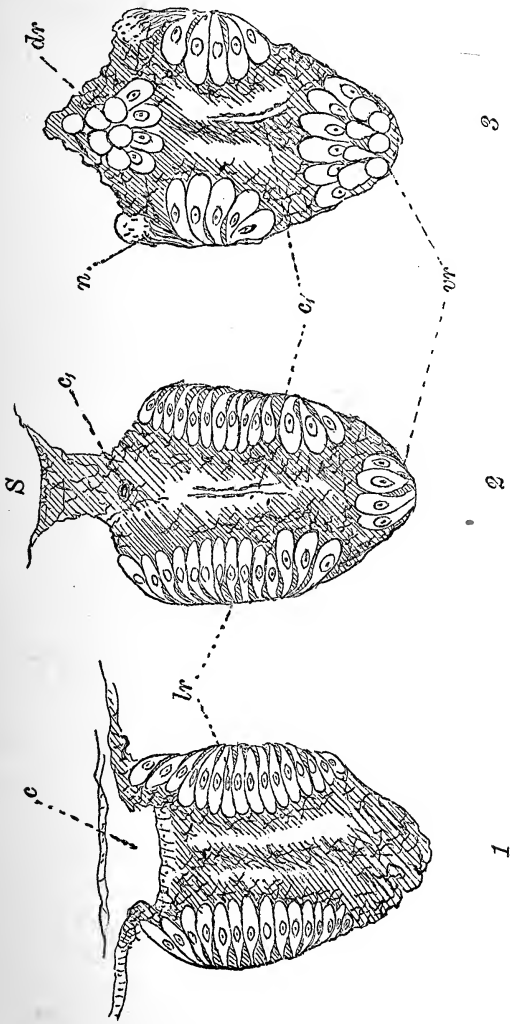

FIG. 27.—Three transverse sections through the unpaired "eye," along the lines 1, 2, 3 in Fig. 25, diagrammatic. Lettering the same as in Figs. 25 and 26. *n*, nerve from the anterior part of the lateral retina (*cf.* Fig. 26).

similar large cells, the smaller group placed dorsally and slightly anteriorly to the other.

As already described, a fine branch of the water canal, on which this sensory body is suspended, runs in towards the angle made by the dorsal and ventral retinae. This fine canal is shown in Fig. 25 and in sections 2 and 3, Fig. 27.

This structure of the median eye seems to be common to all the specimens of the different species of the Apodidæ examined by us. In series of sections the organ is very likely to be displaced by the tearing away of the chitinous tube. On this ground it would require a much more extended study to ascertain whether arrangements which sometimes appear to be characteristic of the organ in the different species are not really due to defects in the preservation of the animals or in the preparation of the sections.

Enough has here been said as to the general structure to bear out what we maintain—viz., that the unpaired eye is no rudimentary organ, but in reality a highly developed sensory body playing a most important part in the life of the animal.

*Origin.*—As to the probable origin of this organ, everything points to its having been originally composed of an anterior pair of eyes on the Annelidan prostomium. The two posterior eyes formed the paired eyes, the two anterior, which were nearer together than the posterior pair, united to form the unpaired eye. The evidence in favour of this origin seems to us to be overwhelming.

When the paired eyes travelled into the end of the

fold as already described, the anterior pair followed them, and also disappeared under the fold, but, naturally, nearer the opening. While the paired eyes, perhaps with the aid of the water lenses, remained functional as eyes, the anterior pair of Annelidan eyes seem to have been dragged out of their hypodermal

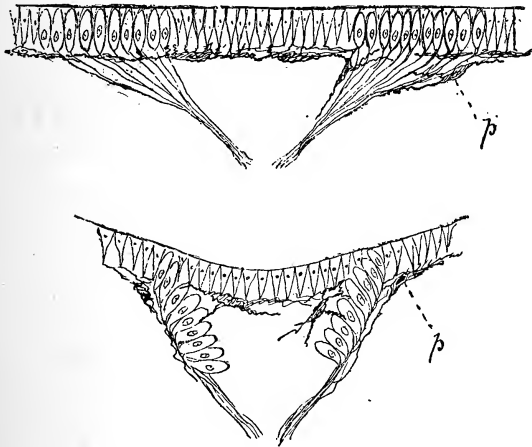

FIG. 28.—Diagram to show the origin of the unpaired eye out of two eye-spots, the retinae being drawn down to form the lateral retinae of that organ. *p*, pigment cells. The pigment in the eyes is not drawn.

position, and to have been arranged so as together to form the cavity already described. The hypodermis cells can still be seen secreting the chitinous membrane of the under side of the water-sac. The retinae now forming the unpaired eye seem to be connected with the original hypodermis only through fine connective tissue and pigment strands, similar pigment cells also

crowding between the retinae. Fig. 28 is a diagram to show the way in which we suppose the unpaired eye to have been formed out of a pair of simple hypodermal eyes. Further investigation must decide whether the dorsal and ventral retinae and the larger posterior cell groups of the lateral retinae are later differentiations of the same two original eyes or new developments. In the inner ends of the retinal cells, *i.e.*, in that part of the cells which points inwards, irregular roundish or oval refractive bodies of different sizes are found ; these are probably remains of rods or rhabdomeres originally secreted by these retinal cells.

The whole structure of the organ, its apparently loose connection with the hypodermis, the chitinous fold which runs down as a branch from the water-canal into its cavity, the occasional occurrence of brown eye pigment instead of the olive green connective tissue pigment, the nerves of its retinae running separately into the brain, all tend to support the above view of its origin (*cf.* also p. 169).

Further corroboration of this theory of the origin of the unpaired eye from the anterior pair of Annelidan eyes will be found in the section on *Limulus*. In that animal the anterior Annelidan eyes remain as eyes, but are reduced to ocelli, or eyes with one single large cuticular lens. These ocelli first appear, according to Packard, *on the ventral surface*, and wander on to the dorsal surface in the course of the later development.<sup>1</sup> This astonishing fact receives its full explanation if we

<sup>1</sup> We shall also find clear traces of a migration of the eyes in the Crustacean *Nauplius*, § xi. Figs. 36 and 37, p. 158.



admit the relationship between *Limulus* and *Apus*, and deduce them both from the same bent Annelid, in which the eyes wander from the prostomium, where they are useless as eyes, to a position where they can function as such. In Part II. we hope to show that the derivation of *Apus* and that of *Limulus* from the same bent Annelid stand or fall together.

*Function.*—As to the function of the unpaired eye, we can perhaps with some certainty conclude that in *Apus* at least it regulates the position of the body in the water. Its structure out of four sensory retinae at once suggests such a function, while further, the loose tangle of pigment cells would constitute a body free to be acted on by the earth's attraction. The organ is perhaps rendered more perfect by the rounded arrangement of the retinal cells, which thus present many different surfaces to appreciate the movement of the mass of pigment cells under the action of gravity.

It is difficult to ascertain for certain whether the chitinous canal *opens* in the cavity of this sensory organ or not. If it opens in the cavity to fill it with water we should rather expect to find a more definite membrane round the whole organ. If, on the other hand, it does not open, it may be a structure for the appreciation of changes of pressure, *i.e.*, of depth. The end of the tube as shown in Fig. 27 (2 and 3) is irregular, and in section seems as if it might be a loose empty sac. As the outer pressure increases, such a fine membranous sac would be the first part of the body to feel it, and would commence to swell. But such an appreciation of changes of pressure

could also no doubt be equally well effected if the canal were open, the increase of pressure leading to a rush of water into the cavity. Further, whether the canal is open at the end or closed, it would serve well for enabling the animal to have a rapid perception of changes of temperature in the water, the inlet of cold water acting at once on the pigment cells.

We may perhaps find some confirmation of our supposition that this sensory body fulfils various functions, in the fact that there are at least two kinds of retinal cells. The diagrams in Fig. 27 show not only differences in the forms of the cells, but also different groupings of the cells. The end of the canal is shown close to the posterior groups of short thick cells.

We have thus a comparatively simple but extremely useful organ, probably adapted for the immediate appreciation of the changes of depth and temperature in the medium in which the animal lives, and further for regulating its position in the water. The Apodidæ are, from all accounts, invariably excellent swimmers. Keeping the ventral surface of the body uppermost, they dive occasionally with great rapidity, rising again to skim along just below the surface of the water. Some organ to regulate such definite movements is clearly necessary.

That this is at least one of the chief functions of the organ is rendered probable by its early appearance in the Nauplius larva. The powerful rowing limbs of this free-swimming larva render some directive body necessary ; hence the appearance of this organ along

with the rowing limbs, and long before the paired eyes are developed or needed. It is also worth noting that the unpaired "eye" is especially characteristic of most small free-living Crustacea such as the Ostracoda, Cladocera, and non-parasitic Copepoda.<sup>1</sup> In some of these animals the organ probably combines rudimentary visual with directive sensory functions, the visual function being secondarily acquired, as there can be little doubt that it has entirely ceased in *Apus*.

This view of the function of the unpaired eye, by explaining its early appearance in the larva, makes it unnecessary to suppose that it is, as is generally assumed, therefore phylogenetically older than the paired eyes. On the other hand, its appearance in the larva of all Crustacea rightly leads to the conclusion that it was present in the original racial form of the class. According to our theory, *Apus* being the ancestor of the majority of the modern Crustacea, the unpaired eye appeared for the first time as such in *Apus*.

A further and more exact study of this interesting organ in *Apus*, and a comparison of it with the homologous organs in other Crustaceans or Crustacean larvæ, is very desirable. It is impossible here to follow up the matter further, as it would lead us too far from the main subject of the book, which is an endeavour to show how every single organ of *Apus* admits of more or less easy derivation from similar or dissimilar organs of a carnivorous Annelid.

<sup>1</sup> Some of the differences between the unpaired eye of *Calanella* described by Grenacher, and that of *Apus* will be referred to in § XV.

## SECTION VII

### THE ALIMENTARY CANAL

ALTHOUGH it is not, as a rule, possible to draw any conclusions as to the relationship between animal groups from the similarity of their alimentary canals, yet the likeness between the digestive tract of the Apodidæ and that of the Annelida is so striking that it must be admitted to be of some weight in establishing the relationship which this book seeks to prove. Allowing for the bend in the œsophagus, the alimentary canal runs straight through the body from end to end, and the mid-gut is lined by the thread-like ciliated epithelium characteristic of that of the Annelida.

The bending of the first five segments of our Annelid, so that the mouth not only lies ventrally but faces posteriorly, necessarily led to a bend in the alimentary canal, so that, from the mouth, the œsophagus would slope upwards and forwards. We find that it has this position in the Apodidæ, and from the Apodidæ it has been handed on to the

whole class of the Crustacea as one of their most constant characteristics. It is not easy to imagine a simpler or more likely explanation of this extraordinary bend in the intestinal tract than that here given; and if it is true, its importance for the purposes of classification is at once evident. We shall return to this subject in the section on the relations of *Apus* to *Limulus* and to the Trilobites.

The œsophagus itself corresponds with that of the original Annelid, which was probably provided with a protrusible pharynx. The loss of this proboscis would naturally follow on the adoption of a browsing manner of life, and the gradual adaptation of the parapodia as instruments for pushing food into the mouth. The œsophagus is very muscular, and is provided with muscle bands radiating forwards into the forehead, and backwards into the sinewy mass already described. These bands serve to dilate it, while its powerful circular muscles close it; when closed it is thrown into folds. The dilators may perhaps be the remains of the retractors and extensors of the pharynx. The œsophagus is lined by a chitinous intima and provided with setæ which project upwards so as to form a fish-trap apparatus. The paired glands which open on the under lip close to the mouth (see Fig. 29) will be described in the section (IX.) on the excretory and other glands.

The œsophagus is in *Apus* comparatively simple, but it is easy to see how a part of such a muscular apparatus, with its chitinous intima folded, and thrown into strong movement by every act of swallowing,

might become differentiated into a masticatory stomach, such as we find in the higher Crustacea. No such differentiation is, however, visible in *Apus*. In *Limulus* we shall find the chitinous ridges used for masticatory purposes in what is called the pro-ventriculus, which is homologous with the masticatory stomach of the higher Crustacea.

The œsophagus projects somewhat into the mid-

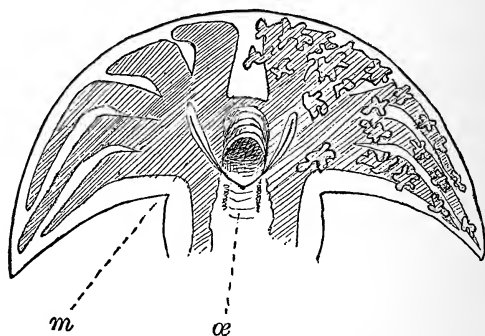

FIG. 29.—Diagram of the branched diverticula of the anterior end of the mid-gut (*m*), on the left without the glandular (hepatic) branched cœca, on the right a few of the latter are drawn. *æ*, entrance to the œsophagus, on each side of which are seen two long glands opening together in the middle line, assumed to be the acicular glands of the vanished parapodia of the first antennal segment.

gut, which is a large sac with lateral diverticula—five or six on each side; these unite, in *Apus*, to enter the mid-gut together (Fig. 29). These diverticula fill up the large flat head widened by the ridge running round the frontal region, as already described. Diverticula of the mid-gut are common among Annelids, and serve to increase the digesting surface.

The diverticula of *Apus* are especially interesting

as showing a perfect transition stage between the simple digesting diverticula of the Annelids, and the hepato-pancreatic glands of the higher Crustacea. In *Apus*, particles of food are found in all the wider parts of the diverticula which, like the rest of the mid-gut, are lined with ciliated epithelium. Smaller branching invaginations from these diverticula (see Fig. 29) contain large glandular cells, which occur in great numbers towards their tips. The secretion of the glands is no doubt forwarded by the ciliated epithelium, which is everywhere present when not entirely displaced by the glandular cells. In the preserved specimens this secretion formed brown crystals.

In order to turn these digesting diverticula, provided with glandular cells at their branched distal ends, into the lobate hepato-pancreas of the higher Crustacea, we have only to imagine the glandular cells increasing so as entirely to displace the ciliated digesting epithelium, and the lumen of the diverticula themselves narrowed to form glandular ducts.

In *Astacus*, where the mid-gut has almost entirely disappeared, these diverticula are highly developed tassel-like hepato-pancreatic glands. *Apus* supplies us with a perfect transition stage, showing the origin of these livers out of the digesting diverticula of the Annelidan mid-gut.

The epithelium of the mid-gut, like that of the diverticula, is composed of minute thread-like cells with nuclei near their basal ends. They stand on a basal membrane, round which run at short intervals

fine circular bands of transversely striated muscles. We find here a striking resemblance with the mid-gut of many carnivorous Annelids.

The mid-gut passes gradually into the hind-gut ; it is very difficult to fix upon the exact place where the chitinous intima of the latter commences. In passing from one to the other, the muscular layer is more and more developed ; the epithelium gradually changes, becoming more and more a glandular epithelium, with large round glandular cells arranged in great numbers, and pouring their contents through pores<sup>1</sup> in the chitinous intima into the hind-gut. From the position of these glands we are fairly safe in concluding that they are excretory.

In the anal segment the rectum is attached to the body wall by radiating muscles, which act as dilators, while the strong circular muscles keep it closed. As in the œsophagus, the wall of the rectum is thrown into folds, which run longitudinally. The anus is situated at the extreme end of the body under the caudal plate, where such a plate is present, and between the caudal cirri or cercopoda.

<sup>1</sup> The actual existence of these pores we have not, however, been able to demonstrate.



## SECTION VIII

### THE CIRCULATORY SYSTEM

THE actual blood-vessels in Apus are limited to the long dorsal vessel or heart. Although, among the Annelida, circulatory systems are found of many different grades of development, it is not necessary to suppose that our original Crustacean-Annelid had a very simple blood vascular system, in order to account for the above fact. It seems to us probable that the development of an exoskeleton, which holds the organs in their places, and protects the inner parts generally from being squeezed together, renders special blood-vessels more or less unnecessary, the blood being able to bathe all the organs of the body without difficulty. On the other hand, this is not the case in a soft-skinned strongly contractile body, such for instance as that of the leech, where it is necessary to carry special blood streams between the organs which are liable to be crowded together. If then our original Crustacean-Annelid possessed a highly developed blood vascular system, it would naturally, with

the development of the exoskeleton, give place to a simple lacunar system as sufficient for the needs of the body, the only vessel retained being the contractile dorsal heart, necessary for propelling the blood through this lacunar system. It may be objected that the trunk of *Apus* under the shield has a soft skin, and nevertheless the blood system in this part is entirely lacunar. The trunk is, however, not very contractile, and although the blood flows through lacunæ, there are definite methods of propelling it through the intestinal sinus, which will be mentioned later on.

It is clear, then, that the absence of nearly all true blood-vessels from the circulatory system of *Apus* makes any comparison of it with that of an Annelid impossible. Apart, however, from the dorsal vessel or heart, which is generally recognised as an organ derived from Annelidan ancestors, there is, in *Apus*, a slight trace of a pair of typical Annelidan vessels; these are the short vessels which supply the shell glands. (See Fig. 30, p. 125.) They branch off from the dorsal vessel on each side, and descend towards the dorsal parapodia of the second pair of maxillæ, to dip under the shell gland. They are necessary for conducting the blood into the shield in which the coils of the gland lie. They may be homologous with a pair of lateral arteries from the dorsal vessel of the fifth segment, such as typically supply the parapodia and sides of the body in a carnivorous Annelid.

Attention must be drawn to the tapering away of the heart to a point towards the posterior end of the

body. This is in keeping with our general explanation of the morphology of the body of *Apus*. As we go from before backwards, the organs are less and less developed, the limbs are more and more rudimentary, and the musculature less and less specialised; the nervous system ceases where the rudimentary limbs cease, and the genital organs gradually diminish in size and development. The heart is no exception; it tapers away in about the tenth or eleventh segment into a point, not being developed in the more larval segments which come behind.

We may also perhaps mention that the blood in many, if not in all *Apodidæ* is coloured red, as is the case in many *Annelids*. The direction of the blood through the body is the same as in the *Annelids*—dorsally from behind forwards, ventrally from before backwards. On its way back through the intestinal sinus, which will be presently described, it streams out ventrally through fenestræ in the membrane which forms the sinus. (See Fig. 14, *m*, p. 59.) It is thus enabled to stream over the ventral cord, and then outwards on each side along the ventral side of each limb. At the end of the limb it turns round to run back along its dorsal edge and thus passes through the gills. It passes up thence through the lateral dermo-muscular sinus of each segment into the pericardial sinus, and thence through the ostia into the heart.<sup>1</sup>

We have now to try and trace the origin of the

<sup>1</sup> As this account differs from that of Zaddach, a fuller description with illustrations will be given in Appendix III. p. 296.

lacunar system of *Apus* more in detail. Its main features are very simple, and in this respect it shows a primitive character. In the main it may be said to consist of but one membrane, forming a tube which runs from the anterior end of the first trunk segment (where it is attached all round to the body wall) to the end of the body. This membranous tube surrounds the intestine and genital glands, while between it and the body wall lie the heart, the ventral cord, and all the musculature, except the dorso-ventral bands which run between the intestine and the genital glands. (See Fig. 14, p. 59; *cf.* also Fig. 66, p. 297.) The membrane is attached to the body wall, at least in the first eleven trunk segments, by segmental dissepiments, which correspond with the segmental constrictions of the body. These dissepiments extend dorsally to the points of attachment of the dorso-ventral muscles, which raise up the membrane in conical folds. Between these dorso-ventral muscle rows the membrane hangs free of the dorsal body wall, thus forming the cardinal sinus, in which the heart is expanded by an arrangement of connective tissue fibres.

In trying to trace the origin of this membrane and these dissepiments (see Fig. 67, *s*, p. 298) from the internal organs of the original Annelid, we naturally begin with the latter, as reminding us at once of the Annelidan septa. Are they the remains of such septa? The answer depends on the interpretation we give to the membrane forming the intestinal sinus.

Glancing at the membrane then as a whole, as a

tube running through the whole trunk outside of the dermal musculature, and containing the intestine and the genital glands, its origin is at once suggested to us. It appears to be the parietal layer of the cœlom epithelium of the original Annelid, loosened from the body wall except at certain definite points, viz., where it is in contact with the ventral muscle bands, and laterally along the segmental constrictions, where it remains attached by means of the septa above mentioned, each of which extends dorsally as far as the point of attachment of the dorso-ventral muscle bands. (See Figs. 66, p. 297, and 67, p. 298.)

In this way we should at once get just such an intestinal sinus as we find in *Apus*, viz., a membranous tube lying just inside of the dermal musculature, the transverse dorso-ventral muscles being almost the only muscles found within the tube. Indeed the relation of the membrane to these muscle bands seems to support this view, for where these are attached to the dorsal surface, the membrane itself is raised up into conical folds in the manner illustrated in the diagram (Figs. 14, p. 59, and 66, *p*). This certainly looks as if the membrane had, as it were, fallen away from the integument. If this view is correct, the intestinal sinus corresponds with the body cavity of the original Annelid, and the dermo-muscular sinus of each segment is a new formation caused by the loosening of the epithelium from the body wall.

The dissepiments themselves may be folds of this membrane grown together. If so, these partial dissepiments must have been secondarily acquired, after

the original Annelidan dissepiments had disappeared. There is no great difficulty nor, indeed, improbability in such a supposition. We may indeed find in these dissepimental folds, attaching the membrane to the body wall, traces of the former presence of the old Annelidan septa, which may have originally run in between the folds just as the transverse dorso-ventral muscles run up into the conical folds of the membrane, as already described and marked  $p$  in the figures.

If this latter view is correct, we then explain the origin of the lacunar system of *Apus* by the loosening of the cœlom epithelium from the heart and from the dorsal surface in the immediate neighbourhood of the heart so as to form the longitudinal cardial sinus. On each side of this sinus laterally it remains attached to the intersegmental folds, being loosened, however, from the segmental walls, so as to form the lateral segmental dermo-muscular sinuses, which conduct the blood from the gills to the cardial sinus.

The separate stages by which this lacunar system took the place of a blood vascular system, are not difficult to imagine. The first step in the transformation would be the gradual degeneration of the separate blood-vessels and the consequent mingling of the blood with the body fluid or lymph. The disappearance of the vessels supplying the dermal musculature, and the general diffusion of hæmolymp between the integument and the cœlom epithelium might very easily lead to the loosening of the latter from the integumental musculature, excepting along

the intersegmental folds, across which the dermal blood-vessels of the original Annelid did not run (?). These two modifications, (1) the degeneration of the blood-vessels, and (2) the loosening of the peritoneum from the body walls, are all that is needed to produce the lacunar system of *Apus* from the blood vascular system of an Annelid.

The contrast between the circulatory systems of the Annelida and of the Apodidæ does not therefore stand in the way of the acceptance of our theory of their close relationship. Apart from the well-known fact that, among the Invertebrata at least, blood vascular systems have little morphological value, we have here shown how simply the lacunar system of *Apus* can be deduced from the blood vascular system of an Annelid.

We reserve any further discussion of the cœlom epithelium, a part of which has been here used up in the formation of the lacunar system, till we come to the genital glands, when we shall again see what an important part it has played in transforming the Annelid into the Crustacean. (See further p. 169 and Appendix III.)

## SECTION IX

### EXCRETORY AND OTHER GLANDS

*The Shell gland.*—THE most conspicuous glands of the Apodidæ, the long coils of which are seen in the shield, one on each side of the middle line, are known as the shell glands. These are generally homologised with the Annelidan nephridia.

From Figs. 1 and 2 it will be seen that we have assumed that the acicular gland of the dorsal parapodium of the fifth segment became excretory, and grew into the growing shell fold, thus forming the shell gland. The position of its external opening, at the tip of the dorsal branch of the second maxilla, agrees exactly with this supposition. The distal end of it is a chitin-lined sac running through the shaft of this limb.<sup>1</sup> The proximal end of the gland has grown into the shield, and is of great length, being folded six times upon itself. That the inner part of the gland has grown upwards, and the limb bent downwards, can be seen by the course of the duct of

<sup>1</sup> See Appendix IV. for the finer structure of the gland.



the gland which, on leaving the shell fold, makes a sudden sharp bend downwards. We thus consider this shell gland as a striking link between our Annelid and Apus. The mesoblastic origin of the urinary canal may mean that this section of the gland is a

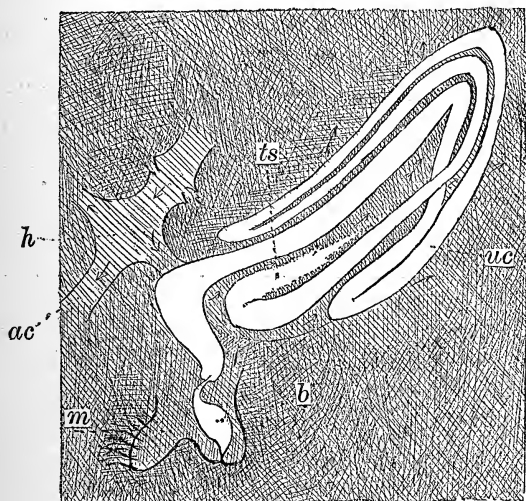

FIG. 30.—Diagram of the shell gland. *h*, the heart; *ac*, the aorta cephalica. The blood is distributed to the gland through a special vessel on each side. *ts*, terminal saccule; *uc*, urinary canal; *b*, chitin-lined bladder in the shaft of the dorsal parapodium of the 2nd maxilla (*m*), homologous with the original setiparous gland of the Annelid.

new formation,—the bladder alone representing the acicular gland.

This homology of the Crustacean shell gland with the acicular gland of the fifth parapodium of the Annelid, naturally leads us to ask whether the acicular gland of any other of the head limbs has been pre-

served. The mandibles and first maxillæ have lost their dorsal parapodia almost entirely, and with them all traces of setiparous glands. The antennæ, however, are in this respect especially interesting. We have homologised them with the sensory cirri of the vanished or rudimentary dorsal parapodia of the first two segments. The acicular glands of both, however, have apparently been preserved in the Crustacea.

*The Acicular gland of the first segment.*—There is a pair of glands (salivary?) opening near the entrance of the œsophagus (Fig. 29, p. 114). We think that these belong almost certainly to the first antennæ;<sup>1</sup> they open together in a small transverse

<sup>1</sup> We were at first inclined to think that these "salivary" glands were the acicular glands of the parapodia of the second antennæ, there being no antennal glands in Apus. Their opening in the mouth could then be explained as follows:—When the Annelid first took to browsing, its ventral parapodia near the mouth would not as yet have developed teeth. The acicula of the antennal parapodia might then have been used as piercers and killers of prey. They would thus be turned inwards towards the opening of the mouth, where their glands might persist as salivary glands after the development of the ventral parapodia of the third and fourth segments into jaws and maxillæ had rendered the acicula useless as teeth. It seemed to us more likely that the acicula of the parapodia of the second segment would be so used, than that the acicula of the vanished parapodia of the first segment should redevelop for that purpose. We have to choose then between the following:

(1) These salivary glands are the acicular glands of the parapodia of the second antennæ, the acicula themselves having once functioned as teeth; this homologises them with the typical antennal glands of the Crustacea.

(2) They are the acicular glands of the vanished parapodia of the first antennæ which had redeveloped their acicula as teeth.

(3) They are the acicular glands of the vanished parapodia of the first antennæ which, *as glands*, need never have disappeared. While we think the oral position of the opening of the glands is better explained

fissure on the inner side of the under lip, almost within the mouth. Their whole structure indicates that they are acicular glands. The ducts are long chitinous tubes which lead to a chitin-lined sac with a very fine epithelium, their proximal ends being attached to the body wall by muscle bands just as are the setiparous sacs in the Annelids. The figure shows the course of these long glands. What the exact function of the two glands, opening together in the mouth, may be, it is impossible to say. In all preparations they are found to be strongly contracted, so that the chitin-lined lumen is to be seen only with difficulty.

These "salivary" glands, developed out of acicular glands, are especially interesting as compared with the salivary glands of *Peripatus*, which have been shown to be transformed nephridia. In both cases the openings of the glands have united in the middle line. In both cases we have to assume that, the acicula or the secretions of their glands on the one hand, the excretion from the nephridia on the other, assisted the jaws in their alimantal functions as the first step towards their differentiation into salivary glands.

*The Acicular gland of the antennal parapodia or Antennal gland.*—In *Apus* we could find no certain trace of an antennal gland at the base of the second antennæ; a slight indentation on the basal swelling seemed, however, to indicate that there had been

by the early use of the acicula as teeth, which would make our choice fall between 1 and 2, we think the last view is the most probable, although we do not reject the second alternative.

an opening. Its redevelopment in the higher Crustacea is paralleled by the redevelopment of the dorsal parapodia of the mandibles, although the latter had disappeared in *Apus*. It is a well-known principle that organs which have disappeared may reappear in the descendants of those who have learnt to dispense with them.

The absence of the antennal gland in *Apus* is perhaps to be explained by the enormous size of the shell gland. In one specimen of *L. Spitzbergensis*, 11 mm. long to the tip of the caudal plate, the coils of the shell gland on each side measured over 25 mm. Such an enormous gland would no doubt be able to undertake the greater part of the excretion of the body.

We have thus, in the Crustacea, three setiparous glands preserved in the head: the salivary (?) gland of the first antennæ (in *Apus* at least), the antennal gland, and the shell gland of the second maxillæ.

The antennal glands as well as the shell glands are generally homologised with the Annelidan nephridia. From the foregoing account of the origin of these glands we repeat the following points, which must render such a homology improbable.

(1) The position of the external opening is on the *dorsal* parapodium,—an unlikely place for the opening of a nephridium, but, on the other hand, quite a proper place for the opening of an acicular gland.

(2) The structure of the glands as we find them (in *Apus* at least) is exactly that of setiparous glands.

A long chitin-lined duct opens into a similarly lined vesicle.

(3) In the "salivary" gland the chitinous sac ends blindly, the end being fastened by muscle bands to the body wall, exactly as is a setiparous gland of the Annelata. In the shell gland, however, the sac or bladder is continued into a long coiled urinary canal.<sup>1</sup> The position of this urinary canal in the dorsal fold, and the finer structure of its walls, seem to indicate that at least this part of the gland is a new formation. It in no sense reminds one of an Annelidan nephridium.

(4) These arguments are especially strong if the rest of our argument holds good, viz., that *Apus* is but a slightly transformed Annelid, or, indeed, if we only claim what is often admitted, that the Phyllopods stand nearest the racial form of the Crustaceans. If even this latter alone is the case, the shell gland of *Apus*, if a true nephridium, should show more likeness to a nephridium than do the shell glands of the higher Crustacea, which have departed further from the Annelidan type. We should expect the shell gland in *Apus* to be a transition form between the Annelidan nephridium and the Crustacean shell gland, just as we found the "liver" of *Apus* to be a true transition form between an ordinary digesting diverticulum such as is common among the Annelida, and the purely glandular hepato-

<sup>1</sup> Grobben says that the whole canal in the antennal gland of *Mysis* is lined with a chitinous cuticle. In *Apus*, however, the intima ceases with the bladder.

pancreas of the higher Crustacea. But this is certainly not the case. Neither in position nor in structure do the glands remind one of Annulatan nephridia, but, on the other hand, they correspond in a most remarkable manner with the acicular glands of the Annelidan parapodia.

(5) We further assume that the habit of browsing of the bent Annelid was originally acquired by the *adult* animals, in which the nephridia in the anterior segments have generally disappeared in the course of development; so that *Apus*, which represents such a browsing Annelid, would probably have no nephridia in the anterior or head segments. In the trunk segments, on the other hand, we shall find abundant traces of nephridia.

These considerations, which, taken singly, do not possess much weight, taken all together make the nephridial origin of these glands very improbable compared with that which we here attribute to them.

Setiparous glands on the trunk segments are hardly to be expected; the dorsal parapodia are developed into complicated limbs covered with setæ, and the ventral parapodia are also thickly beset with setæ of different kinds. We have succeeded, however, in finding two such glands on the same limb in one specimen of *Apus cancriformis* (see Fig. 31). We could find no similar glands on the gnathobase or ventral parapodium of the corresponding limb of the same segment, and only on one other limb. Perhaps further search would reveal more, but it is certain that these glands occur quite irregularly. We are

inclined to consider them as occasional abnormal returns to the Annelidan method of developing the setæ (see pp. 87, 88). When such an abnormal setiparous sac does occur, it would in all probability be utilised for excretory purposes. Chitin itself is probably an excretory product, utilised for protective purposes.

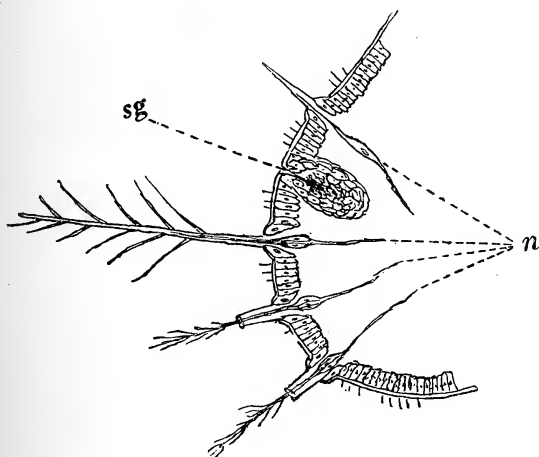

FIG. 31.—Part of a section through the gnathobase of *Apus* mentioned in the text (p. 130), showing an abnormal reappearance of a setiparous gland containing a brown secretion. *n*, the nerves to the hairs; those to the feathered hairs send a fibre into each barb and possess small groups of ganglion cells.

This irregular appearance in *Apus* of glands so obviously homologous with the setiparous glands of the Annelida, as an occasional abnormal return to a former method of developing setæ, establishes beyond all contradiction the usual homology of the leg or coxal glands of the Crustacea with the setiparous glands of the Annelida.

Having so far considered the typical Crustacean glands, the antennal, shell, and leg glands, and homologised them with setiparous glands of the original Annelid, it is necessary, in order to establish the close relationship which we maintain exists between *Apus* and the Annelida, to discuss the typical excretory organs of the latter (*i.e.*, the nephridia), and to endeavour to discover their fate during the transformation of the Annelid into the Crustacean.

Professor Haeckel, in the last edition of his *Natural History of Creation*,<sup>1</sup> characterises the Crustacea as segmented animals without nephridia, and the worms as segmented animals with segmental organs or nephridia, the presence or absence of these latter being the chief characteristic difference. The stress here laid by so distinguished a zoologist upon the nephridia as a class characteristic renders it doubly necessary either to find the nephridia in *Apus*—our primitive Crustacean—or to give some probable explanation of their absence. Although no explanation of the absence of nephridia was immediately evident, we were convinced that it would some day be found. We would not allow that the difficulty of finding a set of organs in *Apus* to homologise with another set in the Annelida—though no doubt serious—could destroy the value of the mass of evidence already obtained as to the relation of *Apus* to the Annelids. This reasoning is further especially applicable in the case of the Annelidan

<sup>1</sup> Ed. viii. 1891, p. 570.



nephridia, whose arrangement in the Annelids themselves is always very variable.

It at first appeared possible that the absence of nephridia in *Apus* could be explained by assuming that in the original Crustacean-Annelid they were developed more in the posterior segments (which is in fact often the case), and that these segments do not attain development in *Apus*, the enormous shell gland sufficing for the removal of waste products from the blood. The weakness of this argument is at once obvious. It is only when all the segments are fairly well developed that the permanent nephridia are limited to the posterior segments. Nephridia or their rudiments are, as a rule, to be found at one time or another in the course of development in all the segments. As the posterior segments attain development, the nephridia in the anterior segments often disappear. Nephridia ought therefore certainly to be found in the developed segments of the trunk of *Apus*, and rudiments of nephridia in the larval segments of which the posterior part of the trunk of *Apus* is composed. Fortunately, we are not driven to take refuge in such a doubtful explanation.

Knowing, on the one hand, that there are no true nephridia in *Apus*, and on the other that in the carnivorous Annelids the nephridia are often the ducts for the transmission of the sexual products, we naturally tried to overcome the difficulty by the aid of the genital glands. The study of these glands soon yielded the desired clue. We have then here some-

what to anticipate a description of the genital glands.

These glands are segmental tubes running dorso-ventrally on each side of the intestine, inside the intestinal blood sinus. They are separated from the intestine only by the incomplete longitudinal dissepiments formed by the dorso-ventral muscle bands described above. The genital tubes commence in the first trunk segment, but become gradually shorter and shorter till they are quite rudimentary in the larval segments of the abdomen; they cease to be developed at all some distance before reaching the last limb-bearing segment. These segmental tubes are branched at each end. At the tips of the branches eggs develop which are found projecting, not into the tube, but *into the body cavity*, as will be more minutely described in the next section; it is, however, important for our argument to mention the fact here.

All the segmental genital tubes on each side are connected together by a longitudinal canal which runs through them all, and acts both as oviduct and shell- or rather shell-secreting gland (see Fig. 32), so that eggs coming dorsally and ventrally from the ends of the branches meet in the middle, and then travel along the longitudinal canal to near the middle of its course, where a descending canal leads to the exterior.

The question is, Can these organs reveal anything about the vanished nephridia? It is obvious that they are not themselves the nephridia; they are

simply tubes formed out of the germ-bearing epithelium. When we turn to the carnivorous Annelids, we find that the germ-bearing epithelium is simply the cœlom epithelium which covers all the internal organs including the nephridia ; the eggs project from this epithelium into the body cavity, and, falling off, ripen in the body fluid (see Fig. 11, p. 54) to find their way out through the nephridia. When we compare this process with what takes place in *Apus*, we find in the latter an epithelium from which the eggs project into the body cavity. (See Fig. 33, p. 144.) Is not this epithelium homologous with the Annelidan cœlom epithelium ? Instead, however, of dropping off into the body cavity, the eggs are drawn back through the epithelium and find their way out through the canals formed by this cœlom epithelium. Are not these canals, then, in some way, the homologues of the Annelidan nephridia ? To the first of the above questions we give an affirmative, to the second a negative answer ; but we arrive at the conclusion that the germ epithelium is the *original cœlom epithelium which covered the nephridia*, and that the canals which it now forms once *contained* the nephridial canals through which the eggs found their way to the exterior. In course of time, the nephridial canals ceased to have any excretory function owing to the sufficiency of the shell gland, and disappeared, leaving only their coverings of cœlom epithelium, which, in proportion as the canals degenerated, itself developed into the pronounced epithelium of the genital glands. The development of the longitudinal canal also out of

the cœlom epithelium presents no difficulty, as this epithelium, on the degeneration of the Annelidan septa, would naturally form such a continuous membrane through all the segments of the body. The disappearance of all the nephridial apertures except the one between the tenth and eleventh segments is a further very natural specialisation.

In summing up the arguments here used in favour of this account of the disappearance of the nephridia in *Apus*, we have to notice the following points :—

(1) The eggs which develop out of the epithelium of the genital glands project, as in the Annelida, into the body cavity and not into the cavity of the genital glands themselves, as one would naturally have expected. This epithelium, then, is a part of the original cœlom epithelium of the Annelid.

(2) The eggs pass again through the epithelium, and travel down the canal formed by it ; this canal has therefore probably taken the place of the nephridial canal which it once covered as cœlom epithelium.

(3) We have to call attention not only to the segmental arrangement of the organs, but to the fact that there is a pair in each segment except in the most rudimentary ; both of these facts agree with what we know of the typical development of nephridia in each segment of the Annelida.

(4) The position of these genital organs between the dorso-ventral muscle dissepiments and the body wall agrees exactly with that of the nephridia of the carnivorous Annelids, which lie in the lateral chambers of the body (see Fig. 11, p. 54).

(5) The position of the only aperture which remains agrees well with the position of the opening of the Annelidan nephridium, *i.e.*, it lies laterally on the ventral surface. The fact that, in *Apus*, it comes between two consecutive limbs is due to the bending round of the parapodial limbs towards the ventral middle line as already described (see § on Appendages).

(6) The genital aperture does not always remain in the same segment in the Crustacea ; it differs even in the males and females of the same species.

(7) Lastly, we have to add the fact that the genital ducts have been generally recognised as homologous with Annelidan nephridia.

We thus believe that though the nephridia are absent in *Apus*, we have found sufficient traces of their having been once present in the typical manner, one pair in each segment, functioning, as they do typically in Annelids, as ducts for the transmission of the sexual products. The great development of the shell gland rendering the excretory functions unnecessary, there remained only the secondary function of conducting the sexual products out of the body. As this could be done equally well by simple tubes formed out of the covering of cœlom epithelium, these latter alone have been retained, preserving, however, the segmental arrangement and the position of the nephridia which they had at one time clothed.

These considerations seem sufficient not only to remove the difficulty caused by the absence of nephridia in *Apus*, but even to strengthen the evidence

in support of our main argument ; they not only remove a difficulty, but bear positive testimony to the truth of our theory. Those who, however, may think this view of the disappearance of the Annelidan nephridia (with the exception of their peritoneal coverings) far-fetched, should remember that the weight of all the positive evidence brought forward as to the relationship of *Apus* and the Annelida is only really diminished if we cannot show that a difficulty is surmountable. It is by no means necessary for our argument either to remove all difficulties so long as they are not positive contradictions, or to state exactly *how* such and such a transformation came about, but only to show that such transformations are not inconceivable. We believe, however, that in this case we have not only shown this, but more, viz. that the process of the disappearance of the nephridia was what we have described.

We have now dealt with the principal glands of the Crustacea and of the Annelida. We have deduced the Crustacean glands from the Annelidan setiparous glands, and followed the Annelidan nephridia in their transformation into Crustacean genital glands.

Of the typical dermal glands of the Annelida we have found no trace in *Apus* (except in the dorsal organ, see below and Appendix IV). The hypodermis is very thin, and seems to be entirely taken up in secreting the cuticle in its gradual transformation into an exoskeleton.

There are very numerous glandular cells in the hind-gut, which have already been mentioned in

§ vii., where we stated that from their position they were almost certainly excretory.

The glands at the tips of the diverticula of the mid-gut were also mentioned in the same section, and were interesting as forming with the diverticula a striking transition between the digesting diverticula of the Annelids and the hepato-pancreas of the higher Crustacea.

The white oval spot, or dorsal organ, behind the eyes in *Apus* we at first thought to be the remains of an Annelidan frontal cirrus such as that shown in Fig. 1. It appears to be an island of dermal glandular cells, the last remains of the Annelidan dermal glands, which the thickening exoskeleton probably rendered impracticable. This organ will be described in detail in Appendix IV. It offers indirect support to our theory of the Annelidan origin of *Apus*.

## SECTION X

### REPRODUCTION

THE carnivorous Annelids are mostly sexually separate. The same was originally the case with the Apodidæ, which are now, however, mostly hermaphrodite (see Appendix V.). Males, generally smaller than the females, have been found at intervals in the best known species, and these seem to suffice for occasional cross fertilisation.

The sexual elements of the Annelids frequently develop out of the cœlom epithelium (see Fig. 11, p. 54), and then, falling off, ripen in the body fluid. They are discharged through the nephridia, which may or may not be specially modified into sexual ducts.

In the section on the excretory glands, we have already briefly described the sexual glands in the Apodidæ. We have here, then, only to describe the process of formation of the sexual products somewhat more minutely. We repeat, however, for the sake of clearness what was said above. The genital glands



are segmental tubes connected by a longitudinal canal which acts as a common duct for all the glands. These latter are branched dorsally and ventrally. The branching is very rich in *A. cancriformis* and *L. productus*, and in *L. glacialis* more so than in *L. Spitzbergensis*. We failed to find that the branches of the genital glands in one segment anastomosed with those in others, so as to form the network figured by Zaddach; but we see no reason why such anastomoses may not sometimes take place.

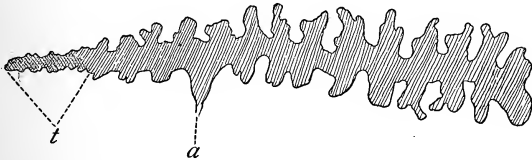

FIG. 32.—Diagram of a somewhat simplified genital tube of *L. Spitzbergensis* or *glacialis*, the dorso-ventral segmental tubes only slightly branched. *a*, aperture between the 10th and 11th segments; *t*, the rudimentary part, *i.e.* the part which lies in the posterior rudimentary segments, in which in this species the epithelium breaks up into sperm cells filling up the whole lumen of the tube.

Although there is no apparent difference between the epithelium of the longitudinal canal and that of the sexual glands, it is useful to consider the two apart. They are both, as we have seen, formed out of the peritoneal epithelium, and besides having the same origin, they have the same function, *viz.*, to secrete the slime which hardens in the brood pouch to form a covering for the eggs.

It is of considerable importance for us to note first of all that the sexual glands are segmentally arranged in *Apus*. This, as far as we know, is not the case in

any other Crustacean, and is in itself evidence of the primitive or Annelidan character of *Apus*. The gradual simplification of the glands from before backwards towards the less developed segments is also significant. The many-segmented ancestors of *Apus* developed sexual products in every or nearly every segment.

In the section on excretion we have already traced back the epithelium forming the sexual glands to the cœlom epithelium of the original Annelid, and to that special part of the epithelium which covered the nephridia. The nephridial tubes themselves have entirely disappeared, having probably been rendered useless by the great size and physiological efficiency of the shell glands. Their peritoneal coverings, however, have remained as the sexual glands. The eggs develop out of this epithelium, not projecting into the lumen of the gland, but outwards, so that they bulge out into the body cavity. This agrees with what takes place in many Polychætan Annelids; the eggs develop out of the peritoneum, and apparently out of any part of the same, drop off into the body cavity, and are emptied out through the nephridia. In *Apus* slight changes have taken place: the eggs develop towards the body cavity out of the peritoneal covering of the vanished nephridia: they do not, however, drop off, but pass through the epithelium again, to pass out through the tube formed by this epithelium, just as they at one time no doubt passed out through the nephridial tubes. When we consider the great size of the eggs owing to the accumulation of the yolk, it

is apparent that the vanishing of these nephridial tubes could be nothing but pure gain ; the simpler and the less differentiated the duct which they have to stretch in passing out, the better.

The eggs appear to develop out of indifferent epithelial cells at the dorsal and ventral tips of the genital glands. Their very first stages we have, however, not been able to trace. They are first recognisable as small groups of four cells with large nuclei (see Fig. 33), embedded among the undifferentiated epithelial cells. The nuclei show characteristic differences from the first stage at which we have found them. One is clear and round, with one or at the most two germinal spots ; the other three are slightly larger and quite full of irregular deeply stained granules. The former is the nucleus of the future egg, the latter are the nuclei of the nutritive cells.

The four cells grow together in one compact mass to a great size, the partitioning membranes being, however, traceable. They bulge out the membrane of the genital tube into the body cavity. In successful preparations, fine nuclei of a tessellated follicular epithelium can be found between the eggs and this membrane (Fig. 33, *n*). When the egg has been discharged down the branch into the genital tube, the locus of the egg is found as a small shrunken bag full of minute round bodies which are doubtless these follicle cells thrown off by the shrinking of the membrane (Fig. 33, 6). This epithelium then apparently plays no very important part, unless, in some way, it

brings about the contraction of the membrane for the discharge of the eggs.

The nuclei of the nutritive cells grow to an enormous size, and clearly play the chief part in absorbing material for the formation of the yolk. When the egg is ripe, these nuclei come to the surface and gradually disappear.

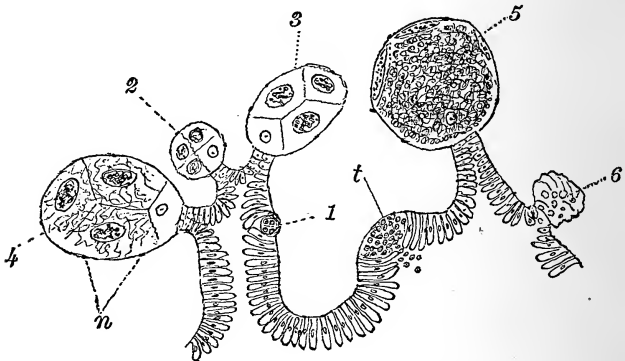

FIG. 33.—Eggs at different stages. In stage 1 the definitive egg nucleus is already differentiated from the nuclei of the three nutritive cells; the latter are seen to grow very large and coarse, and then in 5 to move to the side where they eventually disappear. In 5 the yolk discs fill the whole egg, making the nucleus difficult to see. At 6 an egg has been discharged; the follicular membrane has shrunk, its contents being probably dislodged epithelial cells. *t*, testes as occasionally found (e.g. in *A. cancriformis*); *n*, nuclei of follicular epithelium.

The egg, in its passage down the genital tube and along the longitudinal oviduct, gets covered with a slimy substance yielded by the deep club-shaped epithelial cells. This substance hardens into a shell for the protection of the egg, a shell which, as Von Siebold remarks, looks as if made of hardened foam. The eggs pass out between the 10th and 11th pairs of

limbs into the brood pouch formed by a modification of these limbs.

The external aperture of the genital ducts corresponds well, as has already been pointed out, with one of the apertures of the nephridia of the original Crustacean-Annelid. This view, which is now generally accepted among zoologists, is supported by the fact that, among the higher Crustacea, the position of the apertures is not always constant, *i.e.* they do not always occur on the same segment or segments. Indeed, the male and female apertures may occur on different segments in the same species (*e.g.* in the Crayfish). While there is variation in this point, there is considerable constancy in the position of the openings relatively to the ventral middle line of the body. Both these points are important in homologising the genital apertures of the Crustacea with the nephridial apertures of the Annelida.

Many if not all of the Apodidæ are now, as was before stated, hermaphrodite. The small oval sperm cells form out of the epithelium of the genital tubes in the manner illustrated (Fig. 33, *t*). In some species<sup>1</sup> the whole of the epithelium at the extreme posterior end of the genital tube breaks up into sperm cells.

The sperm cells of the Polychæta are always (?) thread-like, while those of *Apus* are round or oval: this is no doubt a secondary modification. But the round form of the sperm cells in *Apus* may perhaps be the starting point for the many peculiar shapes found among the higher Crustacea. Other

<sup>1</sup> *L. glacialis* and *L. Spitzbergensis*, see Fig. 32.

groups again (*e.g.* the Cirripedia) have returned to, or retained, the thread-shaped spermatozoa of the Annelida.

In the development of the eggs and of the sperm here described, we find but little positive evidence of the relationship which we seek to establish. But we must again repeat that it is enough for our argument if nothing actually contradicts it. It rests upon an accumulation of homologies which are hardly to be denied, some of which, indeed, have long been recognised though never before carried out in detail. It is enough if we show how the other parts of the organisation of *Apus can* be deduced from organs of an Annelid.

With regard to the origin of the sexual products, we have shown more than this. We have drawn attention to at least one point in which *Apus* agrees with the Annelid, and that is, in the development of the egg, not into the genital tube, which did not exist in the Annelid, but into the body cavity. The point may seem to be a small one, but every one who has worked out the anatomy of *Apus* will, we are sure, have been at once struck by the fact, that although the genital glands are large and extensible, yet the eggs bud outwards and not inwards. It was this striking method of development of the eggs which first led us to homologue the epithelium of the genital tubes with the coelom epithelium of the Annelida.

The egg, as already described, consists of one egg-cell and three nutritive cells. As the nutritive cells are probably modified egg-cells, the eggs of the original Crustacean-Annelid may have developed out of its

cœlom epithelium in small groups. So also the small bulgings in the epithelium in which the sperm-cells develop may be considered to represent small pustules containing sperm in the peritoneal wall of an Annelid (see Fig. 33, *t*), but in this case the organs which this wall originally covered, *i.e.* the nephridia, have disappeared.

Lastly, we repeat the fact, that in no other Crustacean are the sexual glands segmentally arranged; one pair in each developed segment, and rudiments in the more developed of the rudimentary segments. The value of this fact for our argument can hardly be over-estimated.

## SECTION XI

### DEVELOPMENT

#### THE NAUPLIUS

OUT of the egg of Apus is hatched the well-known Crustacean larva the Nauplius, which, with certain characteristic differences for each group, occurs in all essential points the same throughout the whole class. The general likeness of the adult Apus to the Nauplius has, as already mentioned, been pointed out by earlier observers. This likeness, from our point of view, is very easily explained; Apus being the primitive Crustacean, or at least one of the primitive Crustaceans, the Nauplius is simply the young Apus, the adult developing gradually out of the larva without any metamorphosis worth mentioning (see Figs. 34, 39, and 41). Thus the Nauplius larva of other Crustaceans is simply the Apus-stage in their development. We repeat this, not as a conclusion only, but in order to use it as an argument in support of the theory set forth in this book.



The fact that a Nauplius stage is passed through by so many Crustaceans—by all, indeed, where the larva is not hatched out at a higher stage of development than the Nauplius, has received great attention. It led the older naturalists to assume that the primitive Crustacean must have been an animal like a Nauplius. This view has, however, generally been given up, on the ground that no such conclusion can be drawn from a free-swimming larva which is certainly much modified to suit its own special mode of life as larva. The whole argument of this book has, nevertheless, brought us back somewhat to the old view, *i.e.* that the primitive Crustacean was a Nauplius-like animal, *viz.*, an Apus. At the same time, the modern objections were largely justified, for the Nauplius is only a larval form of the primitive Crustacean, in some respects comparable with, but much more advanced than, the Trochophoran larva of the Annelids, showing, on the one hand, traces of its adult organisation, and, on the other, modifications to suit its own special method of existence as a free-swimming larva. There were no means of deciding which features belonged to the adult and which to the larva as such. The general likeness to Apus was never therefore understood to point to the fact that the Nauplius was nothing more nor less than an Apus larva, and that consequently Apus was a primitive Crustacean. And yet there seems to be no difficulty in this view; indeed, had it been put forward alone, it would, we think, have met with some acceptance as a plausible specula-

tion. In this book, however, we have arrived at such a conclusion from quite another point of view. We started by endeavouring to show that Apus, from its many striking Annelidan characteristics, was a transition form between the Crustacea and the Annelida, and hence a primitive Crustacean. It comes, therefore, as no slight support to our argument to be able to show that the higher Crustaceans pass through an Apus-like stage. That *all* Crustacea do not pass through this stage is easily explained by the theory of abbreviated development, so that this stage is either passed through in the egg, or else considerably disguised by the early acquirement of adult characteristics. As to the case in which the stage is passed through in the egg (*e.g.* among the Malacostraca) it is important to note that this is not the case in *all* Malacostraca, a Nauplius stage occurring, for example, in the development of Penæus and of Euphausia.

The theory of the origin of Apus from an Annelid gives us at once the true relation of the Nauplius to the Trochophora. It is not necessary to assume that Apus passes through a Trochophora stage, because this latter is a stage in the development of the Annelid specially adapted to a free-swimming larval life. The equivalent stage in Apus, being no longer larval but embryonic, does not require to develop the special characteristics of the Trochophora.

When the young Crustacean is hatched as a Nauplius, it has already advanced considerably

beyond the Trochophora stage. A comparison of the Nauplius of *Apus* just hatched from the egg with the figure of a Polychætan Trochophora shows at a glance that the former stands at a far higher stage of development than the latter. That this is in reality the case is also clear from the fact that the Nauplius develops three limbs, *i.e.*, the homologues of the parapodia of the first *three* Annelidan segments, traces of the dorsal fold which belongs to the *fifth* segment, and further slight indications of *five* trunk segments (see Fig. 34), in all *ten* Annelidan segments. A larva so far developed cannot be compared with the simple ciliated Trochophora, which when hatched probably represents only *two*, *i.e.* the first and last, segments of the adult Annelid.

With certain characteristic differences for each group, the Nauplius is essentially the same throughout the whole class of the Crustacea. Its exact morphology we shall endeavour to explain with the aid of the light we have now obtained as to its origin, as the larva of *Apus*, or the *Apus*-stage in the development of other Crustacea.

When hatched from the egg the Nauplius has three pairs of Crustacean limbs, the unpaired "eye," the dorsal shield, the large upper lip, and what is not usually mentioned—the bent intestine, or, what is the same thing, the rudiments for the development of such a bent intestine (see Fig. 37). We will take these points in turn.

1. The *Nauplius Limbs*.—We are not bound to

claim that these in any way resemble the original limbs of the primitive Crustacean. It is only necessary to assume that they are homologous with the first three pairs of Crustacean limbs, but modified for the special needs of a free-swimming larval life. As a matter of fact we do find that the form of the limbs can easily be traced to its origin. The first uniramous limb corresponds with the antenna of the

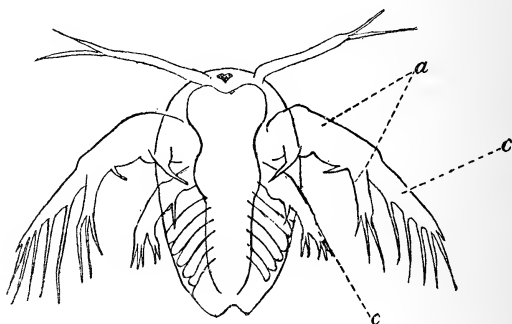

FIG. 34.—Nauplius of *Apus cancriformis* just hatched (after Claus). The large rowing limb homologised with the dorsal parapodium *d*, carrying the sensory cirrus *c*, which forms the most important branch, the smaller branch being the tip of the parapodium.

Annelids, *i.e.* with the sensory cirrus of the vanished parapodium of the first segment. It arises direct from the body as a uniramous appendage without any parapodial portion, *i.e.* unless the slight bulging, which is seen at its base in *Apus* (see Fig. 7 A, p. 34) represents the remains of such a dorsal parapodium, which we think improbable, as the sensory cirri of Annelidan parapodia frequently rise from such papilla-like swellings. Owing to the

smallness of the Nauplius it is not easy to ascertain exactly where the limb springs from; Claus states that it rises on each side of the prostomium or upper lip.

The second limb is biramose, *i.e.* besides the sensory cirrus, the parapodium on which it stands is also re-

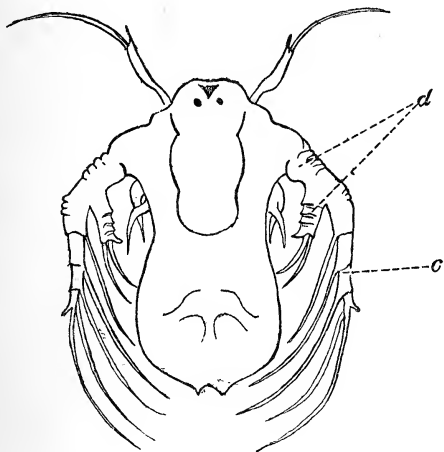

FIG. 35.—Nauplius of *Lepidurus productus* (after Brauer); commencing segmentation of the trunk disguised. A comparison with the 2nd stage, Fig. 40, shows that the trunk in the Nauplius certainly corresponds to several segments. *d*, dorsal parapodium of the 2nd antenna; *c*, sensory cirrus.

tained. Repeating the homologies brought forward in the section on the appendages pp. 32 and 33, the main stem of this second limb of the Nauplius is composed of the dorsal parapodium together with its sensory cirrus; the true tip of the dorsal parapodium appears like a small branch. Here clearly the exopodite is the sensory cirrus, the endopodite the tip of the dorsal

parapodium. That this is the true homology we have little doubt ; the facts that the second antenna is a sensory limb, that its tip carries long sensory hairs, that, as a long rowing foot, it requires to be provided with a fine sense of touch, all tend to support it. It is difficult to say whether the thorn-like process at the base of the limb represents the ventral parapodium ; it is possible that, in order to facilitate the motion of the rowing foot, the ventral branch has disappeared, just as in the higher Crustacea, when the legs become more specialised as such.

Figs. 35 and 36 are two views of the Nauplius of *L. productus*. In these the structure of the whole limb in the manner we have described is particularly clear, the sensory nature of the larger branch of the second antenna being marked by the length of its filaments.

The further development of the limb is interesting. As it ceases to be a rowing limb and to be specialised as a sensory organ, one of its branches, that representing the tip of the original dorsal parapodium, degenerates, leaving the other, the sensory cirrus, *i.e.* the exopodite, to form the distal portion of the limb. In *Apus* a small rudiment of the endopodite remains (see Fig. 7 B, p. 34, where the lettering explains the homologies).

If the thorn-like process at the base of the 2nd antenna is really the homologue of the ventral parapodium, we may perhaps see in it an attempt on the part of the very first Crustacean to use the ventral parapodia of all the segments round the mouth for mastication, an effort which succeeded well in *Limulus*,

as we shall see in Part II. In the other Crustacea, however, the greater efficiency of the ventral parapodia of the 3rd, 4th, and 5th segments, owing to their easier concentration round the mouth, led to their specialisation as mandibles and 1st and 2nd maxillæ, so that the masticatory process of the second antenna was rendered useless and disappeared (see table p. 250).

The third limb has again essentially the same shape as the second. We have the dorsal (and ventral?) parapodia, with an appendage on the former homologous with the sensory cirrus or the antennal branch of the second limb. The dorsal parapodium gradually disappears in *Apus*, leaving only the ventral as masticatory ridge or mandibles. It is however retained as palp in the higher Crustacea.

We repeat then here what we have learnt from our study of the limbs of the adult *Apus* and of those of the Nauplius larva. The tip of the dorsal Annelidan parapodium forms the endopodite of the Crustacean limb, the sensory cirrus the exopodite, and the ventral parapodium the masticatory process. Applying this once more to the trunk legs of *Apus*, we conclude that the flabellum becomes the exopodite, and the limb proper (*i.e.* the dorsal parapodium) is the endopodite; the gnathobase or first endite is the ventral parapodium, which in the typical trunk limb of the Crustacea disappears, but may be retained as a primitive feature, as in *Apus*, *Limulus*, and the Trilobites, and, as on the maxillipedes of the higher Crustacea, as a masticatory process.

We repeat further what was stated on p. 50, that theoretical considerations would also lead one to expect a retention of the parts mentioned to form the Crustacean limb, the capacity of sensation being necessary to all co-ordinated movement. Hence, as the dorsal parapodium lengthened into a seizing foot or locomotory organ, it had everything to gain by retaining its sensory appendage. It is interesting to note that when the exoskeleton is so developed that the limbs are protected by an almost stony covering, and the limb used simply for walking, the exopodite disappears, while on the other hand it is nearly always present in soft-skinned limbs, and generally seems to have retained its sensory functions. As an instance of this we can compare the thoracic with the abdominal limbs of the macrurous Decapoda.

When we come, in Part II., to consider the relation of *Apus* to *Limulus* and the Trilobites, we shall find considerable confirmation of the homologies here put forward, the homologising of the limbs of these animals with those of *Apus* being by no means the impossible task it is too often assumed to be.

2. *The Unpaired "Eye."*—The presence of powerful rowing limbs in the larva necessitated some more perfect sensory organ than any possessed by the Annelidan larva; hence the early development of the unpaired "eye" which in the Nauplius probably still retains its visual functions, although these have apparently been lost in the median "eye" of *Apus*. The structure of this organ in *Apus* has been described, and its probable origin out of the two anterior eye-spots on



the original Annelidan prostomium has been discussed. We also saw how it, together with the paired eyes, wandered on to the dorsal surface. In support of this migration of the eyes, we call attention to Figs. 36 and 37, which show the eyes paired and unpaired far more anteriorly placed in the Nauplius than they are later in the adult, *i.e. midway between the ventral position in the bent Crustacean-Annelid and the dorsal Crustacean position.*

In *Limulus*, as already mentioned, the ocelli travel during embryonic life from the ventral to the dorsal surface. The homology of the unpaired eye of *Apus* with the two ocelli of *Limulus* assumed here and on p. 108 will be further discussed in Part II.

It is important to note that this sensory organ is present in all Nauplii, and persists throughout life in all Entomostraca, but degenerates in the Malacostraca. In the more highly developed larvæ of these latter, traces of it are also generally, if not universally, to be found, *e.g.* in the Phyllosoma larva of *Palinurus*, the *Erichthus* larva of *Squilla*, and in some, if not all, *Zoæa* larvæ. Owing to this almost universal presence of the unpaired eye among the Crustacea it has been assumed that it was present in the original Crustacean. This assumption falls in with our theory that it was first developed in the Crustacean-Annelid.

In addition to what was said on p. 109 as to the function of this organ, we may say that its form as a hollow vesicle full of pigment cells seems at first sight to suggest an auditory organ, but we share the growing conviction among zoologists that many

sensory organs which are now called auditory really serve for regulating the position of the body in the water. The position of the organ in *Apus* seems to support this view. The feathered hairs fringing the flabeila are far more capable of appreciating and responding to sound waves than is a plexus of pig-

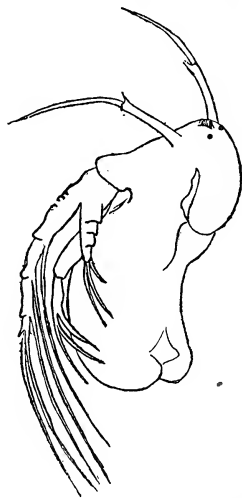

FIG. 36.—Nauplius of *L. productus* from the side (after Brauer), showing the position of the eyes at the frontal end, *i.e.* in their passage from the ventral to the dorsal position.

ment cells in a closed vessel suspended inside the body some distance beneath the outer integument. There is here, however, abundant room for further research. It is possible that in the course of the development of some Entomostraca, its original function as a directive body may entirely give place to secondary visual functions, or, as above suggested,

it may function both as directive and as visual organ. Indeed, there is no reason why we should not assume this double function at least during larval life, so long

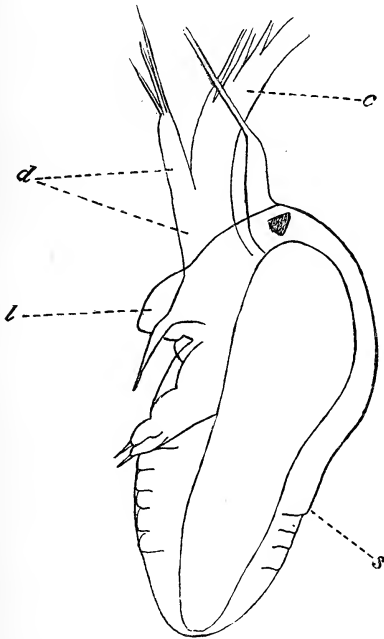

FIG. 37.—Nauplius of *A. cancriformis* just hatched (Claus) from the side, showing the unpaired "eye" in its passage from the ventral to the dorsal position. *l*, large upper lip; *s*, dorsal shield; *d*, dorsal parapodium of the second antennæ; *c*, sensory cirrus of the same.

as the paired eyes are not developed, and the animal is transparent. On the other hand, if it is a directive body its disappearance in the higher Crustacea is quite intelligible, especially in the Decapoda, which

for the most part crawl, and develop "auditory" organs in the antennules.

We may in this connection mention the frontal sensory organs which appear in many (or all?) Nauplii (see Fig. 39, *f*) on each side of the unpaired eye. They disappear throughout nearly the whole class in the course of development. They may perhaps

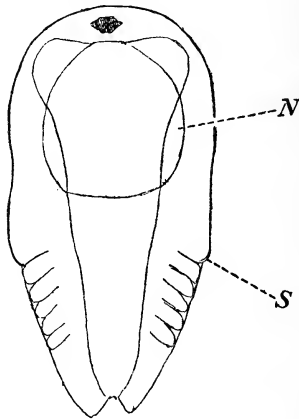

FIG. 38.—Nauplius of *A. cancriformis* just hatched, dorsal view (after Claus).  
*S*, posterior edge of the shield; *N*, the large larval excretory organ, the dorsal or neck organ.

be supposed to represent a pair of feelers rising on the prostomium of the original Annelids, such as those found, for example, on the prostomium of the Eunicidæ. In a section of *Apus cancriformis* we thought we found traces of them on the frontal surface in a very short stiff horn-like process of the cuticle, at the base of which was a group of large ganglion cells.

3. *The Dorsal Shield*.—As a dorsal shield is present in most Nauplii, it has been generally concluded that the original Crustacean possessed such a protective covering. When we come to discuss the relation between Apus and the Trilobites we shall find that this was by no means the case. Only in so far as Apus is the original of all living Crustacea (excepting, perhaps, the Ostracoda<sup>1</sup>) can it be said with truth that the racial form possessed a dorsal shield, at least as a fold of the fifth segment. The shield of the original Crustacean-Annelid was itself a different structure. From it not only the shell fold of Apus, but also the different forms of bivalve shell have been developed, as will be described in detail on pp. 213-216. Again, a further false conclusion has often been drawn from the great size of the shield in the Nauplius, viz., that it must have been of about the same size, relatively, in the original Crustacean as in the Nauplius. Hence it has been concluded that, for instance, the Estheridæ, which have a large dorsal shield, are more primitive than the Apodidæ with their relatively smaller shield. The great size of the shield in the Nauplius, however, admits of a much simpler explanation. The shield is, as we have seen, a dorsal fold of the fifth segment. Hence, in larvæ in which only the first five or six segments are developed, it must necessarily appear relatively of very great size.

<sup>1</sup> Our reason for excluding at least some of the Ostracoda from the other modern Crustacea which we deduce from Apus will be discussed in a special section of Part II.

The development of the shield is well shown in Figs. 35 and 36 of the Nauplius of *L. productus*, which should be compared with the commencement of the development of such a shell in the Trilobite *Acidaspis*, Fig. 48, p. 215, the neck lobe of which, developed as a thorn-carrier, suggests a very probable origin of the dorsal shield. We see it again in the Nauplius of *A. cancriformis*, Figs. 37 and 38, developing as a fold.

No great difficulty need be found in the fact that the fold of the fifth segment should appear in the Nauplius before any trace of the limbs of the fourth and fifth segments, *i.e.*, of the two pairs of maxillæ. It is doubtless of considerable advantage to the larva to develop the shield as early as possible as a protective covering.

4. *The Upper Lip*.—The labrum is another very characteristic feature of most Nauplii. In some, indeed, it reaches an enormous size (see Fig. 37). The homologies of this organ have been a great puzzle to zoologists. Packard suggests the median frontal tentacle of certain larval Annelids. Its presence in the Nauplius seems certainly to suggest that it was a prominent organ in the racial form of the Crustacea, especially as it is difficult to see what special advantage it can offer to the larva as such. Our derivation of *Apus* and of the whole class of Crustacea from a bent Annelid, homologises it, as already described, with the Annelidan prostomium, which is probably the most important of all the external organs of the Annelidan body. Its general

presence in the Nauplius larva of so many Crustaceans, whether it is afterwards retained by the adult or not, is thus easily explained. Its relatively great size in the larva admits of the same explanation as we gave of the great size of the dorsal shield; the Nauplius consisting mainly of the Crustacean head of five bent segments, the prostomium is naturally a more prominent organ in it than it is later in the adult.

5. *The Bent Intestine*.—As a characteristic of the Nauplius not often mentioned we have alluded to the bent intestine or, in other words, the relative position of the mid-gut and the mouth under the upper lip (see Fig. 37, which is a side view of the Nauplius of *Apus* showing the position of the parts). We lay stress on this as a characteristic of all Crustaceans, the origin of which is explained by the bent Annelid theory.

The development of the liver as diverticula of the mid-gut is very clear in Figs. 34, 38, 39, 40.

The important fact that the nerves for the second antennæ spring in the Nauplius from the infra-oesophageal ganglion has already been mentioned in discussing the nervous system. This fact serves as a very striking link between *Apus* and the Nauplius, *Apus* showing in this respect a very primitive condition, for though the nerves of the second antennæ branch off from the oesophageal commissures, there can be no doubt that the ganglia are infra-oesophageal (*cf.* Section V.).

We may perhaps here briefly summarise what has been said about the morphology of the Nauplius

larva. So far from its being comparable with the Trochophoran larva of its original Annelidan ancestors; it is essentially a Crustacean larva, containing from six to ten of the original Annelidan segments, five of which are bent round to form the head. This method of development by the appearance at first of the head and the gradual addition of the new segments has been clearly inherited from the Annelids, and is, in this connection, very important. This free-swimming larval Crustacean head develops chiefly those organs which are necessary to it, those not especially needful remaining rudimentary. These useful organs are the anterior pair of sensory antennæ and the second pair of rowing antennæ, which are also, as we have seen, sensory organs. The use of the third pair of limbs is not clear, unless they serve for holding on to stationary objects; it seems necessary to attribute some function to them, since, if they had no such larval function, they would probably appear more in their definitive form. The two pairs of maxillæ have no function to perform in the larva and are only developed later. It is generally said that the second pair of limbs degenerates; this is not strictly true, only relatively so. They are precociously developed in the larva, and, according to Brauer's measurements for *L. productus*, continue to grow, not, however, in proportion to the growth of the larva. The slight change they undergo is due to a change of function. The shield which belongs to the fifth segment, being a useful organ, is visible from the first. The unpaired "eye" is developed before the paired eye,



not because it is phylogenetically older, but because its functions are more useful to the free-swimming but not at first independently feeding larva. In the larva of *L. productus* rudiments of the paired eyes are distinctly visible. The excretory functions of this larva are entirely carried on by the large round or oval patch of glandular hypodermis called the neck- or dorsal-organ (see Fig. 38, and Appendix V.). Lastly, returning to the gradual development of the Nauplius into Apus without metamorphosis, we cannot help repeating that in itself it is a strong argument in our favour that the Nauplius is but the young Apus, and Apus but an adult Nauplius (*cf.* Figs. 34, 39, 41, and Frontispiece).

One of the chief features, however, in the gradual development of the Nauplius into an Apus is the regular formation of new segments in front of the anal segment as in the Annelid, and the cessation of growth in Apus before the full number of inherited and rudimentary segments are fully developed. Apus is thus, even when adult, little more than a large Nauplius with its posterior segments in front of the anal segment fixed throughout life in their larval condition. The significance of this fact is very great, it shows so conclusively that Apus is a primitive form, that we cannot refrain from repeating our explanation of its morphology. The very fact which has been supposed to be an index of the high specialisation of the Apodidæ, *i.e.*, the great number and peculiar arrangement of the limbs, is in reality one of the strongest proofs of the undifferentiated

primitive character of the genus. The number of limbs is far in excess of the rings in the body, and if we once recognise that the rings do not correspond with segments except in the fully developed anterior trunk region, but that each pair of limbs having its own pair of ventral ganglia corresponds with a true segment

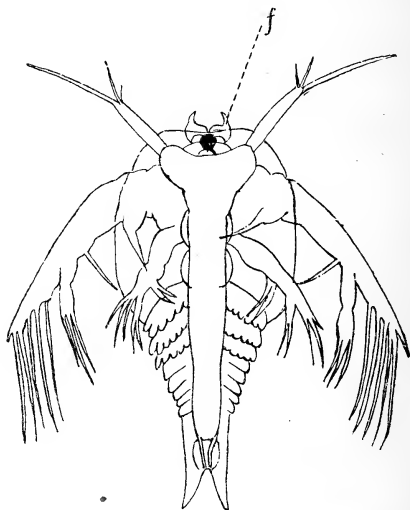

FIG. 39.—Second larval stage of *Apus cancriformis* (Claus), showing the gradual development of *Apus* out of the Nauplius, the liver as diverticula of the mid-gut. *f*, frontal sensory organs.

either developed or rudimentary, we have an animal, say *Apus cancriformis*, with from 60–65 segments. There are other species with from 40–50 segments. In all other Crustacea the number of segments is for each group either absolutely or very nearly constant. The type is fixed. In the Apodidæ, as we

have seen, this is not the case; the number of segments varies not only in the different species of the genus, but, as it appears, in different individuals of the same species. These two characteristics of the Apodidæ, the great number and the varying number of the segments, ought almost of itself to constitute them the natural transition form between the Annelids and the Crustacea. In the Annelids we have a large and variable number of segments, in the higher

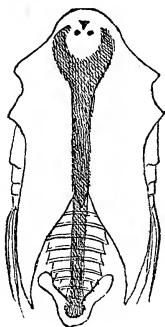

FIG. 40.—Second larval stage of *Lepidurus productus* (after Brauer).

Crustacea a comparatively small, and for each group a fixed, number of segments. Between these two the Apodidæ form the true link, having a diminishing number of segments, diminishing, that is, by a considerable number remaining undeveloped, and so rudimentary as to be useless to the animal, and therefore liable to vanish.

In this section on the Nauplius we have appealed to the developmental history of *Apus* in support of

the arguments founded upon anatomical and morphological comparisons brought forward in the previous sections. We may, we think, safely maintain that the

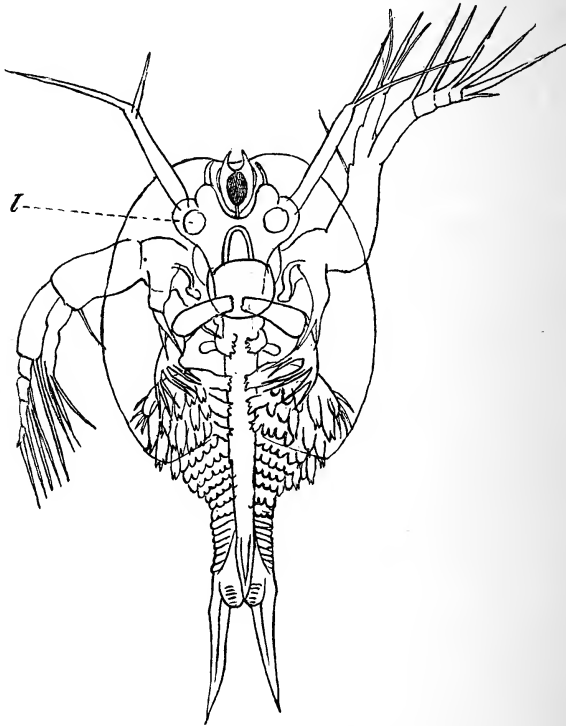

FIG. 41.—Fourth larval stage of *Apus* (Claus), the diverticula of the mid-gut commencing to form the glandular invaginations (*l*).

bulk of the evidence to be deduced from the Nauplius is decidedly in favour of our theory. To us it seems so strong, that on it alone the theory might almost be

based. All that our argument requires is, that, while the positive evidence is strong, the difficulties should not be insuperable.

We have had to limit our remarks to the larval history of *Apus*, as observations on its embryological development are unfortunately wanting. We may, however, here mention one or two facts in the embryology of the Crustacea which bear upon our theory. It is stated,<sup>1</sup> for instance, that the median eye develops from *paired* rudiments—an observation which lends some support to our account of the origin of this organ out of an anterior pair of eyes. Still more important for our theory is the fact that, while in the development of a few Crustacea there is a tendency in the mesoblast to form paired, segmented mesoderm-streaks, in the majority of cases the mesoderm cells form irregular lacunar spaces.<sup>2</sup> The significance of these two facts *taken together* cannot be over-estimated, that is, if we are right in assuming that the latter method of development of the mesoblast is gradually displacing the former, and is therefore cœnogenetic. It will be remembered how, from purely morphological reasoning, we came to the conclusion that the greater part of the cœlom epithelium (the parietal layer) of the original Crustacean-Annelid went to form the membrane of the lacunar blood system of the Crustacea. We find then this acquired rearrangement of the mesoderm shifted back to the earliest embryonic stages.

<sup>1</sup> Grobben, "Die Entwicklungsgeschichte der *Moina rectirostris*."

<sup>2</sup> Korschelt und Heider, "Lehrbuch der vergleichenden Entwicklungsgeschichte der Wirbellosen Thiere."

---

GENERAL CONCLUSION BASED UPON THE ARGUMENTS CONTAINED IN THE FOREGOING SECTIONS.

In pre-Cambrian times, of which there are now no fossil remains, a browsing carnivorous Annelid acquired the habit of keeping its "head," *i.e.*, its first five segments, bent round so that the mouth faced ventrally and posteriorly, and used its parapodia for pushing food into its mouth. The antennæ, antennal parapodia, and parapodia developed gradually into Crustacean antennæ, mandibles, maxillæ, and limbs. For the protection of the exposed anterior dorsal surface, a shield, to be more accurately described later on, was developed out of a fold of the tergum of the fifth segment, the posterior edge of which grew perhaps as a carrier of defensive thorns. At the posterior end of the body, the inherited number of Annelidan segments gradually ceased to be developed, and remained in a rudimentary or larval condition. The gradual development of a thickened cuticle led to transformations of outer and inner organisation sufficient to change the Annelidan into the Crustacean type. The modern representative of this Crustacean-Annelid is *Apus*.

We have now to see if it is possible to deduce the principal groups of both living and extinct Crustacea either from this racial form or from a similar Crustacean-Annelid. This is clearly the best test of the truth of the morphological and anatomical reasoning contained in this first part.

PART II





## *PART II*

### SECTION XII

#### RELATION OF APUS TO THE OTHER CRUSTACEA

IN Part I. we have endeavoured, on morphological and anatomical grounds, to deduce Apus from a carnivorous Annelid. We have shown that the transformation of the latter into the former was in adaptation to a new and very simple change in the manner of life of the Annelid. If the reasoning of Part I. is correct, we feel justified in concluding on the ground of probability that the transformation of Annelids into Crustaceans only took place once, and that therefore our bent carnivorous Annelid must form the root of the whole Crustacean system. Further, it is clear that the Apodidæ must stand very close to this root. This reasoning leads us at once to find an infallible test for our whole theory. We have two lines along which to work, both of which are capable of leading to a positive answer, negative or affirmative. We shall first take the archaic forms and see whether they, like Apus, are capable of being deduced

from our bent Annelid. And, secondly, we shall see whether *Apus* forms a probable starting-point for the modern Crustacea. In both cases we shall find that our theory stands the test. We shall find that the transformation of the carnivorous Annelids into Crustacea did not result in only one form of primitive Crustacean, but in several. It was, however, the same Annelid, with the same number (five) of anterior trunk segments bent round towards the ventral surface, which gave rise to the whole class.

The most important and apparently the most successful modification in early times was the Trilobites, that is, if we may judge from the extraordinary numbers and varied development of these early Crustacea in palæozoic times. They, however, all died out, leaving, perhaps as their sole modern representatives, some families of the Ostracoda.

Other modifications of the original Crustacean-Annelid were the Eurypteridæ and Xiphosuridæ, to which latter the still living king-crab belongs.

All these groups, however well adapted to their palæozoic surroundings, have, with the exception of the last-named (and the Ostracoda, which we think may have come direct from the Trilobites), entirely disappeared, and it was the Apodidæ which became (with the above exceptions) the sole ancestors of the now living Crustacea, surviving mainly, we think, on account of the advantages afforded by the development of a dorsal shield.

We have, then, to try to show first, that these Crustacean forms are deducible, like *Apus*, from the bent

carnivorous Annelid, and, secondly, that the living Crustacea, excepting *Limulus* and (?) the Ostracoda, may be easily deduced from the Apodidæ.

If these points can be established, they necessarily involve a rearrangement of the present system of classification. The discovery that an animal, which has hitherto been considered as a very specialised form of a special group, is in reality one of the simplest and most original forms of all the groups, supplies at once the starting-point for the classification of the Crustacea which has hitherto been wanting. It is at present impossible to find points of connection, sufficient for a natural system of classification, between many of the different groups. We shall now find that the acceptance of our Annelid ancestor of *Apus* as the original form enables us, for the first time, to sketch, at least in outline, a natural order, not only embracing the Entomostraca and Malacostraca, but also *Limulus*, the Eurypteridæ, and the Trilobites. This new classification we shall attempt, that is, if we are justified in calling that "new" which is in reality only a further development of views expressed many years back by the older zoologists, and notably by Burmeister.

Although we have set ourselves this double task, it is clearly impossible, in a small work like this, to go into many details, especially in our comparison of the Apodidæ with the many living Crustacean forms. It will, we think, be granted, that a successful grouping of the Apodidæ with the Xiphosuridæ, the Trilobites, and other early forms as common derivatives from a

bent Annelid, will establish our main argument beyond contradiction. We shall therefore devote our chief attention to endeavouring to explain the morphology of these ancient forms from this point of view, making, as we believe, many points clear which have never been properly understood.

As to the second part of our task, the deduction of the modern Crustacea from the Apodidæ, and the formation of a new system of classification, we shall have to leave the working out of the details to others, and content ourselves with a short collection of notes, to suggest the possible ways in which the modern Crustacea may be deduced from our bent Annelid, either through *Apus* or through the Trilobites.

#### APUS AND LIMULUS.

We begin with *Limulus* because, being still extant, its anatomy is well known. It is to the works of Anton Dohrn, Kingsley, Lankester, Milne-Edwards, Packard, and others, that we are indebted for the details of its organisation here brought forward.

The likeness between *Limulus* and *Apus* is so great, not only in external form but in inner organisation, that almost all the older zoologists classed them together in one genus. The temptation to draw comparisons between them is traceable in the writings of all who have dealt with either of them. But, in spite of this unmistakable likeness, all idea that the two animals could possibly be related has in later times been steadily repudiated. Indeed no general agree-

ment has been arrived at as to the true zoological position of *Limulus*. Many eminent zoologists, such as Van Beneden, maintain that *Limulus* is not a Crustacean at all;<sup>1</sup> and the able attempt of Lankester and others to demonstrate that *Limulus* is an Arachnid is familiar to all zoologists.

The difficulties in the way of connecting *Limulus* and *Apus* seem to be the following. (1) The limbs in the two animals are differently arranged on the body, besides differing in number and form. This point is rightly considered of great importance, because it was chiefly the close study of the limbs, and of their homologies in the different Crustacea, which enabled zoologists to arrange the class into the natural groups of our present classification. (2) Whereas the Xiphosura bear markedly the character of an archaic group, whose nearest allies are to be sought for in the earliest geological strata, and which in development pass through a so-called "Trilobite" stage, *Apus* has, comparatively speaking, no geological record, and is, so far as we can learn from palæontology, rather a highly specialised tertiary form. (3) The young of *Limulus* do not pass through any stages which appear to correspond with the stages of *Apus*. Packard's attempt to discover the Nauplius stage in the embryological development of *Limulus* has met with no favour.

We here have, as far as we can find, the chief

<sup>1</sup> "Les Limules ne sont pas des Crustacés—ils n'ont rien de commun avec les Phyllopoies." *Journal de Zoologie*, par P. Gervais, vol. i. p. 42. Paris, 1872.

reasons why zoologists have not allowed themselves to be influenced by the extraordinary morphological likeness between the two animals, and why they have maintained that this likeness is merely a remarkable case of analogy.

On the other hand, the morphology of *Apus* has been such a perpetual puzzle, that its likeness to *Limulus*, even combined with its acknowledged retention of Annelidan characteristics, gave no key to its systematic position, just as its likeness to the Nauplius failed to suggest that it is itself the proto-Nauplius. When once, however, we recognise the essentially Annelidan and therefore primitive character of *Apus*, and thus regard it as an archaic form, *i.e.*, as a survival from early geological periods, its likeness to *Limulus* takes on at once a new meaning. The difficulties above mentioned deserve to be re-examined; fortunately they are not insuperable. Before going into a detailed comparison of *Limulus*, let us briefly indicate the way these three difficulties may be met.

I. In the first place, the difficulty as to the difference between the limbs of *Limulus* and *Apus* depends entirely upon an exaggeration (a very natural exaggeration) of the importance of limbs for the purpose of classification; we say, a very natural exaggeration because, as above stated, it has been by a close study of the homologies of the Crustacean limbs that so much has been done to arrange the Crustacea into natural groups. On the other hand we ought not to lose sight of the fact that of all organs of the body the appendages are the

most plastic; the slightest alteration in habit of life, and every change in size and form of the body, bring about some corresponding change in the limbs. So that while, on the whole, stability of type is wonderfully exemplified in the Crustacean limbs, too much weight must not be laid upon it, since the same class supplies us with equally wonderful examples of extreme plasticity. Specialisation for some particular habit of life leads often enough to modification which altogether obliterates the type. It is not safe, then, to conclude, because the limbs of a Crustacean do not now show the typical form, that there is no way of connecting them with typical limbs. We thus maintain that the assumed failure of *Limulus* to show the typical Crustacean or Phyllopodan limbs ought not for a moment to weigh against the positive likeness between it and *Apus*.

Further, while *Apus* has, as we have seen, retained the more primitive form of limb, not far removed from the Annelidan parapodium, the manner of life of *Limulus* has led to a specialisation of its limbs, but not, it is important to note, to such extreme specialisation that no points of resemblance with the limbs of *Apus* are retained. On the contrary, the likeness, in some respects, is so great that one might almost be tempted to leave the limbs out of account in the question of relationship; they speak equally strongly both ways. When we come to compare the animals in detail, *Apus* having supplied us with the clue, it will not be difficult to deduce

the limbs of *Limulus* from the parapodia of our Annelid, and to explain the transformations which have taken place.

The first difficulty as to the form and order of the limbs is thus, we think, fairly satisfactorily met for the present by the following four considerations:—

(1) That the possibility of homologising the limbs with typical Crustacean limbs must not be too much insisted upon, in the face of the well-known plasticity of these organs.

(2) That the limbs of *Limulus* are in many points as strikingly like the limbs of *Apus* as, in other respects, they are unlike.

(3) That the modification of the Xiphosuran limb out of the Phyllopodan or Annelidan is fairly easily traceable to the manner of life of the animals.

(4) As to the number of the limbs—our whole theory makes the number of limbs or segments developed of no real importance. The method of the development of new segments is such that few or many may be developed according to the needs of the genus.

II. Turning to the geological difficulties, we think these of even less weight than those founded upon the dissimilarity in the form, number, and order of the appendages. The habit of life of *Apus* from earliest times must have been such that it could be very seldom preserved in a fossil state. It was probably first shut off from the ocean in brackish lagoons, and was gradually driven by the struggle for



existence into small fresh-water pools, where alone it was able to hold its own, shut off from competition with almost all the rest of the animal kingdom. It is in this way, as already stated, that we account for the preservation of its primitive characteristics. Now, in such a record as this, what are the probabilities of its leaving any fossil remains? The marine carnivorous Annelids of palæozoic times have left only their hard, chitinous teeth, so that the Apodidæ of those times, with a skeleton not much harder than that of the Annelids, would hardly be likely to be preserved. Their comparative softness is thus one element to be taken into account in discussing the probability of their being preserved as fossils. But, further, when once they had adopted their fresh-water life in shallow pools, the chances of their preservation would be smaller still. They would at this time belong to the land fauna. There would thus be very little chance of their remains being preserved. In the first place the dead bodies would have decayed before there was any chance of their being covered by a deposit; there is, as a rule, very little suspended matter to fall in the isolated fresh-water pools which we suppose the Apodidæ to inhabit. And in the second place, land surfaces are, as is well known, seldom if ever preserved. There is therefore very little chance of any Apus being preserved excepting under very exceptional circumstances.

Further, although there may be no true Apodidæ recorded from Palæozoic strata, yet there are abun-

dant remains of Phyllopods, many of which show such a striking resemblance to the Apodidæ that we are justified in claiming them as nearly related forms. This fact lends distinct support to our argument that *Apus* is a very ancient form, in spite of the deficiency in its own geological record.

III. The embryological difficulty is even of less account than the two others. Packard, whose studies of the embryology of *Limulus* entitle him to speak with authority, states that it is evident that the metamorphoses are all undergone within the egg, in order that the young may enter at once on the manner of life of the adult. And we may repeat here what has been affirmed in other connections, that it is enough if the embryology of *Limulus* does not directly and plainly contradict our theory; we say plainly, because we do not lay much weight on the passing hints which an animal in its development may give as to its ancestors, unless these hints are supported by other evidence.

If these are not completely satisfactory answers to the difficulties which stand in the way of any close relationship between *Limulus* and *Apus*, they at any rate weaken those difficulties to such an extent that they are of little value in comparison with the positive evidence based upon the anatomical and morphological likeness between the two animals, taken together with all the evidence brought forward in the first Part to show that *Apus* has retained most of the characteristics of a primitive Crustacean, and, in fact, is as truly an archaic form as *Limulus* itself.

Having prepared the way, let us commence the detailed comparison of the organs of *Limulus* and *Apus*.

The first point on which we fix our attention in order to test the relationship between the two animals may not appear very important, but the longer it is considered the more convincing, it seems to us, is the argument founded upon it. It is as follows:

Our main argument is that *Apus* is a *bent* Annelid.

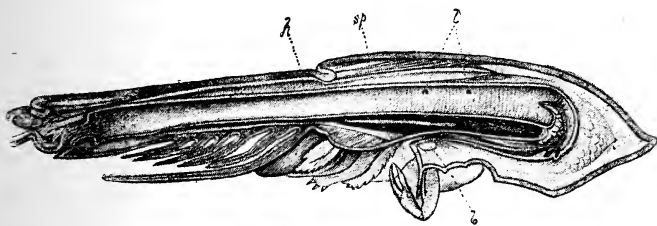

FIG. 42.—Section of *Limulus rotundicauda* to show the bend in the intestine with the sinewy sternal plate in the angle to be compared with that of *Apus* Fig. 13, p. 56. *b*, brain; *h*, heart; *l*, openings of the hepatic ducts in the mid-gut; *sp*, the sternal plate. From Bronn's *Klassen und Ordnungen des Thierreiches*.

In this way we explained the bend in the intestinal canal which is so characteristic of the Crustacea. This bent intestine is very marked in *Limulus* (see Fig. 42), and suggests the same origin. This, however, was not enough. We argued that if we find in the bend of the intestine of *Limulus* a sinewy mass such as we find in *Apus*, referable there to the clumping together of the abdominal musculature, the coincidence can hardly be a mere case of analogy. Such a sinewy mass *is* found in *Limulus*, in

essentially the same place as in Apus, and is known as the sternal plate. If we have given the right explanation of these two points, the bent intestine and the sinewy mass in the bend in Apus, there can hardly be any other explanation to be given of their occurrence in Limulus. Given, then, the derivation of Apus out of a *bent* Annelid, in the manner described in the first part, it is hardly within the range of probability that Limulus, in which these two essential marks of such a derivation occur, should have had a different origin. These two points of resemblance, *occurring together*, are, in our opinion, conclusive as to the essential relationship of Limulus to Apus, through their common origin from a bent Annelid. This alone without further positive evidence was sufficient to convince us that Apus and Limulus were at least branches of the same stem. But, as will be seen in the following pages, the whole organisation of Limulus admits of direct comparison with that of Apus, the very differences between them affording striking confirmation of our theory of their common origin from a bent Annelid.

With this decisive evidence in favour of our theory we naturally proceeded with considerable confidence in attempting to homologise the limbs which have hitherto presented the chief difficulty in connecting Apus and Limulus. Before commencing a detailed discussion of the limbs of Limulus, there are many points of resemblance in external organisation which should be mentioned. It will also be useful to

ascertain here the general principles on which *Limulus* has been modified.

On comparing the external form of *Limulus* with that of *Apus*, we find that the head region, while retaining essentially the same form, is yet far larger in proportion to the size of the body in the former than in the latter. The eyes are further apart, and two ocelli take the place of the unpaired "eye" or directive sensory body. The dorsal shield does not stand out from the body as a fold like that of *Apus*. Its frontal and lateral edges are produced downwards and outwards, so that the anterior part of the animal proper is raised from the ground, and, under the shield, has room for the movement of its limbs.<sup>1</sup> The dorsal shield, in fact, forms a sort of roof under which the animal lives. It is as if the head and anterior trunk segments of an *Apus* had been pushed upwards and backwards under the shield, being somewhat squeezed up in the process. The whole life of *Limulus* is passed under cover, every possible entrance being shut, or carefully guarded, against enemies.

The fusing of the head with the dorsal terga of a certain number of trunk segments naturally deprives these segments of any power of movement one upon another. The abdomen is also quite rigid, although in its embryonic state it shows distinct external traces

<sup>1</sup> This is not shown in the section of *Limulus rotundicauda*, Fig. 42, which, being a median longitudinal section, passes through the forehead. The vaulted shape of the shell is best shown in transverse sections, cf. the sections of a Trilobite Fig. 54, p. 230.

of segmentation. The length and rigidity of the caudal spine, taken together with the rigidity of the anterior portion of the body, would render the flexibility of the middle part of little use. It is true that there are Trilobites with rigid shields and pygidia and yet with flexible segments in the middle region of the body ; but the pygidium could, in these animals, be used as a covering in the rolling up of the body. In animals possessing a caudal spine there could be no question of its being put to any such use ; hence, probably, the rigidity of the middle or abdominal region of the body.

There are, comparatively speaking, but a small number of segments in the Xiphosuridæ, at least as compared with *Apus* ; but this is a matter of comparatively small importance if we take into consideration the method of development of the early Annelidan-Crustaceans. The hind part of the body might become fixed at almost any stage of development, more or fewer segments coming into existence according to the degree of specialisation of each group. *Apus* developed, comparatively speaking, a large number (50-60), *Limulus* a small number (ca. 16).

The metamerism of *Limulus* is probably to be reckoned as follows :

*Cephalothorax*.—This is composed of five segments of the bent Annelid forming the head, each segment retaining its appendages, and of two trunk segments bearing two pairs of limbs, the posterior pair forming the operculum ; in all seven segments.

*Abdomen and Caudal Spine.*—These probably represent nine<sup>1</sup> segments, of which the first five carry leaf-like gills, four (the last of which develops into the caudal spine) remaining limbless; these latter are to be compared with the five or six limbless segments of *Apus*. The caudal spine is a development of the anal segment homologous with the tail plate of *Lepidurus*. *i.e.*, of those *Apodidæ* in which the anal segment is produced posteriorly into a flat plate.

According to its *external* organisation, therefore, *Limulus* is an *Apus*-like animal, especially adapted for living on mud under a shell. The shell is vaulted and the body correspondingly compressed against its roof, so as to allow the limbs, &c., to function. In this way we think that the chief differences between *Apus* and *Limulus* can be explained. It is important to bear in mind this general principle on which *Limulus* has been modified as a key to its special organisation.

It is worth pointing out that Packard, quoting from Dr. Gissler, describes the method of moulting in *Limulus* and *Apus* as being essentially alike. This, however, need be no more than a case of analogy.

In the following detailed comparison we shall find that in some points *Apus* is the more specialised, in others *Limulus*, but there can be little doubt that, of the two, *Apus* stands nearer to the original Crustacean-Annelid.

<sup>1</sup> Packard gives this number for the abdomen of *Limulus*.

## THE LIMBS.

As already stated (p. 179) we find that the differences between the limbs of *Apus* and of *Limulus* are

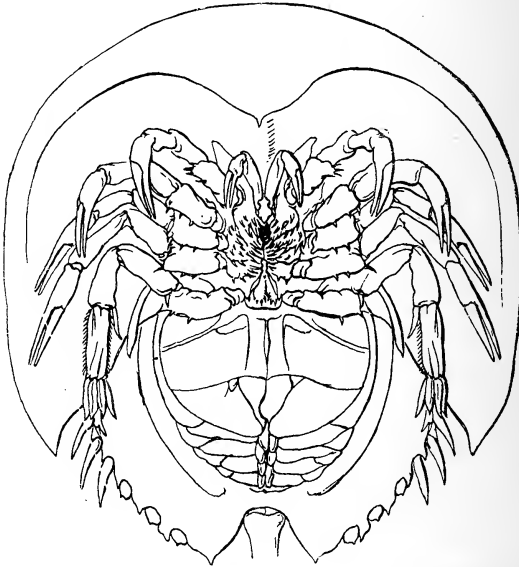

FIG. 43.—Ventral surface of *Limulus moluccanus* ♀ (after Van der Høeven), showing the ventral parapodia of five pairs of limbs, viz., the second, third, fourth, fifth, and sixth (first trunk limb), working between the prostomium and the under lip; also the differentiation of the sixth, or first trunk limb, for locomotory purposes.

as significant as are the likenesses. First as to number, we need only repeat what was said about the difference in number of the segments; instead of a large number of segments with a large number of limbs at different stages of development, from the parapodium-like limb



of the Phyllopoda to the Crustacean leg, we have in *Limulus* a small number of segments with a small number of limbs, showing essentially the same differentiation as we find in the legs of *Apus*, but more specialised in adaptation to its manner of life. We have anteriorly the more typical Crustacean limb, posteriorly the more parapodial limb, the transition between the two, however, being not gradual but sudden.

In trying to homologise the limbs of the two animals, we shall have to utilise the conclusions arrived at in Part I.

The first pair of limbs of *Limulus* occupies a place corresponding to that of the first pair in *Apus*, viz., at the sides of or close to the labrum, and is homologous with the first pair of antennæ. In general form these limbs do not differ much in the two animals, as may be seen by comparing Fig. 43 and Frontispiece. The chief difference is that in *Limulus* the bends have developed hinges, owing to the greater development of the exoskeleton, and there are chelæ at the tips. We need hardly say that neither of these points is of very great morphological worth. For instance, within the Arachnoidea we find one and the same limb, the pedipalp, in one group (the Araneidæ), as a simple feeler; in another (the Scorpionidæ), it develops powerful chelæ; and within the group of the Spiders themselves the tips of the pedipalps in many males undergo even more wonderful modifications for the purposes of copulation.

With regard to the second antenna, we were at first

disposed to think that it had entirely disappeared. In *Apus* it has not yet quite disappeared, but it is so rudimentary that it appears to be in the act of disappearing. It seemed to us that the condition of this limb in *Apus* helped us in pointing out a missing limb in *Limulus*. But maturer thought led to the homologising of the second pair of limbs with the second antennæ of *Apus*. In the first place the position agrees very well (*cf.* Fig. 43 with Frontispiece). This was not, however, the real reason for our change of opinion, which was due to a comparison of the sixth limb in *Apus* with the sixth limb in *Limulus*, and, to anticipate somewhat, with the sixth limb in the *Eurypteridæ* and in the *Trilobites*. The sudden specialisation of this limb in all these animals must be admitted to have some common significance. That given on p. 44 seems the most probable, viz., that, taking five segments to form the bent head, the sixth was the first free segment, and its parapodium was thus free to develop into a limb for locomotion or for some other function. Thus, taking the sixth limb of *Limulus* to represent the first trunk limb, the full number (five) of head limbs were left to be homologised with the typical head limbs of *Apus* and the other Crustacea. The second antenna is therefore present, exactly corresponding in position with the homologous limb of *Apus*. It is, however, a well-developed and highly functional limb. In the female it is chelate, but in the male it develops a seizing hook. It is interesting to note that the same pair of limbs in the male of *Branchipus*, which is closely related to *Apus*,

also develop powerful seizing hooks. The homology of the second pair of limbs of Apus with the second antennæ of the Apodidæ is doubly interesting because we here find the ventral parapodium retained as masticatory ridge. The great number of masticatory ridges in *Limulus* will be referred to again, and compared with the number of homologous ridges in Apus and the fossil Crustacea.

The third pair of limbs of *Limulus* offers a most interesting comparison with the mandibles of Apus. In the latter, the ventral parapodium alone is retained, the dorsal having entirely disappeared. In *Limulus*, both have been retained, the ventral parapodium as a very pronounced masticatory ridge, the dorsal as a long jointed chelate leg.

The fourth and fifth head limbs have nearly the same form as the third, and are homologous with the two pairs of maxillæ of Apus. One interesting feature, however, deserves special attention in connection with our deduction of Apus and also of *Limulus* from an Annelid. In *Limulus*, the ventral parapodium, which stands out much more pronounced as a ventral parapodium than it does in Apus, has retained distinct traces of its sensory cirrus (see Fig. 44). In this respect *Limulus* is more primitive than Apus. On the other hand in *Limulus*, the sensory cirrus (or exopodite) disappears from the dorsal parapodium of the head limbs; this is the exact opposite of what we find in the typical Crustacean limb, where the dorsal parapodium as endopodite and its sensory cirrus as exopodite are alone preserved, the

ventral parapodium being only occasionally retained as a mere rudiment. This very striking difference between *Apus* and *Limulus* is thus at the same time a link, since it connects them both with our Crustacean Annelid.

The sixth pair of limbs has already been homologised with the first trunk limbs of *Apus* and the other Crus-

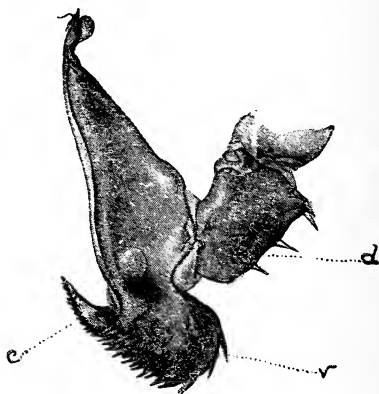

FIG. 44.—Basal part of one of the 2nd pairs of limbs of *Limulus moluccanus* (from Bronn's *Klassen und Ordnungen des Thierreiches*) to show the well-developed ventral parapodium, retaining the remains of its sensory cirrus (*c*); *d*, dorsal parapodium; *v*, ventral parapodium.

tacea. It differs characteristically from the head appendages. Its ventral parapodium is well developed as a masticatory ridge, and functions as a jaw, in front of the under lip, with the masticators of the last four head segments. Its dorsal parapodium, however, is developed in a peculiar way. It is a powerful limb for pushing the animal forward in its burrowing operations; its tip is provided with a group of sensory feelers

comparable with the sensory endites on the ventral edge of the trunk limbs of Apus ; in the middle of this group of sensory processes is a small pair of chelæ. This whole limb seems to combine locomotory with protective functions. Its tip lies close to the lateral gap between the cephalo-thoracic and abdominal shields, so that no enemy could enter without being immediately perceived and thrust out. This first trunk limb seems to have preserved its dorsal sensory cirrus, also no doubt as a guard against the entrance of enemies which could not easily be ejected if once lodged on the dorsal edges of the head limbs, *i.e.* between the limbs and the shield.

The last pair of limbs of the cephalo-thorax is highly modified as a flat cover or operculum for the abdominal feet. Its form is essentially Phyllopodan. In *Limulus*, the passage from the flat Phyllopodan limb to the Crustacean leg is abrupt ; there are no transition forms as in Apus. The first trunk limb is leg-like, the second Phyllopodan. As the form of the latter is essentially the same as that of the abdominal limbs, we reserve our description of it till later.

Before leaving these cephalo-thoracic limbs we wish once more to call attention to their arrangement, which is well explained by the manner of life of the animal. The animal, *i.e.* its anterior end, seems as if fixed up in the vault of a roof, the mouth being in the centre and the limbs hanging down all round. The most anterior and most posterior limbs do not function as jaws, but the five limbs between these two, *i.e.* the last four head limbs and the first

trunk limb, have powerful jaw pieces, which are arranged in two rows, one on each side of the oral aperture, the dorsal parapodia being developed into an outer ring of chelate feet for seizing prey and bringing it between the jaws.

It is clear that the efficiency of these long limbs, already limited as to space for free movement, would be materially lessened if on their dorsal edges they had to carry gills, &c. ; hence these appendages have entirely disappeared, respiration becoming localised on the abdominal limbs, which have been especially modified for the purpose. In the Trilobites the movement of the limbs is also limited by a large shield running the whole length of the body, but in their case both the gills and the cirri are retained, the reason being very simple, viz., that the ambulatory legs of the Trilobites do not require to carry out the complicated movements of the limbs arranged round the mouth of *Limulus*, but are simply ambulatory legs.

Two processes from the ventral surface of the body bring these limbs to a close. The mouth parts, *i.e.* the masticatory ridges, work between the labrum at the one end and these two processes at the other. Although authors have recognised that these processes function as an under lip, they hesitated to assert that morphologically they were the true under lip. We can, however, hardly doubt that they are to be homologised with the under lip of *Apus*. An examination of the special modifications of *Limulus* explains the position of the organ ; the mouth has been lengthened out longitudinally so that the labrum has

been forced outwards and forwards, and the under lip backwards, so as to admit of the working of the five pairs of jaws between them. If it at first sight seems unlikely that the paragnatha should move so far back as to come behind the first pair of trunk feet, it must be remembered that, when the mouth of the Crustacean-Annelid first stretched out so as to admit of the working of the five ventral parapodia as jaws, the parts were more flexible. It is also some confirmation of this homology to find that the sternal plate, the sinewy mass of the musculature originally in the angle of the bent intestine and thus close above the under lip, is also drawn back as far as this under lip, showing that the whole region has been drawn out of its original shape. The origin of the division of the under lip has been already explained (p. 40).

In *Limulus*, as already said, we do not find, as in *Apus*, a gradual change in the limbs from the more Crustacean form anteriorly to the more Annelidan, *i.e.* parapodial, posteriorly. The transition is sudden. The limb corresponding with the second trunk limb of *Apus* forms the flat operculum to cover the following five pairs of Phyllopodan (*i.e.* parapodia-like) limbs.

The typical parts of these abdominal limbs can still be more or less clearly recognised. The ventral parapodia of each pair of limbs have fused in the middle line, forming the basal plate; the dorsal parapodium is represented by a row of four joints approaching the middle line (see Fig. 45). On the outside of these come the large gill and somewhat smaller flabel-

lum fused with one another and with the basal plate, but still distinct. On the well-known principle of the increase of the respiratory surface by the formation of integumental folds, the dorsal (*i.e.* morphologically posterior) surface of the gills has developed a row of leaf-like folds.

It is of importance to note that it is only that part

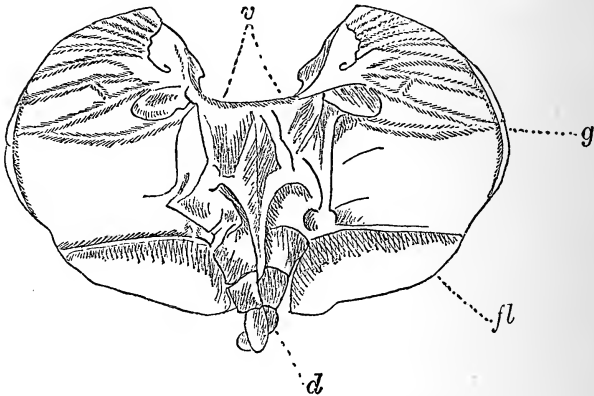

FIG. 45.—One of the abdominal limbs of *Limulus* for comparison with a Phyllopodan limb. *v*, ventral parapodia fused together; *d*, dorsal parapodia (endopodites); *fl*, flabellum or sensory cirrus (exopodite); *g*, gill, the posterior surface of which carries leaf-like integumental folds.

of the limb of *Limulus* which morphologically corresponds with the gill of the parapodium (or of the Phyllopodan leg) which is thus modified. One would have been inclined to think that the increase of the respiratory surface could have been better obtained by using the whole surface of these leaf-like limbs. We have here a most interesting case of the strict localisation of function. The increase of respiratory



surface required, in consequence of the suppression of the gills on the anterior limbs, is obtained by a complicated increase of the surface of the gills on the other limbs, and of the gills only.

We have, then, compared the appendages of *Limulus* with those of *Apus*, and shown how they throw light upon one another, how they are both deducible, some along one line of special differentiation, some along another, from the parapodia of our original Crustacean-Annelid. The type is clearly the same in both, as is also the type of the whole organisation of the two animals.

*The Musculature.*—The musculature of *Limulus* is very specialised, in accordance with the specialisation of the outer body and the high development of the exoskeleton. We will not here venture on the task of endeavouring to trace the separate muscles from their Annelidan origin. In all such attempts, the limitation of the movements of the body must be borne in mind. The fact that the body of *Limulus* is no longer capable of any bend, except in the sagittal plane, would alone bring about very profound changes in the musculature, which originally moved the Annelid freely in any plane.

It must here suffice to refer to what was said above (p. 184) about the sinewy mass found within the bend of the intestine for the attachment of the muscles. For the origin of this mass from the Annelidan ventral muscle bands we refer to the derivation given in Part I. of the similar mass found in the same place in *Apus*. And further we can point to the entapophyses

in *Limulus* as homologous with the points of attachment of the dorso-ventral muscles in *Apus*, marked *p* in figures 66 and 67.

*The Nervous System.*—The nervous system of *Limulus* is especially important and interesting. In many respects it is more primitive than that of *Apus*, for example, in the position of the brain. On the other hand, again, owing to the greater specialisation of the whole body, it is in some respects more specialised.

In describing our bent Annelid we naturally found it necessary to assume that the brain was originally in the prostomium or labrum. In *Apus*, owing to the wandering of the eyes forwards and upwards, the brain followed the eyes, splitting the œsophageal commissures into a sympathetic ring and a cerebro-œsophageal ring. *In Limulus the brain has retained its original Annelidan position.* It need hardly be said that this is a very striking confirmation of our derivation of *Apus* from a bent Annelid. We had quite lost sight of this fact when we stated that in the original Crustacean-Annelid (shown in Fig. 18, p. 69) the brain was in the prostomium, and that in *Apus* it had wandered from its place through secondary adaptations. Thus the very difference in the position of the brains of *Apus* and of *Limulus* affords a conclusive proof of their real relationship as derived from the same bent Annelid.

It is almost equally important for our argument to note that, as Ray Lankester pointed out, the brains of *Apus* and *Limulus* are alike in constitution, both

being very nearly pure archicerebra. They consist almost wholly of the ganglia for the eyes and ocelli in *Limulus*, and of the eyes and unpaired sensory body in *Apus*. In *Limulus*, according to Packard, the brain is not complicated by the presence of the ganglia for the antennæ; in *Apus*, however, according to Pelse-neer, the ganglia for the first antennæ have joined the brain. In the great simplicity of the brain, these two animals are, Lankester states, almost unique.

The eyes in *Limulus*, in wandering forwards and outwards, were unable to take the brain with them, but are simply connected with the brain by long, and not very important, nerve fibres. These nerve fibres have the same relative position on the brain as the stalks of the optic ganglia of *Apus*. Between the two optic nerves, a pair of nerves is found running to the pair of ocelli which lie anteriorly near the middle line. We have already referred to these median ocelli of *Limulus*, as some support for our argument that the median sensory body in *Apus* arose out of an anterior pair of eye-spots on the prostomium of the original Crustacean-Annelid. The position of the points of departure of the nerves to these ocelli agrees exactly with that of the nerves to the unpaired "eye" of *Apus*. In *Limulus* there are other nerves leaving the brain from between the optic nerves besides those to the ocelli. In *Apus* we found that the sensory body is composed of four retinae, with four nerves running to the brain. If we homologise the lateral retinae with the ocelli, the nerves from the postero-dorsal and ventral

retinæ might correspond with a pair of the other nerves just mentioned which leave the brain near those of the ocelli. The different shape and grouping of the sensory cells of the postero-dorsal and ventral retinæ from those of the lateral retinæ seem to indicate that they must have been derived from some other sensory organs.

Owing to the backward prolongation of the mouth and the œsophagus, and the arrangement of the limbs round the former, the anterior nervous system is very concentrated; the nerves for the anterior antennæ and the five pairs of limbs branch out radially from the thickened œsophageal commissures. It is as if the œsophagus had forced its way backwards between the two longitudinal commissures of the nerve cord, forcing apart the separate pairs of ganglia of the first five pairs of limbs, the four transverse commissures of which arch over the slanting œsophagus.

Between the nerves to the fifth pair of limbs and those to the operculum is a pair of nerves to the chilaria or under lip. If the homology of the chilaria with the under lip of *Apus* is correct, these nerves have been carried back with the under lip, in the drawing back of the mouth.

The ventral cord of *Apus* is more primitive than that of *Limulus*, which, at its posterior end, is much modified. This specialisation of the ventral cord of *Limulus* is in correspondence with the great concentration of its body as compared with that of *Apus*. In *Apus* the posterior end was found in a rudimentary and larval condition.

The arterial envelope surrounding the nervous system will be referred to later in the paragraph on the circulatory system.

*The Sensory Organs.*—We have already (Fig. 22, p. 91) described and figured the eyes of *Limulus* in order to explain the origin of the typical Arthropodan eye of *Apus* from the Annelidan eye-spots. It is of no small interest to remark that we had selected the eye of *Limulus* as a guide towards explaining the origin of the Crustacean eye at the very outset of our investigation, when we were entirely occupied in attempting to deduce *Apus* from an Annelid, and long before it occurred to us that *Limulus* was probably related to *Apus*. The establishment of the relationship between the two thus lends considerable support to the theory put forward in Part I. as to the possible development of the Arthropodan eye out of an Annelidan hypodermal eye-spot by the thickening of the cuticle. If this deduction is correct, then the eye of *Limulus* is more primitive than that of *Apus*. This indeed we might expect from the manner of life of the two, the free-swimming form naturally having the more perfect visual organs, while *Limulus*, which burrows in mud or sand and lives practically under a roof, has eyes comparatively weakly developed.

The wandering of the eyes from the ventral surface on to the dorsal, which we found indicated by the bend of the cerebro-oesophageal commissures in *Apus*, is here shown in an equally interesting way by the upward, forward, and outward bend of the long optic

nerves. Their very length, when compared with the usual distance between eyes and brain throughout the animal kingdom, is a clear indication of displacement.

The anterior pair of Annelidan eyes, which in *Apus* went to form the unpaired "eye," are represented in *Limulus* by a pair of ocelli. The wandering of these ocelli on to the dorsal surface can still be traced in the course of the animal's development. According to Packard, the ocelli at their first appearance in the embryo are on the ventral side, and travel on to the dorsal side before the young animal is hatched. The true significance of this fact has already been dwelt upon, and has been compared with a similar, though not so pronounced, wandering of the eyes in the Nauplius as shown in Figs. 36 and 37. The presence of the ocelli on the ventral surface of any ancestor of *Limulus* would be difficult to explain by any other theory than that of our bent Annelid. The nerves to these ocelli branch from the brain from the same place as do those to the unpaired "eye" in *Apus*, *i.e.* from between the optic nerves.

Judging from the lateral retinae of the sensory body of *Apus*, and also from the fact that the posterior eyes are compound, we should have expected compound eyes and not ocelli as the anterior pair in *Limulus*. In certain Trilobites (*e.g.* *Harpes*), according to Barrande, these ocelli are not single but composed of groups.<sup>1</sup> It seemed to us that these might perhaps form an interesting connecting link between

<sup>1</sup> See Packard's paper on the structure of the eye of Trilobites. *American Naturalist*, July 1880.

retinulated compound eyes and the single ocelli of *Limulus*. We find, however, that the ocelli of *Limulus*, according to Lankester's and Bourne's figures, are only ocelli in the sense that they have but one large cuticular lens; the retinal cells under them being grouped in retinulæ. The presence of retinulæ essentially of the same shape as those under the conical cuticular projections in the paired eyes (see Fig. 22) suggests that this large cuticular lens has arisen by the coalescence of a number of such crystal cones; otherwise, according to our view, it would be difficult to account for the retinulæ, which we think first arise by the grouping of the sensory visual cells round the tips of the conical refractive processes. If this is the case, the ocellus of *Limulus* is not due to an independent utilisation of a special form of cuticular thickening, as we think is the case in such an eye as that of the *Dytiscus* larva, but, as stated, to a coalescence of the separate crystal cones to form one large lens. The original compound eyes with their separate cones probably formed weak spots in the anterior shield, and therefore gradually developed large single lenses by the concrescence of the cones. One consequence of the change is, according to our theory, clear, and that is that the retinulæ, being no longer grouped round crystal cones, are, *as retinulæ*, comparatively useless. We turned, therefore, with great interest to Lankester and Bourne's account of these retinulæ, and found what we expected, that they are by no means so definite as

those of the lateral eyes, their irregularity suggesting their slow disorganisation.

The very differences then which we find between these sensory organs in *Limulus* and *Apus* are in reality more confirmatory of our theory than any exact similarity could possibly be. Similarity could only help to establish the relationship between the two animals. As it is, we have a sufficiently striking likeness with just those differences which are only to be explained by deducing both animals from a common Annelidan ancestor, in the way described in this book.

*The alimentary canal* has, as already described, the important bend which we refer both in *Limulus* and in *Apus* to the bending round of the whole Annelidan body. The chitin-lined œsophageal portion is more highly differentiated than in *Apus*; its oral portion is lengthened out posteriorly (or morphologically anteriorly), showing the same longitudinal folds of its intima as we found in the œsophagus of *Apus*. Its anterior portion is widened out to form the so-called pro-ventriculus, the chitinous folds of which are so pronounced and differentiated that they probably help in the trituration of food. We here have the homologue of the masticatory stomach of the higher Crustacea. The posterior end of this projects like a conical crater into the mid-gut, as it does to a much slighter extent in *Apus*. The mid-gut runs almost to the end of the body, receiving in its course, on each side, two hepatic ducts from the much branched "livers," which fill up a large portion of the cephalo-



thorax. In Apus we have a more primitive stage, in that the livers are still clearly little more than digesting diverticula of the mid-gut, at whose branched ends only are found the hepatic glands. In Limulus, the glandular portion is far more pronounced, and the diverticula themselves are diminished to bile ducts, as is the case in the higher Crustacea.

The very difference between what we find here and in Apus is instructive ; perhaps, from the fact of there being two ducts on each side, we can conclude that there were originally two or more intestinal diverticula in Apus. The general form of the liver of Apus certainly looks as if it consisted of two or more diverticula run together at the places where they open into the mid-gut. Embryologically (according to Packard), the livers of Limulus begin as simple biliary tubes, the branchings following later. The development of the liver as outgrowths of the mid-gut is well shown in Claus' figures of the Nauplius (Figs. 39, 41).

The rest of the alimentary canal offers nothing special for remark ; like that of Apus it has a short rectum, the chitinous intima of which is thrown into longitudinal folds by the musculature. It is worth noting that, whereas the anterior half of the mid-gut is very thin-walled, it gradually gets thicker and more muscular as it approaches the rectum ; there is no sharp division between the two. This is exactly what we found in Apus.

*The circulatory system* of Limulus is very highly specialised. We do not, as already stated in Part I., lay much value upon it from a morphological point

of view. This specialisation of the blood vascular system in *Limulus* is a very good illustration of the principles stated on p. 117. The compression of the body of *Limulus* against the vault of its own shell would lead to the development of special vessels to supply those parts which, because of compression, would not otherwise receive their proper share of blood. Thus we may consider the circulatory vascular system of *Limulus* either as a modification of that of the original Crustacean-Annelid, or as secondarily acquired. The latter view is more probably the correct one. In the first place, the type of the system is hardly that of an Annelid, and in the second place, the arterial envelopes surrounding the nerves are clearly secondary specialisations in adaptation to the peculiar physiological needs of the animal.

The Annelidan character of the long dorsal vessel with eight pairs of ostia needs no special notice; it speaks for itself in showing that at least in this respect *Limulus* is not so far removed from the Annelids as its highly specialised form would have led us at first sight to imagine.

*The genital organs* in *Limulus* are considerably more specialised than in *Apus*. The comparative shortness and flatness of the body hinders the primitive metameric arrangement which we find in the latter animal. The eggs appear to develop towards the lumen of the gland instead of outwards towards the body cavity. This advance on *Apus* is what we should expect from the compression of the whole body, and the consequent diminution of the body cavity.

The spermatozoa are filiform as in the carnivorous Annelids, but this fact is of no great morphological importance. The genital aperture is situated on the posterior face of the operculum, *i.e.* on the second trunk limb; in *Apus* it is between the tenth and eleventh trunk feet. There were originally nephridial openings between the limbs of all the more developed trunk segments; hence this difference between *Limulus* and *Apus* is of no importance.

*Development.*—We have already pointed out that the absence of the Nauplius stage in *Limulus* is no real difficulty. We should only expect a Nauplius stage in *Limulus* inasmuch as the Nauplius is the larva of the original Crustacean-Annelid. The great specialisation of *Limulus*, apparently so unlike its Annelidan ancestor, readily explains its direct development without passing through any such stage. Its metamorphoses are all passed through within the egg; we thus learn nothing of its early ancestors. Its so-called “Trilobite stage” receives, however, a new interest from our theory, which includes the Trilobite also among the descendants of the same bent Annelid.

We conclude, then, from the comparison between *Apus* and *Limulus* that both animals have developed from the same bent Crustacean-Annelid; hence the similarity in their organisation. Although their further development has travelled along slightly different lines, their striking differences are in most cases easily explained by the one having retained more primitive Annelidan characteristics than the other.

Returning to the subject of the shield, while in *Apus* the dorsal integument of the fifth segment developed a large shell fold, we see no need for believing that in *Limulus* there was ever a dorsal shield projecting backwards as a fold. When we come to consider the Trilobites we shall find reason to believe that the frontal ridge was in all these animals older than the dorsal shield, and had a different origin, the dorsal shield itself being a later development. In *Limulus*, as in many Trilobites, the ridge round the front of the head is produced backwards on each side to form two horn-like processes. But we reserve the further discussion of this most interesting subject for the next section, where it will be more in its place, as in the Trilobites almost every possible variation of the same essential type of cephalothoracic shield is found, for the defence of the anterior bent, and therefore exposed, segments. We shall then see some reasons for concluding that only those primitive Crustacea which developed shields, *i.e.* either dorsal folds like the Apodidæ, or bivalve shells like the Ostracoda, survived, *Limulus* being probably the only exception to this rule. In many modern Crustacea, however, these shields have again secondarily disappeared.

## SECTION XIII

### THE TRILOBITES

IN this appeal to the ancient Crustacean forms to ascertain whether they lend any support to our theory of the origin of the class, we began with *Limulus*, not because it is more nearly related either to *Apus* or to our bent Annelid than are the Trilobites, but because its anatomy is so well known that it admitted of closer comparison, and further because its relation to the Trilobites is fairly well established. It thus formed a sort of link for the purposes of our comparison, to connect the Apodidæ with the Trilobites and the Eurypteridæ. That *Limulus* and the Trilobites are closely related is now generally acknowledged.

Having shown that *Limulus* is, like *Apus*, derivable from a bent Annelid, if we can only show that the organisation of the Trilobites is also best explained by attributing to it a similar origin, we shall be able to group the Xiphosuridæ, the Trilobites, and the Apodidæ for the first time in a natural system.

It is important to bear in mind that the Trilobites

are the earliest known Crustacean forms. A special interest therefore attaches to our endeavour to prove that they were nearly related to the Apodidæ. Starting from a purely morphological and anatomical standpoint, we endeavoured to show that *Apus* was a modified Annelid, and, therefore, a primitive Crustacean. Our finding that the Nauplius, or the earliest known larval stage in Crustacea, is but a young *Apus*, went far to show that our reasoning was correct. If now we can further show that the earliest known Crustaceans are easily connected with the Apodidæ as related forms, it seems to us that our case is established. Such concurrent testimony from developmental history and from palæontology is almost without parallel.

The relationship of the Apodidæ and the Trilobites has already been assumed by the earlier zoologists. Burmeister,<sup>1</sup> indeed, tried to reconstruct the Trilobites on this assumption, and attributed to them the typical Phyllopodan limbs, and described them as swimming about in the palæozoic seas. Although Burmeister's reconstruction was not correct, yet his assumption of a relationship between the two was justified. The fact that the Apodidæ have rowing limbs does not in any way oblige us to assume that if the Trilobites were related to the Apodidæ they must have had similar limbs. As a matter of fact we

<sup>1</sup> Cf. "Die Organization der Trilobiten aus ihren lebenden Verwandten entwickelt," and further the historical review given by Walcott in his paper, "The Trilobite. Old and new evidence relating to its organisation."

now know that the Trilobites had ambulatory limbs (see Fig. 51). The two sorts of limbs are, as we shall see, but different modifications of the Annelidan parapodium.

The Annelidan character of the outer form of the Trilobites is not so much disguised as at first sight it seems to be. But for its large head-shield it might well have passed for a flattened Annelid. Anteriorly we have the crescent-shaped head, followed by a variable number of movable segments, and posteriorly a number of more or less rudimentary segments, often fused together to form a tail-plate.

Taking the three parts separately, and deducing them from our primitive Crustacean-Annelid, we shall find that much light is thrown upon many hitherto obscure points in their organisation.

(I.) *The Head*.—The Trilobite head is composed of the five anterior segments of our Annelid, bent round so that the mouth opens ventrally and faces posteriorly, as described for *Apus*. The large labrum was originally the prostomium of the Annelid. Fig. 46 is a longitudinal section through a Trilobite, which we had not seen till the first part of this book was in MS., and which afforded a most unexpected confirmation of our argument. Anteriorly and dorsally the bending of the soft cylindrical body gives rise to the glabella, as the characteristic swelling in the median line of the Trilobite head is called. This is the convex surface of the bent Annelidan body, and is retained only in the Trilobites. In *Apus* it is completely disguised by the growing together of the

frontal ridge and the dorsal shield, but it is always more or less visible in the Trilobites, which formed no such dorsal fold. Round the glabella is developed the remarkable crescent-shaped ridge which runs round the front of the head, such as we found in *Apus* as a prolongation of the lateral edges of the shield. In the Trilobites, this ridge is often very pronounced, forming a wide margin round the head, with horns sometimes stretching back far beyond the posterior end of the body (see Figs. 47 and 57, p. 257). The origin of this ridge is probably to be sought in the folds

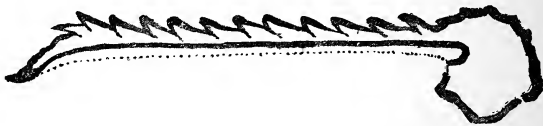

FIG. 46.—Longitudinal section through *Ceraurus pleurexanthemus* (after Walcott), showing the intestinal canal and ventral membrane, and the bend in the head. Cf. Figs. 1 and 2.

which would naturally arise ventrally and laterally in the bend of the soft body; the bend is so sudden that we may well imagine the folds forming projecting angles at each side like the angles formed by the bending of an india-rubber tube. This comparison would be almost exact if we imagine the convex curve of the tube so stretched as not seriously to diminish the size of its lumen, as must have been the case in the bent Annelid to prevent compression of the viscera. That the sides of the angle of the bend did thus project we conclude from the position of the second antennæ both in *Apus* and in *Limulus*, where



they lie outside the longitudinal line which joins the other limbs. The development of hard cuticular points, and thence of thorns on such lateral projections, would be but a matter of time. From these points also the gradual development of the ridge round the front of the head can easily be imagined. In some Trilobites it remains quite inconspicuous, but

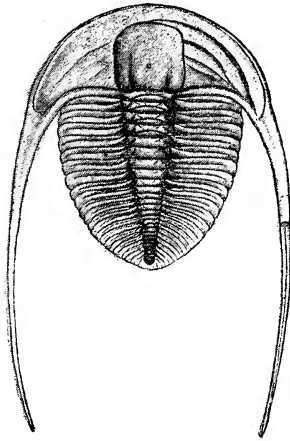

FIG. 47.—*Dionide formosa* (Barr), showing the glabella and the gradual rudimentary character of the posterior segments.

in others, as already stated, it projects as a great shovel-shaped margin. We here find, then, the origin of all forms of the Crustacean shell, which we have deferred discussing till now ; we may summarise our conclusions as follows :

Round these lateral projections, due to the bending of the cylindrical body, all the shapes of the Trilobite

head-shield play. We are inclined to think that the formation of the ridge round the front was the primitive variation, because of its great use as a belt-like shield round the unprotected head of the browsing animal, especially if it went hand in hand with the thickening of the cuticle of the frontal surface. The lateral processes and the frontal ridge thus formed the primitive head-shield of this whole group of Annelidan-Crustacea, and every form of shell-covering may have been developed out of this primitive shield. As a matter of fact we find almost every possible variation of this ground form. The cephalothoracic shield of *Limulus* is one form, due to its fusing with the two anterior trunk segments. But by far the most important of all these variations was the development of this head-shield backwards over the trunk to form a cover such as that of *Apus*. We have already described (p. 15) the probable origin of this shell as a fold of the tergum of the fifth segment developed to carry thorns for the protection of the exposed dorsal surface, the head being bent round ventrally. A Trilobite, *Acidaspis Dufrenoyi* (Fig. 48), shows us the neck-lobe developed into the kind of thorn-carrying fold we had imagined. Such a fold as that possessed by *Acidaspis*, if a little wider and carrying more thorns, could very easily develop backwards over the trunk into a shell fold, such as that possessed by the Apodidæ, the thorn-carrying function eventually giving way to that of forming a cover for the dorsal surface.

But this is not the only form of shell which can be

derived from the primitive head-shield above described. The bivalve shells of the Ostracoda can also be deduced from the same by the clapping together of the two wings of the crescent-shaped ridge against the sides of the body as illustrated in Fig. 57, p. 257. When this crescent is large, owing

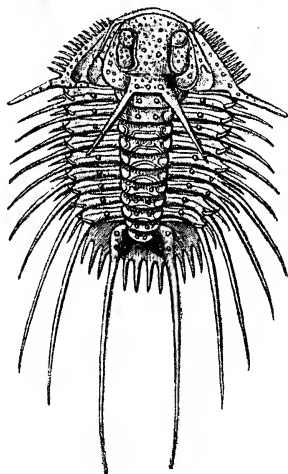

FIG. 48.—*Acidaspis Dufrenoyi* (Barr), Upper Silurian (after Barrande, from Zittel's *Handbuch*). Showing the fold of the skin carrying two prongs projecting backwards just behind the glabella, to demonstrate the probable origin of the dorsal shield of *Apus*.

to the great development of the shovel-shaped ridge round the front of the head, the lateral folding of these wings round the rolled-up body would yield a bivalve shell. Another obvious method of producing the bivalve shell is by the folding down of the edges of a dorsal shell such as that of *Apus*. These

two origins are, however, clearly quite different; we shall find later that they help us greatly in understanding the striking difference between the Ostracoda and the other Crustacea possessing bivalve shells.

In the meanwhile the development of shells directly from the primitive head-shield seems to have taken place in two directions.

(1) By the development of the posterior edge of a neck-lobe, or dorsal fold of the fifth segment, at first carrying the thorns, as shown in Fig. 48, and later forming a covering for the back.

(2) By the growth and folding down of the wings or horns of the crescent-shaped head-shield against the sides of the body.

To these two shell formations we shall however return in discussing the probable origins of the modern Crustacea. We shall also have again to refer to the importance of the formation of such shields protecting the whole body, and to the advantages which they offered over all the other variations of the head-shield.

We conclude then that the shield of *Apus* was not the primitive formation; the ground type was, we think, the head-shield, every variety of which we find in the Trilobites. Thus although, in *Apus*, we spoke of the ridge round the head being the prolongation of the lateral edges of the shield, strictly speaking the ridge and the shield were two independent developments of the primitive Trilobitan head-shield, the former starting forwards from the lateral projections necessitated by the bending of the cylindrical body,

the latter the posterior development of the neck-lobe as shown in Fig. 48.

(II.) *The Trunk Segments.*—The greatest difficulty in homologising these segments with Annelidan segments is that we find the crescent-shaped head followed by segments repeating, in their pleura, the form of the head, whereas at first sight we should expect the head to be followed by a row of Annelidan segments as in *Apus*, *i.e.* a continuation of the glabella alone, as was no doubt originally the case. The gradual acquisition on the part of the trunk segments of their highly developed pleura repeating the characteristics of the wings of the head is probably to be explained as follows:—As soon as the typical Trilobite head-shield became an important factor in the struggle of each species for existence, it would tend to appear earlier and earlier in the larva; the Trilobite Nauplius would then be little more than a generalised Trilobite head with an anal segment. Between these two parts the segments were gradually differentiated, so that the characteristics of the head might very well make themselves felt in the development of the segments, and in this way spread gradually backwards to the posterior end of the body. This, indeed, we find to be the rule in many Trilobites; the most specialised segments are immediately behind the head, while posteriorly they are more and more simple. In this way then the segments of the Annelidan trunk were gradually provided with the pleura characteristic of the Trilobites; their pleura being segmental repetitions of the lateral projections of the head-shield.

The variation in the number of trunk segments is also a point of no small interest. While some authors have tried to classify the Trilobites according to the number of the trunk segments, Barrande has shown that even within the same genus the number is quite inconstant, the different species varying greatly in this respect, in *Olenus* 9-15, *Cyphaspis* 10-17, &c. This is exactly what we find in the Apodidæ, where the number of segments varies greatly: from 60-65 in *A. cancriformis*, to 40 in *L. glacialis*. We have already discussed the importance of this inconstant number of the segments in our argument that the Apodidæ stand half way between the Crustacea, with their small constant number of segments, and the Annelida with their large inconstant number. But the argument has not the same weight here as it had in our endeavour to show that the Apodidæ were very primitive Crustacea, because in the case of the Trilobites the fact is already apparent from their geological position; still it is an important characteristic which they have in common with the Apodidæ, and as such is so much positive evidence in favour of our argument that both are derived from the bent Annelid.

(III.) *The Pygidium* is a more or less constant characteristic of the Trilobites. It is the posterior region of the body, composed of a varying number of segments fused together, so that the whole region forms a stiff plate, a sort of tail-shield answering to the anterior head-shield. The morphology of this pygidium has been as little understood as that of the

posterior end of the body of *Apus*; our explanation of the one also explains the other.

We find, in fact, almost the same as we find in *Apus*, that the posterior segments remain in an undeveloped or larval condition; although the gradual tapering away and diminution in length of the segments is not visible in all species, yet where it is no longer visible it must be assumed to have secondarily disappeared. In some cases these rudimentary segments develop sufficiently to hinge upon one another and to bend in the sagittal plane, or perhaps the bending may have been effected as in *Apus* by the development of rings which do not correspond with true segments. In very many cases, however, the segments are so rudimentary that they are unable to bend upon one another, and hence together form the stiff plate under discussion—the pygidium (see Fig. 50). We thus deduce the pygidium not strictly from *fused* segments but from segments too rudimentary to bend upon one another.

It has been noticed as a somewhat remarkable fact that the trunk segments appear after the pygidium, the young larva consisting of the head and the pygidium, and between these two the thoracic segments are gradually interposed. This is a most interesting case of the shifting back on to the larva of important characteristics. The pygidium, being probably useful in the rolling up of the larva, is thus very early developed, and is then analogous to the anal segment in the *Trochophora* larva, although morphologically it is composed of a number of rudimentary segments.

We have, as has already been pointed out by many authors, the parallel case of the Zoæa, in which the abdomen which is useful to the larva for swimming is developed before the posterior thoracic segments.

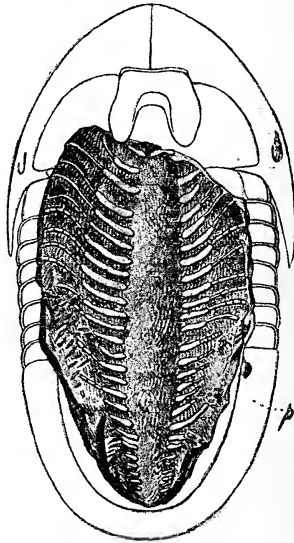

FIG. 49.—*Asaphos megistos* Hall (after Walcott), showing the well-developed ventral parapodia, and the gradual simplification of the limbs from before backwards, as in *Apus*. *Cf.* Frontispiece; *p*, pygidium.

The *Limulus* larva, in which the same thing occurs, is on this account called by Packard a Zoæa.

Having mentioned this habit of rolling up, we may as well here point out that it also forms a link of connection between the Trilobites and the Crustacean-Annelid, it being easily explained as the perfection



of a very natural action which we may safely assume went hand in hand with the development of the primitive head-shield already described. At the approach of an enemy the forehead would be pressed against the ground, the thorns, if there were any on the posterior dorsal fold of the fifth segment, would be somewhat erected by the bending under of the head or humping of the back. In such simple movements we have the first step towards rolling up.

This method of defence by rolling up is one of considerable biological interest (see Fig. 54). In one way it is a very perfect method of defence, but in another it is very fatal. Its perfection is clear from the periods of geological time through which the Trilobites lived; its fatality in the fact that it admits of no further development. Hence the Trilobites, at least all which failed to develop shells, have died out, as unable to protect themselves from new and more powerful enemies, or from old enemies when these latter had once learned to overcome this method of defence. The development of shell folds, which, except in the case of bivalve shells, are clearly inconsistent with the habit of rolling up, render it unnecessary. They make it possible to develop new and more plastic methods of defence, to which we owe the preservation and the rich and varied development of the whole class of modern Crustacea.

*The Trilobite Limbs.*—In spite of the great progress which has been made in our knowledge of the limbs of

the Trilobites, chiefly through the patient researches of Walcott, they are still shrouded in a certain amount of mystery. We believe that it will be found that our derivation of the Trilobites from a bent Annelid will throw considerable light upon the beautiful series of sections made by Walcott, by giving a new clue to the interpretation to be put upon them.

One difficulty, for instance, which has been found in classifying the Trilobites with the Crustacea is the absence of any trace of limbs (*i.e.* of antennæ) in front of the mouth. This, however, from our point of view is no real difficulty. In reality the antennæ of *Apus* are hardly in front of the mouth but in a line with it, and both are more or less rudimentary, from being caught in the angle of the bend. This same bend was equally sharp in the Trilobites (see Fig. 46). Why may not the antennæ have been in this bend, and as rudimentary as they are in *Apus*? We shall try to answer this question in the following pages.

We have, in Walcott's restoration (see Fig. 50), posteriorly to the labrum, three small limbs with masticatory processes, followed by a large pair of locomotory limbs with especially large ventral parapodia for mastication. For reasons given above (pp. 44, 190) we homologise these large locomotory limbs with the sixth pair of typical Crustacean limbs, *i.e.* with the *first pair of trunk limbs*. The three pairs of limbs anterior to these are therefore homologous with the mandibles and the two pair of maxillæ of the typical Crustacean head. In front of these and behind the labrum, we have, in Walcott's restoration (Fig. 50), a

space in which we think the antennæ should have been drawn. That they were present we have little doubt, probably somewhat reduced, as in *Apus*, and pointing backwards. Our reasons for thinking that there must have been two pairs of antennæ as here de-

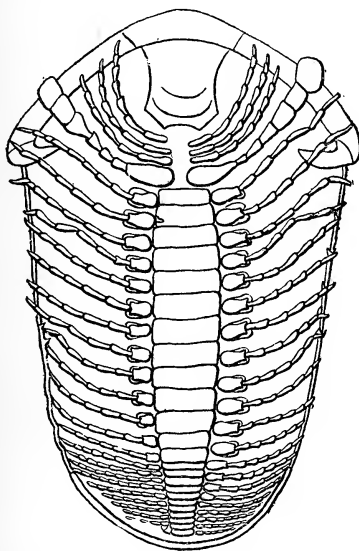

FIG. 50.—Ventral surface of *Calymene Senaria* restored by Walcott (from Zittel). Assuming that the large pair of locomotory limbs are the sixth or first trunk limbs. The two pairs of antennæ are missing—they should probably be drawn in on each side of the prostomium projecting backwards, as in *Apus*.

scribed, are two, apart, that is, from the general reasons founded upon our theory of their relationship to *Apus* through common descent from a bent Annelid.

(1.) Figs. 51 and 52 are sections passing through the prostomium (labrum or hypostoma) of two Trilo-

bites. In the second of these they are cut through along the line shown in Fig. 53. These transverse sections through the head and labrum certainly seem to indicate the presence of such antennæ as we have described, at least they seem to show that there were appendages of some sort starting out sideways from each side of the labrum, just as in *Apus*. It is perhaps possible to interpret all these fragments of limbs shown in the sections, both those seen springing from the sides of the labrum, and those scattered about the section, as parts of the limbs of the hind-body,



FIG. 51.—Sections through *Ceraurus pleurexanthemus* (after Walcott) passing through the prostomium, showing traces of limbs springing out from each side of the same, which we assume to be homologous with the antennæ of *Apus*; the fragments of limbs at the sides may be those of trunk limbs brought near the mouth by the rolling up of the animal.

which when the animal is rolled up are naturally brought up to the mouth. This, however, does not seem to be so probable as our supposition, founded upon a comparison with *Apus*, that those actually starting from the sides of the prostomium are traces of true antennæ, because :

(2.) We think that, if the place assigned by Walcott to the three posterior head limbs is correct, *some form of antennæ must have been present*, if not as antennæ then as mouth parts of some kind. According to our theory, one of the chief advantages of the bending round of the anterior segments was the

possibility of using the parapodia as instruments for pushing food into the mouth; and indeed, whether our theory is correct or not, we doubt if any case will be found of a Crustacean mouth without limbs as mouth parts closely bordering it. Walcott's restoration, given in Fig. 50, is therefore so far incomplete. The mouth, which is covered by the large labrum, *must* have had some kind of appendages bordering it on each side. When therefore we find clear traces of such

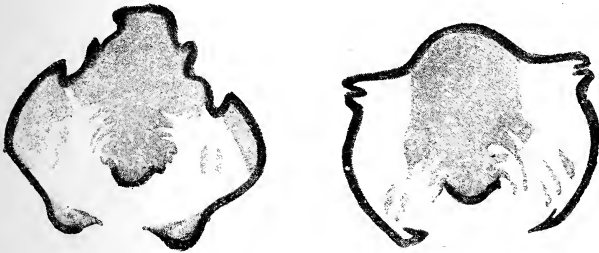

FIG. 52.—Sections of *Calymene Senaria* (after Walcott) passing through the prostomium, showing traces of limbs springing out from each side of the same, which we assume to be homologous with the antennæ of *Apus*; the fragments of limbs at the sides may be those of trunk limbs brought near the mouth by the rolling up of the animal. The section passes along the line shown in the next figure.

limbs in the sections (Figs. 51, 52), we think we are justified in claiming them as such.

It will no doubt be objected that these two reasons are only sufficient to show that there were limbs as mouth parts on each side of the mouth, near the labrum, but not that they were the homologues of the Crustacean antennæ. This homology depends, it is true, upon the truth of our main argument that the Trilobites, like *Apus*, were originally bent Annelids,

and further, upon our homology of the large locomotory limbs with the first trunk limbs; to this latter point we shall return. In the meantime we assume that these two reasons, taken together with our whole argument, are sufficient to establish the fact that the Trilobites possessed two pairs of antennæ like the Apodidæ and the typical Crustacea.

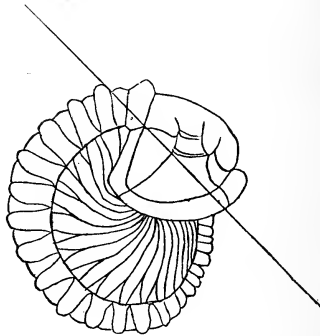

FIG. 53.—Rolled-up specimen of *Calymene Senaria* (after Walcott); the line through the head is the line of the sections in Fig. 52.

When now we come to ask how these antennæ were developed, we can only conjecture that in some way or other they must have supplied the opening of the œsophagus with jaws, or perhaps with simpler instruments for pushing in food. It is improbable that the first antennæ should develop their ventral parapodia as jaws, firstly because it is almost certain that the original Annelid-Crustacean had already lost all traces of the parapodia of the first segment, the

first antennæ being simply sensory cirri ; and secondly because in no other group of early Crustaceans do the anterior antennæ show any traces of ventral parapodia as masticatory ridges. In Eurypterus, where the method of life we attribute to the animal would certainly have developed them into jaws had it been possible, they almost entirely disappear. On the other hand, we have examples of the second antennæ developing their ventral parapodia as masticatory ridges, not only in *Limulus* but also in *Eurypterus*.

We are thus disposed to complete Walcott's restoration by adding a small pair of anterior antennæ on each side of the labrum, and a pair of posterior antennæ, developing, probably as their most important part, a pair of jaws strong enough, if not to crush and destroy, at least to push food into the opening of the œsophagus ; whether the sensory part was developed or not is not so easy to decide.

It may be noticed that it was not so necessary for the Trilobites to have large crushing jaws under the labrum, as the masticatory ridges of the first trunk limbs were, as in the Eurypteridæ, highly developed to function as chief mandibles. The crushed food would have to be forwarded towards the opening of the œsophagus, and then pushed in by special appendages at the sides of the opening. This point is almost as interesting from a biological as from a morphological point of view. We have already had two entirely different combinations of head appendages as jaws. In *Apus*, the third and fourth head limbs form the mandibles (or chief

jaws) and maxillæ. In *Limulus* we have five pairs of nearly equally important jaws, on the four last head, and first trunk, limbs. In the Trilobites we find the mandibles, or chief jaws, between the first trunk limbs, and masticatory ridges for pushing the food into the mouth, as in *Limulus*, on the four posterior head limbs. In the Eurypteridæ we shall find further combinations. We may perhaps find in these different attempts to develop the best arrangements of mouth parts almost as important a factor in the development of the class of the Crustacea as we think we have found in the development of the shield. There can be no doubt that while it offered some advantage to use the ventral parapodia of the most powerful limbs as jaws, this must have been attended by certain disadvantages. To this important subject we shall return.

We repeat here what we said on p. 43, that we might with some safety establish a rule that the closer the forehead was pressed against the ground the less likely would the antennæ be to function as antennæ; they might either degenerate as they have done in *Apus*, and, according to Walcott's restoration, in the Trilobites, or they might function as seizing organs or mouth parts, as in *Limulus*. We shall have occasion later to see the converse of this rule, and shall find that the raising of the head leads not only to the further development and pointing forwards of the antennæ as sensory organs, but also to the travelling of the antennæ themselves towards the anterior end of the body, an advantage for the animals which has enabled



them to hold their own to-day, whereas *Limulus* and *Apus* are probably the only surviving Crustacea which retain the original position of the Annelidan antennæ.

As above pointed out, our interpretation of the head limbs of the Trilobites rests largely upon our homologising the large locomotory limbs with the sixth pair of Annelidan parapodia, or with the first trunk limbs of the Crustacea. Our adoption of this large locomotory limb throughout all the primitive Crustacea as the first trunk limb, for reasons given p. 44, receives some support from Walcott's restoration, where it lies behind the line which runs from side to side, through the widest part of the head, which is morphologically the line round which the body bent. We have already seen, further, that *Limulus*—and we shall see that the Eurypteridæ, with some exceptions—not only possessed the two pairs of antennæ, but also the large locomotory limbs as the sixth pair, *i.e.* the first pair of trunk limbs.

It should be mentioned that so far as these conclusions are based on the few sections published in Mr. Walcott's paper, his conclusions are undoubtedly of much greater value than ours, inasmuch as they were based upon a much more extended study of sections, and of the whole Trilobite problem. We have, however, to set, as against this, our claim to have found in *Apus* a key to the true understanding of the morphology of all these primitive Crustacea.

The form of the trunk limbs in the Trilobites does not at first sight admit of any close comparison with

those of either *Apus* or *Limulus*, but by closer study, and by referring them back to the original Annelidan parapodia, their common origin becomes evident. We find the limbs much specialised, the habits of life of the animal leading to certain modifications. In the first place, the creeping motion along the ground required the development of legs. In the second place, the habit of rolling up requires that the limbs should take up as little room as possible,

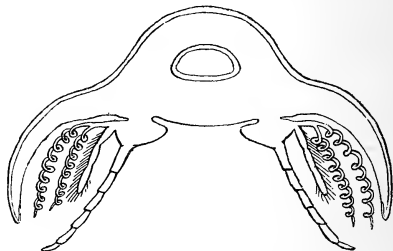

FIG. 54.—Restored transversed section through *Calymene Senaria* (after Walcott), showing the spiral gills, the exopodite (= the sensory cirrus of the dorsal parapodium), the endopodite, or ambulatory foot (= the dorsal parapodium), and the thigh piece or coxal joint, the ventral projection of which corresponds with the ventral parapodium, *cf.* Fig. 49.

first, to render the rolled-up attitude mechanically possible, and second, in order that as much of the respiratory medium as possible may be enclosed. The special form of the limbs can thus be understood. We find (Fig. 54) a large basal joint, the inner ventral part of which is almost certainly to be homologised with the ventral parapodium of the Annelid. This again originally functioned as a gnathobase or accessory jaw for the holding and forwarding of food to the mouth, *i.e.* on a certain

number of limbs not too far from the mouth. It was, no doubt, as in *Apus*, much reduced in other parts of the body, in order not to occupy much space.

The ambulatory limb, if our homology is correct, was the prolonged tip of the dorsal parapodium, and thus homologous with the endopodite of other Crustacea. The exopodite was the sensory cirrus; and here, no doubt in correspondence with the needs of the animal, it retained its position close to the gills, and its filiform shape; it did not travel along the prolonged dorsal branch of the parapodium, or develop into a rowing flabellum as in *Apus*. The modification of the gills into spirals, &c., is also very easily explained on the grounds given above. The animal required respiratory organs which afforded as large a respiratory surface as possible while occupying the smallest possible space, such respiratory organs being essential to the habit of rolling up.

Before dismissing the subject of the form of the Trilobite limbs, we wish to return for a moment to Burmeister's assumption, that if the Trilobites were related to *Apus* they must have possessed Phyllopodan limbs. This, however, is by no means necessary. What is generally known as the typical Phyllopodan limb is but one of the ways in which the Annelidan parapodium developed, the Trilobite ambulatory leg being another and quite independent modification the parapodial type being visible in both. The modifications are due to adaptations to the different manners of life adopted by the different groups.

The development of the ventral parapodium into mandibles and gnathobases is a common specialisation in all the groups, this being the most primitive modification according to our deduction of the Crustacea from a carnivorous Annelid, which caught prey between its ventral parapodia and forwarded it on into the mouth, bent round to receive it. The dorsal parapodia, being chiefly used for locomotion, have however been differently developed according to the different methods of locomotion adopted. In *Apus* they are specialised as rowing plates (except a few anteriorly for raking prey together), in the *Trilobites* as ambulatory legs. The former modification requires no description; it results simply in a further development of the flat leaf-shaped parapodia, the sensory cirrus alone, perhaps, requiring to change its form from a cirrus into the flat flabellum. The ambulatory leg of the *Trilobite* may be supposed to have arisen as follows. A strip running from the tip of the parapodium, where it rested on the ground, to the body, would tend to be strengthened, and would eventually bear the weight of its share of the body. On each side of this strip the leaf-like parapodium would be useless, and would gradually disappear, this disappearance being accelerated in the *Trilobites* by other and special causes which we have already described, such as the necessity of having limbs which, in the rolled-up body, would occupy as little space as possible. Thus we may safely assume that the parapodia, if used for walking or crawling, would, by a simple biological law, turn into ambulatory legs.

The question as to whether the leaf-like feet persisted at the hinder end of the body is an interesting one. We have no certain data on the subject, but, from our point of view, we do not think it at all probable. We have seen that in *Apus* even the most rudimentary limb repeats the Phyllopodan type. We are also inclined to believe that the more rudimentary Trilobite limbs would naturally repeat the Trilobite ambulatory type. The presence of flat leaf-shaped limbs in the *Eurypteridæ* and *Limulus*, accompanied by highly specialised anterior limbs, may perhaps be used as an argument in favour of their presence in the Trilobites also. On the other hand the highly developed gills on the trunk limbs of the Trilobites rendered it unnecessary to concentrate respiration on a few broad gills at the posterior end of the body as in *Eurypterus* and *Limulus*, which in this respect compare with some modern Isopoda.

The first trunk limb, according to Walcott's restoration, has both its locomotory dorsal branch and its masticatory ventral branch specially strongly developed (see Fig. 50). It is, in some respects, very natural that the masticatory ridge of a powerful locomotory limb, if it possessed any function at all, should gradually come to be the chief jaw, as we shall see to have been the case also in the *Eurypteridæ*; the disadvantages of this arrangement will, however, be pointed out later.

We have already shown why the first trunk limb, being the parapodium of the first free segment, not taken up in the formation of the head, should be

highly developed. The use of such a specialised limb in the Trilobites, however, is difficult at first sight to see. In *Apus* we find it developed as a sensory organ on the principle of the division of labour. In the Trilobites it is clearly locomotory, and as such seems rather out of place among the smaller and less powerful crawling legs of the other trunk segments. In discussing the manner of life of *Eurypterus* and *Pterygotus*, we shall find that they throw some light on the probable use of this limb in the Trilobites.

It is especially interesting to find the gradual simplification of the limbs from front to back, which is evident towards the posterior end of the body (Fig. 49, *cf.* with the Frontispiece). There can hardly be any doubt that the gradual dwindling of the limbs in the Trilobites admits of the same explanation as a similar dwindling of the limbs in *Apus*. Such a singular morphological occurrence, in two animals so like in other respects also, can hardly be a case of analogy.

*The Eyes.*—Packard has shown that the hard part of the eyes of Trilobites, which alone have been preserved in the fossils, are identical with those of *Limulus*. As we have already seen in discussing the eyes of *Apus*, we consider the eye of *Limulus* as a more primitive stage in the development of the Crustacean eye out of the Annelidan eye-spots. In this respect *Apus* is more highly developed than both *Limulus* and the Trilobites, as indeed we should expect from its free-swimming life.

*The Alimentary Canal* has already been referred to. It has the very pronounced bend on which we lay so much importance (see Fig. 46). Although we think our proof is not much weakened by our not finding any traces of the sternal plate, still it would be interesting if it were to be found, as it must without doubt have been there, *i.e.* if there is any truth of our deduction of these animals from bent Annelids. The habit of rolling up would lead to a strong development of the ventral muscle bands, and consequently of this sinewy mass for their attachment (*cf.* p. 261).

We think, then, that we have here made it highly probable that if our deduction of *Apus* from a bent carnivorous Annelid holds, the Trilobites must have had the same origin. This fact, that the most primitive Crustacean known to the palæontologist should show so many points in its organisation directly deducible from the Annelids, *i.e.* deducible after the *Apodidæ* have supplied us with the key to their correct interpretation, is one of those confirmations of a theory which we think amounts almost to a demonstration.

The Trilobites, then, are nothing but specialised carnivorous Annelids, browsing under cover of the dorsal integument, which, starting from the head-shield, gradually spread out like a flattened jointed roof, covering all the segments. Every imaginable variation in the sculpture of the surface of this roof, and in the thorns for its protection, are to be met with in the Trilobites.

This development of great multitudes of armoured browsing carnivorous Annelids in the palæozoic seas, supplies us with abundant matter for biological speculation. It was perhaps in defence against these powerful marauders that so many Cœlenterata perfected their nematocysts or stinging cells, that the Corals built their stony ramparts, and that many of the Mollusca developed their shells. It may indeed have been the perfection of these defences which led to the dying out (with the exception of *Limulus*) of these early Crustacea, especially of the giant forms. Whatever the cause, all except *Limulus*, the Ostracoda, and the Apodidæ (looked upon as the racial form of all other existing Crustacea) gradually died out.

The first and the last of these still fortunately retain the clearest traces of their origin, and, more or less modified, the browsing habit of life.



## SECTION XIV

### THE EURYPTERIDÆ

THIS last group of the Gigantostraca need not detain us long. By the general consent of all the zoologists who have recently studied these animals, they are classed with the Xiphosuridæ and the Trilobites. The exact relationship, however, has not hitherto been very clear ; we now find it in their common origin from our Crustacean-Annelid.

We have imagined our Crustacean-Annelid developing first of all a kind of crescent-shaped protection for its bent head, arising primarily from the lateral projections due to the bending of the cylindrical body. This shield develops in almost every possible way. In the Apodidæ it forms a dorsal fold to cover the rest of the cylindrical and unprotected Annelidan body ; in the Ostracoda it forms the bivalve shell in a way to be described later, or it gives rise, as described on p. 217, to the flat jointed dorsal roof extending over the whole body in the Trilobites and the Xiphosuridæ,

In the Eurypteridæ, however, even this primitive head-shield seems wholly or almost wholly to have disappeared, and the flattened Annelidan segments relied almost entirely upon the stronger development of the exoskeleton for protection. Like the Xiphosuridæ, they developed comparatively few segments, ending in a caudal spine or plate. In this limited number of segments they show considerable specialisation. The whole structure of the animal is clearly adapted for a free-swimming life, the first trunk limbs forming powerful oars.

The limbs develop as Crustacean limbs only on the head and first trunk segment ; on the other trunk segments they remain leaf-shaped, *i.e.* more like the original Annelidan parapodia. The gill portions of these limbs may have had their surfaces increased by means of numerous integumental folds like the leaves of a book, as in the Xiphosuridæ.

We feel some confidence in the following homology of the head limbs, because we have learned, from all the groups hitherto discussed, that the large rowing limb is probably the first trunk limb ; we need not here repeat the reasons already given for this conclusion. All that lies in front of these large rowing limbs therefore represents the head.

Before, however, attempting to examine the parts in detail, we are at once struck by the difference between the heads of these animals and those of the Apodidæ, *Limulus* and the Trilobites. The mouth parts are in fact so specialised that it is not easy to compare them with those of the above-named groups.

The head limbs are different in the two groups, *Pterygotus* and *Eurypterus* (see Figs. 55 and 56). They are, however, only different modifications in

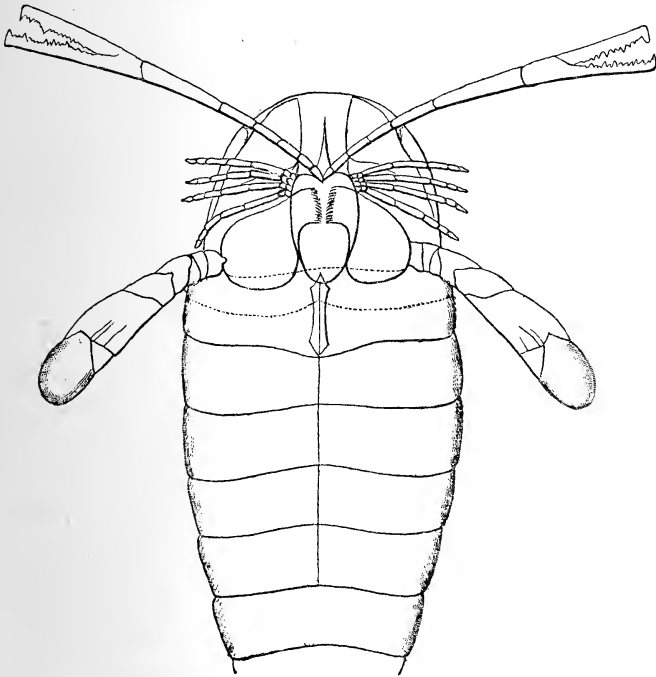

FIG. 55.—*Pterygotus Osiliensis*, upper Silurian, after F. Schmidt (from Zittel), showing five pairs of cephalic limbs, the enormously developed first pair of antennæ, and first trunk limbs in which the dorsal and ventral parapodia are greatly developed as locomotory and masticatory limbs respectively. The second pair of cephalic limbs sometimes disappear, as in *Pterygotus Anglicus* Agassiz.

adaptation to slight differences in the manner of life. Judging from the forms of these remarkable animals, we think the following method of explain-

ing the modifications they show will not be far wrong.

The earliest Crustacean-Annelids possessed large labra or prostomia projecting backwards, still retained in the Apodidæ and Trilobites. This labrum almost necessitated a very deliberate manner of browsing. The animal would creep along, and would have to run some way over its food before it could get it into its mouth, the whole process, it seems to us, necessitating a number of small movements backwards and forwards. Small living prey would very often escape, owing to the fact that the animal's mouth and jaws were not ready in position for them when first perceived. The labrum necessitates the animal passing forwards over its prey, then darting backwards to follow it with its jaws. We here see how useful the gnathobases of *Apus* must be in catching and holding prey which has been thus passed over. Indeed the whole arrangement of the limbs of *Apus* with the sensory endites, forms an excellent trap to catch prey over which the labrum has passed. The legs and pleura of the Trilobites, and the large vaulted shield of the Xiphosuridæ may serve the same purpose, although in the latter case the labrum is much modified. In this respect, however, the Trilobites were not so well equipped as are the Apodidæ; hence perhaps the development of the large locomotory limb, which enabled the animal to dart backwards after prey thus run over, with great rapidity. We here see the use of the two kinds of limbs figured in Walcott's restoration, ambulatory crawling limbs for slow and deliberate forward move-

ments, and one pair of springing limbs for short sudden dartings backwards.

It is clear, then, that the possession of these large labra was attended with certain disadvantages in feeding. It is therefore not improbable that some of these primitive Crustaceans should show various modifications. Smaller upper lips being an advantage, the labra might almost disappear, so that the opening of the mouth would be ready for its prey as soon as it came in a line with it.<sup>1</sup> A natural concomitant change in the under lips would also take place; they would develop into the large metastomata found in the Eurypteridæ, which clearly helped to prevent prey slipping past the mouth as the animal darted forwards. The more rapid the forward dart after prey, the larger should the metastoma be; otherwise prey once shot over would be almost sure to escape before the animal could turn round; the animals have no trap-like arrangement of trunk limbs in which prey could be caught. We do not, it is true, find from comparing Figs. 55 and 56 that the larger rowing limb is accompanied by the larger lower lip, still we think the above reasoning to be correct, and that other factors, such as the higher development of the sensory organs, compensate in this case for the

<sup>1</sup> On p. 40 we discussed the origin of the division in the under lip of *Apus* so that it should not form a barrier to the pushing of food forwards into the mouth. We now see that the divided upper lip of some Trilobites there referred to (and well illustrated Fig. 49, p. 220), was also probably intended to shorten the way into the mouth, only in this case round the labrum from in front. The three small pairs of posterior cephalic limbs may have assisted in this latter process.

comparative smallness of the metastoma. Thus then the entrance to the mouth may have come to have almost an anterior-ventral instead of a posterior-ventral aspect. This explains the enormous mandibles developed by the ventral parapodia of the first trunk limb. In *Pterygotus*, Fig. 55, we have, in fact, an arrangement almost exactly the opposite of that found in the other primitive Crustaceans; the under lip forms the analogue of the upper lip, the masticatory ridges of the first trunk limbs are analogous to the mandibles, while those of the four posterior head limbs probably function as maxillæ, their dorsal parapodia doubtless helping in the catching and holding of prey. And lastly, the first antennæ developed into large chelate feet. It is almost as if we had the typical mouth formula of a modern Crustacean turned quite round.

These changes clearly went hand in hand with the acquisition of more rapid motion in feeding. A springing or darting movement forward is most suitable for an arrangement of mouth and jaws facing anteriorly, for the sudden seizure of the prey which comes in the way. Further, it seemed to us that the more rapid the movement the more delicate should be the sensory organs for the rapid perception of what was food and what was not. A comparison of the rowing limbs of *Eurypterus* and *Pterygotus* quite confirmed this supposition, and lent unexpected support to this method of explaining the morphology of these animals. *Eurypterus* (Fig. 56), which has all its anterior head limbs developed as

highly sensitive antennæ, has larger rowing limbs in proportion to the size of the body than *Pterygotus* (Fig. 55), which does not seem to be so well provided with such organs. The latter animal moved more slowly and caught its prey with its powerful pincers. The former darted forward with great rapidity and caught its prey at once between its numerous jaws.

We consider then the Xiphosuridæ as early Trilobites specialised for slow deliberate browsing ; the Eurypteridæ on the contrary for a rapid darting method of capturing prey. That the Trilobites did employ the springing movement which we have here assumed purely on morphological and biological grounds, has been lately confirmed by the discovery of a Trilobite track, which, according to Ringueberg the discoverer, could only have been produced by a series of jumps.<sup>1</sup>

This description of the manner of life of these animals (the Eurypteridæ) renders it not so necessary to describe the limbs of the two animals ; still, as there are points of great interest in their morphology, a short account of them will not be out of place.

Taking *Pterygotus* first, we have the first antennæ developed into long chelate seizing feet, like the first antennæ of *Limulus*, but much more highly developed. The analogy of the Scorpionidæ will at once suggest itself, where for the same purpose the palps have developed in the same way. These chelæ of *Pterygotus* were probably richly provided with sensory hairs, since the limb on which they were developed

<sup>1</sup> Proc. American Association, 1886.

was, as a sensory limb, richly innervated. The eyes also seem to have been highly developed.

The following four limbs, which correspond with the second antennæ, mandibles, and first and second maxillæ of *Apus* and of the other Crustacea, resemble the ordinary Trilobite limbs. Their dorsal branches probably functioned as palps or tasters, as perhaps was the case in the Trilobites, or perhaps as limbs for holding prey brought by the chelæ in the right position for the mandibles to crush, just as the fore legs of a caterpillar hold the leaf in the best position for the jaws to work upon it, only in this latter case, of course, the jaws lie in front of the legs instead of behind them.

The masticatory ridges of these four limbs probably functioned as maxillæ, but, as already mentioned, lying anteriorly to the mandibles, not posteriorly as in all modern Crustacea.

The first trunk limbs have already been mentioned as large rowing limbs. It was in one sense natural that the powerful limb should also develop a powerful ventral parapodium functional as a jaw, but the union of the two functions is not easily comprehensible, and we are more than ever inclined to think that the two may have been separately articulated with the body.

The limbs of *Eurypterus* differ markedly from those of *Pterygotus*. In front of the large rowing limb, *i.e.* the first trunk limb, we have only four limbs visible in the figure, all of these appearing to be sensory, and thus affording a striking contrast to the head limbs of *Pterygotus*, none of which appear, at first sight, to be



sensory. From our point of view, according to which the large rowing limbs belong to the first trunk segment, we should have had to conclude that one pair of limbs had disappeared. Such a supposition is however not necessary, as F. Schmidt has found and described

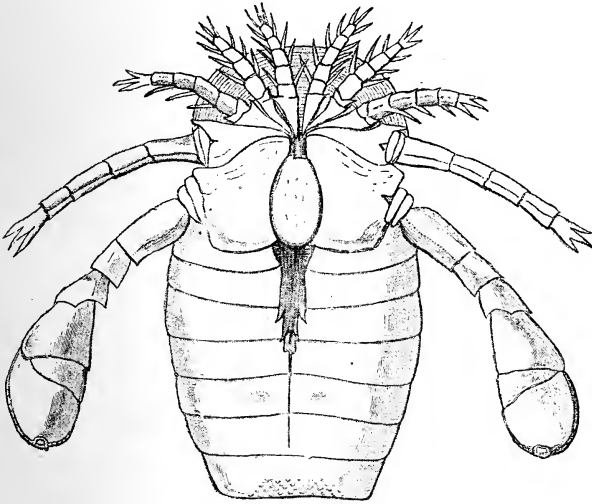

FIG. 56.—*Eurypterus Fischeri* Eichw. : Upper Silurian, natural size, after F. Schmidt (from Zittel's *Handbuch der Paläontologie*). Between the first pair of feet, Schmidt found a fine pair of feelers, corresponding with the Antennules of the other Crustacea.

a pair of rudimentary antennæ between the first pair, so that *Eurypterus* possesses the typical number of head appendages. It is a fact generally accepted that the pair of large rowing limbs corresponds with that of the sixth segment. There is, however, no general agreement as to whether these first six segments form

a head or a cephalothorax. Our homology of the large limb with the first trunk limb, throughout all these primitive Crustacea, shows that the six segments of the Eurypteridæ form a cephalothorax, and not only a head.

This degeneration of the anterior antennæ in Eurypterus is hardly what we should have expected theoretically. The rapid forward movement for feeding would seem to require highly developed antennæ pointing forwards. We attribute it to the fact that the manner of life of the animal, as above described, required that the sense of touch in a limb should be immediately followed by an act of seizing, by means of its masticatory ridges. The anterior antennæ had, however, entirely lost the power of developing their parapodia even in the original Crustacean-Annelid, and thus became of very secondary importance in the life of Eurypterus.

As to the other limbs of the head, Eurypterus resembles *Limulus* in having the masticatory ridges on the last four head limbs and the first trunk limb well developed, and working as jaws round the mouth, which was apparently not the case in *Pterygotus*, where the importance of the masticatory ridges of the first trunk limb over those of the head limbs was very evident. The exact morphology of the limbs themselves it is impossible to describe with certainty; it is not improbable that those of the head, in Eurypterus, are the sensory cirri alone of the original parapodia. We see no reason why this should not be the case. Nature seems to delight in every possible variation, and indeed in the

limbs of the modern Crustacea we have almost every possible combination of the parts of an Annelid parapodium. We have, for example, the sensory cirrus alone in the antennæ, the gills alone in many Crustacea (*e.g.* Caprella), the dorsal parapodia alone in the ambulatory limbs of the Decapoda, the ventral parapodia alone in the mandibles, and all these parts together in the typical Phyllopodan limb. Other combinations, such as the dorsal parapodium with the sensory cirrus, the dorsal parapodium with the gill, will no doubt suggest themselves to the reader.

What was said above as to the first trunk limb of *Pterygotus* applies equally well to the first trunk limb of *Eurypterus*. We may further add that their form as rowing limbs is just what is required to give the animals the forward darting movements which we have assumed to have led to the modifications of their mouth parts. Whether they kept up a continual rowing motion like the common free-living Copepoda, or lurked at the sea bottom to dart out in pursuit of prey which happened to come within reach, it is difficult to say; we incline to the latter as the more probable habit of life.

Again, as already described, the use of the large limb in the Eurypteridæ throws some light on that made by the Trilobites of their large first trunk limb. It functioned as a kind of springing foot to supplement the more deliberate method of crawling. The animal kingdom supplies us with many examples of special arrangements for such a sudden and more energetic method of locomotion, developed

in animals whose ordinary progression is slow and deliberate.

In our general account of the probable manner of life of these animals we have described the change which we think took place in the upper and lower lips, the former almost disappearing, while the latter develops into a large fold projecting anteriorly, and bearing exactly the same relation to the masticatory ridges of the first trunk limbs as the labrum of *Apus* does to the mandibles, only pointing exactly in the opposite direction. The position of this metastoma corresponds exactly with that of the under lips of *Limulus*. This fact seems to suggest that this was also the position of the under lips in the Trilobites.

The leaf-shaped abdominal limbs we have already mentioned as undoubted links between these animals, *Limulus*, and our bent Annelid.

We must now leave these highly interesting animals, which in point of size reached the highest development of all the Crustacean descendants of our carnivorous Annelids. The exact relationship of the group to the Trilobites and the Xiphosuridæ, and to one another, we cannot pretend to settle. It must be left to those who have made the special morphology of these fossil forms a life-long study. We must confine ourselves here to the suggestion made above, that the Xiphosuridæ and Eurypteridæ are early Trilobites modified for two different and opposite methods of feeding. We shall be more than satisfied if we have been able to contribute something to our knowledge of the groups, by tracing their origin to the Annelids.

In bringing to a close these comparisons of the fossil Crustacea with *Apus* and with our Crustacean-Annelid, it may be interesting to see, set out in a table, the various ways in which the parapodia in the first six Annelidan segments have been developed—a representation of the attempts of Nature to find the best combination of head and mouth parts.

The limbs used as jaws are in larger type, so that the different masticatory arrangements may be seen at a glance.

A study of this table shows us that all the animals which retained the early primitive arrangement of crushing the food between the ventral parapodia of the first trunk limbs, which were the strongest in the body, have, with the exception of *Limulus*, died out. It is not difficult to see that it is a great advantage to have the mandibles as close to the opening of the œsophagus as possible, otherwise the greater part of the juices of the crushed animal would be lost before it could reach its destination within the œsophagus of its devourer. The enormous metastoma or under lip of the Eurypteridæ may have been partly an attempt to avoid this loss. It does not seem improbable, therefore, that the ultimate selection of the third pair of ventral parapodia as mandibles may have assisted in leading to the survival of the modern Crustacea. On the other hand, the enormous growth of some of these ancient forms (*Pterygotus anglicus* sometimes being more than a metre in length) shows that they did not apparently suffer from lack of nourishment on account of the arrangement of their jaws. When,

# THE COLUMNS TO BE READ DOWNWARDS.

Mandibles = principal jaws; Maxillæ = accessory jaws.

Segments.	Annelids.	Trilobites.	Pterygotus.	Eurypterus.	Limulus.	Apus.	Typical Crustacean.	Nauplius.
I. { dorsal parapodium ventral parapodium	sensory cirrus = antenna	rudimentary sensory cirrus as antenna	sensory cirrus as long chelate limb	rudimentary sensory cirrus	sensory cirrus as chelate limb	sensory cirrus as antenna	sensory cirrus as antenna	sensory cirrus as antenna
	rudimentary with sensory cirrus	rudimentary sensory cirrus (?)	small grasping leg	sensory limb, ? sensory cirrus alone <sup>1</sup>	chelate or clawed limb	forming proximal half of antenna with sensory cirrus as end piece	long tactile organ with sensory cirrus as scale <sup>2</sup>	powerful rowing limb with sensory cirrus as larger branch ? rudimentary or wanting
II. { dorsal para. ventral para.	complete	probably a small masticatory ridge	MAXILLÆ	MANDIBLES	MANDIBLES with sensory cirrus		rudimentary with sensory cirrus as palp <sup>3</sup>	gradually diminishing
	complete	small grasping leg	small grasping leg	sensory limb, ? sensory cirrus alone <sup>1</sup>	chelate limb		MANDIBLES	gradually developing into MANDIBLES
III. { dorsal para. ventral para.	complete	MAXILLÆ	MAXILLÆ	MANDIBLES	MANDIBLES with sensory cirrus	rudimentary	rudimentary palp <sup>3</sup>	
	complete	small grasping leg	small grasping leg	sensory limb, ? sensory cirrus alone <sup>1</sup>	chelate limb		MAXILLÆ	
IV. { dorsal para. ventral para.	complete	MAXILLÆ	MAXILLÆ	MANDIBLES	MANDIBLES with sensory cirrus	rudimentary	rudimentary palp <sup>3</sup>	
	complete	small grasping leg	small grasping leg	sensory limb, ? sensory cirrus alone <sup>1</sup>	chelate limb		MAXILLÆ	
V. { dorsal para. ventral para.	complete	MAXILLÆ	MAXILLÆ	MANDIBLES	MANDIBLES	rudimentary	rudimentary palp <sup>3</sup>	
	complete	powerful locomotory limb	powerful rowing limb	powerful rowing limb	powerful locomotory limb with sensory cirrus	limb-like with long sensory endites	MAXILLÆ	MAXILLIPEDS rudimentary palp <sup>3</sup>
complete	MANDIBLES	MANDIBLES	MANDIBLES	MANDIBLES	MANDIBLES	masticatory ridge	MAXILLÆ	
VI. { dorsal para. ventral para.	complete	MANDIBLES	MANDIBLES	MANDIBLES	MANDIBLES			

<sup>1</sup> When a sensory limb alone appears, it may either be the sensory cirrus of the original parapodium developed by itself, or the dorsal parapodium as a tactile organ.

<sup>2</sup> Here, according to the accepted homologies, the actual sensory cirrus is the endopodite, *i.e.* the dorsal parapodium, and the scale at its base is the *exopodite* or *original sensory cirrus of the parapodium*; the dorsal parapodium is therefore here a long tactile organ. The feathered hairs on the scale support our view that it is homologous with the original parapodial sensory cirrus. These feathered hairs are especially well developed on the scale in Euphausia.

<sup>3</sup> Here both dorsal parapodium and sensory cirrus, *i.e.* endo- and exopodite, are sensory organs.

---

therefore, we ask why these animals died out, in spite of their having acquired the habit of free swimming, we can only suggest that the very perfection of their specialisation may have been fatal to them ; the line of their development ended in a cul-de-sac. They were not plastic enough to adapt themselves to some great change or other which took place in their surroundings, such as the perfection of the protective arrangements of their prey, and consequently died out. The theory which deduces the Arachnida from them through the scorpions seems to us to be very improbable in the face of this extraordinary specialisation. But to this important and interesting discussion we shall return in a final section dealing with the other division of the Arthropoda, viz. the Tracheata.

## SECTION XV

### ON THE NEW CLASSIFICATION OF THE CRUSTACEA NECESSITATED BY THE THEORY

OUR work is so far finished. We endeavoured first of all to show that Apus was easily derivable from a bent carnivorous Annelid. If this was really the case, we at first concluded that Apus must be the primitive Crustacean. In order to test this, we appealed to such an archaic form as *Limulus*, which is still extant, and to the palæozoic Trilobites and Eurypteridæ. These have offered unexpected confirmation of our theory, amounting, as we have said above, to a demonstration. But at the same time we have had to modify our conclusion that Apus was the primitive Crustacean, these forms not being derivable from Apus, but rather from the same bent Annelids. This accounts, at the same time, for their remarkable resemblances and for their many differences.

Besides the palæozoic Crustacea which we have so far mentioned, viz. the Trilobites, Xiphosuridæ,



Eurypteridæ, and Phyllopora, there occur numerous remains of Ostracoda and Cirripedia. If we can in any way connect these latter with the above named, we shall have solved the difficulty expressed by Barrande and felt by many, that the Crustacea first appear in the geological record in several widely different groups, almost simultaneously, and without any transition forms either leading up to them or linking them together. Our derivation of the former groups from bent Annelids with no hard chitinous skeleton which could have been preserved, explains the sudden appearance of these groups. We have still then to show that both the Ostracoda and the Cirripedia are deducible from these forms. As, however, these two groups have modern representatives, we shall treat them in order among the other living forms.

We have then to ask the question, From which of these primitive Crustacean forms did the modern Crustacea arise? For some groups, fortunately, the answer is clear; as to others, however, we can only guess.

The attempt which we here make to sketch out a new classification of the Crustacea must be understood to be quite provisional. In establishing the bent Annelid as the origin of the Crustacea, we have done nothing more than lay the foundation stone for the construction of a complete and final classification of the Crustacea, including, for the first time, the hitherto enigmatical palæozoic forms. It is, however, as completely out of the sphere of this book as it is

beyond the abilities of the writer to attempt to carry this out in detail.

In arranging the Crustacean groups, we propose to ignore the usual division into Entomostraca and Malacostraca. The Entomostraca we take to mean all those groups which do not clearly belong to the natural group of the Malacostraca. We therefore prefer to divide the class into Phyllopoda, Malacostraca, Copepoda, Cirripedia, and Ostracoda. From what follows it will be seen that we divide these five into three groups, the first consisting of the Phyllopoda and Malacostraca; the second, of the Copepoda and Cirripedia; and the third of the Ostracoda. We believe that the first group is derived from the Apodidæ, the second from a larval Apus, and the third, at least partly, from a Trilobite. This grouping, however, requires considerable investigation before it can be definitely accepted. We leave it to others who have made the different groups of the Crustacea their special field of research to carry it out in detail. We confine ourselves here to giving a diagram representing the way we propose to construct a natural order of the Crustacea based upon our theory. We can, unfortunately, offer but little in the shape of proof of this new classification, and must content ourselves with appending a few disconnected notes on the different groups, which tend to support our views.

Taking the groups in the order in which they occur in the diagram from left to right, we may at once dispose of the Eurypteridæ and the Xiphosuridæ.

From the Trilobites, however, we are inclined to deduce at least a part of one important group of modern Crustacea, the Ostracoda. We think it

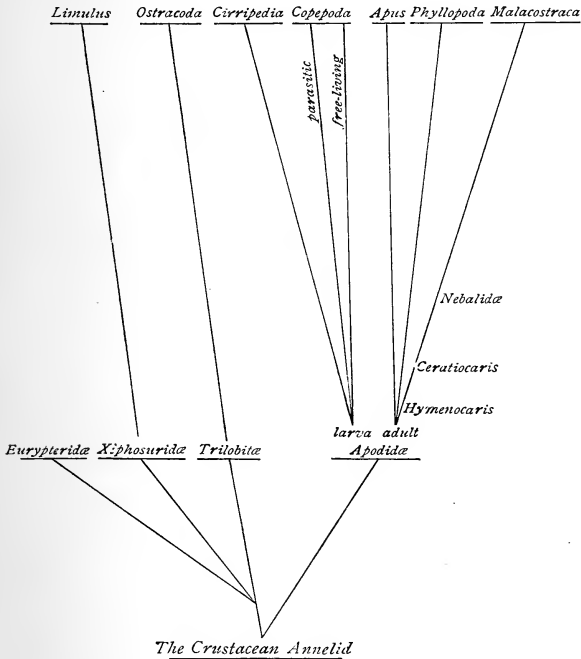

Proposed genealogy of the Crustacea. It will be seen from the text that though we have here given only one root for the Ostracoda it is probable that they have had at least a twofold origin.

probable that the Crustaceans in question may be deduced both from Trilobites and Phyllopods. The strong likeness between these early forms, especially in their larval stages, now perpetuated in the Ostracoda,

accounts for the general resemblance of the latter to one another.

#### THE OSTRACODA.

These animals occur in company with the Trilobites in the very oldest fossiliferous strata. Balfour suggested that they may have had an origin independent of that of the other Crustacea. As, however, we find them possessing the bent intestine, clear traces of the entosternite, the paired and the unpaired eye, we must, according to our theory, deduce them from our bent Annelid.

There are two ways in which the origin of the bivalve shell may be explained: either (1) that shown in Fig. 57, where it arises simply by the folding together of the horns of the crescent-shaped ridge round the front of the head, or (2) when it arises through the folding down of the two halves of a dorsal shell such as that in *Apus*. These two methods are quite distinct; the former bends the dorsal integument of the head-shield alone along the middle line, the latter bends only the dorsal shield as far as its junction with the body. There is, however, a method of combining these two modifications if, after a dorsal shield has been developed, both the head-shield and the dorsal shield are bent.

We were at first inclined to attribute only the first method of origin to the bivalve shells of the Ostracoda, and to deduce them from some such form as *Harpes ungula*. It would be an obvious advantage to an animal given to the habit of rolling up for defence, to be able to

continue to feed and breathe, and yet remain rolled up and sufficiently protected against its enemies. It is clear that this end would hardly be attained in those cases in which a large solid pygidium closed against the head-shield. But on the other hand, it would be quite possible by the longitudinal folding of the lateral wings of the head-shield, as shown in Fig. 57 *B*. We may well suppose that some Trilobites adopted this method of protecting themselves, since, besides

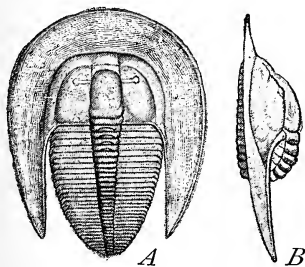

FIG. 57.—*Harpes unguia* Sternb. *A*, dorsal view; *B*, rolled up in profile (from Bronn's *Klassen und Ordnungen des Thierreichs*); *B*, to show the probable origin of the Ostracoda, the head-shield with the enormously developed frontal fold, shown here in profile, only requires to bend in the dorsal middle line to form a bivalve shell.

the great advantages already mentioned of allowing the animal still to use its limbs and to move about and feed while remaining almost perfectly enclosed, it is also clear that the closing of such bivalve shells, which would never be very wide open, would be a much quicker and simpler process than the rolling up of the whole body in the sagittal plane.

In assuming this origin for the bivalve shell of the Ostracoda, and not that from the folding down of a

dorsal shell of an Apus-like animal, we have been mainly influenced by the following considerations, which must be admitted to be of some morphological importance.

(1) The position of the head in the shell seems to point decidedly to such an origin. If the shell had been formed by the bending down of the sides of a dorsal fold, the head would either project anteriorly as in the Cladocera, or, if it came between the shells at all, could only do so by itself bending round ven-

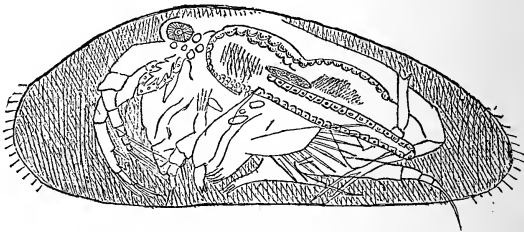

FIG. 58.—*Cypris fasciata* (from Bronn's *Klassen und Ordnungen des Thierreichs*) to show the position of the head in the shell for comparison with the following figures and with Fig. 57.

trally, as shown in different stages in Figs. 60, 61, and 62, or by the growing forward of the halves of the shell so as to cover the head; this latter method is, for many reasons, not a very probable one. In the Ostracoda we find the "face" deep back in the shell, pointing forwards in a way difficult to explain on any other hypothesis than that which we put forward. These projecting parts of the shell are the lateral halves of the shovel-shaped ridge which projected so far forwards in the original Trilobite ancestor of the group. If we

take the Trilobite figured in Fig. 57*A*, and fold the ridge round the head along the dorsal middle line, the face (which lies under the glabella) would come to have almost exactly the position which it has in the Ostracoda.

(2) The ridge of the head-shield is, like the ridge round the head of *Apus*, simply a fold of the integument, and contains a part of the general body cavity. Probably as in *Apus* and *Limulus*, it contained the hepatic

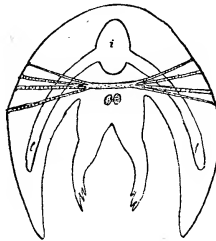

FIG. 59.—Diagrammatic transverse section of an Ostracod, showing the body cavity continued into the valves of the shell, into which also the hepatic diverticula penetrate. The closing muscles are seen to radiate from a central sinewy mass, the sternal plate. *z*, intestine; *h*, hepatic diverticula.

diverticula of the mid-gut. In a cross section through an Ostracod the observer is at once struck by the fact that the space between the laminæ of the shell is considerable, and that it is a continuation of the body cavity. Not only do the hepatic diverticula penetrate into it, but in some genera the genital glands also (Fig. 59). While this is exactly what we should expect from the bending of a head-shield with a pronounced frontal ridge, we should hardly expect to find it from a bending down of a dorsal fold.

(3) We have further the fact, already mentioned, that the Ostracoda are found among the Trilobites in the Silurian strata, and may thus well have been a modified Trilobite form.

It is, however, clear that these arguments do equally well to establish a deduction of the Ostracoda from a primitive Phyllopod with a developing dorsal shield. We have only to assume that both the head- and dorsal shields were bent along the dorsal middle line. The extraordinary likeness between the shells of some of the early Ostracoda (*e.g.* *Leperditia*) to the shells of such Phyllopods as *Ceratiocaris Salteriana* make a Phyllopodan origin for at least some of the Ostracoda very probable. We have further satisfied ourselves by dissections, that at least in some Ostracoda the ligament uniting the two halves of the shell runs backwards posteriorly beyond the point of junction of the abdomen with the shell. We do not, however, give up our first impression that some of the Ostracoda are deducible from Trilobites. In addition to such a significant form as that given in Fig. 57*B*, we would call attention to the fact that the shells of many early Ostracoda are marked by lobes and grooves which Barrande compared to the glabella and intervening furrows, &c., of Trilobites. The presence also of the "ocular" tubercle on each shell in some Ostracoda may well signify what its name implies; the ocular tubercle of the original Trilobite showing just as well on the folded, as on the flat, head-shield. The part played by the habit of rolling up will again be referred to.



As to the general truth of our theory that the Ostracoda are little more than folded Crustacean heads with large head-shields, and with or without a rudimentary dorsal shield, there can, we think, be little doubt. We found strong confirmation of the theory in the form of the closing muscles. It seemed to us that if our view were correct, the closing muscles must be modified from those which radiated from the sternal plate in the transverse plane, and that they ought, therefore, to show this origin. This surmise was fully supported by the facts. The sinewy part of the muscle is found in the centre—the remains of the sternal plate, from which the muscle fibres radiate to the outer walls of the shells. If then it is established that any of the Ostracoda are descended from Trilobites, we have in this double-headed closing muscle very clear proof that the Trilobites possessed the sternal plate which we have elsewhere assumed for them.

As to the causes of the modification of some of these primitive Trilobitic or Phyllopodan Crustacea into Ostracoda, we may perhaps make the following conjecture, borne out by the rudimentary condition of the abdomen, and the small number of trunk limbs. We have only to assume that in some of the larvæ of these primitive Crustaceans with head-shields, the gradual thickening and stiffening of the chitinous head-shield did not keep pace with the developing muscles, whether the powerful mandibular muscles of an early Apus, or the muscles of the masticatory and springing first trunk limb of a Trilobite. This

uneven development is not much to ask, and if it occurred as described, it could hardly fail to lead to a bending of the head-shield along the dorsal middle line, every time, for instance, a larva sought to put in practice its inherited tendency of contracting its muscles for the purpose of rolling up. The failure to develop a head-shield stiff enough to counteract the pulls of muscles lying in the transverse plane, may have thus led to the conversion of the head-shield into the bivalve shells, which have, in the long run, proved a better defence than rolling up.

We thus explain the rudimentary state of the abdomen and trunk. It was only in comparatively young animals in which but few trunk segments had been developed, that the bending was likely to take place, and, when once acquired, it would be clearly an advantage to keep the abdomen in a larval stage, in order that it might be quite enclosed within the halves of the head-shield.

We therefore suggest that the Ostracoda have had more than one root, and may in fact be derived from the larvæ of any of the primitive Crustacea with large head-shields, whether Trilobites or Phyllopods. There seems to be some evidence for both these origins.

#### COPEPODA.

The origin of this very rich group of Crustacea is very obscure. The general opinion is that they must be ranked as perhaps the lowest of all the class. We have now to try to suggest a possible origin for

the group in the light of what is known as to the origin of the whole class from a bent Annelid. We find, then, no group of early Crustacea from which we can actually deduce them. They are distinctly lower in the scale of development than any of the early groups which we have already described, and proved to be the most primitive. We are thus driven to the conclusion that they must have originated from some *larval* form. There is no difficulty in this supposition. Among the enormous number of free-swimming and independently feeding Nauplii, it would almost certainly be an advantage to some to remain but little advanced beyond the Nauplius, the more pronounced character of the adult bringing them at once into danger. If we assume that they are modified larvæ of early Apodidæ, the conditions, as far as we know them, would be fairly well satisfied. The Apodidæ were driven from the open sea by some foe or foes, and would have been exterminated had they not, in the manner described in the early part of this book, taken refuge in shallows and lagoons, and finally in freshwater puddles. We may well suppose, therefore, that while one division of the Apodidæ thus retreated inland and were able there to develop into adults, another probably found safety in remaining at the larval stage, their smallness, their transparency, and the rapidity of their motion rendering them comparatively safe. Whether the organisation of the Copepoda can be explained on this hypothesis we are not able to decide. The view that they are really equivalent to larvæ finds some support in the

fact that they fail, excepting in a few rare cases (*e.g.* Argulus), to develop the paired eyes. The unpaired eye is always present, at least in the free-swimming forms; the paired eyes appear as rudiments, only to disappear again later. The characteristic caudal fork of the Copepoda might well be a further development of the fork which appears at the early larval stages of Apus (see Fig. 41, p. 168). The characteristic ovisacs may be a modification of the habit of Apus of carrying its eggs about in a brood pouch, necessitated by the fact that the more larval Copepoda do not develop enough segments to reach the inherited place of exit of the genital products, *i.e.* between the tenth and eleventh segments.

This theory also is quite in accord with the fact that so many Copepoda are parasitic. The same danger which, loosely speaking, drove the adult Apodidæ into the land, and the larval to remain at the larval stage, would tend to differentiate the larvæ themselves, as the wind has differentiated the beetles in the island of Madeira.<sup>1</sup> These insects are either strong fliers or else have given up the habit of flying altogether, the strong winds having swept away all intermediate grades. The Copepoda are similarly very markedly divided into two groups, the free and powerful swimmers, and the parasites who have almost or entirely given up the habit of free locomotion, except in the earliest larval stages when seeking new hosts.

The chief difficulty in the way of this derivation of the Copepoda from an Apus larva is, perhaps, the form of

<sup>1</sup> Darwin, *Origin of Species*, p. 109.

the limbs. In consequence, however, of our method of deducing the limbs from the Annelidan parapodia we do not ourselves experience this difficulty. The typical Phyllopodan limb is, according to our view, composed of the dorsal parapodium carrying on the dorsal side the gill and the sensory cirrus, and on the ventral side a row of sensory endites, with the remains of the ventral parapodium as masticatory ridge. The parts of these limbs which would be useless to the Copepod would naturally degenerate, *i.e.* 1, the gills, because the animal breathes through its integument; 2, the sensory endites, because the animal would no longer require to use its limbs in the way *Apus* uses them to rake together prey into the ventral middle-line; and 3, consequently also the masticatory ridge which in *Apus* forwards food thus raked together towards the mouth. On the degeneration of these parts we have left only the dorsal parapodium with the sensory cirrus, *i.e.* the endo- and exopodite of the typical Copepod limb.

Grenacher's account of the unpaired "eye" of *Calanella* differs somewhat from that of *Apus*; although there can be little doubt that the two are homologous. In *Calanella* only three "retinæ" are developed, each consisting of comparatively few retinal cells. There is no trace of crystal cones or rhabdomeres, and the pigment is in the centre of the group. The nerves from the retinal cells come from their inner ends, their sensory ends pointing outwards. A comparative study of these unpaired "eyes" has long been a desideratum.

We thus suggest the deduction of the Copepoda

from a larval stage of *Apus*, dating back to the time when the Apodidæ could no longer develop fully in the open sea, and only those larvæ which were accidentally shut off and isolated in lagoons were able to grow into adult animals.

#### CIRRIPEDIA.

These animals are now generally supposed to be related to the Copepoda. What we have said of the latter applies in great part to them also. We can deduce them from no original adult Crustacean form derivable from our bent Annelid. We are therefore driven to deduce them, as we have done the Copepoda, from some larval form. We think it possible that the Cirripedia may have been one of the extraordinary lines of development adopted by the original Copepod, *i.e.* larval *Apus*, which sought safety in a stationary life. As larvæ of *Apus*, it was always possible for them to develop the shell-fold or mantle if necessary, the later calcification of which, perhaps as protection against the browsing Trilobites, led to the beautiful shell arrangements characteristic of the group.

We now come to groups the origin of which can be established with less appeal to the imagination than was necessary in the former groups. The manner in which the other Phyllopoda have been derived from the Apodidæ will afford some capable zoologist a field for research which cannot fail to be rich in

biological observations of extreme interest.<sup>1</sup> We limit our own contribution to the subject to a few points of some interest and importance.

#### THE CLADOCERA.

One specimen of *Lepidurus glacialis* in our collection was in the act of casting its skin. Shining through the shell was a white mass, which turned out to be a group of eggs, thrust in as far as possible under the neck. It was clear that this was not accidental; the eggs were there in order to develop under the shelter of the cast-off cuticle. The *origin* of this arrangement may well have been accidental. The Apodidæ swim on their backs, so that eggs from the brood pouch might very easily fall into the large dorsal shell, and this would be the more likely, the larger the shell in proportion to the length of the body; every diving movement of the animal would tend to lodge the eggs further up between the shell and the back. The young hatched out of such eggs may easily be supposed to have derived some advantage from their position. We have two cases to consider, first, that in which the eggs hatch out before the cuticle is cast, and develop under the shell of the parent, and second, that in which the eggs do not develop before the shell is cast, the Nauplius swimming about for a time under cover of the exuvia of the parent.

<sup>1</sup> A suggestion as to one of the changes which explain the origin of *Branchipus* out of *Apus* will be found on p. 100.

In the first case, if this arrangement proved of any real advantage to the young, it would certainly bring about such modification in the parent animal as would lead to the formation of new species, differing from those which did not so shelter their young. This may seem a small point around which to mould a new species, but not if we give to the reproductive function its true value in the economy of life. Every other function is in fact subordinate to it, and it is therefore capable of modifying every part of the body in order to ensure its own efficiency. Hence, given a certain number of Apodidæ which have inherited a tendency to drop their eggs under the dorsal shell, because in this way a greater number are able to develop and survive in the struggle for existence, these animals would, in course of time, be modified so as to perfect this arrangement. The shield would grow further down at the sides so as to press more closely against the body, and the hinder part of the body would come into closer contact with the hinder edge of the shield, both alterations serving to prevent the eggs or embryos from slipping out from under their cover. It is also probable that processes of the terga might grow up so as to close the posterior opening (see Fig. 60).

On the other hand, again, these very alterations, which make the falling out of the eggs more difficult, at the same time make the falling in of the eggs more difficult; hence the gradual movement of the genital aperture up the sides under the shell so as to ensure the egg finding its way into the cavity under



the shell in which it is to develop. All the alterations which we have here described are exactly what we find in the related Cladocera, for instance in the well-known *Daphnia pulex* or water flea (see Fig. 60).

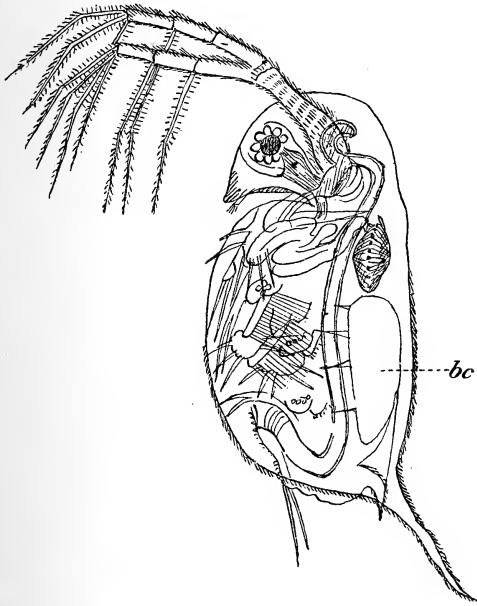

FIG. 60.—*Daphnia* (after Claus), showing the brood cavity (*bc*) between the back of the animal and the dorsal fold; also the position of the head, projecting freely from the folded valves of the shell fold. Cf. Figs. 61 and 62.

Again, as to the great difference in size between the Cladocera and the Apodidæ, it is perhaps worth suggesting (1) that it would originally be only very young Apodidæ, whose shells were specially large in

proportion to the length of the body, into whose shells the eggs would be likely to fall as they swam on their backs; the older the Apodidæ are, the longer the body grows in proportion to the shell, and an egg dropping out of the adult brood pouch would be hardly likely to lodge under the shell, but would fall straight to the bottom of the water,—(2) that the arrangement is not calculated for the development of many eggs at a time, such as one finds in the brood pouches and ovaries of adults; it could only be advantageously used by the young animals at the first commencement of their reproductive activity, when comparatively few eggs issue from the genital apertures. In this way perhaps we may explain the small size of the Cladocera, and also the relatively enormous size of the shield.

The second case in which the skin is shed with the unhatched eggs in it does not appear to require any special modification. It may be a custom among the Apodidæ to collect eggs under the loosening cuticle; this certainly seems to be the case from the specimen of *L. Spitzbergensis* above mentioned. It did not bear any appearance of being accident. About six large eggs were packed in so tightly that they had to be picked out singly with a needle.

It is, however, to be expected that the habit of *hatching* eggs under the shield would naturally lead to some special arrangement for times of ecdysis. Hence the ephippiura of the Cladocera, in which a differentiated part of the cuticle containing two eggs is occasionally cast off as a modified form of ecdysis.

## THE ESTHERIDÆ.

This is the only other group of the Phyllopoda about which we have a few words to say. The formation of the bivalve shell of these animals has already been noticed. The question is, How can a perfect bivalve shell, enclosing the whole body, head and all, be deduced from the folding down of the lateral

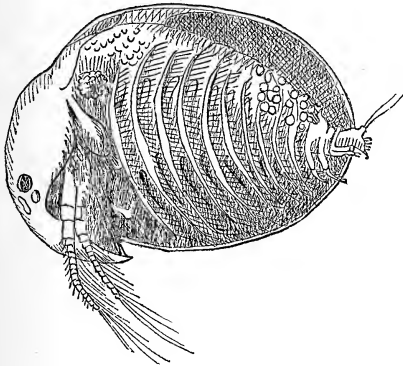

FIG. 61.—*Limnetis brachyurus*, ♀ O. F. Müller (from Bronn's *Klassen und Ordnungen*), to show the position of the head as transition stage between the Cladocera and the Estheridæ (Fig. 62).

halves of a dorsal shield? It fortunately happens that we have a series of forms which make the point quite clear.

In the Cladocera, we have the shell folded down against the sides of the animal, leaving the head quite distinctly marked off (Fig. 60). In *Limnetis* we find the lateral folds of the shell extending more anteriorly so as partially to enclose the head, the change

being chiefly due to the bending down of the head in order to bring it within the shells (Fig. 61).

Limnadia and Estheria show the process completed, *i.e.* the head bent down to such an extent as to be entirely enclosed between the bivalve shells (Fig. 62). The position of the head in these animals, bent ventrally downwards, is in striking contrast to that of the Ostracoda, which is situated far back in the shell and looks forwards.

We must here leave this interesting subject in the

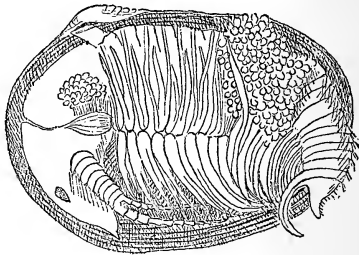

FIG. 62.—*Estheria Donaciformis* Baird ♀, to show the completion of the process of bending the head into the bivalve shell.

hope that some one may be induced to attempt to build up a natural order of the Phyllopoda, and endeavour when possible to show how, and under what biological laws, the different forms have arisen from Apus.

#### THE MALACOSTRACA.

We come lastly to the most highly developed group of the modern Crustacea—the Malacostraca. We need not say much about these. By deducing

the Apodidæ from a bent Annelid, we have endeavoured to establish them as the racial form of the majority of modern Crustacea. We at first thought *Apus* might actually be the primitive Crustacean, but further investigation and comparison with such forms as the Trilobites have shown us that these also claim the same origin as *Apus* from a bent Annelid. These other groups have for the most part died out. *Apus* remains, having been isolated through many geological periods in freshwater pools. While, however, *Apus* itself was not able to hold its own in the struggle for existence in the open sea, modifications of *Apus* succeeded in surviving, and in producing the rich Crustacean fauna of modern seas. We have already deduced some of the natural groups from their *Apus* ancestors, and we have now the chief group of all to trace back to *Apus*.

The Malacostraca have, by general consent, been traced back to Packard's Phyllocaridæ, the only living representative of which is *Nebalia*, which, according to Packard, combines Phyllopodan and Decapodan characteristics. It has been placed by Claus in a special order—the Leptostraca—as a transition form between the Entomostraca and Malacostraca.

Going back to the earlier members of this group, we find in palæozoic times the remains of large Crustacea, which appear to be true *Nebalidæ*. The most important of these are the two forms *Hymenocaris* and *Ceratiocaris* (Figs. 63 and 64). At the first sight of these fossils we are at once reminded of *Apus*, and this is exactly what our theory demands.

No one can study the beautiful plates in Jones and Woodward's monograph of Palæozoic Phyllopods without being convinced that the forms represented were nearly related to the Apodidæ. This first impression is fully borne out when we come to examine the forms more closely. We find several striking characteristics of the Apodidæ, which convince us that we really have here to do with animals at least closely related to and easily derivable from Apus.

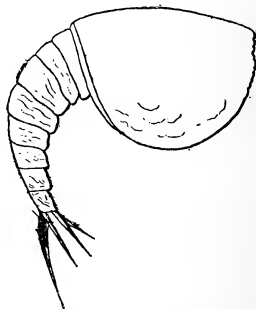

FIG. 63.—*Hymenocaris vermicauda* Salter. Upper Cambrian. To be compared with *Apus* (from Zittel).

*Hymenocaris* has a simple flat shield and a terminal segment carrying a long caudal plate, and three visible anal cirri. From the arrangement of these cirri we may safely conclude that there was a fourth hidden behind the caudal plate. It will be remembered that we found it necessary to assume that the original Crustacean-Annelid had four anal cirri, two of which were preserved in *Apus*, while the two others became rudimentary. This assumption certainly receives some support from the fossil under discussion.

Anteriorly, we find that the shell has been cut off, an arrangement which the next form, *Ceratiocaris*, fully explains.

*Ceratiocaris* differs somewhat from *Hymenocaris*, but shows even closer resemblance to the *Apodidæ*. We have the caudal plate and two anal cirri, which are clearly, as in *Apus*, the ventral pair. If the fossil were well enough preserved, we might perhaps find,

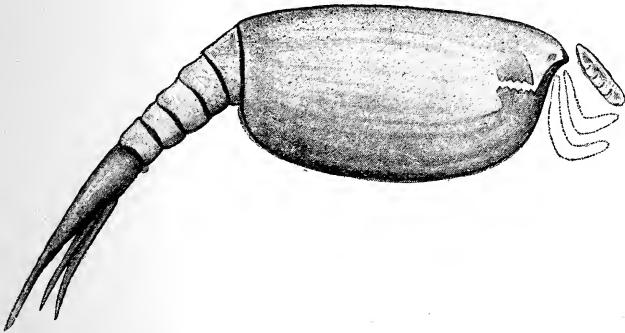

FIG. 64.—*Ceratiocaris papilio* Salter. Upper Silurian. Showing the rostrum, the first pair of antennæ, and the mandibles (from Zittel).

as in *Apus*, the rudiments of the dorsal pair. Impressions of the mandibles are clearly visible, and bear the closest possible resemblance to those of *Apus*. Traces of branchial limbs have been found on the abdominal segments of *Ceratiocaris Stygia*. Anteriorly, however, we find the same piece of the shield cut out as in *Hymenocaris*, with remains of a rostrum and anterior antennæ. The antennæ bear a close resemblance to those of *Apus* (see Fig. 7A, p. 34)

although apparently larger in proportion to the size of the body. The rostrum is, however, clearly a new structure. How can we explain its origin, at the anterior edge of an Apus-like head ?

According to our theory the anterior antennæ once pointed backwards, as do those of Apus. In Ceratiocaris, however, we find them almost at the anterior end of the head. It is not difficult to show that this migration would almost necessitate the formation of a rostrum.

One variation on the primitive Apus type would certainly be a species using their antennæ forwards as organs of sense. Just as, in Apus, the eyes travelled forwards, so, in process of time, the antennæ might tend to move forwards, but, by way of protection for these, at first, delicate organs, we may suppose them to have moved forwards in slight grooves on each side of the median line. As they moved forwards they may have become more and more developed, not only as sensory organs, but as appendages, until they projected freely from the front (as typical Crustacean antennæ). The rostrum is the remains of the middle wall between the two grooves. It is clear that such grooves could not exist on the under surface of the head of an Apus without forming a primitive rostrum. According to this view, the rostrum was originally a *necessary* accompaniment of the migration of the antennæ from the sides of the labrum to the front of the head. The articulation of this rostrum was a secondary acquirement not in itself difficult to imagine.



This view explains the morphological significance of the rostrum, as the protective point for the more or less delicate antennæ, arising, not *per se*, but as the further development of the tip of the middle piece between the two depressions along which the antennæ travelled forwards.

From all that remains then of these primitive Nebalidæ we see a sufficient resemblance to the Apodidæ to form a very striking confirmation of our theory. We see in them true transition forms between Apus and the higher Crustacea ; the fossils showing very clearly one of the first steps in this transformation, and one of the most needful for success in the struggle for existence, *i.e.* the gradual migration of the antennæ to a frontal position near the eyes.

The many points of likeness between Apus and the Macrura will already have struck every reader of the first part of this book. The detailed deduction of *Astacus* from Apus on the lines here laid down would be a most interesting and profitable study.

Starting, then, from our theory that Apus, owing to its likeness to an Annelid, must be one of the racial forms of the whole group, we have been able, with varying success, to show that all ancient Crustaceans are clearly related to Apus, and that all the chief groups of the modern Crustacea, with the probable exception of some of the Ostracoda, can be more or less clearly deduced from Apus. An attempt to derive the modern forms from the Apodidæ in detail would

---

be the work of a life-time and would fill many volumes, but we believe we have established our theory beyond question, and have shown for the first time how a natural system of the Crustacea may be built up by taking *Apus* as the key to the original Crustacean form.

## SECTION XVI

### PERIPATUS AND THE TRACHEATA

BEFORE closing this essay, in which we have endeavoured to prove that *Apus* is an almost ideal transition form between the carnivorous Annelids and one large division of the Arthropoda, viz. the Crustacea, it is but fit that we should briefly refer to *Peripatus*, which is acknowledged to be a transition form between the Annelids and the other division of the Arthropoda, viz. the Tracheata, in which we include the Myriapoda, Hexapoda, and Arachnida. It cannot but add to the interest of this book if we dwell upon this point for a short time.

The accepted fact that both divisions of the Arthropoda are derived from Chætopods, the chief cause of the transformation being the same in both, viz. : the use of the parapodia as appendages for mastication and locomotion, accounts for the resemblances in the organisations of the Crustacea and Tracheata which have led to their being placed side by side as Arthropods. There are, however, striking differences in their

morphology which stand obstinately in the way of attempts to establish a close relation between them.

Has not our derivation of Apus and the Crustacea from a *bent* Annelid supplied us with the clue as to the essential morphological difference between the Crustacea and the Tracheata, leaving out of sight for the moment the tracheæ and the Malpighian tubules which are confined to the latter?

The Annelid which gave rise to the Tracheata started, as did the Crustacean-Annelid, by using its anterior parapodia as mouth parts, but, unlike the latter, it did not bend round its anterior segments to browse in the manner described in the opening sentences of this essay, but remained straight. The fusion of segments to form the head was, in the Tracheatan-Annelid, axial, the mouth remaining at the anterior end of the body.

In such an axial fusing there is nothing to fix the number of segments to form a head common to all the Tracheata, whereas in the Crustacea the bending round of the five segments marked off this region of the body as the head for all time.

The difference between the number of the cephalic appendages of the Crustacea and the Tracheata is to be referred to the fact that with the mouth at the anterior end of the Annelidan body it was impossible to bring so many pairs of parapodia into the region of the mouth to function as mouth parts as in the Crustacea, where its ventral position allows of the arranging on each side of a large number of parapodia as jaws.

The common derivation of the two divisions of the Arthropoda from Annelids modified to use the parapodia as jaws, &c., in the one case round a mouth at the anterior end of the body, and in the other round a mouth bent under so as to face posteriorly, makes it possible, we think, for the first time clearly to homologise the head regions of the two divisions.

The Annelidan prostomium became in both cases the labrum. In both groups the Annelidan antennæ were retained as sensory organs, having disappeared only in the Arachnida. The first pair of parapodia, the antennal parapodia of the Annelids, became differently modified on account of the different position of the mouth. In the Crustacea the mouth was carried round ventrally to between the parapodia of the third and fourth segments, which thus, in the typical Crustacean head, became the chief jaws, leaving the antennal parapodia as a rule free to continue to function as sensory organs. In the Tracheata, on the other hand, the anterior position of the mouth almost necessitated the formation of the chief jaws out of the first pair of parapodia. In Peripatus these alone function as jaws. In the Myriapoda and Hexapoda they are the chief jaws, but are assisted by the two following pairs as first and second maxillæ. In the Arachnida they form the powerful and variously modified chelicerae which develop so largely as to displace and lead to the degeneration of the prostomium and antennæ. These formidable jaws are assisted by the second pair of parapodia as accessory

jaws, supplied with long feelers, or as powerful chelate limbs.

The second pair of parapodia, which in the typical Crustacean head become the chief mandibles, form, in *Peripatus*, the oral papillæ ; the slime glands opening at their tips being perhaps homologous with the acicular glands of the Annelidan parapodia. In the *Myriapoda* and *Hexapoda* they become the anterior maxillæ ; and in the *Arachnida* they form the pedipalps or their homologues.

The third pair of parapodia, which in the Crustacea form typically the first pair of maxillæ, in *Peripatus* and the *Arachnida* function as the first pair of feet. In the *Myriapoda* and *Hexapoda* they form the posterior maxillæ.

Just as we saw that all the Crustacean groups, however aberrant, must have been derived from the same bent Annelid, so we would deduce all the groups of the Tracheata from the same Tracheatan-Annelid. We find the same variety in the arrangement and form of jaws, limbs, &c., and the same variety in the number of segments. In both cases some of the groups can be shown to have been differentiated direct from the original Annelid, while others are only later modifications of such groups. In the Crustacea we think the Apodidæ, and the Trilobites, were original differentiations ; in the Tracheata, the *Arachnida*, the *Protracheata*, and the *Myriapoda*.

Turning now to the important morphological characteristics common to all the Tracheata, viz. the tracheæ and the Malpighian tubules, we shall

not, we think, be far wrong in assuming that these were developed as adaptations to a life on land, and appeared in the original Tracheatan-Annelid, in its gradual passage from a purely aquatic to a terrestrial life. It seems to be a strict biological law that, when aquatic animals migrate to the land, external respiratory surfaces such as gills, which are morphologically folds of the skin, give place to internal respiratory surfaces. This requires no special comment. It is probably, however, an equally strict biological law that free movement on land necessitates such a place of exit for the waste products as will not interfere with such movement. Insects clean themselves from no love of cleanliness. The disadvantages of discharging the waste products in the cephalic or thoracic region, as in the Crustacea, are avoided by means of the Malpighian tubules which open into the hind-gut. This is not the only advantage. Small land animals have often to exercise the most rigid economy in their supply of fluid. The discharge of the waste products into the hind-gut permits the reabsorption of their purely fluid constituents, which would thus be retained within the body. These two advantages are of such importance that the gradual concentration of excretion to the walls of the hind-gut (which we saw in *Apus* to be highly glandular) until special excretory cæca, the Malpighian tubules, were developed, presents no difficulty.

We have already referred to the able attempt of several distinguished zoologists, Kingsley in America, and Ray Lankester in England, to connect the Arach-

nida with the Xiphosuridæ and Eurypteridæ—taking the two latter out of the division of the Crustacea.

If there is any truth in our general argument as to the derivation of the primitive Crustacea from a bent Annelid, and of the Tracheata from an Annelid not so bent, there is no need for any such alteration in the formerly accepted classification. The resemblances in inner and outer organisation between the Xiphosuridæ and the Scorpionidæ, striking as they undoubtedly are, we believe to be simply due to the fact that they are both descended from Annelids. The agreement in the number of segments and cephalothoracic limbs is by far the most important argument in favour of the new classification.

But now it seems to us that it is by no means improbable that two groups of animals descended from many-segmented Annelids should possess the same number of segments, especially when we find that somewhere about the same number of segments seems to have best suited many other groups belonging to both divisions. The Malacostraca have twenty, the free-swimming Copepoda about fifteen, the Hexapoda sixteen, and many genera of the Myriapoda from fifteen to thirty.

The resemblance between the limbs of *Limulus* and *Scorpio* does not seem to us so great as it is often assumed to be. The five pairs of jaws ranged round the ventral mouth of *Limulus*, whether our theory of their origin from Annelidan parapodia is true or not, form a feature which has no counterpart in the limbs of *Scorpio*. This is, to our mind, a most important



point, for in most other respects all Arthropodan legs strongly resemble one another, and the presence of chelæ on a certain number of anterior limbs is a common occurrence. Again, is there anything in *Limulus*, or in any Crustacean, which resembles the two chitinous hooked-claws at the ends of the legs of *Scorpio*, which the latter possess in common with all other Tracheata? Nor do we find in the Scorpionidæ any special development of the sixth pair of limbs such as we have shown to be characteristic not only of the Apodidæ but of the Trilobitæ, the Xiphosuridæ, and the Eurypteridæ, and which is especially marked in the last, although this is claimed as a transition form between the Xiphosuridæ and the Arachnida.

We do not, then, admit that very much weight can be laid upon this agreement in number of segments and in number and form of limbs. It certainly cannot outweigh, for purposes of classification, the tracheæ and the Malpighian vessels, the presence of which in the Scorpionidæ and other Arachnida classes them unmistakably with the Tracheata.

Even if we admit the possibility of the concurrent development of tracheæ and Malpighian tubules for a second time, the improbability of such an occurrence is so great that we should require much stronger evidence than any which has been adduced before we could accept it. It is, further, very improbable that such a highly specialised animal as a species of *Eurypterus* should develop exactly the same respiratory and excretory adaptations to a land life as the more generalised Annelidan ancestor of the other Tracheata.

The origin of the book-leaf tracheæ from the gills of the Xiphosuridæ, fascinating as it is, breaks down when carried into detail. It is easier to believe that the lung-books are only a specially concentrated arrangement of the tracheal tubes, no more extraordinary than the other extreme, viz. the diffuse arrangement found in the Hexapoda. We find almost every form of tracheal arrangement between these two extremes within the division of the Tracheata, and further both tubular and book-leaf tracheæ within the Arachnida. We think that the evidence in favour of the new classification, to be drawn from the form of the tracheæ, is not convincing.

The most probable origin of the tracheæ appears to us to be that which refers them back to dermal glands. The original Tracheatan-Annelid on first migrating on to the land probably respired through the whole skin. The increase of surface afforded by the ducts of the dermal<sup>1</sup> glands would very naturally be taken advantage of. The walls of these ducts being internal, their surfaces would be selected and specialised until they undertook the whole respiration. That this was the origin of the tracheæ is rendered very probable by the fact that the openings of the tracheal tubes in *Peripatus* are, in some species at least, scattered irregularly over the whole body. This derivation of the tracheæ from dermal glands receives some support also

<sup>1</sup> If these include the coxal glands, it may throw light upon the developmental relations between the book-leaf tracheæ of the Arachnida and their rudimentary abdominal limbs.

from the fact that it is accompanied by the development of the Malpighian tubules, except in Peripatus, where the nephridia are retained. The loss of the dermal excretion necessitates the further development of other excretory surfaces. The advantages of the Malpighian tubules, or glandular cæca of the hind-gut, over excretory organs in any other part of the body have been already dwelt upon. This physiological connection between tracheæ and Malpighian vesicles which lessens the improbability of their concurrent development *twice*, cannot however be taken advantage of in the special case under discussion, because the tracheæ are not supposed to have been dermal glands but imbedded external gills.

The early differentiation of the Arachnida from the original Tracheatan-Annelids accounts for the high specialisation of their tracheal gills. The same may be said of the Myriapoda, while Peripatus has remained in this respect, as in so many others, almost entirely undifferentiated.

In addition to these arguments we have to refer on the one hand to those brought forward in this essay to show that *Limulus* is a Crustacean, and on the other hand to the discovery of rudimentary antennæ in the embryo of a spider,<sup>1</sup> which removes the only difficulty in the way of homologising the limbs of the Arachnida with those of the Antennata.

It seems to us that we find evidence of the early specialisation of the Arachnida, not only in the loss of the antennæ, in the form of the limbs and tracheæ,

<sup>1</sup> *Trochosa Singoriensis* Laxm. See *Zool. Anzeiger*, May 11, 1891.

and in their general organisation, but in the possession of a sternal plate or entosternite. The same explanation given in this essay of this sternal plate in *Apus* and *Limulus* must be applied here. It is due to a massing together of the ventral longitudinal muscle bands of a certain number of anterior segments, so that their muscular elements disappear, leaving the sinewy elements for the attachment of transverse muscles. In the primitive Crustacea, the longitudinal muscles of these segments were rendered useless by the bending of the body. In the Arachnida, however, they were rendered useless by the axial fusing of the segments; while the muscular elements degenerated, the sinewy elements were retained to form the entosternite. This seems to show that the Arachnida were differentiated from the Tracheatan-Annelid at a stage when the Annelidan segments were still of the typical form, i.e. before the ventral longitudinal muscle bands had become specialised in adaptation to new modes of life.

In conclusion, it may be interesting to see how *Peripatus* compares with *Apus* as a transition form. The Annelidan characteristics of *Peripatus* are certainly more visible than are those of *Apus*, where they are all more or less disguised or transformed. On the other hand, *Peripatus* is a development by itself, and can hardly be shown to have given rise to any group of the Tracheata. It is *indirectly* a most remarkable transition form, having preserved so many characteristics of the common racial Tracheatan-

Annelid. We think that a little more may be claimed for Apus, and that in its organisation it takes a distinct place in the direct line of descent of many of the modern Crustacea from the original Crustacean-Annelid.



## APPENDIX I

ON comparing the East Spitzbergen species found by Professor Kükenthal with the West Spitzbergen species found by Professor Nathorst, we concluded that they are identical, but that *L. Spitzbergensis* differs considerably from *L. glacialis* in size and in the shape of the caudal plate. We were at first disposed to consider it a new species, especially on account of its possessing second antennæ which were said to be wanting in *Lepidurus glacialis*. Closer examination, however, showed it to be a small variety of *L. glacialis*, most probably derived from the latter by being obliged to ripen at an earlier stage of development, in adaptation to the shortness of the more northerly summer.

That this view is correct seems probable from the following considerations :

(1) The possession of second antennæ does not distinguish it from *L. glacialis*, for we have succeeded in finding these appendages on the latter.

(2) The position of the sperm-forming centre (see § on reproduction) is identical in the two.

(3) The genital tube is very much simpler, the diverticula showing hardly any traces of branching, therein exhibiting a more larval condition.

(4) The same may be said of the smaller size of the caudal plate, which develops gradually, as Brauer has shown in his paper on the development of *L. productus*.

(5) The small size of the whole animal also agrees with the supposition.

It is interesting to find that Packard's measurements for *L. glacialis* (from Cape Krustenstern?) make it even smaller than the Spitzbergen variety. From this, however, it is difficult to draw any certain conclusions, as his drawings give a fully-developed tail-plate (see Monograph of the North American Phyllopoda). It thus appears that *L. glacialis* may be much stunted by unfavourable surroundings.

That the specimens from Spitzbergen were not young specimens follows from the facts that they (several hundred) were nearly all the same size, and that they were caught in the end of August, a week or so before the close of the short summer, while the freshwater pools were still unfrozen. Professor Kükenthal informs me that this season in the latitude in which they were found lasts about ten weeks.

Packard's measurements for a fully developed *L. glacialis* make it doubtful whether we are to look upon this variety as permanent. It is possible that in favourable summers they may further develop (without any great increase of size) into stunted *L. glacialis*. This question, however, can only be certainly answered by cultivating specimens further south, in an aquarium, to see whether they develop into *L. glacialis*. In the meantime it will be useful to call the animal *L. glacialis* var. *Spitzbergensis*, or, for shortness, *L. Spitzbergensis*.



## APPENDIX II

### THE EYE-PIGMENT OF APUS

It was very difficult to decide whether the cells marked  $p$  in the diagram (Fig. 43) of the eye of *Apus* were really cells, as there drawn, or only collections of very minute pigment cells. [Grenacher, in his drawings of the single eyes of *Apus*, leaves the matter rather indefinite. He indicates rather than draws the pigment cells with nuclei. His drawing leaves the impression that he took it for granted that they were large pigment cells, without actually ascertaining the facts.] We were at first inclined to take the latter view, having found that under a very high power,<sup>1</sup> the granules themselves were not easy to distinguish from cells. Each one consists of a stainable nucleus surrounded by a pigment crust, the whole being enclosed in a layer of some hyaline substance. These "cells" were of all sizes (from 1-2  $\mu$ ), and were found in all stages of fission (see Fig. 65). There are thus two ways of regarding these pigment masses in the eye of *Apus*. Either the whole is a kind of loose syncytium of minute pigment cells, as we at first thought, or these pigment granules are formed inside a large cell around stainable protoplasmic granules, as starch is formed round the leucoplasts. This we now think to be the case.

<sup>1</sup> Zeiss apochromatic 2 mm. homogeneous immersion, 1.40 n.a., eye-piece No. 12, giving 1500 diam.

Although we cannot be certain that we have seen the nuclei of the large pigment cells as shown in the diagram (Fig. 23, p. 139), we concluded that there must be such nuclei, and that the pigment masses were real cells and not syncytia. We were chiefly led to this conclusion by noticing the long regular lines of granules running down the nerves towards the optic ganglion, as shown in the diagram. It seemed to us that these rows of single granules would not be so straight and even, unless enclosed within a long pseudopodium-like process of the pigment cells. Were the granules semi-independent cells, their arrangement could hardly be so straight and regular. We

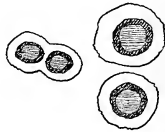

FIG. 65.—Pigment granules (? cells) from the eye of *Apus*,  $\times$  ca. 3000, showing a stainable nucleus, surrounded by a thin crust of brown pigment, the whole enclosed within a hyaline substance.

were further induced to take this view from finding that, in some specimens, the pigment in the unpaired "eye" was composed of similar eye-pigment granules, also arranged in long pseudopodium-like strands. In most of the specimens examined, the pigment in the unpaired "eye" was similar to that in the pigment cells of the rest of the body, *i.e.* it was in the form of very minute olive green granules. The occasional finding of eye-pigment in the unpaired "eye" was especially interesting in reference to the origin we attributed to that organ out of an anterior pair of Annelidan eyes.

Around the paired eyes, the green pigment reaches up to their very rim, and indeed stretches over the outer edges of

the eye itself, but there it changes into the black brown granules above described.

These "eye-pigment" granules certainly appear to be very primitive formations. The utilisation of excretory matter as pigment is at once suggested, the incrustation of brown stuff round the nucleus reminding one forcibly of the incrustation of excretory matter round the blood corpuscles under the dorsal organ (see Appendix IV.). In the pigment granules, however, it was quite regular, whereas it was irregularly massed around the blood corpuscles. These corpuscles, again, are very much larger than the pigment-forming granules, and moreover fairly uniform in size, whereas the latter are of all sizes.

## APPENDIX III

### CIRCULATION

As far as we know, since Zaddach's time no detailed account of the circulation of *Apus* has been given. Gerstaecker adopts and incorporates Zaddach's description in Bronn's *Klassen und Ordnungen*, vol. v. Zaddach's observations seem to have been made on living transparent animals. All who have tried this method know how difficult it is to make out the details, however visible some of the main streams may be. Thus Zaddach's plan of the circulation requires considerable amendment.

As already pointed out in the text, the system is a lacunar system through which the blood is propelled by a contractile dorsal vessel or heart. On the expansion of the heart the blood is drawn out of the cardial sinus to be propelled forwards through (1) the anterior aorta to supply the head and liver, and (2) the two lateral vessels which dip down under the shell gland to convey blood into the shield.

The heart is composed of striated circular muscle fibres crossing each other diagonally—the muscle-cells being turned inwards, and forming a kind of syncytial lining to the tube. The heart is suspended by an exquisite arrangement of connective-tissue fibres, which, seen together under a low power, take the form of triangular wings. These connective tissue alæ are not flat and membranous,

but composed of a number of fibres attached to the walls of the heart over a considerable area around the ostia. They may either be contractile and serve to expand the heart, or, more probably, elastic and restore the heart to its expanded condition after each contraction.

The blood, after circulating through the head, runs ventrally backwards through the intestinal sinus, towards

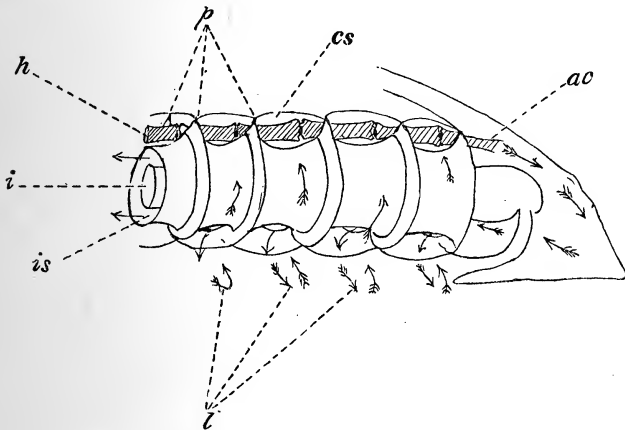

FIG. 66.—Diagram to illustrate the plan of the circulation in the anterior part of the body. The blood propelled by the heart (*h*) through the head, is returned through the intestinal sinus (*is*) from which in each segment it escapes ventrally into the limbs. Its course is indicated diagrammatically by the arrows (*l*). From the limbs it returns through the dermo-muscular sinus in each segment into the cardiac sinus (*cs*). *i*, intestine; *ac*, aorta cephalica; *p*, points of attachment of the dorso-ventral muscle bands.

the posterior end of the body. Near each pair of limbs, the membrane forming this sinus appears to be fenestrated, the openings being regulated by special muscles (?). Through these windows the blood streams down over the ventral cord and into the limbs on each side; it runs along the ventral face of the limbs, returning along the dorsal. On its way back it is guided into the gills, and thence back

into the body, where it flows up between the membrane of the intestinal sinus and the body wall, bathing the musculature in its course. It is interesting to note that a special separate stream flows from each limb into the cardiac sinus, there being membranous dissepiments, corresponding with

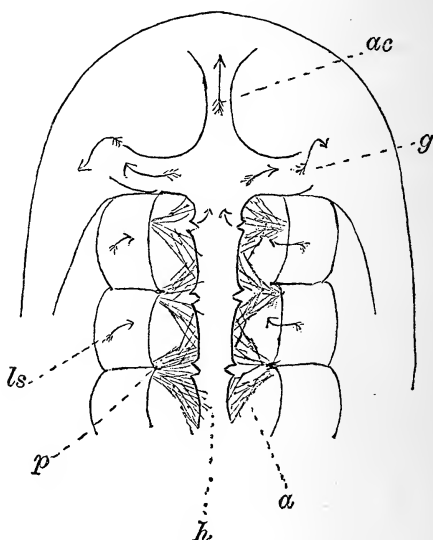

FIG. 67.—Diagram of the circulation from above. *h*, heart, expanded by the fine connective tissue *a*; *s*, segmental septa forming the transverse walls of the dermo-muscular sinuses (*ls*); *ac*, cephalic aorta; *g*, lateral artery to shell and shell gland; *p*, points of attachment of dorso-ventral muscle bands to dorsal wall.

the segmental constrictions, stretched between the body wall and the membrane of the intestinal sinus. The dissepiments, which have already been described in the text, are only formed in the first ten to eleven segments, *i.e.* as far as the heart extends. Thus while part of the blood, flowing through the intestinal sinus, passes down through

the openings above the ventral cord into the limbs, to find its way back to the heart after passing through the gills, the rest continues posteriorly, bathing the intestinal canal (the hind-gut) to find its way, by some means which is not yet clear, into the dermal sinus which, in the posterior part of the body, is continued right round the body, there being no dissepiments and no separate cardinal sinus. It then flows forwards till the first lateral dissepiment confines it to the dorsal channel which contains the heart and forms the cardinal sinus. How the blood finds its way from the intestinal to the dermal sinus in this posterior part of the body we have not been able to ascertain. A longitudinal dissepiment runs right along each cercopod or anal cirrus, which shows that the blood flows along one side and back by the other. We may also perhaps assume that under the two rudimentary cirri openings occur corresponding with the communication which once existed at the tips of the cirri which they represent. These are however probably not the only openings between the two sinuses. We have not been able to make out the relation of the circulation to the rudimentary limbs; sections of the rudimentary gills seem to show that they are functional as such.

We have seen that special muscles probably regulate the flow of the blood out of the intestinal sinus into the neural sinus (if it can be so called), on its way to the limbs. There can be no doubt that the dorso-ventral muscle-bands play a part in propelling the blood through the sinus. The intestinal musculature, except in the hind-gut, is too weakly developed to assist much. But it is easy to see how, in such a tubular sinus, the movements of the intestinal canal running along its centre could materially help the circulation of the fluid between them.

We had no means of following the course of the blood

from the dorsal shield after bathing the shell glands. As far, however, as anatomical researches enable us to judge, we cannot confirm Zaddach's statement that it returns to the heart through special *venæ branchiales*. We think that when this point comes to be further investigated it will probably be found that the blood, which enters the shield laterally, circulates round through it, and returns to re-enter the body anteriorly and dorsally ; not, however, to enter the cardial sinus, but rather to descend on each side of the cephalic aorta, bathing the mandibular muscles on its way to join the main stream from the head into the intestinal sinus.



## APPENDIX IV

### EXCRETION

*The Shell Gland.*—The shell gland falls easily into three typical sections (Fig. 30, p. 125); the terminal saccule, the urinary canal, and the urinary duct with the bladder. The terminal saccule is branched and irregular, and lies in the blood stream between the central coils of the urinary canal. As far as we could judge from our material it seemed to be lined by large flat granulated cells, resting upon a fine basal membrane. It is difficult to say if the large vacuoles to be seen in many of them are natural.

The urinary canal shows the structure depicted in Fig. 68, which is characteristic of the antennal gland of the other Crustacea. Grobben described the striped appearance as being due to protoplasmic strands arranged vertically on the basal membrane owing to the active streaming from without into the lumen of the tube. Tangential sections of the membrane, however, show it to be an independent spongy structure, like hardened foam (see Fig. 68, to the right), forming a strong but very porous support to the large flat epithelial cells. Grobben figures the nuclei as imbedded in this striped membrane. In *Apus*, however, they lie with their surrounding protoplasm on the membrane, here and there heaped up, or even artificially torn away, in both cases leaving the membrane intact, which would hardly have

been the case if the striation were really due to strands of protoplasm free in the cells. There is no trace in *Apus* of a chitinous cuticle lining the canal.

The nuclei of the epithelium are very large and oval, the longest diameter being  $40-45\mu$  (in a specimen of *A. cancriformis*), *i.e.* slightly larger than the nuclei of the nutritive cells of the eggs, a sign of their great physiological activity in the economy of the animal.

The urinary canal shows a slight widening as it bends

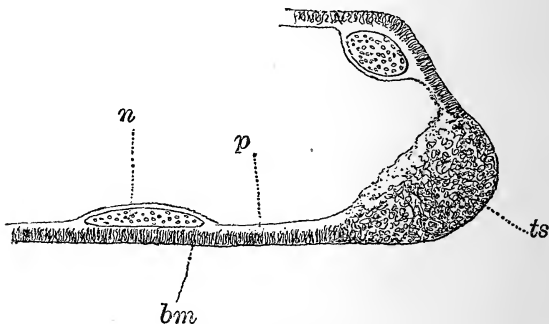

FIG. 68.—Part of a section of the urinary canal (shell gland of *Apus*). *bm*, basal membrane on which rests the harder supporting framework, seen in tangential section (at *ts*) to have a spongy structure; *p*, inner layer of protoplasm; *n*, nuclei with numerous clear round nucleoli.

down towards the ventral side. We at first thought that this might be the bladder, but there is no change in the character of the epithelium. At the base of the second maxilla, this wider portion leads through a very narrow chitinous canal into the true bladder, which is a chitin-lined sac in the shaft of the limb. The chitinous lining of the bladder, which distinguishes it from the urinary canal, makes it a suitable reservoir for excretory fluids.

The opening of the duct at the tip of the second maxilla is shown in Zaddach's drawing as a point which he, however,

did not understand. Claus recognised it as an opening of the shell gland. This, as already shown, we have been able to confirm by following the gland through series of sections.

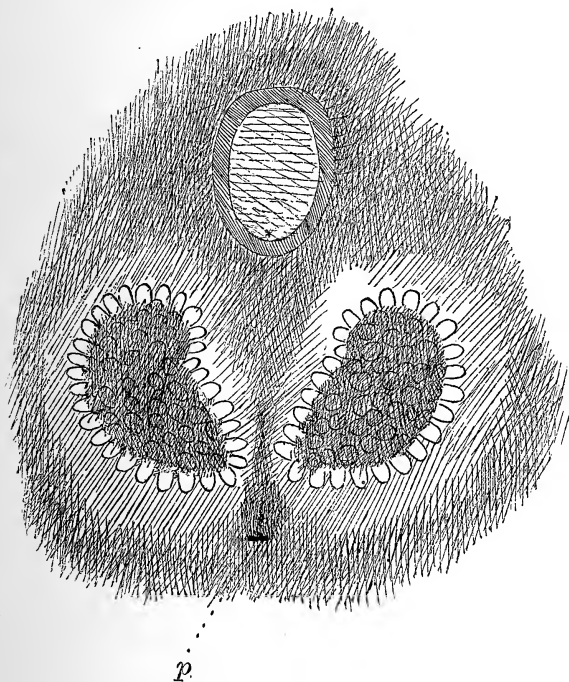

FIG. 69.—Sketch of the region about the eyes of an adult specimen of *L. productus*, showing the relative position and sizes of the dorsal organ, the paired eyes and the pore (*p*) leading into the water-sacs. At the anterior end of the dorsal organ is seen the fine pore mentioned in the text.

*The Dorsal or Neck-Gland.*—One more gland in Apus, the neck- or dorsal gland, remains to be mentioned. It shows as an oval spot behind the eyes, and is

visible in all the Apodidæ. We originally thought that this spot was the remains of a frontal cirrus which travelled back with the eyes, but which, being a hindrance to swimming and burrowing, had become quite rudimentary. Gerstaecker suggests the homology of it with the frontal cirrus (Stirnzapfen) of the Ostracoda. From lack of any detailed study of its finer structure it has, in fact, been very generally claimed as a sensory organ of some kind. A close microscopic study of it, however, shows very clearly that it is an excretory organ.

Fig. 70 shows the surface view, and Fig. 71 shows it in longitudinal section—both are taken from adult specimens of *L. productus*. Fig. 38, p. 160, shows it in the Nauplius of *Apus cancriformis*. From this last figure we may perhaps get a hint as to its real origin and significance, viz. that it was the larval excretory organ.

First, however, as to its structure. A longitudinal section shows us a number of fine connective-tissue strands stretched between the thin cuticle of the organ and the connective tissue belonging to the longitudinal muscle-bands, which bend round over the mid-gut to be attached close to the prostomium. These fibres lie in the full blood stream issuing from the aorta cephalica, and form a net-work to arrest the blood corpuscles.<sup>1</sup> This net-work does not, however, stretch right across, but, as the animal always swims on its back, it forms, as in the drawing, a ground-net to catch those particles which sink, and roll along the bottom. Hence, while the ordinary blood corpuscles shoot through the open part as indicated by the arrow, those laden with excretory matter are caught in the net spread across their path as they roll heavily along. The whole action is purely mechanical ;

<sup>1</sup> This interesting use of the connective-tissue fibres is well illustrated in many parts of *Apus*, particularly around the large reserve or fat cells. It has already been noticed by Grobben in another connection.

the corpuscles laden with waste stuff are too large to pass the meshes; they seem to stick on to the connective tissue fibres and gradually find their way down to the hypodermis, where they either break up or else, after discharging their burdens, return into the blood stream. We are inclined to think the latter to be the correct account, for the connective-

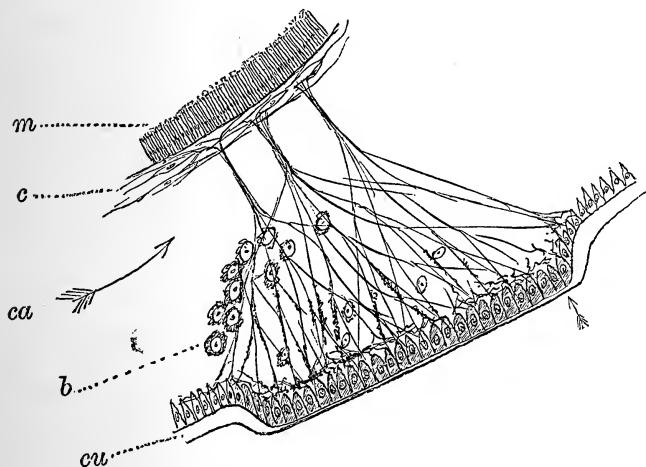

FIG. 70.—Diagram of a section of the neck gland or dorsal organ of Apus, drawn upside down (*i.e.* as the animal swims) so as the better to illustrate the catching of the laden blood corpuscles in the connective tissue net. *m*, epithelium of the mid-gut; *c*, connective tissue belonging to the longitudinal musculature; *ca* blood stream from the aorta cephalica; *b*, blood corpuscles laden with excretory matter; *cu*, cuticle (the small arrow indicates the position of the pore shown in the last figure). The glandular epithelium is shaded dark.

tissue strands were covered with excretory matter, and the corpuscles near the hypodermis were not nearly so heavily laden as those newly arrived. The hypodermis cells themselves were very different from those of the ordinary cuticle; they were much larger, with larger nuclei, each nucleus containing two or three nucleoli, whereas the ordinary hypodermis cells have but one nucleolus. They also stain badly-

having a muddy look, doubtless due to the excretory matter absorbed. How this matter is discharged we cannot see. The cuticle is extremely thin and perhaps allows of passage through it. If so, what is the use of the single fine pore at one end, which by itself could apparently only relieve one or two of the hypodermis cells? We have thus not been able to ascertain the mechanism of discharge, but that the whole organ is essentially glandular, no one who has studied it can doubt.

We can say nothing certain as to the origin of this organ. From its relatively enormous size in the Nauplius,<sup>1</sup> it is clearly the principal larval excretory organ, and undertakes the discharge of waste products before the shell gland appears. It may perhaps be a sort of island of Annelidan hypodermal glandular cells left by the developing exoskeleton, taking the place of the head nephridia of the Annelidan larva. That these latter should not be developed, owing to the bending double of the front segments of the Crustacean-Annelid, was to be expected. We may perhaps therefore find in this neck organ a group of dermal glandular cells, derived from the Annelidan dermal glands, and serving for excretion until the typical Crustacean glands are developed. Its singular position in the larva may perhaps be considered as protective, since an excretory gland might well serve as a protective organ on the exposed dorso-frontal surface.

A comparative study of this organ, which also plays an important part as an excretory organ in most Crustacean embryos or larvæ, is much to be desired. According to Bullar, in some Isopodan embryos it forms as an invagina-

<sup>1</sup> In the Nauplius, figured p. 160, it measures about 0.25 mm., whereas that of the adult *L. productus* (Fig. 69) measures only 0.5 mm. Brauer, curiously enough, shows no traces of it in the Nauplius of *L. productus* (Fig. 35).

---

tion of the ectoderm. As a starting point for such a comparative study we should like here to emphasise the fact that, if our theory is correct, the primitive structure of the organ is most probably to be found in the larva of *Apus*, and that its form in the other Crustacea must have been derived from that. We do not therefore see any reason to modify our suggestion as to its origin because of the fact that in the higher Crustacea it first appears as a more complicated, and even sometimes as a paired, organ.

It is this organ which, in the *Daphnidæ*, functions as a sucker for fixing the little animals to stationary objects. The glandular nature of the organ might easily be supposed to assist this action by supplying a slimy secretion.

# APPENDIX V

## REPRODUCTION

### A. HERMAPHRODITISM OF THE APODIDÆ.<sup>1</sup>

(From *Nature*, vol. xliii. p. 343.)

THE reproduction of *Apus cancriformis* has been a much discussed subject. Although the animal has been well known since the middle of last century, it was not till 1833 that a male was reported to have been found, and not till 1856 that the occasional presence of males in small numbers was certainly established by Kozubowski. On the other hand, the fact that several generations of "females" could be produced without the presence of a male, was established as long ago as 1755 by Schaeffer, who concluded that the animals were hermaphrodite. Since that time authors have been divided in opinion between hermaphroditism and parthenogenesis (not to mention v. Siebold's theory of Thelytoky); the latter view has lately prevailed.<sup>2</sup>

<sup>1</sup> The letter here reprinted was written before the author had recognised the Annelidan character of *Apus* which led to the writing of this book; hence its point of view is not altogether the same as that of the foregoing pages.

<sup>2</sup> For the history of this subject see Bronn's *Klassen und Ordnungen des Thierreichs*, vol. v. On p. 810 the following words occur:—"Untersuchungen über die Gattungen *Apus* und *Daphnia*, welche offenbar in dem bis zu voller Evidenz geführten Nachweis der parthenogenetischen Fortpflanzung beider gipfeln." See also Lang's *Lehrbuch der Vergleichende Anatomie*, p. 393.



The animals, however, prove after all to be hermaphrodites. Since the last careful study of *Apus cancriformis*, as a whole, by Zaddach in 1841 (the works of Ray Lankester and others deal only with special points), new methods of research have been introduced into our laboratories which reveal details not easily discoverable by the older methods. Zaddach's figures of the ovaries and testes of *Apus* are thus naturally somewhat deficient—as deficient, indeed, as the best work we can do to-day will, we hope, be found to be fifty years hence.

\* \* \* \* \*

In my preliminary notice (*Jenaische Zeitschrift für Naturwissenschaft*, Band xxv., N.F. xviii.) announcing the hermaphroditism of *L. Spitzbergensis*, knowing how much the reproduction of the Apodidæ had been discussed, I ventured to assert that in all probability the other species of the genus would also prove on closer examination to be hermaphrodite. As above stated, I found the sperm-forming centres in *L. glacialis* in identically the same position as in the Spitzbergen variety. By the kindness of Professor Möbius, the Director of the new Berlin Museum, and of the Rev. Canon Norman, I have also been able to examine *Apus cancriformis* and *Lepidurus productus*. In both these the sperm-forming centres were found scattered here and there among the rich branchings of the segmental diverticula of the genital tube. They occur either at the tips of such branches, where the eggs ordinarily develop, or as slight lateral bulgings of the same. In all cases the spermatogenesis is the same, the epithelium breaking up into sperm-cells; these escape into the lumen of the tube, and are found in considerable numbers near the genital aperture, where the epithelial lining of the tube is hardly demonstrable, the walls of the tube consisting of a fibrous membrane, in the folds of which

the sperm-cells lurk. The eggs are then fertilised as they stretch this membrane in passing out into the egg pouch. The whole richly-branched reproductive organ, with the eggs developing at the tips of the branches, and with here and there a testis, strongly reminds one of a monœcious plant, self-contained, and able to dispense with pollen from without.

I reserve the drawings and the more detailed description of the reproductive organs of the different species for a short comparative study of the Apodidæ which I hope soon to have ready for the press.<sup>1</sup> By way of caution, however, I should here add that small yellowish sacs filled with minute cells occur here and there among the developing eggs. These must not be mistaken for the testes. They are the loci of discharged eggs, and the minute cells are the epithelium cells dislodged by the shrinking of the membrane of the genital tube, which is stretched some 100-fold by the ripening eggs.

The origin of this secondary hermaphroditism is not far to seek ; it is clearly a protection against isolation, as in the case of the Cirripedia and certain parasitic Isopoda. The manner of life of all these animals is such that they are always in danger of being cut off from their kind ; they would thus die out unless able to reproduce either parthenogenetically or by means of self-fertilisation.

Some species of Cirripedia, as is well known, have dwarf males, the last remains of the original separation of the sexes. As already mentioned, small males of *Apus cancriformis* are sometimes found. Twelve finds of *A. cancriformis* and *L. productus* recorded by Gerstaecker, give 4,458 "females" (*i.e.* hermaphrodites) to 378 males ; while sixteen

<sup>1</sup> As stated in the Preface, this intended work gave way before the more ambitious task of trying to prove *Apus* to be but a modified carnivorous Annelid.

finds, numbering 10,000 individuals, did not contain a single male. I have found no record of a male *L. glacialis*, and none of the twenty odd specimens of the Spitzbergen variety I have as yet examined have been males. It is probable that throughout the whole genus self-fertilisation is taking the place of cross-fertilisation, but that some species have gone further than others in dispensing with males. Two species, for instance, *L. couesii*, Packard, and *L. macrurus*, Lilljeborg, are reported to have more males than "females" (?), but the finds in these cases seem hardly large enough to allow us to judge; it may have been purely accidental that more males than "females" were caught.

The males of the Apodidæ, with the doubtful exception of *L. productus*, seem to be smaller than the hermaphrodites, otherwise there is no very pronounced sexual dimorphism, as there is among the Cirripedia. We are perhaps justified in concluding from this that the hermaphroditism of the Cirripedia is of much older date than that of the Apodidæ. No comparison is here, however, possible, since the two have nothing further in common beyond the fact that they are both hermaphrodite, and that this hermaphroditism is in both cases an adaptation against extermination through too wide dispersion of the individuals.

## B. ON THE FORMATION OF THE EGGS.

The regular formation of the eggs out of four cells, of which three are nutritive and one the definitive egg-cell, gives opportunity for many interesting observations. The general method of growth is shown in Fig. 33, p. 144, where we see the egg in different stages.

The originally round group of cells as a rule soon becomes oval, in consequence of the more active growth

of the three nutritive cells. Traces of this activity can be seen in the different staining of the protoplasm. That round the definitive egg nucleus remains a rose pink when stained with carmine, while that round the other nuclei has a coarse red colour, and a high magnifying power reveals very clearly the meshes of the spongioplasm of this part widened out, and dotted with small lumps of nuclein which are evidently the lecithoblasts.

On examining the small disk-like grains of yolk with a very high power, and repeatedly changing the focus, the small stained lecithoblast in its centre is found not to be a nucleus surrounded with yolk, but a thread passing through the disk, which is thus like a flat bead threaded on the filaments of the chromatin spongioplasm. It is not, however, a smooth thread which passes through the yolk disk, but it has irregularities consisting of sometimes one, sometimes two of the minute lumps of nuclein, these being apparently nothing but slight thickenings of the chromatin fibres. The yolk disks are, therefore, not nutritive masses floating freely in the protoplasm of the cells (like starch grains?), but they remain in organic connection with the nucleus.

There are many further points of great interest which we have not yet succeeded in following; for instance, the nature of the membrane dividing the cells, its relation to the spongioplasm, its gradual disappearance so that the spongioplasm of all the four cells becomes one continuous whole. We especially wished to find out whether the threads of spongioplasm of the different cells ran into one another through the membrane or not. The former seemed to us to be probable; if not, we should have to assume that, on the disappearance of the nuclei of the nutritive cells, and of the dividing membranes, the threads of their spongioplasm joined those of the definitive egg-

cell, in order that the ripe egg should constitute an organic whole with yolk disks threaded on its chromatin filaments. Sedgwick's observations on the development of the Cape species of *Peripatus*<sup>1</sup> make it probable that these dividing membranes are but differentiations of the spongework itself. The disappearance of the membranes would then be nothing more than the *re*-arrangement of their substance as a spongework, which must necessarily connect the spongeworks of the neighbouring cells.

## LITERATURE

Besides the well-known text-books of Balfour (*Embryology*), Claus (*Zoology*), Gegenbaur, Huxley, and Lang (*Comparative Anatomy*), Gerstaecker (*Crustacea*, Vol. V. of Bronn's *Klassen und Ordnungen des Thierreichs*), Haeckel (*Natürliche Schöpfungsgeschichte*), Rollston (*Forms of Animal Life*), and Zittel, Nicholson, and Lydeker (*Palæontology*), the following are the chief works which have been consulted :—

BAIRD.—A Monograph of the Family Apodidæ. *Proceedings of Zool. Soc.*, London, 1853.

BARRANDE.—Système Silurien de la Bohême. Vol. I. and Suppt.

BEDDARD.—On the possible Origin of the Malpighian Tubules in the Arthropoda. *Ann. N.H.* (6) IV.

BOURNE (see Lankester).

BRADY.—A Monograph of recent British Ostracoda. *Tr. Linn. Soc.* Vol. XXVI.

BRAUER.—Ueber die Entwicklung des *Lepidurus productus*; in *Sitz. Ber. d. K. Acad. d. Wissensch.*, Wien, Vol. LXIX., Pt. I., 1874.

<sup>1</sup> *Q. J. M. S.*, Vol. XXVI.

- BRAUER.—Beiträge zur Kenntniss der Phyllopoden. In the same, Vol. LXV., Pt. I., 1872, and further in 1878.
- BUCHANAN.—Respiratory Organs in Decapodous Crustacea. *Q.J.M.S.* Vol. XXIX.
- BURMEISTER.—Die Organisation der Trilobiten aus ihren lebenden Verwandten entwickelt. Berlin, 1843.
- CARRIÈRE.—Die Sehorgane der Thiere. München und Leipzig, 1885.
- CLAPARÈDE.—Les Annélides Chætopodes du golfe de Naples. Genève, 1868, supplément, 1870.
- CLAUS.—Zur Kenntniss des Baues und der Entwicklung von *Branchipus stagnalis* und *Apus cancriformis*. Göttingen, 1873.
- „ Untersuchungen zur Erforschungen des Crustaceen Systems. Wien, 1876.
- „ Organisation und Entwicklung von *Branchipus* und *Artemia*. *Arb. Zool. Inst.* Wien, 1886.
- „ Neue Beiträge zur Morphologie der Crustaceen. *Arb. Zool. Inst.* Wien, 1886.
- „ Neue Beobachtungen über Cyprididen. *Zeitsch. für Wiss. Zool.* Vol. XXIII.
- „ Organisation of *Nebalia*, and Systematic Position of the Leptostraca. *Ann. N.H.* (6) III.
- DOHRN.—Geschichte des Krebs-Stammes nach embryologischen, anatomischen und palæontologischen Quellen. *Jenaische Zeitsch.* Vol. VI., 1871.
- EHLERS.—Die Borstenwürmer. Leipzig, 1864-68.
- FERNALD.—The Relationships of Arthropoda. Studies from Biol. Lab. Johns Hopkins University. Vol. IV., 1890.
- V. GRABER.—Morphologischen Untersuchungen über die Augen der frei-lebenden marinen Borstenwürmer. Bonn, 1879.

- GRENACHER.—Untersuchungen über das Sehorgan der Arthropoden. Göttingen, 1879.
- GROBBEN.—Die Antennendrüse der Crustaceen. *Arb. Zool. Inst.* Wien, 1880.
- „ Entwicklungsgeschichte der *Moina rectirostris*. *Arb. Zool. Inst.* Wien, 1879.
- GRUBE.—Bemerkungen über die Phyllopoden. *Archiv für Naturwiss.* Vol. XIX., 1853.
- HATSCHKE.—Lehrbuch der Zoologie.
- HERRICK.—Metamorphosis and Morphology of certain Phyllopod Crustacea. Bulletin, Denison University, 1885.
- HUXLEY.—The Crayfish. International Science Series.—4th Ed., 1884.
- JONES & WOODWARD.—Monograph of the British Palæozoic Phyllopoda, 1888.
- KINGSLEY.—Notes on the Embryology of *Limulus*. *Q.J.M.S.* Vol. XXV.
- KORSCHULT UND HEIDER.—Vergleichende Entwicklungsgeschichte der wirbellosen Thiere. Jena, 1891.
- KROYER.—*Apus glacialis*. *Naturhist. Tidskrift.* 2 Räk., 1847.
- LANKESTER.—The Appendages and Nervous System of *Apus Cancriformis*. *Q.J.M.Sc.* Vol. XXI.
- „ *Limulus* an Arachnid. *Q.J.M.S.*, XXI. And further Vol. XXV.
- LANKESTER AND BOURNE.—The minute Structure of the lateral and central Eyes of *Scorpio* and *Limulus*. *Q.J.M.S.* Vol. XXIII.
- LILLJEBORG.—Synopsis Crustaceorum Svecicorum. Reg. Soc. Sc. Upsaliensi. Tradita die vii. April. 1877.
- LUBBOCK.—Notes on some New and Little Known Species of Freshwater Entomostraca. *Trans. Linnean Soc.*, 1863.

- LUBBOCK.—Origin and Metamorphosis of Insects. *Nature* Series, 1890.
- MILNE EDWARDS.—Recherches sur l'Anatomie des Limules. *Anal. Sc. Nat.* 5th Série. T. XVII. Paris, 1873.
- MÜLLER, FRITZ.—Facts for Darwin. Translated by Dallas.
- PACKARD.—Monograph of the North American Phyllopoda, Twelfth Annual Report of the U.S. Geological Survey. Washington, 1883.
- „ Development of *Limulus Polyphemus*. Soc. Nat. Hist., Boston, Vol. XI.
- „ Anatomy, Histology, and Embryology of *Limulus Polyphemus*. Boston, 1880.
- And other shorter papers by the same Author.
- PELSENER.—Nervous System of *Apus*. *Quart. Journ. Micro. Sc.* Vol. XXV.
- WALCOTT.—The Trilobite. Old and New Evidence relating to its Organization. *Bull. Mus. Comp. Zool.* Vol. VIII. *Camb., Mass., U.S.*, 1880-81.
- WATASE.—On the Morphology of the Compound Eyes of Arthropods. Studies from Biol. Lab. Johns Hopkins University. Vol. IV., 1890.
- WOODWARD.—British Fossil Crustacea. 1872.
- ZADDACH.—De *Apodis Cancriformis*. Bonn, 1841.
- ZENKER.—Monographie der Ostracoden. 1854.
- &c., &c.



# NATURE SERIES.

Crown 8vo.

## THE ORIGIN AND METAMORPHOSES OF INSECTS.

By Sir JOHN LUBBOCK, M.P., F.R.S. With Illustrations. 3s. 6d.

## THE TRANSIT OF VENUS. By Prof. G. FORBES. With

Illustrations. 3s. 6d.

## POLARISATION OF LIGHT. By W. SPOTTISWOODE,

LL.D. Illustrated. 3s. 6d.

## ON BRITISH WILD FLOWERS CONSIDERED IN RELATION TO INSECTS. By Sir JOHN LUBBOCK, M.P., F.R.S.

Illustrated. 4s. 6d.

## FLOWERS, FRUITS, AND LEAVES. By Sir JOHN

LUBBOCK, M.P., F.R.S. Illustrated. 4s. 6d.

## HOW TO DRAW A STRAIGHT LINE: A LECTURE ON

LINKAGES. By A. B. KEMPE, B.A. Illustrated. 1s. 6d.

## LIGHT: A SERIES OF SIMPLE, ENTERTAINING, AND

USEFUL EXPERIMENTS. By A. M. MAYER and C. BARNARD.  
Illustrated. 2s. 6d.

## SOUND: A SERIES OF SIMPLE, ENTERTAINING,

AND INEXPENSIVE EXPERIMENTS. By A. M. MAYER. 3s. 6d.

## SEEING AND THINKING. By Prof. W. K. CLIFFORD,

F.R.S. Diagrams. 3s. 6d.

## CHARLES DARWIN. Memorial Notices reprinted from

*Nature*. By THOMAS H. HUXLEY, F.R.S., G. J. ROMANES, F.R.S.,  
Sir ARCHIBALD GEIKIE, F.R.S., and W. T. DYER, F.R.S. 2s. 6d.

## ON THE COLOURS OF FLOWERS. By GRANT ALLEN.

Illustrated. 3s. 6d.

## THE CHEMISTRY OF THE SECONDARY BATTERIES.

OF PLANTÉ AND FAURE. By J. H. GLADSTONE and A. TRIBE.  
2s. 6d.

## A CENTURY OF ELECTRICITY. By T. C. MENDENHALL.

4s. 6d.

## ON LIGHT. The Burnett Lectures. By Sir GEORGE

GABRIEL STOKES, M.P., F.R.S. Three Courses: I. On the Nature of  
Light. II. On Light as a Means of Investigation. III. On Beneficial Effects  
of Light. 7s. 6d.

## THE SCIENTIFIC EVIDENCES OF ORGANIC EVOLU-

TION. By GEORGE J. ROMANES, M.A., LL.D. 2s. 6d.

## POPULAR LECTURES AND ADDRESSES. By Sir

WILLIAM THOMSON. In 3 vols. Vol. I. Constitution of Matter. Illustrated.  
7s. 6d. Vol. III. Papers on Navigation. 7s. 6d.

## THE CHEMISTRY OF PHOTOGRAPHY. By Prof. R.

MELDOLA, F.R.S. Illustrated. 6s.

## MODERN VIEWS OF ELECTRICITY. By Prof. O. J.

LODGE, LL.D. Illustrated. 6s. 6d.

MACMILLAN AND CO., LONDON.

## NATURE SERIES—Continued.

**TIMBER AND SOME OF ITS DISEASES.** By Prof. H. M. WARD, M.A. Illustrated. 6s.

**ARE THE EFFECTS OF USE AND DISUSE INHERITED?** An Examination of the View held by Spencer and Darwin. By W. PLATT BALL. 3s. 6d.

**THE RIGHTHAND - LEFTHANDEDNESS.** By Sir D. WILSON. Illustrated. 4s. 6d.

**ON COLOUR BLINDNESS.** By T. H. BICKERTON. Illustrated. [In the Press.]

EVERY THURSDAY AFTERNOON, Price 6d.

(A Specimen Number, post free, 6½d. stamps.)

## NATURE:

A Weekly Illustrated Journal of Science.

NATURE contains Original Articles on all subjects coming within the domain of Science, contributed by the most eminent Scientists, belonging to all parts of the world.

Reviews, setting forth the nature and value of recent Scientific works, are written for NATURE by men who are acknowledged masters in their particular departments.

The Correspondence columns of NATURE, while forming a medium of Scientific discussion and of intercommunication among the most distinguished men of Science, have become the recognized organ for announcing new discoveries and new illustrations of Scientific principles among observers of Nature all the world over—from Japan to San Francisco, from New Zealand to Iceland.

The Serial columns of NATURE contain the gist of the most important Papers that appear in the numerous Scientific Journals which are now published at home and abroad, in various languages; while longer Abstracts are given of the more valuable Papers which appear in foreign Journals.

The Principal Scientific Societies and Academies of the world, British and foreign, have their transactions regularly recorded in NATURE, the Editor being in correspondence, for this purpose, with representatives of Societies in all parts of the world.

Notes from the most trustworthy sources appear each week recording the latest gossip of the Scientific world at home and abroad.

As questions of Science compass all limits of nationality, and are of universal interest, a periodical devoted to them may fitly appeal to the intelligent classes in all countries where its language is read. The proprietors of NATURE aim so to conduct it that it shall have a common claim upon all English-speaking peoples. Its articles are brief and condensed, and are thus suited to the circumstances of an active and busy people who have little time to read extended and elaborate treatises.

### Subscriptions to "Nature":

Yearly ... .. 28s. | Half-Yearly ... .. 14s. 6d.  
Quarterly ... .. 7s. 6d.

*To the Colonies, United States, the Continent, and all places within the Postal Union.*

Yearly ... .. 30s. 6d. | Half-Yearly ... .. 15s. 6d.  
Quarterly ... .. 8s.

P.O.O. to be made payable to MACMILLAN AND CO.,

OFFICE: 29 BEDFORD STREET, STRAND.







