



THE UNIVERSITY
OF ILLINOIS

LIBRARY

581.942

L92a2

v. 2

CPLA

JAN 30



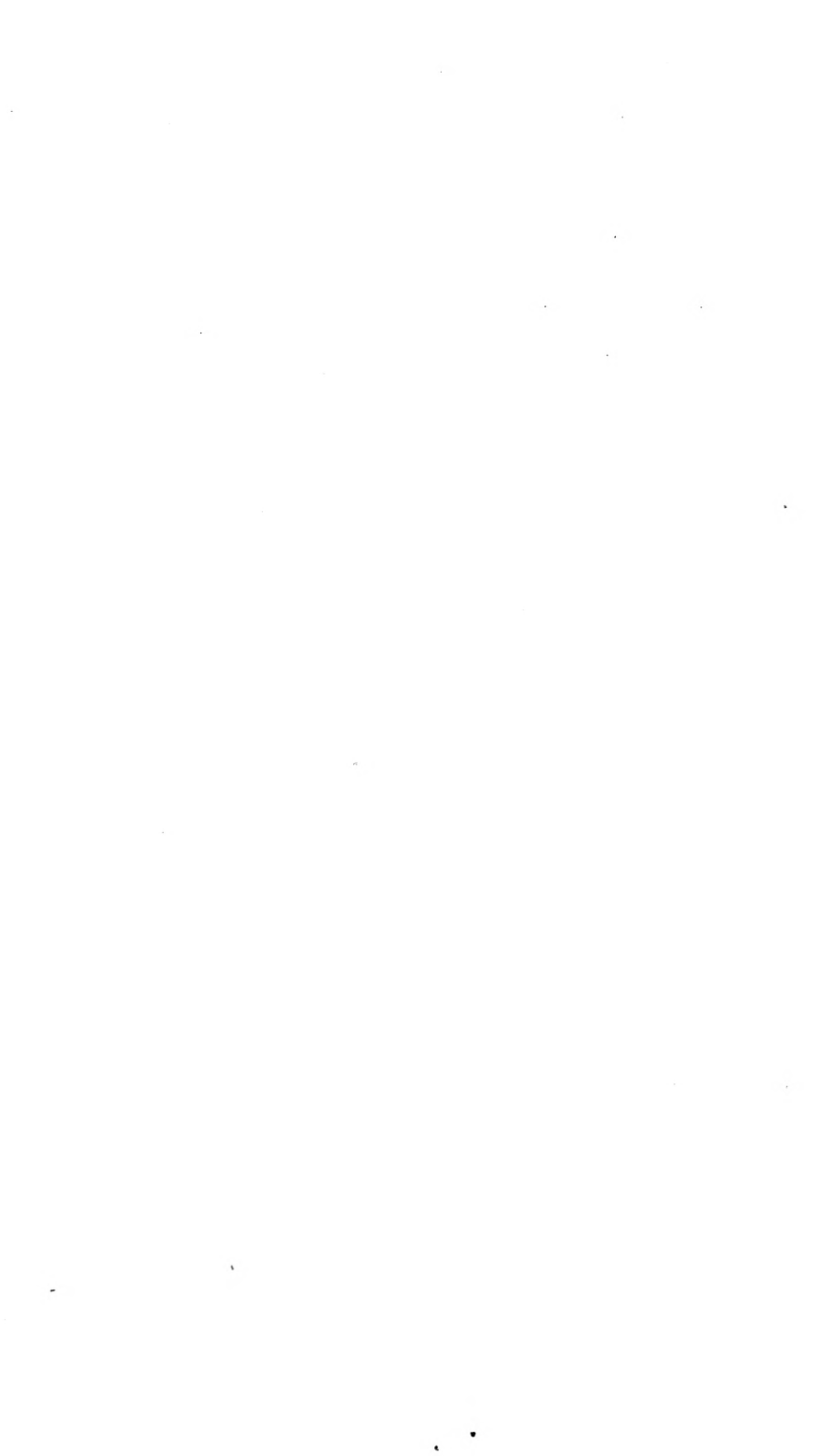

ARBORETUM ET FRUTICETUM BRITANNICUM;

OR,

THE TREES AND SHRUBS OF BRITAIN,

Native and Foreign, Hardy and Half-Hardy,

PICTORIALLY AND BOTANICALLY DELINEATED,
AND SCIENTIFICALLY AND POPULARLY DESCRIBED;

WITH

THEIR PROPAGATION, CULTURE, MANAGEMENT,

AND USES IN THE ARTS, IN USEFUL AND ORNAMENTAL PLANTATIONS, AND IN

LANDSCAPE-GARDENING;

PRECEDED BY A HISTORICAL AND GEOGRAPHICAL OUTLINE
OF THE TREES AND SHRUBS OF TEMPERATE CLIMATES
THROUGHOUT THE WORLD.

BY J. C. LOUDON, F.L. & H.S. &c.

AUTHOR OF THE ENCYCLOPEDIAS OF GARDENING AND OF AGRICULTURE.

IN EIGHT VOLUMES:

FOUR OF LETTERPRESS, ILLUSTRATED BY ABOVE 2500 ENGRAVINGS;
AND FOUR OF OCTAVO AND QUARTO PLATES.

VOL. II.

FROM CELASTRACEÆ, P. 495., TO APOCYNACEÆ, P. 1256., INCLUSIVE.

SECOND EDITION.

LONDON:

HENRY G. BOHN, YORK STREET, COVENT GARDEN.

1854.



581.942
L 32a 2
v. 2

CONTENTS OF VOL. II.

The Roman numerals refer to the General Table of Contents, Vol. I. p. xvii. to cliii., where the species and varieties, with all their synonyms, will be found systematically arranged; the first column of Arabic figures to the pages of the text in this volume, and the second to those of the supplementary matter contained in Vol. IV.

The names of the half-hardy and suffruticose orders and genera are in small type.

	I.	II.	IV.		I.	II.	IV.
<i>Celastræacæ.</i>	xxxiv.	495	2541	<i>Anacardiæacæ.</i>	xxxix.	545	2548
<i>Euonymus</i> -	xxxiv.	496	2545	<i>Pistæcia L.</i> -	xxxix.	545	2548
<i>Spindle Tree.</i>				<i>Pistacia Nut Tree.</i>			
<i>Celastrus L.</i> -	xxxv.	502	2545	<i>Mastic Tree.</i>			
<i>Staff Tree.</i>				<i>Turpentine Tree.</i>			
<i>Nemopanthes Raf.</i>	xxxv.	503	2545	<i>Rhus</i> -	xxxix.	548	2548
<i>Mâytenus Feuill.</i>	xxxv.	503		<i>Sumach.</i>			
<i>Cassine L.</i> -	xxxv.	503		<i>Duvaia Kunth</i> -	xl.	558	2549
<i>Hartógia Dec.</i>	xxxv.	504		<i>Salix Wall.</i> -	xl.	560	
				<i>Schinus L.</i> -	xl.	560	
				<i>Triceros</i> -	xl.	560	
				<i>Heterodendron Desf.</i>	xl.	560	
				<i>Styloplasium Desf.</i>	xl.	560	
				<i>Cneorum L.</i> -	xl.	560	
<i>Aquifoliæacæ.</i>	xxxvi.	505	2545	<i>Burseræacæ.</i>	xl.	561	
<i>Myginda Jacq.</i>	xxxvi.	505		<i>Balsamedendron</i> -	xl.	561	
<i>Ulex L.</i> -	xxxvi.	505	2545	<i>Canarium König</i> -	xl.	561	
<i>Holly.</i>				<i>Fagastrium G. Don</i> -	xl.	561	
<i>Prinos L.</i> -	xxxvi.	520	2546	<i>Amyridæacæ.</i>	xl.	561	
<i>Winter Berry.</i>				<i>Amyris Willd.</i> -	xl.	561	
<i>Rhamnæacæ.</i>	xxxvii.	523	2546	<i>Leguminæacæ.</i>	xl.	561	2549
<i>Zizyphus</i> -	xxxvii.	524	2546	§ 1. <i>Sorno'BLEÆ.</i> -	xl.	563	2549
<i>Jujube Tree.</i>				<i>Sophora R. Br.</i>	xl.	563	2549
<i>Paliurus L.</i> -	xxxvii.	527	2547	<i>Virgilia L.</i> -	xli.	565	
<i>Christ's Thorn.</i>				<i>Yellow Wood.</i>			
<i>Berchémia Neck.</i>	xxxvii.	528		<i>Piptanthus Swt.</i>	xli.	566	
<i>Supple Jack.</i>				<i>Edwardsia Sal.</i> -	xli.	567	
<i>Rhamnus Lam.</i>	xxxvii.	529	2547	<i>Cyclopia R. Br.</i>			
<i>Buckthorn.</i>				<i>Podalyria R. Br.</i> -	xli.	567	
<i>Ceanothus L.</i>	xxxviii.	539	2547	<i>Chorozema R. Br.</i> -	xli.	567	
<i>Red Root.</i>				<i>Podolobium R. Br.</i> -	xli.	567	
<i>Spheroarya Wall.</i> -	xxxix.	511		<i>Oxlobium R. Br.</i> -	xli.	567	
<i>Candalia Cav.</i> -	xxxix.	511		<i>Callistachys Sims</i> -	xli.	567	
<i>Sageretia Brongn.</i>	xxxix.	511		<i>Brachysema R. Br.</i> -	xli.	567	2549
<i>Retanilla Brongn.</i>	xxxix.	511	2548	<i>Gompholobium Sm.</i> -	xli.	567	
<i>Colletia Kunth</i>	xxxix.	511	2548	<i>Burtonia R. Br.</i> -	xli.	567	
<i>Trevoua Mey.</i> -	xxxix.	511		<i>Jacksonia R. Br.</i> -	xli.	567	
<i>Discaria Hook.</i> -	xxxix.	511		<i>Viminaria Sm.</i> -	xli.	567	
<i>Hovenia Thunb.</i>	xxxix.	511		<i>Aëtus G. Don</i> -	xli.	567	
<i>Colubraria Brongn.</i>	xxxix.	512		<i>Dillwynia Sm.</i> -	xli.	567	
<i>Willenertia Brongn.</i>	xxxix.	512		<i>Eutaxia R. Br.</i> -	xli.	567	
<i>Pomadéris Lab.</i>	xxxix.	512	2548	<i>Sclerothamnus R. Br.</i>	xli.	567	
<i>Cryptandra Sm.</i>	xxxix.	512		<i>Gastrolobium Ker.</i>	xli.	567	
<i>Barlingia Brongn.</i>	xxxix.	512		<i>Euchilus R. Br.</i> -	xli.	567	
<i>Solenanthe G. Don</i>	xxxix.	512		<i>Pultenæa B. M.</i> -	xli.	567	
<i>Trichocephalus Brongn.</i>	xxxix.	512		<i>Daviesia R. Br.</i> -	xli.	567	
<i>Phytica L.</i>	xxxix.	512		<i>Murbelia Sm.</i> -	xli.	565	
<i>Soulangia Brongn.</i>	xxxix.	512					
<i>Gonania Jacq.</i>	xxxix.	512		§ 2. <i>LÔTEÆ.</i> -	xli.	571	2549
<i>Carpodetus Forst.</i>	xxxix.	512		<i>Ulex L.</i> -	xli.	571	2549
<i>Oënia Thunb.</i>	xxxix.	512		<i>Furze.</i>			
				<i>Stauracanthus Lk.</i>	xli.	576	
<i>Bruniæacæ.</i>	xxxix.	542		<i>Spártium Dec.</i>	xli.	576	2550
<i>Homalinæacæ.</i>	xxxix.	542		<i>Spanish Broom.</i>			
<i>Aristotelia L'Hér.</i>	xxxix.	545		<i>Genista Lam.</i>	xli.	577	2550
<i>Azara R. et P.</i>	xxxix.	544		<i>Cýtisis Dec.</i>	xliii.	588	2551
<i>Blackwellia Dec.</i>	xxxix.	544		<i>Common and Portugal Broom.</i>			
<i>Astránthus Lour.</i>	xxxix.	544		<i>Laburnum.</i>			
<i>Neillia Dec.</i>	xxxix.	544					

	I.	II.	IV.		I.	II.	IV.
Adenocarpus Dec.	-	xlvi.	603	2552			
Ononis L.	-	xlvi.	604				
<i>Restharrow.</i>							
Amorpha L.	-	xlvi.	606	2552			
<i>Bastard Indigo.</i>							
Robinia L.	-	xlvi.	609	2552			
<i>Locust Tree.</i>							
<i>Rose Acacia.</i>							
Caragana Lam.	-	xlvi.	629	2552			
<i>Siberian Pea Tree.</i>							
Halimodendron Fisch.	-	xlvi.	634				
<i>Salt Tree.</i>							
Calophaca Fisch.	-	xlvi.	635				
Colutea R. Br.	-	xlvi.	635	2552			
<i>Bladder Senna.</i>							
Astragalus Dec.	-	xlvi.	637				
<i>Milk Vetch.</i>							
Dorycnium Tourn.	-	xlvii.	639				
Hovea R. Br.	-	xlvii.	639				
Plagiobium Sm.	-	xlvii.	639				
Platylobium Sm.	-	xlvii.	639				
Bossia Vent.	-	xlvii.	639	2552			
Goodia Sal.	-	xlvii.	640				
Scottia R. Br.	-	xlvii.	640				
Templetonia Sims	-	xlvii.	640				
Rafnia Thunb.	-	xlvii.	640				
Vascosa Dec.	-	xlvii.	640				
Borbonia L.	-	xlvii.	640				
Achyronia Wendl.	-	xlvii.	640				
Liparia L.	-	xlvii.	640				
Priestleya Dec.	-	xlvii.	640				
Crotalaria	-	xlvii.	640				
Hypocalyptus Thunb.	-	xlvii.	640				
Viborgia Spreng.	-	xlvii.	640				
Loddigesia Sims	-	xlvii.	641				
Dichilus Dec.	-	xlvii.	641				
Lebeckia Thunb.	-	xlvii.	641				
Sarcophyllum Thunb.	-	xlvii.	641				
Aspalathus L.	-	xlvii.	641				
Requienia Dec.	-	xlvii.	641				
Anthyllis L.	-	xlvii.	641	2552			
Medicago L.	-	xlvii.	642				
Melilotus Cast.	-	xlvii.	642				
Lotus L.	-	xlvii.	642				
Carmichaelia R. Br.	-	xlvii.	642				
Psoralea L.	-	xlvii.	642				
Indigofera L.	-	xlvii.	642				
Swainsonia Sal.	-	xlvii.	643				
Lessertia Dec.	-	xlvii.	643				
Sutherlandia R. Br.	-	xlvii.	643				
§ III. HEDYSA'LEÆ.							
Coronilla Neck.	-	xlvii.	643				
<i>Hedysarum</i>	-	xlvii.	645				
<i>Hippocrepis Jacq.</i>	-	xlvii.	645				
<i>Adesmia Dec.</i>	-	xlvii.	645				
<i>Urtica Desr.</i>	-	xlvii.	645	2552			
<i>Desmodium Dec.</i>	-	xlvii.	645				
<i>Dicerma Dec.</i>	-	xlvii.	646				
<i>Taverniera Dec.</i>	-	xlvii.	646				
<i>Lepedeza Mx.</i>	-	xlvii.	646				
<i>Flemingia Roxb.</i>	-	xlvii.	646				
<i>Ebenus L.</i>	-	xlvii.	646				
<i>Ahaji Tourn.</i>	-	xlvii.	646				
<i>Clianthus Sol.</i>	-	xlvii.	646				
§ IV. PHASEO'LEÆ.							
Wistaria Nutt.	-	xlviii.	647	2553			
<i>Tree Lupine.</i>	-	xlviii.	649				
Dolichos L.	-	xlviii.	619				
Pachyrhizus Dec.	-	xlviii.	619				
Mucuna Wall.	-	xlviii.	619				
Erythrina L.	-	xlviii.	649				
<i>Coral Tree.</i>							
§ V. CASSIÆÆ.							
Gleditschia	-	xlviii.	650	2554			
<i>Honey Locust.</i>							
Gymnocladus	-	xlviii.	656				
<i>Kentucky Coffee Tree.</i>							
Cercis L.	-	xlviii.	657				
<i>Judas Tree.</i>							
Cesalpinia Ait.	-	xlx.	660				
Cudia L'Hérit.	-	xlx.	660				
Zuccagnia Cav.	-	xlx.	660				
Ceratonia	-	xlx.	660				
Ceratopneum Cunn.	-	xlx.	660				
Cassia L.	-	xlx.	660				
<i>Chama-fistula Don's Mill.</i>	-	xlx.	660				
<i>Schotia Ait.</i>	-	xlx.	660				
App. I. Other Leguminæcæ.							
Derris G. Don	-	xlx.	661				
Pterocarpus Dec.	-	xlx.	661				
Prosopis L.	-	xlx.	661				
Lagonychium Bieb.	-	xlx.	661				
Acacia Neck.	-	xlx.	662	2554			
<i>Mimosa.</i>							
<i>Black Wattle.</i>							
Rosæcæ.							
<i>Rosa</i>	-	xlx.	670	2554			
§ I. AMYGDALÆÆ.							
Amygdalus Tourn.	-	xlx.	673	2554			
<i>The Almond.</i>							
Persica Tourn.	-	l.	679	2554			
<i>The Peach.</i>							
Armeniaca Tourn.	-	l.	681	2554			
<i>The Apricot.</i>							
Prunus Tourn.	-	l.	684	2554			
<i>The Plum.</i>							
Cerasus Juss.	-	li.	692	2555			
<i>The Cherry.</i>							
§ II. SPIRÆÆÆ.							
Purshia Dec.	-	liii.	721	2555			
Kerria Dec.	-	liii.	722	2555			
<i>Corchorus.</i>							
Spiræa L.	-	liii.	722	2556			
§ III. POTENTI'LLÆÆ.							
Rubus L.	-	liv.	733	2557			
<i>The Bramble.</i>							
Potentilla L.	-	lvi.	747	2557			
<i>The Shrubby Cinqufoil.</i>							
§ IV. RO'SEÆÆ.							
Rosa L.	-	lvi.	748	2558			
<i>The Rose Tree.</i>							
Lowea Lindl.	-	lxi.	812				
§ V. PO'MEÆÆ.							
Crataegus Lindl.	-	lxi.	813	2562			
<i>The Thorn.</i>							
Photinia Lindl.	-	lxiv.	868				
Cotoneaster Med.	-	lxv.	869	2563			
Amelanchier Med.	-	lxv.	874				
Mespilus Lindl.	-	lxv.	877				
<i>The Medlar.</i>							
Pyrus Lindl.	-	lxvi.	879	2564			
<i>The Pear Tree.</i>							
Cydonia Tourn.	-	lxviii.	929				
<i>The Quince Tree.</i>							
Raphiolepis Lindl.	-	lxix.	952				
Eriobotrya Lindl.	-	lxix.	953	2566			
Kagenéckia R. et P.	-	lxix.	954	2566			
Margincarpus R. et P.	-	lxix.	954				
Cercocarpus H. B. et K.	-	lxix.	931				
<i>Acacia Vahl</i>	-	lxix.	954				
Poterium L.	-	lxix.	955				
Cliffortia L.	-	lxix.	955				
Calycanthæcæ.							
Calycanthus Lindl.	-	lxix.	936	2566			
<i>American Allspice.</i>							
Chimonanthus Lindl.	-	lxix.	937	2566			
<i>Winter Flower.</i>							
Granatæcæ.							
Punica Tourn.	-	lxix.	939	2566			
<i>The Pomegranate Tree.</i>							

	I.	II.	IV.		I.	II.	IV.
<i>Onagræcæ.</i> -	lxxix.	942	2566	<i>Escalloniæcæ.</i> -	lxxiv.	992	2570
<i>Fuchsia L.</i> -	lxxix.	941	2566	<i>I'tea L.</i> -	lxxiv.	992	
<i>Lythracæ.</i> -	lxx.	945		<i>Escallonia Mutis</i> -	lxxiv.	993	2570
<i>Heimia</i> -	lxx.	945		<i>Saxifragæcæ.</i> -	lxxv.	994	2570
<i>Lagerstrœmia</i> -	lxx.	945		<i>Hydrangea L.</i> -	lxxv.	994	2570
<i>Pride of India.</i>				<i>Umbellæcæ.</i> -	lxxv.	997	2570
<i>Tamaricæcæ.</i> -	lxx.	946		<i>Bupleurum Tourn.</i> -	lxxv.	997	2570
<i>Tamarix Desv.</i> -	lxx.	947		<i>Hare's Ear.</i>			
<i>The Tamarisk.</i>				<i>Tendria Spreng.</i>			
<i>Myricaria Desv.</i> -	lxx.	949		<i>Araliæcæ.</i> -	lxxv.	998	
<i>German Tamarisk.</i>				<i>Aralia L.</i> -	lxxv.	998	
<i>Philadelphæcæ.</i> -	lxx.	950	2567	<i>Anglica Tree.</i>			
<i>Philadelphus L.</i> -	lxx.	951	2567	<i>Hedera Swartz</i> -	lxxv.	999	2570
<i>Mock Orange.</i>				<i>The Ivy.</i>			
<i>Decumãria L.</i> -	lxxi.	955		<i>Hamamelidæcæ.</i> -	lxxv.	1006	2570
<i>Deutzia Thunb.</i> -	lxxi.	956	2567	<i>Hamamelis</i> -	lxxv.	1007	2570
<i>Myrtæcæ.</i> -	lxxi.	956	2567	<i>Wych Hazel.</i>			
§ I. MELALEUCÆCÆ. lxxi. 956				<i>Fothergilla L.</i> -	lxxvi.	1008	
<i>Tristania R. Br.</i> -	lxxi.	956		<i>Cornæcæ.</i> -	lxxvi.	1009	2571
<i>Beaufortia R. Br.</i> -	lxxi.	957		<i>Cornus</i> -	lxxvi.	1009	2571
<i>Calothamnus R. Br.</i> -	lxxi.	957		<i>The Dogwood.</i>			
<i>Melaleuca Lab.</i> -	lxxi.	957		<i>Benthamia Lindl.</i> -	lxxvii.	1019	
<i>Eudesmia R. Br.</i> -	lxxi.	958		<i>Loranthæcæ.</i> -	lxxvii.	1020	2571
§ II. EULEPTOSPÉRMEÆ. lxxi. 958				<i>Víscum L.</i> -	lxxvii.	1021	2571
<i>Eucalyptus Sm.</i> -	lxxi.	958	2567	<i>Mistletoe.</i>			
<i>Angophora Cav.</i> -	lxxi.	960		<i>Aúca Thunb.</i> -	lxxvii.	1026	2571
<i>Callistemon Dec.</i> -	lxxi.	960		<i>Japan Laurel.</i>			
<i>Metrosideros Vent.</i> -	lxxi.	961		<i>Caprifoliæcæ.</i> -	lxxvii.	1026	2572
<i>Leptospermum Sm.</i> -	lxxi.	961	2567	§ I. SAMBUCEÆ. lxxvii. 1027			
<i>Bilbottia H. Br.</i> -	lxxi.	961		<i>Sambucus L.</i> -	lxxvii.	1027	2572
<i>Fabricia Guern.</i> -	lxxi.	961		<i>The Elder.</i>			
<i>Bæ'ckia Andr.</i> -	lxxi.	961		<i>Viburnum</i> -	lxxvii.	1032	2572
§ III. MYRTEÆ. lxxi. 961				<i>Tinus Tourn.</i>			
<i>Psidium Sab.</i> -	lxxi.	961		<i>O'pulus Tourn.</i>			
<i>Myrtus L.</i> -	lxxi.	961	2568	<i>The Laurustinus.</i>			
<i>The Myrtle.</i>				<i>The Wayfaring Tree.</i>			
§ IV. CHAMELAUCIÆ. lxxii. 964				<i>The Guelder Rose.</i>			
<i>Chamelaucium Desf.</i> -	lxxii.	964		<i>Diervilla Tourn.</i> -	lxxix.	1042	
<i>Calythrix R. Br.</i> -	lxxii.	964		<i>Lonicera Desf.</i> -	lxxix.	1042	2572
<i>Darwinia Rudge</i> -	lxxii.	964		<i>Honeysuckle.</i>			
<i>Passifloræcæ.</i> -	lxxii.	964		<i>Symphoricarpos Dill.</i> -	lxxx.	1058	2572
<i>Passiflora L.</i> -	lxxii.	964		<i>St. Peter's Wort.</i>			
<i>Discema Dec.</i> -	lxxii.	965		<i>The Snowberry Tree.</i>			
<i>Tasconia Juss.</i> -	lxxii.	965		<i>Leycesteria Wall.</i> -	lxxx.	1060	
<i>Crassulæcæ.</i> -	lxxii.	965	2568	<i>Rubiæcæ.</i> -	lxxx.	1061	2573
<i>Sedum L.</i> -	lxxii.	965	2568	<i>Cephalanthus L.</i> -	lxxx.	1061	2573
<i>The Stonecrop.</i>				<i>The Button Wood.</i>			
<i>Sempervivum L.</i> -	lxxii.	965		<i>Pinckney Mx.</i> -	lxxx.	1062	
<i>The Tree Houelleck.</i>				<i>Serissa Comm.</i> -	lxxx.	1062	
<i>Mesembryæcæ.</i> -	lxxii.	966		<i>Plocama Ait.</i> -	lxxx.	1062	
<i>Mesembryanthemum L.</i> -	lxxii.	966		<i>Phyllis L.</i> -	lxxx.	1062	
<i>Fig Marigold.</i>				<i>Anthospermum L.</i> -	lxxx.	1062	
<i>Nitrariæcæ.</i> -	lxxii.	968		<i>Rubia Ait.</i> -	lxxx.	1062	
<i>Nitraria L.</i> -	lxxii.	968		<i>Bouvardia H. B. et K.</i> -	lxxx.	1062	
<i>Cactæcæ.</i> -	lxxii.	967	2569	<i>Manettia Cham. et Schl.</i> -	lxxx.	1062	
<i>Opuntia Mill.</i> -	lxxii.	967	2569				
<i>The Prickly Pear.</i>							
<i>Grossulæcæ.</i> -	lxxii.	967	2569				
<i>Ribes L.</i> -	lxxii.	968	2569				
<i>The Gooseberry.</i>							
<i>The Currant.</i>							

	I.	II.	IV.		I.	II.	IV.
<i>Lobeliaceæ.</i>	- lxxxii.	1063		<i>Blæria</i>	-	lxxxv.	1091
<i>Tupa</i> G. Don	-	lxxxii.		<i>E'tetasis</i>	-	lxxxv.	1092
<i>Lobelia</i> Forst.	-	lxxxii.		<i>Eurystégia</i>	-	lxxxv.	1093
<i>Campanulaceæ.</i>	lxxxii.	1063		<i>Lophándra</i>	-	lxxxv.	1093
<i>Müsschia</i> Dumort.	-	lxxxii.		<i>Lámprotis</i>	-	lxxxv.	1093
<i>Campanula.</i>				<i>Andrómeda</i>	-	lxxxv.	1105 2574
<i>Compósitæ.</i>	- lxxxii.	1063	2573	<i>Cassiöpe D. Don</i>	-	lxxxvi.	1107 2574
<i>Stæhëlina</i> Lessing	-	lxxxii.		<i>Cassándra D. Don</i>	-	lxxxvi.	1108
<i>Bácharis R. Br.</i>	-	lxxxii.		<i>Zenóbia D. Don</i>	-	lxxxvi.	1108
<i>Ploughman's Spikenard.</i>				<i>Lyónia</i> Nutt.	-	lxxxvi.	1109 2574
<i>I'ra</i> L.	-	lxxxii.		<i>Leucóthöe D. Don</i>	-	lxxxvi.	1113
<i>Santolina</i>	-	lxxxii.		<i>Pieris D. Don</i>	-	lxxxvii.	1114
<i>Lavender Cotton.</i>				<i>Phyllódoce</i> Sal.	-	lxxxvii.	1115
<i>Artemisia</i> Cass.	-	lxxxii.	2573	<i>Dabæ'cia D. Don</i>	-	lxxxvii.	1116
<i>Southernwood.</i>				<i>Arbutus Cam.</i>	-	lxxxvii.	1117 2575
<i>Helichrysum</i> Lessing	lxxxii.	1070		<i>The Strawberry Tree.</i>			
<i>Everlasting Flower.</i>				<i>Arctostáphylos</i>	}	lxxxviii.	1123 2575
<i>Cineraria</i> Less.	-	lxxxii.	1071	<i>Adans.</i>			
<i>Carlowitzia</i> Moench	-	lxxxii.	1072	<i>The Bearberry.</i>			
<i>Arctótis</i> L.	-	lxxxii.	1072	<i>Pernéttya</i> Gaud.	-	lxxxviii.	1124 2575
<i>Didéla H. K.</i>	-	lxxxii.	1073	<i>Gaulthéria</i> L.	-	lxxxviii.	1125 2575
<i>Berckhèya</i> W.	-	lxxxii.	1072	<i>Epigæ'a</i> L.	-	lxxxviii.	1126 2575
<i>Callunia</i> R. Br.	-	lxxxii.	1072	<i>Phaleroeárpus G. Don</i>	-	lxxxviii.	1127
<i>Obótia</i> Bot. Cab.	-	lxxxii.	1072	<i>Cléthra</i> L.	-	lxxxviii.	1127
<i>Osteospermum</i> L.	-	lxxxii.	1072	<i>Agarista G. Don</i>	-	lxxxviii.	1129
<i>Caléndula</i> Ven.	-	lxxxii.	1072				
<i>Mutisia</i> D. Don	-	lxxxii.	1072	§ II. RHODO'REÆ.	lxxxix.	1129	
<i>Déliia</i> Cav.	-	lxxxii.	1073	<i>Rhododéndron</i> L.	-	lxxxix.	1130 2576
<i>A'ladánthus G. Don</i>	-	lxxxii.	1073	<i>Azálea</i> L.			
<i>Sónchus</i> Jacq.	-	lxxxii.	1073	<i>Rhodóra</i> L.			
<i>Vernónia</i> Hook.	-	lxxxii.	1073	<i>Kálmia</i> L.	-	xcii.	1151 2576
<i>Aster</i> Lab.	-	lxxxii.	1073	<i>American Laurel.</i>			
<i>Chrysócoma</i> L.	-	lxxxii.	1073	<i>Menzièsa</i> Sm.	-	xcii.	1152 2576
<i>Brachyla'na</i> Svt.	-	lxxxii.	1073	<i>Azálea D. Don</i>	-	xcii.	1153 2576
<i>Conyza</i> Jacq.	-	lxxxii.	1073	<i>Leiophýllum</i> Pers.	-	xcii.	1154
<i>Podánthus</i> Lindl.	-	lxxxii.	1075	<i>Lédum</i> L.	-	xcii.	1155 2576
<i>Culcitlum</i> Spr.	-	lxxxii.	1071				
<i>Cacúia</i> L.	-	lxxxii.	1074	§ III. VACCINIE'Æ.	xcii.	1156	
<i>Französa</i> W.	-	lxxxii.	1074	<i>Vaccínium</i> L.	-	xcii.	1156 2576
<i>E'dera</i> Thunb.	-	lxxxii.	1074	<i>Whortleberry.</i>			
<i>Pyréthrum</i> W. En.	-	lxxxii.	1074	<i>Biberry.</i>			
<i>Ismida</i>	-	lxxxii.	1074	<i>Oxyeóceus</i> Pers.	-	xciii.	1168 2577
<i>Athanásia</i> L.	-	lxxxii.	1074	<i>Cranberry.</i>			
<i>Balsamita</i> Desf.	-	lxxxii.	1074	<i>Bryánthus</i> Gmel.	-	xciv.	1171
<i>Piéntia</i> W.	-	lxxxii.	1074	<i>Enkánthus</i> Lour.	-	xciv.	1172
<i>Eriocéphalus</i> L.	-	lxxxii.	1074	<i>Vireya</i>	-	xciv.	1173
<i>Senécio</i> B. M.	-	lxxxii.	1074	<i>Befara</i> H. et B.	-	xciv.	1175
<i>Tarchonánthus</i> Lam.	-	lxxxii.	1074	<i>Hymenánthes</i> Blum.	-	xciv.	1175
<i>Eriócoma</i> D. Don	-	lxxxii.	1074	<i>Gaylussacia</i> H. B. et K.	-	xciv.	1175
				<i>Thibándia</i> H. B. et K.	-	xciv.	1173
				<i>Cavendishia</i> Lindl.	-	xciv.	1173
				<i>Agapetes</i> D. Don	-	xciv.	1173
				<i>Ceratostema</i> R. et P.	-	xciv.	1175
<i>Epacridaceæ.</i>	- lxxxiii.	1075	2573	<i>Symplocaceæ.</i>	-	xciv.	1186
<i>Styphélia</i> R.	-	lxxxiii.	1075	<i>Symplocos</i> Ker	-	xciv.	1186
<i>Stenánthera</i> R. Br.	-	lxxxiii.	1075				
<i>Cyathódes</i> Lab.	-	lxxxiii.	1075	<i>Styraceæ.</i>	xcix.	1187	
<i>Lissánthe</i> R. Br.	-	lxxxiii.	1075	<i>Stýrax</i> L.	-	xciv.	1187
<i>Leucopógon</i> B. Br.	-	lxxxiii.	1075	<i>Storax.</i>			
<i>Monótoea</i> R. Br.	-	lxxxiii.	1075				
<i>Trochocárypa</i> R. B.	-	lxxxiii.	1075	<i>Halesiaceæ.</i>	-	xciv.	1189
<i>E'pacris</i> Sm.	-	lxxxiii.	1075	<i>Halèsia</i> Ellis	-	xciv.	1189
<i>Lysinema</i> R. Br.	-	lxxxiii.	1075	<i>The Snowdrop Tree.</i>			
<i>Andersónia</i> R. Br.	-	lxxxiii.	1075				
<i>Sprengélia</i> Bot. Cat.	-	lxxxiii.	1075	<i>Sapotaceæ.</i>	-	xciv.	1191 2578
<i>Sphenótoma</i> Svt.	-	lxxxiii.	1075	<i>Argánia</i> R. et S.	-	xciv.	1192
				<i>Sideróxylon.</i>			
				<i>Bumélia</i> Swartz	-	xcv.	1192 2578

	I.	II.	IV.		I.	II.	IV.
<i>Ebenàcœ.</i> -	xcv.	1194	2578	<i>Fontanèsia</i> Lab. -	xcvii.	1213	
<i>Diospÿros</i> -	xcv.	1194	2578	<i>Forsÿthia</i> Vahl -	xcvii.	1213	
<i>Date Plum.</i>				§ III. <i>FRAXINIE`E.</i>	xcvii.	1213	
<i>Oleàcœ.</i>	xcv.	1197	2578	<i>Fráxinus</i> L. -	xcvii.	1213	2579
§ I. <i>OLE`INÆ.</i> -	xcv.	1198		<i>The Ash Tree.</i>			
<i>Ligústrum Tourn.</i> -	xcv.	1198	2578	<i>O`rnus Pers.</i> -	xcviii.	1241	
<i>Privet.</i>				<i>The Flowering Ash.</i>			
<i>Phillyrea Tourn.</i> -	xcv.	1203	2579	<i>Jasminàcœ.</i> -	xcix.	1248	2581
<i>Chionánthus L.</i> -	xcvi.	1205		<i>Jasminum Forsk.</i> -	xcix.	1248	2581
<i>Snow Flower, or Fringe Tree.</i>				<i>The Jasmine.</i>			
<i>Olea L.</i>	xcvi.	1207	2579	<i>Apocÿnàcœ.</i> -	xcix.	1254	2581
<i>Olive.</i>				<i>Vinea L.</i> -	xcix.	1254	2581
§ II. <i>SYR`INOBEÆ.</i>	xcvi.	1208		<i>The Periwinkle.</i>			
<i>Syringa L.</i> -	xcvi.	1208	2579	<i>Gelsómium Mx.</i> -	xcix.	1256	
<i>The Lilac.</i>				<i>Nerium L.</i> -	xcix.	1256	
				<i>Oleander.</i>			

ALPHABETICAL INDEX TO VOL. II.

	I.	II.	IV.		I.	II.	IV.
<i>Acacia Neck.</i> -	xliv.	662	2554	<i>Ash Tree</i> -	xcvii.	1213	2579
<i>Acacia, False</i>	xliv.	609	2552	<i>Aspálarhus L.</i> -	xlxii.	611	
<i>Acacia Vahl</i> -	lxix.	951		<i>Aster Lab.</i> -	lxxxii.	1075	
<i>Achyronia Wendl.</i> -	xlvii.	640		<i>Astrágalus Dec.</i> -	xlvi.	657	
<i>Adenocárpus Dec.</i> -	xliv.	603	2552	<i>Astránthus Lour.</i>	xxxix.	544	
<i>Adesmia Dec.</i>	xlviij.	645		<i>Atalánthus G. Don</i>	lxxxii.	1075	
<i>Agapetes D. Don</i>	xciv.	1175		<i>Athanásia L.</i> -	lxxxii.	1074	
<i>Agarista G. Don</i>	lxxxviii.	1129		<i>A`cuba Thunb.</i>	lxxxvii.	1026	2571
<i>Almond</i> -	xliv.	673	2554	<i>Azara R et P.</i>	xxxix.	544	
<i>Althagi Tourn.</i> -	xlviij.	646		<i>Azalea D. Don</i>	xcii.	1153	2576
<i>Amelánchier Med.</i>	lxv.	874		<i>Azalea L.</i> -	lxxxix.	1140	
<i>American Allspice</i>	lxix.	936	2566	<i>Bácecharis R. Br.</i>	lxxxii.	1065	
<i>American Laurel</i> -	xcii.	1151	2576	<i>Bac`kia Andr.</i> -	lxxi.	961	
<i>Amórpha L.</i> -	xliv.	606	2552	<i>Balsamita Desf.</i> -	lxxxii.	1071	
<i>Amygdàle</i> -	xliv.	673	2554	<i>Balsamodendron</i>	xl.	561	
<i>Amygdalus Tourn.</i> -	xliv.	673	2554	<i>Bartlingia Brongn.</i>	xxxix.	542	
<i>Andersonia R. Br.</i>	lxxxiii.	1075		<i>Bastard Indigo</i> -	xliv.	606	
<i>Andrómeda L.</i> -	lxxxv.	1105	2574	<i>Bearberry</i> -	lxxxviii.	1123	2575
<i>Angelica Tree</i>	lxxv.	998		<i>Beaufórtia R. Br.</i>	lxxi.	957	
<i>Angophora Cav.</i>	lxxi.	960		<i>Becharia H. et B.</i> -	xciv.	1175	
<i>Anthospermum L.</i>	lxxi.	1062		<i>Benthámia Lindl.</i>	lxxxvii.	1019	
<i>Anthyllis L.</i> -	xlviij.	641	2552	<i>Berchémia Neck.</i>	xxxvii.	528	
<i>Amyridàcœ</i> -	xl.	561		<i>Berkhèya W.</i> -	lxxxii.	1072	
<i>Amyris Willd.</i>	xl.	561		<i>Bilberry</i> -	xcii.	1156	2576
<i>Anacardiàcœ</i>	xxxix.	545	2548	<i>Billótia R. Br.</i>	lxxi.	961	
<i>Aótus G. Don</i>	xli.	567		<i>Blackwèllia Dec.</i>	xl.	544	
<i>Apocÿnàcœ</i> -	xcix.	1254	2581	<i>Bladder Senna</i>	xlvi.	635	2552
<i>Apricot</i> -	l.	681	2554	<i>Blæ`ria</i> -	lxxxv.	1091	
<i>Aquifoliàcœ</i>	xxxvi.	505	2545	<i>Borbónia L.</i> -	xlviij.	640	
<i>Aralia L.</i> -	lxxv.	998		<i>Bossia`a Vent.</i> -	xlviij.	640	
<i>Araliàcœ</i> -	lxxv.	998		<i>Bouvardia H. B. et K.</i>	lxxxv.	1062	
<i>A`rbutus Cam.</i>	lxxxvii.	1117	2575	<i>Brachylob`na Smt.</i>	lxxxii.	1075	
<i>Arctostáphylos</i> }				<i>Brachysemá R. Br.</i>	li.	567	2549
<i>Adans.</i> - }	lxxxviii.	1123	2575	<i>Bramble</i> -	liv.	733	2557
<i>Arctótis L.</i> -	lxxxii.	1072		<i>Broom, common</i>	xlviij.	595	2550
<i>Arginia R. et S.</i>	xciv.	1192		<i>Bruniàcœ</i>	xxxix.	542	
<i>Aristotèlia L'Hérit.</i>	xxxix.	543		<i>Bryánthus Gmel.</i> -	xciv.	1171	
<i>Armeniàca Tourn.</i> -	l.	681	2554	<i>Buckthorn</i> -	xxxvii.	529	
<i>Artemisia Cass.</i> -	lxxxii.	1068	2573	<i>Bumèlia Swartz.</i> -	xcv.	1192	2578
				<i>Bupleúrum Tourn.</i> -	lxxv.	997	2570
				<i>Bursàcœ</i>	xl.	561	
				<i>Burtonia R. Br.</i> -	xli.	567	
				<i>Button-wood</i>	lxxxv.	1061	2573
				<i>Cacàlia L.</i> -	lxxxii.	1071	

	I.	II.	IV.		I.	II.	IV.
<i>Caetacea</i> -	lxix.	967	1569	<i>Decumaria L.</i> -	lxx.	955	
<i>Cadia L'Hérit.</i> -	xliv.	660		<i>Déris G. Don</i> -	xliv.	661	
<i>Cæsalpinea Ait.</i> -	xliv.	660		<i>Désmia</i> -	lxxxiv.	1089	
<i>Calendula Ven.</i> -	lxxxiii.	1072		<i>Desmодиум Dec.</i> -	xlvi.	645	2552
<i>Callista</i> -	lxxxiv.	1089		<i>Deutzia Thunb.</i> -	lxxi.	956	2567
<i>Callistemon Dec.</i> -	lxxi.	960		<i>Diœrma Dec.</i> -	xlvi.	646	
<i>Calluna Sal.</i> -	lxxxiii.	1084	2574	<i>Dichilus Dec.</i> -	xlvi.	641	
<i>Calophaca Fisch.</i> -	xlvi.	635		<i>Dicelta H. K.</i> -	lxxxii.	1072	
<i>Callistachys Sims</i> -	xli.	567		<i>Diervilla Tourn.</i> -	lxxxix.	1042	
<i>Calothamnus R. Br.</i> -	lxxi.	957		<i>Dillwynia Sm.</i> -	xli.	567	
<i>Calycanthea</i> -	lxix.	935		<i>Diospyros</i> -	xcv.	1194	2578
<i>Calycanthus Lindl.</i> -	lxix.	936	2566	<i>Discaria Hook.</i> -	xxxix.	541	
<i>Calythrix R. Br.</i> -	lxxxii.	964		<i>Disœmma Dec.</i> -	lxxii.	965	
<i>Campanulæca</i> -	lxxxii.	1065		<i>Dogwood</i> -	lxxvi.	1009	2571
<i>Campanula</i> -	lxxxii.	1063		<i>Dolichos L.</i> -	xlviij.	649	
<i>Canarium Kœnig</i> -	xl.	561		<i>Dorœniump Tourn.</i> -	xlviij.	639	
<i>Caprifoliæca</i> -	lxxxvii.	1026	2572	<i>Duvaâa Kunth</i> -	xl.	558	2549
<i>Caragana Lam.</i> -	xlv.	629	2552	<i>Ebenæca</i> -	xcv.	1194	2578
<i>Carlowizia Mench</i> -	lxxxii.	1072		<i>E'benus L.</i> -	xlviij.	646	
<i>Carmichaelia R. Br.</i> -	xlvi.	642		<i>E'ctasis</i> -	lxxxv.	1092	
<i>Carpodetus Forst.</i> -	xxxix.	542		<i>Edwardsia Sal.</i> -	xli.	567	
<i>Cassandra D. Don</i> -	lxxxvi.	1108		<i>Elder</i> -	lxxxvii.	1027	2572
<i>Cassia L.</i> -	xliv.	660		<i>Enkiánthus Lour.</i> -	xciij.	1172	
<i>Cassine L.</i> -	xxxv.	503		<i>E'paciis Sm.</i> -	lxxxiiij.	1075	
<i>Cassiope D. Don</i> -	lxxxvi.	1107	2574	<i>E'pœriðæca</i> -	lxxxiiij.	1075	2575
<i>Cavendishia Lmdl.</i> -	xlvi.	1175		<i>Épigæa L.</i> -	lxxxviii.	1126	2575
<i>Ceanothus L.</i> -	xxxviii.	539	2547	<i>Erica D. Don</i> -	lxxxiii.	1079	2574
<i>Celastræca</i> -	xxxiv.	495	2545	<i>Ericæca</i> -	lxxxiii.	1076	2574
<i>Celâstrus L.</i> -	xxxv.	502	2525	<i>Ericæca</i> -	lxxxiii.	1076	
<i>Cephalánthus L.</i> -	lxxxii.	1061	2573	<i>Eriobotrya Lindl.</i> -	lxix.	935	2566
<i>Cerâmia</i> -	lxxxiv.	1089		<i>Eriocéphalus L.</i> -	lxxxiiij.	1074	2575
<i>Cérâsus Juss.</i> -	li.	692	2555	<i>Eriocoma D. Don</i> -	lxxxiiij.	1074	
<i>Ceratostema R. et P.</i> -	xciij.	1173		<i>Erythra L.</i> -	xlviij.	649	
<i>Ceratonia L.</i> -	xliv.	660		<i>Escallonia Mutis</i> -	lxxiv.	993	2570
<i>Ceratospérum Cunn.</i> -	xliv.	660		<i>Escalloniæca</i> -	lxxiv.	992	2570
<i>Cércis L.</i> -	xlviij.	657		<i>Euchlus R. Br.</i> -	xli.	567	
<i>Cercocarpus H. B. et K.</i> -	lxix.	954		<i>Eudesia R. Br.</i> -	lxxi.	958	
<i>Chamaefistula Don's Mill.</i> -	xliv.	660		<i>Eucalyptus Sm.</i> -	lxxiiij.	958	2567
<i>Cherry</i> -	li.	692	2555	<i>Eulepyspermea</i> -	lxxii.	958	
<i>Compositæ</i> -	lxxxii.	1063	2578	<i>Euonymus L.</i> -	xxxv.	496	2545
<i>Conyza Jacq.</i> -	lxxxii.	1075		<i>Eurylepis</i> -	lxxxiv.	1090	
<i>Córchorus</i> -	liij.	722	2555	<i>Eurystegia</i> -	lxxxv.	1093	
<i>Cornæca</i> -	lxxxv.	1009	2571	<i>Eutaxia R. Br.</i> -	xli.	561	
<i>Córnus</i> -	lxxvi.	1009	2571	<i>Everlasting Flower</i> -	lxxxii.	1070	
<i>Coronilla Neck.</i> -	xlviij.	643		<i>Fabricia Gaertn.</i> -	lxxi.	961	
<i>Cotonæster Med.</i> -	lxv.	869	2563	<i>Fagœstrum G. Don</i> -	xl.	561	
<i>Chamaelœcica</i> -	lxxij.	964		<i>Fig Marigold</i> -	lxxxii.	965	
<i>Chamaelœcium Desf.</i> -	lxxii.	964		<i>Five-leaved Ivy</i> -	xxxiii.	481	2544
<i>Chimonánthus Lindl.</i> -	lxix.	937	2566	<i>Flemingia Roxb.</i> -	xlviij.	646	
<i>Chionánthus L.</i> -	xvii.	1205		<i>Flowering Ash</i> -	xcviiij.	1241	
<i>Chorozema R. Br.</i> -	xli.	567		<i>Fontanèsia Lab.</i> -	xcvii.	1213	
<i>Christ's Thorn</i> -	xxxvii.	527	2547	<i>Forsythia Vahl</i> -	xcvii.	1213	
<i>Chrysœoma L.</i> -	lxxxii.	1075		<i>Fothergilla L.</i> -	lxxvii.	1008	
<i>Cineraria Less.</i> -	lxxxii.	1071		<i>Furze</i> -	xli.	571	2549
<i>Clêthra L.</i> -	lxxxviii.	1127		<i>Fraxèria W.</i> -	lxxxiiij.	1071	
<i>Clîánthus Sol.</i> -	xlviij.	646		<i>Fraxinæca</i> -	xcvii.	1213	
<i>Clifförtia L.</i> -	lxix.	955		<i>Fraxinus L.</i> -	xcvii.	1213	2579
<i>Cneorum L.</i> -	xl.	560		<i>Fringe Tree</i> -	xcvi.	1205	
<i>Collètia Kunth</i> -	xxxix.	551	2548	<i>Fuchsia L.</i> -	lxix.	944	2566
<i>Colubrina Bromn.</i> -	xxxix.	542		<i>Gastrolóbium Ker</i> -	xli.	567	
<i>Colútea R. Br.</i> -	xlvi.	635	2552	<i>Gaulthéria L.</i> -	lxxxviii.	1125	2575
<i>Condalia Cav.</i> -	xxxix.	541		<i>Gaylussaccia H. B. et K.</i> -	xcvi.	1175	
<i>Coronilla Neck.</i> -	xlviij.	643		<i>Gelsemium Mx.</i> -	xcix.	1256	
<i>Cranberry</i> -	xxxiiij.	1168	2577	<i>Genista Lam.</i> -	xli.	577	2550
<i>Crossulæca</i> -	lxxii.	965	2565	<i>German Tamarisk</i> -	lxx.	949	
<i>Cratægus Lindl.</i> -	lxi.	813	2562	<i>Gleditschia L.</i> -	xlviij.	650	
<i>Cress Rocket</i> -	xxi.	312		<i>Gompholóbium Sm.</i> -	xli.	567	
<i>Crotalaria</i> -	xlviij.	640		<i>Goddia Sal.</i> -	xlviij.	610	
<i>Cryptandra Sm.</i> -	xxxix.	542		<i>Gooseberry</i> -	lxxxii.	968	
<i>Culcitium Spr.</i> -	lxxxii.	1074	2575	<i>Gouania Jacq.</i> -	xxxix.	542	
<i>Cullamia R. Br.</i> -	lxxxiiij.	1072		<i>Granatæca</i> -	lxix.	939	2566
<i>Currant</i> -	lxxii.	968		<i>Grossulæca</i> -	lxxii.	967	2569
<i>Cyathodes Lab.</i> -	lxxxiiij.	1075		<i>Guelder Rose</i> -	lxxvii.	1032	
<i>Cyclopia R. Br.</i> -	xli.	567		<i>Gymnócladus</i> -	xlviij.	656	
<i>Cýdonia Tourn.</i> -	lxxviii.	929		<i>Gypsocállis Sal.</i> -	lxxxiii.	1082	
<i>Cýticus Dec.</i> -	xlviij.	588	2550	<i>Halèsia Ellis</i> -	xcvi.	1189	
<i>Dabœcia D. Don</i> -	lxxxviiij.	1116		<i>Halesiæca</i> -	xcvi.	1189	
<i>Dahlia Cav.</i> -	lxxxii.	1073		<i>Halimodéndron Fisch.</i> -	xlvi.	364	
<i>Darwinia Rudge</i> -	lxxii.	964		<i>Hamamelidæca</i> -	lxxv.	1006	2570
<i>Dasyánthes</i> -	lxxxiv.	1089		<i>Hamamelis L.</i> -	lxxv.	1007	2570
<i>Date Plum</i> -	xlv.	1194	2578				
<i>Daviesia R. Br.</i> -	lxi.	367					

	I.	II.	IV.		I.	II.	IV.
Hare's Ear -	lxxv.	997	2570	<i>Mäytenus</i> Feuil.	xxxv.	503	
Hartógia Dec.	xxxv.	404		Medlar -	xlv.	877	
Heath -	lxxxiii.	1079	2574	Medicago L.	xlvii.	642	
Hédera Swartz	lxxv.	999	2570	Melaleuca Lab.	lxvi.	957	
Hedýáree	xlvi.	643		Melaleuca	lxxi.	956	
Hedýsarum	xlvi.	645		Mellilótus Cast.	xlvii.	642	
Helma	lxx.	915		Menziésia Sm.	xcii.	1152	2765
Helvehrysum Lessing	lxxxii.	1070		Mesembryanthemum L.	lxxii.	966	
Heterodendron Desf.	xl.	550		Mesembryácea	lxxii.	966	
Hippocrénis Jacq.	xlvii.	645		Méspilus Lindl.	lxv.	877	
Holly -	xxxvi.	506	2545	Metrosidéros Vent.	lxxi.	961	
Homalinácea	xxxix.	542		Milk Vetch -	xlvi.	637	
Honey Locust	lxviii.	650		Mirbélia Sm.	xli.	567	
Honeysuckle -	lxxix.	1042	2572	Mimosa L.	xliv.	662.	2554
Hovea R. Br.	xlvi.	639		Mistletoe -	lxxvii.	1021	2571
Hovenia Thunb.	xxxix.	541		Mock Orange	lxx.	951	2567
Hydránga L.	lxxv.	994	2570	Monótoea R. Br.	lxxxiii.	1075	
Hymenánthes Blum.	xciv.	1173		Moor Heath -	lxxxiii.	1082	
Hypocalýptus Thunb.	xlvii.	640		Mucuna Wall.	xlviii.	649	
Ilex L.	xxxvi.	505	2545	Muscáin Dumont	lxxxi.	1063	
Indigófera L.	xlvi.	612		Mutistá D. Don	lxxxii.	1072	
Ionicia	lxxxii.	1074		Mygánda Jacq.	xxxvi.	505	
Itea L.	lxxxv.	992		Myricaria Desv.	lxx.	949	
Iva L.	lxxxii.	1066		Myrtácea	lxxi.	956	
Ivy -	lxxv.	999		Myrtica	lxxi.	961	2568
Jacksonia R. Br.	xli.	567		Myrtus L.	lxxi.	961	2568
Japan Laurel	lxxvii.	1026		Neília Dec.	xxxix.	544	
Japan Rose	xxvii.	351		Nemopánthes Raf.	xxxv.	503	2545
Jasminácea	xcix.	1248	2581	Nerium L.	xcix.	1256	
Jasmine -	xcix.	1248	2581	Nitraria L.	lxxii.	966	
Jasminum Forsk.	xcix.	1248	2581	Nitrariácea	lxxii.	966	
Judas Tree	xlviii.	657		O'dera Thunb.	lxxxii.	1074	
Jujube -	xxxvii.	524	2546	O'lea L.	xlvi.	1107	2572
Kagenéckia R. et P.	lxix.	931	2566	Oleacea	xcv.	1197	2578
Kálmia L.	xcii.	1151	2576	Oleander	xcix.	1256	
Kentucky Coffee Tree	xlviii.	656		Oleína	xcv.	1198	
Kérria Dec.	liii.	722	2555	Olenia Thunb.	xxxix.	542	
Labúrnum -	xlíiii.	590	2551	Olive	xcvi.	1207	2570
Lagerstrémia	lxx.	945		Ouónis L.	xliv.	604	
Lagonychium Bieb.	xliv.	661		Opántia Mill.	lxxii.	967	2569
Lámprotis -	lxxxv.	1093		Ouarácea	lxix.	942	2566
Laurustinus	lxxvii.	1032		O'pulus Tourn.	lxxvii.	1032	
Lavender Cotton	lxxxii.	1066		O'rnus Pers.	xcviii.	1241	
Lebeckia Thunb.	xlvii.	641		Osteospermum L.	lxxxii.	1072	
Lédum L.	xcii.	1155	2576	Othónna Bot. Cat.	lxxxii.	1072	
Leguminácea	xl.	561	2549	Oxycócos Pers.	xciii.	1168	
Leiophyllum Pers.	xcii.	1154		Oxylóbium R. Br.	xli.	567	
Leptospermum Sm.	lxxi.	961	2567	Páchya	lxxxv.	1091	
Lespedeza Mx.	xlvii.	616		Pachyrhizus Dec.	xlviii.	649	
Lessertia Dec.	xlvii.	643		Paliúrus L.	xxxvii.	527	2547
Leucopogon R. Br.	lxxxiii.	1075		Passiflora L.	lxxii.	964	
Leucothoe D. Don.	lxxxvi.	1113		Passiflorácea	lxxii.	964	
Leycesteria Wall.	lxxxii.	1060		Peach -	l.	679	2554
Ligústrum Tourn.	xcv.	1198	2578	Pear Tree -	lxvi.	879	2563
Lilac -	xcvi.	1208	2579	Periwinkle	xcix.	1254	2581
Ling, or Heather	lxxxiii.	1084	2574	Pernéttya Gaud.	lxxxviii.	1124	2575
Lipária L.	xlvi.	640		Pérsica Tourn.	l.	679	2554
Lissánthe R. Br.	lxxxiii.	1075		Phalerozárcus	lxxxviii.	1127	
Lobelia Forst.	lxxxi.	1065		G. Don			
Lobeliácea	lxxxi.	1065		Phaeocolor	xlviii.	647	
Locust Tree	xlv.	609	2552	Philadelphácea	lxx.	950	2567
Loddigésia Sims	xlvii.	641		Philadelphus L.	lxx.	951	2567
Lonicera Desf.	lxxxv.	1042	2572	Phillýrea Tourn.	xcv.	1203	25
Lonicérea -	lxxxix.	1041		Photinia Lindl.	lxiv.	868	
Lophándra -	lxxxv.	1093		Phýlica L.	xxxix.	542	
Loranthácea -	lxxvi.	1020	2571	Phyllis L.	lxxx.	1062	
Lótea -	xli.	571	2549	Phyllodoce Sal.	lxxxvii.	1115	
Lotus	xlvi.	642		Pieris D. Don	lxxxvi.	1114	
Lówea Lindl.	lxi.	812		Piéntza W.	lxxxii.	1074	
Lupinus Sims	xlviii.	649		Pinckneya Mx.	lxxxii.	1062	
Lyónia Nutt.	lxxxvi.	1109	2574	Piptánthus Smt.	xli.	566	
Lysanema R. Br.	lxxxv.	1074		Pistácia L.	xxxix.	545	2548
Lythracea	lxx.	945		Pistácia Nut Tree	xxxix.	545	2548
Manéttia Cham. et Schl.	lxxxii.	1062		Plagiolóbium Smt.	xlvi.	639	
Margýricárcus R. et P.	lxix.	951		Platylóbium Sm.	xlvi.	659	
Mastich Tree	xxxix.	547		Plocama Ail.	lxxxii.	1062	
				Ploughman's Spike- nard	lxxxii.	1065	
				Plum -	l.	684	2659
				Podánthus Lindl.	lxxxii.	1073	

	I.	II.	IV.		I.	II.	IV.
Podolobium R. Br.	xl.	567		<i>Sophora</i> R. Br.	xl.	563	2549
Podalyria R. Br.	xl.	567		<i>Sophorea</i>	xl.	563	2549
Pomaderris Lab.	xxxix.	514	2548	Soulingia Brongn.	xxxix.	514	
Poincæ	lxi.	813		Southernwood	lxxxii.	1068	2573
Pomegranate Tree	xlix.	937	2566	Spanish Broom	xli.	576	2550
Potentilla L.	lvi.	747	2557	Spârtium Dec.	xli.	576	2550
Potentilla L.	iii.	733	2557	Sphærocarya Wall.	xxxix.	541	
Poterium L.	lxix.	935		Spherolobium Sm.	xli.	567	
Prickly Pear	lxxii.	947	2569	Sphenotoma Smt.	lxxxiii.	1075	
Pride of India	lxx.	640		Spindle tree	xxxix.	496	2546
Priestleya Dec.	xlvii.	640		Spiræa	liii.	722	2556
Prinos L.	xxxvi.	520	2546	<i>Spiræa</i>	liii.	721	2556
Privet	xcv.	1198	2578	Sprengelia Bot. Cab.	lxxxiii.	1075	
Prunus Tourn.	l.	684	2554	Stachelind Lessing	lxxxiii.	1064	
Prosopis L.	xlx.	661		Staff Tree	xxxv.	502	2545
Psidium Sab.	lxxi.	961		Stauracanthus Lk.	xli.	576	
Psoralea L.	xlvii.	642		Stenanthëra R. Br.	lxxxiii.	1075	2573
Pterocarpus Dec.	xlx.	661		Stonocrop.	lxxii.	965	2568
Putenz B. M.	xli.	567		Storax	xciv.	1187	
Punica Tourn.	lxix.	939	2566	St. Peter's Wort	lxxxii.	1058	
Purshia Dec.	liii.	721		Strawberry Tree	lxxxvii.	1117	2575
Pyrethrum W. En.	lxxxvi.	1071	2573	Styloplâsum Desf.	xl.	560	
Pyrus Lindl.	lxvi.	879	2563	Styphelia R. Br.	lxxxiii.	1075	
Quince Tree	lxxviii.	929		Styræca	xciv.	1187	
Rafnia Thunb.	xlvii.	666		Styrax L.	xciv.	1187	
Raphiôlepis Lindl.	lxix.	932		Sumach	xxxix.	548	2548
Red Root	xxxviii.	539		Sutherlandia R. Br. 1	xlvii.	643	
Resipiënia Dec.	xlvii.	641		Swainsonia Sal.	xlvii.	643	
Restharrow	xli.	604		Symphoricârpus	lxxxii.	1058	
Retanilla Brongn.	xxxix.	541	2548	<i>Dill.</i>	lxxxii.	1058	
Rhamnûcæ	xxxvii.	523	2546	<i>Symphoricæa</i>	xciv.	1186	
Rhâmnus Lam.	xxxvii.	529	2547	<i>Symplocos Ker</i>	xciv.	1186	
Rhododëndron L.	lxxxix.	1130	2576	Syringa L.	xcvi.	1208	
Rhodorea	lxxxix.	1129		Syringæa	xcvi.	1208	
Rhus L.	xxxix.	548	2548	Syringodea	lxxxiv.	1091	
Ribes L.	lxxii.	968	2569	Tamaricæ	lxx.	916	
Robinia L.	xlv.	609	2552	Tamarisk	lxx.	917	
Rosa L.	lvi.	748		Tamaria Desr.	lxx.	947	
Rosacæ	xlix.	670	2554	Tarchonanthus Lam.	lxxxii.	1074	
Rose	lvi.	784		Tæcônia Juss.	lxxii.	965	
Rosea	lvi.	748	2558	Taverniera Dec.	xlvii.	646	
Rose Tree	lvi.	748	2558	Templetonia Sims.	xlvii.	640	
Rose Bay	lxxxix.	1130	2576	Tenoria Spreng.	lxxv.	997	2570
Rubia Ait.	lxxxii.	1062		Thibauidia H. B. et K.	xciv.	1173	
Rubiacæ	lxxxii.	1061	2573	Thorn	lxi.	813	2562
Rubus L.	liv.	733	2557	Timus Tourn.	lxxvii.	1032	
Rubia Wall.	xl.	560		Trevoa Mey.	xxxix.	541	
Sagittaria Brongn.	xxxix.	541		Triceros	xl.	560	
Salt Tree	xlvi.	634		Trichocéphalus Brongn.	xxxix.	542	
Sambucæ	lxxvii.	1027		Tristana R. Br.	lxxii.	956	
Sambûsus L.	lxxvii.	1027	2572	Trochocarpa R. Br.	lxxxiii.	1075	
Santolina	lxxxii.	1066		Tree Houseleek	lxxii.	965	
Sapotacæ	xciv.	1191	2578	Tuja G. Don	lxxxii.	1065	
Sarcophyllum Thunb.	xlvii.	641		Ulex L.	xli.	571	2549
Saxifragæ	lxxv.	994	2570	Umbellacæ	lxxv.	997	2570
Schinus L.	xl.	560		Uraria Desv.	xlvii.	645	
Schötia Ait.	xlx.	660		Vacciniæ	xcii.	1156	
Sclerothâmnus R. Br.	xli.	567		Vaccinium L.	xcii.	1156	2576
Scottia R. Br.	xlvii.	646		Vascôa Dec.	xlvii.	640	
Scutia Brongn.	xxxix.	541		Vernonia Hook.	lxxxii.	1073	
Sea Ragwort	lxxxii.	1071		Viborgia Spreng.	xlvii.	640	
Sedum L.	lxxii.	965	2568	Viburnum	lxxxvii.	1032	2572
Sempervivum L.	lxxii.	965		Viminaria Sm.	xli.	567	
Senecio B. M.	lxxxii.	1074		Vinca L.	xcix.	1254	2581
Serissa Comm.	lxxxii.	1062		Virèya	xciv.	1175	
Shrubby Cinquefoil	lvi.	747	2557	Virgilia L.	xli.	565	
Siberian Pea Tree	xlv.	629	2552	Viscum L.	lxxvii.	1021	2571
Sideroxylon	xciv.	1192		Wayfaring Tree	lxxvii.	1032	
Snowberry Tree	lxxxii.	1058	2572	Whortleberry	xcii.	1156	
Snowdrop Tree	xciv.	1189		Willemetia Brongn.	xxxix.	542	
Snow Flower Tree	xcvi.	1205		Winter Berry	xxxvi.	520	2546
Solenanthea G. Don	xxxix.	541		Winter Flower	lxix.	937	2566
Sônchus Jacq.	lxxxii.	1073		Wistaria Nutt.	xlviii.	647	2553
				Wych Hazel	lxxv.	1007	2570
				Yellow Wood	xl.	555	
				Zenobia D. Don	lxxxvi.	1108	
				Zizyphus Tourn.	xxxvii.	524	2546

ARBORETUM ET FRUTICETUM BRITANNICUM.

CHAP. XXXIII.

OF THE HARDY LIGNEOUS PLANTS OF THE ORDER CELASTRACEÆ.

DISTINCT. Char. Sepals 4—6: æstivation imbricate. Petals 4—6. Stamens 4—6, alternate with the petals; opposite the sepals, indistinctly perigynous. Ovary superior, free, girded with a fleshy disk, with 2—4 cells: ovules erect, rarely pendulous. Fruit capsular, baccate, drupaceous or samarideous. Seeds, in most, attended with an aril. Shrubs or trees. Leaves alternate or opposite, stipulate in most. Flowers whitish or greenish, in axillary cymes. (*Dec. Prod.*, and *Lindl. Introd. to N. S.*) Shrubs or low trees, chiefly deciduous; natives of both hemispheres; chiefly remarkable for the form and colours of their fruits; their flowers being neither large nor showy, nor their properties valuable in medicine, or general economy. All the species are readily increased by layers, by cuttings struck in sand, or by seeds. The genera containing hardy species are *Euonymus*, *Celastrus*, and *Nemopánthes*: the half-hardy species are included in *Máytenus*, *Cassine*, and *Hartògia*. The genus *Ilex* was formerly included in this order, and is still so in *De Candolle's Prodromus*, *Don's Miller*, *Royle's Illustrations*, and various other works, being made a tribe under the name of *Aquifoliaceæ*. As this tribe was elevated to the rank of an order, by *Dr. Lindley*, in his *Key*, we have followed that as an authority.

EUONYMUS Tourn. Sexes mostly hermaphrodite. Calyx 4—6-lobed, covered with a peltate disk. Petals 4—6, inserted into the disk. Stamens 4—6, inserted into rather prominent glands above the disk. Fruit a dehiscent capsule, of 3—5 cells. Seed with an aril. Leaves mostly opposite. (*Dec. Prod.*, ii. p. 3.)

CELASTRUS L. Sexes mostly hermaphrodite. Calyx minute, 5-lobed, Petals 5. Ovary small, immersed in a disk, that is marked with 10 longitudinal lines. Fruit a dehiscent capsule of 2—3 cells. Seed with an aril. Leaves alternate. (*Dec. Prod.*, ii. p. 3.)

NEMOPÁNTNES Rafin. Sexes polygamous or diœcious. Calyx minute. Petals 5. Ovary hemispherical, covered with a clammy juice or pulp. Fruit an indehiscent berry, that is roundish, and of 3—4 cells, and 3—4 seeds. (*Dec. Prod.*, ii. p. 17.)

MÁYTENUS Feuillée. Sexes polygamous. Calyx 5-cleft. Petals 5. Stamens 5. Ovary surrounded by a fleshy disk. Fruit dehiscent. Capsule of 1—4 cells. Seeds few, in the bottom of the cells, each with an aril. Leaves alternate. (*Dec. Prod.*, ii. p. 9.)

CASSINE L. Sexes hermaphrodite. Calyx minute, 4—5-parted. Petals 5. Fruit an almost dry drupe; its nut indehiscent, slender, of 3 cells, and 3 seeds, each pendulous from the top of a cell. Leaves opposite. (*Dec. Prod.*, ii. p. 11.)

HARTÓGLA Thunb. Sexes hermaphrodite. Calyx 4—5-cleft. Petals 4—5. Stamens 4—5. Fruit a dry drupe; its nut indehiscent, ovate, of 2 cells, and 2 seeds. Leaves opposite. (*Dec. Prod.*, ii. p. 12.)

GENUS I.



EUONYMUS *Tourn.* THE EUONYMUS, or SPINDLE TREE. *Lin. Syst.*
Tetra-Hex-ándria Monogýnia.

Identification. Tourn. Inst., t. 388.; *Lin. Gen.*, 271.; *Dec. Prod.*, 2. p. 3.; Don's Mill., 2. p. 3.

Synonymes. Fusain, Bonnet de Prêtre, or Bois à Lardoire, *Fr.*; Spindelbaum, *Ger.*

Derivation. The word *Euonymus* is formed from the Greek, and signifies of good repute; and Smith states that it has been applied to this genus, or, at least, to the species *E. europæus*, by antiphrasis, as this species is fetid in every part when bruised, and is esteemed poisonous. (*Eng. Flora*, i. p. 329.) The French word *Fusain* means a spindle, alluding to the use of the wood for making spindles. *Bonnet de Prêtre* alludes to the form of the capsules, which, when opened, bear some resemblance to a priest's cap; and it is called *Bois à Lardoire* from the use made of the wood for skewers or larding-pins. The German name is literally spindle tree.

‡ 1. *E. EUROPEUS* L. The European Euonymus, or Spindle Tree.

Identification. *Lin. Sp.*, 286.; *Dec. Prod.*, 2. p. 4.; Don's Mill., 2. p. 3.

Synonymes. *E. vulgaris* *Mil. Dict.*; Prick-timber *Gerard.*; Louse Berry, Dogwood, Gatteridge Tree; Fusain d'Europe, Bonnet de Prêtre commun, *Fr.*; gemeine Spindelbaum, *Ger.*

Derivation. The English name Prick-timber, or Prick-wood, alludes to the employment of the wood in making toothpicks and skewers, which were formerly called pricks; and it is called Dogwood, because a decoction of its leaves was used to wash dogs, to free them from vermin. The names of Gatteridge Tree and Gaitre Tree are derived from a Saxon word signifying a cover; from the capsule hanging, like a cover, over the fruit. It is called Louse Berry, because the powdered leaves and berries were formerly put on the heads of children to chase away lice.

Engravings. Smith's *Eng. Bot.*, t. 362.; Hayne *Abbild.*, t. 16.; *E. of Pl.*, 2912.; our *fig.* 164.; and the plate of the tree in our Second Volume.

Spec. Char., &c. Branches smooth. Leaves lanceolate-ovate, very finely sawed. Flowers about 3 upon one peduncle; the petals oblong, rather acute. Lobes of the capsule obtuse. (*Dec. Prod.*, ii. p. 4.) A shrub or low tree, a native of Europe, in hedges and scattered woods; plentiful in Britain; and, though seldom found in a wild state exceeding 10 ft. or 12 ft. in height, yet, in some situations, attaining, when cultivated, the height of 30 ft. and upwards. It produces its greenish white flowers in May, and ripens its rose-coloured fruits in September.



164

Varieties.

‡ *E. e.* 2 *fôlius variegâtis* Lodd. Cat. has variegated leaves, but never looks healthy.

‡ *E. e.* 3 *latifôlius* Lodd. Cat. has rather broader leaves than the species.

‡ *E. e.* 4 *nânus* Lodd. Cat. is a dwarf-growing plant.

‡ *E. e.* 5 *fructu albo* Lodd. Cat. has white capsules.

Nos. 3. and 5. of these varieties are, in our opinion, alone worth cultivating.

Description, &c. The roots are very numerous and whitish; forming a dense mass of network, and not extending to a great distance from the stem. The branches are numerous and opposite; and the wood hard and fine-grained. The leaves and bark are acrid, poisonous, and fetid when bruised. The capsules are of a fine rose colour, except in the white-capsuled variety, and the seeds are severally invested with an aril of a fine orange colour. This last character is conspicuous in the white-capsuled variety, as the colour of the capsule and that of the aril are in more direct contrast than in the species.

Geography, History, &c. This species is common throughout the middle and northern states of Europe; it is found in abundance in Sweden, in the north of Germany, in France, and in Britain; and it is also a native of Greece and Italy. It was noticed by the ancient Greek and Roman writers, and the wood seems, from the earliest ages, to have been used for various domestic purposes, more particularly for making netting-needles and spindles; and its uses in France and Germany, even at the present day, are very numerous. In

Britain, it was formerly employed in the manufacture of musical instruments; and it is still occasionally used for keys to pianofortes, and by turners and coopers. In Scotland, it is employed, along with the wood of the alpine laburnum (*Cytisus alpinus* L.), to form noggins, called bickers (? from the German word *becher*, a cup). These bickers are formed of small staves, alternately of the spindle tree and the laburnum; the wood of the former being white or yellowish, and that of the latter being very dark brown or black. When the wood of the spindle tree cannot be got, that of the holly is used. These bickers are employed both as drinking-vessels and as porridge dishes: in form they resemble milkpails; and when of a small size, are called luggies, from their having but one handle, which is called a lug, or ear. In Germany, shoots of 3 ft. or 4 ft. in length are bored and employed for the shanks of tobacco-pipes, the bowls being made of earthenware; and spindles are made of the wood in parts of the Continent where that mode of spinning is still practised: hence, the names of *fusain* and *spindelbaum*. The wood, split up into thin pieces, is formed into whisks for driving away flies. A charcoal is made of the shoots, which is much valued by artists, from the lines traced with it being easily effaced. This charcoal is made by putting a number of the shoots of two years' growth into an iron tube, and, after closing it so as to exclude the air, putting the tube in a fire till it becomes red. It is then taken out, and allowed to cool before the charcoal is removed. In using this charcoal, or charcoal crayons, as they are called, it is necessary, in sharpening them, to cut them to a point on one side, on account of the centre being only pith. The fruits of the tree have been employed by dyers, who derive three colours from them, green, yellow, and red. The first is obtained by boiling the seeds with alum; the second, by boiling the seeds alone; and the third, by using the capsules. A decoction of the capsules in alkali is said to colour hair red; and the leaves, dried and powdered, and put among the hair of the heads of children, is said to drive away vermin: hence one of the names. The fruit is said to be purgative and emetic in an eminent degree; so much so as not to be eaten by birds. After all, the principal use of the spindle tree at present, in Britain, is, to form skewers for butchers and cooks, and for watchmakers; the large trees in Forfarshire, that were formerly used by coopers in making bickers, being, for the most part, no longer to be met with. In ornamental plantations, this species, and all the others, are chiefly interesting in autumn, when, as Dumont elegantly observes, "they spread, by their numerous pendent capsules of a bright red colour or pure white, and their white and orange-coloured seeds, some rays of brilliance over the departing season, and recall the remembrance of the fine days of summer." (*Bot. Cult.*, vol. vi. p. 243.)

Casualties. The leaves are liable to be attacked by the caterpillar of the *Yponomeuta Euonymella Latr.*; so much so, that the plant, both in hedges and gardens, may frequently be seen wholly without leaves, and bearing numerous webs of a cobwebby appearance and consistence, which are formed by the young caterpillars, in the course of their feeding, in passing from point to point.

Statistics. The largest specimens of *E. europæus* in Great Britain appear to be in Scotland; more especially in Forfarshire, where the tree abounds, and attains a very considerable size, being frequently found from 25 ft. to 35 ft. in height, with trunks from 1 ft. to 18 inches in diameter. The wood, in that part of the country, is, or was formerly, much in demand by coopers and turners. In the neighbourhood of London, we know of but few large trees. One in Kensington Gardens, a little distance west of the Bayswater Gate, is 15 ft. high; in the Brompton Nursery, the white-capsuled variety has attained the height of 12 ft., with two stems, and a head covering a space of 25 ft. in diameter; at Mount Grove, Hampstead, 10 years planted, the species is 6 ft. high; in Essex, at Hylands, 10 years planted, it is 14 ft. high; in Oxfordshire, in the Oxford Botanic Garden, 40 years planted, it is 17 ft. high; in Pembrokehire, at Golden Grove, 7 years planted, and 10 ft. high; in Rutlandshire, at Belvoir Castle, 18 years planted, and 15 ft. high; in Staffordshire, at Trentham, 14 ft. high; in Yorkshire, at Grimston, 12 years planted, and 12 ft. high. In Scotland, in the Glasgow Botanic Garden, 12 years planted, and 13 ft. high; in Banffshire, at Gordon Castle, many trees are 20 ft. high. In Ireland, at Cypress Grove, near Dublin, 15 ft. high; at Terenure, 15 ft. high; at Coole, 17 ft. high, the diameter of the trunk, at 1 ft. from the ground, 1 ft. 2 in., and of the space covered by the branches 25 ft. In France, near Paris, at Sceaux, 20 ft. high. In Austria, at Kopenzel, near Vienna, 16 ft. high; in Held's Nursery, at Vienna, the white-capsuled variety, 12 ft. high; at Hadersdorf, 15 ft. high; at Brück on the Leytha, 14 ft. high. In Prussia, at Sans Souci, 15 ft. high. In Bavaria, in the Botanic Garden at Munich, 12 ft. high. In Sweden, in the Botanic Garden at Lund, 16 ft. high.

Commercial Statistics. The species, being little in demand, is not generally propagated in the London nurseries. *E. e. latifolius* is 1s. 6d. a plant. At Bollwyller, the species, the variegated-leaved variety, and the variety with white capsules, are each 50 cents; and *E. e. latifolius*, 1 franc and 50 cents: at New York, ?.

❖ 2. *E. VERRUCOSUS* Scop. The warted-barked *Euonymus*, or *Spindle Tree*.

Identification. Scop. Carn., ed. 2. No. 268.; Jacq. Fl. Austr.; Nouv. Du Ham.; Schmidt Arb.; Dec. Prod., 2. p. 4.; Don's Mill., 2. p. 4.
Synonyms. *E. europæus lepræus* Lin. Fil. Suppl., 154.; Fusain galeux, ou verruqueux, Fr.; warziger Spindelbaum, Ger.
Engravings. Nouv. Du Ham., 3. t. 8.; Schmidt Arb., t. 72.; Jacq. Fl. Austr., t. 49.; and our fig. 165.

Spec. Char., &c. Branches warted with prominent lenticular glands. Leaves ovate, slightly serrate. Flowers three on a peduncle. Petals ovate; capsule bluntly 4-cornered. (Dec. Prod., ii. p. 4.) A deciduous shrub of restricted growth, and rather conical outline; not marked by any feature of foliage, noticeable at a distance, that distinguishes it from *E. europæus*, but remarkable, and most distinct, on close inspection, in the warted character of its branches. The bark is of a green colour, and the warts of a dark one: they are small, and very numerous. A native of Europe, particularly of Austria, Hungary, and Carniola; introduced in 1763, and flowering in May and June. The flowers are of a purple brown colour. This species is cultivated in collections chiefly for the singularity of its appearance; being among spindle trees what the warted ash is among ash trees. It ripens seeds, and is readily increased by cuttings. Plants of it, 10 ft. high, were in Loddiges's arboretum in 1834. Plants, in the London nurseries, cost 1s. 6d. each; at Bollwyller, 1 franc.



‡ 3. *E. LATIFOLIUS* C. Bauh. The broad-leaved *Euonymus*, or *Spindle Tree*.

Identification. C. Bauh. Pin., 428.; Jacq. Hort. Vind., 2.; Dec. Prod., 2. p. 4.; Don's Mill., 2. p. 4.
Synonyms. *E. europæus* var. 2. Lin. Sp., 236.; Fusain à larges Feuilles, Fr.; breitblättriger Spindelbaum, Ger.
Engravings. Jacq. Fl. Austr., t. 289.; Nouv. Du Ham., 3. t. 7.; Bot. Mag., 2384.; E. of Pl., No. 2914.; our fig. 166.; and the plate of the species in our Second Volume.

Spec. Char., &c. Branches smooth. Leaves broadly ovate. A shrub or low tree, a native of Europe, and particularly of the south of Germany, and of some parts of France and Switzerland, where it grows to the height of 10 ft. or 12 ft., producing its greenish white flowers in June and July, which become of a reddish purple as they fade. Introduced in 1730. In British gardens, this forms much the handsomest species of the genus, from its broad shining leaves and its large red pendulous fruits, with orange-coloured seeds, which, when the capsules open, are suspended from the cells somewhat in the manner that the seeds of the magnolias hang from their strobiles. Even the wood of this species, during winter, is much handsomer than that of any other, the branches being regularly divaricate, with a clean bark, of a reddish green, and with long-pointed dark brown buds; by which alone this species may be distinguished from all the others. Unfortunately for this species, it is generally treated as a shrub, and crowded among other shrubs

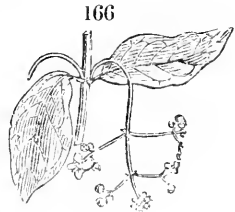

or trees; so that it is never allowed a chance of attaining either its full size or its proper shape. Notwithstanding this, at Purser's Cross, and in the arboretum at Kew, it is 15 ft. high. If treated as a tree, placed by itself on a lawn, it would form one of the very handsomest small trees that we possess during summer, from its fine broad shining leaves; and one of great singularity and beauty in autumn, when covered with its brilliant scarlet fruits. It appears much less liable to be attacked by insects than the common species, or than *E. verrucosus*, as may be seen in Loddiges's arboretum, where all the species and varieties are placed together; and where *E. latifolius* always appears with leaves uninjured; while the other species and varieties are sometimes almost entirely without leaves, from the ravages of caterpillars. Like the other species, *E. latifolius* may be propagated in abundance by seeds, or by cuttings, either of the young or of the ripened wood. Plants, in London, are 1s. 6d. each; at Bollwyller, 1 franc 50 cents; and at New York, ?.

♣ 4. *E. NANUS* Bieb. The dwarf Euonymus, or Spindle Tree.

Identification. Bieb. Fl. Taur. Suppl., p. 160; Dec. Prod., 2. p. 4; Don's Mill., 2. p. 4.

Spec. Char., &c. Branches smooth, somewhat herbaceous. Leaves lanceolate, entire, nearly opposite. Flowers 4-cleft, from 1 to 3 on a peduncle. A subshrub, with the aspect of the widow wail (*Cneorum tricóccum*), and a native of northern Caucasus. The fruit is not known; hence the species may not be of the genus *Euonymus*. (*Dec. Prod.*, ii. p. 4.)

♣ 5. *E. ATROPURPUREUS* Jacq. The dark-purple-flowered Euonymus, or Spindle Tree.

Identification. Jacq. Hort. Vind., 2; Ph. Fl. Am. Sept., 1. p. 168; Dec. Prod., 2. p. 4; Don's Mill., 2. p. 5.

Synonyms. *E. carolinénsis* Marsh. *Arb. Amer.*, No. 1; and, probably, *E. latifolius* Marsh. *Arb. Amer.*, No. 2.

Engravings. Jacq. Hort. Vind., 2. t. 120; Schmidt *Arb.*, t. 73; and our fig. 167.

Spec. Char., &c. Branches smooth. Leaves stalked, lanceolate, sawed. Flowers many upon a peduncle; the peduncle compressed. Petals orbiculate. Capsules angulately furrowed, smooth. (*Dec. Prod.*, ii. p. 4.) A native of N. America, from New York to Carolina, on the banks of rivulets. Introduced in 1756, and producing its dark purple flowers in June and July, which are succeeded by red fruit. This and the other American species of *Euonymus* are rarely found in a thriving state in Britain: as it appears to us, from not being planted in moist shady situations, and in peat or sandy soil. The plant in the London Horticultural Society's Garden, named *E. atropurpureus*, was, in 1834, 3 ft. high, after being 6 years planted. Plants, in the London nurseries, are 1s. 6d. each; at Bollwyller, 1 franc; and at New York, 25 cents.

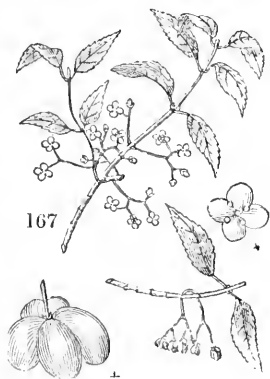

♣ 6. *E. AMERICANUS* L. The American Euonymus, or Spindle Tree.

Identification. Lin. Sp., 286; Dec. Prod., 2. p. 4; Don's Mill., 2. p. 5.

Synonyms. *E. sempervirens* Marsh.; *E. alternifolius* Manch; the Burning Bush, *Amer.*

Engravings. Nouv. Du Ham., 3. t. 9; Pluk. *Alm.*, t. 150, fig. 5; Schmidt *Arb.*, t. 75; our fig. 168, representing the plant in flower; and fig. 169, representing it in seed, with the warty capsule.

Spec. Char., &c. Branches smooth. Leaves almost sessile, elliptic-lanceolate, sawed. Flowers 1 to 3 on a peduncle. Petals sub-orbiculate. Capsule echinately warty. (*Dec. Prod.*, ii. p. 4.) A sub-evergreen shrub, growing to the height of 6 ft. or 8 ft; a native of North America, from New England to Carolina, in hedges and shady woods, among rocks, and on the

168

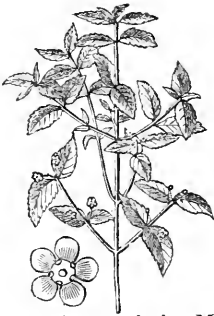

edges of swamps; introduced in 1686. The flowers appear in June and July: they are yellow, tinged with red, and are succeeded by scarlet fruits which, according to Pursh, resemble, at a distance, those of *Arbutus U'nedo*. They are a great ornament, he says, to this almost evergreen shrub, and have given rise, in America, to its common name, the burning bush. Plants of this species are in the arboretums of the London Horticultural

Society and the Messrs. Loddiges, but not in a thriving state, for want of moisture and shade. Price of plants, at New York, 15 cents, and of seeds 1 dollar a quart.

169



* 7. *E. SARMENTOSUS* Nutt. The trailing-stemmed *Euonymus*, or *Spindle Tree*.

Identification. Nutt. Gen. Amer., 1. p. 155; Don's Mill., 2. p. 5.

Synonymes. *E. scandens* Hort.; *E. americanus* var. *sarmentosus* Dec. Prod., 2. p. 4

Spec. Char., &c. Chiefly distinguished from the last by its having a trailing stem that is prone to emit roots into the soil. It inhabits shady woods in Virginia and Carolina. (Dec. Prod., i. p. 4.) Introduced in 1824.

* 8. *E. OBOVATUS* Nutt. The obovate-leaved *Euonymus*, or *Spindle Tree*.

Identification. Nutt. Gen. Amer., 1. p. 155; Dec. Prod., 2. p. 4; Don's Mill., 2. p. 5.

Spec. Char., &c. Stem prostrate, rooting. Shoots upright, with 4 blunt angles. Leaves broadly obovate, obtuse, almost sessile, sawed, with acute fine teeth. Flowers 3 upon a peduncle. Calyxes inflated. Anthers sessile. (Dec. Prod., ii. p. 4.) A trailing shrub, a native of Pennsylvania, in marshes, between Franklin and Waterford; introduced in 1820, and flowering in June and July. The plant of this species in the garden of the London Horticultural Society was, in 1834, 1 ft. in height, and covered a circle of 10 ft. in diameter. We have not observed the name in any nurseryman's catalogue.

* 9. *E. ANGUSTIFOLIUS* Ph. The narrow-leaved *Euonymus*, or *Spindle Tree*.

Identification. Ph. Fl. Amer. Sept., 1. p. 168; Dec. Prod., 2. p. 4; Don's Mill., 2. p. 5.

Spec. Char., &c. Branches smooth. Leaves either oblong-elliptical or linear-elliptical, somewhat falcate, almost entire, almost sessile. Flowers mostly 1 on a peduncle, unequally 5-cleft. Capsules echinately warted. Allied to *E. americanus*. (Dec. Prod., ii. p. 4.) A deciduous shrub, of 6 ft. or 7 ft. in height; a native of North America, in Georgia, in shady woods. Introduced in 1806. Its flowers and fruit resemble those of *E. americanus*; and, though nearly related to it, Lyon, its discoverer, was informed by Pursh, that, when propagated by seeds, it retains its distinctive character. Plants, in the London nurseries, are 1s. 6d. each; at New York, 1 dollar.

† 10. *E. HAMILTONIANUS* Wall. Hamilton's *Euonymus*, or *Spindle Tree*.

Identification. Wall. Fl. Ind., 2. p. 403; Don's Mill., 2. p. 4.

Synonymes. *E. atropurpureus* Wall. Fl. Ind., 2. p. 402.

Spec. Char., &c. Branches smooth, terete. Leaves lanceolate, finely serrated. Peduncles dichotomous, 6-flowered. Flowers tetrandrous. Petals 4, lanceolate cordate. Ovary 4-lobed, 4-celled, each cell containing 2 ovules. (Don's Mill., ii. p. 4.) A shrub or low tree, a native of Nepal, where it grows to the height of 20 ft., with an erect trunk and spreading branchlets. It was

introduced in 1825; and there are plants of it in the London Horticultural Society's Garden, and in some nurseries. A standard plant of it, in the garden of the London Horticultural Society, in an open situation, was, in 1834, 4 ft. high, after being 4 years planted. Plants against a wall, in the same garden, are 10 ft. high. The species is striking from the whiteness of its stem, and the largeness of its leaves. The plant above mentioned, which is trained to a wall, flowers pretty freely; but the flowers are small, and the cymes of them do not make a show: they are of a yellowish green colour.

‡ 11. *E. GARCINLEFOLIUS* Roxb. The *Garcinia*-leaved *Euonymus*, or *Spindle Tree*.

Identification. Roxb. in *Fl. Ind.*, 2. p. 403; Don's *Mill.*, 1. p. 4.
Synonyme. *E. laccerus* Ham. in *D. Don's Prod. Fl. Nep.*, p. 191.?, *Dec. Prod.*, 2. p. 5., *Don's Mill.*, 2. p. 4.

Spec. Char., &c. Branchlets smooth, terete. Leaves lanceolate, entire. Petals oblong, with incurved edges, much longer than the calyx. Peduncles between the leaves, sometimes solitary, 3-flowered. Flowers pentandrous. (*Don's Mill.*, ii. p. 4.) A shrub or tree, growing to the height of 12 ft.; a native of Nepal; introduced in 1820. The flowers are small, pale yellow; the capsule oblong, about the size of a small field bean, 1-celled, 2-valved, opening from the base, containing one oval seed, covered with a thin, succulent, veined, bright scarlet aril. (*Ibid.*) This appears to be a very remarkable species; but we have not seen plants of it.

‡ 12. *E. GRANDIFLORUS* Wall. The large-flowered *Euonymus*, or *Spindle Tree*.

Identification. Wall. in *Fl. Ind.*, 2. p. 404; Don's *Mill.*, 2. p. 5.
Spec. Char., &c. Branches terete, smooth. Leaves obovate-oblong, obtuse, acutely serrate, with a tapering entire base. Peduncles slender, flattened, nearly equalling the length of the leaves, 3-6-flowered. Flowers tetrandrous; petals orbicular, flat, with curled edges. Capsule globular, pendulous, obscurely 4-cornered, with, usually, geminate pendulous seeds. (*Don's Mill.*, 2. p. 5.) A shrub, growing 10 ft. high, in the forest of Nepal, where it is very ornamental, both when in flower and when loaded with its yellow pendulous capsules, each of which is furnished with as many as 6 black pendulous seeds. The flowers are white, very large, scentless, slightly nodding; capsule very nearly globular, about the size of a cherry, 4-celled, 4-valved. Seeds oval, black, half covered by a brilliant red, minutely lobed, warted aril. (*Ibid.*) This very desirable species has not yet been introduced.

App. i. *Half-hardy Species of Euonymus, or Species which, according to G. Don, "will, no doubt, turn out to be truly hardy."*

The following are already in the country, and treated as frame or greenhouse plants:—

‡ *E. gróssus* Wall., a tree of Nepal, growing 12 ft. high, and introduced in 1824.

‡ *E. micranthus* D. Don, a Nepal shrub of 8 ft. high, introduced in 1820.

‡ *E. lucidus* D. Don, a Nepal shrub of 6 ft. high, introduced in 1820.

‡ *E. japonicus* Thunb., an elegant Japan tree, growing to the height of 20 ft., introduced in 1804.

‡ *E. echinatus* Wall., a climbing and rooting shrub from Nepal, in 1824. (*fig.* 170.) Found on mountains, at the height of from 5,000 ft. to 7,000 ft.

The following species, marked in Don's *Miller* as frame plants, are not yet introduced:—

‡ *E. tingens* Wall., a tree of Nepal, growing to the height of 16 ft. or 20 ft., the yellow bark of which is employed by the Nepalese for the purpose of marking the forehead with their religious symbol, commonly called *ticha*. This is also found on mountains. In p. 173., under the order *Celastraceæ*, are enumerated two other Nepal species, which will probably prove hardy; and which will be found described below.

‡ *E. gláber* Roxb., a tree growing to the height of 15 ft., in Chittagong, in the East Indies.

‡ *E. fimbriátus* Wall., a tree from the Sewalik Mountains, in India, with doubly serrated leaves.

‡ *E. indicus* Heyne, an East India shrub 8 ft. high.

‡ *E. vógans* Wall., a most extensive climbing and rambling shrub, in the mountainous forests of Nepal, resembling *E. echinatus*, but never throwing out roots at the joints.

‡ *E. subtriflorus* Blume, and *E. Thunbergianus* Blume, are Japan shrubs, of which little appears to be known.

The following species are those above alluded to, as mentioned in Royle's *Illustrations*, and not included in Don's *Miller*:—

E. pendulus Wall., a Nepal tree, considered by some as identical with *E. japonicus*, and found on the Himalaya Mountains, at an elevation of about 5,000 ft.

E. frigidus Wall. is also a Nepal tree, which is generally found with *E. fimbriata*, at not less than 8,000 ft. of elevation.



GENUS II.



CELASTRUS L. THE CELASTRUS, or STAFF TREE. Lin. Syst. Pentándria Monogýnia.

Identification. Lin. Gen., 270.; Dec. Prod., 2. p. 5.; Don's Mill., 2. p. 6.

Synonyms. Euonymoides Mench.; Célastré, Fr.; Celaster, Ger.

Derivation. From *kélas*, the latter season; the fruit remaining on the tree all the winter. The *kélastros* of the Greeks is supposed to be the *Euonymus*.

3 **1. C. SCA'NDENS L.** The climbing-stemmed *Celastrus*, or *Staff Tree*.

Identification. Lin. Sp., 285.; Dec. Prod., 2. p. 6.; Don's Mill., 2. p. 9.; Bourreau des Arbres, Fr.; Baumwörder, Ger.

Engravings. Nouv. Du Ham., 1. t. 95.; Schkuhr Handb., 1. t. 47.; and our fig. 171.

Spec. Char., &c. Thornless, climbing, smooth.

Leaves oval, acuminate, serrate. Flowers diceious. (*Dec. Prod.*, ii. p. 6.) A deciduous twining shrub; a native of North America, and introduced, by Peter Collinson, in 1736. The flowers are of a pale yellow, and the capsules of an orange scarlet colour, 3-cornered and 3-seeded. The stems are woody and flexible, and twist themselves round trees and shrubs, or round each other, to the height of 12 ft. or 15 ft. or upwards, girdling trees so closely as, in a few years, to destroy them; whence the French and German names, which signify "tree-strangler." The leaves are about 3 in. long, and nearly 2 in. broad, serrated, of a lively green above, but paler on the under side. We are uncertain whether both of the sexes are extant in British collections or not; but, as seed has been produced in the Botanic Garden at Bury St. Edmunds, it is clear that the female one, at least, is. Miller says the seeds ripen well in England, and that the plant may be propagated by them, or by layers. It prefers a strong loamy soil, rather moist than dry. As a freely growing twiner, with pleasing foliage, and as lignous twiners are not numerous, it deserves to be more generally cultivated. Plants, in the London nurseries, cost 1s. 6d. each, and American seeds 6d. an ounce; at Bollwyller, plants 1 franc each; and at New York, plants 20 cents each, and seeds 35 cents a quart.

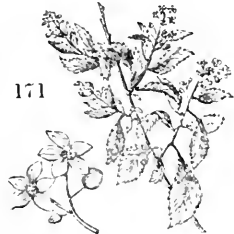

1 **2. C. BULLA'TUS L.** The studded-capsuled *Celastrus*, or *Staff Tree*.

Identification. Lin. Sp., 285.; Dec. Prod., 2. p. 6.; Don's Mill., 2. p. 7.

Engravings. Pluk. Alm., t. 28. f. 5.

Spec. Char., &c. Thornless, climbing. Leaves ovate, acute, entire. Flowers in terminal panicles. Capsules elegant, studded, scarlet. (*Dec. Prod.*, ii. p. 6.) A low shrub, said to be a native of Virginia, and to have been first discovered by Banister, and afterwards introduced in 1759; but Pursh, after diligent research, in the place of its supposed nativity, and also in the herbariums of Plukenet and Banister, at the British Museum, was not able to satisfy himself that it was a native of America. Miller says that it grows, in its native country, to the height of 8 ft. or 10 ft.; but in England it seldom attains more than half that size. It flowers in July; and, in its native country, the flowers are succeeded by scarlet capsules; but it rarely ripens seeds in England. (*Mart. Mill.*)

App. i. *Half hardy Species of Celastrus.*

There are a number of species of *Celastrus* from the Cape of Good Hope, and some from the East and West Indies, and South America, which might be tried in the open air against a conservative wall; but the family are not of sufficient beauty or interest to render this desirable to any great extent.

GENUS III.



NEMOPANTHES Rafin. THE NEMOPANTHES. *Lin. Syst. Polygãmia Dicc'cia.*

Identification. Rafin. Journ. Phys., 1819, p.96.; Dec. Prod., 2. p. 17.; Don's Mill., 2. p. 13.

Synonymcs. *Hicoides Dum. Cours.*, 1. vol. 4. p. 27.

Derivation. From *nemos*, a grove, and *anthos*, a flower; it being generally found in groves.

☞ 1. *N. CANADENSIS* Dec. THE Canadian Nemopantes.

Identification. Dec. Mém. Soc. Gen., 1. p. 44.; Pl. Rar. Hort. Gen., t. 3.; Don's Mill., 2. p. 13.

Synonymcs. *Plex canadensis Michx. Flor. Bor. Amer.*, 2. p. 299.; *N. fascicularis Rafin.*; *Plex delicatula Bart. Fl. Fr.*, p. 67.; ? *Prinos lucidus Ait. Hort. Kew.*, 2. p. 478.; *Houx du Canada, Fr.*

Engravings. Dec. Mém. Soc. Gen., 1. t. 3.; Michx. Fl. Bor. Amer., 2. t. 49., as *Plex canadensis*; and our fig. 172.

Spec. Char., &c. Leaves ovate, quite entire, or serrated at the apex, smooth. Pedicels usually solitary, 1-flowered, very long. Flowers white. Berries large, beautiful crimson, very ornamental. (*Don's Mill.*, ii. p. 13.) This is said to be a very hardy, ornamental, deciduous shrub, and to be cultivated at Courset, and in the nursery of M. Cels, at Paris. We have only seen a small plant of it, under the name of *Prinos lucidus*, in the garden of the London Horticultural Society, which, in 1834, was 4 ft. high, after having been 8 years planted.

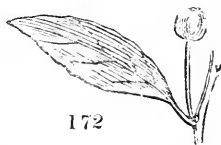

GENUS IV.



MAYTENUS Feuill. THE MAYTENUS. *Lin. Syst. Polygãmia Dicc'cia.*

Identification. H. B. et Kunth. Nov. Gen. Amer., 7. p. 64.; Dec. Prod., 2. p. 9.; Don's Mill., 2. p. 10.

☞ 1. *M. CHILENSIS* Dec. THE Chili Maytenus.

Identification. Dec. Prod., 2. p. 9.; Don's Mill., 2. p. 11.; Lindl. in Bot. Reg., t. 1702.

Synonymcs. *Senecia Maytenus* Lam. Ill., No. 2712.; *Celastrus Maytenus* Willd. Sp., 1. p. 1127.; ? *M. boaria Mol. Chit.*, p. 152.

Engravings. Feuill. Obs., 3. p. 39. t. 27.; Bot. Reg., t. 1702.; and our fig. 173.

Spec. Char., &c. Leaves lanceolate serrated. A handsome evergreen shrub, a native of Chili, at Coquimbo, and introduced in 1829. In its native country, it is said to form a small tree, 12 ft. high; in the garden of the London Horticultural Society, where it has been planted against a south wall since 1830, it forms a handsome, evergreen, branchy shrub, with twiggy branchlets. It has also been tried there as a standard, and found to be quite hardy. The flowers are in axillary clusters, with a corolla of a yellowish green colour, not showy. (*Bot. Reg.*, t. 1702.) This desirable addition to our hardy evergreen shrubs will, we trust, soon come into general cultivation. It affords one of the numerous examples which are continually occurring of the utility of trying house plants in the open air, since in published lists it is marked as requiring a green-house.



GENUS V.

CASSINE L. THE CASSINE. *Lin. Syst. Pentandria Monogynia.*

Identification. Lin. Gen., 371.; Lam. Ill., t. 310.; Gært. Fruct., 2. p. 72. t. 92.; Dec. Prod., 2. p. 11.; Don's Mill., 2. p. 12.

Derivation. The word *Cassine* is of American origin, and unknown meaning.

■ 1. *C. MAUROCE'NSIS* L. Mauroceni's Cassine, or the Hottentot Cherry.

Identification. Lin. Sp., 385; Don's Mill., 2. p. 13.

Synonymy. Maurocenia frangularia Mill. Dict., No. 1.

Derivation. The specific name was given in honour of the Venetian senator, Signor Francisco Mauroceni, who had a fine garden at Padua, a catalogue of the plants in which was published by Antonio Teta.

Engraving. Dill. Elth., t. 121. f. 147.

Spec. Char., &c. Leaves sessile, obovate, quite entire, convex. Pedicels many, very short. (*Don's Mill.*, ii. p. 13.) A shrub, a native of Ethiopia, introduced in 1690, and commonly kept in green-houses, but which deserves trial against a conservative wall.

■ 2. *C. CAPE'NSIS* L. The Cape Cassine, or Phillyrea.

Identification. Lin. Mant., 220; Don's Mill., 2. p. 13.

Engravings. Burm. Rar. Plant. Afr., t. 85; Dill. Elth., t. 236; and our fig. 174.

Spec. Char., &c. Leaves stalked, ovate, retuse, crenate, flat. Panicles solitary, shorter than the leaves. Flowers small, white. (*Don's Mill.*, ii. p. 13.) A shrub, a native of the Cape of Good Hope, found in woods; introduced in 1629, and producing its small white flowers in July and August.

C. excelsa Wall., *C. discolor* Wall., and *C. Colpoön Thun.*: the first a native of Nepal, and introduced in 1820; and the last a native of the Cape of Good Hope, and introduced in 1791, might be tried against a conservative wall, with every prospect of success.



GENUS VI.

HARTOGIA Dec. THE HARTOGIA. Lin. Syst. Tetra-Pentándria Monogýnia.

Identification. Dec. Prod., 2. p. 12; Don's Mill., 2. p. 13.

Derivation. Named in honour of *J. Hartog*, a Dutch traveller, and naturalist at the Cape of Good Hope.

■ 1. *H. CAPE'NSIS* L. The Cape Hartogia.

Identification. Lin. Fil. Suppl., 128; Don's Mill., 1. p. 13.

Synonymy. Schrebera schinoides Thun. Prod., t. 2; Elæodéndron schinoides Spreng. Syst., 1. p. 780.

Engraving. Thunb. Prod., t. 2.

Spec. Char., &c. Leaves opposite, oblong, crenated, smooth, hardly stalked. Pedicels few-flowered, axillary, drooping. (*Don's Mill.*, ii. p. 13.) A shrub, a native of the Cape of Good Hope, growing to the height of 10 ft., and introduced in 1800. It is marked in the catalogues as a green-house plant, but has been found to stand the open air as an evergreen shrub. In the London nurseries, a narrow-leaved variety of the *Cerasus Laurocerasus* used frequently to be sold for it.

CHAP. XXXIV.

OF THE HARDY AND HALF-HARDY PLANTS OF THE ORDER AQUIFOLIA'CEÆ.

Identification. Lindley's Key, p. 63.

Synonymy. Celastrineæ, tribe Aquifoliæcæ, in part, Dec. Prod., 2. p. 11; Ilicineæ, in part, Lindl. Introd. to N. S., p. 178, Don's Mill., 2. p. 14.

Distinctive Characteristics. Calyx and corolla with an imbricate æstivation. Sepals 4—6. Corolla hypogynous, with 4—6 lobes, and as many stamens inserted into it alternately to its lobes. Ovary 2—6-celled; a pendulous ovule in each cell. Fruit fleshy, indehiscent, with from 2—6 stones, each containing a pendulous seed, which has large fleshy albumen. Flowers small, axillary, solitary, or fascicled. (*Lindl. Introd. to N. S.*) Myginda is described as having a 1-celled fruit. The species of Aquifoliæcæ are evergreen and deciduous shrubs or trees, having alternate or opposite leaves, frequently coriaceous, glabrous, and sometimes feather-nerved. The genera containing hardy species are three, and are thus distinguished:—

MYGINDA Jacq. Sexes hermaphrodite. Calyx 4—5-cleft. Corolla deeply 4-cleft. Stamens 4, inserted into the base of the corolla. Fruit with (very

likely by abortion) 1 cell and 1 seed. Shrubs with branchlets square; leaves opposite, subcoriaceous, and flowers upon trifidly or trichotomously branched peduncles. (*Dec. Prod.* and *Don's Mill.*)

I'LEX L. Sexes hermaphrodite, very rarely, by defect, diœcious or polygamous. Calyx 4—5-toothed. Corolla 4—5-cleft. Stamens 4—5, inserted into the tube of the corolla. Fruit including 4 or 5 nuts. Evergreen shrubs, with, mostly, coriaceous leaves. Flowers many on a peduncle. (*Dec. Prod.* and *Don's Mill.*)

PRI'NOS L. Sexes mostly, by defect, diœcious or polygamous. Calyx 6-cleft. Corolla 6-cleft. Stamens 6, inserted into the tube of the corolla. Fruit including 6 nuts. Shrubs, with leaves deciduous or persistent, and flowers 1 upon a peduncle. (*Dec. Prod.* and *Don's Mill.*)

GENUS I.



MYGINDA Jacq. THE MYGINDA. *Lin. Syst.* Tetrândria Monogýnia.

Identification. Jacq. Amer., p. 24; Dec. Prod., 2. p. 12; Don's Mill., 2. p. 15.

Synonyme. *I'lex Pursh.*

Derivation. So named by Jacquin in honour of Francis von Mygind, a German botanist.

■ 1. *M. MYRTIFOLIA* Nutt. The Myrtle-leaved Myginda.

Identification. Nutt. Gen., 1. p. 109; Don's Mill., 2. p. 15; Dec. Prod., 2. p. 13.

Synonyme. *I'lex Myrsinites Pursh Fl. Sept. Amer., Hook. Fl. Bor. Amer., 1. p. 119, 120. Engravings.* Hook. Fl. Bor. Amer., t. 41; and our fig. 175.

Spec. Char., &c. Leaves oblong, blunt, serrated, smooth, with revolute edges. Peduncles very short, usually solitary, 1-flowered. Style short, club-shaped. 4-lobed at the apex. (*Don's Mill.*, ii. p. 15.) An evergreen shrub, a native of the western coast of North America, on subalpine hills, where it grows to the height of 4 ft. Introduced in 1818. The flowers are small and white, and they appear from May to August. The drupe, when mature, is about the size of a pea: it is of a dark purple colour, and contains only 1 elliptical seed. Small plants of this species are in the arboretum of Messrs. Loddiges, where it is increased by cuttings.



GENUS II.



I'LEX L. THE HOLLY. *Lin. Syst.* Tetrândria Tetragýnia.

Identification. Lin. Gen., No. 172; Dec. Prod., 2. p. 13; Don's Mill., 2. p. 16.

Synonymes. *Aquifolium Tourn. Inst., t. 371., Gärt. Fruct., 2. t. 92.; Houx, Fr.; Stechpalme, or Heiße, Ger.*

Derivation. Theophrastus, and other Greek authors, named the holly *Agria*; that is, wild, or of the fields; and the Romans formed from this the word *Agrifolium*; and called it, also, *Aquifolium*, from *acutum*, sharp, and *folium*, a leaf. C. Bauhin and Loureiro first named it *I'lex*, on account of the resemblance of its leaves to those of the *Quercus I'lex*, the true *Ilex* of Virgil. Linnæus adopted the name of *I'lex* for the genus, and preserved the name of *Aquifolium* for the most anciently known species. The name of holly is, probably, a corruption of the word *holy*, as Turner in his *Herbal* calls it *Holy*, and *Holy Tree*, probably from its being used to commemorate the holy time of Christmas, not only in houses, but in churches. The German name *Christdorn*, the Danish name *Christorn*, and the Swedish name *Christorn*, seem to justify this conjecture.

‡ 1. *I. AQUIFOLIUM* L. The prickly-leaved, or common, Holly.

Identification. Lin. Sp., 181; Fl. Dan., 508; Dec. Prod., 2. p. 14; Don's Mill., 2. p. 16.

Synonymes. The holly, being a native of most parts of Europe, and being every where much admired, has several names in most living European languages. We shall give the chief of these from Nieuman's *Dictionary*.

English. *Hulver, Hulfere, and Holme.*

German. Stechpalme, Stecheiche, Stechbaum, Stechlaub, Hulse, Hulsenbaum, Hulsenstrauch, Hulzt, Hulchs, Holst, Habze, Hüllgenolz, Myrtendom, Christdorn, Maudorn, Zwieseldorn, Kleezebusch, Stechapsel, Stechwinde, Waldistel.

Danish. Stikpalme, Maretorn, Christorn, Skoutisdell.

Swedish. Jernek, Christsorn.

French. Le Houx, le grand Honsson, l'Agrou grand Pardon, and Bois Franc.

Italian. Agrifolio, Alloro spinoso.

Spanish. Acebo, Agrifolio.

Portuguese. Azevinho, Agrifolio, Acrifolio, Aginfolio.

Russian. Waefoscheld, Ostrolof, Padub.

Dutch. Schubbig hardelk.

Engravings. Smith, Eng. Bot., t. 496.; Mill. Icon. 46.; Blackw. Icon., t. 205.; and the plate of the species in our Second Volume.

Spec. Char., &c. Leaves oblong, shining, wavy, spiny-toothed. Peduncles axillary. Flowers nearly umbellate. A handsome, conical, evergreen tree, a native of Europe, growing to the height of 30 ft. in a wild state, and to twice that height or upwards in a state of cultivation. The flowers are white, and appear in May; and the fruit is red, ripening in September, and remaining on the tree all the winter. The lower leaves are very spinous; while the upper ones, especially on old trees, are entire.

Varieties. In general the variegation of plants, more especially of trees and shrubs, is accompanied by a ragged, or otherwise unhealthy, appearance in the leaves; but the holly is one of the very few exceptions to this rule. The variegations of the holly are chiefly confined to the modification of white and yellow in the leaves; but there are some sorts in which the variation results from the state of the leaves with reference to prickles, to magnitude, and to form; and others consist of differences in the colour of the fruit, which is red, yellow, or white, and, according to some, black. All the varieties have been selected by gardeners from sports, or accidental deviations, from the central form and colour, detected in wild plants, or in plants in a state of cultivation. One of the most assiduous gardeners in collecting these varieties, according to Collinson, was Wrench of Fulham, who lived in the latter part of the reign of Charles II., and who planted the elm trees in St. James's Park. The collections of hollies in the time of Miller appear, from his lists, to have been more extensive, and to have been attended to with much more care, than they are at present; the wish being now more for species than varieties. The best garden collection of hollies in the neighbourhood of London is that in the arboretum of the Messrs. Loddiges; of which we shall give a classification below. The following sorts are purchasable in the London nurseries, exclusive of twenty or thirty subvarieties, differing in the degrees of variation of yellow or white blotches in the leaves. These subvarieties are, for the most part, without names, and are sold as yellow variegated or white variegated hollies of sorts. Of these subvarieties there are forty or fifty sorts from 6 ft. to 10 ft. high, all planted adjoining each other in the arboretum of the Messrs. Loddiges. Thirty-one varieties are described in the *Nouveau Du Hamel*, chiefly taken from Miller's *Catalogue*; but many of these varieties are no longer to be found in British nurseries. It is curious to look over the lists of the names of variegated hollies, which have been given in nurserymen's catalogues and garden books, from the time of London and Wise to the present day. In former times, as at present, the name given to any new variety was either that of the person who originated it, or that of the place where it was first raised; so that these lists present a sort of chronological history of nurserymen and nurseries, commencing with Wrench's Phyllis and Bridgman's yellow, named after persons, and terminating with the recent Irish varieties, Ballybeg and Ballyarthur hollies, lately sent to the London Horticultural Society, and named after places. The varieties in the following groups appear to us to be all that are truly distinct; but the shades of difference under each name in these groups are almost innumerable.

A. *Varieties designated from the Form, Magnitude, Thickness, Surface, or Margin of the Leaf.*

‡ I. A. 2 *heterophyllum* Hort. *The various-leaved common Holly.*



176



177



178

- ♣ I. A. 3 *angustifolium* Hort. *The narrow-leaved common Holly.*
- ♣ I. A. 4 *latifolium* Hort. *The broad-leaved common Holly.*
- ♣ I. A. 5 *altacrerense* Hort. *The High Clere common Holly.* — Leaves broad, thin, and flat.
- ♣ I. A. 6 *marginata* Hort. (*fig. 176.*) *The thick margined-leaved common Holly.* — Leaves without prickles, coriaceous, nearly as broad as long, and with a thickened margin.
- ♣ I. A. 7 *laurifolium* Hort. (*fig. 177.*) *The Laurel-leaved common Holly.* — Leaves small, oval-lanceolate, without prickles, about the size and shape of those of *Laurus nobilis*.
- ♣ I. A. 8 *ciliatum* Hort. (*fig. 179.*) *The ciliated-leaved common Holly.* — Leaves oval-acuminate, small, the prickles along the margins like hairs.

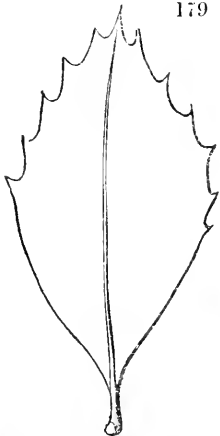

179



180

- ♣ I. A. 9 *ciliatum minus* Hort. *The smaller ciliated-leaved common Holly.* — Leaves thinner and smaller than in the preceding variety.
- ♣ I. A. 10 *recurvum* Hort. (*fig. 181.*) *The recurved-leaved common Holly.*
- ♣ I. A. 11 *serratifolium* Hort. (*fig. 182.*) *The serrated-leaved common Holly.*
- ♣ I. A. 12 *crispum* Hort. *The curled-leaved common Holly.*
- ♣ I. A. 13 *ferox* Hort. *The fierce, or ferociously-spined-leaved common Holly;* Houx-hérissou or Hedgehog Holly, *Fr.* (*fig. 180.*) — The disk of the leaf has its edges rolled back; and a somewhat cylindrical figure is hence given to it; and, as the surface abounds in



prominences and prickles, it has a curious appearance, not unaptly compared to that of a hedgehog. This sort is said, by Bradley and Evelyn, to have been first planted in the Bishop of London's garden, at Fulham, about the end of the seventeenth century, by his gardener, Mr. George London, who is supposed to have introduced it from France. According to Miller, who thought it a distinct species, it reproduces itself from seed.

- ♣ I. A. 14 *crassifolium* Hort. (fig. 178.) *The thick-leaved common Holly.*
- ♣ I. A. 15 *senescens* Sweet. *The aged, or spineless, common Holly.*

B. *Varieties designated from the Colours of the Leaf.*

- ♣ I. A. *variegatum* Hort. *The variegated-leaved common Holly.*—Under the general name of variegated hollies, twenty or thirty varieties, some of them with, and some of them without, popular names, are obtainable in the principal London nurseries. Having examined and compared the different shades of variegation in the plants in the very complete collection of Messrs. Loddiges, we think they may be all included in the following groups:—
- ♣ I. A. 16 *albo-marginatum* Hort. *The white-edged-leaved common Holly.*—Of this variety the subvarieties in Loddiges's arboretum are marked 5, 15, 18, and 24, which have all long and narrow leaves, with edgings of white or pale yellow along their margins; and 4, 6, 7, 12, 17, 22, 23, and 28, which have larger leaves, and a greater breadth of margin variegated; the white or pale yellow forming in some cases one third, or even one half, of the surface of the leaf.
- ♣ I. A. 17 *aureo-marginatum* Hort. *The gold-edged-leaved common Holly.*—The following subvarieties are in Messrs. Loddiges's arboretum. Nos. 19 and 20 with dark yellow margins; and Nos. 1, 2, 8, 9, 10, 13, and 29, with margins of dark and light yellow. Another subdivision of this group consists of plants with broad leaves, in what may be called a transition state from green to variegated, viz., with greenish yellow or very pale green blotches or margins. When such plants become old they are generally very distinctly variegated with yellow. Examples in the Hackney arboretum are Nos. 3, 20, and 21.
- ♣ I. A. 18 *albo-pictum*. Hort. *The white-spotted-leaved common Holly, or Milkmaid Holly.*—This variety has a considerable portion of the centre of the disk of the leaf white, and of a somewhat transparent appearance; the edges of the disk of the leaf being green.

- † I. A. 19 *aurco-pictum* Hort. *The gold-spotted-leaved common Holly.*— The following subvarieties are in Messrs. Loddiges's arboretum. Nos. 11, 14, 16, 26, 27, and 30.
- † I. A. 20 *ferox argenteum* Hort. *The silver-blotched Hedgehog common Holly.*
- † I. A. 21 *ferox aureum* Hort. *The gold-blotched Hedgehog common Holly.*

C. *Varieties designated from the Colour of the Fruit.*

- † I. A. 22 *fructu luteo* Hort. *The yellow-fruited common Holly.*
- † I. A. 23 *fructu albo* Hort. *The white-fruited common Holly.*

Geography. The holly is indigenous in most parts of the middle and south of Europe, in woods and shady places, in free and rather sandy soil; it is also said to be found in Japan and China. The European species does not appear to be a native either of North America or India; but the *Ilex opaca*, which is very extensively distributed in North America, and the *I. dipyræna*, which is common in the Himalaya, so closely resemble *I. Aquifolium*, that they are probably only varieties of it. According to Pallas, the common holly scarcely occurs within the ancient limits of the Russian empire; though frequent on the southern side of Caucasus, where it forms a low branching shrub, about 10 ft. high. In France it is abundant, more particularly in Brittany. In Germany it abounds in many forests, particularly in the southern and middle states; where, when sheltered by lofty trees, it attains the height of 20 ft.; but, in exposed situations, it does not rise higher than 6 ft. or 8 ft. The tree appears to attain a larger size in England than in any other part of Europe. It is very generally distributed over the country, more especially in loamy soils. It abounds more or less in the remains of all aboriginal forests, and perhaps, at present, it prevails nowhere to a greater extent than in the remains of Needwood Forest, in Staffordshire; there are many fine holly trees, also, in the New Forest, in Hampshire. In Scotland it is common in most natural woods, as an undergrowth to the oak, the ash, and the pine. The greatest collection of hollies that we recollect to have seen or heard of, Sang observes, "grew in the pine forest of Blackhall, on the river Dee, about 20 miles above Aberdeen. Many of the trees were very large, and furnished a great quantity of timber, which was sent to London, where it fetched a high price." (*Plant. Kal.*, p. 15.) The holly, Sir T. D. Lauder states, is found in great abundance on the banks of the river Findhorn, in Aberdeenshire, and the trees grow to a very great size. So plentiful were they in the forest of Tarnawa, on its left bank, that for many years the castle of Tarnawa was supplied with no other fuel than billets of holly; and yet the trees are still so numerous, that, in going through the woods (in 1834), no one would suppose that any such destruction had been committed. (*Lauder's Gilpin*, i. p. 194.) In Ireland, the holly is not very common; but about the Lakes of Killarney it attains a large size.

History. The tree has been much admired from the earliest periods; and formerly, when it was customary to enclose and subdivide gardens by hedges, the holly was employed by all those who could afford to procure the plants, and wait for their comparatively slow growth. Evelyn's holly hedge, at Say's Court, Deptford, which was 400 ft. in length, 9 ft. high, and 5 ft. in diameter, has been celebrated in the history of this tree ever since the time of Ray; and other holly hedges, famous in their day, were those of Lord Dacre, at his park in Sussex, and of Sir Matthew Decker, at Richmond. "I have seen hedges," Evelyn observes, "or, if you will, stout walls of holly, 20 feet in height, kept upright; and the gilded sort budded low, and in two or three places one above another, shorn and fashioned into columns and pilasters, architecturally shaped, and at due distance; than which nothing can possibly be more pleasant, the berry adorning the intercolumniations with scarlet festoons, and encarpa." In Scotland, the most celebrated holly hedges were

those of the Earl of Haddington, at Tynningham, and those at Collington House, and at Moredun, near Edinburgh. Some of these hedges are noticed in p. 103.

Properties and Uses. As a hedge plant, the holly makes the most impenetrable and the most durable of all vegetable fences; and it has this great advantage over deciduous-leaved trees and shrubs, that it is seldom liable to be attacked by insects; and, if shorn, the outer surface becomes impenetrable even to birds, who cannot build their nests in it. In these points of view, it is decidedly the best hedge, both for the farmer and the gardener; but, if the faggot wood produced by the hedge is a greater object than the advantages just mentioned, which it is in some parts of England where fuel is scarce, the hawthorn is preferable to the holly, the latter producing but short annual shoots. The objection to the holly, as a hedge plant, is the slowness of its growth; but against this must be set its great durability and the other advantages which it possesses. Besides, by a little extra care in preparing the soil, the holly will make a complete fence as soon as the hawthorn does, under ordinary treatment. Mr. Sang, who may be quoted as the very first authority, observes, "that holly hedges are the best for making durable fences, and afford the greatest degree of shelter, especially during the winter months. No plant endures the shears better than the holly. A hedge of it may be carried to a great height; and, consequently, it is well fitted for situations where strength and shelter are required. It luxuriates most in rich sandy loam, although there are few soils in which it will not grow. After planting, the holly makes but very indifferent progress for a few years; but, after it becomes established in the ground, or about the third or fourth year after planting, no fence whatever will outgrow the holly." (*Plant. Kal.*, p. 357.) When a holly hedge has once become effective as a fence, no other kind whatever can be kept in repair for so many years, at so small an expense. Baudrillart speaks of holly hedges, in France, that are upwards of two centuries old: those at Tynningham were planted about the latter end of the seventeenth century.

The wood of the holly is almost as white as ivory, except in the centre of very old trunks, where it is somewhat brown. It is very hard, with a fine grain, susceptible of a high degree of polish, and is readily stained with black, green, blue, or red. It weighs, when dry, at the rate of 47 lb. 7 oz. per cubic foot. The veins of the wood, and its annual layers, are so small as scarcely to be perceptible. It is applied to a great many purposes, in joinery, cabinet-making, and turnery; in engineering, in mathematical-instrument-making; and it is even used for wood engraving. It would be much more generally used in veneering, in Britain, if it were more common: but large trees are now comparatively rare; or, if they exist, they belong to persons who will not cut them down for their timber. One of the principal uses of the wood, at present, is, when dyed black, to be substituted for ebony, in the handles of metal teapots, &c.: the young shoots and the branches are given to sheep and deer, during winter, in France; and the stronger straight shoots, deprived of their bark, are made into whip handles and walkingsticks.

The bark affords birdlime. As this article may be useful to gardeners, not only for catching birds, but also for preventing snails, slugs, and caterpillars from ascending the stems of plants, we subjoin directions for its manufacture. "Peel a good quantity of the bark of the young shoots about midsummer; fill a vessel with it, and put to it spring water; then boil it till the grey and white bark rises from the green, which will require near 12 hours' boiling; then, taking it off the fire, separate the barks, the water being first drained off. Then lay the green bark on the earth, in some cool vault or cellar, covering it with any sort of green and rank weeds, litter, or mats, to a good thickness. Thus let it continue near a fortnight, by which time, in consequence of fermentation, it will have become a perfect mucilage; then pound it all exceedingly well in a stone mortar, till it be a tough paste, and so very fine, that no part of the bark be discernible. This done, wash it accurately well in some

running stream of water, as long as you perceive the least impurities in it, and so reserve it in some earthen pot to ferment, scumming it as often as anything arises, for four or five days; and, when no more filth comes to the top, change it into a fresh earthen vessel, and prepare it for use, thus:—Take what quantity you please of it, and, in an earthen pipkin, add a third part of capon's fat, or goose-grease, to it, well clarified, or oil of walnuts, which is better; incorporate these on a gentle fire, continually stirring it till it be cold; and thus your composition is finished." (*Hunter's Evelyn*, p. 268.) The use of the grease or oil is, to prevent the preparation from freezing; and also to diminish evaporation when the birdlime is spread out on the barks of trees, or other surfaces, to attract birds or vermin. At present birdlime is manufactured in but few parts of Britain, though in some parts of Cumberland and Westmoreland it is made in small quantities. It is made on a large scale in Italy, and also in Turkey; from which latter country it is imported into England for the use of London bird-catchers, and for other purposes. We recommend gardeners to try it on the stems of trees and shrubs, and on wires and lines stretched round flower-beds, as a protection against hares and rabbits.

Medicinally, a decoction of the bark is given for calming a cough. The berries are purgative, and six or eight of them will occasion violent vomiting; though they are considered as poisonous to men, yet they form the food of some birds, more especially of thrushes. The bark is mucilaginous, emollient, and solvent.

The principal use of the holly in Britain, after all, is as a hedge plant, and as an ornamental shrub, or low tree. In the latter capacity, it is surpassed by no evergreen whatever, whether we look on the plant in its native state, with its deep shining green leaves and coral berries, which remain on the tree for half the year; or in its numerous variegations of the gold or silver leaves, and white, yellow, or coral berries.

Mythological, legendary, and poetical Allusions. The use made of the holly at Christmas, for ornamenting churches and dwelling-houses, is well known; though the origin of the practice is uncertain. The custom of placing evergreens in places of religious worship prevailed before the introduction of Christianity; and several texts of Scripture, particularly in the 40th, 41st, 51st, and 55th chapters of Isaiah, and in the 8th chapter of Nehemiah, have reference to it: but the evergreens originally made use of were branches of the pine, fir, and cedar, and sprigs of box. Holly appears to have been first used for this purpose by the early Christians, at Rome; and was probably adopted for decorating the churches at Christmas, because holly was used in the great festival of the Saturnalia, which occurred about that period, and it was the policy of the early fathers of the church to assimilate the festivals of the Pagans and Christians as closely as possible in their outward forms, to avoid shocking unnecessarily the prejudices of newly made converts. It was customary among the ancient Romans to send boughs of holly, during the Saturnalia, as emblematical of good wishes, with the gifts they presented to their friends at that season; and the holly became thus to be considered as an emblem of peace and good-will. It was for this reason, independently of any wish to conciliate the Pagans, well adapted to be an emblem of the principal festival of a religion which professes, more than any other, to preach peace and good-will to man. Whatever may have been the origin of the practice, it appears to be of very great antiquity; for Bourne, in his *Antiquities of the Common People*, p. 173., cites an edict of the Council of Bracara, canon 73., forbidding Christians to begin to decorate their houses at Christmas with green boughs at the same time as the Pagans; the Saturnalia commencing about a week before Christmas. Dr. Chandler, in his *Travels in Greece*, supposes this custom to be derived from the Druids, who, he says, decorated dwelling-places with evergreens during winter, "that the sylvan spirits might repair to them, and remain unripp'd with frost and cold winds, until a milder season had renewed the foliage of their darling abodes." In England, perhaps the earliest record of this custom is in a carol in praise of the holly, written in the reign of

Henry VI., and preserved in the Harleian MS., No. 5396.; in illustration of which it must be observed, that the ivy, being dedicated to Bacchus, was used as a vintner's sign in winter, and hung outside the door.

- "Nay, Ivy, nay, it shall not be I wys;
Let Holy hafe the maystry, as the maner ys.
Holy stond in the halle, fayre to behold;
Ivy stond without the dore; she ys full sore a cold.
- "Holy and hys mery men they dawnsyn and they syng,
Ivy and hur maydenys they wepyn and they wryng.
Ivy hath a lybe; she laghit with the cold,
So mot they all hafe that wyth Ivy hold.
- "Holy hath berys as red as any Rose,
They foster the hunters, kepe hem from the doo.
Ivy hath berys as black as any slo;
Ther com the oule and ete hym as she goo.
- "Holy hath byrdys, aful fayre flok,
The Nyghtyngale, the Poppyngy, the gaynytl Lavyrok.
Good Ivy! what byrdys ast thou!
Non but the Howlet that 'How! How!'"

Stowe, in his *Survey of London*, published in 1598, says that, in his time, every man's house, the parish churches, the corners of the streets, conduits, market crosses, &c., were decorated with holme (holly), ivy, and bayes, at Christmas. The disciples of Zoroaster believed that the sun never shadows the holly tree; and the followers of that philosopher who still remain in Persia and India, are said to throw water impregnated with holly bark in the face of a child newly born. In the language of flowers, the holly signifies foresight. A great number of curious carols, and other verses, ancient and modern, referring to the use of the holly at Christmas, will be found in Forster's *Percennial Calendar*, p. 727.; and an elegant poem by Southey, alluding to the circumstance of the lower leaves of large plants being spinous, while the upper are entire, is printed in Dr. Johnston's *Flora of Berwick upon Tweed*, vol. i. p. 40.

Soil and Situation. The holly attains the largest size in a rich sandy loam; but it will grow, and even thrive, on almost any soil, provided it is not overcharged with moisture. Cook says, it does best on soil somewhat gravelly; Miller, that it prospers on gravel over chalk; and Boucher, that it refuses not almost any sort of barren ground, hot or cold, and often indicates where coals are to be found; a proof that it will grow both on lime and clay: in short, the holly is found on all soils, except in bogs or marshes. The forest of Needwood, which contains so many fine hollies, is on a free loamy soil, inclining to sand rather than to stiff clay; the largest hollies in the New Forest are on gravelly soil, on a substratum of chalk or clay. The largest hollies in Buckinghamshire, Kent, and Surrey, are in loam on chalk; the hollies at Tynningham are on deep alluvial sand; those in Aberdeenshire, on granitic clay. The holly does not grow at very great elevations in Europe; and it is always found in a most prosperous state when somewhat shaded by deciduous trees, but not overtopped by them. The most favourable situation seems to be a thin scattered wood of oaks, in the intervals of which, as at Needwood and New Forest, the holly grows up, at once sheltered, and partially shaded. At the same time, the holly will grow completely beneath the shade and drip of other trees; for which reason it is equalled as undergrowth by no other evergreen shrub or tree, except the box. The common laurel will also grow under the drip and shade of other trees; but it is more tender than either the box or the holly, and soon becomes naked below.

Propagation and Culture. In the days of Evelyn, it was customary for planters to collect seedlings of trees of different sorts from the woods; and this was more especially the case with the holly, on account of the length of time the seed lies in the ground before it comes up. "Of this noble tree," Evelyn says, "one may take thousands of young plants, four inches long, out of the woods (growing amongst the fallen leaves), and so plant them; but this should be before the cattle begin to crop them, especially sheep, who are greedy of them when tender. Stick them into the ground, in a moist season,

in spring, or early in autumn, especially in the spring; shaded (if it prove too hot and searching) till they begin to shoot of themselves, and, in very sharp weather, and during our eastern etesians, covered with dry straw or haulme; and if any one of them seem to perish, cut it close, and you shall soon see it revive. Of these seedlings, and by this culture, I have raised plants and hedges, full 4 ft. high, in four years. The lustier and bigger the sets are, the better; and, if you can procure such as are a thumb's breadth thick, they will soon furnish into an hedge." (*Hunter's Evelyn*, p. 266.) Seedlings of holly, yew, and other indigenous trees, are still collected occasionally from the woods in country places, by the children of labourers, and sold to the local nurserymen; but the more general practice is, to raise the species from seeds, and the varieties by budding, grafting, or by cuttings.

By Seeds. As the seeds of the holly, like those of the hawthorn, do not come up the first year, to save ground, and the expense of weeding, the berries are commonly buried in the soil, or kept mixed up in a heap of earth for one year: this heap of earth, into which the berries are put as soon as gathered, should be turned over several times in the course of the season, to facilitate the rotting of the pulp and husks. This will generally be effected by the autumn succeeding that in which they were gathered from the tree; and they may then be taken, and separated from the earth with which they were mixed, by sifting, and sown in beds of finely prepared soil, and covered about a quarter of an inch. Thus prepared, when sown in autumn, they will come up the June following. A covering of half-rotten leaves, fronds of fern or spruce fir, or even of litter or straw, placed over the seed-beds, will protect the soil from extreme heat and drought, and will greatly facilitate the progress of the germination. In Scotland and in Ireland, this is seldom found necessary; but in England and in France, the climate being warmer in the beginning of summer, and the air drier, it is found a great advantage. As the holly is apt to suffer from transplanting, it should never be kept in the nursery longer than two years in one place. When the seeds are to be sown as soon as gathered, Boutecher directs that the berries should hang on the trees till December; or, if they could be defended from birds, till February or March. As soon as they are gathered, he says, "throw them into a tub with water, and rub them between your hands till the seeds are divested of their thick glutinous covering; pour off the water, with the light seeds that swim, the mucilage, &c., and spread the sound seeds on a cloth, in a dry airy place, rubbing them often, and giving them a fresh cloth daily till they are quite dry. If this be done in autumn or winter, mix them with sand, and keep them dry till spring; but, if they have been gathered in spring, let them be sown immediately." (*Mart. Mill.*) Bradley suggests a method of forwarding the germination of the seeds of the holly, and other hard seeds, by fermenting them with moist bran; but the difficulty of keeping the temperature such as, while it decomposes the pulp of the berries, shall not destroy their vital principle, seems to render this a very precarious process.

Budding and Grafting. These operations are performed at the usual times, and in the usual manner; but it has been observed by Tschoudi, that cleft-grafting does not succeed nearly so well with the holly as whip-grafting or budding. In England, the stocks budded or grafted on are generally of four or five years' growth; and the grafting is effected in March, and the budding in July.

Cuttings. These are made in autumn, of the ripened summer shoots. They are planted in sandy soil, in a shady border, and covered with hand-glasses; and they generally put forth roots the following spring. The lower branches of the common holly, in Ireland, we are informed, strike as readily by cuttings as those of the common willow, emitting roots from every part of the shoot, as well as from the joints. This facility of rooting in Ireland may be owing to the moisture of the climate of that country; experience proving that the branches of trees and shrubs which are grown nearest the ground, or on the north side of the plant, so as to be kept shaded and moist, always root

easier than those which have been taken from higher parts of the tree, and more exposed to the influence of light and air; the moisture and the shade being the predisposing causes for the production of roots.

After-culture in the Nursery. No plant requires less care than the holly, when it is once established: the species can hardly be said even to need pruning; and the varieties which have been grafted or budded require little more than the removal of shoots from the stock. To fit them for removal, however, whether of a large or small size, they ought to be taken up and replanted every other year.

Final Planting. When the holly is to be planted as a hedge, if it is intended that the growth shall be rapid, the soil ought to be trenched to the depth of 3 ft. or 4 ft. If the subsoil be bad, the most effective mode is to take out a trench, in the direction of the hedge, of 3 ft. or 4 ft. wide, and of the same depth; and to fill up this trench with good surfaces from the adjoining ground. The soil in the trench ought to be raised at least a foot above the adjoining surface, to allow for sinking; and along the middle of this ridge, the hollies might be planted at 1 ft. or 18 in. apart. In some cases, the seeds may be sown on such a ridge; but that mode involves the expense of fencing for a greater number of years than the mode by transplanting. By some, the best mode of planting a holly hedge is said to be, to intermix it with the common thorn, and, as the hollies advance, to cut the thorns out. This may be a convenient mode; but it must be evidently a very slow and uncertain one, and must depend so much upon the constant attention paid, to keep the thorns from overpowering the hollies, and, at the same time, to keep their branches sufficiently intermingled with each other to render the fence effective, that we can by no means recommend it as an eligible practice.

Season for transplanting the Holly. Much has been written in gardening books respecting the proper season for transplanting evergreens; and what is remarkable is, that, while summer and autumn are generally stated to be the proper seasons, the spring, and during mild weather in winter, are the seasons most generally adopted in practice. The principle which justifies the practice is, that all plants whatever, with very few exceptions, are most safely removed when the whole plant is in a comparatively dormant state, and when the weather is temperate, and the air moist and still, rather than dry and in motion. Now, it is known that the greatest degree of torpidity in any plant exists a short time before it begins to grow or push out shoots; consequently, as evergreens begin to grow only a week or two later than deciduous trees of the same climate, the proper time for transplanting them cannot differ much from the proper time for transplanting deciduous trees. The chief difference to be attended to is, the circumstance of evergreen trees being at no time whatever in so completely a dormant state as deciduous ones; and hence, such weather, in the winter, autumn, or spring, must be chosen for removing them, as will least affect their fibrous roots and leaves by evaporation. This is in perfect accordance with the practice of the best gardeners; and it has been laid down as the best mode, founded on experience, by Mr. Mc'Nab, the intelligent curator of the Edinburgh Botanic Garden, and author of a valuable pamphlet, entitled *Hints on the Planting and general Treatment of Hardy Evergreens, &c.*, of which an account will be found in the *Gardener's Magazine*, vol. vii. p. 78.

Culture of the Holly in useful and ornamental Plantations. Holly hedges, according to Miller, should never be clipped, because, when the leaves are cut through the middle, they are rendered unsightly; and the shoots should therefore be cut with a knife close to a leaf. There can be no doubt that this is the most suitable mode for hedges that are to be near the eye: for example, in gardens and pleasure-grounds; but, as this method leaves a rougher exterior surface, and involves a much greater expense, than clipping, it is unsuitable where the object is to prevent birds from building in the hedges, and to maintain effective fences at the least expense. The proper season for clipping would appear to be just after the leaves have attained maturity; because

at that season, in the holly, as in the box, the wound is comparatively obliterated by the healing over produced by the still abundant sap. When it is desired to grow the holly for timber, it should be planted in close plantations, like other forest trees; either with or without nurse trees, according to the situation; and the stems should be deprived of the side branches, when they are under half an inch in diameter, to a certain height, say a fourth of the entire height of the tree, in order to produce a clean trunk.

Statistics. Hollies in ancient Times. Pliny tells us that "Tiburthus built the city of Tibur near three holly trees; over which he had observed the flight of birds that pointed out the spot whereon the gods had fixed for its erection; and that these trees were standing in his own time, and must, therefore, be upwards of 1200 years old. He also tells us that there was a holly tree, then growing near the Vatican, in Rome, on which was fixed a plate of brass, with an inscription engraven in Tuscan letters; and that this tree was older than Rome itself, which must have been more than 800 years." (Book xvi. chap. 44.) This author notices a holly tree in Tusculum, the trunk of which measured 35 ft. in circumference, and which sent out ten branches, of such magnitude, that each might pass for a tree. He says, this single tree alone resembled a small wood. Cole tells us, in his *Paradise of Plants*, that he knew a tree of this kind which grew in an orchard; and the owner, he says, "cut it down, and caused it to be sawed into boards, and made himself thereof a coffin; and, if I mistake not, left enough to make his wife one also. Both the parties were very corpulent; and, therefore, you may imagine the tree could not be small." (*Sylva Florifera*, i. p. 283.) Bradley, in 1726, mentions hollies above 60 ft. high, in the holly walk, near Frencham, in Surrey, in sandy soil. Evelyn mentions some large ones near his own place, at Wooton, in Surrey, in the neighbourhood of which was once a fort called Holmsdale Castle, from, as he supposes, the number of holms, or hollies, which once grew there. The names of Holmsdale, Holmwood, and Holme Castle occur in various parts of Scotland, and are generally supposed to have been applied in consequence of the abundance of hollies at these places at the time the names were given. Hayes mentions a variegated silver holly at Ballygannon, in Ireland, 28 ft. high, with a trunk, 5 ft. in circumference; and another, on Lunisfallen Island, in the Lake of Killarney, with a trunk 15 ft. in circumference, and about the same height before it began to branch out.

Ilex Aquifolium in the Environs of London. At Syon, *I. A. auro-marginatum* 50 ft. high, and *I. A. albo-marginatum* 35 ft. high; at York House, Twickenham, the species 50 years planted, and 40 ft. high; at Mount Grove, Hampstead, 25 ft. high, the diameter of the trunk 16 in., and of the head, 20 ft.; at Ham House, 33 ft. high, diameter of the trunk 21 in., and of the head 31 ft.; in the Fulham Nursery, 30 years planted, and 40 ft. high.

Ilex Aquifolium South of London. In Cornwall, at Port Elliott, 70 years planted, and 40 ft. high, the diameter of the trunk 3 ft. 3 in., and of the head 52 ft. In Devonshire, at Killerton, 33 ft. high; at Endsleigh Cottage, *I. A. auro-marginatum*, 22 years planted, and 21 ft. high; at Kempton, 45 ft. high. In Dorsetshire, at Compton House, 100 years planted and 40 ft. high, diameter of the trunk 2 ft. 2 in. In the Isle of Jersey, in Saunders's Nursery, 10 years planted, and 16 ft. high. In Hampshire, at Alresford, 30 years planted, and 40 ft. high. In Somersetshire, at Nettlecombe, 100 years planted, and 27 ft. high. In Surrey, at Claremont, 80 ft. high (the highest in England), the diameter of the trunk 2 ft. 2 in., and of the head 25 ft., in sandy loam, on gravel, and drawn up among other trees; at Walton on Thames, 40 years planted, and 23 ft. high, the branches spreading over a space 76 ft. in diameter; at Pepper Harrow Park, various trees from 60 ft. to 70 ft. high; at Bagshot Park, 40 ft. high. In Sussex, at Cowdray, 53 ft. high. In Wiltshire, at Wardour Castle, 40 years planted, and 25 ft. high, diameter of the trunk 2 ft. 4 in., and of the head 54 ft.

Ilex Aquifolium North of London. In Berkshire, at Hampstead Marshall, there are various trees from 40 ft. to 50 ft. high, with trunks from 4 ft. to 5 ft. in diameter. In Cheshire, at Kimmel Park, 20 years planted, and 26 ft. high, in sandy loam, on moist clay. In Cumberland, at Ponsonby Hall, many specimens 30 ft. high. In Durham, at Southend, 8 years planted, and 13 ft. high. In Essex, at Hylands, 10 years planted, and 18 ft. high. In Monmouthshire, at Dowlais House, 30 years planted, and 18 ft. high. In Norfolk, at Merton, one 61 ft. high, with a trunk 4 ft. in diameter; and two others nearly as large. In Staffordshire, at Trentham, 26 ft. high. In Rutlandshire, at Belvoir Castle, 7 years planted, and 8 ft. high. In Warwickshire, at Whitley Abbey, 160 years planted, and 43 ft. high. In Worcestershire, at Croome, 35 years planted, and 40 ft. high. In Yorkshire, at Hacksness, 50 years planted, and 30 ft. high; at Grimston, in argillaceous soil, 37 ft. high; and at Cannon Hall, the species 38 ft. high, *I. A. albo-marginatum* 29 ft. high, *I. A. auro-marginatum* 32 ft. high, and *I. A. terox* 19 ft. high.

Ilex Aquifolium in the Environs of Edinburgh. At Hopetoun House, 100 years planted, 44 ft. high, diameter of the trunk 2 ft. 1 in., and of the head 30 ft., on clay; at Craigie Hall, 20 ft. high; at Woodhouse Lee, a hedge, upwards of 100 ft. long, and 30 ft. high; at Cramond House, 20 ft. high; at Moredun, a hedge, planted in the beginning of the eighteenth century, 578 ft. long, 30 ft. high, 9 ft. wide at bottom, and 4 ft. wide at top, annually clipped; at Collinton, 1120 ft. of holly hedges, planted in 1670 and 1780, and varying from 15 ft. to 28 ft. in height, clipped every three years.

Ilex Aquifolium South of Edinburgh. In East Lothian, at Gosford House, 20 ft. high; at Biel, 100 years planted, 37½ ft. high; at Tynningham, 2952 yards of holly hedges, chiefly planted in 1712, from 10 ft. to 25 ft. in height, and from 9 ft. to 13 ft. wide at the base; and single trees, varying in height from 20 ft. to 50 ft. Most of the hedges are regularly clipped in April, and they are carefully protected, by ditches on each side, from the bite of cattle, and more particularly of sheep, which are very fond of the bark, shoots, and young leaves of the holly. In Kirkcudbrightshire, at Bargally, there are several varieties, above 140 years planted, and from 30 ft. to 40 ft. high.

Ilex Aquifolium North of Edinburgh. In Argyllshire, at Toward Castle, various trees, from 25 ft. to 30 ft. high, with trunks from 18 in. to 20 in. in diameter, and that of the heads from 20 ft. to 30 ft., on gravelly loam. In Banffshire, at Gordon Castle, 52 ft. high, the trunk 2 ft. 6 in. in diameter, and the soil a strong loam on a strong clay. (See the dimensions of numerous hollies at Gordon Castle, in *Gard. Mag.*, vol. iii. p. 185.) In Fifehire, at Danbristle Park, 44 ft. high, the diameter of the trunk 25 in., and of the head 18 ft., on strong loam. The trees here, and at Gordon Castle, prove that, if the holly were drawn up in a close plantation, like the larch or pine, it would, like them, produce a clean straight trunk, of a timber-like size, in a moderate space of ground and time. In Perthshire, at Taymouth, 30 ft. high. In Renfrewshire, at Bothwell Castle, 45 years planted, and 46 ft. high, the diameter of the trunk 15 inches, and of the head 38 ft., in heavy loam on moist clay. In Sutherlandshire, at Dunrobin Castle, 43 ft. high, the diameter of the trunk 17 in., and of the head 25 ft., in black heath soil, on gravel.

Ilex Aquifolium in the Environs of Dublin. At Castle Town, 30 ft. high, the trunk 18 in., and the head 30 ft. in diameter; at Cypress Grove, 30 ft. high; at Terenure, 40 years planted, and 30 ft. high, in dry soil, on a calcareous subsoil; in Cullenswood Nursery, *I. A. cræcum*, [?] 12 years planted, and 17 ft. high.

Ilex Aquifolium South of Dublin. In King's County, at Charleville Forest, 40 years planted, and 45 ft. high, diameter of the trunk 32 in., and of the head 28 ft., in brown loam, on gravel. In Munster, at Castle Freke, 32 ft. high.

Ilex Aquifolium North of Dublin. In Louth, at Oriel Temple, the species and several varieties, from 20 ft. to 30 ft. high. In Down, at Ballyleady, 60 years planted, and 34 ft. high. In the Park, at Moira, 25 ft. high. In Antrim, at Belfast, in Mr. Templeton's garden, 15 ft. high.

Ilex Aquifolium in Foreign Countries. In France, in the Jardin des Plantes, 50 years planted, and 30 ft. high; in the Botanic Garden at Toulon, 48 years planted, and 18 ft. high; at Nantes, in the nursery of M. Nerrin, 60 years planted, and 30 ft. high. In Saxony, at Wörlitz, 35 years planted, and 16 ft. high. In Austria, at Brück on the Leytha, 30 years planted, and 12 ft. high. In Prussia, the holly grows wild in a forest 20 miles from Berlin, nevertheless, in the Berlin Botanic Garden, it requires protection during winter; at Sans Souci, 9 years planted, it has attained the height of 8 ft. In Hanover, at Harbecke, 6 years planted, it has attained the height of 3 ft.; in the Botanic Garden at Göttingen, it requires protection during winter. In Denmark, in the Royal Gardens at Copenhagen, it is 3 ft. or 4 ft. high, and requires protection. In Sweden, in the Botanic Garden at Lund, it is 2½ ft. high, and requires protection. In Italy, at Monza, 30 years planted, it is 20 ft. high.

Commercial Statistics. In the London nurseries, two years' seedlings of the species are 7s. a thousand; transplanted plants of 3 and 4 years' growth, from 8s. to 10s. a thousand; variegated hollies, in sorts, one and two years planted, from 50s. to 75s. a hundred. At Bollwyller, the species, of 3 or 4 years' growth, is 1 franc a plant, and the different varieties 3 francs each. At New York, the species is 50 cents a plant, and the different varieties, which, in that part of America, require protection during winter, are 1 dollar each.

2. *I. (A.) BALEARICA* Desf. The Minorca Holly.

Identification. Desf. Arb., 2. p. 262.; Don's Mill., 2. p. 17.

Synonymes. *I. Aquifolium* var. δ Lam. Dict., 3. p. 143.; *I. macroreus* Willd. Enum. Suppl., 8. according to Link.

Engraving. Our fig. 183.

Spec. Char., &c. Leaves ovate, acute, flat, shining, entire, or spiny-toothed. Umbels axillary, few-flowered, short. (*Don's Mill.*, ii. p. 17.) A very distinct variety of the common holly, readily distinguished at sight, by its yellowish green leaves, which are sharply acuminate, but very slightly waved at the edges, and with few prickles. As it is considered by some authors as a species, and has very much the appearance of one, we have thought it best to keep it apart. It is propagated by budding or grafting on the common holly. There were formerly large plants of this species in the Mile End Nursery. Plants, in the London nurseries, are 5s. each. At Bollwyller and New York it is a green-house plant.



183

3. *I. OPA'CA* Ait. The opaque-leaved, or American Holly.

Identification. Ait. Hort. Kew., 1. p. 177.; Dec. Prod., 2. p. 14.; Don's Mill., 2. p. 17.

Synonymes. *Agrifolium vulgare* Clayt. Flor. Virgin.; *Ilex Aquifolium Gronov.* and *Walt. Fl. Car.* 241.

Engravings. E. of Pl., No. 1824.; and the plate of the species in our Second Volume.

Spec. Char., &c. Leaves ovate, flat, coriaceous, acute, toothed in a scalloped manner, spiny, and glabrous, but not glossy. Flowers scattered, at the base of only those branches that are a year old. Teeth of the calyx acute. Sexes diœcious. (*Dec. Prod.*, ii. p. 14.) A beautiful evergreen tree, a native of North America, from Canada to Carolina, sometimes, according to Pursh, growing to the height of 80 ft., with a trunk 4 ft. in diameter. Introduced in 1744. The flowers are white, and produced in May and June, and the berries are scarlet, round, and handsome, remaining on all the winter. According to Rafinesque, in the northern parts of North America this species forms a bush under 10 ft. in height; its medium height, in favourable situations, being about 40 ft. This species was formerly supposed to be only a variety of *I. Aquifolium*. In America, it is applied to all the uses which the common holly is in Europe. It forms hedges; is an

ornamental tree or shrub in gardens; is employed for making birdlime; and the wood is used in turnery and cabinet-making. It is propagated in the same manner as the common holly. There is a plant of this species in the garden at Walton House 25 ft. high; a large one at Syon; and many fine plants at White Knights. Plants, in London, are 1s. 6d. each; at New York, 40 cents, and seeds 1 dollar a quart.

Varieties. There are none in the British gardens; but Rafinesque mentions *I. o.* 2 *macrodon*, with remote long teeth; *I. o.* 3 *latifolia*, with broad ovate leaves, rounded at the base, and small teeth; *I. o.* 4 *acuminata*, with narrow and very sharp leaves; and *I. o.* 5 *globosa*, a small plant, with a globose foliage. These names are not in Prince's *Catalogue*; but we hope some collector will procure them from their native habitats, and send them to England.

■ 4. *I. (O.) LAXIFLOÏRA* Lam. The loose-flowered Holly.

Identification. Lam Dict., 3. p. 147.; Dec. Prod., 2. p. 14.; Don's Mill., 2. p. 17.

Synonyms. A variety of *I. opaca*, according to Nuttal, Dec.; *I. Aquifolium bæcis flavis* Walt Fl. Carol., 241.

Spec. Char., &c. Leaves ovate, sinuately toothed, spiny, coriaceous, glabrous. Stipules awl-shaped. Peduncles loosely branched, bearing many flowers, and placed in a scattered manner above the axils of the leaves. Teeth of the calyx acute. Fruit yellow. (Dec. Prod., ii. p. 14.) Described by Pursh as an evergreen shrub, of lower growth than *I. opaca*; found in Carolina, in shady sandy woods, with whitish flowers, and yellowish red berries. It produces its flowers in May and June, and was introduced into England in 1811. We have not seen this sort, but think it, in all probability, only a variety. Seeds of it are advertised in Mr. Charlwood's *Catalogue* at 4s. a quart.

B. *Leaves toothed, serrated, or crenate, but not spiny.*

■ 5. *I. CASSINE* Ait. The Cassine-like, or broad-leaved Dahoon, Holly.

Identification. Ait. Hort. Kew., p. 170.; Dec. Prod., 2. p. 14.; Don's Mill., 2. p. 17.

Synonyms. *Aquifolium carolinense* Catesb. Car., 1. t. 31.; *I. caroliniana* Mill. Dict., No. 3.; *I. cassinoides* Link. Enum., 1. p. 148.; *I. Dahoon* Walt. Fl. Car., 241.; the Cassina of the American Indians, Rafin.

Engravings. Catesb. Car., 1. t. 31.; E. of Pl., No. 1828.

Spec. Char., &c. Leaves ovate-lanceolate, sharply sawed, flat; the midribs, petioles, and branchlets glabrous; the flowers upon lateral corymbosely branched peduncles. (Dec. Prod., ii. p. 14.) An evergreen low tree, from 8 ft. to 12 ft. in height; a native of Lower Carolina and Florida, in shady swamps; and introduced into England in 1700. The flowers are small, and of a yellowish white; they are produced in August, and are succeeded by round red berries rather smaller than those of the common holly. The berries continue on the trees the most part of the winter, untouched by birds; and, being of a bright red, and large in proportion to the leaves, which are about the size of those of the common arbutus, they make a fine appearance, both in their native country and in England. The leaves and young shoots of this species are used by the Indians for the same purposes as those of *I. vomitoria* and *I. Dahoon*. This species is not unfrequent in British collections: there is a specimen of it, 10 ft. high, in the arboretum of Messrs. Loddiges, and a small one in the garden of the Horticultural Society. It is commonly propagated by seeds; but it will also strike by cuttings, or it may be grafted on the common holly. Plants, in the London nurseries, cost 2s. 6d. each; at New York, 1 dollar, and seeds 2 dollars a quart.

184



Variety.

■ *I. C.* 2 *angustifolia* (fig. 184.), with oblong-lanceolate subentire leaves, is mentioned in the *Nouvcau Du Hamet*.

■ 6. *I. ANGUSTIFOLIA* Willd. The narrow-leaved Holly.

Identification. Willd. Enum., 1. p. 172.; Dec. Prod., 2. p. 14.; Don's Mill., 2. p. 17.

Synonyms. *I. myrtifolia* Walt. Carol., 241., *N. Duh.*, and *Lodd. Cat.*; *I. rosmarinifolia* Lam. Ill., 1. p. 356.

Engravings. N. Duh., 1. t. 4.; and our fig. 185.

Spec. Char., &c. Leaves linear-lanceolate, sawed at the tip, rather revolute in the margin; the midrib, petiole, and branchlets glabrous. Flowers in stalked lateral cymes. (*Dec. Prod.*, ii. p. 14.) An evergreen shrub, from 6 ft. to 10 ft. high, found in deep swamps from Virginia to Georgia, and introduced in 1806. The flowers are white, and appear in June; the berries are globular and red. A very handsome species, but not very common. There are plants of it at Messrs. Loddiges, and in the London Horticultural Society's Garden, under the name of *I. myrtifolia*.

Variety.

- ♣ *I. a. 2 ligustrifolia* Ph., with oblong, ovate, entire leaves, is given by Pursh, who doubts whether it may not be a distinct species.

† *I. I. VOMITO'RIA* Ait. The emetic Holly, or South Sea Tea.

Identification. Ait. Hort. Kew., 1. p. 278.; Dec. Prod., 2. p. 14.; Don's Mill., 2. p. 17.

Synonyms. *I. Cassine vera* Walt. *Carol.*, 241.; *I. ligustrina* Jacq. *Coll.*, 4. p. 105., *Icon. Rar.*, t. 310., *Wendl. Hort.*, t. 31.; *Cassine Peragua* Mill. *Icon.*, t. 83. f. 2.; *I. Cassina* Michx. *Fl.*, 1. p. 229.; *I. religiosa* Bart. *Fl. Virg.*, 69.; *I. floridana* Lam. *Ill.*, No. 1731.; *Houx apalachine* Fr.; true Cassine, Cassena, *Floridan*; the Yapon, *Virginian*; the evergreen Cassena, or Cassioberry Bush, *Eng.*

Engravings. Jacq. *Icon. Rar.*, t. 310.; *Wendl. Hort.*, t. 31.; *Mill. Fig.*, t. 83. f. 2.; and our *fig.* 186.

Spec. Char., &c. Leaves oblong or elliptic, obtuse at both ends, crenately sawed, and, with the branchlets, glabrous. Flowers in subsessile lateral umbels. (*Dec. Prod.*, ii. p. 14.) An elegant evergreen tree, a native of Florida, Carolina, and Virginia, in moist shady places, growing to the height of 12 ft. or 15 ft., and introduced in 1700. The flowers, which are whitish, are produced in June; and the berries, which resemble in colour those of the common holly, remain on the tree all the winter. It was cultivated by Miller, and in several other gardens in the neighbourhood of London, till the severe winter of 1789, when most of the plants of it were destroyed. Other plants were afterwards raised from seed, and they have ever since resisted the cold of ordinary winters without covering. In the first edition of *Du Hamel*, it is stated, that this species had been a long time cultivated by the Chevalier Jansen, in his garden at the Barrière Chaillot, at Paris. Rafinesque states that the true cassena is reckoned a holy plant by many of the southern tribes of American Indians, being used, during their religious rites and solemn councils, to clear the stomach and the head. Women are forbidden to use it. For these purposes the leaves and young shoots are collected with care, and, when dried, form an article of trade among the tribes. They often parch or scorch slightly the leaves before using them. They are inodorous, the taste is sub-aromatic and fervid, and they are useful in stomach fevers, diabetes, small-pox, &c., as a mild emetic; but the Indians' *black drink* is a strong decoction of them, and a violent, though harmless, vomitive. In North Carolina, the inhabitants of the sea-side swamps, having no good water to drink, purify it, by boiling it with a little cassena (perhaps *Viburnum cassinoides*), and use it constantly warm, as the Chinese do their daily tea. *I. Daboón* and *I. Cassine* are used as substitutes for the cassena; and many other shrubs appear to be used indiscriminately for making the black drink: for example, the *Cassine ramulosa* of the *Flora of Louisiana*. (*Raf. Med. Flor.*, i. p. 9.) The use made of the leaves in Carolina and Florida, by the native Indians, has given rise to the opinion that this species was the Paragay tea mentioned in Martyn's *Miller*, on



the authority of M. Frezier: but the species which produces that article is the *I. paragnariensis* Lam., which will be hereafter noticed. *I. vomitoria* is not very common in British collections; but there are plants of it in Loddiges's arboretum, and in the garden of the London Horticultural Society. Price, at New York, 1 dollar a plant, and seeds 2 dollars a quart.

C. *Leaves quite entire, or nearly so.*

† 8. *I. CANARIENSIS* Poir. The Canary Island Holly.

Identification. Poir. Suppl., 3. p. 67; Dec. Prod., 2. p. 14.; Don's Mill., 2. p. 19.

Spec. Char., &c. Leaves ovate-lanceolate, flat, rather acute, entire, glossy. Flowers in axillary umbels, few in an umbel. Peduncle longer than the petioles. Fruit black. (*Dec. Prod.*, ii. p. 14.) Flowers white, truly diœcious. (*Don's Mill.*, ii. p. 19.) An evergreen tree, a native of the Canary Islands, introduced in 1820. The fruit of this species is said to be black. We have not seen the plant.

‡ 9. *I. DAHOON* Wall. The Dahoon Holly.

Identification. Walt. Fl. Carol., 241.; Dec. Prod., 2. p. 14.; Don's Mill., 2. p. 19.

Synonyme. *I. Cassine* Willd. Hort. Berl., 1. t. 31.

Engraving. Willd. Hort. Berlin., t. 31., under the name of *I. Cassine*.

Spec. Char., &c. Leaves lanceolately elliptical, nearly entire, almost revolute in the margin; the midrib, petiole, and branchlets villous. Flowers disposed in corymbose panicles, that are upon lateral and terminal peduncles. (*Dec. Prod.*, ii. p. 14.) A beautiful evergreen shrub or low tree, found in open swamps from Carolina to Florida, and introduced in 1726. In British gardens, it grows to the height of 6 ft. or 8 ft., producing its white flowers in May and June, which are succeeded by berries, which become red in September. The leaves of this species are very numerous, and resemble those of *Laurus Borbonia*. In America, as already noticed under No. 7., they are used in the same manner as *Vlex vomitoria*. The species is scarce in British gardens, and seldom ripens fruit. It is most commonly kept in green-houses or pits; but there is a plant in the open air, in the Mile End Nursery, which was 20 ft. high, with a head 30 ft. in diameter. It had stood there many years, without the slightest protection. Plants, in London, are 2s. 6d. each, and seeds 6s. a quart; at Bollwyller, where it is a green-house plant, 3 francs each; at New York, where it requires protection during winter, 1 dollar.

Variety.

- ‡ I. D. 2 *laurifolia* Nutt. has leaves large, elliptical, acutish, and pedicels elongated, and usually 3-flowered. It is a native of Eastern Florida, and almost evergreen.

App. i. *Hardy Species of Vlex not yet introduced.*

Vlex odorata Hamilt. in D. Don's *Prod. Fl. Nep.*, p. 189., is a tree, a native of Nepal, with sweet-scented flowers, which would be a very desirable addition to the species cultivated in British gardens. *I. cuneifolia* Lin. Spec., 181., is a native of North America, of which very little is known; and there is a variety of it (*I. c. bonariensis*, said to be a native of Buenos Ayres) which grows to the height of 10 ft. *I. ligustrifolia* G. Don, the *I. angustifolia* of Nuttall (*Gen. Amer.*, i. p. 109.), is said to be an evergreen shrub of Virginia and Georgia; and very probably is the same as *I. angustifolia* of Willd. No. 6. *I. nepalensis* Spreng. (the *I. elliptica* of D. Don) is a Nepal shrub, growing to the height of 8 ft. As all these species are evergreens, they would form a most desirable addition to our woody plants of that kind, more especially the *I. odorata*.

App. ii. *Species of Vlex which may probably be found half-hardy.*

I. dipyræna Wall. is an evergreen tree or shrub of Nepal and Chinese Tartary, growing to the height of 12 ft., and bearing, according to Mr. Royle, a close resemblance to the common holly, especially when covered with its clusters of scarlet berries in November and December. *I. excelsa* Wall. and *I. serrata* Royle are both lofty Nepal species, certainly half-hardy, and probably quite hardy. (*Illustr.*, p. 175.) *I. Perado* Ait., the *I. maderensis* of Lam., (*fig. 187.*) is a low tree of Madeira, common in our green-houses; but, according to the *Nouveau Du Hamel*, it is much harder than is generally imagined, and will stand the open air as well as the common myrtle. There is a plant of it grafted on the common holly, in the garden of the Horticultural Society, which has stood out for several winters as a standard, in the garden, without the slightest protection. *I. chinensis* Sims (*Bot. Mag.*, 2043., and our *fig. 188.*) is an evergreen tree, about 20 ft. high, from China, introduced in 1814. *I. heterophylla* G. Don is a tree of 30 ft. high, from Japan, not yet introduced, and considered by some as only a variety of the common holly. *I. macrophylla* is a Japan tree. *I. elliptica* H. B. et Kunth is a native of Peru; and also *I. scopulorum* and *I. rupticola* of the same authors: the two latter are trees; and, if they could be made to endure the open air in Britain, would be most desirable additions. *I. Paltoria Pers.* is an evergreen shrub, a native of Peru or New Granada, on the highest mountains; and, in all probability, is quite hardy. *I. emarginata* Thunb. and *I. crenata* Thunb. are natives of Japan. *I. serrata* Thunb. and *I. latifolia* Thunb. are also natives of Japan: the latter is a tree growing to the height of 20 ft. *I. myricoides* Thunb. et Kunth is a native of New Granada,

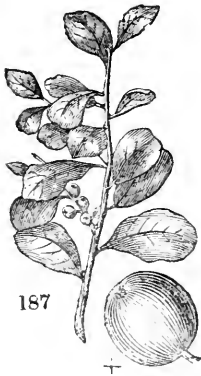

on mountains. 1. *asiatica* Lin. Spec., 710, is a native of the East Indies. 1. *integra* Thunb. and 1. *rotunda* Thunb. are Japan shrubs. 1. *bumelioides* H. B. et Kunth is a tree of Peru. A number of these species are introduced, and occasionally to be found in our green-houses; and the others, if they could be procured, would doubtless thrive in the open air in the warmest parts of Devonshire and Cornwall, and, perhaps, at least half of them in the neighbourhood of London. 1. *paraguariensis* Lamb. Pin., vol. 2., App., t. 2., and our fig. 189., though commonly treated as a stove plant, might possibly succeed in the warmest parts of Devonshire, against a wall, as well as the orange tree. This shrub or tree affords what is called the Paraguay tea, from which the Jesuits of Paraguay derive a large revenue. The leaves are used in Paraguay, La Plata, Chili, Peru, and Quito, by all classes of persons, and at all hours of the day, by infusion in a pot, called *mate*, from the spout of which the tea is drunk, with or without a little sugar or lemon juice. The Creoles drink the infusion at every meal, and never eat until they have taken some of it. If the water is suffered to remain long on the leaves, the decoction becomes as black as ink. The pipe to the *mate*, or teapot, called a *bambilla*, is perforated with holes at the top, to prevent swallowing the pulverised herb, which swims on the surface. The whole party is supplied by handing the *mate* and pipe from one to another, filling up the *mate* with hot water as fast as it is drunk out. The leaves, when green, taste somewhat like mallow leaves: they are prepared for use by being parched, and almost pulverised; after which they are packed up for sale. The aromatic bitterness which the herb possesses when first prepared is partly dissipated by carriage. The principal harvest of the herb is made in the eastern part of Paraguay, and about the mountains of Maracaja; but it is also cultivated in the marshy valleys which intervene between the hills. The people boast of innumerable qualities which this herb possesses: it is certainly aperient and diuretic; but the other qualities attributed to it are rather doubtful. Like opium, it gives sleep to the restless, and spirit to the torpid; and, like that drug, when once a habit is contracted of using it, it is difficult to leave it off; and the effect of it on the constitution is similar to that produced by the immoderate use of spirituous liquor. (*Don's Mill.*, ii. p. 18.; and *Mag. Nat. Hist.*, vol. v. p. 8. and p. 9.) Plants of this species were introduced into England in 1828, and are to be found in one or two collections.

GENUS III.



PRINOS L. THE PRINOS, or WINTER BERRY. *Lin. Syst.* Hexándria Monogýnia, or Polygámia Diœ'cia.

Identification. Lin. Gen., No. 461.; Dec. Prod., 2. p. 16.; Don's Mill., 2. p. 20.

Synonymes. *Agéria Adams. Fam.*, 2. p. 166.; *Apalanche, Fr.*; *Winterbeere, Ger.*

Derivation. From *prinos*, the Greek name for the holly, which the present genus much resembles; or, according to others, from *prion*, a saw, on account of the serrated leaves of the species. The species are deciduous or evergreen shrubs, natives of North America, from 2 ft. to 8 ft. in height, forming compact upright bushes, densely clothed with foliage.

§ i. *Prinöides* Dec.



Sectional Characteristic. Flowers usually 4—5-cleft. (*Dec. Prod.*, ii. p. 16.)

☉ 1. *P. DECIDUUS* Dec. The deciduous Winter Berry.

Identification. Dec. Prod., 2. p. 16.; Dec. Prod., 2. p. 17.; Don's Mill., 2. p. 20.

Synonymes. *Flex prinöides Ait. Hort. Kew.*, 2. p. 278.; *Flex decidua Walt. Fl. Carol.*, 241.

Spec. Char., &c. Leaves deciduous, elliptic-lanceolate, tapered to the petiole, shallowly sawed; the midrib villous beneath; the peduncles axillary; those

of the male flowers several together ; of the female ones, singly. Berries red. (*Dec. Prod.*, ii. p. 16.) A deciduous shrub, growing to the height of 4 ft. ; a native of North America, from Virginia to Georgia, on rocky shady banks of rivers ; and introduced in 1736. It produces its white flowers in June and July, which are succeeded by large crimson berries. Plants of the species are in Loddiges's Nursery, under the name of *I. prinoides*.

Variety. *P. d. 2 æstivâlis*, *Ilex æstivâlis Lam.* The adult leaves glabrous on both surfaces. (*Dec. Prod.*, ii. p. 17.)

❖ 2. *P. AMBIGUUS Michx.* The ambiguous Winter Berry.

Identification. Michx. Fl. Bor. Amer., 2. p. 236. ; *Dec. Prod.*, 2. p. 17. ; Don's Mill., 2. p. 20.
Synonymes. *Cassine caroliniana Walt. Fl. Carol.*, p. 242.
Engravings. Wats. Dend. Brit., t. 29. ; and our fig. 190.

Spec. Char., &c. Leaves deciduous, oval, acuminate to both ends ; both adult ones and young ones glabrous in every part. Peduncles of the male flowers crowded together in the lower parts of the branchlets ; of the female ones, singly. (*Dec. Prod.*, ii. p. 17.) A deciduous shrub, found in sandy wet woods, and on the borders of swamps, from New Jersey to Carolina ; growing to the height of 4 ft. or 5 ft., and producing its white flowers from June to August. Introduced in 1812. The leaves are subimbricate-serrated, acute at the apex, and the berries small, round, smooth, and red. There is a handsome plant of this species in the arboretum of Messrs. Loddiges, which, in 1835, was 5 ft. high. It is of easy culture in any free soil, either by seeds, cuttings, or layers. Plants, in London, are 1s. 6d. each ; at New York, 37½ cents each.



§ ii. *Ageria Dec.*



Sectional Characteristics. Flowers usually 6-cleft. Leaves deciduous. (*Dec. Prod.*, ii. p. 17.)

❖ 3. *P. VERTICILLATUS L.* The whorled Winter Berry.

Identification. Lin. Spec., 471. ; *Dec. Prod.*, 2. p. 17. ; Don's Mill., 2. p. 20.
Synonymes. *P. padifolius Willd. Enum.*, p. 394. ; *P. Gronovii Michx. Fl. Bor. Amer.*, 2. p. 236. ; *P. confertus Mench* ; *P. prunifolius Lodd. Cat.*
Engravings. Wats. Dend. Brit., t. 30. ; Duh. Arb., 1. t. 23. ; and our fig. 191.

Spec. Char., &c. Leaves deciduous, oval, acuminate, sawed, pubescent beneath. Male flowers in axillary umbel-shaped fascicles ; the female ones aggregate ; the flowers of both sexes 6-parted. (*Dec. Prod.*, ii. p. 17.) A deciduous shrub, growing to the height of 8 ft. ; a native of North America, from Canada to Virginia, in wet woods, and on the banks of ditches. Introduced in 1736. The flowers are white, and are produced from June to August. The berries are red or crimson, turning purplish when ripe. There are two handsome plants of this species in Loddiges's arboretum, 7 ft. high, one of which is under the name of *P. prunifolius*. Plants, in the London nurseries, are 1s. 6d. each ; at Bollwyller, 1 franc 50 cents ; at New York, 25 cents, and seeds 50 cents a quart.



❖ 4. *P. DU'BIUS G. Don.* The doubtful Winter Berry.

Synonymes. *P. ambiguus Pursh Fl. Amer. Sept.*, 1. p. 220.

Spec. Char., &c. Leaves deciduous, oval, acuminate at both ends, mucronately serrated, pubescent beneath. Flowers, 4—5-cleft ; male ones crowded at the bottom of the branches ; female ones

solitary. Berries red, larger than those of *P. verticillatus*. (*Don's Mill.*, ii. p. 20.) A deciduous shrub, or low tree, growing to the height of 12 ft., in sandy woods, and on the borders of swamps, from New Jersey to Carolina; introduced in 1736; producing its white flowers in July and August, which are succeeded by red berries, larger than those of *P. verticillatus*.

5. *P. LEVIGATUS* Pursh. The smooth-leaved Winter Berry.

Identification. Pursh Fl. Sept. Amer., 1. p. 220.; Dec. Prod., 2. p. 17.; Don's Mill., 2. p. 20.
Engravings. Wats. Dend. Brit., t. 28.; and our fig. 192.

Spec. Char., &c. Leaves deciduous, lanceolate, sawed, the teeth directed forwards, acuminate, glabrous on both surfaces, except on the nerves beneath, where they are slightly pubescent; upper surface glossy. Flowers 6-cleft; the male ones scattered; the female ones axillary, solitary, almost sessile. (*Dec. Prod.*, ii. p. 17.) A deciduous shrub, growing to the height of 8 ft. on the Alleghany Mountains, from New York to Virginia; introduced in 1812. The flowers are white; and the berries large, and of a dark red colour. The plant of this species in Loddiges's arboretum was 4 ft. high in 1835.



6. *P. LANCEOLATUS* Pursh. The lanceolate-leaved Winter Berry.

Identification. Pursh. Fl. Sept. Amer., 2. p. 27.; Dec. Prod., 2. p. 17.; Don's Mill., 2. p. 20.

Spec. Char., &c. Leaves deciduous, lanceolate, remotely and very slightly serrulate, smooth on both surfaces. Male flowers aggregate, triandrous; female ones mostly in pairs, peduncled, and 6-cleft. (*Dec. Prod.*, ii. p. 17.) A deciduous shrub, growing to the height of 8 ft.; a native of the lower districts of Carolina and Georgia; introduced in 1811. The flowers are white; and the berries are small, and of a scarlet colour. The plant in Loddiges's arboretum is 8 ft. high.

§ iii. *Winteria* Moench.



Derivation. Probably from the name of some botanist.

Sectional Characteristics. Flowers, for the most part, 6-cleft. Leaves permanent. (*Dec. Prod.*, ii. p. 17.)

7. *P. GLABER* L. The glabrous Winter Berry.

Identification. Lin. Spec., 471; Dec. Prod., 2. p. 17.; Don's Mill., 2. p. 20.
Engraving. The figure under this name in Wats. Dend., t. 27., is that of *P. coriaceous* Pursh.

Spec. Char., &c. Evergreen. Leaves lanceolate, with wedge-shaped bases, coriaceous, glabrous, glossy, somewhat toothed at the tip. Flowers mostly three on an axillary peduncle that is usually solitary. Fruit black. (*Dec. Prod.*, ii. p. 17.) An evergreen shrub, growing to the height of 3 ft. or 4 ft., in sandy shady woods, from Canada to Florida; introduced in 1759, and producing its small white flowers in July and August. The colour of the berries in this species is black, and in Jersey they are called ink berries. It forms a very handsome shrub, which, in Loddiges's arboretum has attained the height of 4 ft., with a regular ovate shape, densely clothed with shining foliage. Plants, in the London nurseries, are 2s. 6d. each; at Bollwyller, 2 francs; and at New York, 25 cents, and seeds 1 dollar a quart.

8. *P. ATOMARIUS* Nutt. The atom-bearing Winter Berry.

Identification. Nutt. Gen. Amer., 1. p. 213.; Dec. Prod., 2. p. 17.; Don's Mill., 2. p. 20.

Spec. Char., &c. Evergreen. Leaf oval, with the base wedge-shaped and the tip acute, and somewhat sawed, coriaceous, bearing on the under surface minute excrescences; whence the specific

name. Younger branches rather clammy. Flowers solitary on lateral peduncles. (*Dec. Prod.*, ii. p. 17.) An undershrub, growing to the height of 2 ft., in woods, and on the banks of rivers in Georgia; producing its white flowers in July and August, which are succeeded by dark-coloured berries. Introduced in 1820; but we have never seen it in British gardens.

■ 9. *P. CORIACEUS* Pursh. The coriaceous-leaved Winter Berry.

Identification. Pursh Fl. Sept. Amer., 1. p. 221.; *Dec. Prod.*, 2. p. 17.; Don's Mill., 2. p. 21.

Synonymes. *P. glaber* Wats.

Engraving. Wats. Dend. Brit., t. 27., under the name of *P. glaber*.

Spec. Char., &c. Evergreen. Leaf lanceolate, with a wedge-shaped base, coriaceous, glabrous, glossy, entire. Flowers in short, sessile, axillary corymbs, many in a corymb. (*Dec. Prod.*, ii. p. 17.) A handsome, tall, evergreen shrub, having the general aspect of *Ilex Dahoën*; found in sandy woods near the banks of rivers in Georgia, and introduced in 1820.

Varieties. This species varies, with leaves broader, obovate-lanceolate, and acuminate; and narrower, lanceolate, and acute. (*Dec. Prod.*, ii. p. 17.)

App. i. Other Species of *Prinos* hardy or half-hardy.

P. dioicus Vahl is a native of the Island of Montserrat, and considered as hardy, though not yet introduced. *P. nitidus* Vahl is also a native of Montserrat, and is supposed to require a green-house. There are two stove species described by Swartz natives of the Caribbee Islands, which are trees growing from 20 ft. to 30 ft. high. They are found on mountains in their native countries; and hence may, probably, be hardy enough to be kept in British green-houses, though it is customary to consider natives of the West India Islands as stove plants, whether they are natives of the hills or of the plains.

CHAP. XXXV.

OF THE HARDY LIGNEOUS PLANTS OF THE ORDER RHAMNACEÆ.

DISTINCTIVE Characteristics. Calyx 4—5-cleft; æstivation valvate. Corolla of 4—5 petals; in some absent. Petals cucullate, or convolute, inserted into the orifice of the calyx. Stamens 4—5, opposite the petals, perigynous. Ovary superior, or half-superior, 2-, 3-, or 4-celled, surrounded by a fleshy disk. Ovules one in a cell, erect, as are the seeds. Fruit fleshy and indehiscent or dry, and separating into 3 divisions. Trees or shrubs, often spiny, and generally deciduous. Leaves simple, alternate, very seldom opposite, with minute stipules. Flowers axillary or terminal. (*Lindl. Introd. to N. S.*) The species are natives of Europe or North America, and some of them of India; they are ornamental in British gardens and shrubberies, chiefly from the variety of their foliage, and from their berries; but some of them, as *Ceanothus*, from their flowers. They are all of easy culture. The genera containing hardy ligneous plants are six; which are characterised as follows:—

ZIZYPHUS Tourn. Calyx spreading, 5-cleft; its upper part separating all round from the lower, in the manner as if cut from it; the lower persistent, situated under the fruit, and adhering to it more or less. Petals 5, upon a glandular disk that is adnate to the calyx. Stamens inserted in front of the petals. Styles 2—3, simple. Fruit an ovoid drupe; the nut 2-celled, rarely 1—3-celled. Seed suborbicular, compressed. Shrubs or small trees. Leaves alternate, 3-nerved. Stipules spinescent. Flowers axillary. Drupes mucilaginous and eatable. (*Dec. Prod.*, ii. p. 19.) The species are deciduous shrubs, natives of Europe or Asia, one of them bearing eatable fruit.

PALMIURUS Tourn. The flower like that of *Zizyphus*, except as follows. Styles 3. Fruit dry, indehiscent, orbicular, girded with a broad membranaceous wing, 3-celled. Seed ovate. The habit that of *Zizyphus*. (*Dec. Prod.*, ii. p. 22.) The species are deciduous shrubs or low trees, natives of Europe, or Asia, and highly ornamental in gardens, from their shining leaves, which are nerved; and their abundance of rich greenish yellow flowers, which are succeeded by fruit of rather a singular form.

They are easily propagated by seeds, which they produce, in Britain, in abundance.

BERCHEMIA Necker. Calyx 5-parted, the segments deciduous, the remaining portion persistent, situate under the fruit, and adhering to it more or less. Petals 5, scale-shaped. Stamens inserted lower than the petals. Style 1. Stigmas 2. Fruit an oblong dry drupe; the nut 2-celled. A shrub, without spines, somewhat twining. Often, by defect, the sexes are dioecious, and the fruit 1-seeded. (*Dec. Prod.*, ii. p. 22.) The only hardy species is a twining deciduous shrub, a native of Carolina.

RHAMNUS Lam. Calyx 4—5-cleft; often, with the upper part, after the flowering, separating from the lower all round, in the manner as if cut, and the lower part persistent, situate beneath the fruit, and cohering with it. Petals, in some, absent. Stamens inserted in front of the petals. Style 2—4-cleft. Fruit nearly dry, or berried. Cells 2—4; those in the nearly dry fruits separable, and 1-seeded, or very rarely 2-seeded. Seed oblong, having on the outer side a deep furrow, that is broadest at the base. Shrubs or small trees, with the tips of the branches becoming spines, in some instances. The leaves feather-nerved. The stipules never converted into a prickle. Flowers often unisexual. Fruit not eatable. (*Dec. Prod.*, ii. p. 23.) The species are evergreen, subevergreen, and deciduous shrubs, chiefly natives of Europe, but some of them of North America and Asia.

COLLETTIA Comm. Calyx pitcher-shaped, 5-cleft, its base scarcely adhering to the ovary, which it surrounds. Not any corolla. Stamens 5, situated between the lobes of the calyx: anthers with a tendency to be 1-celled, kidney-shaped, opening by a horseshoe-shaped furrow. Style ending in 3 teeth. Fruit a 3-celled capsule, surrounded by the base of the calyx. Shrubs. Branches spiny. Leaves small, mostly opposite. (*Dec. Prod.*, ii. p. 28; and *Don's Mill.*) The species are spinous shrubs, with few small leaves, natives of Peru or Chili, and interesting by their peculiarity of appearance, and their flowers.

CEANOTHUS L. Calyx 5-cleft, bell-shaped; after the flowering, the upper part separates from the lower part all round, in the manner as if cut; the lower part is persistent, is situate under the fruit, and adheres to it more or less. Corolla of 5 petals, each with a long claw, and hooded: rarely none. Stamens projecting in front of the petals. Styles 2—3, united as high as the middle. Fruit a dry berry, 3-celled, rarely 2—4-celled; the cells pervious at the base; the walls of the consistence of paper. Seed ovate. Shrubs without thorns, with leaves ovate. (*Dec. Prod.*, ii. p. 29.) The species are evergreen or deciduous shrubs, from North America, some of them highly ornamental, on account of their flowers. They are readily propagated by cuttings of the young wood; or by seeds, which are generally imported from America, though they are sometimes ripened in England.

GENUS I.



ZIZYPHUS Tourn. **THE JUJUBE.** *Lin. Syst.* Pentándria Di-Trigýnia.

Identification. Tourn. Inst., t. 403; Gært. Fruct., 1. p. 43; Lam. Ill., t. 185; Dec. Prod., 2. p. 198; Brongn. Mém. Rham., p. 47.

Synonymes. Jujubier, Fr.; Judendorh, Ger.

Derivation. From *zizouf*, the Arabic name of the lotus.

‡ 1. *Z. VULGARIS* Lam. The common, or cultivated, Jujube.

Identification. Lam. Ill., 185. f. 1.; Dec. Prod., 2. p. 19.; Don's Mill., 2. p. 23.

Synonymes. Rhamnus Zizyphus *Lin. Spec.*, 282., *Pall. Fl. Ross.*, 2. t. 59.; *Z. sativa* Desf. *Arb.*, 2. p. 373. *N. Du Ham.*, t. 16., but not of Gært.; *Z. Jujuba* Mill. Dict., No. 1., but not of Lam.; Jujubier cultivé, Fr.; Brustbeeren, Ger.; Giuggiol, Ital.

Engravings. Lam. Ill., 185. f. 1.; *Pall. Fl. Ross.*, 2. t. 59.; *N. Du Ham.* 3. t. 16.; and our fig. 193.

Spec. Char., &c. Branchlets glabrous.

Leaves ovate, retuse, denticulate glabrous, or, beneath, pubescent along the nerves. Prickles not any, or twin, one of them recurved. Drupe ovate-oblong. A deciduous tree, a native of Syria, whence it was brought to Rome during the reign of Augustus. (*Dec. Prod.*, ii. p. 19.) Introduced into England in 1640. In its native country, it grows to the height of 20 ft. or 30 ft., with a thick cylindrical stem, somewhat twisted. The bark is brown, and rather chapped. The branches are numerous, pliant, armed with prickles, zigzag in their direction; the prickles at the joints being two of unequal size, of which one is almost straight, and the other shorter and quite straight. The leaves are alternate and oval-oblong, somewhat hard and coriaceous.

The flowers are small, axillary, of a pale yellow colour, with short peduncles. The fruit is oval-oblong, resembling that of the olive; at first green, afterwards yellow, and entirely red when ripe. It has a mild and vinous taste. The pulp encloses a nut, having a long point at one of the extremities, and it contains two seeds. In the south of France, the tree flowers in the beginning of summer, and the fruit ripens in the beginning of autumn. In the neighbourhood of Paris, it flowers in autumn, and the fruit never arrives at maturity. In England, we have only seen very small plants, kept in pots, in pits.

Geography, History, &c. This tree is indigenous in Syria, and other parts of Asia, also in Greece (see p. 165.); and it is cultivated on both shores of the Mediterranean. It has been acclimatised in Italy since the time of Augustus, and cultivated for its fruit in different parts of that country, as far north as Genoa. Pliny, speaking of the jujube, says that "this tree, and the *Azedarach*, were imported into Italy, from Africa and Syria, in the reign of Augustus, and planted on the ramparts of Rome, where they made a fine appearance, from their heads rising above the houses." Du Hamel recommends the tree to be cultivated generally, on account of the beauty of its foliage; and, in Languedoc, on account of its fruit. The taste of the fruit is somewhat acid; but the flesh is firm, succulent, and, when dried, it makes a very desirable sweetmeat. The syrup of jujubes is employed for abating fever, and purifying the blood; and in coughs and catarrhs: lozenges for the latter purposes are also made of it. The plant prefers a soil that is rather dry, to one that is moist; and, when once established, it is by no means liable to suffer from the winters of Paris. It is easily increased by cuttings of the roots, whether of young or old trees; or by suckers, which it throws up in the greatest abundance. Seeds may also be procured of it from Italy. We have seen the fruit on the tree in the garden of M. Cels, at Paris, in 1828; and gathered it in that of Signor di Negro, at Genoa, in 1819. In 1835, there were plants of this species in the Fulham Nursery.

2. *Z. SINE'NSIS* Lam. The Chinese Jujube.

Identification. Lam. Dict., 3. p. 318.; Dec. Prod. 2. p. 19.; Don's Mill., 2. p. 24.

Synonymy. *Rhâmnus Zizyphus* Lour. *Fl. Coch.*, 158.

Spec. Char. &c. Branchlets pubescent. Leaves ovate-oblong, acute, serrate, glabrous, except beneath, along the nerves. Prickles twin, straightish, diverging. Petals reflexed. Drupes ovate. Reputed to be a native of China, apparently on the authority of the Paris Garden; but it is a question whether correctly. (*Dec. Prod.*, ii. p. 19.) Introduced into England in 1818, and described in the *Nouveau Du Hamel* as requiring protection during winter in the Paris Garden. The name is in Loddiges's *Catalogue*, but the plant in their arboretum was dead in 1835, and we have never seen it.



❖ 3. *Z. SPINA-CHRISTI* Willd. Christ's Thorn Jujube.

Identification. Willd. Spec., 1. p. 1105; Dec. Prod., 2. p. 20; Don's Mill., 2. p. 24.

Synonymes. *Rhâmnus spina-Christi* Lin. Spec., 282., Desf. Fl. Atl., 1. p. 201. *Rhâmnus Nabêca* Forsk. Egypt., 204., but not of Lin.; *Z. africana* Mill. Dict., No. 4.; *Z.*; *Napêca* Lam. Dict., 3. p. 320.; *Nabêca* Alp. Eg., 2. t. 4. p. 10.; *Cenôphia spinosa* Bauh. Pin., 477. *Ger. Emac. Append.*, t. 1605.; Christkronen Judendorf, *Ger.*

Engravings. Alp. Eg., 2. t. 4. p. 10.; *Ger. Emac. Append.*, t. 1605.

Spec. Char., &c. Leaves ovate, obtuse, toothed, glabrous, or, beneath, pubescent. Prickles twin, spreading, one straight, the other incurved. Flowers disposed upon peduncles, two, are corymbosely divided, and villosely tomentose. Drupes ovate-globose. Inhabits the north of Africa and Palestine. (*Dec. Prod.*, ii. p. 20.) A deciduous shrub, growing to the height of 8 ft. in the north of Africa, in Palestine, in Ethiopia, and in Egypt. Introduced in 1759. The flowers are yellowish green; the fruit oblong, about the size of a sloe, with a pleasant subacid taste, and used as food by the inhabitants of Egypt and Arabia. Hasselquist thinks that this is the tree from which the crown of thorns was taken which was put on the head of our Saviour during the crucifixion; but the more general opinion is in favour of *Paliurus aculeatus*. Linnæus raised it from seeds sent by Hasselquist, and Miller cultivated it, in 1759, from seeds; but we have never seen the plant, and do not know whether it is now to be procured in England.

Variety.

❖ *Z. S. 2 inermis* Dec. Prod., ii. p. 20.—This has no prickles, and its leaves are larger, and very obtuse.

‡ 4. *Z. INCURVA* Roxb. The incurved-spined Jujube.

Identification. Roxb. Fl. Ind., 2. p. 364; Dec. Prod., 2. p. 20; Don's Mill., 2. p. 25.

Synonymes. *Z. paniculata* Hamilt. MSS.

Spec. Char., &c. Leaves oval, obtusely acuminate, crenulate, 5-nerved, oblique at the base. Petioles and nerves pubescent. Prickles solitary, or twin, with one incurved. Flowers with the style parted half-way down, disposed in bifid peduncled cymes. (*Dec. Prod.*, ii. p. 20.) A tree growing to the height of 20 ft.; a native of Upper Nepal, and introduced in 1823. The flowers are of a yellowish green, and appear in August and September: they are succeeded by small, round, dark purple fruit. We have never seen the plant.

❖ 5. *Z. FLEXUOSA* Wall. The flexible Jujube.

Identification. Wall. in Fl. Ind., 2. p. 365; Don's Mill., 2. p. 25.

Spec. Char., &c. A smooth shrub, with spiny flexible branches, and unarmed straight branchlets. Prickles twin, one very long and straight, the other recurved. Leaves lanceolate, obtuse, crenate, smooth. Flowers axillary, usually solitary. Style deeply bifid. (*Don's Mill.*, ii. p. 25.) A native of Nepal, where it grows to the height of 8 ft. It is considered an elegant plant, with mahogany-coloured prickles, and solitary yellowish flowers, rather large. It was introduced in 1820; but we have not seen the plant.

App. i. Half-hardy Species of *Zizyphus* already introduced.

Z. Lötus Lam., the *Rhâmnus Lötus* of Linnæus, (*Desf. Act. Par.*, 1788, t. 21.; *Shaw's Afr.*, No. 632, t. 632; and our fig. 194.)

The *lotos* of the Lotophagi, is a deciduous shrub, from 5 ft. to 4 ft. in height, of considerable interest, and eminently deserving of a place against a conservative wall. It is a native of Persia, and of the interior of Africa, especially of the kingdom of Tunis, in a tract called Jereed, which was formerly the country of the Lotophagi. It has the habit of the *Rhâmnus*, and the flowers of the common jujube; but the fruits are smaller, rounder, and sweeter, being about the size of sloes, and containing large stones: they are borne on every part of the plant like gooseberries, and have a purplish tinge. The farinaceous pulp is separated from the stone, and laid by for winter use. Its flavour approaches nearly to that of figs or dates. A kind of wine is made from the fruit by expressing the juice, and diluting it with water; but it will not keep more than a few days. The natives of some parts of Africa convert the fruits into a sort of bread, by exposing them for some days to the sun, and afterwards pounding them gently in a wooden mortar, until the farinaceous part is separated from the stones. The meal thus produced is then mixed with a little water, and formed into cakes, which, when dried in the sun, resemble in colour and flavour the sweetest gingerbread. The stones are afterwards put into a vessel of water, and shaken about, so as to separate the farina which may still adhere to them. This communicates a sweet and agreeable taste to the water; and, with the addition of a little pounded millet, it forms a pleasant liquor, called *fondi*, which is the common breakfast, in many parts of Ludamar, during the months of February and March. The fruit is collected by spreading a cloth upon the ground, and beating the branches with a stick. The *lotos* of the Lotophagi must not be confounded with the Egyptian *lotos*, which is the *Nymphæa Lötus*; with the *lotos* of Homer and Dioscorides, which is a species of *Trifolium*; with the *lotos* of Hippocrates, which is the *Celtis australis*; or with the Italian *lotos*, which is the *Diospyros Lötus*. (*Don's Mill.*, ii. p. 24.) Plants of this species were introduced into Britain in 1731; but they are rarely to be met with, and, when they are, they are treated as frame plants. Plants might probably be obtained from Italy, or from the French colonial garden at Algiers.

Z. nitida Roxb. is a native of China, introduced in 1822. The fruit is 1 in. long, pale yellow when ripe, and edible; the root produces innumerable suckers, which run to a great distance from the parent tree. This species is recorded as a green-house plant, but will probably prove half-hardy.

Z. parvifolia Del. (*Foy. from Egypt*) is a hardy species, not yet introduced. *Z. mucronata* Willd. is a Cape species. *Z. glabra* Roxb. is a native of the East Indies. *Z. Cenôphia* Mill., *Z. tomentosa* Roxb.,

194



and *Z. äbens* Roxb. are also natives of the East Indies. *Z. agrëstis* Schult. and *Z. soporiferus* Schult. are natives of the north of China; and *Z. capënsis* is a native of the Cape of Good Hope. All these species being deciduous, we have no doubt that, if once introduced, and tried in very dry soil, against a conservative wall, they would be found half-hardy.

Z. Jujuba Lam. *Dict.*, iii. p. 318., *Rhâmnuus Jujuba* Lin. *Spec.*, 282., the wild jujube, a tree growing to the height of 16 ft. in India, and cultivated in China and Cochîn-China, was introduced into England in 1759, but, as far as we know, is now lost. It is figured and described by Rumphius (*Amb.*, ii. t. 36.), and by Rheede (*Mal.*, iv. t. 41.); and the following notice respecting it is in Don's *Miller*:—Leaves obliquely ovate, serrated, downy below, as well as the young branches, hoary. Prickles twin, the one recurved, the other straight. Corymbs axillary, almost sessile. Flowers greenish yellow. Drupe globular, size of a large cherry, smooth and yellow when ripe, containing a 2-celled, 1-seeded nut. There is a variety of this, or a new species, in the East Indies, which produces excellent fruit, of a long form, about the size of a hen's egg, known by the name of *warrikellekool* in Bengal. The fruit of both varieties is eaten by all classes of persons: it is sweet and mealy. The bark of the tree is said to be used in the Moluccas in diarrhœa, and to fortify the stomach; which seems to confirm the general opinion entertained of the astringent properties of the bark of most of the species of this order. (*Don's Mill.*, ii. p. 26.) This species, though marked as a green-house plant, will doubtless thrive in the open air, in the warmest parts of the south of England; but we have introduced it here, because we think it and *Zizyphus Lötus* likely to be desirable fruit-shrubs for Australia, the Cape, and the Himalayas. Highly improved varieties of both species, producing fruit as different from that which they now bear, as the Lancashire gooseberry is from the gooseberry of the woods of Switzerland or California, might probably be obtained by selection and cultivation.

Various species of *Zizyphus* are found in the Himalayas; some of which, growing on the higher parts of the mountains, may probably be found hardy. (See *Royle's Illust.*, p. 168.) In the garden of the Horticultural Society there is an unnamed species, which has stood two winters against a wall without any protection.

GENUS II.



PALIURUS L. THE PALIURUS, or CHRIST'S THORN. *Lin. Syst.* Pentândria Trigýnia.

Identification. Tourn. *Inst.*, t. 386.; D. Don *Prod. Fl. Nep.*, p. 189.; Dec. *Prod.*, t. p. 22.; Don's *Mill.*, 2. p. 23.; Brongu. *Mém. Rham.*, p. 46.

Synonymes. Paliüre, Porte-chapeau, *Fr.*

Derivation. From *palto*, to move, and *ouron*, urine; in allusion to its diuretic qualities; or from Paliurus, the name of a town in Africa; now called Nabil.

§ 1. *P. ACULEATUS* Lam. The prickly Paliurus, or Christ's Thorn.

Identification. Lam. *Ill.*, t. 210.; Fl. *Fr.*, ed. 3., No. 4081.; N. Du Ham., 3. t. 17.; Don's *Mill.*, 2. p. 23.

Synonymes. *P. pétasus* *Dum. Cours.*, 6. p. 266.; *P. australis* *Gært. Fruct.*, 1. t. 43. f. 5.; *P. vulgaris* *D. Don Prod. Fl. Nep.*, 189.; *Rhâmnuus Paliurus* *Lin. Spec.*, 281.; *Zizyphus Paliurus* *Willd. Spec.*, 1. p. 1183.; *Sims Bot Mag.*, t. 1893.; Christ's Thorn, or Ram of Libya *Gerard.*; *E'pine de Christ*, Argalon, *Porte-chapeau, Fr.*; *gefägelter Judendorn, Ger.*

Engravings. Lam. *Ill.*, t. 210.; N. Duh., 3. t. 17.; *Gært. Fruct.*, 1. t. 43. f. 5.; *Bot. Mag.*, t. 1893.; *E. of Pl.*, No. 2896.; our *fig.* 195.; and the plates of this species, both in a young and an old state, in our Second Volume.

Spec. Char., &c. Branchlets pubescent. Leaves ovate, serrulated, quite smooth, 3-nerved, with two spines at the base, one straight, the other recurved. Flowers in axillary crowded umbellules; few in an umbellule. Wing of capsule crenated. (*Don's Mill.*, ii. p. 23.) A branching deciduous shrub, or low tree; a native of the south of Europe, and north and west of Asia, and introduced in 1596. The flowers, which are produced in great abundance, are of a greenish yellow, and they are succeeded by fruit of a buckler shape, flat and thin, but coriaceous. From the singular appearance of this fruit, which has the footstalk attached to the middle, which is raised like the crown of a hat, and the flattened disk, which resembles its brim, the French have given this tree the name of *porte-chapeau*. On both shores of the Mediterranean, it grows to about the same height as the common hawthorn. In the south of Russia, according to Pallas, it forms a bushy tree, with numerous branches, thickly clothed with prickles, coming out in pairs at the buds, one of them bent back, and both very sharp. It is found on the hills near the Lake of Baikal, particularly near warm springs; it is also found in the south of Caucasus and Georgia, and in the woody mountains of Taurida, where it renders some parts of them almost impervious. In many parts of Italy



195

the hedges are formed of this plant, as they are of the hawthorn in Britain; it is also the common hedge plant in Asia. Du Hamel recommends it for being employed for hedges in the south of France, where it abounds in a wild state. Medicinally, the entire plant is considered diuretic; and it is said to have been given with success in dropsical cases. Virgil, when describing, in figurative language, Nature as mourning for the death of Julius Cæsar, says the earth was no longer covered with flowers or corn, but with thistles, and the sharp spines of the paliurus. Columella recommends excluding the plant entirely from gardens, and planting it with brambles for the purpose of forming live hedges. In the south of France, where it has been tried in this way, the same objection is made to it as to hedges of the common sloe (*Prunus spinosa*) in this country; viz. that it throws up such numerous suckers as in a short time to extend the width of the hedge considerably on both sides. As this species abounds in Judæa, and as the spines are very sharp, and the branches very pliable, and easily twisted into any figure, Belon supposed the crown of thorns, which was put upon the head of Christ before his crucifixion, to be composed of them. Josephus says "that this thorn, having sharper prickles than any other, in order that Christ might be the more tormented, they made choice of it for a crown for him." (*Ant. of the Jews*, book i. chap. ii., as quoted by Gerard.) Hasselquist, however, thinks that the crown of thorns was formed of another prickly plant, the *Zizyphus spina-Christi* W., *Rhâmnus spina-Christi* Lin.; but, according to Warburton, it was the *Acánthus mollis*, which can hardly be considered prickly at all.

Statistics. The largest plant of this species in the neighbourhood of London is at Syon, where it is 33 ft. high, the trunk 1 ft., and the diameter of the head 30 ft. (See our engraving of this tree in Vol. II.) There is a fine old specimen in the Botanic Garden at Oxford about 20 ft. high, and one in the Chelsea Botanic Garden of considerable age, but not remarkable for its height. Plants, in the London nurseries, are 1s. 6d. each; at Bollwyller, 1 franc 20 cents each; and at New York, 50 cents each.

GENUS III.



BERCHEMIA Neck. THE BERCHEMIA. *Lin. Syst.* Pentándria Monogýnia.

Identification. Neck. Elem., 2. p. 122.; Dec. Prod., 2. p. 22.; Brongn. Mém. Rham., 49.; Don's Mill., 2. p. 97.

Synonyms. *Enóphia Hedw. F. Gen.*, 1. p. 151., and *Schult. Syst.*, 5. p. 962.

Derivation. From *Berchem*, probably the name of some botanist.

Description, &c. Twining deciduous shrubs, of which there is only one species considered hardy.

§ 1. B. VOLU'BILIS Dec. The twining Berchemia.

Identification. Dec. Prod., 2. p. 22.; Don's Mill., 2. p. 27.

Synonyms. *Rhâmnus volubilis Lin. Fil. Suppl.*, 132., *Jacq. Icon. Rar.*, t. 336.; *Zizyphus volubilis*

Willd. Spec., 1. p. 1102.; *Enóphia volubilis Schult. Syst.*, 5. p. 332.; *Supple Jack, Virginian.*

Engravings. *Jacq. Icon. Rar.*, t. 336.; *E. of Pl.*, No. 2895.; and our fig. 196.

Spec. Char., &c. Branches glabrous, rather twining.

Leaves oval, mucronate, somewhat waved. Flowers

dioecious. Drupes oblong. (*Dec. Prod.*, ii. p. 22.)

A deciduous twining shrub, a native of Carolina and

Virginia, in deep swamps near the sea coast. Introduced in 1714.

According to Pursh, it ascends the highest trees of *Taxodium distichum*, in the dismal

swamp near Suffolk in Virginia; and it is known there by the name of *Supple Jack*. The stems

twine round one another, or any object which they may be near; but, in British gardens, they are

seldom seen above 8 ft. or 10 ft. high, probably from

little attention being paid to place the plant in a



deep sandy or peaty soil, and to supply it with abundance of moisture in the growing season. The foliage has a neat appearance. The flowers are small, and of a greenish yellow colour; and, in America, they are succeeded by oblong violet-coloured berries. It is propagated by cuttings of the root, or of the branches, or by layers. Plants are in the garden of the London Horticultural Society, and in some nurseries. Price, in London. 2s. 6d. each; and at New York, 1 dollar.

App. i. *Other Species of Berchémia.*

B. flavescens Brongn., the *Zizyphus flavescens* of *Wallich*, is a Nepal climber, not yet introduced. *B. lineata* Dec., *Rhámnus lineatus* *Lin.*, is a green-house shrub, introduced in 1804 from China. It grows to the height of 8 ft. *B. Lourciviana* *Dec.*, the *Rhámnus lineatus* of *Lam.*, but not of *Linnaeus*, is a trailing shrub, a native of Cochín-China, among hedges and bushes, not yet introduced, but, in all probability, half-hardy or hardy.

GENUS IV.



RHA'MNUS *Lam.* THE BUCKTHORN. *Lin. Syst.* Pentándria Mono- gýnia.

Identification. *Lam. Dict.*, 4. p. 461.; *Lam. Ill.*, t. 128.; *Gärt. Fruct.*, 2. p. 106.; *Dec. Prod.*, 2. p. 23.; *Don's Mill.*, 2. p. 29.; *Brongn. Mém Rham.*, p. 53.

Synonymes. Nerprun, *Fr.*; Wegdorn, *Ger.*; the Ram, or Hart's, Thorne, *Gerard.*; Box Thorn.
Derivation. From the Celtic word, *ram*, signifying a tuft of branches; which the Greeks have changed to *rhamnos*, and the Latins to *ramus*.

Description, &c. Deciduous, or evergreen shrubs, one or two of them with the habit of low trees, and some of them sub-procumbent, or procumbent; and all of them, except the latter, distinguished by an upright stiff mode of growth, and numerous strong thorns in their wild state; whence the name of ram, or buck, thorn. Many of the sorts set down in books as species are, doubtless, only varieties; but, till the whole are brought together, and cultivated in one garden, this cannot be determined. The flowers in all the species are inconspicuous; but the *R. Alaternus* and its varieties are most valuable evergreen shrubs, and several of the other species are ornamental, both from their foliage and their fruit; the latter of which is also useful in dyeing. *R. híbridus*, *R. alpinus*, *R. cathárticus*, *R. Frángula*, *R. saxátilis*, *R. ánifólius*, and *R. latifólius* are species procurable in the nurseries, and well deserving of cultivation. They are all easily propagated by seeds or layers, and most of them by cuttings; and they will all grow in any soil that is dry. They all vary much in magnitude by culture, in common with most plants which, in a wild state, grow in arid soils.

§ i. *Marcorélla* Neck.

Synonymes. *Rhámnus* and *Alaternus* of *Tourn.*

Sect. Char. Flowers usually diœcious, and 5-cleft. Fruit a berry, with 3 seeds, or, from abortion, 2 seeds. Seeds deeply furrowed, with the raphe in the bottom of the furrow. Leaves usually permanent; coriaceous, and glabrous. (*Dec. Prod.*, ii. p. 23.)

A. *Alaternus* *Tourn.* *Flowers racemosc, 5-cleft. Evergreen Shrubs.*

✱ 1. *R. ALATE'RNUS* *L.* The Alaternus.

Identification. *Lin. Spec.*, 281.; *Dec. Prod.*, 2. p. 23.; *Don's Mill.*, 2. p. 30.

Synonymes. *Alaternus Phillýrea Mill. Dict.*, No. 1.

Derivation. From *Alternus*, a generic name, adopted from *Dioscorides*, designating the alternate position of the leaves.

Engravings. *Mill. Dict.*, t. 16. f. 1.; *N. Du Ham.*, 3. p. 42. t. 14.; and our *fig.* 1-7.

Spec. Char., &c. Leaves ovate-elliptical, or lanceolate, coriaceous, quite smooth, serrated. Flowers diœcious, disposed in short racemes. (*Don's Mill.*, ii. p. 30.) An evergreen shrub, a native of the south of Europe and the north of Africa; in cultivation, in England, from the days of Parkinson, in 1629. There are several varieties.

197



- R. A. 2 *baleárica* Hort. Par. *The Balearic Alaternus*.—Leaves roundish. The *Rhámnus rotundifólius* of Dumont. We take this as the first variety, assuming the species to be what is called *R. A. latifólius*, which is the commonest variety in British nurseries.
 - R. A. 3 *hispánica* Hort. Par. *The Spanish Alaternus*.—Leaves ovate, a little toothed.
 - R. A. 4 *fólius maculátis*. *The gold-blotched-leaved Alaternus*.
 - R. A. 5 *fólius aúreis*. *The gold-edged-leaved Alaternus*.
 - R. A. 6 *fólius argénteis*. *The silver-edged-leaved Alaternus*.—This variety, which is very conspicuous from the large proportion of the leaves which is white, is more tender than some of the other varieties, it generally does best against a wall, and is well worth a place there, on account of its splendid appearance, especially in winter.
- R. A. 7 *angustifólia*, *synon. R. Clúsi* Willd. *The narrow-leaved Alaternus*.—Figured in *Mill. Icon.*, t. 16. fig. 2. This variety is so distinct, that it is by many authors considered as a species. There are two subvarieties of it, the gold-striped-leaved, and the silver-striped-leaved. They are all of remarkably free growth, more especially *R. A. angustifolia*.

Geography, History, &c. The alaternus is a densely branched shrub, growing to the height of 15 ft. or 20 ft. in sheltered situations, but always preserving the character of a bush, unless carefully trained to a single stem. The leaves are alternate, shining, and often glandular at the base, and serrated in some varieties, but entire in others. The flowers are numerous, male or female, or imperfect hermaphrodites, on the same or different individuals; and hence the plant is seldom seen in England bearing fruit. It is abundant in the south of Europe, and was observed by Sir James Smith, in Italy, sometimes only a foot or two in height, and at others as high as a low tree. Evelyn, also, observed it there; and says that its blossoms, which are produced from April to June, afford an “early and marvellous relief to bees.” Evelyn boasts that he was the first who brought the alaternus into use and reputation in England, and that he had propagated it from Cornwall to Cumberland. Parkinson, however, first introduced it; and he commends it for the beauty and verdure of the leaves, “abiding quite fresh all the year.” In his time it was called evergreen privet. The plant is mentioned by Pliny and by Dioscorides, both as medicinal and as being used in dyeing. Clusius states that in Portugal the bark is used to dye a red, and the wood to dye a blackish blue. In British gardens, this shrub is particularly valuable for the rapidity of its growth in almost any soil and situation, more especially the narrow-leaved variety. About the end of the seventeenth century, it was one of the few evergreens generally planted, not only for hedges and to conceal objects, but to clothe walls, and to be clipped into artificial shapes. In London and Wise’s *Retired Gardener*, published in 1706, it is recommended to grow the alaternus in cases (boxes), for ornamenting gardens and court-yards; and, when clipped into the form of a bowl or ball, for placing in the borders of parterres. “You give it what shape you think fit by the help of your shears, which, being well guided, will make this shrub of a very agreeable figure.” (*Ret. Gard.*,

ii. p. 751.) The four large, round, and smoothly clipped plants of phillyrea, on naked stems, mentioned in p. 45. as possessed by Evelyn at Sayer's Court, were doubtless of this species, and not of the genus *Phillyrea*, which is of much slower and less robust growth. The *Alaternus* was at that time, and even so late as the time of Miller, frequently confounded with the *Phillyrea*; but the two genera are readily distinguished by the position of their leaves, which are alternate in *Rhamnus*, and opposite in *Phillyrea*. At present, the *alaternus* is chiefly planted in town gardens, to conceal walls, and because it is less injured by the smoke of coal than most other evergreens. The species, and all the varieties, are readily propagated by cuttings, which are taken off in autumn, and planted in sandy soil, in a shady border, and covered with a hand-glass. Price, in the London nurseries, of the species, and of the blotched-leaved variety, 9d. a plant; of the gold- and silver-edged-leaved, 2s. 6d. each: at Bollwyler, the species and varieties from 1 franc to 2 francs a plant: at New York, &c. As the roots are not very productive of fibres, when large plants are chosen, they should be such as have been reared in pots, in order that they may receive no check from removal.

■ 2. *R. HYBRIDUS* L'Hérit. The hybrid *Alaternus*.

Identification. L'Hérit. Sert., t. 5.; Dec. Prod., 2. p. 23.; Don's Mill., 2. p. 33.

Synonymes. *R. burgundicus Hort. Par.*; *R. sempervirens Hortulan.*

Engraving. L'Hérit. Sert., t. 5.

Spec. Char., &c. Leaves oblong, acuminate, serrated, smooth, shining, hardly permanent, rather coriaceous. Flowers androgynous. (*Don's Mill.*, ii. p. 30.) A garden hybrid, a sub-evergreen shrub, raised from *R. alpinus*, fecundated by *R. Alaternus*, and forming a very distinct and desirable kind, which, in British gardens, grows to the height of 10 ft. or 12 ft. The flowers are green, and appear in May or June. There is a plant in the arboretum of Messrs. Loddiges, which, in 1833, before it was cut down, was 8 ft. high. There is one in the garden of the London Horticultural Society 5 ft. high. Price of plants, in London, 2s. each; at Bollwyler, 1 franc and 50 cents.

B. *Rhamnus* Dec. Flowers in Fascicles, 5-cleft.



■ 3. *R. LONGIFOLIUS* Link. The long-leaved Buckthorn.

Identification. Link Enum., i. p. 228.; Dum. Cours. Bot. Cult., 6. p. 260.; Dec. Prod., 2. p. 24.; Don's Mill., 2. p. 30.

Synonyme. *R. Willdenovianus* Röm. et Schult. Syst., 5. p. 295.

Spec. Char., &c. Leaves oval-oblong, acute at both ends, serrated, smooth, shining, pilose in the axils of the veins beneath. (*Don's Mill.*, ii. p. 30.) A shrub, growing to the height of 8 ft.; introduced in 1823, but from what country is uncertain.

C. Flowers 4-cleft, in Fascicles.



a. Branchlets terminating in a Thorn.

‡ 4. *R. CATHARTICUS* L. The purging Buckthorn.

Identification. Lin. Spec., 280.; Dec. Prod., 2. p. 24.; Don's Mill., 2. p. 30.

Synonyme. The White Thorn of the modern Greeks.

Engravings. Eng. Bot., t. 1629.; Wood. Med. Bot., t. 114.; Ed. Fl. Dan., t. 850.; N. Du Ham., 2., t. 10.; our fig. 198.; and the plate of this species in Vol. II.

Spec. Char., &c. Erect. Leaves ovate, toothed. Flowers in fascicles, polygamodioecious. Berries 4-seeded, rather globose. (*Don's Mill.*, ii. p. 30.) A native of Europe and the north of Asia, and plentiful in England.

Variety.

‡ *R. c. 2 hydryiensis* Jac., with larger leaves, tapering to the base, is found wild about Hydria.

Description, History, &c. A deciduous shrub or low tree, growing to the height of 12 ft. or 15 ft. in a state of cultivation, with many irregular branches, the young shoots of which have a smooth greyish brown bark; but the older branches have rougher bark, armed with a few short thorns. The leaves are ribbed, smooth, and of a bright green. The flowers are of a yellowish green, and they are succeeded by berries, which are globular, bluish black, nauseous, violently purgative, with 4 cells, and as many seeds. By this last character they are distinguished by druggists from the berries of *R. Frángula*, which are supposed to be less cathartic. In Britain, this species is found in native woods and thickets, generally on calcareous and loamy soils, but seldom above 10 ft. or 12 ft. in height. According to Pallas, this species is common in the champaign and southern parts of Siberia, with a trunk thicker than a man's arm, and the wood very hard, and of a reddish colour. The flowers are, for the most part, hermaphrodite, and, in a wild state, clustered; but in a state of cultivation they are fewer, and nearly solitary. The juice of the unripe berries has the colour of saffron, and it is used for staining maps or paper: they are sold under the name of French berries. The juice of the ripe berries, mixed with alum, is the sap green of painters; but, if the berries be gathered late in the autumn, the juice is purple. The bark affords a beautiful yellow dye. The inner bark, like that of the elder, is said to be a strong cathartic, and to excite vomiting; the berries are also strongly purgative; and it is said that the flesh of birds which feed upon them possesses the same quality. Plants of this species, in the garden of the London Horticultural Society, have attained the height of 9 ft. in 10 years: they do not make much show in spring, when in flower; but in autumn and winter, when profusely covered with their black berries, they are very ornamental. The fruit remains on after the leaves have fallen. Plants, in the London nurseries, are 1s. each; at New York, plants are 37½ cents each.

If plants were required for forming hedges (for which the species is very eligible, in consequence of its robust and rigid habit of growth), they could, no doubt, be provided and supplied at a price less than that of plants of the common hawthorn, because plants of *R. cathárticus* come up in the first year from the sowing.

§ 5. *R. VIRGATUS* Roxb. The twiggy Buckthorn.

Identification. Roxb. Fl. Ind., 2. p. 351; Dec. Prod., 2. p. 24; Don's Mill., 2. p. 30.
Synonymes. *R. cathárticus* Hamilt. MSS.

Spec. Char., &c. Erect. Branchlets terminating in a spine. Leaves nearly opposite, oblong, ventricose, serrated. Flowers around the base of the young shoots, and axillary in threes. Stigmas 2-3-cleft. (*Don's Mill.*, ii. p. 33.) A deciduous shrub, growing to the height of 12 ft. in the Neelgherry Mountains in the Himalaya; introduced in 1820. The flowers are very small, yellow, and appear in June and July; and the berries are from 2- to 3-seeded.

§ 6. *R. TINCTORIUS* Waldst. The Dyer's Buckthorn.

Identification. Waldst. et Kit. Pl. Rar. Hung., 3. p. 255; Dec. Prod., 2. p. 24; Don's Mill., 2. p. 31.

Synonyme. *R. cardiopérmus* Willd. Herb.
Engravings. Hayne Abild., t. 97., and our fig. 199.

Spec. Char., &c. Erect. Leaves ovate, crenate-serrated. Petioles villous. Flowers crowded, diœcious. Berries obcordate, 3- to 4-seeded. (*Don's Mill.*, ii. p. 31.) A deciduous shrub, a native of Hungary, in hedges, where it grows to the height of 8 ft. Introduced in 1820. The flowers, which are produced in May and June, are of a greenish yellow, and the berries and inner bark are used for dyeing. A plant of this species, in the garden of the London Horticultural Society, was, in 1834, 3 ft. high, after being 7 years planted.



✱ 7. *R. INFECTORIUS* L. The staining Buckthorn, or *Avignon Berry*.

Identification. Lin. Mant., 49; Dec. Prod., 2. p. 24; Don's Mill., 2. p. 31.
Synonymes. *Rhamnus Lycium Scop. Carn. ed. 2. n. 260.*; dwarf, or yellow-berried, Buckthorn;
 Nerprun des Teinturiers, Graine d'Avignon, Nerprun teignant, Fr.; Farbender Wegdorn, Ger.
Engravings. Ard. Mem., 78. t. 14; and our fig. 200.

Spec. Char., &c. Leaves ovate-lanceolate, serrulated, smoothish. Flowers diœcious, bearing petals in both sexes. (*Don's Mill.*, ii. p. 31.) A deciduous, sub-procumbent shrub; a native of the south of Europe, in rocky places; common about Avignon, and the Vaucluse; whence the name Avignon berry. Introduced in 1683. The root fixes itself so firmly in the fissures of the rocks, that the plant can scarcely be pulled up. The stem divides immediately into branches, that are very much subdivided, and form a very close head, the shoots having numerous spines, both terminating and lateral. The flowers are numerous, and the berries 3-celled, and black when ripe. In England, the berries are very seldom produced. According to the first edition of *Du Hamel*, the berries of this species were gathered green, and used for producing a yellow colour by dyers and painters. Miller says that this is a mistake, and that the Avignon berries alluded to by Du Hamel are those of the narrow-leaved alaternus, one of the most common shrubs in the south of France. In the *Nouveau Du Hamel*, this assertion of Miller's is noticed, together with one of Haller's, who says that the Avignon berries are gathered from the *R. saxatilis*. The writer remarks that the berries are now very little used, and that, as all the three species abound in the south of France, and the berries of all of them dye yellow, the Avignon berries were probably gathered from all, or any, of them indiscriminately. The berries are used for dyeing leather yellow; and the Turkey leather, or yellow morocco, is generally supposed to be coloured by them. There are plants of this species in the arboretums of Messrs. Loddiges and the London Horticultural Society. The latter had, in 1834, attained the height of 6 ft., forming a very handsome bush.



✱ 8. *R. SAXATILIS* L. The Stone Buckthorn.

Identification. Lin. Sp., 1671; Dec. Prod., 2. p. 24; Don's Mill., 2. p. 31.
Synonymes. *R. longifolius Mill. Dict.*; Stein Wegdorn, Ger.
Engravings. Javq. Austr., t. 43; and our fig. 201.

Spec. Char., &c. Procumbent, or erectish.

Leaves ovate-lanceolate, serrulated, smoothish. Flowers diœcious, female ones destitute of petals. (*Don's Mill.*, ii. p. 31.) A procumbent deciduous shrub, native of the south of Europe, among rocks, in Austria, Switzerland, Italy, and Greece. Introduced in 1752. The flowers are of a greenish yellow, and appear in June and July. The berries are black, containing three whitish seeds, each enclosed in a dry whitish membrane, separating into two parts with elastic force. The berries are supposed to be used for the same purposes as those of *R. infectorius*, and *R. tinctorius*, for which they are often sold. Neither this nor the preceding species can be considered as ornamental in itself; but both are well adapted for planting among rocks, either natural or artificial. In garden scenery, where natural rocks occur, and where it is desirable that they should be retained, the only legitimate mode of rendering them gardenesque is, by clothing them, or varying them with showy flowering plants, ligneous or herbaceous.

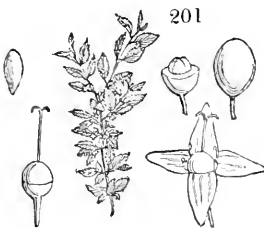

☞ 9. *R. OLEÖIDES* Lin. The Olive-like Buckthorn.

Identification. Lin. Sp., 279.; Desf. Atl., 1. p. 197.; Dec. Prod., 2. p. 24.; Don's Mill., 2. p. 31.
Synonyme. *R. oleifolius* Hort.
Engraving. Our fig. 202.

Spec. Char., &c. Diffuse, or rather erect; leaves oblong, obtuse entire, coriaceous, smooth, with netted veins beneath. (*Don's Mill.*, ii. p. 31.) A deciduous shrub, growing to the height of 3 ft., in the fissures of rocks, in Sicily, Mauritania, Spain, and Greece. Introduced in 1752. In *Loddiges's Catalogue*, it is in the list of green-house plants; but it is generally understood to be quite hardy. Though the species of the *Rhamnus* are numerous, yet, as few of them attain a large size, they will not occupy so much space in an arboretum as might, at first sight, be imagined. Where the soil is dry, and the surface somewhat undulated, the plants may be scattered over it at the same distances from each other as their heights; or, if there is space to spare, at double this distance, which will allow each species to display its natural form, and to bring its leaves, flowers, and fruit to maturity. Where the soil is not naturally dry, an artificial ridge of dry soil, mixed with rocks or stones, may be formed; and along this the different species of *Rhamnus* may be scattered.



☞ 10. *R. BUXIFOLIUS* Poir. The Box-leaved Buckthorn.

Identification. Poir. Dict., 1. p. 463.; Dec. Prod., 2. p. 24.; Don's Mill., 2. p. 31.
Synonyme. ? *R. buxifolius* Brot. *Fl. Lus.*, 1. p. 301.
Engraving. Our fig. 203.

Spec. Char., &c. Diffuse. Leaves ovate, quite entire, mucronate, smooth, coriaceous, green on both surfaces. (*Don's Mill.*, ii. p. 31.) A shrub, growing to the height of 5 ft., a native of Numidia, and introduced in 1820. According to *Destontaines*, it is only a variety of *R. oleoides*; but, whether a species or variety, it is, at all events, a very distinct and a very neat form: indeed, it may be observed of the species of deciduous *Rhamnus* generally, that they are all characterised by a particular kind of distinctness and permanence of appearance; from which, however much many of the sorts may resemble each other, yet they can never be mistaken for species belonging to other genera. They almost all grow slowly, and have wood of a hard and durable nature; and the appearance of all of them, whether as bushes or low trees, has the expression of durability. The blossoms are small, and so are the fruit; but both, or at all events the fruit, remain a long time on the plant, as well as the leaves, most of which are pointed and coriaceous, and strongly veined or ribbed; all which adds to that expression of firmness, rigidity, and permanence in the plant, which we have already mentioned.



☞ 11. *R. PUBESCENS* Poir. The pubescent Buckthorn.

Identification. Poir. Dict., 4. p. 464.; Dec. Prod., 2. p. 24.; Don's Mill., 2. p. 31.
Synonyme. *R. oleoides* Lam. *Fl. Fr.*, 2. p. 545., ed. 3., No. 4075.

Spec. Char., &c. Diffuse. Leaves quite entire, coriaceous, pubescent. (*Don's Mill.*, ii. p. 31.) A deciduous shrub, growing to the height of 3 ft., a native of the south of France and of the Levant, and introduced in 1817. Probably only a variety of *R. oleoides*.

☞ 12. *R. LYCÖIDES* Lin. The Lycium-like Buckthorn.

Identification. Lin. Spec., 279.; Dec. Prod., 2. p. 25.; Don's Mill., 2. p. 31.
Engraving. Cav. Icon., 2. t. 182.

Spec. Char., &c. Erect. Leaves linear, quite entire, obtuse, smooth. Flowers hermaphrodite. (*Don's Mill.*, ii. p. 31.) A deciduous shrub, a native of Spain, growing to the height of 3 ft. or 4 ft., on the limestone hills of Valencia. Introduced in 1752.

Variety.

☞ *R. l. 2 arragonensis* Asso *Syn. Arr.*, p. 27., has the leaves yellowish on the upper surface, and is found in Arragon.

☞ 13. *R. ERYTHROXYLON* Pall. The red-wooded Buckthorn.

Identification. Pall. *Fl. Ross.*, 2. t. 62.; *Itin.*, French edit., t. 90.; Dec. Prod., 2. p. 25.; Don's Mill., 2. p. 31.
Engravings. Pall. *Fl. Ross.*, 2. t. 62.; *Itin.*, French edit., t. 90.; and our fig. 204

Spec. Char., &c. Erect. Leaves linear, lanceolate, quite entire or serrated, smooth. Flowers hermaphrodite. Berries oblong. (*Don's Mill.*, ii. p. 31.)



A deciduous shrub, growing to the height of 6 ft., in rocky and gravelly situations, near the rivers of Mongolia and Siberia. Introduced in 1823. It delights in a warm situation; and in cold and humid places, Pallas observes, it is never met with. The wood, on account of its hardness and red colour, is used by the Mongols for making their images; and the berries, when macerated in water, afford them a deep yellow colour. The plant, in its wild state, is a prickly bush; but, when cultivated, the spines no longer appear. There is a

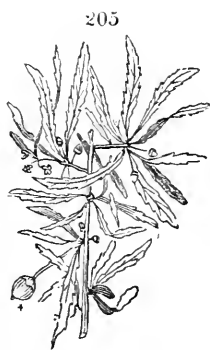

small plant of this species in the garden of the London Horticultural Society; and another in the arboretum of Messrs. Loddiges.

Variety.

- ✱ *R. E. 2 angustissimum* Dec. Prod., ii. p. 25., *R. lycioides* Pall. *Fl. Ross.*, t. 63., (fig. 205.) has the leaves narrow, smaller, and very finely serrulated. It is a native of Caucasus and Achalgory.

b. *Branchlets not terminated by Spines.*

- ✱ 14. *R. RUPESTRIS* Vill. The Rock Buckthorn.

Identification. Vill. Dauph., 2. p. 531.; Don's Mill., 2. p. 31.

Synonymes. *R. pumilus* β *rupëstris* Dec. Prod., 2. p. 25.

Spec. Char., &c. Procumbent, branched. Leaves ovate, quite entire, smooth. Flowers diœcious. (Don's Mill., ii. p. 31.) A procumbent deciduous shrub, a native of Dauphiné, on rocks; and introduced in 1752.

- ✱ 15. *R. VALENTINUS* Willd. The Valencia Buckthorn.

Identification. Willd. Spec., 1. p. 1096.; Don's Mill. 2. p. 31.

Synonymes. *R. pumilus* Cav. *Icon.*, 2. t. 181.; *R. pumilus* var. *valentinus* Dec. Prod., 2. p. 25.

Engraving. Cav. *Icon.*, 2. t. 181.

Spec. Char., &c. Procumbent. Leaves roundish, elliptical, minutely crenate, and nearly sessile. Flowers 4-cleft, hermaphrodite. (Don's Mill., ii. p. 31.) A procumbent deciduous shrub, a native of Spain, on the mountains of Mecca and Palomera, in the kingdom of Valencia; introduced in 1816; flowering in June and July.

- ✱ 16. *R. WULFENII* Spreng. Wulfen's Buckthorn.

Identification. Spreng. Syst., 1. p. 762.; Don's Mill., 2. p. 31.

Synonymes. *R. pumilus* Wulf. in *Jacq. Coll.*, 2. p. 141.; *R. pumilus* var. *Wulfeni* Dec. Prod., 2. p. 25.

Engraving. Jacq. *Coll.*, t. 11.

Spec. Char., &c. Erectish. Leaves orbicular, with cartilaginous crenated margins, veiny, silky beneath on the nerves. Stigma simple. Flowers hermaphrodite. (Don's Mill., ii. p. 31.) A subprocumbent deciduous shrub, growing to the height of 2 ft., a native of Austria; introduced in 1752, and flowering in June and July.

- ✱ 17. *R. PUSILLUS* Ten. The small Buckthorn.

Identification. Ten. Prod., 16.; Don's Mill., 2. p. 31.

Synonyme. *R. pumilus* var. *neapolitanus* Dec. Prod., 2. p. 25.

Spec. Char., &c. Procumbent. Leaves obovate, acute, crenulated, and mucronate at the apex. Flowers hermaphrodite. Stigma 3-parted. (Don's Mill., ii. p. 31.) A deciduous procumbent shrub, a native of Naples, and introduced in 1823; flowering in June and July.

- ✱ 18. *R. DAHURICUS* Pall. The Dahurian Buckthorn.

Identification. Pall. *Fl. Ross.*, 2. t. 61.; Dec. Prod., 2. p. 25.; Don's Mill. 2. p. 31.

Engraving. Pall. *Fl. Ross.*, 2. t. 61.

Spec. Char., &c. Erect. Leaves oblong-ovate, serrated, smooth, veiny. Flowers diœcious, female ones with bifid stigmas. (Don's Mill., ii. p. 31.) A deciduous shrub, growing to the height of 5 ft.; found near the river Arguinus in Dahuria, but not in any other part of Siberia. The flowers are of

a greenish yellow colour; berries black, about the size of a pea; and the general appearance of the plant is that of *R. catharticus*, of which it may possibly be only a variety. In 1833, there was a small plant of it in Loddiges's arboretum. The wood is red, and is called sandal wood by the Russians.

❧ 19. *R. ALNIFOLIUS* L'Hérit. The Alder-leaved Buckthorn.

Identification. L'Hérit. Sert., t. 5.; Dec Prod., 2. p. 25.; Don's Mill., 2. p. 32.
Engravings. Hayne Abbild., t. 61.; and our fig. 206.

Spec. Char., &c. Erect. Leaves obovate or ovate, serrulated, obliquely lineated, with lateral nerves, acuminate or obtuse, smoothish beneath, except the nerves. Flowers hermaphrodite or diœcious. Pedicels 1-flowered, aggregate. Calyxes acute. Fruit turbinate. (*Don's Mill.*, ii. p. 32.) A deciduous shrub, growing to the height of 8 ft.; a native of North America, introduced in 1778; but not the *R. alnifolius* of Pursh. There are plants of this name in the nurseries, which, in London, cost 1s. 6d.; at New York, 50 cents.



❧ 20. *R. FRANGULOIDES* Michx. The Frangula-like Buckthorn.

Identification. Michx. Fl. Bor. Amer., l. p. 153.; Don's Mill., 2. p. 32.
Synonymy. *R. alnifolius* var. *franguloides* Dec. Prod., 2. p. 25.
Engravings. N. Du Ham., 3. t. 13, and our fig. 207.

Spec. Char., &c. Leaves oval, serrated, pubescent on the nerves beneath. Peduncles twice bifid. Berries depressed, globose. (*Don's Mill.*, ii. p. 32.) A deciduous shrub, growing to the height of 8 ft.; a native of North America, from Canada to Virginia, on dry hills, near rivers; producing its green flowers in June and July, which are succeeded by small, round, black berries. Introduced in 1810. This sort, and some of the others, may possibly be only seminal varieties, or natural hybrids; for, in a genus in which there are so many species, it is to be expected that accidental cross fecundation will occasionally take place. From whatever source, however, a distinct form is produced, it can always be continued in gardens by propagation by extension; and, so long as mankind have wealth, intelligence, and leisure to admire the varied productions of nature, the greater the number of these varied productions, the more ample will be their source of enjoyment.

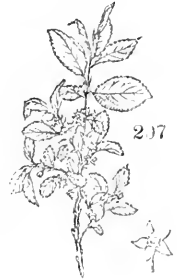

❧ 21. *R. ALPINUS* Lin. The Alpine Buckthorn.

Identification. Lin. Spec., 213.; Don's Mill., 2. p. 32.
Engravings. N. Du Ham., 3. t. 13.; Bot. Cab., t. 1077.; our fig. 208.; and our plate of the tree in Vol. II.

Spec. Char., &c. Erect, twisted. Leaves oval-lanceolate, crenate-serrated, smooth, lineated with many parallel nerves. Flowers diœcious, female ones with 4-cleft stigmas. (*Don's Mill.*, ii. p. 32.) A deciduous shrub, growing to the height of 4 ft., in the Alps, of Switzerland, Dauphiné, and Carniola. Introduced in 1752. The flowers are greenish, and produced in May and June, and the berries black. This is a very distinct species, and remarkable for its twisted leaves. There is a strong plant of it in the arboretum of Messrs. Loddiges, and one in the garden of the Horticultural Society, which, in 10 years, has attained the height of 8 ft., and the character of a small tree.



❧ 22. *R. PUMILUS* Lin. The dwarf Buckthorn.

Identification. Lin. Mant., 49.; Don's Mill., 2. p. 32.
Synonymy. *R. rupëstris* Scop. Carn., l. t. 5.
Engraving. Scop. Carn., l. t. 5.

Spec. Char., &c. Plant procumbent, much branched. Leaves ovate, serrated, smooth. Flowers hermaphrodite. (*Don's Mill.*, ii. p. 32.) A deciduous procumbent shrub, a native of Mount Baldo in the Alps, and of Carniola, in the fissures of rocks. Introduced in 1752. Flowering in June and July. The flowers are greenish yellow, the stamens white, and the berries black.

§ ii. *Frángula* Tourn.

Identification. Tourn. Inst., t. 383.; Dec. Prod., 2. p. 26.; Brongn. Mém. Rham., t. 55.

Sect. Char. Flowers hermaphrodite, rarely diœcious, 5-cleft, sometimes 4-cleft. Seeds smooth, compressed, with the hilum white and exserted, and with the raphe lateral, on the surface of the inner testa. Embryo flat. Leaves membranous, caducous, quite entire, lined with approximate parallel nerves. (*Don's Mill.*, ii. p. 32.)

‡ 23. *R. CAROLINIA'NUS* Walt. The Carolina Buckthorn.

Identification. Walt. Car., p. 101.; Pursh, 1. 166.; Michx. Fl. Amer., 1. p. 153.; Dec. Prod., 2. p. 26.; Don's Mill., 2. p. 32.

Spec. Char., &c. Erect. Leaves oval-oblong, almost entire, smooth. Umbels stalked. Flowers hermaphrodite. Berries globose. (*Don's Mill.*, ii. p. 32.) A deciduous shrub, growing to the height of 6 ft., in woods and swamps, in Virginia and Carolina. Introduced in 1819. It flowers in May and June, and the berries are black, and 4-seeded.

‡ 24. *R. FRA'NGULA* L. The breaking Buckthorn, or Berry-bearing Alder.

Identification. Lin. Spec., 280.; Don's Mill., 2. p. 32.

Synonyms. Nerprun Bourgène, Aune noir, Fr. glatter Wegdorn, Ger.

Derivation. The name of Frángula, breaking, is applied to this species, from the brittleness of its branches.

Engravings. Eng. Bot., t. 250.; CEd. Fl. Dan., t. 278.; our fig. 209.; and the plate of the species in Vol. II.

Spec. Char., &c. Leaves oval, quite entire, lineated with 10 or 12 lateral nerves, and, as well as the calyx, smooth. Flowers hermaphrodite. (*Don's Mill.*, ii. p. 32.)

A deciduous shrub, or low tree, with stems from 3 to 5 ft. high, in a wild state; but, in cultivation, attaining more than double that height. The branches are numerous, alternate, leafy, round, smooth, and blackish. The flowers are whitish, with purple anthers, and the berries are dark purple, each with two large seeds. A native of Europe, and part of Siberia, in Asia, in woods and thickets. It is not uncommon in England, but rare in Scotland. It is common in all the north of Russia, in Siberia, and Caucasus, and in Taurida. The berries are used by the Russians for dyeing yellow, and the bark for dyeing a tawny colour. From a quarter to half an ounce of the inner bark, boiled in small beer, is a sharp purge. In dropsies, or constipation of the bowels in cattle, it is a very certain purgative. The berries are also purgative, like those of the common buckthorn. These, gathered before they are ripe, dye wool green and yellow; when ripe, blue grey, blue, and green. The bark dyes yellow, and, with a preparation of iron, black. The flowers are particularly grateful to bees. Goats devour the leaves voraciously, and sheep will eat them. The charcoal prepared from the wood is preferred by the makers of gunpowder to any other. The berries of this species, and also of the cornel, are said to have been formerly brought to market for those of the common buckthorn. They are easily distinguished; the true buckthorn having 4 seeds, and this only 2; and the cornel one nut enclosing two kernels. (*Martyn's Miller.*) The plant of this species in the garden of the London Horticultural Society was, in 1835, 8 ft. high, after being 10 years planted; and that at Messrs. Lodiges was still higher in 1833, but it has been since cut down.



209

Variety.

‡ *R. F. 2. angustifolia* Hort., has narrower leaves. The plant of this species in the Horticultural Society's Garden is very distinct, and, in 1835, was 6 ft. high, after being 10 years planted.

‡ 25. *R. LATIFOLIUS* L'Hérit. The broad-leaved Buckthorn.

Identification. L'Hérit. Sert., 5. t. 8.; Dec. Prod., 2. p. 26.; Don's Mill., 2. p. 32.

Engravings. L'Hérit. Sert., 5. t. 8.; Dend. Brit., t. 11.; Willd. Abbild., t. 100.; E. of Pl., No. 2886.; our fig. 210.; and the plate of this tree in Vol. II.

Spec. Char., &c. Leaves elliptical, acuminate, quite entire, lineated with 12 or 15 lateral nerves; younger leaves and calyxes villous. Flowers hermaphrodite. (Don's Mill., ii. p. 32.) A deciduous shrub, with the habit of a low tree; a native of the Azores, on the mountains of St. Michael. Introduced in 1778. It flowers in July, and the berries which succeed them are either red or black, both colours appearing on the same plant. The leaves are larger than those of any other species; and the whole plant is remarkable for its robust appearance, and the conspicuous opposite nerves, which proceed from the middle of the leaves. It deserves a place in every collection. There is a tree of it at Syon 15 ft. high. In London, plants are from 1s. to 1s. 6d. each. At Bollwyller, 1 franc and 50 cents; and at New York, 50 cents.



App. i. *Hardy Species of Rhámnus not yet introduced.*

R. amygdálinus Desf. Atl., 1. p. 198., a native of the north of Africa, in the fissures of rocks, where it grows to the height of 3 ft., and produces berries used for dyeing yellow, like those of *R. saxatilis*.

R. persicifolius Moris. Stirp. Sard. 4to, fasc. 2., a native of Sardinia, and probably only a synonyme of *R. amygdálinus*.

R. prunifolius Smith Prod. Fl. Græc., 1. p. 157., a native of Crete, on the highest mountains, and probably only a variety of one of the preceding sorts.

R. Sibthorpianus Schult. Syst., 6. p. 286.; *R. pubescens* Sibth. Fl. Græc., t. 239., a native of Mount Parnassus, and nearly allied to *R. alpinus*, and *R. Frángula*.

R. Purshianus Dec. Prod., 2. p. 25. (fig. 211.), the *R. alniifolius* of Pursh but not of L'Héritier, a shrub, growing to the height of 6 ft., native of North America, on the banks of the Koorokoosky.

212



211

R. sanguineus Pers., a native of Galicia, on the banks of rivers, where it grows to the height of 6 ft.

R. minutiflorus Pursh, a native of the sea coasts of Carolina and Florida.

The following species probably belongs to another genus; but, not having seen the plant we can say nothing about it of our own knowledge.

R. carpinifolius Pall. Ross., 2. p. 24. t. 60., Willd. Spec., 1101., and N. Du Ham., vol. iii. p. 40., (fig. 212.) is said to be a tree resembling the hornbeam. Pallas says that it abounds in the calcareous mountains of Kutais, in Russia, but that he never saw its flowers. It may possibly be a *Planera*.

App. ii. *Half-hardy, or Green-house, Species.*

R. integrifolius Dec. Hort. Monsp., *R. coriáceus* Nees's *Hort. Phys.*, p. 114. t. 22., is a shrub, a native of Teneriffe, on the highest peak, where it attains the height of 2 ft.; introduced in 1822. and, doubtless, half-hardy.

R. prinoides L'Hérit. Sert., 6. t. 9., *Zizyphus lucidus* *Wenck* is a shrub, growing 10 ft. high in Africa, at the Cape of Good Hope; introduced in 1778.

R. celtidifolius Thunb. is a native of the Cape of Good Hope, not yet introduced.

R. crenulátus Ait. Hort. Kew., 1. p. 263., is a shrub, growing to the height of 6 ft. on the mountains of Teneriffe; in culture in British green-houses in 1778.

R. scrrulátus H. B. et Kunth Nov. Sp. Amer., 7. p. 51. t. 617., is a shrub, growing to the height of 6 ft. in Mexico, not yet introduced.

R. microphyllus Willd. is a trailing shrub, a native of Mexico, resembling *R. oleoides*, introduced in 1823.

R. umbellátus Cav. Icon., 6. p. 2. t. 504., is a shrub, growing 6 ft. high in Mexico.

R. tenuifolius Moe. in Dec. Prod., 2. p. 26., is a native of Mexico, of which little is known.

Besides the above, there are some doubtful green-house species, all of which it would be desirable to procure, in order to prove their degree of hardiness, and assist in reducing this genus to order.

GENUS V.



Ceanothus L. THE CEANOTHUS, or RED ROOT. *Lin. Syst.*
Pentándria Monogýnia.

Identification. Brongn. Mém. Rham., p. 62.; Hook. Fl. Bor. Amer., 1. p. 124.; Dec. Prod., 2. p. 31.; Don's Mill., 2. p. 37.

Synonymes. *Rhamnus speciosus* L., *Juss., Lam.*; *Ceanothe, Fr.*; *Säkebaum, Ger.*

Derivation. From *ceanothus*, a name employed by Theophrastus to designate a spiny plant, derived from *keō*, to cleave: the modern genus has, however, nothing to do with the plant of Theophrastus. The English name red root is given to the plant in America, from the red colour of the roots, which are of a large size in proportion to the branches.

Description, &c. Deciduous shrubs, with large red roots, herbage generally pubescent, with numerous erect branches, seldom exceeding 3 ft. or 4 ft. in height, but, in one or two cases, attaining the height of 6 ft. or 8 ft., with alternate, serrated, 3-nerved leaves, and white, blue, or yellow flowers, in terminal panicles, or in axillary racemes. They are chiefly natives of North America, very ornamental in British gardens, and easily propagated by cuttings of the young wood, planted in sand, and covered with a hand-glass. Most of the species produce seeds freely in British gardens, and they all grow in any common garden soil.

1. *C. AZUREUS* Desf. The azure-flowered Ceanothus, or Red Root.

Identification. Desf. Cat., 1815, p. 232.; Dec. Prod., 2. p. 31.; Don's Mill., 2. p. 37.

Synonymes. *C. caeruleus* Lag. *Gen. et Spec.*, 1816., p. 11., *Lodd. Bot. Cab.*, t. 110.; *C. bicolor* Willd. in *Schult. Syst.*, 7. p. 65.

Engravings. Bot. Reg., t. 291.; *Lodd. Bot. Cab.*, t. 110.; and our fig. 213.

Spec. Char., &c. Leaves ovate-oblong, obtuse, acutely serrated, smooth above, hoary and downy beneath. Thyse elongated, axillary, with a downy rachis. Pedicels smooth. (*Don's Mill.*, ii. p. 37.) A very handsome shrub, with brilliant celestial blue flowers in large panicles; a native of Mexico, where its bark is considered as a febrifuge. Introduced in 1818. It is the most robust-growing species of the genus, attaining, in 3 or 4 years from seed, the height of 5 ft. or 6 ft. or more, against a wall. It was at first treated as a green-house plant, but lately it has been found to be nearly as hardy as the North American species. There is a plant in the Botanic Garden at Kew which has stood out 10 years; one in the Lewisham Nursery which has stood out 4 years as a standard; and one in the Fulham Nursery, 10 ft. in extent, which stands out without any protection whatever.



213

2. *C. AMERICANUS* L. The American Ceanothus, or Red Root; or New Jersey Tea.

Identification. *Lin. Spec.*, 281.; *Dec. Prod.*, 2. p. 31.; *Hook. Fl. Bor. Amer.*, 1. p. 124.; *Don's Mill.*, 2. p. 37.

Engravings. *Duh. Arb.*, 1. t. 51.; *Mill. Ic.* t. 57.; *Bot. Mag.*, t. 1497.; and our fig. 214.

Spec. Char., &c. Leaves ovate, acuminate, serrated, pubescent beneath. Thyse elongated, axillary, with a pubescent rachis. (*Don's Mill.*, ii. p. 37.) A shrub, from 2 ft. to 4 ft. high; a native of North America, in dry woods from Canada to Florida. Introduced in 1713. The leaves and stems of the plant are pubescent; the flowers are small and white; but, being produced in great numbers together, are very ornamental. They appear in June and July, and are succeeded by bluntly triangular fruits, and, about London, in fine seasons, it ripen seeds. It is abundant in most parts of North America, where it is



214

commonly known by the name of New Jersey tea; the leaves having been formerly dried for the same purpose as those of the Chinese tea plant; and for which, according to Pursh, it formed a general substitute during the war of independence. In Canada, it is used for dyeing wool of a nankin, or cinnamon, colour. This shrub will grow in any soil that is tolerably dry, and is not uncommon in British gardens. Plants, in the London nurseries, are 1s. 6d. each, and seeds 1s. per ounce. At Bollwyller, plants are 1 franc each. At New York, plants are 15 cents each, and seeds 1 dollar a quart.

♣ 3. *C. (A.) TARDIFLO'RUS* Horn. The late-flowering *Ceanothus*, or *Red Root*.

Identification. Horn. Hort. Hafn., 230.; Dec. Prod., 2. p. 31.; Don's Mill., 2. p. 37.

Spec. Char., &c. Leaves cordate-ovate, serrated, downy beneath. Thyrses elongated, axillary. (*Don's Mill.*, ii. p. 37.) A native of North America, introduced in 1820, and, in all probability, only a variety of the foregoing species.

♣ 4. *C. OVA'TUS* Desf. The ovate-leaved *Ceanothus*, or *Red Root*.

Identification. Desf. Arb., 2. p. 581.; Dec. Prod., 2. p. 31.; Don's Mill., 2. p. 57.

Spec. Char., &c. Leaves ovate or oval, serrated, smooth on both surfaces, as well as the peduncles. Thyrses short, axillary? (*Don's Mill.*, ii. p. 37.) A native of North America, where it grows from the height of from 2 ft. to 4 ft. It is generally confounded in gardens with *C. americanus*, from which, however, it appears quite distinct. A plant of this species was in Knight's Exotic Nursery, King's Road, in 1830.

♣ 5. *C. INTERME'DIUS* Pursh. The intermediate *Ceanothus*, or *Red Root*.

Identification. Pursh Fl. Sept. Amer., 1. p. 167.; Hook. Fl. Bor. Amer., 1. p. 124.; Dec. Prod., 2. p. 32.; Don's Mill., 2. p. 37.

Spec. Char., &c. Leaves oval-oblong, acute, mucronately serrated, triple-nerved, pubescent beneath. Panicles axillary, on long peduncles, with loose corymbose pedicels. (*Don's Mill.*, ii. p. 37.) A deciduous shrub; a native of North America, in the woods of Tennessee; introduced in 1812, and producing its white flowers in June and July. Height from 2 ft. to 4 ft. This species is readily distinguished from *C. americanus* by its very small leaves, which are not one fourth the size of those of that species.

♣ 6. *C. SANGU'NEUS* Pursh. The bloody-branched *Ceanothus*, or *Red Root*.

Identification. Pursh Fl. Sept. Amer., 1. p. 167.; Hook. Fl. Bor. Amer., 1. p. 125.; Dec. Prod., 2. p. 32.; Don's Mill., 2. p. 37.

Spec. Char., &c. Leaves oblong-ovate, serrated, pubescent beneath. Panicles axillary, thyrsose, on very short peduncles. Pedicels aggregate. (*Don's Mill.*, ii. p. 37.) A shrub, from 2 ft. to 3 ft. in height, found near the Rocky Mountains, on the banks of the Missouri. It is readily distinguished by its branches, which, as the specific name implies, are of a blood-red or purplish colour. The flowers, which appear in May and June, are white, and are produced on panicles not longer than the leaves.

♣ 7. *C. MICROPHY'LLUS* Michx. The small-leaved *Ceanothus*, or *Red Root*.

Identification. Michx. Fl. Bor. Amer., 2. p. 154.; Dec. Prod., 2. p. 32.; Don's Mill., 2. p. 37.

Synonyme. *C. hypericoides* L'Herit. MSS.

Spec. Char., &c. Leaves oblong, obtuse, entire, minute, sub-fasciated, smooth. Branches straight, somewhat decumbent. Corymbs stalked, loose, terminal. (*Don's Mill.*, ii. p. 37.) A shrub growing to the height of 2 ft., found in sandy woods from Carolina to Florida, and introduced in 1806. The leaves are very small, not being more than 3 or 4 lines in length; and the whole plant is of a delicate habit; but it has large red roots, as in all the other species. The flowers are white, and produced in May and June; and they are succeeded by almost globular fruit.

App. i. Other Species of *Ceanothus*.

C. velutinus Hook. Fl. Bor. Amer., i. p. 125. t. 45, (fig. 215.) is a very beautiful species, discovered by Douglas, and described by Professor Hooker from dried specimens in the possession of the London Horticultural Society. The plant grows from 3 ft. to 8 ft. high. The leaves are broad, sometimes subcordate, obtuse, from 3 in. to 4 in. long, and from 3 in. to 3½ in. broad; and the flowers are white, in terminal panicles. The plant is found on subalpine hills, near the sources of the Columbia, and at the Kettle Falls. This seems a very desirable species, and, when introduced, will probably be found the next in beauty to *C. azureus*, which it appears to surpass in robustness of growth.

C. levigatus Hook. Fl. Bor. Amer., i. p. 125., also discovered by Douglas, and described from dried specimens, is probably only a variety of *C. velutinus*. It is found on mountains near the coast of the north-west of America, and at Nootka Sound.

C. thyrsiflorus Esch. Mém. Acad. Scienc. Peters., x. p. 221., Hook. Bor. Amer., i. p. 125., was discovered on the north-west coast of America by Mr. Menzies. The flowers are surrounded by densely imbricated, ovate, and acute bracteas, which drop before the blossoms are expanded. The calyx is blue, and the petals white. The whole plant turns black in drying.



We have little doubt that all the above species would cross-fecundate, and, consequently, that the beautiful ultramarine blue of the flowers of *C. azureus*, or some portion of it, might be given to *C. americanus*, which would be a very desirable acquisition. Indeed, there is such a close general resemblance between all the sorts described, that we cannot help suspecting that they are only races or varieties of one or two original forms. *C. azureus*, *C. americanus*, and *C. velutinus* when it can be got, ought to be in every collection. Where there is a conservative wall, and the choice is limited to half a dozen or a dozen plants, *C. azureus*, which continues in flower during the greater part of summer, ought undoubtedly to be one of them.

App. I. *Half-hardy Genera and Species of the order Rhamnaceæ.*

Sphærocarya (from *sphaira*, a sphere, and *caryon*, a nut) *cœulis* Wall. Fl. Ind., ii. p. 371., Don's Mill., ii. p. 27., is a native of Nepal, in forests, producing a fruit of a pale brown colour, the flesh of which is eaten by the inhabitants. It grows to a tree of 40 ft. in height, with ovate, alternate, smooth leaves, and racemes of greenish inodorous flowers. When introduced, it will probably be found not more tender than other Nipal trees.

Condalia (in honour of *Anthony Condal*, M.D., the companion of Loeffing in his voyages) *microphylla* Cav. Icon., 6. p. 16. t. 525., Don's Mill., 2. p. 27., (fig. 216.) is a spiny shrub, a native of Chili, a good deal resembling a *Zizyphus*.

Sageretia (named in honour of *M. Sageret*, member of the Royal Agricultural Society of Paris, a vegetable physiologist) *Theezans* Brongn. *Mém. Rham.*, p. 52., Don's Mill., ii. p. 28.; the *Rhâmnus Theezans* of Lân. *Mém.*, 207., and the *R. Thèa* of Osb. *Itin.*, 232., is a shrub growing to the height of 4 ft., a native of China, where it is said the poor make use of the leaves instead of those of the true tea. The branches are divaricate, spiny at the apex. Leaves ovate, smooth, serrulated. Flowers somewhat paniced, glomerated, in terminal spikes, greenish. This species has not yet been introduced; though there are plants bearing the name of *Rhâmnus Theezans* in the garden of the London Horticultural Society, growing with great luxuriance, which appear to be only a variety of *Rhâmnus Alaternus*.

S. oppositifolia Brongn., the *Zizyphus oppositifolia* of Wall., and *S. hamôsa* Brongn., the *Zizyphus hamôsa* of Wall., are Nepal climbing shrubs, which have not yet been introduced; and which, though marked as requiring the green-house, would doubtless stand against a conservative wall.

Scitïa (from *scutum*, a shield; in allusion to the form of the disk of the flower) *capensis* Brongn. *Mém. Rham.*, p. 55., Don's Mill., ii. p. 33.; the *Rhâmnus capensis* of Thunb., and *Ceanôthus capensis* of Dec., is a Cape shrub, growing to the height of 4 ft.; introduced in 1823, and sometimes to be found in green-houses.

Retanilla (*retanilla* is the aboriginal name in Peru) *obcordata* Brongn. *Mém. Rham.*, p. 57., Don's Mill., ii. p. 34., the *Rhâmnus Retanilla* of Domb., and the *Collètia Retanilla* of Vent. Hort. Cels., t. 92., is a twiggy shrub, with white flowers, a native of Peru, where it grows to the height of 3 ft. *R. E'phedra* Brongn., the *Rhâmnus E'phedra* of Domb., and the *Collètia E'phedra* of Vent. Choix., t. 16., is also a native of Peru. Both these shrubs are in the country, and are kept in green-houses; but we have little doubt of their being as hardy as the plants of the genus *Collètia*.

Collètia (named by Commerson in honour of his friend and countryman *Collet*, who wrote upon the plants of Brest) *spinôsa* Kunth *Nov. Gen. Amer.*, 7. p. 58., Hook. *Bot. Miscel.*, 1. p. 153. t. 44 A., (fig. 217.) the *Collètia polyacantha* of Willd., is a native of Chili, Peru, and also of Brazil. It is a shrub with few and small leaves, but with numerous, very strong, awl-shaped spines. The flowers are of a reddish yellow, and whitish in the centre. This shrub has been tried in the open air, both against a wall and in the open border, in the Horticultural Society's Garden; and, in 1835, it had stood three years, without any protection, flowering freely in the summer season, from May to August. It has stood out for three winters in the open border in Buchanan's Nursery, Camberwell, without any protection, and against a wall in the Fulham Nursery. We think we can safely recommend it as a shrub for the open border, at least in dry sheltered situations.

C. serratifolia Vent. Choix., t. 15.; the *Rhâmnus Spârtium* of Domb., also from Peru; *C. cruciata* Gill. et Hook. *Bot. Misc.*, 1. p. 152. t. 43, from sandy hills in La Plata; *C. ferox* Gill. et Hook., from Chili; *C. ulicina* Gill. et Hook., the ulex, or furze-like *Collètia*, also from Chili; *C. Chacaye G. Don*, the *Rhâmnus Chacaye* of Domb., from Peru; and *C. tetragona* Brongn., also from Peru; are probably as hardy as *C. spinôsa*. They will grow in any common garden soil, and are propagated by cuttings or seeds.

Trevoia (from *Trevo*, the name of some Spanish botanist) *quinquenervis* Meyers in Hook. *Bot. Misc.*, 1. p. 158. t. 45. B., and Don's Mill., 2. p. 35., and *T. trinervis*, are spiny shrubs, growing to the height of 4 ft. or 6 ft.; natives of Chili, on the Andes, and probably as hardy as *Collètia*. The last species was introduced in 1828.

Discaria (from *discus*, a disk; the disk of the flower being very broad) *americana* Hook. *Bot. Misc.*, 1. t. 44. D., is a spiny shrub, a native of Buenos Ayres; and *D. australis* Hook. is a native of New Holland; neither of which has yet been introduced.

Hovenia (in honour of *D. Hoven*, a senator of Amsterdam, who contributed to the success of the travels of Thunberg by his good offices) *dileis* Thunb. is a fruit tree of Japan, where it is called *ken*, and *kenpokonus*. It has large, cordate, acuminate leaves, and small white flowers. The fruit is said to contain a sweet red pulp, which has a taste somewhat like that of a pear. It was introduced in 1812; and a plant of it in the Botanic Garden at Kew has stood against a south wall since the year 1816. Another has stood in the Horticultural Society's Garden since the year 1816; in both gardens, they have attained the height of the wall; and, though the young shoots are generally killed back in winter, when they receive no protection, yet the plants grow vigorously during every summer. The tree, which grows to the height of 12 ft. in its native country, is figured in *Kämpfer's Amœn. Ex.*, 2. p. 809. In 1830 there was a plant of this species in Knight's Nursery, 10 ft. high, in a pot.

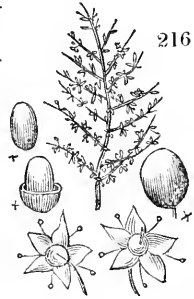

216

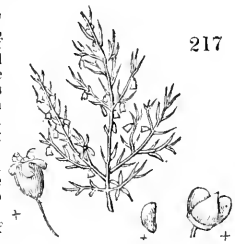

217

Colubrina (from *coluber*, a snake; in allusion to the twisted stems) *triflora* Brongn. and Don's Mill., 2. p. 36, the *Rhamnus triflorus* of Moc. et Sesse; and *C. Mociniana* G. Don, the *Ceanothus Mocinianus* of Dec., are Mexican shrubs; the latter introduced in 1824. There are some Nepal species of this genus, not yet introduced, which will probably be found harder than those from Mexico.

Willemia (in honour of *C. L. Willemet*, author of *Herbarium Mauritanium*) *africana* Brongn. and Don's Mill., 2. p. 38.; the *Ceanothus africanus* of Lin. Seb. Thes., 1. t. 22. f. 6, is a Cape shrub, which has been an inhabitant of our green-houses since 1712. It is readily distinguished by its purplish red branches, and lanceolate, serrated, shining leaves. It is an elegant shrub, considering the order to which it belongs; and, on a conservative wall, would deserve the preference to any that we have enumerated.

Pomaderris (from *pōma*, a lid, and *aeris*, a skin; in allusion to the membranous covering to the capsule) *elliptica* Labill., Don's Mill., 2. p. 38., Sims Bot. Mag., t. 1510, (fig. 218.) is a

218



219



shrub from Van Diemen's Land, growing to the height of 6 ft., and introduced in 1805. It bears a general resemblance to *Ceanothus azureus*; but it has smoother and more shining foliage, and cream-coloured flowers. Being a native of Van Diemen's Land, it will probably be found tolerably hardy. There are several other Australian species, and some from the South Seas, which will be found enumerated in Don's *Miller*, and in our *Hortus Britannicus*, all of which might be tried against a conservative wall.

The genera *Cryptandra* Smith, *Bartlingia* Brongn., *Solenanthes* G. Don, *Tetrapasma* G. Don, *Trichocéphalus* Brongn., *Phyllica* Lin., *Soulangia* Brongn., *Gouania* Jacq., *Carpodetus* Forst., and *Oleina* Thunb., all afford ligneous plants, marked in Don's *Miller* and in our *Hortus Britannicus* as inhabitants of the green-house; but, as far as we have observed, none of them have been tried against a conservative wall, except *Phyllica ericoides* Lin. (Bot. Mag., t. 224., and our fig. 219.), which is a heath-like

shrub, growing from 2 ft. to 3 ft. in height; and producing white flowers from April to September, which, in dry warm situations, on sandy soil, will pass the winter in the open air, with a little protection.

CHAP. XXXVI.

OF THE HALF-HARDY LIGNEOUS PLANTS OF THE ORDER BRUNIA'CEÆ.

THERE are nine genera included in this order in Don's *Miller*; and the species are mostly natives of the Cape. They are "much branched heath-like shrubs, with small, smooth, or hardly pilose leaves," and small, capitate or rarely paniced, spiked and terminal, or solitary flowers. They almost all require a heath soil, and to be propagated by cuttings, in the manner of heaths. Many of them are, doubtless, as hardy as some of the Cape heaths have been proved to be; and, where there is an extensive range of conservative walling, a few of each genus might be tried against it. Even if they did not live through the winter, their foliage and flowers, during summer, would be interesting and ornamental, and a stock of plants for turning out annually might be kept in pits.

CHAP. XXXVII.

OF THE HARDY OR HALF-HARDY LIGNEOUS PLANTS OF THE ORDER HOMALINA'CEÆ.

DISTINCTIVE Characteristics. Calyx funnel-shaped, its tube usually adnate to the ovary, its limb with 5—15 lobes. Petals inserted into the calyx, as many as its lobes, alternate with them, smaller than they, and deemed by some an inner whorl of lobes of the calyx. Glands present in front of the segments of the calyx. Stamens arising from the base of the petals, either singly, or in threes or sixes. Anthers 2-celled, opening longitudinally. Ovary 1-celled, with numerous ovules. Styles 3—5, simple. Ovules attached to as many parietal placentas as there are styles. Fruit berried or capsular. Seeds small, ovate, or angular, with an embryo in the middle of fleshy albumen. Trees or shrubs. Leaves alternate, with deciduous stipules, toothed or entire. Flowers in spikes, racemes, or panicles. (*Lindley Introd. to N. S.*, p. 79., adapted.) The ligneous species and varieties of which there are living plants in British col-

lections are four: *Aristotelia Macqui*, and the variety of this with variegated leaves; and two species of *Azara*: both genera are natives of Chili. The genus *Aristotelia* is considered by botanists as only allied to *Homalonææ*; but we have placed it first in our enumeration, as being both the most conspicuous, and the hardiest plant of the order.

ARISTOTELIA L'Hérit. Calyx deeply 5-cleft. Corolla of 5 petals, inserted into the bottom of the calyx. Stamens 15—18, 3—4 in a fascicle in front of each lobe of the calyx. Ovary free. Fruit a globose berry, 3-celled, the cells 2-ovuled, 1—2-seeded. (*Dec. Prod.*, ii. p. 56.)

AZARA R. et P. Calyx 4—7-parted. Corolla none. Stamens numerous, inserted into the base of the calyx. Fruit a globose berry, 1-celled, 5-seeded from abortion; seed covered with a spongy aril when mature. (*Don's Mill.*, ii. p. 55.)

GENUS I.



ARISTOTELIA L'Hérit. THE ARISTOTELIA. *Lin. Syst.* Polyadélphia Polyándria.

Identification. L'Hérit. *Stirp.*, p. 31; *Dec. Prod.*, 2. p. 56; *Don's Mill.*, 2. p. 58.

Derivation. Named in commemoration of Aristotle, the celebrated philosopher and naturalist.

■ 1. A. *MACQUI* L'Hérit. The Macqui Aristotelia.

Identification. L'Hérit. *Stirp.*, p. 31; *Dec. Prod.*, 2. p. 56; *Don's Mill.*, 2. p. 58.

Synonymes. *A. glandulosa* R. et P. *Fl. Per. Syst.*, p. 126., *Poir. Suppl.*, 587; *A. Macqui* in *Dec. Prod.*, 2. p. 56.

Engravings. L'Hérit. *Stirp.*, t. 16; *Lam. Ill.*, t. 369; *Wats. Dend. Brit.*, t. 44.; *N. Du Ham.*, t. 33; *Otto*, t. 88.; *E. of Pl.*, No. 6597.; and the plate of this tree in our Second Volume.

Variety.

■ A. M. *2-fôlius variegâtis.* The variegated-leaved Macqui Aristotelia.

Description, &c. The species is a shrub with spreading branches and persistent leaves, which are almost opposite, with obvious petioles, and disks that are oblong, acute, more than 2 in. long, and about 1 in. broad, dentately serrate, glabrous, and of rather a full green colour. There are stipules, but they fall off. The flowers are small, green, and yellow, disposed in axillary racemes: some of the stamens are sterile. It is a native of Chili, where it forms an evergreen shrub, with diffuse branches, growing to the height of 6 ft. The flowers are not very showy; but, in Chili, they are succeeded by berries about the size of a pea, very dark purple, and at length becoming black. They are acid, eatable; and the inhabitants make a wine from them, which they give in malignant fevers. In British gardens, it forms a sub-evergreen shrub or low tree, of very vigorous growth; so much so, in a young state, that, from the shoots not being matured, they are frequently killed down to the ground, and the foliage more or less injured. Notwithstanding this, the aristotelia frequently flowers, and, against a wall, ripens fruit; and, in all probability, if the tree were planted in dry and rather poor soil, so as to grow slowly, and not make more wood every year than it could ripen properly, it would attain a large size, and form a very handsome hardy evergreen shrub or tree. There is a plant of it at Oriel Temple, near Dublin, which, in twenty years, has attained the height of 16 ft.; and there are specimens in most botanic gardens. There is a large one at Messrs. Loddiges's, and one in the garden of the London Horticultural Society, as a low bush, which, in 1835, flowered freely. There is a tree at Syon, 18 ft. high. A standard in our garden at Bayswater has stood since 1831, without the slightest protection, and flowers freely; it is trained to a single stem, and is 8 ft. high; but would probably have been twice that height if we had not been obliged to mutilate it for want of room. The plant grows vigorously in any common garden soil,

producing shoots 3 ft., 4 ft., or 5 ft. in length, when young; and it is readily propagated by cuttings, or by layers. The latter mode is generally adopted in British nurseries. Plants, in London, are 2s. 6d. each. In the case of the aristotelia and of all other shrubs or trees that are rather tender, it is very desirable, in cold situations north of London more especially, to have reserve plants, against a wall, or in pots, from which cuttings may be taken when wanted, to supply any deaths which may occur in the open garden.

GENUS II.



AZARA R. et P. THE AZARA. *Lin. Syst.* Polyándria Monogýnia.

Identification. R. et P. Fl. Per. et Chil. Prod., 1. p. 76. t. 36; Syst., p. 137.; D. Don, in Edin. N. P. Journ. Jan. 1831; Don's Mill., 1. p. 297., 2. p. 55.

Derivation. In honour of Joseph Nicholas Azara, a Spanish promoter of science, and of botany in particular. (Don's Mill., i. p. 297.)

Description, &c. The species are leafy evergreen shrubs or trees, with alternate, simple, stalked, stipulate leaves, which are bitter to the taste; and flowers disposed in corymbs or spikes, fragrant.

■ 1. A. DENTATA R. et P. The toothed-leaved Azara.

Identification. R. et P. Fl. Per. et Chil. Syst., 1. p. 138.; Fl. Per., 5. t. 465. fig. a; Dec. Prod., 1. p. 262.; Don's Mill., 1. p. 297., 2. p. 55, 56.

Engravings. R. et P. Fl. Per., 5. t. 465. fig. a; Bot. Reg., t. 1788.; and our fig. 220.

Spec. Char., &c. Leaves ovate, serrated, scabrous, tomentose beneath. Stipules leafy, one large, the other small. Corymbs sessile, few flowered. Calyx 5—7-parted, spreading, with the segments somewhat imbricate in aestivation. Stamens numerous, many of them sterile. (Don's Mill., ii. p. 55, 56.) An evergreen shrub or low tree, growing to the height of 12 ft. in its native country (Chili), in groves about Concepcion, where it is called Corcolen. It was introduced into England in 1830, or before, and flowered against a wall in the garden of the London Horticultural Society in 1835. The following particulars respecting it are from the *Bot. Reg.*, t. 1788. Branches pubescent. Leaves oblong, from 1 in. to 2 in. long, crenately sawed, deep, bright green, remarkably glossy. Flowers small, devoid of corolla, yellow in the anthers, which are protruded a little beyond the calyx, disposed in corymbose clusters that are shorter than the leaves, fragrant. *A. dentata*, in England, nailed to the south face of a wall, and protected from wet in winter, forms a very handsome evergreen bush. No drought seems to affect it; for, after nearly two months of the hottest and driest weather known in England, its leaves were perfectly fresh and green. (*Bot. Reg.*, Sept. 1835.)



■ 2. A. INTEGRIFOLIA R. et P. The entire-leaved Azara.

Identification. R. et P. Syst. Fl. Per. et Chil., 1. p. 138.; Fl. Per. 5. t. 466. f. a; Dec. Prod., 1. p. 262.; Don's Mill., 1. p. 297., 2. p. 56.; Gard. Mag., 10. p. 285.

Engraving. R. et P. Flor. Per., 5. t. 466.

Spec. Char., &c. Leaves obovate or oblong, entire, smooth. Stipules equal, permanent. Flowers spiked. Calyx with a connivent 4-cleft limb, furnished with scales on the inside, valvate in aestivation. Stamens not numerous, all fertile, disposed in fascicles opposite the lobes of the calyx. (Don's Mill., ii. p. 56.) An evergreen shrub, a native of Chili, growing to about 12 ft. high, and found in groves about Concepcion, where it, as well as *A. dentata*, is called Corcolen. Mr. Knight of the Exotic Nursery, Chelsea, raised, in 1832, plants of this species from seeds obtained of Mr. Cuming, who had imported them from their native country. It is probably only a variety of the preceding. *A. serrata* R. et P., another species, is described in *Dec. Prod.* and *Don's Mill.*, 2. p. 56. This is a native of the same locality as the others, and is also a shrub 12 ft. high. All three are, probably, varieties of the same species.

App. i. Other hardy or half-hardy ligneous Species of Homalinææ.

Blackwellia nepalensis Dec. is a Nepal shrub, with ovate leaves and whitish flowers.—*Astránthus cochinchinensis* Lour. (*Don's Mill.*, 2. p. 57.) is a tree with ovate, serrated, lanuginous leaves, and white flowers in long spikes, introduced in 1825.—*Neillia thyrsiflora* D. Don, and *N. rubriflora* D. Don (*Don's Mill.*, 2. p. 57.), are hardy Nepal shrubs, with the habit of *Spiræa*; but they have not yet been introduced. The last generic name was given by Professor Don, in honour of his friend Patrick Neill, Esq., LL.D. F.R.S.E. and F.L.S., Secretary of the Wernerian and Horticultural Societies of Edinburgh; a gentleman who has been a great encourager of botany and gardening for many years, and to whose zeal and activity, and the universal esteem in which he is held in his native country, the Caledonian Horticultural Society owes its existence, and, in a great measure, its present prosperous state.

CHAP. XXXVIII.

OF THE HARDY OR HALF-HARDY LIGNEOUS PLANTS OF THE ORDER
ANACARDIA\CEÆ.

Identification. Lindley, in *Intro.* to *N. S.*

Synonymes. *Terebinthaceæ*, tribe 1. *Anacardiæ R. Br.*, and tribe 2. *Sumachinæ* Dec. *Prod.*, 2. 66.

Distinctive Characteristics. Calyx in 5, occasionally in 3—4, or 7, divisions. Petals the same in number, inserted, in most, along with the stamens, into a perigynous disk: in some, not any. Sexes hermaphrodite, diœcious or polygamous. Stamens equal in number to the petals, and alternate with them, or twice as many, or even more. Ovary simple, superior. Seeds solitary. Leaves alternate. (*Lindl. Intro. to N. S.*) Low deciduous or evergreen trees, natives of Asia and Africa.

GENUS I.

PISTA\CIA L. THE PISTACHIA TREE. *Lin. Syst. Diœ\cia Pentândria.*

Identification. *Lin. Gen.*, 1108.; *Dec. Prod.*, 2. p. 64.; *Don's Mill.*, 2. p. 61. and 65.

Synonyme. *Terebinthus Juss.*

Derivation. From the Greek word *Pistakia*, derived, according to some, from *Psittakion*, the name of a city; and, according to others, from the Arabic word *Foustaq*, the Arabian name of *Pistacia vera*.

Gen. Char. The sexes are diœcious, and the flowers without petals. In the male plants, the flowers are disposed in racemes that resemble catkins; every flower is bracteate by a scale; the calyx is 5-cleft; and the stamens are 5, inserted into a calycine disk, or into the calyx, and have 4-cornered, almost sessile, anthers. In the female plants, the flowers are disposed in a raceme, less closely than in the male; the calyx is 3—4-cleft; the ovary is 1—3-celled; the stigmas are three, and thickish; and the fruit is a dry ovate drupe, the nut of which is rather bony, and usually 1-celled, though sometimes it shows two abortive cells at the side; the cell contains a single seed, which is affixed to the bottom. The cotyledons of the seed are thick, fleshy, and oily, and bent back upon the radicle. The species are trees, with pinnate leaves. (*Dec. Prod.*, ii. p. 64.)

‡ 1. *P. VE\RA* *Lin.* The true Pistachia Nut Tree.

Identification. *Lin. Spec.*, 1454.; *Dec. Prod.*, 2. p. 64.; *Don's Mill.*, 2. p. 65.

Synonymes. *Pistacia officinarum Hort. Kew.*; *Pistachier, Fr.*; *Pistacie, Ger.* *Pistacchio, Ital.* 2 *Engravings.* *Blackw. Icon.*, t. 461.; *N. Du Ham.*, 4. t. 17., and our *fig.* 221.

Spec. Char., &c. Leaves deciduous, impari-pinnate, of 3—5 leaflets, rarely of 1; the leaflets ovate, a little tapered at the base, indistinctly mucronate at the tip. (*Dec. Prod.*, ii. p. 64.) A tree, a native of Syria, growing to the height of 20 ft. Introduced in 1770.

Varieties. The following are considered by some authors as species:—

‡ *P. v.* 2 *trifolia* *Lin. Spec.*, 1454., *Bocc. Mus.*, ii. t. 93., has leaves usually of 3 leaflets.

‡ *P. v.* 3 *narbonensis* *Bocc. Mus.*, t. ii. 693.; *P. reticulata Willd.* and *Don's Miller*; has pinnate leaves, the leaflets having prominent veins. A plant of this variety, as a bush, in the open garden of the Horticultural Society, was, in 1834, 5 ft. high, after having been 6 years planted. According to the *Nouveau Du Hamel*, these sorts differ only in the size, shape, and consistency of the leaflets, and are by no means entitled to be considered as species.

Description, &c. The trunk of this tree is clothed with grey bark. The branches are spreading, but not very numerous; and they are furnished with winged alternate leaves, on long petioles. The fruit is oval, about the size of an olive: it is reddish and furrowed, and it contains a kernel, oily and mild to the taste. It is a native of Syria, Barbary, Persia, and Arabia. It was brought from Syria to Italy by the Emperor Vitellius, whence it found its way to the south of France, where it is so far naturalised as to appear, in some places, like a native. (See 134.) It is cultivated in the south of France, and in Italy, for its fruit, which is sometimes eaten raw, but more frequently in a dried state, like almonds. They are most generally used on the Continent as sugar-plums,

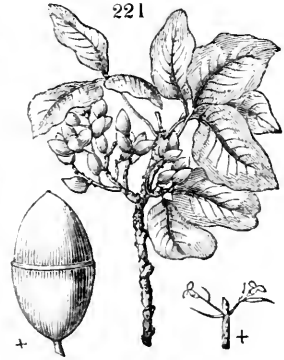

being covered with sugar, or with chocolate, under the name of diabolins: creams and ices are also composed of them, coloured green with the juice of spinach. Generally, the fruit is said to be a fortifier of the stomach, and to diminish coughs and colds. There is a nut imported from the West Indies, under the name of pistachia nut, which is the produce of quite a different plant, probably a palm. In British gardens, the tree is not much planted, from its being generally supposed to require a wall; but, in favourable situations, it will grow as a standard or a bush; as is proved by a plant in the garden of the London Horticultural Society, which has stood there for 5 or 6 years without any protection. It will grow in any common garden soil, and may be propagated, either by nuts procured from abroad, or even from the Italian warehouses in England, or by cuttings. Miller says, if planted against high walls, with a warm aspect, or as standards in a sheltered situation, they will bear the cold of our ordinary winters very well; but, in severe frosts, they are often destroyed. The tree, he says, flowers, and produces fruit freely in England; but the summers are not warm enough to ripen the nuts. He mentions a tree, in the Bishop of London's garden at Fulham, upwards of 40 years old, planted against a wall; and another, which had been planted as a standard, in the Duke of Richmond's grounds, at Goodwood, in Sussex, where it had stood many years without the slightest protection. Till lately, there was a very fine specimen at Syon. The foliage of the tree is so ornamental, that no conservative wall ought to be without one.

† 2. *P. TEREBINTHUS* Lin. The Turpentine Pistachia, or Venetian, or Chian, Turpentine Tree.

Identification. Lin. Spec., 1455; Dec. Prod., 2. p. 64; Don's Mill, 2. p. 65.

Synonymes. *T. vulgaris* Tourn. Inst., 579; *P. vera* Mill. Dict., No. 4; Pistachier Térébinthe, Fr.; Terpentin Pistacie, Ger.; Terebinto, Ital.

Engravings. Woodv. Med. Bot., 415. t. 153; Blackw, t. 478.; Duh. Arb., ed. 1. vol. 2. t. 87.

Spec. Char., &c. Leaves deciduous, impari-pinnate, of about 7 leaflets, that are ovate-lanceolate, rounded at the base, and at the tip acute and mucronate. (Dec. Prod., ii. p. 64.) A tree, growing to the height of 30 ft. in the south of Europe and north of Africa. Introduced in 1656.

Variety.

‡ P. T. 2 *sphærocârpa* Dec. Prod., ii. p. 64. The round-fruited Turpentine Pistachia Tree.—Its fruit is larger and rounder than that of the species. (*J. Bauh. Hist.*, i. p. 278. ic.) It is said to be a native of the East. Requier has seen a cultivated plant of this variety in a garden at Nismes. (Dec. Prod., ii. p. 64.)

Description, &c. The general appearance of the tree is that of *P. vera*, but the leaves are larger, and the fruit only a third of the size; the leaflets are, also, lanceolate, instead of being subovate. The fruit is round, not succulent.

and somewhat furrowed; at first green, and afterwards reddish; but black, or of a very dark blue, when ripe. The leaves and flowers emit a very resinous odour, which spreads to a considerable distance, more especially at sunset, when the dew is falling, after a very warm day. Gerard, in describing this tree, says that its kernel is "clammie, full of fat, and oilous in substance, and of a pleasant savour. This plant beareth an empty cod, or crooked horne, somewhat reddish, wherein are found small flies, wormes, or gnats, bred and ingendered of a certaine humorous matter, which cleaveth to the inner sides of the said cods or hornes; which wormes have no physicall use at all." (*Johnson's Gerard*, p. 1434.) Exceedingly good figures of the male and female trees are given by Gerard, in which the pods, or horns, produced by the insect (a species of *Cynips*) when depositing its eggs, are exhibited as about the same length as the leaves. Oliver states that these excrescences contain a small portion of very limpid and odoriferous resin. The turpentine is procured from the *P. Terebinthus*, by making numerous slight incisions in the trunk and principal branches, from the ground as high up the trunk as a man can reach, from the 15th to the 20th of July, according to the Greek calendar. The terebinth oozes out of the wounds made in the bark, and, in a few days, becomes hard and dry by exposure to the air; as in the case of the resins produced by the pine tribe, and with resins generally. The colour is a bluish or greenish white. It is collected every morning from the wounds in the trees with a spatula; and is purified from any extraneous matters that may have stuck to it, by liquefaction by solar heat, and by passing it through a sieve. The largest trees, of 50 or 60 years' growth, with trunks 4 ft. or 5 ft. in circumference, do not yield above 10 oz. or 12 oz. annually: hence the high price of the article, and its adulteration with Venice turpentine, which is produced from the larch; or with common turpentine, which is drawn from the Scotch pine. The terebinth which is pure is called the Chian, or Cyprus turpentine (from Chios, the ancient name of Scio); and, when unadulterated, it is known from the common turpentine by being thicker, and possessing a far more agreeable odour; it is also destitute of bitterness and acidity.

In consequence of the small quantity of terebinth produced by the trees in Scio, a correspondent of Du Hamel's suggests the idea of grafting the *P. vera*, or edible-fruit-bearing species, on the upper parts of trees of *P. Terebinthus*, in order to render them more profitable. He states that he has seen this done in a garden at Naples, and that the fruit was much larger and better than it was on those trees which had not been grafted; while the stocks produced as much resin as the ungrafted plants of the same species. In British gardens, the tree is not very common: the largest specimen that we know of it is a female plant, in the north-east corner of the Chelsea Botanic Garden, 22 ft. high, that flowers every year, and produces fruit, which, though not fecundated, attains the size of small peas. This species is generally considered as the hardiest of the genus, and, with *P. vera*, may be planted in warm sheltered situations in the open border.

† 3. *P. LENTI'SCUS* Lin. The Mastich Tree.

Identification. Lin. Spec., 1455; Dec. Prod., 2. p. 65.; Don's Mill., 2. p. 66.

Engravings. Woodv. Med. Bot., t. 152; Black, t. 195.; Duh. Arb., ed. nov., 4. t. 18.; and our fig. 222.

Spec. Char., &c. Evergreen. Leaves abruptly pinnate; the leaflets 8, lanceolate; the petiole winged. (*Dec. Prod.*, ii. p. 65.) A native of Southern Europe, Northern Africa, and the Levant.

Varieties.

† P. L. 2 *angustifolia* Dec., *P. massiliensis* Mill. *Dict.*, *P. angustifolia* *massiliensis* *Tourn.*, has leaflets almost linear, and the tree seldom exceeds 10 ft. in height.

† P. L. 3 *chia* N. Du Ham., iv. p. 72., *P. chia* *Desf. Cat. Hort. Par.*, a native of Scio, where it produces the mastich.

Description, &c. The species bears a general resemblance to the two preceding ones, in summer, when they are clothed with foliage; but it differs from them in being evergreen, and in having the leaves much smaller. Fabricius has observed that the male plant sometimes produces hermaphrodite flowers, with three stamens and five styles. Gouan has remarked that the buds in this species are different from what they are in the other sorts; the branch-bearing buds being terminal, and the flower buds axillary. The leaves have sometimes 5 leaflets on each side; and the petioles are so much winged as to appear like pinnae. The tree is a native of the south of Europe, and the north of Africa. It grows to the height of 20 ft., and is cultivated in gardens, as well as being found in a wild state. Desfontaines, who travelled in Barbary, states that the tree in that country, though punctured as it is in the Island of Scio, yet does not yield mastich; but that the wood gives out an aromatic smell when burned, and the berries yield an oil fit both for the lamp and for the table. The great source of the mastich of commerce is the Island of Scio, where it is obtained from the trees in the same manner as the Chian turpentine. The quantity produced there averages, according to Olivier, 125,000 lb. annually: but, according to Macculloch, the annual produce is 1500 cwt. The tree was introduced into British gardens in 1654; but it is not very common there. It is not so hardy as *P. Terebinthus*, and should always be planted against a wall.



✚ 4. *P. ATLAN'TICA* Desf. The Mount Atlas Mastich, or Turpentine Tree.

Identification. Desf. Atl., 2. p. 364.; Dec. Prod., 2. p. 64.; Don's Mill., 2. p. 66.

Spec. Char., &c. Leaves deciduous, impari-pinnate. The leaflets about 9, lanceolate, a little tapered at the base. The petiole between the terminal pairs of leaflets somewhat winged. (*Dec. Prod.*, ii. p. 64.) A native of sandy places in Barbary and about Constantinople.

Variety. ✚ *P. a. 2 latifolia* Dec. Prod., 2. p. 64., has leaflets rounded, broader at the base than those of the species. It was found in the Isle of Scio by Olivier.

Description, &c. The species is a deciduous tree, with a large roundish head, growing to the height of 40 ft. in Barbary, near Coffa, not far from Mount Atlas; where, from being found in rows, it appears to have been in a state of cultivation. The variety with broad leaves is found in the Island of Scio, and also about Constantinople. The drupe of this tree is about the same size as that of the *Pistacia Terebinthus*; but the tree seems to be rather more prolific of resin. Desfontaines, who discovered this species, and first described it, says that the resin oozes from the trunk and branches at different seasons of the year, but especially in summer; and that, in property, in smell, and in taste, it is scarcely to be distinguished from Oriental mastich. The Arabs collect it in autumn and winter, and chew it to improve their breath, and give brightness to their teeth; and the Moors eat the fruits, and bruise them to mix with their dates. This tree is rarely to be met with in British gardens.

GENUS II.



RHUS L. THE RHUS, or SUMACH. *Lin. Syst.* Pentándria Trigýnia and Diœ'cia Pentándria.

Identification. *Lin. Gen.*, 369.; *Lam Ill.*, t. 207.; *Kunth Gen. Tereb.*, p. 5.; *Dec. Prod.*, 2. p. 66. Don's Mill., 2. p. 61. and p. 69.

Derivation. From *rhous*, or *rhous*, Greek, which is derived from *rhudd*, a synonyme of *rud*, Celtic, red; in allusion to the colour of the fruit and leaves of some of the species in autumn. (*Don's Mill.*, n. p. 69.) Donnegan has given the following explanation of the word *rhous*:—"A species of

small tree, the rind of which was used for tanning, and the fruit as a spice (*Theophrast. H. Pl.*, 3. 18.); supposed to be some variety of the *Rhús Cótinus*." And others derive *Rhús* from the Greek verb *rhéo*, I run, from the habit of the roots running and spreading under ground to a considerable distance from the tree. Sumach is derived from *Símaq*, the Arabic name of the plant.

Gen. Char. Sexes hermaphrodite, diœcious, or polygamous. *Calyx* small, 5-parted, persistent. *Petals* ovate, and inserted into a calycine disk, or into the calyx. *Stamens* 5, inserted into a calycine disk; all of them in the flowers of the male and hermaphrodite sexes bearing anthers. *Ovary* single, perhaps from defect, subglobular, of 1 cell. *Styles* 3, short, or not any. *Stigmas* 3. Fruit an almost dry drupe of 1 cell, with a bony nut, which includes a single seed; and, in some instances, 2—3 seeds: when one, perhaps, by defect. Each seed is pendulous by a thread (the raphe), that arises from the bottom of the cell. *Cotyledons* leafy, their edges, on one side, and the radicle, in contact. (*Dec. Prod.*, ii. p. 66., and *Wats. Dend.*)—Deciduous shrubs, generally with alternate compound leaves; natives of Europe, Asia, and North and South America. The leaves vary much, both in form and magnitude; and they generally die off, in autumn, of a dark red, or a bright scarlet, or yellow; on which account, at that season, they are very ornamental. Most of the species are poisonous, some of them highly so; and they all may be used in tanning, and dyeing yellow or black. They are all easily propagated by cuttings of the root, and some of them by cuttings of the branches.

§ i. *Cótinus* Tourn.

Sect. Char. Leaves undivided. Flowers hermaphrodite.

■ 1. *R. Co'tinus* L. The *Cotinus* Rhus, or *Venetian Sumach*.

Identification. Lin. Spec., 383; Dec. Prod., 2. p. 67.; Don's Mill., 2. p. 69.

Synonymes. *Cótinus Coggýgria Scop. Carn.*, ed. 2. No. 368.; *Mœnch Meth.*, 73.; *Cótinus coriácea*

Duh. Arb., 1. t. 78.; *Venus Sumach*, Venice Sumach, wild Olive; Sumach Fustet, or Arbre aux

Péruques, Fr.; Perücken Sumach, Ger.; *Scotino*, Ital.

Derivation. The term *Cótinus* is derived from *cotinos*, a name under which Pliny speaks of a tree

with red wood, which is supposed to grow in the Apennines. (*Don's Mill.*, 2. p. 69.)

Engravings. Jacq. Aust., t. 210.; Mill. Icon., t. 270.; Lob. Icon., t. 99.; *Duh. Arb.*, t. 178.; and our

fig. 223.

Spec. Char., &c. Leaves obovate. (*Dec. Prod.*, ii. p. 67.)

A native of sunny places in the south of Europe and Asia, from Spain to Caucasus. The flowers are disposed in loose panicles, and have the sexes hermaphrodite. The drupe is half-heart-shaped, smooth, and veiny; its nut is triangular. Many of the flowers are abortive, and their pedicels, after the flowering, lengthen, and become hairy. (*Ibid.*)

Description, &c. The *Rhús Cótinus*, though seldom found higher than 5 ft. or 6 ft. in a wild state, yet grows to double that height in gardens, where it forms a highly ornamental shrub, more especially when covered with its large loose panicles of elongated hairy pedicels, very few of which produce fruit. It is easily known from all the other species by its simple, obovate, smooth, stiff, lucid, green leaves, rounded at the points, and supported by long footstalks, which remain on till they are killed by frost, so that the plant is almost a sub-evergreen. The flowers are produced at the ends of the branches, and are of a pale purplish or flesh colour. Each flower is composed of 5 small oval petals, which spread open, but are seldom succeeded by seeds in England. In Greece, and in the south of Russia, the whole plant is used for tanning, and for dyeing leather, wool, and silk yellow. In Italy, about Venice, it is used for dyeing black, and is called by the Italians *scotino*, from *skotios*, dark. Sir James Edward Smith found it cultivated under this name for tanning, on a little hill at the back of the inn at Valcimaca, between Rome and Bologna. (*Corresp.*, i. p. 325.) The plant appears to have been known to



Pliny, who mentions it as an Apennine shrub, under the name of *Coggýgia*. In England, it was cultivated by Tradescant, and it is described by Gerard as an excellent and most beautiful plant, "with the leaves of the capparís, and the savour of the pistachia." As an ornamental shrub, it deserves a place in every garden where there is room to allow it to extend itself on every side. A dry loam suits it best; and it is propagated by pegging down the branches flat to the ground, and strewing earth over them, through which young shoots rise up, which root at the base, and may be removed in autumn. There are old plants of it at Syon; and a very fine one at Deepdene, the diameter of the head of which is nearly 20 ft.: but the largest in England is at Enville, in Staffordshire, where it has attained more than double that size. Plants, in the London nurseries, are 50s. a hundred, or 6d. each; at Bollwyller, plants are 1 franc each.

§ ii. Sùmach *Dec.*

Sect. Char. Leaves impari-pinnate; leaflets more than 3 in the leaves of each of the first 6 species of this section. Flowers in panicles, polygamous, diœcious, or hermaphrodite.

‡ 2. *R. TYPHINA* L. The Fever Rhus, or Stag's Horn Sumach.

Identification. Lin. Spec., 380.; Dec. Prod., 2. p. 67.; Don's Mill., 2. p. 70.

Synonymes. *R. virginiana* Bauh. Pin., p. 517.; Virginian Sumach.

Engravings. Dub. Arb. Ed. Nov., 2. t. 47.; Wats. Dend. Brit., t. 17 and t. 18.; and our fig. 224.

Spec. Char., &c. Leaf of 8—10 pairs of leaflets, and the odd one, that are lanceolate, acuminate, serrated, hairy beneath. Petiole and branches hairy. (*Dec. Prod.*, ii. p. 67.) A native of North America. Fruit hairy, purple. De Candolle has characterised two forms of this species as follows:—

‡ *R. t.* 1 *arborœscens*.—Its form that of a tree; its height between 10 ft. and 25 ft. high; leaf slightly downy beneath. (*Willd. Enum.*, 323.)

‡ *R. t.* 2 *frutœscens*.—Its form shrubby; its height between 2 ft. and 10 ft.; and its leaf downy and whitish beneath.

Description, &c. *Rhus typhina*, in British gardens, is either a large shrub or a low tree, with a woody stem, and a head composed of many irregular branches, generally crooked and deformed. The young shoots are covered with a soft velvet-like down, resembling that of a young stag's horn, both in colour and texture; whence, and probably also from the crookedness of the branches, the common name. The leaves



are large, and very conspicuous in autumn, before they drop off, when they change to a purplish or yellowish red. The flowers are produced in close spikes at the ends of the branches; and the female ones are followed by seeds enclosed in woolly, simple, succulent covers, which are very conspicuous in autumn. The plant is found in a wild state in almost every part of North America; particularly in Carolina and Virginia. It was cultivated by Parkinson in 1629, and is now common in British gardens. There are large specimens of it at Syon, where it has attained the height of 15 ft. as a tree; and in the arboretum of Messrs. Loddiges, and in the garden of the London Horticultural Society; in each of which places it has attained the height of 10 ft. or 12 ft. In some parts of North America, the wood is used for tanning leather, and the roots prescribed as a febrifugal medicine. In British gardens it well deserves a place, from its large and beautiful foliage, and its striking colour in autumn; its spikes of dark red fruit; and the singularity of its branches in winter. As the plant is of open irregular growth, and not

of long duration, it should never be placed where it is intended to act as a screen. Like all objects the chief beauty of which consists in their singularity, it produces the most striking effect when standing alone on a lawn. If trained to a single stem, either of the forms of this species may be made an interesting small tree, but not one of many years' durability. Price, in the London nurseries, 1s. a plant, and seeds 1s. an ounce; at Bollwyller, 50 cents a plant; and in New York, 25 cents a plant, and seeds 1 dollar a quart.

‡ 3. *R. (? T.) VIRIDIFLORA* Poir. The green-flowered Rhus, or *Sumach*.

Identification. Poir. Dict., 7. p. 504.; Dec. Prod., 2. p. 67.; Don's Mill., 2. p. 70.

Synonyme. *R. canadense* Mill. Dict., No. 5.

Spec. Char., &c. Leaf of 8—10 pairs of leaflets, and the odd one, that are lanceolate-oblong, serrate, pubescent beneath. Petiole and branches rather hairy. (*Dec. Prod.*, ii. p. 66.) A tree, a native of North America. Flowers green, in upright racemes. Probably a variety of *R. glabra*. (*Ibid.*) The plant of *R. viridiflora* in the garden of the London Horticultural Society was, in 1834, 10 ft. high, after having been 10 years planted.

‡ 4. *R. (? T.) GLABRA* Lin. The glabrous Rhus, or *Scarlet Sumach*.

Identifications. Lin. Spec., 880.; Dec. Prod., 2. p. 67.; Don's Mill., 2. p. 70.

Engravings. Wats. Dend. Brit., t. 15.; and our fig. 225.

Spec. Char., &c. Leaf glabrous, of 8—10 pairs of leaflets, and an odd one; leaflets lanceolate-oblong, serrate, whitish beneath. Branches glabrous. (*Dec. Prod.*, ii. p. 67.) A native of North America. Fruit covered with silky hairs, red. De Candolle has distinguished three forms of this species; namely:—

‡ *R. g. 1 hermaphrodita*, with hermaphrodite sexes, and greenish flowers; the *R. glabra* Willd. *Spec.*, i. p. 1478., and figured in *Dill. Elth.*, t. 243.

‡ *R. g. 2 dioica*, with diœcious sexes, and greenish flowers, figured in *Lam. Ill.*, t. 207. f. 1.

‡ *R. g. ? 3 coccinea*, the *R. carolinianum* of *Mill. Dict.*, and the *R. elegans* of Ait., Loddiges's Catalogue, and of nurseries generally, figured in *Dend. Brit.*, t. 16., has diœcious sexes, and red flowers. It is distinguished by a more upright habit of growth, and smoother branches and leaves, than *R. glabra*. The leaves are glaucous underneath; and the fruit is of a rich velvety crimson.

Description, &c. The general appearance of the species is similar to that of *R. typhina*; but the plant is smaller, the branches more spreading and smooth, and the leaflets wider, less serrated, and of a deeper green. There are many varieties of *R. typhina* in North America; and, to us, it appears highly probable that *R. glabra* is only one of these. According to Kalm, the species or variety under notice is exceedingly common in woods throughout great part of North America, both in cultivated and uncultivated districts. In woods, it is found on the margins of open glades; and, in cultivated parts of the country, it less common in low meadows than in corn fields. "It is like a weed in some parts of the country; and, if a field be left a few years uncultivated, this shrub overruns it, from berries which are brought by birds; and, when the ground comes again into tillage, the roots stop the plough very much. The fruit remains on the shrub during winter; but the leaves drop very early in autumn. It seldom grows above 9 ft. high. The wood burns well, without much crackling. On cutting the stem, a yellow juice comes out between the bark and the wood; one or two of the outer circles of the wood are white, but the innermost are of a yellowish green; it contains a pith frequently half an inch in diameter, or more, of a brown colour, and so loose, that it is easily pushed out by a stick. The branches, boiled with the



225

berries, afford a black ink-like tincture. The berries are eaten by children with impunity, but they are very sour: they are red, and are made use of for dyeing that same colour." (*Martyn's Miller.*) Professor Rogers, in *Silliman's Journal*, vol. xxvii, p. 294., observes that the berries contain a large portion of the malic acid, and are used as a substitute for lemons in various preparations of domestic economy and medicine: the leaves are used in tanning. In British gardens, this sort has been cultivated since 1726. A plant in the garden of the London Horticultural Society was, in 1834, 6 ft. high, after being 10 years planted. The history and culture are the same as those of *R. typhina*.

♣ 5. *R. PU'MILA Michx.* The dwarf Rhus, or Sumach.

Identification. Michx. Fl. Bor. Amer., 1. p. 182.; Pursh Bor. Amer., 1. p. 204.; Dec. Prod., 2. p. 67.; Don's Mill., 2. p. 70.

Spec. Char., &c. Dwarf, downy in every part. Leaf of many pairs of leaflets, and the odd one; the leaflets are oval, cut in a toothed manner, and tomentose beneath. Fruit silky. (*Dec. Prod.* 2. p. 68.) A native of Upper Carolina, whence it was introduced in 1805. It grows to the height of 1 ft., and flowers in July. Mr. John Lyon, who discovered this species, when collecting the seed, "got poisoned all over his body, and was lamed for a considerable time." (*Ph.*) The species is not in the garden of the London Horticultural Society, or in the arbo-retum of Messrs. Loddiges.

‡ 6. *R. VERNICI'FERA Dec.* The varnish-yielding Rhus, or Sumach.

Identification. Dec. Prod., 2. p. 68.; Don's Mill., 2. p. 70.

Synonymes. Sitz, or Urus, *Japanese*, according to *Kämpfer Am.*, 791. t. 792.; *R. vernix Lin. Mat. Med.*, 151., and *Thun. Jap.*, 121., not of other authors; *R. juglandifolium Walt.* in *Litt. Dou. Prod. Fl. Nep.*, not of Willd.

Engraving. Kämpf. Amœn., t. 792.

Spec. Char., &c. Leaf of 5—6 pairs of leaflets, and the odd one; all ovate, acuminate, entire, rather glabrous above, beneath bearing velvety pubescence. Petiole and branches softly woolly. (*Dec. Prod.*, ii. p. 68.) A tree, a native of Japan and Nepal. The general appearance of this species is that of *R. typhina*; but the leaves are much larger, and more like those of some species of *Juglans* or *Carya*. The plant also seems to be of more robust growth; a specimen in the garden of the London Horticultural Society having, in 6 years, attained the height of 11 ft. Though marked, in some works, as a green-house shrub, it appears to be as hardy as the common species; and it is especially worth culture on account of its magnificent leaves. Thunberg affirms that the very best Japan varnish is made from this species, which is the *Rhus vernix* of *Lin. Mat. Med.*, though not of *Lin. Sp. Plan.*; it grows in abundance in many parts of that country; and is cultivated in several places, on account of the advantage derived from it. The varnish, which oozes out of the tree on its being wounded, is procured from stems that are three years old, and is received into some proper vessel. When first collected, it is of a whitish colour, and of the consistence of cream; but grows thicker and black on being exposed to the air. It is so transparent, that, when laid, pure and unmixed, upon boxes or furniture, every vein of the wood may be clearly seen through it. For the most part, a dark ground is spread underneath it, which causes it to reflect like a mirror; and for this purpose recourse is frequently had to the fine sludge which is collected in the trough under a grindstone; or to ground charcoal; occasionally, a red substance is mixed with the varnish, and sometimes leaf gold ground very fine. This varnish hardens very much, but will not endure any blows, cracking and flying almost like glass; though, at the same time, it can stand boiling water without receiving any damage. With this the Japanese varnish over the posts of their doors and windows, their drawers, chests, boxes, scimitars, fans, tea-cups, soup-dishes, their portable stools, and most articles of household furniture which are made of wood. (*Mart. Mill.*)

♣ 7. *R. VENENATA Dec.* The poisonous Rhus, *Poison Wood*, or *Swamp Sumach*.

Identification. Dec. Prod., 2. p. 68.; Don's Mill., 2. p. 71.; Hook. Fl. Bor. Amer., 1. p. 126.

Synonymes. *R. vernix Lin. Spec.*, 380., *Big. Med. Bot.*, 1. p. 96. t. 10.; *Toxicodendron pin-natum Mill. Dict.*, No. 5.; *Poison Sumach*, *Poison Elder*.

Engravings. Dill. Elth., t. 292; Wats. Dend. Brit., t. 19.; Big. Med. Bot., l. t. 19.; and our fig. 226.

Spec. Char., &c. Leaf rather glabrous than pubescent, of 5—6 pairs of leaflets, and the odd one, which are ovate-lanceolate, acuminate, entire, and beneath reticulately veined. (*Dec. Prod.*, ü. p. 68.) A native of North America, from Canada to Carolina, and commonly called there poison sumach, or poison wood. The drupe is white, and the nut furrowed. (*Ibid.*)

Description, &c. In its native country, this species is a shrub or low tree, growing to the height of 20 ft.; but it does not grow so vigorously in British gardens, probably from not being sufficiently attended to in regard to soil, which ought to be kept very moist, as the name swamp sumach implies. The leaves are divided like those of *R. typhina* and *R. glabra*; but they are quite different from those of both kinds in being smooth, shining, and having the leaflets very entire, narrow, and pointed, and the veins of a purplish red colour. There is a plant in the garden of the London Horticultural Society, which, in 1834, was 4 ft. high, after being 5 years planted. There are also plants of the same species in the arboretum of Messrs. Loddiges. The leaves die off of an intense red or purple; and are, in the autumn season, strikingly beautiful. This species is a native of swamps in Virginia, Carolina, Pennsylvania, and New England; and it is also said to be a native of Japan.

The milky juice stains linen a dark brown. The whole shrub is in a high degree poisonous; and the poison is communicated by touching or smelling any part of it. In forty-eight hours, inflammation appears on the skin, in large blotches, principally on the extremities, and on the glandulous parts of the body: soon after, small pustules rise in the inflamed parts, and fill with watery matter, attended with burning and itching. In two or three days, the eruptions suppurate; after which the inflammation subsides. Some persons are incapable of being poisoned with this plant; but those who are of unstable habits are more likely to receive it.

According to Kalm, an incision being made, a whitish yellow juice, which has a nauseous smell, comes out between the bark and the wood: it is noxious to some persons, but does not in the least affect others. On Kalm himself it had no effect, except once, on a hot day, when, being in some perspiration, he cut a branch, and carried it in his hand for half an hour, smelling it now and then. It produced a violent itching in his eyelids and the parts thereabouts. During a week, his eyes were very red, and the eyelids very stiff, but the disorder went off by washing the parts in very cold water. (*Mart. Mill.*) In British gardens, this species is not very common; but it well deserves culture, on account of the beauty of its smooth shining foliage at all seasons, and of its almost unparalleled splendour in the autumn, from the time that the leaves begin to change colour, till they ultimately drop off with the first frost. We would recommend that the plant should always have a label attached to it, indicating the poisonous qualities of the leaves, even when touched or smelled to. Plants, in the London nurseries, are 1s. 6d. each, seeds 2s. an ounce; at Bollwyller, 1 franc and 50 cents a plant; and at New York, 50 cents a plant.

♣ *S. R. CORIARIA* Lin. The hide-tanning Rhus, or the Elm-leaved Sumach.

Identification. Lin. Spec., 579.; *Dec. Prod.*, 2. p. 67.; Don's Mill., 2. p. 70.

Derivation. The specific name of *Coriaria* was given to this plant from the use made of it by the Turks in tanning leather; and it was also a name of the *Rhus* among the Romans, from the same quality.



Engravings. N. Du Ham., 2. t. 46.; Wats. Dend. Brit., t. 136.; Blackw., t. 486.; Plenck. Icon., t. 232.; and our figs. 227. and 228.



Spec. Char., &c. Leaf villose, of 5—7 pairs of leaflets, and the odd one; leaflets elliptical, and toothed with large and blunt teeth. The petiole smooth at the tip, a little margined. (*Dec. Prod.*, ii. p. 67.) A native of sunny rocky spots in the south of Europe, from Portugal to Tauria. Fruit villose. (*Ibid.*)



Description, &c. The general habit of this plant resembles that of *R.*

typhina; but it is much smaller in all its parts. The leaflets are about 2 in. long, and $\frac{1}{2}$ in. wide, of a pale green, serrated, and in general appearance resembling the leaves of the common elm. The flowers are in large loose panicles, of a whitish green; and they appear in July, but are seldom followed by seeds in England. The seeds are used at Aleppo, ground into powder, as a provocative to appetite, as mustard is in Britain. The plant is a native of the south of Europe and the north of Africa, and it appears to have been introduced into England in 1640. In British gardens, this species is not uncommon. Plants, in London, cost 1s. 6d. each; at Bollwyller, 1 franc.

✻ 9. *R. COPALLINA* Lin. The Gum Copal Rhus, or Mastich-tree-leaved Sumach.

Identification. Lin. Spec., 380.; *Dec. Prod.*, 5. p. 68.; Don's Mill., 2. p. 72.
Engravings. Jacq. Hort. Schön., t. 341.; Pluk. Alm., p. 56. f. 1.; and our fig. 229.

Spec. Char., &c. Leaf glabrous above, a little pilose beneath, of 5—7 pairs of leaflets, and the odd one; leaflets lanceolate and entire. Petiole winged and jointed. Root stoloniferous. Flowers yellow green. Sexes diœcious. (*Dec. Prod.*, ii. p. 68.)

Variety.

✻ *R. c.* 2 *leucantha* Jac. Hort. Schön., t. 342. — Root not stoloniferous. Flowers whitish. Panicles more contracted than in the species.

Description, &c. The leaves and general habit of the plant are those of *R. typhina*, but it seldom grows to the height of more than 4 ft. or 5 ft. The branches are smooth, and the leaflets entire with acute points; they are light green on both sides, and in autumn change to a fine purple. The petiole, as in *R. Coriaria*, is somewhat winged towards its tip, which, with other circumstances, induces us to think that they may both be varieties of the same species. *R. copallina* is found in dry fields and woods, particularly in sandy soil, from New Jersey to Carolina. The leaves are used as tobacco by the Indians of the Missouri and the Mississippi. The species was intro-



duced into England in 1697, and is occasionally to be met with in collections. There are good plants of both the species and the variety in the arboretum of Messrs. Loddiges. Plants of the species, in London, are 1s. 6d. each, and seeds 1s. an ounce; at New York, 37½ cents a plant.

* § 10. *R. RADICANS* L. The rooting-branched Rhus, or Sumach; or Poison Oak.

Identification. Lin. Spec., 381.; Dec. Prod., 2. p. 69.; Don's Mill., 2. p. 71.

Synonymes. *R. Toxicodéndron* var. α Michx. *Fl. Bor. Amer.*, 1. p. 185.; and *R. T.* var. β Torrey

Fl. U. S., 1. p. 322.

Engravings. Big. Med. Bot., t. 42.; and our fig. 230.

Spec. Char., &c. Leaf of one pair of leaflets and an odd one, the odd one upon a petiole; all glabrous and entire. (*Dec. Prod.*, ii. p. 69.) A native of North America. De Candolle has characterised three forms of this species as follows:—

§ *R. r.* 1 *vulgàris*.—Stem climbing by means of roots emitted from it; leaflets large, ovate. *R. Toxicodéndron vulgàre Ph. Fl. Amer. Sept.*, i. p. 205.; *Bot. Mag.*, t. 1806.; *Toxicodéndron vulgare*, and *T. volùbile Mill. Dict.* This often poisons upon mere touching.

§ *R. r.* 2 *volùbilis*.—The stem climbing, scarcely emitting roots; the leaflets large and ovate. *Toxicodéndron volùbile Mill. Dict.*

§ *R. r.* 3 *microcárpa*.—Leaflets oblong-oval with a tapered long point; the fruit much smaller than that of the other forms. *R. Toxicodéndron microcárpon Ph. Fl. Amer. Sept.*, i. p. 205. There is a figure of this in *Dill. Élth.*, t. 291. fig. 375. A plant of this variety in the garden of the London Horticultural Society was, in 1834, 4 ft. high, after having been 8 years planted.

Description, &c. This species, in America, has a low shrubby stem, and forms a bush from 2 ft. to 3 ft. in height, whence shoots proceed near the bottom to the distance of 20 ft. or 30 ft. on each side, rooting at the joints, and completely occupying the surface of the ground. Placed near a wall or a tree, the shoots climb up, and root into the joints of the wall, or into the furrows of the bark of the tree, if the latter should be old. It is a native of many parts of North America, from Canada to Georgia; sometimes covering the surface of the ground to a great extent; and at other times climbing to the top of the highest trees, and penetrating the bark with its fibrous roots. When the stem is cut, it emits a pale brown sap of a disagreeable scent; and staining so powerfully, that letters or marks made upon linen with it cannot be obliterated, but grow blacker the more the linen is washed, not being acted upon by common chemical agents. (*Churchill's Medical Botany*, vol. ii.) In Bigelow's *Medical Botany*, it is stated, that the plant is as common in the woods of America as the ivy is in the woods of Europe; "and the terrible effects of its poison are so frequent, that there seems to be no doubt on the subject. An American young man, who was cutting wood, had his feet, hands, and arms so dreadfully blistered by an unwary approach to this plant, that he could not work for some days." Kalm relates that the plant is poisonous to some persons, but less so to others, and that the same thing takes place with respect to it as with *R. venenata*. (See p. 553.) He mentions the case of two sisters, one of whom could manage a plant of *R. radicans* without being affected by its venom; whilst the other felt its exhalations as soon as she came within a yard of it, or even when she stood to windward of it at a still greater distance. Kalm says that the poison had not the least effect upon himself, though he tried it in various ways, and once squirted the juice into his eye; but that, on another person's hand, which he had covered very thickly with it, the skin, a few hours afterwards, became as hard as a piece of tanned



leather, and peeled off afterwards in scales. (*Travels*, i. p. 177., as quoted in *Martyn's Miller*.) *R. radicans* was introduced into British gardens in 1640, and is common in collections in two distinct varieties. One, a dwarf kind, about a yard or less in height, with several upright stems; and emitting from about the bases of these stems numerous prostrate runners, which extend several, sometimes many, feet from the plant, and root into the earth: the other rising to a much greater height, having fewer stems, and being but little prone to emit prostrate runners, but producing, in the upper part, flexile and rather long branches, that climb when contiguous to objects of support; perhaps rather by emitted fibres than by convolution.

✻ § 11. *R. (R.) TOXICODÉNDRON* *Lin.* The Poison-tree Rhus, or Sumach.

Identification. *Lin. Spec.*, 381; *Hook. Fl. Bor. Amer.*, i. p. 127.; *Dec. Prod.*, 2. p. 69.; *Don's Mill.*, 2. p. 72.

Synonymes. *R. Toxicodéndron quercifolium Michx. Flor. Bor. Amer.*, i. p. 182., *Pursh Fl. Sept. Amer.*, i. p. 205.; *Toxicodéndron pubescens Mill. Dict.*, No. 2., *R. T. serratum Mill. Dict.*; the common Poison Oak, Poison Nut, Poison Vine.

Engraving. *N. Du Ham.*, 2. t. 48.; and our *fig.* 231.

Spec. Char., &c. Leaf of one pair of leaflets, and an odd one, the odd one upon a petiole; all inciso-angulate, pubescent. (*Dec. Prod.*, ii. p. 69.) A native of North America. Dr. Hooker remarks, that American botanists are at variance with regard to the distinctive characteristics of *R. Toxicodéndron* and *R. radicans*. Nuttall says, that they are certainly different. Pursh, and most other authors, either unite them, or speak with doubt as to the value of their distinctive characters. (*Hook. Bor. Amer.*, i. p. 127.)

Description, &c. The general appearance of this shrub closely resembles that of *R. radicans*, of which, in all probability, it is only a variety. The male flowers, which are produced on separate plants from the female ones, come out from the side of the stalks, on close short spikes, and are of a pale green. The female flowers are produced in loose panicles, agreeing in shape and colour with the males; but are larger, and have a roundish germ supporting three very short styles. This species is common in woods, fields, and along fences, from Canada to Georgia, where, like the *Rhus radicans*, it is known by the name of the poison oak, or the poison vine.

R. Toxicodéndron was introduced into England in 1640, when it was cultivated in the Bishop of London's garden at Fulham; it is now frequent in collections. *R. Toxicodéndron* yields a yellowish milky sap, the properties of which, as an indelible ink, are similar to those of the sap of *R. radicans*. The plant in the garden of the London Horticultural Society, in 1834, formed a bush 5 ft. high, and 5 ft. in diameter, after having been 10 years planted; and it is there readily distinguished from *R. radicans* by its deeply sinuated, or almost pinnatifid, leaflets.



231

§ iii. *Thezèra* *Dec.*

Sect. Char. Leaf of 3—5 sessile leaflets, disposed palmately. Flowers in short racemes. Sexes diœcious. Styles 3, distinct, short. Drupe roundish, marked at the tip with 3 tubercles; the nut compressed. (*Dec. Prod.*, ii. p. 72.)

✻ 12. *R. PENTAPHYLLA* *Desf.* The five-leafletted-leaved Rhus, or Sumach.

Identification. *Desf. Fl. Atl.*, i. p. 267. t. 77.; *Dec. Prod.*, 2. p. 72.; *Don's Mill.*, 2. p. 75.

Synonymes. *Rhamnus pentaphyllus Jacq. Obs.*, 2. p. 27.; *R. Thezèra* (from *thexas*, a point, in reference to the prickles), *Pers. Ench.*, i. p. 325., *Tin. Pug.*, i. p. 7.

Engraving. *Bocc. Sic.*, t. 21.

Spec. Char., &c. Branches bearing spines. Petiole indistinctly winged. Leaflets 3—5, linear-lanceolate at the tip broader, obtuse, entire, or having 3 teeth. (*Dec. Prod.*, ii. p. 72.) A shrub, growing to the height of 10 ft., a native of Sicily and Barbary, and introduced in 1816. The fruit is acidulous and catable, and the bark dyes red, and is used in tanning leather.

❖ 13. *R. ZIZYPHINA* Tinco. The Zizyphus-like Rhus, or Sumach.

Identification. Schrank in Flora, 1819, p. 314; Tin. Pug. Sic., 1. p. 8.; Dec. Prod., 2. p. 72.; Don's Mill., 2. p. 75.

Synonymes. *Rhâmnus tripartita Ucria*, and *Zizyphus tripartita Roem. et Schult' Syst.*, 5. p. 342., and 6. p. 663.

Spec. Char., &c. Branches divaricate, bearing spines. Leaflets 3, glabrous, glossy above, wedge-shaped, toothed more than half their length. Racemes terminal. (*Dec. Prod.*, p. 72.) A shrub, found in the mountainous parts of Sicily, where it grows to the height of 4 ft. Introduced in 1800.

§ iv. *Lobadium* Dec.

Sect. Char. Leaf of 3 leaflets, and palmately disposed on the tip of the common petiole, cut in a serrate manner, the teeth large. Flowers in a dense catkin. Sexes polygamous. There are two-lobed glands under the ovary, alternate with the stamens. Styles 3, short, distinct. Drupe rather compressed, villose. Nut smooth. Aromatic shrubs. (*Dec. Prod.*, ii. p. 72.)

❖ 14. *R. SUAVE'OLENS* Ait. The sweet-scented Rhus, or Sumach.

Identification. Ait. Hort. Kew., 1. p. 368.; Dec. Prod., 2. p. 72.; Don's Mill., 2. p. 75.

Synonymes. *Myrica trifoliata Hortul.*, and, perhaps, of *Lin.*; *Toxicodendron crenatum Mill. Dict.*, No. 5.

Spec. Char., &c. Leaflets oval, a little angular in the middle, glabrous. (*Dec. Prod.*, ii. p. 72, 73.) A native of Carolina, where it grows to the height of 6 ft., and produces its greenish-yellow flowers in May. It was introduced in 1759, but is not common in collections; is, in all probability, the same as the following sort.

❖ 15. *R. (s.) AROMA'TICA* Ait. The aromatic Rhus, or Sumach.

Identification. Ait. Hort. Kew., 1. p. 367.; Dec. Prod., 2. p. 73.; Don's Mill., 2. p. 75.

Engraving. Turp. in An. du Mus. 5. p. 445. t. 30.

Spec. Char., &c. Leaflets oval, a little angular in the middle, pubescent in a pilose manner. (*Dec. Prod.*, ii. p. 73.) A native of North America, in Kentucky, and from Pennsylvania to Carolina, where it grows to the height of 6 ft. Introduced in 1772. Nuttall has stated that the drupes are acid and eatable. The flowers are yellow, in dense terminal spikes. The plant in the Horticultural Society's Garden was, in 1834, 4 ft. high, after being 10 years planted.

App. i. *Other Species of Rhûs, hardy and half-hardy.*

In Don's *Miller*, ninety-seven species of this genus are described; but, if it were possible to bring them all together, and cultivate them in the same garden, we question much if there would be found more than a fourth part of them entitled to be considered specifically or permanently distinct. We judge of those which we have not seen from those which we have observed for years in British gardens; and, as we feel quite confident that *R. typhina*, *R. viridiflora*, and *R. glabra* are one and the same species, and *R. Toxicodendron* and *R. radicans* are also only one species, so we do not think it likely that the species, or names given as species, under the other sections, are more distinct. It is the business of botanical writers, however, to record all these names with their descriptions; and of cultivators, to endeavour to procure them for their gardens, in order to compare them together; for which last reason we subjoin the following names:—

R. lobata Hook. (*Fl. Bor. Amer.*, i. p. 127. t. 46.) is a very handsome species, or perhaps only a tolerably distinct variety, closely resembling *R. Toxicodendron* var. *quercifolium*, at least, as the plant bearing that name appears in the garden of the London Horticultural Society. Dr. Hooker says, "Although nearly allied as this [*R. lobata*] is to the two preceding species [*R. radicans* and *R. Toxicodendron*], I nevertheless venture to consider it distinct. Its general habit is very different, having erect straight stems, and numerous small leafy branches. The leaflets, besides that they are deeply lobed with acute sinuses, are truly ovate, very obtuse, and greatly smaller than in any state of *R. Toxicodendron* or *R. radicans* which I have seen: the panicles, too, are exceedingly numerous, and large in proportion to the size of the leaf." (*Fl. Bor. Amer.*, i. p. 127.) The shrub was discovered by Douglas, on the outskirts of woods in dry soils in North-west America, particularly at Fort Vancouver. It is not yet introduced, but appears to be a very desirable variety.

R. acuminata Dec. (*Don's Mill.*, ii. p. 70.), a native of Nepal, and hardy; not yet introduced.

R. Amèla D. Don (*Don's Mill.*, ii. p. 72.), the *Bucku-Amèla* of *Hort. Brit.*, is a Nepal tree, growing to the height of 4 ft., with diœcious flowers, disposed in large terminal spikes. It is marked as having been introduced in 1823, and as requiring the protection of a frame. It seems a most desirable species; but we have not seen it.

R. bahamensis G. Don (*Don's Mill.*, ii. p. 72.) is a climbing shrub, a native of the Bahama Islands, not yet introduced, probably only a modification of *R. radicans*.

R. Oxyacantha and *R. oxyacanthoides* of *Hort. Brit.*, (the *R. Oxyacantha* and *R. dioica* of Don's *Miller*, the first introduced in 1823, and the last in 1825, are considered hardy; but they are rarely to be met with in gardens. (See, also, several species enumerated under Anacardiaceæ of the Himalaya, p. 174.)

The frame and green-house species of *Rhûs* are numerous, as will be seen by a glance at our *Hort. Brit.*, p. 110. When tried in the open air, many of them will probably be found hardy, and perhaps all of them half-hardy. *R. heterophylla*, generally kept in the green-house, was planted

against a wall in the garden of the London Horticultural Society, in 1832, and is found quite hardy. We anticipate the hardness of most of the other species from their habits; viz. from their being generally deciduous, in the open air, in the neighbourhood of London; producing their shoots rapidly, and so early in the season as to allow time for their ripening before the approach of frost; and from their having no visible buds in the shoots, but numerous germs in the roots: a proof that a great part of the vitality of the plant is under ground, and, consequently, comparatively safe from the influence of the weather.

GENUS III.

DUVAU'A Kth. THE DUVAUA. *Lin. Syst. Polygàmia Monœ'cia.*

Identification. Kth. Gen. Tereb., p. 8; Dec. Prod., 2. p. 74; Don's Mill., 2. p. 76; Lindley in Bot. Reg., t. 1568. 1573. 1580.

Synonymics. Schinus sp. Andr.; Amyris sp. Cav.

Derivation. Called Duvaúa, "after M. Duvaux, a French botanist, known as the editor of the original edition of Richard's *Analyse du Fruit*; and for some observations on *Verónica*." (Lindley, in Bot. Reg., t. 1568.)

Gen. Char., &c. Calyx persistent, with 4—5 segments. Corolla of 4—5 concave petals. Sæces monœciously polygamous. Stamens 8—10, inserted under a pitcher-shaped calycine disk, which has as many sinuses and as many teeth as there are stamens: these are opposite the sinuses, and half of them opposite the petals, and half of them alternate with them. Anthers in the fruit-bearing flowers barren. Ovary conical, including one ovule, barren in some flowers. Styles 3—4. Stigmas capitate. Fruit a globose drupe, with a leathery nut, whose seed is pendulous, and has flat cotyledons, and a long radicle.—Chilian trees and shrubs, becoming spiny as they advance in growth; their leaves simple, and their flowers disposed in axillary racemes, many in a raceme. (Dec. Prod., ii. p. 74, and Lindley, in Bot. Reg., t. 1568. 1573. 1580.) There are four species in cultivation, which are all very handsome evergreen bushes, with bright shining foliage; the leaves rather small, oblong, and toothed; with numerous small flowers of a greenish yellow, and small dry berries.

Properties and Uses. The foliage emits, when bruised, a strong but not unpleasant odour of the nature of turpentine; and it is probable that this odour pervades all parts of the plants, especially those in which the sap is most abundant. A pretty phenomenon is exhibited by the leaves of *D. ovata*, and, doubtless, by those of every species of *Duvaúa* and of *Schinus*, when thrown upon water, both in a whole state and when broken into pieces. The leaves, or parts of leaves, "after lying a short time, will be found to start and jump as if they were alive, while at the instant of each start a jet of oily matter is discharged into the water. This circumstance appears to be owing to some peculiar irritability of the parenchyma of the leaves, which, when acted upon by water, causes the turpentine sæcs, that abound in them, to empty themselves with violence; and the movements of the leaves may be ascribed to the recoil produced by the discharge. Thus we have in every leaf a sort of vegetable battery, which will keep up its fire until the stock of ammunition is expended." (Bot. Reg.) The movements of the leaves upon the water have been compared to a fleet of ships employed in manœuvring, or to persons engaged in dancing. (Gard. Mag., vol. ix. p. 377.) Dr. Gillies states that the Pehuenco Indians prepare by fermentation an intoxicating liquor from the fruit of *D. latifolia*, or a nearly allied species. (Bot. Reg.)

Propagation and Culture. Seeds have been produced plentifully in the London Horticultural Society's garden by *D. depèndens*, trained to a south wall; and seeds of *D. latifolia* are often imported from Chile. Plants of this genus may also be multiplied by cuttings of the ripe wood struck in sand, under a bell-glass, in a gentle heat. The species "will not bear the climate of London without protection from frost; but, if trained to a wall, and sheltered by a roof of thatch in winter, they succeed perfectly: in short, they are about as hardy as myrtles." (Bot. Reg.) *D. ovata*, and, it is probable, all the species, "will grow in any soil or situation which is dry in summer, and well drained in winter; and would probably succeed in the crevices of rocks in Devonshire or Cornwall." (Bot. Reg.) *D. depèndens*, *D. ovata*, and *D. latifolia* have flowered in the London Horticultural Society's Garden, the two former in July, and plentifully; the last in June and July, but, it seems by the figure in Bot. Reg., much less abundantly than the other

two. The fruit produced by *D. dependens* consists of small, dry, blackish purple berries. The species appear highly desirable to all who have a conservative wall, if it were only to excite an interest in plants in the minds of children, by exhibiting to them the curious action of the leaves.

† 1. *D. DEPENDENS* Dec. The drooping-branched Duvaua.

Identification. Dec. Prod., 2. p. 74.; Don's Mill., 2. p. 75.; Lindley in Bot. Reg., t. 1573.
Synonymes. *Amŕis polygama* Cav. Icon., 3. p. 20. t. 239.; *Schinus dependens* Ort. Decad., 8. p. 102.; Duvaúa dependens α Hook. Bot. Misc., 2. p. 176.
Engravings. Cav. Ic., t. 239.; Bot. Reg., t. 1573.; and our fig. 232.

Spec. Char., &c. Leaves mostly, especially upon the flower-bearing branches, obovate, and very obtuse, or even emarginate, with scarcely any denticulations. Racemes scarcely exceeding the leaves in length. Stamens mostly 10. Flowers smaller than those of *D. ovata*. (*Lindley, in Bot. Reg., t. 1573.*) A tree, a native of Chili, where it is called *Huinghan*. (*Dec. Prod., ii. p. 74.*) Introduced in 1790. There is an old plant of it in the Botanic Garden at Kew, against a wall with a west aspect, which has attained a considerable size, with very little protection. There is also a tree in the Chelsea Botanic Garden, which is 12 ft. high, with a trunk 7 in. in circumference, after having been 5 years planted. The plant in the London Horticultural Society's Garden has passed seven winters against a wall with a southern exposure. The winter of 1835-6 having been unusually severe, has withered the leaves and the smaller shoots of this and of some other species of *Duvaúa* in this garden; but, on examining the trees, April 20. 1836, we find the stronger shoots, and the trunk and branches, uninjured, and buds and leaves rapidly developing themselves.

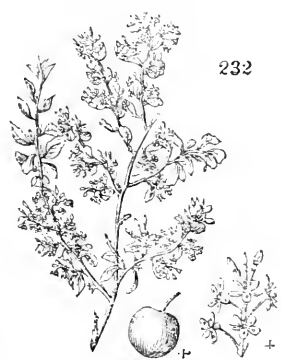

232

‡ 2. *D. OVATA* Lindl. The ovate-leaved Duvaua.

Identification. Lindl. in Bot. Reg., t. 1568.
Engraving. Bot. Reg., t. 1568.

Spec. Char., &c. Leaves ovate, toothed, in most acute at the tip, in some obtuse. Racemes a little longer than the leaves. Stamens mostly 8. (*Lindley, in Bot. Reg., t. 1568.*) Nearly related to *D. dependens*; "but the plants are so different when growing side by side, that we cannot think it right to combine them." (*Lindley.*) About 6 ft. high. Branches spinescent. Introduced about 1825 or 1826. The plant in the Horticultural Society's Garden was planted in 1831. To us it appears only a variety of the preceding species.

‡ 3. *D. LATIFOLIA* Gill. The broad-leaved Duvaua.

Identification. Gillies MSS.; Lindl. in Bot. Reg. t. 1580.
Synonyme. *D. dependens* γ Hook. Bot. Misc.
Engraving. Bot. Reg., t. 1580.; and our fig. 233.

Spec. Char., &c. Leaves oblong, acute, coarsely toothed, so waved as to seem in some measure plicate. Racemes dense, the length of the leaves. Stamens 8. (*Lindley in Bot. Reg., t. 1580.*) "Whatever may be thought" of the distinctness, as species, "of *D. ovata* and *D. dependens*, there can be no doubt that this is a totally distinct species; for not only are the leaves, in their outline, surface, and colour, and the whole plant in its habit, very different, but we find it maintain all its peculiarities unchanged when raised from seeds." (*Id.*) This species is very common in Chili, and is called there *Huing han*, as well as *D. dependens*. It was introduced into Britain in 1829, or before. The plant in the Horticultural Society's Garden was placed against the wall where it now stands in 1829. This species, judging from the above-mentioned plant, as examined by us April 20th, 1836, appears to be somewhat more tender than *D. dependens*; but this may be owing to its larger leaves presenting a greater surface to the action of the weather. We have already more than once remarked, that, when the majority of a species of a genus are hardy, the probability is that those species of that genus which are found to be rather tender may, by cultivation through several generations, or even perhaps by extension, become hardy. The first, Sir Joseph Banks alleges, has been the case with *Zizania aquatica*; and the



233

‡ 4. *D. DENTATA* Dec. The toothed-leaved Duvaua.

Identification. Dec. Prod., 2. p. 74.; Don's Mill., 2. p. 76.
Synonyme. *Schinus dentata* Andr. Bot. Rep., t. 620.
Engraving. Andr. Bot. Rep., t. 620.

Spec. Char., &c. Leaf lanceolate, toothed, scarcely so long as the raceme. Stamens 10. (*Dec. Prod.*, ii. p. 74.) A shrub, a native of the Island of Owhyhee. (*Id.*) Introduced in 1795. The plant in the Horticultural Society's Garden was placed against the wall in 1828. It is probable that plants of this species are extant in many old collections in conservatories.

App. i. Other Species of *Duvaña*.

There is a plant belonging to this genus in the Horticultural Society's Garden, which was placed against a wall there in 1831, but which has not yet flowered. It seems somewhat different in foliage from the preceding sorts, and may be a variety. The others we consider as nothing more than varieties, unless we except *D. latifolia*.

App. I. Other Species of *Anacardiaceæ*, half-hardy, or conjectured to be so.

Sabia parviflora Wall. and *S. campanulata* Wall. are climbing shrubs, natives of Nepal, and included in our list, p. 174., as likely to prove hardy when once introduced. In *Don's Miller* (ii. p. 69.), they are very properly marked as requiring the green-house; and we should probably not have included them among the half-hardy species, had we not had the aid of Mr. Royle's opinion, as stated in p. 173.

✻ *Schinus Mülli* L. (*Don's Mill.*, ii. p. 76.; *Lam. Ill.*, t. 822.; and our *fig.*, 234.) is a deciduous shrub or low tree, a native of Brazil and Peru, where it grows to the height of 20 ft. The leaves are impari-pinnate, with lanceolate serrated leaflets. The flowers are small, and of a yellowish green; and they are succeeded by berries about as large as a pea, of a singularly beautiful rose colour, and highly polished. This species was introduced in 1597, and, till lately, was kept in green-houses; but a plant in the garden of the London Horticultural Society has stood out several years in the open border, without any protection whatever.



It well deserves a place against a conservative wall, not only on account of the beauty of its foliage and of its berries, but from the interest attached to it, from the usefulness of its products in its native country, were it called the Peruvian mastich tree. The Peruvians are reported to make a vinous liquor and a sort of vinegar from its berries; and, from the resinous gum which exudes from its stem, they prepare mastich. The fresh leaves exhibit the same phenomenon, when immersed in water, as those of *Duvaña* (see p. 558.), and, probably, other terebinthinate genera. The leaves, the bark, and other parts of the plant, when bruised, emit a terebinthinate odour. There are two plants in the garden of the London Horticultural Society, one of which, in 1834, was 3 ft. high, after having been 2 years planted; and the second, which differs in its foliage from the other, was 3 ft. high, after having been planted 3 years. The common name in gardens is *S. Molle*; but the proper specific name is *Müllii*, which is the Peruvian name of the tree.

S. M. 2 *Areira* *Lin. Spec.*, 1467., *Don's Mill.*, 2 p. 77., is a variety with the leaflets almost entire. *S. Huýgan* *Mol.* and *S. virgata* Sweet are species from Chili and Lima, probably as hardy as *S. Mülli*.

Triceros (from *treis*, three, and *keras*, a horn; because the berry is three-horned) *cochinchinensis* *Lour.* (*Dec. Prod.*, 2 p. 89., and *Don's Mill.*, 2 p. 77.) is a tree with impari-pinnate leaves, a native of Cochinchina, on the mountains, where it grows to the height of 25 ft. It would form a most desirable acquisition to British gardens, as there can be little doubt of its proving quite hardy.

Heterodendron olcafolium *Desf.* (*Don's Mill.*, 2 p. 78.) is an evergreen shrub from New Holland, with the appearance of *Cneorum tricóccum*.

Styloplisium spatulatum *Desf.* (*Don's Mill.*, 2 p. 78.) is also a native of New Holland.

Cneorum tricóccum L. (*Lam. Ill.*, t. 27.) is a native of Spain and the south of France, in dry and gravelly places. It has been an inhabitant of our green-houses since 1793; and, on dry sheltered rockwork, it will stand the open air with little or no protection; producing its yellow flowers from April to September, and ripening its brownish red 3-seeded fruits, which resemble in form those of *Euphórbia Láthyris*, and remain on all the winter. The plant is evergreen, and grows to the height of from 1 ft. to 2 ft. A specimen of this species in our garden at Bayswater, planted at the foot of a wall, and protected with a glass case, but without any artificial heat, has stood for the last six years; and is now (April 23. 1836) 18 inches high, and covered with fruit and flowers; contrasting strongly with *Coronilla glauca*, planted in the same glass case, and beautifully in flower at the same time.

Cneorum pulverulentum is a native of Teneriffe, and probably as hardy as the other.

CHAP. XXXIX.

OF THE HALF-HARDY LIGNEOUS PLANTS OF THE ORDER
BURSERA'CEÆ.

Balsamodendron gileadense Kunth, and Don's Mill., 2. p. 81.; the *Amphis gileadensis* of Lin. (*Vahl Symb.*, 1. p. 28. t. 11.; and our fig. 235. representing a branch, drawn to our usual scale of 2 in. to 1 ft., and fig. 236. representing the flower and fruit of the natural size), the Balm of Gilead tree, is a native of Arabia, with leaves palmately trifoliate, and small whitish flowers. There are two or three varieties of it, which are by some considered species, but none of them have yet been introduced into Britain. — *Canarium Pimela* König. (*Don's Mill.*, 2. p. 85.) is a tree with compound leaves, growing to the height of 50 ft. in the woods of Cochin-China and Java.

Fugastrum G. Don. (*Don's Mill.*, p. 87.) is a Cape genus, containing several species of evergreen shrubs, with alternate pinnate leaves, some of which may probably prove hardy; but none of which have hitherto been introduced.



CHAP. XL.

OF THE HALF-HARDY LIGNEOUS SPECIES OF THE ORDER
AMYRIDA'CEÆ.

Amphis toxicifera Willd., the *A. balsamifera* of L. and *Cat. Car.* t. 40., is a tree with compound leaves, a native of Carolina, and growing to the height of 50 ft. It is commonly kept in green-houses; but there can be little doubt, from the climate of its native country, that it would succeed against a conservative wall. The fruit is produced in racemes, and it is pearl-shaped and purple. From the trunk of the tree a juice distils as black as ink, which is reported to be poisonous. The leaves, in a dried state, are highly cephalic. This species was introduced in 1820, but it is not common. It well deserves a place in collections, as the representative of a genus containing various species interesting in medicine and the arts.

A. floridana Nutt. is a shrub, growing to the height of 10 ft. in Eastern Florida, with reticulate veined, glandular, resinous, and fragrant leaves, and black berries, about the size of those of black pepper. When introduced, it will doubtless be found half-hardy.

CHAP. XLI.

OF THE HARDY LIGNEOUS PLANTS OF THE ORDER LEGUMINA'CEÆ.

THE name of Leguminææ is applied to this extensive and truly natural order, on account of the seeds of all the species being produced in leguminous pods, bearing more or less resemblance to those of the common pea or bean; and quite different from the siliquose pods of cruciferous plants.

The *Distinctive Characteristics* are: Calyx with 5 divisions, either partitions, teeth, or clefts, the odd one anterior to the axis of inflorescence. Fruit a legume. Seed with the radicle next the hilum. (*Lindley, Introd. to N. S.*, and *Key.*) The ligneous species are trees and shrubs, for the most part deciduous; and they are disposed through almost every part of the world. The order contains some of our finest ornamental shrubs and low trees, such as *Robinia*, *Cytisus*, *Wistaria*, *Genista*, *Ulex*, *Amorpha*, *Halimodendron*, *Acacia*, *Gleditschia*, *Cercis*, and various others. It also contains some considerable trees, which belong to the genera *Robinia*, *Gleditschia*, *Sophora*, &c. The genera containing hardy ligneous plants are in number twenty-three, which, after De Candolle and G. Don, we place in characterised sections, and ascribe to them short characters, that are more or less contra-distinctive.

Sect. I. *SOPHO'REÆ.*

Sect. Char. Corolla, in most, papilionaceous. Stamens 10, with the filaments distinct. Legume not jointed. Cotyledons flat, leafy. Embryo with the radicle beside the edges of the cotyledons. Leaves simply pinnate, or simple.

- SOPHORA* R. Br. Legume necklace-shaped, including many seeds. Leaf with more than three leaflets.
VIRGILIA Lam. Legume compressed, including many seeds. Leaf with more than three leaflets.
PIPTANTHUS Swt. Legume compressed, including 6 seeds. Leaf with its leaflets 3.

Sect. II. *LO'TEÆ.*

Sect. Char. Corolla papilionaceous. Stamens 10, the filaments of all connate, or those of 9 connate, and that of one distinct. Legume not jointed. Embryo with the radicle beside the edges of the cotyledons. The cotyledons flattish; in germination, converted into leaves furnished with stomata. Leaves simply pinnate, or simple.

- ULX* L. Calyx 2-parted, 5-toothed. Legume oval-oblong, turgid, scarcely longer than the calyx, containing but few seeds, though the ovules are many. Habit spiny.
STAUROANTHUS Lk. Calyx 2-parted, 5-toothed. Legume flat, extended far beyond the calyx, containing many seeds. Habit spiny.
SPARTIUM Dec. Standard roundish. Keel acuminate. Branches rush-like. Leaf simple.
GENISTA Lam. Standard oblong-oval. Keel oblong, not wholly including the stamens and pistils. Leaves with 3 leaflets, or, in some, simple.
CYTISUS Dec. Standard ovate. Keel very obtuse, including the stamens and pistil. Leaves, in all, with 3 leaflets.
ADENOCARPUS Dec. Stamens with the filaments connate. Legume bearing stalked glands all over it.
ONONIS L. Calyx with 5 linear segments. Standard striate. Legume containing few seeds; in most, turgid.
AMORPHA L. Corolla consisting of the standard only.
ROBINIA Dec. Legume flat; that edge to which the seeds are attached margined. Leaf impari-pinnate.
CARAGANA Lam. Legume rather cylindrical. Leaf abruptly pinnate.
HALIMODENDRON Fisch. Legume stipitate, inflated, bladderly. Leaf abruptly-pinnate.
CALOPHYLLA Fisch. Stamens with the filaments of 9 connate, that of one distinct. Legume sessile, with concave valves bearing hairs, some soft, some rigid and glanded.
COLUTEA R. Br. Legume stipitate, much inflated, glabrous.
ASTRAGALUS Dec. Legume with its lower suture so bent in towards the opposite one as to cause the legume to seem, more or less, 2-celled.

Sect. III. *HEDYSA'REÆ.*

Sect. Char. Corolla papilionaceous. Stamens usually with the filaments connate in one of three modes; the 10 connate; 9 connate and one distinct; or connate by fives: in a few cases all are distinct. Legume dividing transversely into 1-seeded joints, called loments. Embryo with the radicle beside the edges of the cotyledons, which are flattish, and, in germination, are converted into leaves furnished with stomata. Leaves simply pinnate, or simple.

- CORONILLA* Neck. Calyx campanulate, usually shorter than the claws of the petals. Carina acute. Stamens diadelphous. Seeds ovate, or cylindrical.

Sect. IV. PHASEOLEÆ.

Sect. Char. Corolla papilionaceous. Stamens usually with 9 filaments connate, and one distinct. Legume not jointed, including many seeds, that are separated from one another with a cellular, transverse, membranous partition, that is in some cases not complete. Embryo with the radicle beside the edge of the cotyledons, which are thick, and, in germination, either remain under ground, or are changed into thick leaves that scarcely have stomata. Leaves simply pinnate, or simple.

WISTA'RIA Nutt. Leaf impari-pinnate.

LUPI'NUS Tourn. Leaf digitate.

Sect. V. CASSIÆ.

Sect. Char. Corolla, in most of the species, of equal petals; in some sub-papilionaceous. Stamens with the filaments distinct. Leaves doubly or triply pinnate; in some simple.

GLEDI'TSCHIA L. Sexes diœciously polygamous. Corolla of 3—5 equal petals. Legume in most long and narrow. Seeds compressed. Leaves compoundly divided. Bearing prickles in most.

GYMNO'CLADUS Lam. Sexes, by defect, diœcious. Corolla of 5 equal petals. Legume compressed and broad. Seeds scarcely compressed. Leaves compoundly divided.

CE'RCIS L. Sexes hermaphrodite. Corolla sub-papilionaceous, of 5 unequal petals; the side ones, or wings, longer than the others. Leaves simple.

Sect. I. SOPHOREÆ.

GENUS I.



SOPHORA R. Br. THE SOPHORA. *Lin. Syst.* Decândria Monogýna.

Identification. R. Brown in Hort. Kew., ed. 2. vol. 3. p. 2.; Dec. Lég. Mém., 5.; Prod., 2. p. 95.; Don's Mill., 2. p. 109.

Synonyme. *Sophora* spec. *Lin. Gen.*, No. 508.

Derivation. Altered from *sophora*, the Arabic name of a papilionaceous flowering tree.

Description. The only hardy species is a deciduous tree, a native of Japan or China, and it is highly ornamental. It is propagated by seeds, which are ripened in abundance in the south of France and Italy. The two varieties of this species (*S. japónica*) are propagated by grafting. All the sorts will grow in any soil which is dry; but in Britain, north of London, they are rather tender. On the Continent, however, where the summers are hotter than in England, and the winters colder, as at Vienna, for example, these trees are quite hardy.

‡ 1. *S. JAPÓNICA* L. The Japan Sophora.

Identification. *Lin. Mant.*, 78.; Dec. Prod., 2. p. 98.; Don's Mill., 2. p. 109.

Synonyme. *S. sínica* Rosier *Journ. Phys.*, 14. p. 248, Dec. Légum., t. 4. f. 1.

Engravings. Red. in N. Du Ham., 3. t. 21.; Dec. Légum., t. 4. f. 1.; and the plate of this species in our Second Volume.

Spec. Char., &c. Leaves pinnate, with 11—13 leaflets, which are oblong-ovate, acute, and smooth; panicle loose, terminal; pods smooth. A tree, a native of Japan, growing to the height of 40 ft. or 50 ft., and producing large bunches of rather small cream-coloured flowers in August and September. Introduced in 1763.

Varieties.

‡ *S. j.* 2 *variegata* Hort. has the leaves variegated, but is not worth cultivating as an ornamental plant.

‡ *S. j. 3 pëndula* Hort., has pendulous shoots, and is a very remarkable variety. Grafted near the ground, the shoots run along the surface, like those of a trailing plant, to a very great distance from the main stem; in good soil, a shoot extending itself 6 ft. or 8 ft. in one season. Grafted at the height of 10 ft. or 20 ft., the shoots hang down, and form one of the most ornamental of pendulous trees, both in summer and winter. There are specimens in the Horticultural Society's Garden, and in Knight's Exotic Nursery, King's Road, Chelsea. Our engraving of this tree in Vol. II. was taken from the former specimen. The bright smooth green of the branches renders this variety truly ornamental, even when deprived of its leaves.

Description, &c. This is a round-headed tree, readily distinguished in winter by the fine, smooth, dark green bark of its young wood and smaller branches; and, in summer, by the dark blue green of its foliage. In deep free soil, this tree grows with great rapidity, seedlings attaining the height of 10 ft. or 12 ft. in 4 or 5 years; and in 20 or 30 years, in the neighbourhood of London, that of 30 ft. or 40 ft. In France, near Paris, there are trees of the height of 60 ft. The sophora is one of the few trees that were introduced into France before they found their way into England. In 1747, Father d'Incarville sent seedlings of this tree to Bernard De Jussieu, at Paris, who sowed the seeds, and distributed the plants. In 1763, it is recorded, as having been cultivated in the Mile End Nursery, by Gordon, who probably received it from Jussieu. In 1779, a tree in the garden of M. De Noailles, at St. Germain en Laye, flowered for the first time in France; and soon afterwards seed was ripened in abundance, from which the nurseries of Europe have been supplied with plants. There are large specimens in England, which flower freely; but they have never yet ripened seeds: indeed, the tree ripens seeds in France only in the very warmest seasons.

Properties and Uses. The wood is very hard and compact, as much so, it is said, as that of the box. The bark exhales a strong odour, which, it is stated in the *Nouveau Du Hamel*, has a remarkable effect on those who prune the tree, or otherwise work with the wood in a green state. This was first discovered by a turner, who, while at work on a piece of wood newly taken from the tree, was seized with the colic, which obliged him to leave off. The following morning he resumed his work; and the same thing having happened to him again, he sent for a neighbouring turner, and afterwards for two others, who were all alike seized with colic, and violently purged. It appears, however, that the Chinese, who employ the wood in a dried state, suffer no inconvenience from it. It is somewhat remarkable, that, in the *Dictionnaire Général des Eaux et Forêts*, where the sophora is treated on at considerable length, and a long extract is made from a pamphlet published on the subject by M. Guerrapain, no notice is taken of this singular property. In that pamphlet, the sophora is mentioned as rivalling the *Robínia Pscúd-Acácia* in the robustness of its habit, and rapidity of its growth; and as surpassing it in durability, and in suitability for culture in arable lands, from its roots being chiefly of the descending kind; while those of the *Robínia* extend themselves horizontally near the surface. Little appears to be known of the uses of the tree in China and Japan; but it is said that the fruit is employed to dye a fine yellow; and the flowers for dyeing a yellow of so superior a hue, that it is exclusively reserved for dyeing stuffs to be worn by the members of the imperial family. In Britain, the tree can only be considered as ornamental; and, in that respect, none of the arboreous Leguminææ are equal to it in beauty of foliage and bark. Its flowers, when they are produced, are also in large terminal compound spikes, and very conspicuous, though much smaller than those of the *Robínia viscösa*. One remarkable property in the foliage of the sophora is, that the very hottest and driest seasons do not turn it pale, or cause it to drop off, as heat does that of most of the other pinnated-leaved Leguminææ. The same remark holds good in

France, and is strikingly exemplified in the remains of the garden at Marbœuf, near the Barrière de Chaillot, in Paris, where some very large sophoras and robinias are growing together. The pendulous variety is well deserving of culture as an object of singularity and beauty; and, where it is desired to cover a surface with intense green foliage during summer, for example, a dry hillock, a plant of this variety, placed on the centre, will accomplish the purpose effectually.

Soil, Propagation, &c. Any free soil will suit this tree; but, in cold climates, it ought to be placed in one rather poor and dry, that it may be compelled to make shorter shoots; which, of course, being less succulent, are more easily ripened. Where it is desired to have trees that will soon come into flower, seedling plants should be grafted with scions. The tree will grow by cuttings, more especially of the roots, and also by layers from a flowering tree.

Statistics. The largest tree in the neighbourhood of London is at Syon, where it is 57 ft. high; the diameter of the trunk is 3 ft., and of the head 80 ft. It flowers beautifully in most years. The oldest tree near London is at Purser's Cross, where it flowered, for the first time in England, in August 1807, as noticed p. 72. In Kensington Gardens, in the north-west corner, is an old tree, about 30 ft. high, which flowers occasionally. At Kew, there is a tree 50 ft. high. In the Mile End Nursery, there is a tree 35 ft. high, the trunk 2 ft. in diameter, and the diameter of the head 30 ft. At Hampstead, at Mount Grove, there is a tree 38 ft. high; and at Kenwood, one, 38 years planted, 32 ft. high. In Buckinghamshire, at Temple House, a tree, 40 years planted, is 18 ft. high. In Cambridgeshire, in the Cambridge Botanic Garden, there are two handsome trees, both 50 ft. high, which have flowered occasionally. In Cheshire, at Eaton Hall, 13 years planted, and 6 ft. high. In Hertfordshire, at Cheshunt, 6 years planted, and 10 ft. high. In Oxfordshire, in the Oxford Botanic Garden, 20 years planted, and 35 ft. high. In Worestershire, at Croome, 70 years planted, and 35 ft. high, the diameter of the trunk 2 ft. 4 in., and of the head 40 ft.: the soil a dark sandy loam. In Scotland, in Haddingtonshire, at Tynningham, 42 ft. high. In Perthshire, at Kinfauns Castle, 8 years planted, and 6 ft. high. In Ireland, near Dublin, at Castletown, 35 ft. high; at Terenure, 15 years planted, and 10 ft. high. In Louth, at Oriel Temple, 50 years planted, and 35 ft. high. In Munster, at Castle Freke, 13 ft. high. In France, at Paris, in the Jardin des Plantes, 100 years planted, and 64 ft. high, the diameter of the head 40 ft.: in the Rue des Vignes, a tree, which stood in what was formerly the garden of Marbœuf, was 60 ft. high, and flowered and ripened seeds almost every year; but it has lately been cut down, with several others in the same garden, the ground being about to be built on. In the Botanic Garden at Toulon, a tree, 50 years planted, is 60 ft. high. At Nantes, in the nursery of M. Nerrières, a tree, 30 years planted, is 25 ft. high. In Saxony, at Wörlitz, 20 years planted, and 25 ft. high. In Austria, at Laxenburg, 16 years planted, and 18 ft. high; at Brünn, 30 years planted, and 25 ft. high. In Prussia, in the Botanic Garden; at Berlin, 30 years planted, and 25 ft. high; at Sans Souci, 20 years planted, and 20 ft. high. In Bavaria, at Munich, in the Botanic Garden, 20 years planted, and 25 ft. high.

Commercial Statistics. Price, in London, of 2 years' seedlings, 50s. per 100, of grafted plants 2s. 6d., and of the pendulous variety 5s.; at Bollwyller, of the species 1 franc and 50 cents each, and the variegated variety 3 francs; at New York, the species, and the pendulous variety, 1 dollar each.

GENUS II.



VIRGILIA L. THE VIRGILIA. *Lin. Syst.* Decándria Monogýnia.

Identification. Lam. Ill., t. 346.; Pers. Ench., 1. p. 453.; R. Brown in Hort. Kew., ed. 2. vol. 3. p. 4.; Dec. Prod., 2. p. 98.; Don's Mill., 2. p. 111.

Derivation. Named by Lamarck in honour of the poet *Virgil*, whose *Georgics* entitle him to botanic commemoration.

Description, &c. There is only one hardy species, a deciduous low tree.

♀ 1. V. LU'TEA Michx. The yellow-wooded Virgilia, or Yellow Wood.

Identification. Michx. Fil. Arb. Amer., 3. p. 266. t. 3.; Dec. Prod., 2. p. 98.; Don's Mill., 2. p. 112.

Engravings. Delaun. Herb. Amat., t. 197.; Michx. Fil. Arb. Amer., 3. p. 266. t. 3.; and the plate of this tree in our Second Volume.

Spec. Char., &c. Leaves pinnate; leaflets 9—11; alternate, ovate, pointed, smooth. A tree, in its native country rarely exceeding 40 ft. in height, with a trunk 1 ft. in diameter, covered with a greenish bark, having a smooth surface. The leaves, on young trees, are from 1 ft. to 1½ ft. in length, and on old trees not above half that size. The flowers form white pendulous racemes, a little larger than those of the *Robinia Pseud-Acacia*, but not so odoriferous. The seeds are like those of the robinia, and, in America, ripe

about the middle of August. In Britain, the tree is seldom seen in flower, there being but few old specimens.

Geography, History, &c. *Virgilia lutea* is found chiefly in the western part of Tennessee, on gentle declivities, on a loose, deep, and fertile soil; where it is usually associated with *Morus rubra*, *Gymnocladus canadensis*, *Gleditschia*, *Juglans*, and other trees which delight in good soil. It was discovered by the younger Michaux; and plants of it were first brought to England by Mr. Lyon, in 1812; and seeds having been since frequently sent over, the plant is now to be met with in most collections. The wood is fine-grained and soft; and remarkable for its deep yellow colour. This colour is given out freely to water, but cannot be fixed by alum, like most other vegetable colours. Very little use is made of the tree in America; and, in Europe, it is planted solely for purposes of ornament and botanical interest. It is rather later in coming into leaf than most of the other pinnate-leaved Leguminææ, and its leaves drop very early in autumn, previously becoming of a fine yellow.

Soil, Situation, &c. An open airy situation is desirable, in order that the tree may ripen its wood; and, to facilitate the same purpose where the climate is cold, the soil ought to be dry rather than rich. In the London nurseries, it is propagated chiefly by seeds.

Statistics. In the neighbourhood of London, the highest plants are at the Duke of Devonshire's villa at Chiswick; but, as they are crowded among other shrubs, they are not handsome; in the Chelsea Botanic Garden, there is a tree 20 ft. high, which flowers annually; in the London Horticultural Society's Garden, there is one 10 years planted, which, in 1834, was 13 ft. high; in the Mile End Nursery, there is a tree 18 ft. high. In Surrey, at Claremont, there is one 20 ft. high. In Sussex, at West Dean, one, 9 years planted, is 18 ft. high. In Berkshire, at White Knights, one, 25 years planted, is 23 ft. high; the diameter of the trunk is 5 in., and of the head 20 ft. In Essex, at Hylands, 10 years planted, and 17 ft. high. In Pembrokeshire, at Golden Grove, 35 years planted, and 17 ft. high. In Suffolk, at Ampton Hall, 12 years planted, and 11 ft. high. In Ireland, near Dublin, in the Cullenswood Nursery, 17 years planted, and 25 ft. high.

Commercial Statistics. Plants, in London, are 5s. each; at Bollwyller 1 franc and 50 cents; and in New York, 50 cents.

GENUS III.



PIPTANTHUS *Swt.* THE PIPTANTHUS. *Lin. Syst.* Decándria Monogýnia.

Identification. *Swt. Fl.-Gard.*, 264; *Don's Mill.*, 2. p. 112.

Derivation. From *piptō*, to fall, and *anthos*, a flower; from the flowers falling off very soon.

Description, &c. There is only one species described or introduced, which is a sub-evergreen bush or low tree.

■ *P. NEPALENSIS* *Swt.* The Nepal Piptanthus.

Identification. *Swt. Fl.-Gard.*, 264; *Dec. Prod.*; *Don's Mill.*, 2. p. 112.

Synonymes. *Thermopsis laburnifolia* *D. Don Prod. Fl. Nep.*, p. 239; *Anagyris indica* *Wall. MSS.*; *Baptisia nepalensis* *Hook. Exot. Fl.*, t. 151.

Engravings. *Hook. Exot. Fl.*, t. 151; *Swt. Fl.-Gard.*, t. 264; and our *fig.* 237, to a scale of 2 in. to a foot, and *fig.* 238, representing a flower of the natural size.

237



Spec. Char., &c. Leaves trifoliate; leaflets elliptical-oblong, acute, broad. Stipules 2, large. The young leaves are silky; and the flowers are of a bright yellow, and are much larger than those of the common laburnum, to which they bear a general resemblance. In Nepal, the shrub grows to the height of 8 ft. or 10 ft.; but it sometimes exceeds this height in

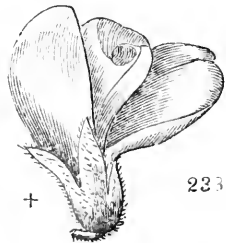

238

British gardens, in warm sheltered situations. It may be considered as rather tender, and not of many years' duration: nevertheless, in fine seasons, it ripens abundance of seeds. It was introduced in 1821, and flowers in May and June. It may be propagated by cuttings of the roots, and of the shoots, as well as by seeds or layers. In most of the counties north of London, the safest situation for it will be against a wall; and it well deserves a place there, on account of its luxuriant deep green foliage, and large bright yellow flowers. Price, in the London nurseries, 2s. 6d. each; and at Bollwyller, where it is a green-house plant, 3 francs.

App. i. *Half-hardy Species of Sophorææ.*

Sophora velutina Lindl. (*Bot. Reg.*, t. 1185.) is a Nepal shrub, introduced in 1820, which grows to the height of from 4 ft. to 6 ft. The flowers are pale purple, in long racemose spikes. Mr. G. Don suggests the idea of grafting it on the *S. japonica*, by which means, he says, it would be rendered so hardy as to stand our winters in open shrubberies.

S. tomentosa Hook, the *S. occidentalis* of Lindl. (*Bot. Reg.*, t. 3390.), is an evergreen Brazilian shrub, growing to the height of 5 ft. There is a variety of this species not yet introduced, the leaves of which are dark green and shining; and the flowers are in spike-like panicles, in form and colour much like those of the Spanish broom, but rather paler. (See *Gard. Mag.*, xl. p. 191.)

239

Edwardsia chilensis

Miers, the *Sophora macrocarpa* of Smith and of Don's *Mill.*, (*Lodd. Bot. Cab.*, t. 1125., and our fig. 239.) is a native of Chili, introduced by Messrs. Loddiges in 1822. It was planted against a wall in the arboretum at Hackney; and, after having stood there 3 years, it flowered there, for the first time in England, in April 1826. Its flowers are large, and of a rich yellow; the leaves are also large; and, what is rather uncommon in plants of this order, they are evergreen. In 1835,

240

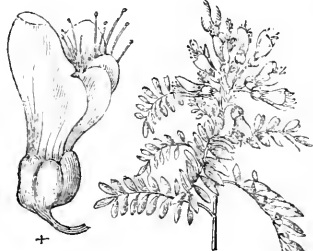

the plant in the arboretum of the Messrs. Loddiges was 5 ft. high. (See a description of it in *Gard. Mag.*, vol. xi. p. 584.) It may be considered as one of our most ornamental half-hardy shrubs, and may probably prove to be quite hardy. It grows freely in light loamy soil, and is propagated by cuttings.

Edwardsia grandiflora Salisb., the *Sophora tetraptera* of Ait. (*Bot. Mag.*, t. 167., and our fig. 240.) is a handsome New Zealand low tree or shrub, introduced in 1772, and producing its large pendulous bright yellow flowers in April and May. This is a most ornamental plant, and, in the environs of London, succeeds perfectly when trained against a wall, requiring very little, if any, protection. In the Chelsea Botanic Garden, there is a tree 12 ft. high; and some nearly of equal height in the garden of the Horticultural Society, and in Loddiges's arboretum.

241

E. microphylla Salisb., the *Sophora microphylla* of Ait. (*Lam. Ill.*, t. 325., and our fig. 241.) is also a low tree from New Zealand, closely resembling *E. grandiflora*, but much smaller in all its parts. It is equally hardy, if not more so, and is truly ornamental when in flower. Plants of it in the Botanic Garden at Kew have stood against a south wall for upwards of 20 years. In the Chelsea Botanic Garden, there are plants of it 7 ft. high; and in Dorsetshire, in the Upway Nur-

242



sery, Dorchester, it has ripened seeds as a standard in the open border. There is a variety in the Chelsea Botanic Garden, with very narrow leaves, which, in 3 years, has attained the height of 6 ft.

E. myriophylla Wand. (*Don's Mill.*, 2. p. 111.), *E. minima* *Lodd. Cat.*, is a New Zealand shrub, introduced in 1818, and is, doubtless, as hardy as the other species of the genus.

E. chrysophylla Salisb. (*Don's Mill.*, 2. p. 111., *Bot. Reg.*, t. 738.) is a native of the Sandwich Islands, where it grows to the height of 8 ft. or 10 ft., producing flowers rather smaller than those of *E. myriophylla*. It seems as hardy as any other species; for a plant of it has stood in the front of the stove in the Botanic Garden at Kew since it was first introduced in 1822.

Cyclotia genistoides R. Br; *Bot. Mag.*, t. 1259., the *Gompholobium maculatum* of *Bot. Rep.*, t. 427



243



244



245

is a handsome frame shrub from the Cape of Good Hope, growing to the height of 8 ft., and producing its yellow flowers in July and August. There are several green-house species of *Cyclöpia*, which might also be kept in a frame, or against a conservative wall.

Podalyria sericea R. Br. *Bot. Mag.*, t. 1293, the *Sophora sericea* of *Bot. Rep.*, t. 440, and our fig. 242, is a Cape shrub, with pale purple flowers; and there are other species of the same genus, also with purple flowers (as will be seen by our *Hortus Britannicus*), all of which are suitable for a conservative wall.

Chorózema Henchamni R. Br. (*Bot. Reg.*, t. 986, and our fig. 243.) is a beautiful little New Holland shrub, with hoary leaves and bright scarlet and buff flowers, which, with other species of the genus, well deserves culture in the open air, in fine warm situations, even if they should require to be taken up, and kept in a pot during winter.



246

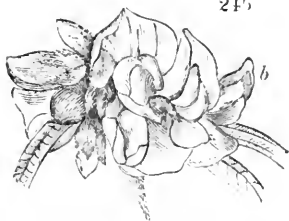

247



Podolobium trilobatum R. Br. (*Sims Bot. Mag.*, t. 1477; and our fig. 244, representing a branch to a scale of 2 in. to a foot, and fig. 245, the flowers of the natural size) is a handsome shrub from New South Wales with coriaceous leaves, and yellow flowers; to which, and to other species of the genus, the same remarks apply as to *Chorózema*.

Orylobium arborescens R. Br. (*Bot. Cab.*, t. 163; and our fig. 246, *a* showing the habit of the plant, and *b* representing the flower of the natural size) is a Van Diemen's Land shrub, producing its yellow flowers in May and June, and growing to the height of 6 ft. There are other species from Van Diemen's Land, and several from New Holland and New South Wales, all elegant, and all, doubtless, half-hardy.



248



249



250

Callistachys ovata Sims (*Bot. Mag.*, t. 1925, and our fig. 248.) is a New Holland shrub, producing fine large spikes of yellow flowers from June to August, and growing to the height of 6 ft.

Brachysena latifolium R. Br. (*Bot. Reg.*, t. 118.; *Bot. Mag.*, t. 2008.; and our fig. 247.) is a handsome New Holland climbing shrub, producing large scarlet flowers from April to July, which no conservative wall ought to be without.

Gompholobium grandiflorum Smith (*Bot. Reg.*, t. 484.) is a New Holland shrub, with fine large yellow flowers, which are produced from March to September. It grows to the height of 3 ft.; and there are several other species from the same part of the world.

Burtônia R. Br. is a genus that includes a few New Holland species; but they do not exceed 1 ft. in height.

251



Jacksônia (named by Mr. Brown in honour of *George Jackson*, an acute Scotch botanist, once librarian to A. B. Lambert, Esq., and a particular friend of ours) scopària R. Br. (*Bot. Cab.*, t. 427.) is a handsome shrub from New South Wales, with the habit, nearly, of *Genista monosperma*. It grows to the height of 6 ft., and flowers in July and August. There are several other species.

Viminària denudata Smith (*Ex. Bot.*, t. 27.; *Bot. Mag.*, t. 1190.; and our fig. 249. to scale of 2 in. to a foot, and fig. 250. of the natural size) is an elegant New Holland shrub, growing to the height of 4 ft., and flowering from June to September.

Sphærolobium vininum Smith (*Bot. Mag.*, 969.; and our fig. 251. to a scale of 2 in. to a foot, and fig. 252. of the natural size) is a diminutive Australian shrub, producing yellow flowers from May to August; and

S. medium is another species of the same genus, producing red flowers.

Aotus ericoides Don's Mill., 2. p. 120. (*Bot. Mag.*, t. 949.; and our fig. 253., in which the branch of the natural size is marked (as in all similar cases) with a +) is a very neat little heath-like low

252



253



254

shrub, producing its fine yellow flowers from April to June. There are other species, all with narrow heath-like, or rosemary-like leaves.

Dillwynia glaberrima Smith (*Bot. Mag.*, t. 944.; *Bot. Cab.*, t. 552.; and our fig. 256. to a scale of 2 in. to a foot, and fig. 255. of the natural size) is a handsome New Holland shrub, producing its fine yellow flowers from March to July, and growing to the height of 4 ft. There are several other species, all deserving of culture.

Eutaxia myrtifolia R. Br. (*Bot. Mag.*, t. 1274.; and our fig. 254. the flower of the natural size being marked with a +.), and *E. pungens* Sweet (*Fl. Aus.*, t. 28.), are elegant evergreen New Holland shrubs, which Mr. Sweet has shown might easily be kept in pits, or against conservative walls in the neighbourhood of London; or grown, without any kind of protection, in the open air, in Devonshire.

Sclerothinnus microphyllus R. Br. is an elegant New Holland shrub, growing to the height of 2 ft. The leaves are stiff, and the whole plant rigid, as the generic name implies. The flowers are yellow, and are produced from May to July.

Gastrolobium bilobum Ker (*Bot. Reg.*, t. 411.; *Bot. Cab.*, t. 70.) is a pretty little New Holland shrub, producing its fine yellow flowers from March to May.

Euchilus obcordatus R. Br. (*Bot. Reg.*, t. 403.; *Bot. Cab.*, t. 60.; and our fig. 258. to a scale of 2 in. to a foot, and fig. 257. of the natural size), is an elegant plant, producing yellow flowers, which have a purple keel, from March to June.

Pultenæa is a genus of 41 species, which are described in Don's *Miller*; and many of them are in cultivation in our green-houses, pits, or cold-frames. — *P. stricta* Bot. Mag., t. 1388.; (*Bot. Cab.*, t. 274.; and our fig. 259.) will give an idea of these plants. *P. stricta* is a native of Van Diemen's Land.

Daviesia latifolia R. Br. (*Bot. Mag.*, t. 1757.; and our fig. 261. representing one branch (a) to the scale of 2 in. to the foot, and part of a branch (marked with a +) of the natural size) is a Van

257

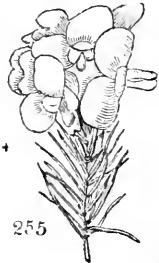

255



256



258

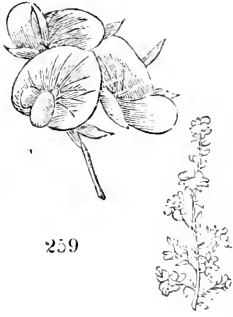

259

Diemen's Land shrub, with yellow flowers which have the vexillum copper-coloured. It grows to the height of 4 ft., and flowers from May to August. There are 14 species, all from the same part of the world; and all, doubtless, half-hardy in the climate of London. In considering what may be the degree of hardiness of plants, natives of foreign countries, it must be remembered that the constitution of every plant has an absolute and a relative character; the former can only be known experimentally by culture in different countries, or by noticing it in a wild state in different climates, and localities; but the latter may be judged of by observing how a plant accommodates itself to the climate and locality in which it may exist for the time being. Hence a number of plants which appear tender are only relatively so, from having been grown in a warm climate; while the same plant, reared in a cold climate, would be absolutely hardy. The common yew, for example, as Dr. Walker has mentioned, grown in France, proved quite tender when taken to



260

Stockholm; though the yew, as it is well known, is indigenous to Sweden. Plants, therefore, which are natives of Van Diemen's Land may, in the course of two or three generations, without altering their nature, be found as hardy as natives of Scotland.

Mirbèria reticulata Smith (*Bot. Mag.*, t. 1211., and our fig. 260.) is a handsome New Holland shrub, with lilac flowers; and there are several other Australian species of this genus, all beautiful, and all deserving culture, though requiring some protection during winter.

General Remarks as to half-hardy Species.—We may observe here, what to many will appear sufficiently obvious, that plants half-hardy in the climate of London will, in general, be quite hardy in the warmest parts of Devonshire and Cornwall; and will gradually require less and less protection than they do about London, as we proceed farther southward; always excepting, however, particular localities, such as elevated regions, very wet or clayey soils, and retentive subsoils. As a proof of the truth of what we state, we have only to refer to such plants as the common myrtle, *Corræa alba*, *Coronilla glauca*, *Pittosporum Tobira*, the edwardsias, &c., which all thrive against walls in the neighbourhood of London, but require a slight protection during frost; while at Dartmouth, Plymouth, Mount Edgecombe, Powderham Castle, Mamhead, Carclew, and other well-known places, they are shrubs as hardy as *Buxus balæarica* is near the metropolis. As we proceed northwards,



261



it will be found that plants adapted for a conservative wall in the climate of London may be divided into three kinds: the more tender, which will require, in the colder situations, to be kept in the green-house or conservatory, such as eutaxia; the less tender, which will grow against a wall, in low situations near the sea, as far north as Inverness, such as pittosporum, with the same protection as they require about London; and the hardiest, which may be preserved against a wall, with very little more protection than what they receive about London, in all ordinary situations in the north. Among this latter kind may be included the myrtle, the camellia, edwardsia, psoralea, &c., which, it is well known, require very little protection at Culzean Castle, in Ayrshire; at Ardgowan, near Greenock; at Dundee, Montrose, Aberdeen, Elgin, and Inverness. Even at Dunrobin Castle, these plants, and various others, are grown in the open air, and kept alive through the winter with protection. The experience of gardeners in this most interesting part of their profession is, as yet, in its infancy; but it is not difficult to foresee that, as the enjoyments afforded by conservative walls become better known, a knowledge of their management, and of the principles of acclimatising plants, will be considered essential for every master-gardener.

Sect. II. LO'TEÆ.

GENUS IV.



U'LEX L. THE FURZE. *Lin. Syst. Monadélphia Decándria.*

Identification. *Lin. Gen.*, No. 881.; *Lam. Ill.*, t. 621.; *Dec. Prod.*, 2. p. 144.; *Don's Mill.*, 2. p. 148.

Synonymes. Ajonc, *Fr.*; Hecksame, *Ger.*

Derivation. Said to be derived from *ac*, Celtic, a point; in reference to the prickly branches.

Description, &c. Branchy, evergreen, spinous shrubs, with yellow flowers, natives of Europe, which will grow in any tolerably good soil that is dry; and are readily propagated by seeds, or by cuttings, planted in sand.

■ 1. U'LEX EUROPEA L. The European, or common, Furze, or Whin.

Identification. *Lin. Spec.*, 1045. var. α .; *Dec. Prod.*, 2. p. 144.; *Don's Mill.*, 2. p. 148.

Synonymes. *Genista spinosa L'Obel.*, *U. grandiflorus Pour.*; *U. vernalis Thore*; Whin, Gorse, Prickly Broome; Ajonc common, Jonc marin, Jonarin, or Genêt épineux, *Fr.*

Engravings. *Eng. Bot.*, t. 742.; and our *fig.* 262. to a scale of 2 in. to a foot, and *fig.* 263. of the natural size.

Spec. Char., Description, &c. Leaves lanceolate, linear. Branchlets villous. Bractees ovate, loose. Calyx pubescent. An erect evergreen shrub, with yellow flowers, which are produced in abundance from February to May, and, in mild winters, from September till May. Indeed, it may be said to be in flower, more or less, the whole year; and hence the country proverb, that "Love goes out of fashion, when the furze is out of blossom." In a wild state, in cold elevated situations, it is seldom seen higher than 2 ft. or 3 ft.; but in sheltered woods, in England, it may frequently be seen of 10 ft. or 12 ft. in height. In Spain, on the mountains of Galicia, it grows to the height of 18 ft., with stems as thick as a man's leg.

Varieties.

■ *U. e. 2 flore pleno* has double flowers, and is a splendid plant when profusely covered with blossoms. It is well adapted for small gardens; and is easily increased by cuttings. A plant in our garden at Bayswater, in 5 years, formed a bush 8ft. high, and 6 ft. in diameter, flowering profusely from April to June.

U. provincialis and *U. stricta* are probably only varieties of *U. europæa*, but, as they may possibly belong to *U. nana*, we have kept them distinct, and treated them as botanical species or races.

A variety with white flowers is mentioned by Gerard and Parkinson, as reported to have been seen in the north parts of England; but no such variety is now known.

262



Geography. The common furze is a native of the middle and south of Europe, on gravelly soils, on plains and hills, but not generally to a very great elevation.

In Caernarvonshire, it grows to the height of 1500 ft. above the sea, in open, airy, warm situations; but in damp shaded valleys, not higher than 600 ft. In the north of England, according to Winch, it forms fine fox covers, at 800 ft. or 900 ft., and

213



grows, in warm sheltered situations, at 2000 ft. At Inverness, it is found to the height of 1150 ft. About Tongue, in the north-west of Suther-

land, where it was introduced, but is now naturalised, it scarcely attains 350 ft. of elevation. Its failure, Watson observes, marks the higher part of the upland zone, and gives an accurate indication of the climate. (*Outlines, &c.*, p. 124.) It grows on the sea coast, close to the water's edge, flowering abundantly, and apparently uninjured even when washed by the spray of the sea. It is not found wild in Asia, Africa, or America; in the north of Germany, Denmark, Sweden, or Russia. Gerard tells us that he was desired by "divers earnest letters," to send seeds of our common furze and broom to "the colder countries of the East, as Dantzicke, Brunswicke, and Poland," where the plants were "most curiously kept in their fairest gardens." (*Herbal*, p. 1320.) Linnæus lamented that he could hardly preserve it alive in a green-house; and Dillenius, when he first visited England, knelt down in admiration of the quantities he saw in flower on Hounslow Heath. The furze is abundant in the middle and southern districts of Scotland, though Dr. Walker doubts its being truly indigenous, from its flowering in the winter; jocularly observing that "no truly Scotch plant would be so rash." Though indigenous in England, it is nevertheless, in extremely severe winters, killed down to the ground; from which, however, it shoots up the following season. This happened in the winter of 1819-20, to whole fields of furze in Surrey.

History. The furze is commonly thought to be the *Scórpis* of Theophrastus and the *Ulex* of Pliny. By modern botanists, before the days of Linnæus, it was considered as a species of broom; and L'Obel and other writers, accordingly, style it *Genista spinosa*. Linnæus restored to it the name of *Ulex*, which it has since retained throughout the botanical world. The earliest notices which we have of the plant are in Turner, who calls it *Genista*; and in Gerard, who calls it *Genista spinosa vulgaris*. Hanbury enumerates no fewer than 6 varieties of it, differing in the length of the spines; and one having white flowers, and another a dwarf habit: but there are none in cultivation at present, worthy of being kept distinct, except the upright and double-flowered varieties. In France, in the province of Britany, and in Normandy, the furze bush has been used as fodder for cattle from time immemorial: it is bruised in a cider mill, and given to them in a green state. Evelyn informs us that it was cultivated for this purpose in Herefordshire; and that, in Devonshire, the seeds were sown in the worst land, the tops given to horses, and the branches used for fuel, burning lime, and other purposes. Du Hamel says that, about Poitiers, in Britany, the furze is sown and treated in exactly the same manner as saintfoin. In Britain, the furze is cultivated in various places, for hedges, fodder for cattle, protection for game, and underwood. Captain Cook mentions that, when he touched at St. Helena, he found the inhabitants had planted a great quantity of furze there, to be used as fodder, and also as shelter to the pasturage, by excluding heat and evaporation. About 1825, or earlier, the double-flowered variety was found wild in Devonshire; and that has since been propagated, and very extensively cultivated in gardens, as an ornamental evergreen flowering shrub.

Properties and Uses. As fodder, the young branches, bruised, and given to cattle and horses, in a green state, are found highly nutritive; and not to affect the taste either of the milk or butter of cows. In some parts of the country, furze bushes, in a wild state, are cropped for this purpose; and in others the clippings of furze hedges are taken; but, where the practice of feeding with furze is to be carried on as part of a regular system of farm management, the most efficient mode is, to cultivate the plants in a regular rotation with corn and other crops, mowing them twice in 4 years, or thrice in 6 years, and afterwards breaking up the ground for corn. The shoots are bruised by passing them between two fluted rollers, or grinding them in a bark or cider mill. (See *Encyc. of Agr.*, 2d edit., § 2553.) In Wales, an upright-growing variety (to be hereafter noticed as a botanical species) has lately been chiefly cultivated for fodder, on account of the comparative absence of prickles, the slenderness of the shoots, and the erect, compact, or fastigate

form of the plant. This plant requires neither bruising nor grinding, but may be given to horses in the same manner as clover or tares; but, as it never flowers or produces seeds, it requires to be propagated by cuttings.

The use of furze for hedges is chiefly desirable in situations where the hawthorn or the holly will not thrive; because the furze is not a plant of long duration; and, after being some time in culture as a hedge, it is apt to get naked below, even if clipped or pruned on the sides; and to extend to a great width, if left untouched by the knife or shears. The most rapid mode of forming a hedge of it is, to raise a bank of earth, say 5 ft. or 6 ft. wide at bottom, 2 ft. wide at top, and 3 ft. or 4 ft. high. The seeds may then be sown on a drill along the middle of the top, and the plants either left to grow and hang down on each side irregularly, or be clipped into regular shape as a hedge, according to the taste of the owner, or other circumstances. The most economical mode is, to clip the hedge on each side, so that the section of it may complete the upper part of the triangle, of which the earthen bank forms the lower part. The proper time for clipping such a hedge is either in autumn, after the growth of the shoots is completed, or in spring, before it is commenced; and only so much should be cut at a time, as can be bruised and consumed by the cattle to be fed with it. In rich soils, there can be no doubt that the furze would form hedges 10 ft. or 12 ft. high, if regularly pruned on each side; and, perhaps, for a market-gardener, who keeps a cow and a horse, this would be the most profitable of all kinds of subdivision hedges. Where an evergreen hedge is wanted for shelter in a garden, and where the clippings or prunings are not wanted as fodder, then the fastigiata variety is much to be preferred, as it grows very compact, and requires little or no pruning. In ornamental gardens, the double-flowered variety, unpruned, forms a splendid hedge when in flower; but it is only suitable where there is abundance of room. In 1835, there was a splendid hedge of this variety in the Knaphill Nursery.

A picturesque hedge of furze, to serve as a boundary to plantations, has been adopted with success in Gloucestershire, by Charles Lawrence, Esq., who gives the following directions for raising it:—" Sow furze seed early in the spring, on stony or gravelly banks, on which there is a little good mould, as the plants are thereby provided with much more fibrous root than when the seed is sown on stiff clay soils; keep the plants clean, and transplant them in November, or early in February, to the front of the plantation. Fence them with a post and two-rail fence, which will keep off cattle (the occasional bite of sheep or lambs will rather do good than harm), and keep them hoed. In the following spring, clip off with shears the principal part of the first year's shoots. The plants will make very luxuriant shoots during the next two years, after which the posts and rails are to be removed; the branches of the furze must then be collected in the hand, and drawn forward towards the field, while the posts and rails are again put up on the plantation side of the furze, about 1 ft. or 18 in. within the stems of the plants; and, as each rail is fixed, the branches of furze are disengaged, and fall back against the fence; so that, at a moderate distance, it is not seen. When the furze thus becomes laid open, the tender parts of all the young shoots are browsed by cattle and sheep, which makes it grow so thick and close, that, by the time the posts and rails decay, it is a perfect fence to the plantation. Different forms may be introduced, occasionally, to vary the effect, which is extremely beautiful, especially when the furze is in bloom. (*Gard. Mag.*, vol. viii. p. 678.)

As a shelter to young trees, the furze is sometimes sown where acorns, beech masts, or chestnuts, are to be sown, or young trees are to be planted, in order to shelter them for a few years, till they grow up, and have sufficient strength to shelter one another; when they will overtop the furze and destroy it. This practice has been adopted to some extent in the government plantations in the New Forest, and in the Forest of Dean. For this purpose, to afford a shelter for game, and also to serve as undergrowth in the

plantations, it is only necessary to dig the ground, sow the seeds at the average rate of one or two to a square foot, and, when the plants come up, to keep them clear of weeds for the first year.

The use of furze in a dead state is chiefly as fuel for bakers' ovens, for brick, tile, and lime kilns, and for lighting fires. In Scotland, it is sometimes used in kilns for drying oats. In England, a common use of it is to weave into the sides of hovels for sheltering cattle, to prevent them from rubbing against them. In gardens, the points of the shoots are chopped into pieces of about an inch in length, and dropped into the drills in which peas are sown before the seeds are covered; and, the earth being drawn over them, and trod down, they are found effectually to resist the attacks of mice and small birds. In France, the chopped branches are mixed with cow dung, and the mixture afterwards formed into bricks, which are dried in the sun, and used as fuel. The seeds, if they could be procured in sufficient quantity, would, if ground into flour, form a nutritive food both for cattle and swine: they retain their vital property for several years. In Britany, large heaps are formed of alternate layers of turf and dried furze branches; and the whole being set fire to, the ashes are preserved as manure. In many parts of both France and England, the ashes of dry furze branches are used as a lye for washing linen; and for this purpose the ashes are made into balls, and sold by the country people in the markets.

Poetical and legendary Allusions. The beauty of the common furze, or gorse, when in blossom, and the circumstance of its growing wild in England, has induced most of our English descriptive poets to allude to it in their writings. Cowper says:—

"The common overgrown with fern, and rough
With prickly gorse, that, shapeless and deform'd,
And dangerous to the touch, has yet its bloom,
And decks itself with ornaments of gold,
Yields no displeasing ramble."

And Hurdis observes:—

"And what more noble than the vernal furze,
With golden baskets hung? Approach it not,
For every blossom has a troop of swords
Drawn to defend it."

The linnet is said to be very fond of nestling in furze bushes; a circumstance which has been noticed by Thomson in his *Seasons*:—

"Nor are the linnets, o'er the flowering furze
Pour'd out profusely, silent."

Many other instances might be given of poetical notices of this shrub and *U. nana*. Indeed, the rich golden hue of the blossoms of the latter contrasts so beautifully with the bright purple blossoms of the heath, which is generally found near it, and in flower at the same season; and both give such a richness to the wild scenery in which they usually grow, that it is not surprising to find them attracting the attention of all the British poets who have written on rural themes.

Propagation and Culture. A pound of seeds, which, in London, costs from 8d. to 1s., will sow an acre broad-cast, or a drill of a mile in length as a hedge. No culture is required for broad-cast crops, except keeping the plants clear of weeds for the first year or two; but hedges require to have the weeds taken out every year; and where they are to be clipped, that operation should be performed once a year. The double-flowered and the fastigate varieties are propagated by cuttings: the latter, when wanted for agricultural purposes, may be bedded in, like box, in a sandy soil rather moist, in the beginning of September; and by the following spring they will be fit to transplant. In Caernarvonshire, cuttings are formed of the points of the shoots of the present year's wood, about 3 in. long; they are bedded in sandy garden soil, in August; transplanted into the field, in rows 18 in. apart, and at 1 ft. distance in the row, in March; and mown for the first time in the September following. The produce even of the first year is found to be of more value than a crop of clover; and the quantity of forage increases with the strength of the plants

2. *U. (E.) NA`NA* Forst. The dwarf Furze.

Identification. Smith Eng. Fl., 3. p. 266.; Engl. Bot., t. 743.; Dec. Prod., 2. p. 144.; Don's Mill., 2. p. 148.

Synonymes. *U. rahnor* Roth Cat., 1. p. 83.; *U. europæus* β *Lin. Spec.*, 1045.

Engravings. Engl. Bot., t. 743.; and our fig. 264. to a scale of 2 in. to a foot, and fig. 265. of the natural size.

Spec. Char., &c. Branches and leaves smooth, the latter linear.

Calyx glabrous, with spreading narrow teeth. According to Smith, the essential character consists in the more distinct and spreading calyx teeth, and the more minute, rounded, close-pressed, and often hardly discernible, bractæas. A low spiny shrub, a native of Britain, and the western parts of France, on poor gravelly soils.

Abundant in Surrey, on the Portsmouth Road; found in Dumfriesshire, and on the Pentland Hills, in Scotland; and also in Ireland. This is a very distinct sort, though, from the very different and more luxuriant habit which the plant has when cultivated in gardens on rich soils, we have no doubt of its being only a variety of *U. europæa*. In its native habitats, it is easily distinguished from that species by its low growth, seldom exceeding 2 ft. in height; by its being much smaller in all its parts; by its decumbent habit; and by its flowering from the end of August till the beginning of December, and seldom at any other season. This sort, H. C. Watson observes, generally grows at a greater elevation by 200 ft., in North Wales, than the common sort. (*Outlines, &c.*, p. 124). The only use of this plant in cultivation is to produce variety in ornamental plantations. A double-flowered variety of it, would be a desirable acquisition. Very neat low hedges and edgings may be formed of it.



3. *U. (E.) PROVINCIA`LIS* Lois. The Provence Furze.

Identification. Lois. Not., 105. t. 6. f. 2.; Dec. Fl. Franc. Suppl., No. 3799.; Dec. Prod., 2. p. 144.; Don's Mill., 2. p. 148.

Engraving. Lois. Not., 105. t. 6. f. 2.

Spec. Char., &c. Calyx rather pubescent, with lanceolate distant teeth. Shrub erect; intermediate, in all its parts and in its habit, between *U. europæa* and *U. nana*. A native of Provence, Andegavany, and Mauritania; where it grows to the height of from 2 ft. to 4 ft. Whatever doubts there may be as to *U. nana* being a distinct species, there can be none as to this sort being only a variety. As an evergreen shrub, flowering freely, it well deserves a place in collections.

4. *U. STRI`CTA* Mackay. The upright-growing, or Irish, Furze.

Identification. Mackay's List of Irish Plants; Hook. Brit. Fl., p. 317.

Synonymes. *U. hibernica* Don's Mill., 2. p. 148.; *U. fastigiata* Hort.

Spec. Char., &c. Habit erect, narrow, and compact. Spines few or none; and what there are weak, branched, leafy, and pubescent. A native of Ireland, where it was discovered in the Marquess of Londonderry's Park, in the County of Down, in 1815, or before. It is very upright in its growth, and attains the height, in good soils, of from 6 ft. to 10 ft. in as many years. Its branches are so soft and succulent, that sheep and cattle eat them without injuring their mouths, and are very fond of them. It forms excellent garden hedges, and, in rather moist climates, is a most excellent forage plant, as has been already stated under *U. europæa*. It very rarely flowers, and has never produced seeds; but it is easily propagated by cuttings. Sir W. J. Hooker doubts whether it should be referred to *U. europæa* or *U. nana*, or be considered as a distinct species; he says (*Encyc of Geog.*,

p. 329.) that he has seen both flowers and seed vessels, which do not differ in any material point from those of *U. nana*. We have no doubt in our own mind of its being only a variety of *U. europæa*; but we have preserved it distinct, because it is truly so in its habit, and most important in its uses. Its value as a forage plant, in deep soils, can hardly be over-rated; and, perhaps, in this capacity, it may be found a valuable acquisition to Australia, India, and North America.

GENUS V.



STAU'RACA'NTHUS *Link.* THE STAU'RACANTHUS, or LEAFLESS FURZE. *Lin. Syst. Monadélphia Decándria.*

Identification. Link in Schrad. N. Journ., 2. p. 1. and 52.; Don's Mill., 2. p. 148.

Synonymæ. *Ulex* sp. *Brot.*

Derivation. From *stauros*, a cross, and *akantha*, a spine; in allusion to the spines, each of which has two smaller spines proceeding from its sides, which give it the appearance of a cross.

■ 1. *S. APHYLLUS* *Link.* The leafless *Stauracanthus*.

Ulex genistoides *Brot. Fl. Lus.*, ii. p. 78.; and *Ulex mitis* *Hort.* This is the only species of the genus known. It is a leafless shrub, with the habit of *Ulex*, having divaricate branches; and is a native of Spain and Portugal, in sandy pine woods, where it grows to the height of from 2 ft. to 3 ft. It was introduced in 1823, and produces its yellow flowers in May and June. It is readily increased by cuttings planted in sand under a hand-glass, or by seeds. Plants of it were in the garden of the London Horticultural Society in 1835.

GENUS VI.



SPA'RTIUM *Dec.* THE SPARTIUM, or SPANISH BROOM. *Lin. Syst.* *Monadélphia Decándria.*

Identification. Lin. Sp., 995.; Dec. Prod., 2. p. 145.; Don's Mill., 2. p. 148.

Synonymes. *Spartiánthus* *Link Enum.*, 2. p. 223.; *Genista* sp. *Lam.* and *Mench.*

Derivation. From *sparton*, cordage; in allusion to the use of the plant in early ages generally, and in Spain, even to the present day, for making ropes.

■ 1. *S. JUNCEUM* *L.* The Rush-like *Spartium*, or *Spanish Broom*.

Identification. Lin. Sp., 995.; Dec. Prod., 2. p. 145.; Don's Mill., 2. p. 148.

Synonymes. *Genista júncea* *Lam.* and *Du Ham.*; *G. odorata* *Mench.*; *Spartiánthus júnceus* *Mench.*; *Genêt d'Espagne*, *Fr.*; *Binsenartige Pflriemen*, *Ger.*

Engravings. N. Du Ham., 2. t. 22.; Bot. Mag., t. 85.; and our fig. 266

Variety.

■ *S. j.* 2 *flore pleno* has double flowers.

Description, Geography, &c. A shrub, with upright branches, round, of a deep green colour, smooth, and with but few leaves, which are lanceolate, and soon drop off. The flowers are few, disposed in terminal racemes, large, distant, and of a deep yellow. It is a native of Spain, Portugal, Italy, and the south of France, in rocky situations, and upon dry gravelly soils. In its native country, it grows to the height of from 5 ft. to 8 ft.; but it attains to nearly double that height in British gardens, into which it was introduced in 1548.

Properties and Uses. In Italy and the south of France, a very good cloth is manufactured from the fibres of this plant. The shoots are cut over in the



course of the month of August; and, after having been made up into little bundles, are dried in the sun. These are afterwards beaten with a mallet, and then steeped in water for three or four hours; after this they are steeped in a ditch, among water and mud, for eight or nine days, and then taken out and washed, which operation has the effect of separating the parenchyma from the fibres. The bundles are then opened, and thinly spread out to dry, after which they are combed in the manner of flax; and the better part is laid aside for being spun, and woven into sheets, table linen, or shirts; the remaining part being used for sacking, or for stuffing mattresses. In various parts of France, Italy, and Spain, where neither hemp nor flax is grown, owing to the poverty of the soil, *Spártium júnceum* is found an excellent substitute. In Italy, about Mount Cassiano, advantage is taken of a hot spring, by alternately immersing the shoots in it, and drying them in the sun, instead of the more tedious process of immersing them in cold water: when thus treated, the parenchyma is rendered fit for separation, and the fibres for combing, in three or four days. This process is said by Rosier to be also performed with the *Cýtisis scopàrius*; though, according to Desfontaines, this is doubtful. In Languedoc, sheep and goats are fed with the branches of *Spártium júnceum* during winter, not because it is an excellent fodder, but because there is a general deficiency of forage at that season. Both in Spain and France, the shoots are used for forming baskets, and for tying up vines and other fruit trees. The bees are said to be very fond of the flowers; and the seeds are eaten with great avidity by poultry, partridges, &c. Medicinally, the flowers and leaves, in infusion, act as an emetic, or, in a larger quantity, as an aperient. In Britain, the plant is solely regarded as an ornamental shrub, having the appearance of an evergreen, from its smooth dark-green shoots, and fastigate form, even in winter, when without leaves. To produce a harmonious effect, some judgment is required in the quantity of plants of this species which ought to be grouped together. Three or four plants of *Spártium júnceum*, placed among three or four plants of any broad-leaved shrub, from the equal balance of opposite forms and characters, will not form a harmonious whole; while one plant of *Spártium*, in a group of six or eight broad-leaved plants (and more if the *Spártium* be not large), will be effective, by the contrast which it exhibits to the others; in the same manner as a single Lombardy poplar sometimes produces a good effect in a mass of round-headed trees. In planting *Spártium júnceum* along with *Cýtisis scopàrius* and other plants of the same general character and habit, less attention in regard to proportion is requisite, as the assimilation is more natural. In shrubberies, where the *Spártium júnceum* is planted here and there at random, though the plants form a beautiful objects, considered separately, yet they often destroy the unity of expression of the scenery.

Propagation and Culture. Seeds are produced in abundance, and they will come up in any soil that is tolerably dry. In the nursery, they ought to be transplanted every year, as they are apt to form long taproots and very few fibres. Where the plants are wanted as shelter for game, or to be grown as a substitute for flax or hemp, they may be treated in the same manner as the seeds of *Ulex europæa*. (See p. 574.)

Commercial Statistics. Price of plants, in the London nurseries, seedlings 5s. per 100; transplanted plants, 12s. per 100; the double-flowered variety, 1s. 6d. each: at Bollwyller, 50 cents.

GENUS VII.



GENISTA Lam. THE GENISTA. *Lin. Syst. Monadélphia Decándria.*

Identification. Lam. Dict., 2. p. 616.; III., t. 619.; Dec. Prod., 2. p. 145.; Don's Mill., 2. p. 148.
Synonyms. Genista, et Spártium, spec. *Lin.*; Genét, *Fr.*; Ginster, *Ger.*

Description, &c. The hardy species are deciduous or sub-evergreen shrubs, generally with trifoliolate leaves and yellow flowers; there is a great sameness of character among them; and, though many are quite distinct, yet it is highly probable that the greater number now recorded as species are only varieties. They are chiefly natives of Europe; but a few are found in the north of Africa, and they are all hardy or half-hardy. A number of the species were formerly included under the genus *Spártium*, and some under *Cýtisis*, from which they have been separated by Lamarek, whose arrangement as modified by De Candolle, we have adopted in the following enumeration.

❖ 1. *G. PARVIFLO'RA* Dec. The small-flowered Genista.

Identification. Dec. Prod., 2. p. 145.; Don's Mill., 2. p. 148.

Synonymic. *Spártium parviflorum* Vent. Hort. Cels., t. 87.

Engraving. Vent. Hort. Cels., t. 87.

Spec. Char., &c. Leaf trifoliolate, its petiole very short; its leaflets usually deciduous, very narrow, glabrous. Flowers in lengthened terminal racemes. Legumes compressed, 1-3-seeded, rather pubescent, being covered with minute closely pressed down, slightly spreading. (Dec. Prod., ii. p. 145.) A deciduous shrub, a native of the Levant, near the Gulf of Mundania, producing its yellow flowers from May to August. It was introduced in 1817; and, in British gardens, grows to the height of 6 ft. or 7 ft.

❖ 2. *G. CLAVA'TA* Poir. The club-shaped-calyxed Genista.

Identification. Poir. Supp., 2. p. 717.; Dec. Prod., 2. p. 145.; Don's Mill., 2. p. 149.

Synonymic. *Spártium sericeum* Vent. Hort. Cels., t. 17., but not of Ait.

Engraving. Vent. Hort. Cels., t. 17.

Spec. Char., &c. Leaf trifoliolate. Leaflets linear-sublanccolate, silky beneath. Flowers in terminal heads. Legume compressed, so as to be flat, tapered at the base, containing 1-2 seeds. (Dec. Prod., ii. p. 145.) A deciduous shrub, from 2 ft. to 4 ft. high, a native of Mogador, in Spain; introduced in 1812. Its flowers, which are produced from May to August, are yellow, and rather larger than those of the preceding species. De Candolle thinks it is perhaps a species of *Cýtisis*.

❖ 3. *G. CA'NDICANS* L. The whitish-surfaced Genista.

Identification. Lin. Amœn.; Dec. Prod., 2. p. 145.; Don's Mill., 2. p. 149.

Synonymic. *Cýtisis candicans* Lin. Sp.; *C. pubescens* Mench.

Engravings. Dend. Brit., t. 80.; and our fig. 267.

Spec. Char., &c. Leaf trifoliolate, petiolate; leaflets ovate, pubescent, with appressed down. Branches angled. Flowers in terminal heads, few in a head. Legume hairy. (Dec. Prod., ii. p. 145.) It is allied to *G. canariensis*, but has larger leaves, and scentless flowers. (Dec.) A sub-evergreen shrub, a native of Mogador, Italy, and the Levant. Introduced in 1735, and producing its large scentless flowers from April to July. In British gardens, it grows to the height of 4 ft. or 5 ft.; and the great advantage of this species is, that it grows rapidly, and flowers freely. In a newly formed garden or shrubbery, where it is desirable to produce a considerable effect the first summer, there are few shrubs better adapted for this purpose than the different species of *Genista*; provided the plants are done justice to, in all that relates to culture.

❖ 4. *G. TRI'QUETRA* Ait. The triangular-stemmed Genista.

Identification. Ait. Hort. Kew., 3. p. 14.; Dec. Prod., 2. p. 146.; Don's Mill., 2. p. 149.

Synonymic. *G. triquetra* Lam.?

Engravings. Curt. Bot. Mag., t. 314.; and our fig. 268.

Spec. Char., &c. Branches 3-sided, decumbent, the younger ones villose. Leaves trifoliolate, simple about the extremities of the branches; leaflets ovate-lanceolate, villose. Flowers in short terminal racemes. (Dec. Prod., ii. p. 146.) A trailing shrub, which, in winter, has the appearance of being evergreen from its somewhat winged and triangular green shoots. It is a native of Spain, Italy, and France; it was introduced in 1748, and, in British gardens, produces a vast profusion of flowers from April to July. No shrub is more ornamental on rockwork; and when trained to a stake, and allowed to form a head, or grafted standard high



267



268

on a laburnum, it forms a singular object, and, when in flower, a most magnificent one. It is also an admirable plant for training against a wall, particularly in dry situations, where it is exposed to the sun. Where it is desired to train a plant in the form of a man, an animal, or of any artificial object, by planting *Genista triquetra* in a favourable soil and situation, and placing over it a wire frame of the exact form of the object to be produced in green, the shoots might be trained to the frame; and in summer, when the plant was in flower, the form would appear as if covered with gold; while in winter, from the greenness of the shoots, it would be completely green.

§ 5. *G. BRACTEOLATA* Lk. The bracteolated Genista.

Identification. Lk. Enum., 2. p. 224; Dec. Prod., 2. p. 146; Don's Mill., 2. p. 149.

Spec. Char., &c. Branches striated, pubescent. Leaves pubescent, trifoliolate; the leaflets obovate. Flowers in short terminal racemes. Calyx hairy. (*Dec. Prod.*, ii. p. 146.) A deciduous shrub, growing to the height of from 2 ft. to 4 ft., and flowering from March to May. It was introduced in 1823, but from what country is unknown. De Candolle knows so little about it, that he expresses a doubt, in his *Prodromus*, as to whether he has given it its right place in the series of species.

§ 6. *G. UMBELLATA* Poir. The umbellate-flowered Genista.

Identification. Poir. Suppl., 2. p. 715; Dec. Prod., 2. p. 146; Don's Mill., 2. p. 149.

Synonyme. *Spartium umbellatum* Desf. Atl., 2. p. 153, *L'Hérit. Stirp.*, 183.

Spec. Char., &c. Leaf trifoliolate, its petiole short, its leaflets linear-lanceolate, and rather silky. Flowers in terminal heads. Calyx hairy, in a silky manner. Corolla and legume silky. Branches glabrous. (*Dec. Prod.*, ii. p. 146.) Found in Barbary, on arid hills, and introduced in 1799. It grows to the height of from 1 ft. to 2 ft., and flowers from April to June.

Variety.

§ *G. u. capitata* Dec. has the branches and leaves clothed with silky hairs. It is a native of Mogador, and is synonymous with the *Spartium capitatum* Cav. *Annal.* 1801, p. 62.

§ 7. *G. LUSITANICA* L. The Portugal Genista.

Identification. Lin. Sp., 999, exclusive of the synonymes of Chus. and J. Bauh.; Lam. Dict., 2. p. 662, exclusive of the synonymes; Dec. Prod., 2. p. 146; Don's Mill., 2. p. 150.

Engraving. Andr. Bot. Rep. t. 419.

Spec. Char., &c. Branches spiny, round, becoming striate. Leaves trifoliolate, opposite, upon short petioles; the leaflets linear, folded, somewhat silky. Flowers few, terminal. Calyx very hairy. (*Dec. Prod.*, ii. p. 146.) A native of Portugal, where it grows 4 ft. high. Introduced in 1771, and flowering from March to May. It forms a very spiny shrub, remarkable for having opposite leaves and branches; a character not common among Leguminaceæ.

§ 8. *G. (L.) RADIIATA* Scop. The rayed-branched Genista.

Identification. Scop. Carn., No. 871; Dec. Prod., 2. p. 146; Don's Mill., 2. p. 149.

Synonymes. *Spartium radiatum* Lin. Sp., 996, Mill. Icon., t. 249. f. 1., Sims Bot. Mag., 2260; *G. ilvænsis* Dulac.

Engravings. Mill. Icon., t. 249. f. 1.; Bot. Mag., t. 2260; and our fig. 269.

Spec. Char., &c. Branches angled, grouped, glabrous. Leaf trifoliolate, almost sessile, opposite, the leaflets somewhat silky. Flowers in terminal heads, 2—4 in a head. Corolla and legume silky. The old branches show a tendency to become spiny. The legumes are oval, short, compressed, pointed with the style, and include two seeds. (*Dec. Prod.*, ii. p. 146.) A native of Italy, Carniola and the Vallais; introduced in 1758, and flowering in June and July. It bears a close resemblance to *G. lusitânica*, differing from it principally in being without spines, and having its leaves somewhat longer. Both this species or variety, and *G. lusitânica*, have a very singular appearance when without their leaves; and, in that point of view, they may be considered as almost as interesting in winter as they are in summer. Shrubs of this kind of interest are most desirable for introducing among evergreens, more especially if they are at the same time free flowerers.



269



☞ 9. *G. EPHEDRÖIDES* Dec. The Ephedra-like Genista.

Identification. Dec. Légum. Mém., 6.; Dec. Prod., 2. p. 147.; Don's Mill., 2. p. 150.
Engravings. Dec. Légum. Mém., 6. t. 36.; Maund's Botanic Garden, t. 498.

Spec. Char., &c. Leaves some trifoliate, some simple, few sessile; leaflets linear, almost glabrous. Branches rigid, round, becoming striated and spiny. Flowers in spikes, alternate, yellow. Calyx somewhat pubescent. (*Dec. Prod.*, ii. p. 147.) A shrub, not exceeding 2 ft. in height, in its native habitat, the coast of Sardinia, but attaining double that height in British gardens. It is glabrous, and resembles in appearance *Ephedra distachya*. There are plants of this species in the Birmingham Botanic Garden.

☞ 10. *G. TRIACANTHOS* Brot. The three-spined Genista.

Identification. Brot. Phyt., 130. t. 54.; Fl. Lusit., 2. p. 89.; Dec. Prod., 2. p. 147.; Don's Mill. 2. p. 150.
Synonyme. *G. rostrata* Poir. *Suppl.*, 2. p. 719.
Engraving. Brot. Phyt., t. 54.

Spec. Char., &c. Leaves sessile, trifoliate and simple, glabrous. Leaflets linear-lanceolate. Branchlets spiny, branched. Flowers in terminal racemes, few in a raceme. Calyx, corolla, and legume glabrous; legume 1-seeded. The spines are simple, trifid, or branched. (*Dec. Prod.*, ii. p. 147.) A native of Portugal, on mountains, and in woods. Introduced in 1821 and flowering from May to July. Height from 2 ft. to 3 ft.

Variety.

☞ *G. t. 2 interrupta* Dec.; *Spartium interruptum* Cav. *Annal.*, 1801, vol. iv. p. 58.; has linear leaflets, and branches usually simple, and shorter than those of the species. It is found wild about Tangier.

☞ 11. *G. HORRIDA* Dec. The horrid Genista.

Identification. Dec. Fl. Fr., 4. p. 500.; Dec. Prod., 2. p. 145.; Don's Mill., 2. p. 149.
Synonymes. *Spartium horridum* Vahl *Symb.*, 1. p. 51., exclusive of the synonyme; *G. erinacea* Gilib. *Bot. Prat.*, 2. p. 239.
Engraving. Gilib. *Bot. Prat.*, 2. p. 239. icon.

Spec. Char., &c. Branches grouped, angled, spiny, opposite. Leaves trifoliate, opposite; the leaflets linear, folded, somewhat silky. Flowers few, almost terminal. Calyx pubescent. (*Dec. Prod.*, ii. p. 146.) A native of the Pyrenees, introduced in 1821, growing to the height of 4 ft., and flowering from May to July.

☞ 12. *G. SYLVESTRIS* Scop. The wood Genista.

Identification. Scop. Carn., No. 875.; Dec. Prod., 2. p. 148.; Don's Mill., 2. p. 151.
Synonyme. *G. hispánica* Jacq. *Icon. Rar.*, t. 557.
Engraving. Jacq. *Icon. Rar.*, t. 557.

Spec. Char., &c. Leaves simple, linear-awl-shaped, glabrous above, villose in a closely pressed manner beneath. Spines axillary, branched, slender. Flowers glabrous, disposed in a terminal spiked raceme. Teeth of the calyx almost spiny. The keel longer than the standard and wings. (*Dec. Prod.*, ii. p. 148.) A native of Carniola and Croatia, on hills. Introduced in 1818; flowering in June and July, and growing to the height of 2 ft.

☞ 13. *G. SCORPIUS* Dec. The Scorpion Genista.

Identification. Dec. Fl. Fr., 4. p. 498.; Dec. Prod., 2. p. 148.; Don's Mill., 2. p. 151.
Synonymes. *Spartium Scorpius* Lin. *Sp.*, 995.; *G. spiniflora* Lam. *Dict.*, 2. p. 621.; Scorpion Furze *Gerard.*
Engraving. Clus. *Hist.*, 1. p. 106.

Spec. Char., &c. Spiny; spines branched, spreading, striated, glabrous. Leaves simple, very few, oblong, somewhat silky. Flowers glabrous, upon short pedicels, in groups disposed somewhat racemosely; the keel as long as the standard. Legume containing 2—4 seeds. (*Dec. Prod.*, ii. p. 148.) A native of the south of Europe and in Barbary, in arid places, producing its yellow flowers from March to April. It was cultivated by Parkinson in 1640, and forms a spiny shrub, almost leafless, when the shoots are full grown. This species is commonly thought to be the *Scorpius* of Theophrastus. Parkinson says it is so covered by thorns as to be quite inaccessible; from which it would appear to be a desirable plant for low hedges in suitable situations. In British gardens, it is occasionally met with as a curious shrub, and in conservatories in old collections.

✚ 14. *G. HISPA'NICA* L. The Spanish Genista.

Identification. Lin. Sp., 999; Dec. Prod., 2. p. 148.; Don's Mill., 2. p. 151.

Synonymy. Spanish Furze *Hort.*

Engravings. Cav. Icon., 3. t. 211.; Lam. Ill., t. 619. f. 3.

Spec. Char., &c. Spiny, except in the flower-bearing branches; spines branched, rigid. Leaves simple, lanceolate, villose. Flowers in a terminal subcapitate raceme. Keel villose, the length of the glabrous standard. Legume oval, including 2—4 seeds; when ripe, rather glabrous. (*Dec. Prod.*, ii. p. 148.) An undershrub, from 6 in. to 1 ft. in height, a native of Spain and the south of France, and cultivated in British gardens since 1759. Its flowers are produced in June and July. Probably this species, *G. lusitánica*, and *G. hórrida* may be all varieties of the same species; at least, they do not appear more distinct than *Ulex europæ'a*, *nána*, *provincialis*, and *stricta*.

✚ 15. *G. A'NGLICA* L. The English Genista, or Petty Whin.

Identification. Lin. Sp., 999; Dec. Prod., 2. p. 149.; Don's Mill., 2. p. 151.

Synonymy. *G. minor* Lam. *Ft. Fr.*, 2. p. 615.

Engravings. Engl. Bot., t. 132.; Lobel Icon., 2. p. 93. f. 2.; and our fig. 270.

Spec. Char., &c. Spiny, except in the flower-bearing branches; spines simple; the whole plant glabrous. Leaves simple, ovate-lanceolate. Flowers in terminal racemes, few in a raceme; the keel longer than the standard and wings. Legume ovately cylindrical, including many seeds. (*Dec. Prod.*, ii. p. 149.) A prostrate deciduous shrub, with woody stems, seldom exceeding 1 ft. in height; native of the middle and north of Europe, and frequent in Britain, on moist, boggy, heathy commons. It is sometimes cultivated in collections, where it forms a spiny bush about 2 ft. in height, flowering profusely in May and June.



✚ 16. *G. GERMA'NICA* L. The German Genista.

Identification. Lin. Sp., 995.; Dec. Prod., 2. p. 149.; Don's Mill., 2. p. 151.

Synonymy. *Scorpius spinosus* *Manch. Meth.*, 134.; *Vóglera spinosa* *Fl. Wett.*, 2. p. 500.

Engravings. Fuchs Hist., 220. icon.; Hayne Abbild., t. 122.; and our fig. 271.

Spec. Char., &c. Spiny, except in the flower-bearing branches; spines simple or branched. Leaves simple, lanceolate, slightly hairy. Flowers somewhat villose, in terminal racemes. Keel longer than the standard and wings. Legume ovate, slightly hairy, including 2—4 seeds. (*Dec. Prod.*, ii. p. 149.) A spiny shrub, a native of Europe, in woods and on heaths, introduced in 1773. It grows to the height of 2 ft. or 3 ft. in British gardens, and flowers in June, July, and August.



Variety.

✚ *G. g. 2 inérnis* Dec. is almost without spines.

✚ 17. *G. PU'RGANS* L. The purging Genista.

Identification. Lin. Sp., 999; Bull. Herb., 115.; Dec. Prod., 2. p. 149.; Don's Mill., 2. p. 151.

Synonymy. *Spartium purgans* *Lin. Syst.*, 474.

Spec. Char., &c. Upright, much branched. Branches round, striate. Leaves simple, very few, lanceolate, almost sessile, somewhat silky. Flowers axillary, solitary, scarcely pedicled. Petals equal, glabrous. The young legume adressedly pubescent. (*Dec. Prod.*, ii. p. 149.) A native of France, on hills, where it grows to the height of from 3 ft. to 6 ft., flowering in June and July introduced in 1768.

✚ 18. *G. SERI'CEA* Wulf. The silky Genista.

Identification. Wulf. in Jacq. Coll., 2. p. 167.; Dec. Prod., 2. p. 149.; Dou's Mill., 2. p. 151.

Engraving. Jacq. Icon. Rar., 3. t. 556.

Spec. Char., &c. Decumbent, with upright round branches. Leaves simple, linear-lanceolate, silky beneath. Flowers terminal, 3 or 4 together, in a sort of raceme. Petals silky, nearly equal. Lobes of the calyx oblong-acuminate; the floral leaves equalling the calyx in length. (*Dec. Prod.*, ii. p. 149.) A decumbent shrub, not exceeding 6 in. in height; a native of Austria and Croatia, in subalpine places near the shore; introduced in 1812, and flowering in May and June.

✻ 19. *G. HUMIFUSA* L. The trailing Genista.

Identification. Lin. Sp., 998; Vill. Dauph., 3. p. 421. t. 44; Dec. Prod., 2. p. 149; Don's Mill, 2. p. 152.
Engraving. Vill. Dauph., 3. p. 421. t. 44.

Spec. Char., &c. Procumbent, the branches crooked, bearing tubercles, pilosely hairy, so rigid at the tip as to seem spiny. Leaves simple, linear-lanceolate, pilosely hairy. Flowers axillary, solitary, almost sessile. Petals silky, almost equal. Lobes of the calyx ovate, subacute. (*Dec. Prod.*, ii. p. 149.) A trailing shrub, from the Levant, in 1819, flowering in May and June.

✻ 20. *G. APHYLLA* Dec. The leafless Genista.

Identification. Dec. Prod., 2. p. 149; Don's Mill, 2. p. 152.
Synonymes. *Spartium aphyllum* Lin. *Fl. Suppl.*, 320; *G. virgata* Lam. *Diet.*, 2. p. 616.
Engraving. Pall. *Itin.* Ed. Gall. *Append.*, No. 357. t. 99. f. 2.

Spec. Char., &c. Branched, upright. Leaves simple, very few, linear, very short. Flowers disposed distantly in lengthened terminal racemes. Legumes compressed, including 2 seeds; when young tomentose; when adult, glabrous. (*Dec. Prod.*, ii. p. 150.) Found in Siberia, in deserts, about the Volga; and introduced in 1800. It grows to the height of 3 ft. or 4 ft. in British gardens; and is one of the few species of *Genista* which have flowers of any other colour than yellow, those of this species being violaceous, and produced in June and July.

✻ 21. *G. MONOSPERMA* Lam. The one-seeded Genista.

Identification. Lam. *Diet.*, 2. p. 616; Dec. Prod., 2. p. 150; Don's Mill, 2. p. 152.
Synonymes. *Spartium monospermum* Lin. *Sp.*, 995; *Curt. Bot. Mag.*, t. 683; *G. Reclam* Forsk.
Engravings. *Curt. Bot. Mag.*, t. 683; and our *fig.* 272.

Spec. Char., &c. Branched, upright. Leaves simple, very few, linear-oblong, adpressedly pubescent. Flowers in lateral racemes, few in a raceme. Petals silky, almost equal. Legumes ovate, inflated, membranaceous, glabrous, including 1—2 seeds. (*Dec. Prod.*, ii. p. 150.) An erect shrub, with numerous slender, twiggy, flexile branches, and white flowers. It is a native of the coast on both sides of the Mediterranean Sea, where, in many places, it serves to retain and consolidate the drifting sand. The leaves and young branches are, in these countries eaten by sheep and goats; and the twigs are used for tying vines to stakes, or tying up faggots; and they are also twisted into ropes. In British gardens, the plant is highly ornamental. There is a fine plant of it in the Hammersmith Nursery.



✻ 22. *G. SPHEROCARPA* Lam. The round-fruited Genista.

Identification. Lam. *Diet.*, 2. p. 616; Dec. Prod., 2. p. 150; Don's Mill, 2. p. 152.
Synonyme. *Spartium sphaerocarpon* Lin. *Mant.*, 571.
Engraving. Clus. *Hist.*, 1. p. 102. f. 2.

Spec. Char., &c. Twiggy, branched. Leaves simple, few, linear, almost glabrous. Flowers in lateral racemes, many in a raceme. Petals glabrous, equal. Legumes ovate, in some measure fleshy, containing 1—2 seeds. Flowers small, and pale yellow. (*Dec. Prod.*, ii. p. 150.) A twiggy shrub, a native of the south of Europe and north of Africa, introduced in 1731. It grows to the height of 3 ft. or 4 ft., and produces its small yellow flowers in June and July.

✻ 23. *G. ÆTHIENSIS* Dec. The Mount Etna Genista.

Identification. Dec. Prod., 2. p. 150; Don's Mill, 2. p. 152.
Synonymes. *Spartium æthiense* Biv. *St. Sic. Mant.*, 2., *Rafin. Specch.*, 1. p. 17; *Sims Bot. Mag.*, 2674; *Spartium trisperrum* Smith in *Rees's Cycl.*, vol. 32. No. 5.
Engravings. *Bot. Mag.*, t. 2674; and our *fig.* 273.

Spec. Char., &c. Upright, very much branched. Leaves simple, few, linear, silky. Flowers in terminal racemes. Petals almost glabrous, nearly equal in length. Legumes obliquely ovate, compressed, containing 2—3 seeds; when young, pubescent. (*Dec. Prod.*, ii. p. 150.) An erect twiggy shrub, a native of the wooded region of Mount Etna, and resembling the preceding species, except that the flowers are twice the size. It was introduced in 1816, grows to the height of from 2 ft. to 4 ft., and produces its yellow flowers in June and July.



✱ 24. *G. SCARIO'SA* Viv. The scarious-margined-leaved Genista.

Identification. Viv. Ann. Bot., 1. p. 2. 175.; Fragm. Fl. Ital., 1. p. 5. t. 8.; Dec. Prod., 2. p. 150.; Don's Mill., 2. p. 152.

Synonymes. *G. januensis* Viv. Cat., p. 10., Bert. Pl.; *G. genuensis* Pers. Ench., No 5.

Engraving. Frag. Fl. Ital., 1. t. 8.

Spec. Char., &c. The whole plant perfectly glabrous. Stem ascending. Younger branches 3-sided. Leaves simple, lanceolate, or the lowest obovate, dry and shriveled in the margin. Flowers in racemes. Corolla twice the length of the calyx. Legume linear, including 4—7 seeds, some of the intervals between them constricted. (*Dec. Prod.*, 2. p. 150.) An upright shrub, a native of Liguria and of the kingdom of Naples. Introduced in 1821 and flowering in June and July.

✱ 25. *G. ANXA'NTICA* Ten. The Anxantie Genista.

Identification. Ten. Fl. Nap. Prod., p. 41.; Fl. Nap., 2. p. 127. t. 66.; Dec. Prod., 2. p. 150.; Don's Mill., 2. p. 152.

Synonymes. *G. amsántica* Tenore.

Engravings. Fl. Nap., 2. p. 127. t. 66.; Swt. Fl.-Gar., 2d ser. t. 266.; and our figs. 274, 275.



Spec. Char., &c. The whole plant is perfectly glabrous. Stems spreading. Branches angled. Leaves simple, ovate-elliptical, rather coriaceous, veiny. Flowers in racemes. Corolla thrice as long as the calyx; and about 8 lines long. Legume containing 8—10 seeds. (*Dec. Prod.*, ii. p. 150.) A diffuse shrub, a native of the kingdom of Naples. Introduced in 1818, and flowering in June



and July. There are plants of this species in the Chelsea and other botanic gardens. It is well adapted for ornamenting rockwork, from its trailing habit, and profusion of yellow flowers.

✱ 26. *G. TINCTO'RIA* L. The Dyer's Broom, or Green Weed.

Identification. Lin. Sp., 998.; Dec. Prod., 2. p. 151.; Don's Mill., 2. p. 152.

Synonymes. Base Broom, Green Weed, Green Wood, Dyer's Weed, and Wood-waxen; Genêt des Teinturiers, Genêt de Sibérie, Fr.; färbender Ginster, Ger.

Engravings. Eng. Bot., t. 44.; and our fig. 276.

Spec. Char., &c. Root creeping. Stems almost upright. Branches round, striated, upright. Leaves simple, lanceolate, rather glabrous. Flowers glabrous, in spiked racemes. Legume glabrous. (*Dec. Prod.*, ii. p. 151.) A creeping-rooted low shrub, common in Europe, in grassy fields, and in woods and copses, particularly in dry gravelly or sandy soils; flowering in July. It is very common in pastures in many places both in England and Scotland; and, when cows feed on it, it is said by Ray to give a bitter taste to their milk. All parts of this plant, and especially the branches, and leaves, have long been used by dyers for producing yellow, especially for dyeing wool that is afterwards to be dyed green with woad (*Isätis tinctoria* L.). We are not aware that the *Genista tinctoria* is in cultivation, as a dyer's plant, either in Britain or on the Continent; but, in Suffolk and Norfolk, and probably other counties, the wild plant is collected in quantities, and sold to dyers. The ashes afford an alkaline salt, which is employed as a diuretic in dropsy and other diseases. In Britain, the principal use of the plant, when in a state of cultivation, is as an ornamental shrub.



Varieties.

✱ *G. t. 2 latifolia* Dec. — Leaves broad-lanceolate. (*Dec. Prod.*) A native of Auvergne, on the Golden Mount. (*Don's Mill.*)

✱ *G. t. 3 hirsuta* Dec. — Leaves somewhat villose. Branches upright. A native of sunny meadows.

- ❖ *G. l. 4 pratensis* Poll. — Leaves oblong-lanceolate, rather hairy. Branches ascending. (*Dec. Prod.*, ii. p. 151.) Inhabits the mountainous parts of Upper Italy.

❖ 27. *G. (T.) SIBIRICA* L. The Siberian Genista.

Identification. Lin. Mant., 571; *Dec. Prod.*, 2. p. 151; Don's Mill., 2. p. 152.

Synonymes. Genistoides elata *March Meth.*, 132; Genista tinctoria var. *N. Du Ham.*

Engraving. Jac. Hort. Vind., t. 190.

Spec. Char., &c. Stems erect; and the whole plant more slender and taller than *G. tinctoria*, of which it is evidently only a variety. It is found wild in Siberia, where it grows to the height of 6 ft., and produces its yellow flowers from June till August. Introduced in 1785. A plant of this kind of Genista, standing close to one of *G. tinctoria*, in the arboretum of the Messrs. Loddiges, resembles the latter so exactly, as to leave no doubt in our mind of their identity.

❖ 28. *G. (T.) TETRAGONA* Besser. The quadrangular-branched Genista.

Identification. Besser. Enum. Cont., 2. p. 73, No. 887; *Dec. Prod.*, 2. p. 150; Don's Mill., 2. p. 152.

Spec. Char., &c. Stem 4-sided, furrowed, decumbent. Branches ascending. Leaves simple, almost opposite, lanceolate, the younger ones somewhat silky. Flowers disposed rather racemously. Calyx somewhat silky; corolla glabrous. (*Dec. Prod.*, ii. p. 150.) Related to *G. tinctoria*. (*Dec.*) A decumbent shrub, native of the south of Podolia. Introduced in 1822, producing its yellow flowers in June and July, and probably only a variety of *G. tinctoria*.

❖ 29. *G. (T.) POLYGALÉFO'LIA* Dec. The Milkwort-leaved Genista.

Identification. *Dec. Prod.*, 2. p. 151; Don's Mill., 2. p. 153.

Synonymes. *G. polygalaphylla Brot. Fl. Lus.*, 2. p. 86; *G. exaltata Link*; *G. tinctoria lusitânica máxima Tourn. Inst.*, 643.

Spec. Char., &c. Stem erect. Branches terete, striated, erect. Leaves lanceolate, rather silky beneath, as well as the calyxes. Racemes somewhat turned to one side, disposed in panicles. Corolla smooth. (*Don's Mill.*, 2. p. 153.) A shrub, growing to the height of 4 ft., in the north of Portugal. Introduced in 1820, and producing its yellow flowers from June to August. In all probability, only a variety of *G. tinctoria*.

❖ 30. *G. (T.) FLO'RIDA* L. The florid Genista.

Identification. Lin. Sp., 998; *Dec. Prod.*, 2. p. 151; Don's Mill., 2. p. 153.

Spec. Char., &c. Stem erect. Branches round and striated. Leaves lanceolate, and, as well as the legumes, clothed with close-pressed silky down. Branches turned to one side. Corolla shining. (*Dec. Prod.*, ii. p. 151.) A shrub, growing to the height of 4 ft., a native of Spain and Naples. Introduced in 1752, and flowering from June to August. Apparently, also, a variety of *G. tinctoria*.

❖ 31. *G. (T.) MA'NTICA* Poll. The Mantuan Genista.

Identification. Poll. Fl. Ver., 2. p. 458; Spreng. Pug., 2. p. 73; Horn. Hort. Hafn. Suppl. p. 151; *Dec. Prod.*, 2. p. 151; Don's Mill., 2. p. 153.

Spec. Char., &c. Stems numerous, prostrate, and striated angularly. Leaves linear-lanceolate, and, like the stems, pubescently hairy. Peduncles axillary, shorter than the leaves. Corolla smooth. Legume clothed with silky hairs. (*Dec. Prod.*, ii. p. 151.) A prostrate shrub, found in woods, and apparently only a variety of *G. tinctoria*. It was introduced in 1816, and flowers from June to August.

❖ 32. *G. OVA'TA* Waldst. The ovate-leaved Genista.

Identification. Waldst. et Kit. Pl. Hung., 1. t. 84; Balb.; Bert.; Tav.; Ten.; *Dec. Prod.*, 2. p. 151; Don's Mill., 2. p. 153.

Synonyme. *G. nervata Kit. in Litt.*

Engraving. Waldst. et Kit. Hung., 1. t. 84.

Spec. Char. &c. Stems numerous, hairy, erectish, somewhat herbaceous, striated, terete. Leaves ovate, or ovate-oblong, and are, as well as the legumes, hairy. Racemes short. Corolla smooth. (*Don's Mill.*, ii. p. 153.) A shrub, growing from 2 ft. to 4 ft. high, in Slavonia and Hungary; and on the hills of Italy, from Piedmont to Naples. It was introduced in 1819, and produces its yellow flowers from June to August.

❖ 33. *G. PA'TULA* Bieb. The spreading Genista.

Identification. Bieb. Fl. Taur., 2. p. 148; *Dec. Prod.*, 2. p. 151; Don's Mill., 2. p. 153.

Spec. Char., &c. The branches are numerous, round, striated, paniced, spreading, and quite smooth. Leaves linear-lanceolate, and acuminate. Flowers and legumes smooth. (*Dec. Prod.*, ii. p. 151.) A shrub, growing to the height of 4 ft., on the hills of Tauria, "nearly allied to *G. tinctoria*; but the flowers are one half smaller." Introduced in 1818, and flowering from June to August.

❖ 34. *G. TRIANGULA'RIS* Willd. The triangular-stemmed Genista.

Identification. Willd. Sp., 3. p. 939; *Dec. Prod.*, 2. p. 151; Don's Mill., 2. p. 153.

Synonymes. *G. triquetra Waldst. et Kit. Hung.*, 2. p. 165. t. 153., but not of Aiton.

Engraving. Waldst. et Kit. Hung., 2. t. 153.

Spec. Char., &c. Branches smooth, 3-angled, and, as well as the stems, ascending. Leaves lanceolate, and mucronate. Flowers axillary. Legume compressed, and mucronate. (*Dec. Prod.*, ii. p. 151.) A shrub, not exceeding 1 ft. in height, a native of Hungary, on calcareous rocks, and closely resembling *G. triquetra*, of which, notwithstanding its simple leaves, it may possibly be only a variety; the change not being greater than what takes place in *Fraxinus excelsior simplicifolia*.

✱ 35. *G. SAGITTA`LIS* L. The arrow-jointed Genista.

Identification. Lin. Sp., 998.; *Dec. Prod.*, 2. p. 151.; *Don's Mill.*, 2. p. 153.

Synonymes. *G. herbacea* Lam. *Fl. Fr.*; *Genistella racemosa* Moench *Meth.*; *Saltzwedelia sagittalis* *Fl. Wett.*, 2. p. 498.

Engravings. Mill. *Icon.*, t. 259. f. 2.; *Jacq. Fl. Aust.*, t. 209.; *Hayne Abbild.*, t. 117.; and our *fig. 277.*

Spec. Char., &c. Stems prostrate. Branches herbaceous, ascending, 2-edged, membranous, somewhat articulated. Leaves ovate-lanceolate. Flowers disposed in an ovate, terminal, leafless spike. Corolla smooth; but the keel is furnished with a villous line on the back. (*Don's Mill.*, ii. p. 153.) A prostrate shrub, a native of Continental Europe, in mountain pastures. Introduced in 1750. It seldom exceeds half a foot in height, and, for practical purposes, may be considered as a herbaceous plant. It flowers in May and June, and is a very distinct, ornamental, and hardy sort; growing and flowering freely.



Variety.

✱ *G. s. 2 minor* *Dec. Prod.*, ii. p. 151.— A small shrub, having the branches clothed with adpressed pubescence at the apex, as well as the leaves (*Don's Mill.*, ii. p. 153.)

✱ 36. *G. DIFFU`SA* Willd. The diffuse Genista.

Identification. Willd. Sp., 3. p. 942.; *Dec. Prod.*, 2. p. 152.; *Don's Mill.*, 2. p. 153.

Synonymes. *G. humifusa* Wulf in *Jacq. Coll.*, 2. p. 169.; *Spartium procumbens* *Jacq. Icon. Rar.*, 3. t. 555. but not of Aiton.

Engraving. *Jacq. Icon. Rar.*, t. 555.

Spec. Char., &c. Branches procumbent from the neck, triquetrous. Leaves lanceolate, and smooth, a little ciliated. Peduncles axillary, erect, and disposed in interrupted fascicles. Corollas and legumes glabrous. (*Dec. Prod.*, ii. p. 152.) A procumbent shrub, a native of Italy and Styria, in exposed places, where it flowers in May and June. It was introduced in 1815, and is probably a variety of the preceding species.

✱ 37. *G. PROSTRA`TA* Lam. The prostrate Genista.

Identification. Lam. *Dict.*, 2. p. 618.; *Dec. Prod.*, 2. p. 152.; *Don's Mill.*, 2. p. 153.

Synonymes. *G. pedunculata* L'Hér. *Stirp.*, 184.; *G. decumbens* *Dur. Bourg.*, 1. p. 299.; *G. Halleri* *Reyn. Mem.*, 1. p. 211. *icon.*

Engravings. *Lodd. Bot. Cab.*, 718.; *Reyn. Mem.*, 1. p. 211. *icon.*; and our *fig. 278.*

Spec. Char., &c. Stems diffuse, prostrate. Branches angular, striated, rather hairy. Leaves ovate-oblong, somewhat hairy beneath. Flowers axillary, on long erect pedicels. Corolla glabrous. Legumes hairy, 3—4-seeded. (*Dec. Prod.*, ii. p. 152.) A prostrate shrub, a native of Burgundy, and the Alps of Jura. Introduced in 1775, and not unfrequent in gardens and nurseries. It flowers in May and June.



✱ 38. *G. PROCUMBENS* Waldst et Kit. The procumbent Genista.

Identification. Waldst. et Kit. in Willd. Sp., 3. p. 940.; *Dec. Prod.*, 2. p. 152.; *Don's Mill.*, 2. p. 153.

Spec. Char. &c. Branches procumbent, round, striated, rather downy. Leaves lanceolate, acute, and, as well as the calyxes, downy beneath. Flowers pedicellate, axillary, in threes. Corolla glabrous. (*Dec. Prod.*, ii. p. 152.) A procumbent shrub, a native of Hungary and Moravia; introduced in 1816, and flowering from June to August. Most likely only a variety of the preceding species. Frequent in collections.

* 39. *G. PILO'SA* Lin. The hairy Genista.

Identification. Lin. Sp., 999; Smith's Eng. Fl. 3. p. 263; Hayne Abbild. der deut. Holz., p. 161; Dec. Prod., 2. p. 152; Don's Mill., 2. p. 153.
Synonymes. *G. repens* Lam. Fl. Fr.; *Genistoides tuberculata* Moench Meth.
Engravings. Jacq. Fl. Austr., t. 208; Clus. Hist., 1. p. 103. f. 2; Hayne Abbild., t. 120; and our fig. 279.

Spec. Char., &c. Stems procumbent, striated, branched, tuberculated. Leaves obovate-lanceolate, obtuse, folded, and having beneath a close-pressed silky down. Flowers axillary, on short pedicels. Calyx and pedicels silky. Legumes pubescent, and 3—4-seeded. (*Dec. Prod.*, ii. p. 152.) A procumbent shrub, a native of the south of France, Switzerland, Germany, &c., and of Britain, on dry elevated downs or heaths, in Suffolk, Cornwall, and in North Wales; flowering in May and June. The specific name, pilosa, is certainly not very appropriate; for there are other species, such as *G. cándicans*, which are much more hairy.

* 40. *G. PILOCA'RPA* Link. The hairy-fruited Genista.

Identification. Link. Enum., 2. p. 223; Dec. Prod. 2. p. 152; Don's Mill., 2. p. 154.

Spec. Char. &c. An erect shrub, with angular downy branches, and lanceolate leaves, clothed beneath with silky pubescence. Flowers racemose, on short pedicels. Legume hairy. (*Dec. Prod.*, ii. p. 152.) A shrub, growing to the height of 2 ft. or 3 ft. Introduced in 1823, but from what country is uncertain. It flowers in June and July.

App. i. *Hardy Species of Genista not yet introduced.*

The following abridged descriptions are almost all taken from De Candolle's *Prodromus* and Don's *Miller*. We have given them here, in order to direct the attention of patriotic travellers to the subject; because the seeds of many of the sorts might, doubtless, be obtained from the directors of botanic gardens, in the places where they are indigenous; and seeds of all the species will retain their vital powers for two years or more.

G. mollis Dec.; *Spártium mollé* Cav. Ann., 1801. p. 57. Leaves on short petioles, trifoliolate, and as well as the calyxes, branches, and legumes, clothed with soft villi. Flowers axillary, crowded, Native of Mogador. (*Dec. Prod.*, ii. p. 145.)

G. pátens Dec.; *Spártium pátens* Cav. Icon., 2. p. 58. t. 176., exclusive of the synonyme. Branches striated, twiggly, glabrous. Leaves stalked, trifoliolate; leaflets obovate, pubescent beneath. Flowers in fours, pedicellate, nearly terminal. Legume glabrous, 3—6-seeded. Native of Spain, on mountains near Albayda. It differs from *Cytisus pátens*, in the upper lip of the calyx being acutely bipartite, lower lip of 3 bristles, not with the lips nearly equal and entire. Flowers from April to July. Shrub, 4 ft. to 8 ft. (*Dec. Prod.*, ii. p. 145., and *Don's Mill.*, ii. p. 149.)

G. sessilifolia Dec. Lég. Mém., 6. Leaflets 3, rising from the same point on the branches, linear-subulate, silky, sometimes solitary. Spike terminal, elongated, loose-flowered. Corolla silky. Legume ovate, acuminate, pubescent, 1—2-seeded. A shrub, from 1 ft. to 2 ft. in height, a native of Galicia, on hills. The flowers closely resemble those of *G. pilosa*; but the standard is shorter than the keel. (*Dec. Prod.*, ii. p. 146.)

G. casparrina Guss. ex Schlecht. Linnæa., 4. p. 38., under *Spártium*. A beautiful shrub, with slender branches, the lower leaves ternate, and the upper ones simple. Like *G. radiata*. (*Don's Mill.*, 2. p. 149.)

G. acanthobelada Dec. Lég. Mém. 6., D'Urv. Enum. Leaves nearly sessile, and trifoliolate; leaflets linear, complicated, and rather silky. Branches round, stiff, terete, and spiny, becoming at length striated. Flowers almost opposite, disposed along the branches in a kind of interrupted spike. Calyx pubescent. It is found wild in exposed places in the Levant, in the Island of Melos, where it forms a shrub from 2 ft. to 3 ft. high. (*Dec. Prod.*, ii. p. 147.)

G. Lobelii Dec. Fl. Fr., 4. p. 499., *Lob. Adv.*, p. 409., *Chab. Sciag.*, p. 86. f. 1.; *Spártium erinacoides* Lois. Fl. Gall., p. 441. Leaves few, and the lower ones sessile, and trifoliolate; the rest sessile, scattered, linear-oblong, and rather silky. Branches crowded, spiny, striated, and rather tuberculated. Flowers few, solitary, pedicellate, disposed along the branches in a kind of raceme. Calyx pubescent. A shrub, from 1 ft. to 2 ft. high, found in arid places in Corsica and Provence. (*Dec. Prod.*, ii. p. 147.)

G. parvifolia G. Don; *G. microphýlla* Moris. Elench., p. 13. Hairy. Leaves alternate, trifoliolate, upper ones simple; leaflets oblong-linear, acute, complicated, smooth above; lower ones obovate. Branches crowded, spiny, alternate; younger ones furrowed. Flowers racemose. Native of Sardinia. Legume 4—5-seeded, linear, villous. Shrub, 1 ft. to 2 ft. high. (*Don's Mill.*, 2. p. 150.)

G. Satsmannii Dec. Lég. Mém., 6.; *G. umbellata* Satszm. Leaves sessile, trifoliolate, or simple, ob-

long, obtuse, clothed with closely pressed down. Branches becoming at length striated, lax, spiny. Flowers somewhat racemose along the branches, twin, pedicellate, clothed with silky pubescence; the 3 lower lobes of the calyx about equal in length to the upper ones, but narrower. A shrub, growing to the height of from 2 ft. to 3 ft., on rocks near Corte, in Corsica. (*Dec. Prod.*, 2, p. 147.)

G. aspalathoides Lam. Diet., 2, p. 630; *Spärtium aspalathoides* Desf. *Atl.*, 2, p. 136. Leaves few; the lower ones sessile, and trifoliolate, the rest nearly all simple, scattered, linear-oblong, and rather silky. Branches loose, round spiny, somewhat recurved, and at length becoming striated. Flowers in pairs, subracemose along the branches, pedicellate, clothed with closely pressed silky pubescence. Calyx trifid, the 3 lower of the 5 lobes being connate into a 3-toothed lip. A shrub, from 2 ft. to 3 ft., found on rocks near Bonne, in Barbary. (*Dec. Prod.*, ii, p. 147.)

G. ferax Poir. Suppl., 2, p. 708; *Spärtium heterophyllum* L'Herit. *Stirp.*, 183; *Spärtium ferax* Desf. *Atl.*, 2, p. 136, t. 182. Leaves trifoliolate, or for the most part simple, oblong, and smoothish. Branches striated, and spinescent at the apex. Flowers racemose. Calyx rather pubescent. Corolla smooth. A shrub, from 3 ft. to 4 ft. high, found on mountains near Lacalle, in Barbary. (*Dec. Prod.*, ii, p. 147.)

G. Cupani Guss. *Cat.*, 1821, p. 77; *Aëcia triphylla* Cup. *Pamph. Sic.*, ed. 1, vol. 2, t. 233. Leaves sessile, trifoliolate, and hairy; leaflets linear-lanceolate. Branches spiny. Racemes terminal and few-flowered. Calyx rather pilose. Corolla smooth. Legume 1-seeded, and rather hairy. A shrub, from 2 ft. to 3 ft. high, found on arid mountains, more especially on the Nebrodes, in Sicily. (*Dec. Prod.*, ii, p. 147.)

G. infesta G. Don; *Spärtium infestum* Gussone *Pl. Rar.*, p. 290. Branches striated, and spiny. Leaves ternate; leaflets obovate, and silky beneath. Legumes compressed, and, as well as the bracteas, covered with a close, soft, silky down. Found in bushy places by the sea side, in Calabria, and growing to the height of 2 ft. or 3 ft. Flowers in May. (*Don's Mill.*, ii, p. 130, adapted.)

G. hirsuta Vahl *Symb.*, 1, p. 51. Leaves lanceolate, and, as well as the branches, hairy. Spines trifid, and striated. Spikes terminal and hairy. Corolla hairy, having the keel twice the length of the standard. Legume pubescent, and 1-seeded. A shrub, native of Spain and Portugal.

G. h. 2 cuspidata Dec. *Prod.*, 2, p. 148; *Spärtium cuspidatum* Cav. *Anal.*, 1801, p. 56; has the spines much elongated. It is a native of the north of Africa.

G. h. 3 orientalis Dec. *Prod.*, 2, p. 148., is a native of the Levant. It has the spines hardly longer than the leaves, and trifid or simple. (*Dec. Prod.*, ii, p. 148.)

G. algarbiensis Brot. *Fl. Lus.*, 2, p. 89; *G. hirsuta* var. $\delta\delta$ *algarbiensis* Dec. *Prod.*, 2, p. 148. Leaves lanceolate. Spines simple, solitary. Flowers terminal, subcapitate. Bracteas hairy. Calyx and corolla yellow. A native of Algarva, in Portugal; and a shrub, from 2 ft. to 4 ft. high. It is considered as a variety by De Candolle, and as a species by G. Don. (*Dec. Prod.*, ii, p. 148, and *Don's Mill.*, ii, p. 150.)

G. tricuspidata Desf. *Atl.*, 2, p. 138, t. 183; *Spärtium tricuspidatum* Cav. *Ann.* Leaves lanceolate, and, as well as the branches, sometimes hairy, but not always 4-sided. Spines somewhat stiff, for the most part trifid. Racemes spike-formed, terminal. Calyx rather hairy. Corolla glabrous. Keel twice the length of the standard and wings. A shrub, from 1 ft. to 3 ft. high, found on hills near Algiers. (*Dec. Prod.*, ii, p. 148.)

G. gibraltaria Dec. *Prod.*, 2, p. 148. Leaves linear-lanceolate, and, as well as the branches, calyxes, and corollas, glabrous. Branches flexible and decumbent. Spines trifid and simple, usually leafy. Racemes terminal, somewhat spicate. Keel longer than the standard and wings. A native of the rocks of Gibraltar, near St. Roque. (*Dec. Prod.*, ii, p. 148.)

G. jalcala Brot. *Phyt.*, 133, t. 55, *Fl. Lus.*, 2, p. 89. Leaves ovate-lanceolate; the upper ones, and those of the stem, roundish, having the margins, middle nerve, and branchlets rather hairy. Spines stiff, and for the most part trifid. Racemes few-flowered. Keel longer than the standard and wings. Flowers glabrous. Legumes sickle-shaped, and many-seeded. A shrub from 2 ft. to 3 ft. high, found in Beira and Estremadura, in Portugal. (*Dec. Prod.*, ii, p. 148.)

G. corsica Dec. *Fl. Fr. Suppl.*, p. 548; *Spärtium corsicum* Lois. *Fl. Gall.*, p. 440. The whole shrub is smooth. Leaves linear lanceolate. Stipules rather spiny. Spines simple and rigid. Flowers axillary, solitary, pedicellate. Keel length of the standard. Legume 4-8-seeded, quite smooth. A shrub, about 2 ft. high, found about Bastia, Bonifacio, &c., in Corsica.

There is a variety (*G. c. 2 pubescens* Dec. *Prod.*, 2, p. 148.) which has the branches and young leaves clothed with closely pressed down. (*Dec. Prod.*, ii, p. 148.)

G. ramosissima Poir. *Suppl.*, 2, p. 715; *Spärtium ramosissimum* Desf. *Fl. Atl.*, 2, p. 132, t. 178. Much branched, erect. Branches striated, tuberculated. Leaves few, lanceolate, villous. Flowers nearly sessile along the branches, crowded. Petals silky, about equal in length. Native of Mount Atlas, near Flemeu. Fruit unknown. (*Don's Mill.*, ii, p. 151.)

G. cinerea Dec. *Fl. Fr.*, 4, p. 424; *Spärtium cinereum* Vill. *Prosp.*, 40; *G. scoparia* Vill. *Dauph.*, 3, 420, exclusively of synonyms; *G. florida* Asso *Ar.*, 94. Erect, much branched. Branches striated. Leaves lanceolate, clothed with adpressed pubescence. Flowers almost sessile along the branches, solitary. Petals silky, about equal in length. Legume clothed with adpressed villi, 4-6-seeded. Native of arid hills and mountains, from Aragon to Nice, in the limits of olives. Flowers in June and July. Shrub, 2 ft. to 6 ft. (*Don's Mill.*, ii, p. 151.)

G. stylosa Spreng *Syst.*, 3, p. 176; *G. bracteolata* Willd. *Herb.* Branches slender, angular, flexuous; and are, as well as the leaves, linear and smooth. Flowers in terminal racemes. Calyx bracteolate. Style elongated, permanent. Native of Portugal. Flowers yellow. Shrub, 2 ft. to 4 ft. (*Don's Mill.*, ii, p. 151.)

G. multicaulis Lam. *Dict.*, 2, p. 617. Dwarf. Branches erect, twiggly. Leaves linear-oblong, rather glabrous, tapering into the petiole at the base. Flowers solitary, on short pedicels. Calyx clothed with adpressed silky pubescence. Corolla glabrous. Native of the Balearic Islands. Shrub, 1 ft. to 2 ft. (*Don's Mill.*, ii, p. 151.)

G. tenuifolia Lois. *Not.*, 169. Stems weak. Branches round and striated, rather erect. Leaves linear, 1-3-veined, glabrous. Flowers disposed in terminal racemes, and, with the legumes, glabrous. Nearly allied to *G. tinctoria* and *G. depressa*, from which it is hardly distinct, unless in the flowers being smaller. Native of Piedmont. (*Dec. Prod.*, ii, p. 150.)

G. depressa Bieb. *Fl. Taur. Suppl.*, p. 430. Stems decumbent. Floriferous branches triquetrous, ascending. Leaves lanceolate, acute, clothed with adpressed hairs. Flowers in the upper axils of the leaves on short pedicels, disposed in such a manner as to appear a leafy raceme. Corolla glabrous. Native of Tauria, on mountains, and about Constantinople; very like *G. mântica*. Shrub, decumbent. (*Don's Mill.*, ii, p. 152.)

G. Perreymondii Lois. *Fl. Gall. ex Bull. Sci.*, Aug. 1828, p. 425. Stems decumbent. Branches striated, round, and rather erect. Leaves lanceolate, rather smooth. Flowers racemose, and terminal. Legume clothed with canescent hairs. Found wild in France, and closely resembling *G. tinctoria*. (*Don's Mill.*, ii, p. 152.)

G. pulchella Visiani *Pl. Dahm ex Bot. Zeit.*, Jan 1820, p. 51. The whole plant is silky. The stems are diffuse, and much branched. The branches are furrowed, and the young ones striped,

tubercled at the buds, and rufescent at the apex. The leaves are simple, lanceolate, entire, small. The flowers are in crowded racemes, the pedicels all leaning to one side. Wings smooth, shorter than the keel. Legumes pendulous, 2—3-seeded. It is a native of Dalmatia, and closely resembles *G. æthiœnsis* and *G. florida*, but is more silky. (*Don's Mill.*, ii. p. 153., adapted.)

G. tridentata Lin. Sp., 998., Brot. Fl. Lus., 2. p. 86. Branches shrubby, triquetrous, membranous, somewhat articulated. Leaves ovate, tridentate at the apex, glabrous. Flowers disposed into crowded, terminal, and lateral heads. Carina and legumes clothed with silky wool. Native of Portugal, on uncultivated hills and among bushes. Wings of stem rather undulated, with the margins roughly denticulated. Shrub, 1 ft. (*Don's Mill.*, ii. p. 153.)

G. albida Willd. Sp., 3. p. 942., Bieb. Fl. Taur., 2. p. 149. 3. p. 459. Stems procumbent, striated, branched. Leaves lanceolate or linear, clothed with white hairs. Legume tomentose. Native of Tauria and Bessarabia, on stony mountains. Allied to *G. pilosa*. Shrub procumbent. (*Don's Mill.*, ii. p. 153.)

G. micrantha Ort. Dec., 6. p. 68. t. 10. f. 1. Stems procumbent, smooth, angular. Leaves linear-lanceolate. Flowers disposed in terminal spikes, distant. Carina rather villous. Legume 2—3-seeded. Native of Spain, in humid places, in the wood called Corazo, near Silos. Flowers in May and June. Shrub, procumbent. (*Don's Mill.*, ii. p. 152.)

G. heterophylla Dec. Prod., 2. p. 152.; *Cytisus heterophyllus* La Peyr. Abr., 422. Erect stems, and angular branches, the sterile ones hairy. Leaves simple, obovate, on short petioles, and clothed with silky down. Flowers usually in threes, axillary, pedunculate. Calyxes campanulate, and hairy. Legume silky. A shrub, from 2 ft. to 4 ft. high; found in the Pyrenees. (*Dec. Prod.*, ii. p. 152.)

G. angulata G. Don, Rafin. Prœc. déc. Som., p. 57., under *Spartium*. Unarmed. Branches pentagonal, glabrous. Leaves simple and trifoliate, stalked; leaflets thin, oblong, mucronate, almost smooth. Legume solitary, pedunculate, oblong, compressed, pubescent. Native of Maryland, in woods. Shrub, from 2 ft. to 3 ft. (*Don's Mill.*, ii. p. 153.)

App. ii. Half-hardy Species of *Genista*.

G. canariensis L., the *Spartium albicans* of Cavanilles, the *Cytisus paniculatus* of Lois., and the *C. ramosissimus* of Poir., (*Bot. Reg.*, t. 217.) is a native of the Canary Islands and of Spain, which has been an inhabitant of British green-houses since 1656. It is a showy shrub, growing to the height of 8 ft. or 10 ft.; very leafy, with terminal heads of flowers, the petals of which are of a cream colour. In dry warm situations, it will grow in the open air with very little protection. A plant has stood out against a wall in the Horticultural Society's garden since 1832.

G. sinifolia L., *Spartium sinifolium* Desf., *Cytisus sinifolius* Lam., *Genistoides sinifolia* Munch., (*Bot. Mag.*, t. 442.; and our fig. 280.) is a native of the south of France, and of Spain, and also of Barbary. It grows to the height of 6 ft., and flowers in our green-houses from January to June. It has been in cultivation since 1739; but, from its flowering in the winter season, it is not so well adapted for the open air as most of the half-hardy species. It is, however, an admirable plant for a conservative wall, where the protection is a glass case.

G. biflora Dec., *Spartium biflorum* Desf. Fl. Atl., 2. p. 133. t. 179., is a shrub from 1 ft. to 3 ft. high, a native of the north of Africa, not yet introduced.

G. microphylla Dec., *Spartium microphyllum* Cav. Ann., 1801, p. 63., is a shrub from 1 ft. to 3 ft. high, a native of the Grand Canary Island on mountains, not yet introduced; unless this, and other species from the Canary Islands, should have been sent home, by Philip Barker Webb, Esq., to the Milford Nursery.

G. tridens Cav. (*Don's Mill.*, 2. p. 151.) grows 2 ft. high in the north of Africa, about Tangier, but has not yet been introduced.

G. ægyptiaca Spreng. grows to the height of 2 ft. in Egypt, and approaches very near to *G. hispânica*, of which it is probably only a variety.

G. virgata Dec., *Spartium virgatum* Ait., *G. gracilis* Poir., *Cytisus tener* Jac. Icon. Rar., t. 147., and our fig. 281., is a handsome shrub, a native of Madeira, growing to the height of 3 ft. or 4 ft., and flowering from March to July. It has been an inhabitant of our green-houses since 1777, but will grow against a wall with very little protection.

G. cuspidata Dec., *Spartium cuspidatum* Burch., is a native of the Cape of Good Hope, and grows to 2 ft. or 3 ft. high. It is a much-branched stiff shrub, and, probably, rather more tender than the preceding species given as half-hardy.

G. congesta Dec., *Spartium congestum* Willd., is a native of Teneriffe, nearly allied to *G. virgata*, and, doubtless, only a variety of it.

G. desiderata Dec., a native of Port Desideratum, and *G. scandens* Lois., a native of Cochinchina, are very doubtful plants, and probably belong to a different tribe.



GENUS VIII.



CYTISUS Dec. THE CYTISUS. Lin. Syst. Monadelphía Decándria.

Identification. Dec. Prod., 2. p. 153.; *Don's Mill.*, 2. p. 154.

Synonymes. *Cytisus* and *Spartium* species *Lin.* and *Lam. &c.*; *Cytise*, *Fr.*; *Bohmenbaum*, *Ger.*

Derivation. From *Cythus*, one of the *Cyclades*, the first of the species known having been found there.

Description, &c. The species are generally deciduous shrubs, but two of them are low trees; all have trifoliolate leaves, and the flowers are for the most part yellow. The shrubs have the habit of *Genista* or of *Spártium*, to both which genera they are nearly allied. All the species are ornamental, some of them eminently so; and those which have their flowers in terminal racemes are decidedly more elegant than those which have them in close terminal, or in axillary heads. The wood of the laburnum is valuable in turnery and cabinet-work. All the species produce seeds in abundance, by which they are almost exclusively propagated. The species recorded in books are numerous; but, if they were all brought together, and cultivated in the same garden, we question much if a tithé of them would be found specifically distinct. The ancients held the cytismus in great estimation; and, according to Pliny, Aristomachus of Athens, and Amphiloehus, wrote treatises on it, which are lost. Much is said on this subject by Columella and Pliny, who have given ample details on the culture and uses of the cytismus; but their description of the plant is so indefinite, that modern naturalists are scarcely agreed as to which species was meant. In England, Switzer, and, in France, M. Amoureux, have written treatises to prove that the cytismus of the ancients was the *Medicàgo arborea* of Lin., the lucerne en arbre of the modern French, and this is at present the general opinion. (See *Medicàgo*.)

§ i. *Alburnoides* Dec.

Derivation. From the word *alburnum*, signifying the white inner sap-wood of trees; and applied to this section from the flowers of the species being white.

Sect. Char. Calyx campanulate. Pod 1—4-seeded, not dilated at the upper suture. Flowers white. Leaves very few. Branches unarmed. (*Dec. Prod.*, ii. p. 153.)

❧ 1. *C. ALBUS* Link. The white Cytismus, or Portugal Broom.

Identification. Link Enum., 2. p. 241; Dec. Prod., 2. p. 153; Don's Mill., 2. p. 154.

Synonymes. *Genista alba* Lam. Dict., 2. p. 623; *Spártium album* Desf. Fl. Atl., 2. p. 152; *Spártium multiflorum* Ait. Hort. Kew., 3. p. 11; *Spártium dispersum* Munch Meth., p. 130; *Genista multiflora* N. Du Ham., 2. p. 76; *Spártium à Fleurs blanches*, Fr.; weisse Piriemeu, Ger.

Engravings. N. Du Ham., 2. t. 23; and our fig. 282.

Spec. Char., &c. Branches terete, twiggy. Leaves simple, and trifoliolate, sessile. Leaflets linear-oblong, silky. Flowers in fascicles, disposed in long racemes. Legume 2-seeded, very villous. (*Don's Mill.*, ii. p. 154.) A very handsome shrub, more especially when covered with its white flowers in May, and when surrounded by hundreds of bees, busily occupied in extracting their honey. It is a native of Portugal and the Levant, and was introduced in 1752; since when it has been very generally cultivated. In good soil, it is of very rapid growth, attaining the height of 5 ft. or 6 ft. in 3 or 4 years, and, in 6 or 8 years, growing as high as 15 ft., or even 20 ft., if in a sheltered situation. Placed by itself on a lawn, it forms a singularly ornamental plant, even when not in flower, by the varied disposition and tufting of its twiggy thread-like branches. When in flower, it is one of the finest ornaments of the garden. Trained to a single stem, its effect is increased; and, grafted on the laburnum, a common practice about Paris, it forms a very remarkable combination of beauty and singularity. Plants are so easily raised from seeds, that they are sold in the British nurseries at very moderate prices: in London, from 5s. to 12s. per hundred, and seeds 10s. per lb. At Bollwyller, and in New York, it is a greenhouse plant.



282



Variety.

- ☛ *C. a. 2 incarnatus* has flesh-coloured flowers, or flowers very slightly tinged with reddish purple. This variety was introduced in 1818; and reproduces itself from seeds, but it varies much in the quantity of colour in the flowers.

§ ii. *Laburnum* Dec.

Derivation. A name applied by Pliny to some species of *Cytisus*.

Sect. Char. Calyx campanulate. Pod many-seeded, not dilated at the upper suture. Flowers yellow. Branches leafy and unarmed. (*Dec. Prod.*, ii. p. 153.)

☛ 2. *C. LABURNUM* L. The common Laburnum.

Identification. Lin. Sp., 1041.; Dec. Prod., 2. p. 153.; Don's Mill., 2. p. 154.

Synonymes. *C. alpinus* Lam. Fl. Fr., 2. p. 621.; Bean-trefoil Tree, and Peascod Tree, Gerard; Pea Tree, Scotch; Golden Chain; L'Aubours, faux E'bénier, Arbois, or Arc-Bois, Fr.; gemeine Bohnenbaum, Ger.

Derivation. The name of L'Aubours, which is given to this tree in Dauphiné and Switzerland, is supposed by Du Hamel to be a corruption of the Latin word *laburnum*. The word Arbois is a corruption of *arc-bois*, the wood of this tree having been used by the ancient Gauls to make their bows; and being still so employed by the country people, in some parts of the Mâconnais, where these bows are found to preserve their strength and elasticity during half a century. The name of False Ebony is applied to the wood, from the blackness of its heart-wood. The German name signifies Bean Tree, and both it and the English and Scotch names of Bean-trefoil and Pea Tree have reference to the shape of the leaves and the legumes. The name of Golden Chain alludes to the length of the drooping racemes of flowers, which, as Cowper elegantly describes them, are "rich in streaming gold."

Engravings. Jacq. Aust., t. 536.; Curt. Bot. Mag., t. 176.; N. Du. Ham. 5. t. 44.; J. Bauhin Hist., t. p. 3. and 361. icon.

Spec. Char., &c. Branches terete, whitish. Leaves petiolate; leaflets ovate-lanceolate, pubescent beneath. Racemes pendulous, simple. Pedicels and calyxes clothed with closely pressed pubescence. Legume linear, many-seeded, clothed with closely pressed pubescence. A tree, a native of Europe, on the lower mountains of the south of Germany, and of Switzerland, where it grows to the height of 20 ft. or upwards. It was introduced in 1596, and produces its fine yellow flowers in May and June.

Varieties.

☛ *C. L. 2 quercifolium* Hort., *C. L. 2 incisum*, has sinuated leaflets, not unlike the leaves of the common oak. (See our plate of this variety in Vol. II.)

☛ *C. L. 3 pendulum* Hort. has pendulous branches.

☛ *C. L. 4 foliis variegatis* has variegated leaves; but it is a plant of no beauty.

☛ *C. L. 5 purpurascens* Hort., *C. L. purpureum* Hort., *C. Adami*, Poir., *C. L. coccineum* Baum. Cat., the purple Laburnum, the scarlet Laburnum, is a hybrid between *C. Laburnum* and *C. purpureum*, in which the flowers are of a reddish purple, slightly tinged with buff, and are produced in pendent spikes, 8 in. or more long. It was originated in Paris, in the nursery of M. Adam, in 1828; it was introduced into England about 1829, and has been a good deal cultivated. It is a very vigorous, and somewhat erect and fastigiate, growing variety, having produced shoots from 6 ft. to 9 ft. long in one season; but, though it has been highly spoken of by some cultivators, in point of beauty, it cannot be recommended. A remarkable fact respecting this hybrid is stated by Mr. Rivers, in the *Gard. Mag.* for May, 1836. When he was in the Jardin des Plantes, at Paris, in the autumn of the year 1835, a fine plant of this variety was shown to him, which appeared to be half *C. purpureum* and half *C. Laburnum*. On examining the plant more minutely, he ascertained that half the plant had partially returned to the habits of one of its parents, the *C. purpureum*; while the remaining part retained the hybrid character in which, as is well known, the habit and foliage of *C. Laburnum* prevail. A similar anomaly

was observed by Mr. Rivers in England; in which, at the extreme end of the shoot of a plant of *C. L. purpurascens*, there came forth a branch of the true *C. purpureus*, with its small leaves and peculiar habit, appearing as if budded on the purple laburnum. (*Gard. Mag.*, vol. xii. p. 225.) The same thing has occurred to the original tree in our garden at Bayswater.

‡ 3. *C. (L.) ALPINUS* Mill. The Alpine, or Scotch, Laburnum.

Identification. Mill. Dict., No. 2.; Dec. Prod., 2. p. 153.; Don's Mill., 2. p. 154.

Synonyms. *C. Laburnum* β *Ait., Lam., Dec. Fl. Fr.*; *Cytisus angustifolius* *Manch Meth.*, 145.; *C. Laburnum* var. *latifolium* *Pers. and Du Mont*; *Cytisus des Alpes*, P'Aubours, *Fr.*; *Alpen Bohlenbaum*, *Ger.*; *Maggio pendolino*, *Ital.*

Engravings. Waldst. et Kit. Hung., 3. t. 260.; and the plate of this tree in Vol. II.

Spec. Char., &c. Branches glabrous and terete. Leaves petiolate; leaflets ovate-lanceolate, rounded at the base. Racemes pendulous. Pedicels and calyxes puberulous. Legumes glabrous, few-seeded, marginate. (*Don's Mill.*, ii. p. 154.) A tree, growing to the height of 20 ft. or 30 ft., and sometimes much higher, in a state of cultivation. It is found in Carinthia, in the Alps of Jura, on Mount Cenis, and on the Apennines. According to some, it is also found wild in Scotland; but, though it is much cultivated in some parts of Fifeshire and Forfarshire, it is far from being indigenous there. It was introduced into Britain about the same time as the other species, viz. 1596; and was, probably, for a long time confounded with it; for which reason we shall treat of the history, uses, &c., of the two species, or races, together.

Variety.

‡ *C. (L.) a. 2 pendulus* has pendulous branches, and, in the foliage and legumes, seems intermediate between *C. Laburnum* and *C. (L.) alpinus*. This is very obvious in a fine specimen of this variety in the arboretum of the Messrs. Loddiges, as shown in our plate in Vol. II. The pendulous variety of *C. Laburnum* is a much less robust plant.

Geography, History, &c. The *Cytisus Laburnum*, according to the *Nouveau Du Hamel*, grows spontaneously in the mountain forests of Germany, Austria, Hungary, Switzerland, and Italy; in several provinces of France, and, among others, in Provence, Dauphiné, Burgundy, Lyonois, Jura, &c. The *Cytisus (L.) alpinus* is found in most of these woods, along with the other species, or race; but it is now particularly abundant in Savoy and Hungary. The laburnum appears to have been known to the Greeks, under the name of Anaguris, and it is mentioned by Theocritus, Virgil, and Pliny. Theocritus states that goats are very fond of its shoots; and Virgil, that it augments the milk of that animal. Pliny, in his *Nat. Hist.*, book xvi. chap. 18., observes that the laburnum, a native of the Alps, was not common in Italy in his time. He adds that bees would not even settle upon the blossoms of this tree. Mathioli mentions that the wood of the laburnum was considered, in his time, to make the best bows. Gerard cultivated this tree in his garden in Holborn, in 1596; and observes that there are two varieties, one with long broad leaves, and the other with less and narrower leaves; that he possessed the latter only, but that Tradescant had both sorts. Miller recognised them as species; but Linnæus did not. Whether they are species or varieties, they are certainly very distinct; as much so, perhaps, as the *Quercus Robur pedunculatum*, and *Q. R. sessiliflorum*. Both sorts, being highly ornamental, have been extensively propagated and cultivated in British gardens and plantations.

Properties and Uses. The heart-wood of the laburnum is of a dark colour; and, though of rather a coarse grain, it is very hard and durable: it will take a polish, and may be made to resemble ebony. A cubic foot weighs 52 lb. 11 oz. in a dried state. The colour and grain of the heart-wood vary much, according to the soil, and the age of the tree. It is darkest in the *C. Laburnum*, when grown on poor calcareous soil; and lightest in the *C. (L.) alpinus*, when grown in deep rich soil: in which last case its

colour is a sort of greenish black. It is in much demand among turners and cabinet-makers; and Sang observes, in 1820, that it was the most valuable and the highest-priced timber that was grown at that time in Scotland. There was, he says, "a considerable quantity of it sold at Brechin Castle and Pannure, in November, 1809, by public sale, at half a guinea a foot. It was all bought by cabinetmakers, who were as anxious to get the small and middle-sized trees as they were to have the large ones." (*Plant. Kal.*, p. 91.) The variety which produced the timber referred to by Mr. Sang was the *C. (L.) alpinus*, there called the tree laburnum. The ordinary use of the wood in the north of Scotland, as we have already observed (p. 497.), is to form alternate staves with the wood of the holly, or the spindle tree, in making small noggins, or bickers; but it is also used for the bowls of punch-ladles; for flutes, and other musical instruments; for knife handles, pegs, and wedges; and for pulleys and blocks: and, in France, Switzerland, and Germany, it is much employed by the cabinet-makers, turners, and toy-makers; also for musical instruments, handles to knives, snuff-boxes, poles for sedan chairs, and oars: and the young trees split up, make excellent hoops. Mr. Bonteher tells us that he has seen in Scotland a large table, and a dozen of chairs, "that were considered by judges of elegant furniture to be the finest they had ever seen," having been made from trees of the laburnum, grown in Scotland, which were a yard in girth, at 6 ft. from the ground. At present, the art of imitating every kind of wood by staining is brought to so high a degree of perfection, that the value of all coloured woods, as far as mere colour is concerned, is very much less than what it was formerly.

In *Plantations*, the laburnum is valuable on some soils, and in some situations, as a shelter for other trees: a quantity are said to have been planted near Amesbury, in Wiltshire, where the situation is very much exposed, and the soil so shallow, that few trees will grow there; yet in this place the young laburnums attained the height of 12 ft. in 4 years after planting, and became a shelter to other trees. Hares and rabbits being remarkably fond of the bark of the laburnum, it has been suggested to sow laburnum seeds, in order to produce an undergrowth in plantations liable to be infested with these animals; for, though the plants are eaten to the ground every winter, yet they will spring up again the next season, and thus yield a regular supply of winter's food for these kinds of game. Miller recommends planting the laburnum thick, for the purpose of drawing up the plants tall and straight for hop-poles, which are said, when formed of laburnum, to be more durable than those of almost any other kind of wood. Sang observes that the laburnum, planted together in masses or groves, attains a timber-like size in a short time, and, if properly pruned, has a straight clean trunk. Medicinally, the whole tree is very bitter, and acts both as an aperient and an emetic. The seeds, in a green state, are very violent in their action, and are justly esteemed poisonous. There are various instances of children having died from eating them.

As an *ornamental tree*, the laburnum has few rivals. The shape of the head is irregular and picturesque; its foliage is of a smooth, shining, and beautiful green; and, what is a great recommendation to every ornamental plant, it is not liable to be preyed on by insects. It produces a profusion of blossoms, which, in the *C. Laburnum*, begin to appear in the first week in May, and in the *C. (L.) alpinus* continue till the first week in July. The purple and white lilac, the Judas tree, the perfumed cherry, the Guelder rose, the birdcherry, the white and the scarlet hawthorn, and the *Pyrus coronaria*, which blossom about the same period, form fine compositions in connexion with the laburnum. In the north of Germany, and in the Highlands of Scotland, the *C. Laburnum* forms a most ornamental tree when trained against a wall. In Italy, the mountains are so richly adorned with the flowers of the laburnum in the month of May, as to obtain for it the name of *Maggio*, in the same way as we give the name of *May* to the hawthorn.

Soil and Situation. Though the laburnum will grow in a very indifferent soil, it requires a deep fertile sandy loam to attain a large size. In regard to

situation, as the tree puts out few horizontal roots, and has rather a spreading head, when it grows rapidly it is apt to be blown aside by high winds. In ornamental plantations it prefers a situation somewhat shaded, as the flowers soon fade, and the leaves assume a paler green, when exposed to the full influence of the sun. When planted with a view to producing timber, it should be placed in masses in a sheltered situation, or in a plantation among other trees, so as to be drawn up with a clear straight stem; and when so circumstanced, in good soil, *C. (L.) alpinus* will grow to the height of from 35 ft. to 45 ft.

Propagation and Culture. Both *C. Laburnum* and *C. (L.) alpinus* are invariably raised from seed, and the pendulous and other varieties are propagated by grafting or budding on either of the common sorts. The seeds are fit to gather in October; and they may be kept in the pod, in a dry airy loft, till the March following, when they should be sown in beds of light soil, at about an inch apart every way, and covered about half an inch or three quarters of an inch thick. Half the plants which come up will be fit for transplanting into nursery lines in the November following.

Statistics. The returns of dimensions which we have received being, in general, for *Cytisus Laburnum*, we are uncertain which of them may be for that species, and which for *C. alpinus*; but we have selected a few, leaving the reader to draw his own conclusion, from the dimensions and the rate of growth given.

C. Laburnum and C. (L.) alpinus in the Neighbourhood of London. The largest and oldest trees are at Syon, where some of *C. alpinus* are from 30 ft. to 40 ft. high. At Purser's Cross, there are some above 30 ft. high. At Kenwood, at Upton House, and in the Mile End Nursery, there are also some very large trees. One at Kenwood, 49 years planted, has the diameter of the trunk, at 1 ft. from the ground, 15 in., and of the head 24 ft., though it is only 20 ft. high.

C. Laburnum and C. (L.) alpinus South of London. In Surrey, at Farnham Castle, from 30 ft. to 40 ft. high; at Bagshot Park, 20 years planted, and 22 ft. high. In Wiltshire, at Wardour Castle, 20 years planted, and 30 ft. high, diameter of trunk 9 in., and of the head 31 ft. In the Isle of Jersey, 10 years planted, 13 ft. high.

C. Laburnum and C. (L.) alpinus North of London. In Durham, at Southend, 18 years planted, and 14 ft. high. In Hertfordshire, at Cheshunt, the oak-leaved variety, 6 years planted, is 13 ft. high. In Oxfordshire, in the Oxford Botanic Garden, 14 years planted, 18 ft. high. In Shropshire, at Hardwicke Grange, 10 years planted, and 23 ft. high. In Yorkshire, at Grimston, 10 years planted, and 25 ft. high.

C. Laburnum and C. (L.) alpinus in Scotland. In Clackmannashire, in the garden of the Dollar Institution, 20 ft. high. In Haddingtonshire, *C. (L.) alpinus*, 40 ft., the diameter of the trunk 18 in., and of the head 32 ft., on loam, on a gravelly subsoil, and the situation sheltered. In the Perth Nursery, *C. (L.) alpinus*, 30 years planted, and 23 ft. high. In Renfrewshire, at Bothwell Castle, *C. (L.) alpinus*, 49 years planted, 35 ft. high, diameter of the trunk 18 in., and of the head 42 ft. In Ross-shire, at Castle Lead, a tree with a trunk nearly 11 ft. in circumference. In Stirlingshire, at Sanchie, 40 ft. high, the trunk 2 ft. in diameter, and the diameter of the head 48 ft.

C. Laburnum and C. (L.) alpinus in Ireland. Near Dublin, at Cypress Grove, 18 ft. high, diameter of trunk 9 in., and of the head 21 ft. At Terenure, 15 years planted, and 12 ft. high. In Fermanagh, at Florence Court, 30 ft. high, the diameter of the trunk 2 ft., and of the head 25 ft. In Galway, at Coole, 29 ft. high. In Tyrone, at Baron's Court, 40 years planted, and 35 ft. high, diameter of the trunk 2 ft. 2 in., and of the head 42 ft. At Baron's Court, besides the above, are thousands of laburnums of large size, intermixed with the plantations.

C. Laburnum and C. (L.) alpinus in Foreign Countries. In France, in the Jardin des Plantes, 32 ft. high; at Nantes, in the nursery of M. De Nerrières, 40 years planted, and 30 ft. high. In Saxony, at Wörlitz, *C. Laburnum*, 45 years planted, and 30 ft. high; and *C. (L.) alpinus*, 35 years planted, and 30 ft. high. In Austria, at Laxenburg, 20 years planted, and 16 ft. high; at Hadersdorf, 10 years planted, and 14 ft. high; at Brick on the Leytha, the oak-leaved variety, 20 years planted, and 30 ft. high. In Prussia, in the Botanic Garden at Berlin, *C. (L.) alpinus* has attained the height of 18 ft. in 15 years; and *C. Laburnum*, 16 ft. in 10 years; the latter is very frequently injured by the frost: at Sans Souci, 15 years planted, and 17 ft. high. In Bavaria, at Munich, in the Botanic Garden, *C. (L.) alpinus*, 4 years planted, and 20 ft. high. In Sweden, at Stockholm, 5 years planted, and 2 ft. high, as a standard, and 6 ft. high against a wall; at Lund, in the Botanic Garden, from 20 ft. to 24 ft. high. In Switzerland, near Geneva, at Bossière, 40 ft. high.

Commercial Statistics. Price of seedling plants, in London, 4s. a thousand; transplanted plants, from 2 ft. to 3 ft. high, 50s. a thousand; from 5 ft. to 7 ft. high, 25s. a hundred; and the weeping and other varieties, 2s. 6d. each. Seeds of *C. Laburnum*, 1s. 6d. per lb.; and of *C. [L.] alpinus*, 4s. per lb. At Bollwyller, plants of the species are 50 cents each; of the broad-leaved, or Scotch, laburnum, 1 franc; of the cut-leaved variety, 1 franc; and of the purple-flowered variety, 3 francs. In New York, the species and the varieties are 50 cents each, with the exception of the weeping sort, which is 1 dollar; and the purple-flowered variety, which they do not appear to possess.

§ 4. *C. NIGRICANS L.* The black Cytisus.

Identification. Lin. Sp., 1041.; Dec. Prod., 2. p. 153.; Don's Mill., 2. p. 155.

Engravings. Jacq. Austr., t. 378.; Ker Bot. Reg., t. 802.; Lam. Ill., t. 618. f. 3.; N. Du Ham., 5. t. 46. f. 1.; and our fig. 283.

Spec. Char., &c. Branches round, twiggy. Leaves stalked, and clothed with closely pressed down beneath, as well as the branches, calyxes, and pods; leaflets elliptic. Racemes elongated, terminal, erect. Calyxes without bracteas. (*Dec. Prod.*, ii. p. 154.) A handsome deciduous shrub, growing from 3 ft. to 6 ft. high, on hills and along way sides, in Piedmont, Vallais, and Bohemia; producing fine yellow flowers in June and July. The whole plant turns black when drying; whence the specific name. It was introduced in 1730, and is very generally to be found in collections. It ripens seeds in abundance; and it may also be propagated by grafting on *C. Laburnum*, thus forming a handsome standard. Price, in London, seedlings, 5s. per 100; transplanted plants, from 1s. to 1s. 6d. each; and plants grafted standard high, from 2s. 6d. to 5s. each: at Bollwyller, 50 cents a plant, or 3 franes for 25 seedlings: in New York, 50 cents a plant.



❖ 5. *C. SESSILIFOLIUS* L. The sessile-leaved Cytisus.

Identification. Lin. Sp., 1041.; *Dec. Prod.*, 2. p. 153.; *Don's Mill.*, 2. p. 155.

Engravings. Lam. Ill., t. 618. f. 2.; N. Du. Ham., 5. t. 45. f. 1.; *Curt. Bot. Mag.*, t. 255.; J. Bauh. Hist., I. p. 2. p. 374. f. 2.; and our figs. 284, 285.

Spec. Char., &c. The whole plant quite smooth. Branches round. Floral leaves almost sessile, and leaflets ovate. Racemes terminal, short, and



erect; each calyx having a 3-leaved bractea under it. (*Dec. Prod.*, ii. p. 153.) A shrub, with upright branches, and smooth shining leaves, growing to the height of from 4 ft. to 7 ft., and flowering in May and June. It is a native of the south of France and Piedmont, and was cultivated in Britain by Parkinson, in 1569. It is in very general cultivation in British gardens, generally as a bush, but sometimes grafted standard high on the laburnum; when it forms a very formal symmetrical, round-headed, small tree, which, however, is highly beautiful when in flower. In Dauphiné, it grows with great vigour, throwing up numerous suckers; and these, with the leaves and flowers, are greedily eaten by cattle, horses, and sheep, and are considered by the inhabitants as highly nutritive. We have given two figures of this species both drawn to the same scale, to show how much it varies in the magnitude and general appearance of its foliage, according to soil and situation. It will be observed that in *fig.* 285. the leaves are not at all sessile, as in the other; but we are nevertheless certain that they are the same species. Price, in London, 1s. a plant; or, grafted standard high, from 2s. 6d. to 5s. each. At Bollwyller, dwarf plants are 50 cents each; and at New York, 50 cents.



❖ 6. *C. TRIFLORUS* L'Hérit. The three-flowered Cytisus.

Identification. L'Hérit. Stirp., 184.; *Desf. Fl. Atl.*, 2. p. 139.;

Dec. Prod., 2. p. 154.; *Don's Mill.*, 2. p. 155.

Synonymic. *C. villosus* Pour. *Act. Toul.*, 3. p. 317.

Engravings. *Clus. Hist.*, I. p. 94. f. 3.; *Duh.*, t. 5. f. 452.; and our *fig.* 286.

Spec. Char., &c. The whole plant hairy. Branches round. Leaves petiolate; leaflets ovate-elliptic. Flowers axillary, pedicellate, terete, and somewhat racemose at the tops of the branches. (*Dec. Prod.*, ii. p. 153.) A straggling hairy



shrub, growing to the height of 3 ft. or 4 ft. in the south of France, Italy, Sicily, and Mauritania. Introduced in 1640, and flowering in June and July. It is frequent in gardens; and plants, in the London nurseries, are charged as in the preceding species. It is sometimes grafted standard high; but neither as a standard nor as a dwarf is it of great duration.

☞ 7. *C. MO'LLIS* Willd. The soft *Cytisus*.

Identification. Willd. Enum. Suppl., 51.; Dec. Prod., 2. p. 154.; Don's Mill., 2. p. 155.

Spec. Char., &c. Leaflets oblong, clothed with soft down, at both ends acute. Peduncles axillary, usually in threes. Calyxes subglobose, trilid, scarious. (*Dec. Prod.*, ii. p. 154.) A shrub, from 2 ft. to 4 ft. high; introduced in 1818, from what country is uncertain, and, perhaps, only a variety of *C. triflorus*.

☞ 8. *C. PA'TENS* L. The spreading *Cytisus*.

Identification. Lin. Syst. Vég., 555., according to L'Hérit. Stirp., 184.; Dec. Prod., 2. p. 154.; Don's Mill., 2. p. 155.

Synonymes. *C. pendulus* Lin. Fl. Suppl., 328.; *Genista tomentosa* Poir. Suppl., 2. p. 719.; *Spartium patens* Lin. Syst., 535., Brot. Fl. Lus., 2. p. 83., but not of Cav.

Spec. Char., &c. Branches striated and pubescent. Leaves trifoliolate, petiole; the upper ones simple, and obovate, as are the leaflets; covered with closely pressed down. Flowers axillary, usually in pairs, pedicelled, nodding. Pods very hairy. (*Dec. Prod.*, ii. p. 154.) A native of Portugal; growing to the height of from 4 ft. to 6 ft. Introduced in 1752, and flowering in June and July. A very handsome shrub, not so common in collections as it ought to be. Plants are in the arboretum of the Messrs. Loddiges.

☞ 9. *C. GRANDIFLO'RUS* Dec. The great-flowered *Cytisus*.

Identification. Dec. Prod., 2. p. 154., Don's Mill., 2. p. 155.

Synonymes. *Spartium grandiflorum* Brot. Fl. Lus., 2. p. 80.

Spec. Char., &c. Branches angled, usually glabrous. Leaves petioled, grouped, trifoliolate, or, in many instances, simple. Leaflets and simple leaf ovate-lanceolate; primary leaflets roundish. Flowers lateral, upon pedicels, solitary or in pairs. Legume woolly all over. (*Dec. Prod.*, ii. p. 154.) Inhabits hedges, hills, river sides, and copses, in Portugal, and grows there to the height of 3 ft. or 4 ft.; flowering in June and July. Introduced in 1816.

☞ 10. *C. SCOPA'RIOUS* Link. The common Broom.

Identification. Link Enum., 2. p. 241.; Dec. Prod., 2. p. 154.; Don's Mill., 2. p. 155.

Synonymes. *Spartium scoparium* Lin. Sp., 998., *Ed. Fl. Dan.*, t. 313., *Smith Eng. Bot.*, 1339.; *Genista scoparia* Lam. Dict., 2. p. 623., but not of Vill.; *G. hirsuta* Muench Meth., 144.; *Genêt à Balais*, ou *Genêt commun*, Fr.; *gemeine Pflriemen*, Ger.

Engravings. *Ed. Fl. Dan.*, t. 313.; *Smith Engl. Bot.*, t. 1339.; and our fig. 287.

Spec. Char., &c. Branches angled, glabrous. Leaves petioled, trifoliolate; the uppermost simple, these and the leaflets oblong. Flowers axillary, pedicelled, solitary. Legumes pilose at the margins. (*Dec. Prod.*, ii. p. 154.) A shrub, growing to the height of from 3 ft. to 6 ft., or even 12 ft., according to the soil and situation; a native of dry sandy or gravelly soils, throughout Europe; and producing its fine large yellow flowers in May and June. The roots are straight, and penetrate perpendicularly to a great depth. The leaves are trifoliolate or simple; the branches numerous, long, straight, angular, dark green, smooth, and tough. The flowers are of a deep golden yellow, sometimes tinged with orange, and occasionally of a uniform pale lemon colour: they are succeeded by pods above an inch long, black when ripe, and each containing 15 or 16 seeds. The flowers are larger than those of any other species of the genus; and, were the species not so common, it would, doubtless, be considered the most ornamental.

Varieties.

☞ *C. s.* 2 *albus* Hort. has the flowers white, or of a very pale yellow.

☞ *C. s.* 3 *flòce pleno* Hort. has flowers slightly double



When the broom is found in abundance in a wild state, it varies considerably in the colour of the flowers, and in the smoothness or hairiness of the pods. Sometimes, also, the calyx takes a purple tinge. None of these varieties, however, are in cultivation, except the first, which, indeed, is of little value.

Geography, History, &c. The broom is found in a wild state in most parts of Europe, from Norway and Sweden to the shores of the Mediterranean. It is also found in the Mediterranean islands, in Greece, Turkey, but not, as it would appear, in Russia. At great elevations, it is a shrub not exceeding 1 ft. in height; but in the woods of Galicia it attains a timber-like size, growing to the height of 20 ft. or 30 ft. or upwards. In Britain, it is found to the height of 1800 ft. or 1900 ft., on the Grampian Mountains, and as far north as Sutherlandshire.

Properties and Uses. The whole plant is exceedingly tough, and bitter to the taste, and has a strong disagreeable smell. Though it is at present comparatively neglected, yet in former times it was one of very great importance in rural and domestic economy. The branches are eaten by sheep and cattle, and, on poor gravelly soils, formed, before the general improvement of grass lands which has taken place within the last century, the principal herbage. In the mountainous districts of Scotland, and also in France and Spain, it still constitutes, with the heath, the principal winter food for store sheep. In Scotland, during the winter season, when the ground was long covered with snow, the broom was cut, and carried to the farm-yards and sheepfolds as the only provender; and, though it is not readily eaten by horses and cows, yet, at that season, they, as well as the sheep, fed on it. Sheep, at all seasons, eat it greedily. The branches were also used for litter, for thatching ricks and houses, and for making fences or screens, in the same manner as reeds.

One of the principal modern uses of the broom, both in Britain and on the Continent, is to form brooms, or besoms, for which purpose, as the specific name would imply, it appears to have been used from time immemorial. In the woods of Spain and the south of France, more especially in Galicia, where, in schistose soils, the broom attains a timber-like size, the wood becomes an object of value. It is much used for veneering, from being finely veined; and many beautiful little articles of turnery are made of it. The most durable of all stakes for supporting vines are made of its branches; and of its twigs ties are made for the vine-dresser, and for a variety of other purposes. The branches were formerly used for tanning leather, and also for dyeing yellow; and, when treated in the same manner as those of *Spártium júnceum* (see p. 577.), they afford a fibre which may be spun and woven into a very good coarse cloth. An excellent paper may also be made of this fibre. The branches, and the whole plant, used at one time, in France, to be burned for the sake of the ashes, from which a potass was procured, by lixiviation and evaporation; the coarsest kind of which was sold to the glass-works, and the finer kind to the apothecaries. In Britany there are extensive tracts of very poor sandy and gravelly soil, upon which scarcely any thing grows but the heath and the broom. These are regularly pastured by immense flocks of sheep; and the tufts of broom, which here and there grow up and form bushes, are periodically cut down; and, after being burned on the spot, their ashes are spread over the surface of the ground as manure.

In domestic economy, the young shoots were formerly used as a substitute for hops in brewing beer; and the flower buds, just before they become yellow, are pickled in the manner of capers.

In medicine, the tops and leaves of broom are purgative and diuretic; and dropsical patients have been cured by taking half a pint of the decoction of green broom tops, with a spoonful of white mustard seed, every morning and evening. Dr. Cullen gave two table-spoonfuls of the decoction every hour, and cured several dropsies with it. The efficacy of the broom in dropsies is said by Sydenham, Monro, and others, to depend upon the alkali contained in the plant.

The principal uses of the broom in Britain, in plantations, are as a shelter for game; and, when cut down, for besoms, fuel, shelters (that is, for filling in hurdles or railings of fences, in the manner of reed-hurdles), and for thatch for ricks and cottages. It has been sometimes sown on poor exposed soils, in order to form a shelter, preparatory to the insertion of plants or seeds of timber trees, in the same manner as furze (see p. 573.) is on rich soils; but, though it affords shelter to the tops of the plants, yet it exhausts the soil to such a degree as to do them more harm than good. As an undergrowth, to protect game, among trees, whatever may be the nature of the soil, it doubtless exhausts it, and naturally checks the growth of the trees. It can only, therefore, be recommended as undergrowth where game is considered of more value than timber. In ornamental plantations, it forms a splendid plant when allowed to attain a large size; and, for this purpose, it is sometimes grafted standard high on *Cytisus* (*L.*) *alpinus*.

Propagation and Culture. The broom produces abundance of seeds, which, according to M. Hartig, retain their germinating quality for a very long time: some that he kept 25 years, in a room which was occupied, having come up as well as new seed. Hence fields that have been many years in pasture, when broken up for corn, sometimes produce abundance of young plants of broom; or, when woods have been grubbed up, or even the surface of the ground burned, the same thing has happened. (See *Gard. Mag.*, x. p. 81.) The seeds, when sown as soon as gathered, or in the following spring, come up in part in the June following, and in part remain in the ground till the next April or May. When sown as a shelter for game, the ground, if an open field, is prepared by ploughing, or, if among trees, by digging in patches, and scattering the seeds in the same manner as recommended for furze. No farther culture is requisite than pulling out the larger weeds the first year. Price of the seeds, in London, is 1s. a pound; price of plants of *C. s. albus*, from 1s. 6d. to 2s. 6d.; of *C. s. flore pleno*, 2s. 6d.; at New York, where it is called Scotch broom, plants are 37½ cents each.

§ iii. *Calycotome* Link.

Derivation. From *calyx*, a calyx, and *tomē*, a cutting; in reference to the calyx, the upper part of which, after some time, falls off, in such a manner as to give the remainder the appearance of being cut round.

Sect. Char. Calyx campanulate, somewhat bilabiate, at length becoming truncate. Pod thickened on the upper suture. Shrubs with spiny branches and yellow flowers. (*Dec. Prod.*, ii. p. 154.)

♣ 11. *C. SPINOSUS* Lam. The spiny *Cytisus*.

Identification. Lam. Dict., 2. p. 247.; *Dec. Prod.*, 2. p. 154.; *Don's Mill.*, 2. p. 155.

Synonyme. *Spartium spinosum* Lin. *Sp.*, 997.

Engravings. J. Bauh. *Hist.*, 1. p. 2. p. 576., icon.; Lob. *Icon.*, 2. t. 95.

Spec. Char., &c. Branches angled, spiny. Leaves trifoliolate; leaflets obovate-oblong. Legumes perfectly smooth. (*Dec. Prod.*, ii. p. 154.) Upon hills and rough places from Perpignan to Genoa, in Corsica, and in the Algerine country, where it attains the height of from 2 ft. to 10 ft.; producing its yellow flowers in June and July. It was introduced in 1596, but is not very common in British collections.

♣ 12. *C. LANIGERUS* Dec. The wool-bearing *Cytisus*.

Identification. *Dec. Prod.*, 2. p. 154.; *Don's Mill.*, 2. p. 155.

Synonyme. *Spartium lanigerum* Desf. *Fl. Atl.*, 2. p. 135.; *Calycotome villosa* Link *Enum.*; *Spartium villosum* Brot. *Fl. Lus.*, 2. p. 85., and *Poir. Voy.*, 2. p. 207.

Spec. Char., &c. Branches furrowed, spiny. Leaves trifoliolate; leaflets obovate-elliptical. Legumes very hairy in a woolly manner. (*Dec. Prod.*, ii. p. 154.)

Variety.

♣ *C. l. rigidus* Dec. Spines very strong.

Description. The species is a shrub, between 2 ft. and 10 ft. high, wild on hills and in rough places in Corsica, Crete, the Archipelago, Mauritania, Gibraltar, and Portugal; producing its yellow flowers from June to July. It was introduced in 1821, but is not common in collections: in all probability, it is nothing more than a variety of the preceding species.

§ iv. *Tubocytisus* Dec.

Derivation. From *tubus*, a tube, and *cytisis*; in reference to the tubular shape of the calyx.

Secl. Char. Calyx tubular, with the apex toothed-lipped. Thornless shrubs (*Dec. Prod.*, ii. p. 155.)

A. *Flowers white or whitish.** 13. *C. LEUCA'NTHUS* *Waldst. et Kit.* The white-flowered *Cytisus*.

Identification. *Waldst. et Kit.*, 2. p. 141. t. 132.; *Dec. Prod.*, 2. p. 155.; *Don's Mill.*, 2. p. 156.

Engravings. *Bot. Mag.*, t. 1438.; and our *fig.* 288.

Spec. Char., &c. Stem erect. Branches round, and, as well as the leaves, clothed with closely pressed pubescence. Leaflets elliptic and acute. Flowers at the points of the branches; heads of flowers bracted by two leaves. (*Dec. Prod.*, ii. p. 155.) A shrub, growing to the height of 3 ft. or 4 ft. in Croatia, in woods. Introduced in 1806, and producing its yellowish white flowers in June and July. It is very ornamental, and well deserves a place among other species of the genus. Price of plants, in the London nurseries, 1s. 6d. each.

B. *Flowers purple.** 14. *C. PURPU'REUS* *Scop.* The purple-flowered *Cytisus*.

Identification. *Scop. Carn.*, No. 905. t. 43.; *Dec. Prod.* 2. p. 155.; *Don's Mill.*, 2. p. 156.

Engravings. *Jacq. Aust. Append.*, t. 48.; *Lodd. Bot. Cab.*, t. 892.; *Bot. Mag.*, t. 1176.; and our *figs.* 289, 290.

Spec. Char., &c. Stems procumbent, twiggly. Leaves, calyxes, and legumes glabrous. Leaflets oblong. Flowers axillary, solitary, on short pedicels. (*Don's Mill.*, ii. p. 156.) A procumbent shrub, a native of Carniola, in exposed places. Introduced in 1792, and flowering from May to August. It seldom exceeds 1 ft. in height, but is very ornamental on rockwork, or when grafted on the laburnum, standard high. Of all the different species of *Cytisus*, when grafted standard high, this forms the most graceful tree; and a plant of it covered with its purple flowers, placed on a lawn, or in a border near a standard of *Genista triquetra*, covered with its golden yellow flowers, will produce a very striking effect. Plants, in the London nurseries, are 1s. 6d. each; grafted standard high, they are from 2s. 6d. to 5s.; at Bollwyller, they are 50 cents each; and for two years' seedlings, 4 francs for 25.

289



290

*Variety.*

* *C. p.* 2 *fløre albo* Hort. has the flowers of a pure white. There is a specimen of this in the London Horticultural Society's garden, and another in the garden of Dr. Neill at Canon Mills.

C. *Flowers yellow.** 15. *C. ELONGA'TUS* *Waldst. et Kit.* The elongated *Cytisus*.

Identification. *Waldst. et Kit. Hung.*, 2. p. 200. t. 183.; *Dec. Prod.*, 2. p. 155.; *Don's Mill.*, 2. p. 155.

Engraving. *Waldst. et Kit. Hung.*, t. 183.

Spec. Char., &c. Stems erect. Branches elongated and round; young ones hairy. Leaflets obovate, clothed beneath with closely pressed hairs. Flowers lateral, usually in fours, on short pedicels. Calyxes hairy. (*Dec. Prod.*, ii.

p. 155.) A native of Hungary, in woods, where it grows to the height of 3 ft. or 4 ft., flowering in May and June. It was introduced in 1804. Price, in London, 1s. 6d. each.

§ 16. *C. MULTIFLORUS* Lindl. The many-flowered Cytisus.

Identification. Lindl. Bot. Reg., t. 1191.; Don's Mill., 2. p. 156.

Synonymes. *C. elongatus Hortul.*, but not of Kit; *C. elongatus* β *multiflorus* Dec. *Prod.*, 2. p. 155.

Engraving. Lindl. Bot. Reg., t. 1191.

Spec. Char., &c. Stems erect. Branches elongated, terete, younger ones villous. Leaflets oblong, tapering to the base, villous beneath, and of the same colour on both surfaces. Flowers usually ternary. Pedicels about equal in length to the petioles. Vexillum emarginate, undulated. (*Don's Mill.*, ii. p. 156.) A native of Europe, growing to the height of 2 ft. or 3 ft. and flowering in May and June. It was in cultivation in 1800, and appears to us only a variety of the preceding species.

§ 17. *C. FALCATUS* Waldst. et Kit. The sickle-like-podded Cytisus.

Identification. Waldst. et Kit. Hung., 3. p. 264.; Dec. *Prod.*, 2. p. 155.; Don's Mill., 2. p. 156.

Engravings. Lodd. Bot. Cab., t. 520.; Waldst. et Kit. Hung., 3. t. 258.

Spec. Char., &c. Stems declinate. Branches round and twiggy; the young ones, as well as the leaves, clothed with closely pressed hairy down. Petioles hairy. Flowers usually in threes, lateral, and on short peduncles. Calyxes clothed with closely pressed hairs. (*Dec. Prod.*, ii. p. 155). A shrub, from 2 ft. to 4 ft. high, a native of Croatia, the south of Russia, and Galicia. Introduced in 1816, and flowering from June to August. There are plants in Loddiges's arboretum. Plants, in London, are 1s. 6d. each.

§ 18. *C. AUSTRIACUS* L. The Austrian Cytisus.

Identification. Lin. Sp., 1042.; Dec. *Prod.*, 2. p. 156.; Don's Mill., 2. p. 156.

Engravings. Mill. Icon., 117. f. 2.; Pail. Itin., ed. Gal., t. 100. f. 3.; Jacq. Austr., t. 21.; and our fig. 291.

Spec. Char., &c. Stems upright. Branches round and twiggy, and, as well as the leaves, clothed with closely pressed strigose pubescence. Leaflets lanceolate, attenuated at both ends. Flowers terminal, somewhat umbellate. Calyxes and legumes rather hairy. (*Dec. Prod.*, ii. p. 156). Found in woods and rough places in Austria, Upper Italy, the Ukraine, and Siberia, and growing from the height of 2 ft. to 4 ft. Introduced in 1741, and flowering from July to September. Plants, in the London nurseries, are 2s. 6d. each.

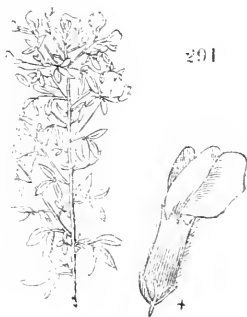

✱ 19. *C. SUPINUS* Jacq. The supine Cytisus.

Identification. Jacq. Fl. Austr., 1. t. 20.; Dec. *Prod.*, 2. p. 156.; Don's Mill., 2. p. 156.

Synonymes. *C. totoides Pour. Act. Toul.*, 3. t. 318.

Engravings. Clus. Hist., p. 96., No. 7., icon.; Jacq. Fl. Austr., 1. t. 20.; and our fig. 292.

Spec. Char., &c. Stems branched and decumbent. Branches round, and, when young, rather hairy; adult ones smooth. Leaflets obovate, hairy beneath. Flowers 2—4, usually terminal and pedunculate. Calyxes and pods slightly hairy. (*Dec. Prod.*, ii. p. 156). A decumbent shrub, a native of Belgium, Austria, Pannonia, Siberia, Turkey, and Dauphiné, found both on exposed hills, and in sheltered bushy places. Its flowers are of a pale yellow, with the standard reddish; and are produced from May to August. It was introduced in 1755. Plants, in the London nurseries, are 1s. 6d. each.



§ 20. *C. HIRSU'TUS* L. The hairy Cytisus.

Identification. Lin. Sp., 1042.; Jacq. Obs., 1. t. 96.; Dec. *Prod.*, 2. p. 156.; Don's Mill. 2. p. 156.

Synonymes. *C. supinus Bertol. Pl. Gen.*, but not of Lin.; *C. triflorus Lam. Dict.*, 2. p. 250., but not of L'Hérit.; *C. Tournefortianus* Loisel. in N. Du Ham, 5. p. 157.

Spec. Char., &c. Stems decumbent. Branches round and twiggy; when young, hairy, but smooth when old. Leaflets ovate, hairy beneath. Flowers lateral on very short pedicels, aggregate. Calyxes and pods hairy. (*Dec. Prod.*, ii. p. 156). Found in rugged places from Genoa to Hungary. Introduced in 1739, and flowering from June to August.

✻ 21. *C. CAPITATUS* Jacq. The headed-flowered Cytisus.

Identification. Jacq. Fl. Austr., t. 33.; *Dec. Prod.*, 2. p. 156.; Don's Mill., 2. p. 156.

Synonymes. *C. hirsutus* Lam. *Dict.*, 2. p. 250.; *C. supinus* Lin. *Sp.*, 1049.

Engraving. Lodd. Bot. Cab., t. 457.

Spec. Char., &c. Stems and branches erect, the latter hispid. Leaflets ovate-elliptic, hairy. Flowers numerous, and forming heads at the points of the branches; but sometimes lateral in the autumn. Calyxes and pods covered with short hairs. (*Dec. Prod.*, ii. p. 156.) An upright-growing shrub, from 2 ft. to 4 ft. high. Found wild on the edges of woods in Burgundy, Italy, and Austria. Introduced in 1774, and flowering in June and July. Plants, in London, are 1s. each.

✻ 22. *C. CILIATUS* Wahlenb. The ciliated-podded Cytisus.

Identification. Wahlenb. Fl. Carp., 219.; *Dec. Prod.*, 2. p. 156.; Don's Mill., 2. p. 156.

Spec. Char., &c. Stems upright. Branches smooth when old, but when young, hispid. Leaflets obovate, clothed beneath with closely pressed hairs. Flowers approximate in threes, at length lateral. Pods glabrous and ciliated. (*Dec. Prod.*, ii. p. 156.) A shrub, from 2 ft. to 4 ft. high, a native of the Carpathian Mountains; flowering in June and July; and introduced in 1817.

✻ 23. *C. POLYTRICHUS* Bieb. The many-haired Cytisus.

Identification. Bieb. Fl. Taur. Suppl., 477.; *Dec. Prod.*, 2. p. 156.; Don's Mill., 2. p. 156.

Spec. Char., &c. Stems declinate. Branches hispid. Leaflets obovate-elliptic. Flowers lateral, usually in pairs, pedicellate. Calyxes and pods hairy. (*Dec. Prod.*, ii. p. 156.) This shrub is found in pine forests, on high mountains, in Tauria; and De Candolle observes of it, that it has the hairiness of *C. capitatus*, the disposition of the flowers of *C. hirsutus*, and the habit of *C. supinus*. It was introduced in 1818. It grows from 2 ft. to 3 ft. high, and flowers in June and July.

§ v. *Lotoides* Dec.

Derivation. From *lotos*, the lotus, and *oides*, appearance; from the general resemblance of the species to the genus *Lötus*.

Spec. Char., &c. Tube of the calyx short, obconical; the upper lip 2-parted, the lower 3-toothed. Corolla hardly longer than the calyx. Many-stemmed decumbent shrubs, deciduous, with few flowers, generally capitate and terminal, and all yellow. (*Dec. Prod.*, ii. p. 156.)

✻ 24. *C. ARGENTEUS* L. The silvery Cytisus.

Identification. Lin. *Sp.*, 1043.; Desf. *Atl.*, 2. p. 139.; *Dec. Prod.*, 2. p. 156.; Don's Mill., 2. p. 157.

Synonyme. *Lötus argenteus* Brot. *Fl. Lus.*, 2. p. 119.

Engraving. Lob. *Icon.*, 2. p. 41. f. 2.

Spec. Char., &c. Stems decumbent. Leaves, calyxes, corollas, and pods clothed with a closely pressed silky down. Leaves petiolate, trifoliolate; leaflets oblong-lanceolate. Flowers 3—4, produced at the points of the shoots. (*Dec. Prod.*, ii. p. 156.) A decumbent shrub, a native of Carniola, the south of France, and Mauritania. Introduced in 1739, and flowering in August. A silky silvery-looking shrub, from the prevalence of closely pressed silky down over all its parts; noticed in the specific character, and whence it derives its specific name. Plants, in the London nurseries, are 1s. 6d. each.

✱ 25. *C. CALYCI'NUS* Bieb. The large-calyxed *Cytisus*.

Identification. Bieb. Fl. Taur., 2. p. 166.; Dec. Prod., 2. p. 157.; Don's Mill., 2. p. 157.

Synonymy. *C. pauciflorus* Willd. *Sp.*, 3. p. 1126.

Engraving. Lodd. Bot. Cab. t. 673.

Spec. Char., &c. Stems ascending. Leaves, calyxes, and pods somewhat hairy from spreading down. Leaves trifoliolate and petiolate. Leaflets roundish, obovate. Flowers terminal, from 2 to 8 together. (*Dec. Prod.*, ii. p. 157.) A prostrate shrub, with trailing branches, the ends of which grow upright; found in stony places on Mount Caucasus. Introduced in 1820, and flowering in August.

✱ 26. *C. NA'NUS* Willd. The dwarf *Cytisus*.

Identification. Willd. Enum., 769.; Don's Mill., 2. p. 157.

Engravings. Wats. Dend. Brit., t. 81.; and our fig. 293.

Spec. Char., &c. Stems cylindrical. Leaves trifoliolate, obovate, clothed with strigose pubescence beneath, and smooth above. Raceme terminal, secund, usually 4-flowered. Calyx deeply 3-parted; hairs on the stems and peduncles adpressed. (*Don's Mill.*, ii. p. 157.) A procumbent shrub, a native of the Levant; flowering in June and July. Introduced in 1816. This is a beautiful little shrub for rock-work; and if planted in dry sandy soil, covered with broad flat stones to retain the moisture during the hot weather of July, it will continue flowering during the whole of that month, and produce abundance of seeds; which may be sent to any distance in the pods.



§ vi. *Chronánthus* Dec.

Derivation. From *chronos*, a year, and *anthos*, a flower; applied to this section because the petals remain attached to the calyxes all the year.

Sect. Char. Calyx with the upper lip bifid, and the lower one trifid; lobes acute, of the same length as the tube. Petals permanent. Legume oval, much compressed, 2-seeded. (*Dec. Prod.*, ii. p. 157.)

✱ 27. *C. ORIENTA'LIS* Lois. The Oriental *Cytisus*.

Identification. Lois. in N. Du Ham., 5. p. 156.; Don's Mill., 2. p. 157.

Synonymy. *C. orientalis*, &c. *Gerard and Vail. Herb.*

Engraving. Pluk. Phyt., t. 31. f. 3.

Spec. Char., &c. Stems erect, hairy. Leaves almost sessile, trifoliolate, hairy; leaflets linear, acute. Flowers large and yellow, subterminal, on short pedicels, and few. The flowers and pods are both glabrous. Calyx hairy, more 5-lobed than bilabiate. (*Dec. Prod.*, ii. p. 157.) A shrub, from 2 ft. to 3 ft. high, a native of the Levant. Introduced in 1818, and producing its large persistent yellow flowers in June and July.

App. i. *Hardy Species of Cytisus not yet introduced.*

Though we believe that by far the greater number of the *Cytisus* described by botanists are mere varieties, and that some of the sorts are mere names copied by one botanist after another, an unavoidable practice in the progress of science; yet, we deem it advisable to add the following descriptions, that the plants may, if possible, be brought together, and studied in the same garden.

C. arborescens Dec.; *Spártium arborescens* Desf. *Atl.*, 2. p. 131. t. 177.; *Genista péndula* Poir. *Voy.*, 2. p. 208. Branches striated and glabrous. Leaves petiolate; leaflets obovate, clothed with fine pubescence beneath. Flowers axillary, aggregate, pedicellate, and nodding. Pods clothed with closely pressed silky down. A shrub, 8 ft. to 10 ft. high, with a trunk about the thickness of a man's arm. (*Dec. Prod.*, ii. p. 154.) Found in valleys near Algiers, by Desfontaines.

C. Wéldenii Visiani, *Pl. Dalm.* ex *Bot. Zeit.*, Jan. 1830, p. 52. Upright. Leaves stalked, and disposed in threes; leaflets elliptic, entire, wedge-shaped at the base, and obtuse at the apex, smooth. Flowers in terminal racemes, stalked, pyramidal, and straight. Pedicels hairy. Calyxes campanulate, 3-lobed; lobes edged with down. Corolla glabrous, but the keel clothed with silky hairs. Pod glabrous and pointed. An upright-growing shrub, from 2 ft. to 4 ft. high; a native of Dalmatia, in woods and on mounts. The flowers are yellow and fragrant. (*Don's Mill.*, ii. p. 155., adapted.)

C. albidus Dec. Stems erect. Branches round, spreading, and rather glabrous. Leaflets oblong, pubescent beneath, as well as the calyxes. Flowers white, axillary, usually in threes, footstalked. Calyx with both lips entire. Ovary pubescent. A native of the south of Europe and north of Africa. (*Dec. Prod.*, ii. 155.)

C. biflorus L'Hérit. Stirp., 184. Ait. Hort. Kew., 3. p. 52. Waldst. et Kit. Hung., 2. p. 166. N. Du Ham., 5. t. 45. f. 2.; *C. supinus* Jacq. *Fl. Austr.*, 1. t. 20.; *C. hirsutus* Gmel. *Sib.*, 4. p. 17. t. 6. f. 2.; *C. hirsutus* and *C. supinus* Bieb. *Fl. Taur. ex Stev. in Litt.*; *C. macrospermus* Bess in *Litt.* Stems diffuse. Branches round, and, as well as the leaves, rather downy. Leaflets oblong-lanceolate. Flowers on short peduncles, axillary, and usually in pairs. Calyxes and pods clothed with close silky down. A native of Austria, Pannonia, Podolia, Tauria, and Siberia. (*Dec. Prod.*, ii. p. 155.) The names of *C. hirsutus* and *C. supinus* appear to have been confused together, and both applied by botanists, not only to this plant, but to others. (See p. 599.)

Varieties.

C. b. 2 glaber Lin. *Fil. Suppl.*, 325, has the branches and leaves glabrous; and the leaflets obovate. (*Ibid.*)

C. b. 3 subspinescens Dec. has the branches rather hoary, more diffuse, somewhat spinescent at the apex. Native of Naples and Hungary. (*Ibid.*)

C. serotinus Kit. in *Litt.* Stems ascending. Branches round, hairy. Leaflets obovate, glabrous above, and rather hairy beneath. Flowers axillary, 2—3, pedicellate. Calyxes hairy. Native of Hungary. (*Dec. Prod.*, ii. p. 155.)

C. pygmaeus Willd. *Spec.*, 3. p. 1127. Stem proeminent, suffruticose. Leaves petiolate, 3-leafleted; leaflets oblong-lanceolate, silky. Flowers usually at the ends of the branches. Pods oblong, and hairy. A native of Galicia. (*Dec. Prod.*, ii. p. 156.)

C. ponticus Willd. *Spec.*, 3. p. 1120, exclusive of the synonyme of Tourn.; *C. ponticus humifusus magno flore* Tourn. *Cor.*, 44; has ascending furrowed branches, which are, like the leaves, pubescent. Leaves with three elliptic obtuse leaflets. Racemes of flowers erect and terminal. Calyxes villous. A shrub, a native of Pontus, as is implied by the specific name. Willdenow, however, gives quite a different description of *C. ponticus*, which, according to him, is allied to *Adenocarpus hispanicus*, and has round branches, not furrowed; and obovate leaflets, not elliptic. (*Dec. Prod.*, ii. p. 157.)

C. canescens Lois. in N. Du Ham., 5. p. 151. The whole plant is clothed with silky hoary pubescence. Leaves trifoliolate; leaflets linear-oblong. Racemes few-flowered and terminal. Calyxes short, campanulate, caesecent, 5-toothed. Country and legumes unknown. (*Dec. Prod.*, ii. p. 157.) There are several plants bearing this name at Syon, but they do not appear to be the same as the species here described.

C. africanus Lois. in N. Du Ham., 5. p. 154; *C. africanus hirsutus angustifolius* Tourn. *Inst.*, 648. Branches erect, hairy. Leaves trifoliolate, with petioles; leaflets linear and pilose. Flowers stalked, in terminal umbels. Calyx hairy, hardly shorter than the corolla. A native of the north of Africa. This plant is said to be allied to *Adenocarpus*. (*Dec. Prod.*, ii. p. 157.)

C. procerus Link *Enum.*, 2. p. 241.; *Spartium procerum* Willd. *Enum.*, 742. Branches round and striated. Leaves lanceolate and downy. Flowers solitary and axillary. Pods hairy. A shrub, a native of Portugal. (*Dec. Prod.*, ii. p. 157.)

C. 2 persicus Burm. *Fl. Ind.*, p. 163. t. 51. f. 1.; *Spartium persicum* Willd. *Sp.*, 3. p. 931; has the branches upright and spreading; both the branches and the leaves are finely pubescent. Leaves trifoliolate, with footstalks; leaflets linear, those in the middle being twice the length of the others. Racemes elongated and loose-flowered, opposite the leaves. Ovary villous. A shrub, a native of Persia, with nearly the habit of *Indigofera psoraloides*; and, if the stamens, as is suspected, are diadelphous, it is certainly referable to *Indigofera*. (*Dec. Prod.*, ii. p. 157.)

App. ii. Half-hardy Species of *Cytisus*.

C. profliferus L., *Dec. Prod.*, 2. p. 155. Don's *Mill.*, 2. p. 155., *Bot. Reg.*, t. 121. *Bot. Cab.*, t. 761. and our fig. 294., is a Teneriffe shrub, with white flowers, cultivated in green-houses since 1769, and flowering in April and May. It grows to the height of from 4 ft. to 6 ft.; and, as in its native country, it is found on mountains, it is probably half-hardy.

C. pallidus Poir., *Dec. Prod.*, 2. p. 157., Don's *Mill.*, 2. p. 157., is a native of the Canaries, growing to the height of 2 ft. or 3 ft., and bearing a general resemblance to *Genista amifolia*, of which it is probably only a variety.

C. nubigenus Link. *Enum.*, 2. p. 240.; *Spartium nubigenum* Ait. *Hort. Kew.*, 3. p. 13.; *S. supranubium* Linn. *Fil. Suppl.*, 319.; *Cytisus fragrans* Lam. *Dict.*; has the flowers fragrant. It is a native of the Peak of Teneriffe, and was introduced by P. B. Webb, Esq. It is in the nursery of Messrs. Young, at Epsom, and flowered with them in May, 1835.

C. bracteolatus Hort. with racemes of golden yellow powerfully fragrant flowers, *C. tetragonolobus* Hort. also fragrant, and *C. racemifolius* Hort., are all Canary and Teneriffe species, which have been introduced by Mr. Webb, and have flowered in the nursery of Messrs. Young and Penny, at Milford, near Godalming. The Canary Isles appear to be rich in species of this genus; and as most of the kinds brought from that country are not only very handsome, but fragrant, they will probably prove valuable additions to our green-houses and conservatory walls. Whenever a new species of the *Cytisus* is introduced from the warmer parts of the old world, it ought to be tried first in a green-house, or in a cold-pit or frame. It will soon, in all probability, ripen seeds, from which plants may be raised, and tried either at the base of a conservatory wall, or on a bank of dry sandy soil, covered with large stones.



App. iii. Anticipated hardy and half-hardy Species of *Cytisus*.

The seeds of a number of species of *Cytisus* have been collected in Teneriffe and the Canary Isles, by Philip Barker Webb, Esq., and sent by him to the Milford Nursery, where plants have been raised from them. Among these there will, no doubt, be some undescribed species, among numbers already known and recorded; but, if care be not taken to identify the latter, it is probable that the whole will, as is usually the case, be described as new; and thus additional names will be introduced into this genus, which, in our opinion, is already sufficiently confused.

GENUS IX.

ADENOCARPUS *Dec.* THE ADENOCARPUS. *Lin. Syst.* Monadélphia
Decándria.

Identification. Dec. Fl. Fr. Suppl., 549; Lég. Mém., 6; Prod., 2. p. 158.; Don's Mill., 2. p. 157.

Derivation. From *adēn*, a gland, and *karpos*, fruit; in reference to the legumes being beset with pedicellate glands.

Description, &c. Shrubs, having very divergent branches; trifoliolate leaves, that have petiolar stipules, folded leaflets, and are usually grouped; and yellow flowers upon bracteolate pedicels, and disposed in terminal racemes. (*Dec. Prod.*, ii. p. 158.) Natives, chiefly, of Europe, which require the same culture as *Cytisus*; from which genus most of the species have been separated.

❖ 1. A. HISPANICUS *Dec.* The Spanish Adenocarpus.

Identification. Dec. Fl. Fr. Suppl., 549.; Lég. Mém., 6; Prod., 2. p. 158.; Don's Mill., 2. p. 158.

Synonymes. *Cytisus hispanicus* *Lam. Dict.*, 2. p. 248.; *C. anagyrius* *L'Hérit. Stirp.*, 184., *N. Du Ham.*, 5. p. 149.

Spec. Char., &c. Calyx glandulose and villose; lower lip with three equal segments, that are barely longer than the upper lip. Branchlets hairy. Flowers grouped. Standard rather glabrous. (*Dec. Prod.*, ii. p. 158.) A shrub, between 2 ft. and 4 ft. high, a native of shady and moist places in Spain and Portugal. (*Dec.*) Introduced in 1816, and producing its yellow flowers in June and July.

❖ 2. A. INTERMEDIUS *Dec.* The intermediate Adenocarpus.

Identification. Dec. Prod., 2. p. 158.; Don's Mill., 2. p. 158.

Synonymes. *Cytisus complicatus* *Brot. Fl. Lus.*, 2. p. 92.

Engravings. *Clus. Hist.*, 1. p. 94. f. 1.; and our fig. 295.

Spec. Char., &c. Calyx pubescent; pubescence glandulated; the middle of the three segments of the lower lip of the calyx longer than the side ones, and than the upper lip. Branchlets rather villose. Flowers rather distant. Standard rather glabrous. (*Dec. Prod.*, ii. p. 158.) A native of sunny gravelly places in Portugal and Old Castile, and Mount Scuder, in Sicily, and of Mongiana, in the kingdom of Naples. A shrub, 4 ft. high, in cultivation in British gardens; but the year of its introduction is unknown. It produces yellow flowers from May to July. This is a very handsome species, and one that is much admired for its fine terminal spikes of flowers, which, in favourable seasons, and in a dry soil, ripen abundance of seeds.

❖ 3. A. PARVIFOLIUS *Dec.* The small-leaved Adenocarpus.

Identification. Dec. Lég. Mém., 6., and Prod., 2. p. 158.; Don's Mill., 2. p. 158.

Synonymes. *Cytisus parvifolius* *N. Du Ham.*, 5. p. 147., *Lam. Dict.*, 2. p. 248., exclusive of the synonymes; *Cytisus divaricatus* *L'Hérit. Stirp.*, 184.; *Cytisus complicatus* *Dec. Fl. Fr.*, No. 3821.; *Spartium complicatum* *Lois. Fl. Gall.*, 411

Engravings. *N. Du Ham.*, 5. t. 47. f. 1.; and our fig. 296.

Spec. Char., &c. Calyx somewhat pubescent, with glandulous pubescence; the central segment of the lower lip longer than the side segments, and much exceeding the upper lip in length. Branches glabrous. Flowers distant. Standard pubescent. (*Dec. Prod.*, ii. p. 158.) A native of sunny heaths in the west of France. A shrub, between 2 ft. and 10 ft. high. Branches whitish. (*Dec.*)



‡ 4. *A. TELONE'NSIS* Dec. The Toulon Adenocarpus.

Identification. Dec. Fl. Fr. Suppl., 54, Lég. Mém., 6, Prod., 2, p. 158.; Don's Mill., 2, p. 158.

Synonymes. *Cytisus telonensis* Lois. Fl. Gall., 446, and in *N. Du Ham.*, 5, p. 155.; *Spartium complicatum* Gouan Hort. Monsp., 336, exclusive of the synonyme.

Engravings. *N. Du Ham.*, 5, t. 47, f. 2.; and our fig. 297.

Spec. Char., &c. Calyx not glandulose, pubescent; the segments on the lower lip nearly equal, exceeding a little the upper lip in length. Branches almost glabrous. Flowers distant. Standard pubescent. (*Dec. Prod.*, ii, p. 158.) A native of sterile places and heaths in the Pyrenees, in Cevennes, in Provence, and in Rome. A shrub, between 2 ft. and 4 ft. high. Introduced in 1800, and flowering in June and July. It well deserves a place in British gardens; where, when judiciously treated, it will, owing to the moisture of our climate, attain double the height that it does in the south of France.



App. i. *Half-hardy Species of Adenocarpus.*

A. frankenioides Choix, *Dec. Prod.*, 2, p. 158.; *Genista viscosa* Willd.; is a native of Teneriffe, or declivities 500 ft. above the level of the sea. Introduced in 1815, and flowering from April to July. It is commonly kept in frames; but, in a dry, airy, and yet sheltered situation, it will doubtless stand the open air. It is usually confounded in gardens with *A. foliolosus*; from which it differs in having a glandular calyx.

A. foliolosus Dec., *Cytisus foliolosus* Ait., is a native of the Great Canary Island. Introduced in 1629; and a very old inhabitant of cold-pits and frames; flowering from May to July.

GENUS X.



ONONIS L. THE RESTHARROW. *Lin. Syst.* Monadélphia Decándria.

Identification. *Lin. Gen.*, No. 863.; *Lam. Ill.*, t. 616.; *Dec. Prod.*, 2, p. 158.; *Don's Mill.*, 2, p. 158.

Synonymes. *Anónis* and *Nátrix* *Muench Meth.*, 157, and 158.; *Arrête-bœuf*, or *Bugrane*, *Fr.*; *Hanc-el*, *Ger.*

Derivation. Said to be from *onos*, an ass; because only asses would feed upon so prickly a plant. Restharrow is a corruption of *arrest*, that is, *stop*, *harrow*; from the long and deeply seated roots opposing a serious impediment to the plough or harrow.

Description. Suffruticose plants, with, mostly, trifoliolate leaves; and axillary flowers, that in some are pedicelled, and in some sessile; and yellow, purplish, and red, or, rarely, white. The peduncle is, in many instances, furnished with an awn, which is the petiole of an abortive floral leaf. (*Dec. Prod.*, ii, p. 158.) Natives of Europe and Africa. Most of the species we have enumerated may be treated as herbaceous plants; but, being technically suffruticose, we considered it proper not to omit them. They are well adapted for rockwork or flower-borders, on account of their lively flowers, some of which are red, or reddish purple; colours not frequently met with in the ligneous Leguminææ, by far the greater part of which have yellow flowers. They are readily propagated by seeds or by division, and will grow in any soil that is tolerably dry. According to Pliny and Dioscorides, the shoots of *Ononis* are eaten pickled in brine, and the leaves are applied to ulcers. In modern times, it is considered to be slightly aperient and diuretic.

‡ 1. *O. FRUTICO'SA* L. The shrubby Restharrow.

Identification. *Lin. Sp.*, 1010.; *Dec. Prod.*, 2, p. 167.; *Don's Mill.*, 2, p. 160.

Engravings. *N. Du Ham.*, 1, t. 58.; *Mill. Icon.*, t. 36.; *Bot. Mag.*, t. 317.; and our fig. 298.

Spec. Char., &c. Shrubby. Leaves trifoliolate. Leaflets sessile, lanceolate, serrated. Stipules connate into one, sheathing, and 4-awned; and, in the uppermost parts of the plant, occupying the places of leaves which are absent. Pedicels 3-flowered, disposed in a raceme. (*Dec. Prod.*, ii, p. 161.)

Variety.

❖ *O. f. 2 microphýlla* Dec., *O. fruticosa* Asso.—Leaflets small, obovate, and serrated. (*Dec.*) The species is a native of sunny places in the Alps of Gallo-provincia, Dauphiné, &c.; the variety of the mountains of Aragon. (*Dec. Prod.*, ii. p.161.) Introduced in 1680. A shrub not unfrequent in botanic gardens, and sometimes growing to the height of 4 ft. It is, perhaps, the only species worth planting in an arboretum. It produces its purplish red flowers in May and June. There is something remarkably singular and attractive in all the shrubby species of the genus *Ononis*; and this variety certainly belongs to one of those species which are most deserving of cultivation. Under favourable circumstances it has exceeded 6 ft. in height, flowering abundantly. Price of plants, in London, 1s. 6d. each.



298

❖ 2. *O. ROTUNDIFOLIA* L. The round-leaved Restharrow.

Identification. Lin. Sp., ed. 1. p.719, but not ed. 2.; *Dec. Prod.*, 2. p.161.; Don's Mill., 2. p.160.

Synonymes. *O. latifolia* Asso *Syn.*, 97., *Lin. Mant.*, t. 11. f. 1.; *Natrix rotundifolia* *Manch.*

Engravings. Jacq. Fl. Austr. Append., t. 49.; Lam. III., t. 616.; Asso *Syn.*, 97.; *Mant.*, t. 11. f. 1.; Hayne *Abbild.*, t. 126.; *Bot. Mag.*, t. 335.; and our *fig.* 299.

Spec. Char., &c. Leaves trifoliolate; leaflets ovate, and toothed. Peduncles 3 flowered, and without bracteas. (*Dec. Prod.*, ii. p.161.) A native of the Pyrenees, and of the Alps. A shrub, under 2 ft. Introduced in 1570, and producing its purplish red flowers from May to September.

Variety.

O. r. 2 aristata Dec.—Peduncle bearing 3 flowers, bearded.

Wild in the Alps and Pyrenees. (*Dec. Prod.*, ii. p.161.) Though, perhaps, this is as much entitled to be treated as a herbaceous plant as a ligneous one, yet it is highly ornamental, and deserves a place on every rock-work, and in every flower-border.



299

❖ 3. *O. (R.) TRIBRACTEATA* Dec. The three-bracted-calyxed Restharrow.

Identification. *Dec. Fl. Fr. Supp.*, 553.; *Dec. Prod.*, 2. p. 161.; Don's Mill., 2. p. 160.

Synonymes. *O. rotundifolia* *Lin. Sp.*, ed. 2., p. 1050., exclusive of the synonymes.

Spec. Char., &c. Shrubby. Leaves trifoliolate; leaflets ovate, toothed. Peduncles usually 3-flowered. Calyx bracted, with 3 leaves. (*Don's Mill.*, ii. p. 160.) Its native country is not known with certainty, but it is reputed to be Carinthia. Is not the kind identical with *O. rotundifolia*? (*Dec. Prod.*, ii. p. 161.) Introduced in 1800; growing to the height of 1½ ft. or 2 ft., and producing its pink flowers from May to July.

❖ 4. *O. NATRIX* Dec. The Goat-root Restharrow.

Identification. Lin. Sp., 1008.; *Dec. Fl. Fr.*, 4. p.514.; *Dec. Prod.*, 2. p. 159.; Don's Mill., 2. p. 158.

Synonyme. *Natrix pinguis* *Manch Meth.*, 158.

Engravings. Mill. *Icon.*, t. 57.; *Bot. Mag.*, t. 329.; and our *fig.* 300.

Spec. Char., &c. Suffruticose, pubescent; pubescence viscoso. Leaves trifoliolate; leaflets oblong, serrated at the tip; the uppermost leaves, in some instances, simple. Stipules adnate to the petiole, oval-lanceolate. Pedicels 1-flowered, awned. (*Dec. Prod.*, ii. p. 159.) A native of Europe, in sunny places, in the south of France, Spain, and Italy. Introduced in 1583, and producing its yellow flowers from June to August. De Candolle has described two forms of this species; one with the standard plain yellow, the other with the standard yellow, streaked with red: the last is the *O. pinguis* of *Lin. Sp.*, 1009., and of our *Hortus Britannicus*, No. 17561. This species seldom exceeds 18 in. in height in a wild state, or 2 ft. in a state of culture. In British gardens, this species is very commonly introduced in collections as a herbaceous plant; and very properly so, because, practically speaking, all plants technically ligneous, which do not, in a state of cultivation, exceed the height of 1 ft. or 2 ft., may with propriety be called in to increase the number of species which can be planted together and treated as herbs. It would surely be ridiculous to omit from herbaceous collections thyme, hyssop, sage, germander, lavender, rosemary, rue, wormwood, southernwood, iberis, alyssum, mitchella, the British heaths, and a great many others that might be mentioned, merely because, not dying down to the ground every year, they are considered by botanists as shrubs, and consequently fit for introduction into an arboretum.

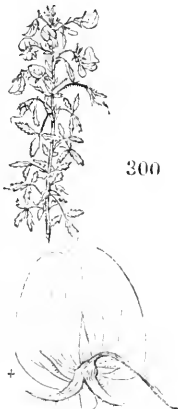

300

5. *O. ARENARIA* Dec. The sand Restharrow.

Identification. Dec. Cat Hort. Monsp., 128.; Fl. Fr. Suppl., p. 551.; Dec. Prod., 2. p. 159.; Don's Mill., 2. p. 159.

Synonyme. *Anonis spinis cærens lutea minor*, Magn. Bot., 21.

Spec. Char., &c. A branchy plant, suffruticose at the base. Branches clothed with clammy pubescence. Leaves divided into three linear-oblong serrated leaflets. Pedicels 1-flowered, shorter than the leaves, and hardly awned. The standard yellow, and not streaked. (*Dec. Prod.*, ii. p. 159.) A native of sandy places on the coast near Montpellier. Introduced in 1819. From half a foot to 1 ft. high, and flowering in June and July.

6. *O. CENISIA* L. The Mount Cenis Restharrow.

Identification. Lin. Mant., 267.; Dec. Prod., 2. p. 161.; Don's Mill., 2. p. 160.

Synonyme. *O. cristata* Mill. Dict.

Engraving. All. Fl. Ped., No. 1173. t. 10. f. 2.

Spec. Char., &c. A many-stemmed, tufted, prostrate, glabrous plant, suffruticose at the base. Leaves palmately trifoliolate; leaflets cuneated, and, like the stipules, serrated. Peduncles 1-flowered, without an awn, and longer than the leaves. A native of rocky places in the Alps of Provence, Dauphiné, and Savoy. (*Dec. Prod.*, ii. p. 161.) Introduced in 1759; and producing its pink flowers in June and July. It rarely exceeds 1 ft. in height.

Variety.

1. *O. c. 2 subaristata* Dec., the *O. cenisia* of *Asso Syn.*, No. 674, is a native of the Pyrenees, and has each peduncle furnished with a kind of awn. It is rather more tender than the species.

7. *O. ARAGONESIS* Asso. The Aragon Restharrow.

Identification. Asso Syn. Arr., 96. t. 6. f. 2; Dec. Fl. Fr. Suppl., p. 562.; Dec. Prod., 2. p. 159.; Don's Mill., 2. p. 162.

Synonyme. *O. dumosa* Lapeyr. Arb., 410.

Engraving. Magn. Hort. Monsp., 17. t. 21.

Spec. Char., &c. A low shrub, with trifoliolate glabrous leaves, and roundish serrated leaflets. Flowers in pairs, almost sessile, and disposed in a leafless raceme. Calyx villous, and one half shorter than the corolla. A native of mountains in Valencia and Aragon, and of the Pyrenees in the part contiguous to France. (*Dec. Prod.*, ii. p. 164.) Introduced in 1816. It grows to the height of from 1 ft. to 2 ft., and produces its yellow flowers from May to July.

App. i. *Other suffruticose Species of Ononis.*

O. pedunculatis Lindl. (*Bot. Reg.*, t. 1445, and our fig. 301. is a small shrub, not more than a foot high, introduced in 1829, from Teneriffe, with fragrant white and rose-coloured flowers. It is usually kept in a frame. It would do, with a little protection, for rockwork. It is in Messrs. Young and Penny's collection.

O. crispa L., *O. hispanica*, *O. vaginatis* L., *O. arachnoidea* Lapeyr., *O. longifolia* Willd., *O. jaicita* Willd., *O. ramosissima* Desf., *O. tridentata* L., *O. angustifolia* Lam., and *O. jaicida* Schousb., are other species of *Ononis* varying in height from 1 ft. to 3 ft., and usually kept in frames or cold-pits; but which, if protected in severe weather, would be very ornamental for rockwork. Descriptions of them will be found in our *Hortus Britannicus*, and in Don's *Miller*.

Other species of *Ononis* marked in catalogues as herbaceous, are nearly as suffruticose as those last mentioned; and, where the object is to extend a collection, there are several that may be introduced in the arboretum. Indeed it may be safely assumed, that, where several species of a genus are ligneous or suffruticose, all the species of that genus are more or less so, and may, by culture, be prevented from dying down to the ground during winter; provided that genus has been formed on natural principles.



GENUS XI.



AMORPHA L. THE AMORPHA, or BASTARD INDIGO. Lin. Syst. Monadelphica Decandria.

Identification. Lin. Gen., 369.; Lam. Ill., t. 621.; Dec. Prod., 2. p. 256.; Don's Mill., 2. p. 234.

Synonyme. Bonafidia Neck. Elem., No. 1564.

Derivation. From *a*, privative, and *morphè*, form; in reference to the deformity of the corolla, from the want of the wings and keel.

Description. Large deciduous shrubs, natives of North America. Leaves impari-pinnate, having many pairs of leaflets that have transparent dots in their disks, and, usually, minute stipules at their base. The leaves have deciduous stipules. The flowers are disposed in lengthened spiked racemes, usually grouped at the tips of the branches; of a blue-violet colour. (*Dec.*

Prod., ii. p. 256.) The species are highly ornamental on account of their leaves, and more especially of their long spikes of flowers; which, though, when taken separately, they are small, and imperfect in regard to form, are yet rich from their number, and their colours of purple or violet, spangled with a golden yellow. The plants are not of long duration; and are liable to be broken by wind; for which reason they ought always to be planted in a sheltered situation. They produce abundance of suckers, from which, and from cuttings of the root, they are very readily propagated. The several sorts that are in the garden of the London Horticultural Society, and in the arboretum of the Messrs. Loddiges, appear to us only varieties of one and the same species.

✽ 1. A. FRUTICO'SA *Lin.* The shrubby *Amorpha*, or *Bastard Indigo*.

Identification. *Lin. Sp.*, 1063.; *Dec. Prod.*, 2. p. 256.; *Don's Mill.*, 2. p. 234.

Synonymes. Wild Indigo, *Amer.*; faux Indigo, *Fr.*, Strauchartiger Uniform, *Ger.*

Engravings. Schkuhr *Handb.*, t. 197.; *Mill. Icon.*, t. 27.; *Bot. Reg.*, 427.; *Krauss.*, t. 7.; *N. Du Ham.*, 3. t. 36.; and our *fig.* 302.

Spec. Char., &c. Rather arborescent, somewhat villose or glabrous. Leaflets elliptic-oblong, the lowest distant from the base of the petiole. Calyx somewhat villose; 4 of its teeth obtuse, 1 acuminate. The standard glandless. Legume few-seeded. (*Dec. Prod.*, ii. p. 256.) A native of Carolina and Florida, on the banks of rivers, where it grows to the height of from 9 ft. to 12 ft. In Britain, it produces its long close spikes of fine, rich, very dark, bluish-purple flowers in June and July. It was introduced into Britain in 1724, by Mark Catesby; who states that the inhabitants of Carolina, at one time, made a sort of coarse indigo from the young shoots. It is now a common shrub in European gardens; and Thunberg is said to have observed it in those of the Island of Nipon, in Japan.



Varieties.

✽ *A. f.* 2 *angustifolia* Pursh has the leaflets linear-elliptic.

✽ *A. f.* 3 *emarginata* Pursh has the leaflets notched, and the calyx hoary. There is a plant of it in the garden of the London Horticultural Society.

✽ *A. f.* 4 *Lewisii* Lodd. *Cat.*, 1830, appears to have rather larger flowers and leaves than the species. There are finely flowering plants of it in the Goldworth Arboretum.

✽ *A. f.* 5 *cærulea* Lodd. *Cat.*, 1830, has the flowers of somewhat a paler blue. There are plants of it in Loddiges's arboretum. Perhaps it is only a variation of *A. crœceo-lanata*.

Commercial Statistics. The price of plants, in the London nurseries, is 1s. 6d. each, and of seeds, 1s. per oz.; at Bollwyller, plants are 50 cents each, or seedlings 10 francs for 50; at New York, plants are 37½ cents each, and seeds 4 dollars per lb.

✽ 2. A. (F.) GLA'BRA *Desf.* The glabrous *Amorpha*, or *Bastard Indigo*.

Identification. *Desf. Cat. Hort. Par.*, 192.; *Dec. Prod.*, 2. p. 256.; *Don's Mill.*, 2. p. 234.

Spec. Char., &c. Rather arborescent, glabrous. Leaflets elliptic-oblong, the lowest distant from the base of the petiole. Calyx glabrous, four of its teeth obtuse, one acuminate. Standard glanded on the outside. Legume containing few seeds. (*Dec. Prod.*, ii. p. 256.) A shrub, growing from 3 ft. to 6 ft. high. Introduced in 1810, and flowering in July and August.

✽ 3. A. (F.) NA'NA *Nutt.* The dwarf *Amorpha*, or *Bastard Indigo*.

Identification. *Nutt. in Fras. Cat.*, 1813; *Nov. Gen. Amer.*, 2. p. 91.; *Dec. Prod.*, 2. p. 256.; *Don's Mill.*, 2. p. 234.

Synonymes. *A. microphylla* Pursh *Fl. Amer. Sept.*, 2. p. 465.

Spec. Char., &c. Shrubby, dwarf, rather glabrous. Leaflets elliptical, mucronulate. Calyx glabrous, all its teeth setaceously acuminate. Legume 1-seeded. (*Dec. Prod.*, ii. p. 256.) A native of herbage-covered hills near the Missouri, where it grows to the height of from 1 ft. to 2 ft. According to Pursh, it is an elegant little shrub, with purple flowers, which are fragrant. It was introduced in 1811, by Mr. Lyon; but it is not common in collections.

4. A. (F.) FRA'GRANS Sweet. The fragrant Amorpha, or *Bastard Indigo*.

Identification. Swt. Fl.-Gard., t. 241; Don's Mill., 2. p. 234.

Synonyme. A. nana Sims in Bot. Mag., t. 2112, but not of others.

Engravings. Swt. Fl.-Gard., t. 241; Bot. Mag., t. 2112; and our fig. 303.

Spec. Char., &c. Shrubby, pubescent. Leaves with 6—8 pairs of elliptic-oblong mucronate leaflets, obtuse at both ends, young ones pubescent. Calyx pubescent, pedicellate; superior teeth obtuse, lower one acute. Style hairy. Flowers dark purple. (*Don's Mill.*, ii. p. 234.) A native of North America, where it grows 7 ft. or 8 ft. high; flowering in June and July. Introduced in 1800; but not common in British collections. Planted in deep, free, dry, sandy soil, this sort, like all the others, will grow and flower freely.



5. A. (F.) CRO'CEO-LANA'TA Wats. The Saffron-coloured-woolly Amorpha, or *tawny Bastard Indigo*.

Identification. Wats. Dend. Brit., t. 139; Don's Mill., 2. p. 234.

Engravings. Wats. Dend. Brit., t. 139; and our fig. 304.

Spec. Char., &c. Plant clothed with tawny pubescence. Racemes branched. Leaves with 6—8 pairs of oblong-elliptic, mucronulate, downy leaflets; the 3 upper teeth of calyx ovate, acute, the 2 lower ones very short, and rounded. (*Don's Mill.*, ii. p. 234.) A native of North America, cultivated in British gardens in 1820, where it is a shrub from 3 ft. to 5 ft. high. Its flowers, which appear in July and August, are of a purplish blue. Plants of this sort are in the Fulham Nursery.



6. A. (F.) CANE'SCENS Nutt. The canescent Amorpha, or *Bastard Indigo*.

Identification. Nutt. in Fras. Cat., 1813, and Gen. Amer., 2. p. 92; Pursh Fl. Amer. Sept., 2. p. 467; *Dec. Prod.*, 2. p. 256; Don's Mill., 2. p. 234.

Synonyme. ? A. pubescens Pursh, 2. p. 467.

Spec. Char., &c. Suffruticose, dwarf, all over whitely tomentose. Leaflets ovate-elliptic, mucronate, the lowest near the base of the petiole. Calyx tomentose; its teeth ovate, acute, equal. Ovary 2-ovuled. Legume 1-seeded. (*Dec. Prod.*, ii. p. 256.) A native of Louisiana, on the banks of the Missouri and the Mississippi; producing its dark blue flowers in July and August. Introduced in 1812, by Lyon, but not common in collections. This sort, like every other kind of Amórpha (and indeed like all ligneous plants, the wood of which is not hard and compact, and the duration of which is consequently but temporary), requires to be well cut in every year, or otherwise to be planted in very poor, dry, sandy soil. Nothing but cutting in shrubs of this description in soils where they grow freely, will either make them assume handsome shapes, or preserve their vitality for any length of time. The same may be said of the peach, the almond, the hydrangea, the ribes, and many other soft-wooded trees and shrubs.

GENUS XII.

ROBINIA Lin. THE ROBINIA, or LOCUST TREE. *Lin. Syst.* Diadélphia Decándria.

Identification. Dec. Mém. Lég., 6; Prod., 2. p. 261.; Don's Mill., 2. p. 237.

Synonymes. Pseudacácia *Tourn. Inst.*, t. 417.; *Mærch Meth.*, 145.; Robinier, *Fr.*; Robinie, *Ger.*

Derivation. Named in honour of Jean Robin, a French botanist, once herbalist to Henry IV. of France, author of *Histoire des Plantes*, 12mo, Paris, 1620; printed with the second edition of Lonicer's *History of Plants*. His son Vespasian was sub-demonstrator at the Jardin des Plantes in Paris, and was the first person who cultivated the Robinia Pseud-Acácia in Europe.

Description. Deciduous trees, natives of North America, where one of the species is highly valued for its timber. In Europe, all the species are much prized both for their use and beauty. They are readily propagated by seeds, large truncheons of the stem and branches, cuttings of the roots, or by grafting; and they will grow in any soil that is not too wet. Their roots are creeping, and their branches very brittle: they grow rapidly, but are not generally of long duration. Their rapid growth is a property that they have in common with all trees and plants the principal roots of which extend themselves close under the surface; because there the soil is always richest: but the same cause that produces this rapidity at first, occasions the tree to grow slowly afterwards, unless the roots are allowed ample space on every side; since, as they never penetrate deep, they soon exhaust all the soil within their reach. For this reason, also, such trees are objectionable as hedgerow trees, or as scattered groups in arable lands; their roots proving a serious impediment to the plough, and the suckers thrown up by them choking the corn crops. Roots, on the other hand, which penetrate perpendicularly as well as horizontally, belong to more slowly, but more steadily, growing trees, which always attain a larger size in proportion to the extent of ground they occupy.

‡ 1. R. PSEUD-ACACIA Lin. The common Robinia, or False Acacia.

Identification. Lin Sp., 1043.; Dec. Prod., 2. p. 261.; Lam. Ill., t. 666. f. 1.; N. Du Ham. 2. t. 16.; Don's Mill., 2. p. 237.

Synonymes. *Æschynomene Pseudacácia Rob.*; Pseudacácia odorata *Mærch Meth.*, 145.; Locust Tree, *Amer.*; the Bastard Acacia; Robinier faux Acacia, Acacia blanc, Carouge des Américains, *Fr.*; gemeine Acacie, or Schotendorn, *Ger.*

Derivation. This tree, when first introduced, was supposed to be a species of the Egyptian acacia, (*Acácia vèra*), from its prickly branches and pinnated leaves, which resembled those of that tree. It was named the locust tree by the missionaries, who were some of the first collectors, and who fancied that it was the tree that supported St. John in the wilderness. It is not, however, a native of any other part of the world than North America. The name Carouge, is the French word for carob bean, the locust tree of Spain; which, being also a native of Syria, is, probably, the true locust of the *New Testament*. The German name of Schotendorn is composed of *schote*, a pod, or legume, and *dorn*, a thorn.

Engravings. Lam. Ill. t. 666.; N. Du Ham., 2. t. 16.; our fig. 305.; and the plate of this species in Volume II.

Spec. Char., &c. Prickles stipular. Branches twiggy. Racemes of flowers loose and pendulous; and smooth, as are the legumes. Leaflets ovate. The flowers are white and sweet-scented; the roots creeping, and their fibres sometimes bearing tubercles. (*Dec. Prod.*, ii. p. 261.) A native of North America, where it is found from Canada to Carolina.

Varieties. The plant varying much in its different native localities, and also having been long cultivated from seeds in Europe, the varieties are numerous. Some of those included in the following list appear in our *Hortus Britannicus*, and in Don's *Miller*, as species; while some hybrids, such as R. híbrida and R. intermedia, might also have been considered as varieties, but we have preferred keeping them apart.

‡ R. P. 2 *fløre litéo* Dumont, 6. p. 140., has the flowers yellow.

‡ R. P. 3 *inèrnis* Dec. Prod., ii. p. 261., Dec. Cat. Hort. Monsp., 136.— Prickles wanting, or nearly obsolete. Leaflets flat. Plant of free growth, in which respect it differs from R. P. umbraculifera.

- † *R. P. 4 crispata* Dec. Prod., ii. p. 261.— Prickles wanting. Leaflets all, or for the most part, undulately curled.
 † *R. P. 5 umbraculifera* Dec. Prod., ii. p. 261., Cat. Hort. Monsp., 157.; *R. inermis* Dum. Cours., vi. p. 140.— Prickles wanting. Branches much crowded, and smooth. Head orbicular. Leaflets ovate. This variety is said to have been raised from the seed of *R. Pseud-Acacia*; and, according to Dumont de Courset, to have yellow flowers. It has been common in British gardens since 1820, but has not yet flowered in this country.
 † *R. P. 6 tortuosa* Dec. Prod., ii. p. 261.; and the plate in Vol. II.— Branches much crowded, and twisted. Racemes similar to those of *R. Pseud-Acacia*, but smaller and fewer-flowered.
 † *R. P. 7 sophoræfolia* Lodd. Cat., 1830, has the leaves large, and somewhat like those of *Sophora japonica*.
 † *R. P. 8 amorphæfolia* Lk. has leaves somewhat like those of *Amorpha fruticosa*.
 † *R. P. 9 stricta* Lk. has the general tendency of the shoots upright; but still the plant is not so fastigate as the Lombardy poplar.
 † *R. P. 10 procera* Lodd. Cat., 1830.— A tall vigorous-growing variety.
 † *R. P. 11 pëndula* Ort. Dec., p. 26.— The shoots are somewhat drooping, but not very decidedly so.
 † *R. P. 12 monströsa* Lodd. Cat., 1830.— The leaves are large, and twisted.
 † *R. P. 13 macrophýlla* Lodd. Cat., 1830, has the leaves long, and the leaflets broad.
 † *R. P. 14 microphýlla* Lodd. Cat., 1830; *R. angustifolia* Hort.; has the leaves small, and the leaflets narrow.
 † *R. P. 15 spectabilis* Dum. has large leaves and is without prickles: it produces straight vigorous shoots, which are angular when young. It was raised from seed by M. Descmet, at St. Denis, and was formerly known in the French nurseries by the name of *agaçante* (enticing).
 † *R. P. 16 latisiliqua*, the broad-podded locust, is mentioned in Prince's *Catalogue* for 1829.

In America, there are three popular varieties, distinguished by the colour of the heart-wood; viz. the red locust, when the heart-wood is red, and which is esteemed by far the most durable and beautiful timber; the green locust, which is the most common, which has a greenish yellow heart, and is held next in esteem to the red; and the white locust, which has a white heart, and is considered the least valuable of all; and, in the western states, there is said to be another variety, called the black locust. All these may more properly be considered as variations, apparently depending solely on the soil and situation, in the same manner as the blue colour of the flowers of the *hydrangea* depends on the soil in which it is planted.

Most of these varieties are tolerably distinct in the foliage when the plants are young; but those best worth cultivating, except where there is a complete collection, are *R. P. umbraculifera*, the parasol acacia; *R. P. pëndula*, the weeping variety; *R. P. stricta*, the upright-growing sort; and *R. P. spectabilis*, the vigorous-growing thornless variety. With regard to the yellow-flowered variety, it may be worth continuing by grafting or suckers; but, to make quite sure of having white flowers, the trees producing them ought to be propagated by grafting also; as plants raised from seed, though, for the most part, they have white flowers, yet occasionally produce yellowish ones.

Description. The *Robinia Pseud-Acacia*, though it attains the height of 70 ft. or 80 ft., with a trunk of 2 ft. or 3 ft. in diameter, in favourable situations in its native country, yet is seldom, if ever, found there with a straight clean trunk, which will admit of being sawn up into boards of even moderate dimensions. It is a much branched tree, with the branches, as well as the trunk, somewhat twisted: the branches have a general tendency upwards when the tree is

young, but as it grows old they spread out horizontally. They are armed with strong hooked prickles, and not with spines or ligneous thorns; the former being only attached to the bark, like the prickles of the common rose or the bramble; and the latter proceeding from the wood, like the spines of the hawthorn, cockspur, and other thorns. The leaves of the robinia are composite, the leaflets being sessile, and 8, 10, or even 12, with an odd one. Their texture is so fine, and their surface so smooth, that the dust which falls on them will hardly lie; which last circumstance renders the tree particularly eligible for planting along road sides, in the neighbourhood of towns, or in great thoroughfares. The flowers are disposed



in pendulous bunches, white or yellowish, and are most agreeably fragrant: they are succeeded by narrow flat legumes, about 3 in. long, each containing 5 or 6 small seeds, which are commonly brown, but sometimes black. These seeds, when taken out of the pod, and exposed to the air, will hardly retain their vegetative properties two years, but, when kept in the pod, they will remain good a year longer; and, when the pods are buried 5 ft. or 6 ft. under the surface, in dry soil, they have been known to keep 7 years, without losing their vitality, and would probably retain it for a much longer period. The dimensions of the tree, in its native country, vary much with the soil and climate in which it grows. In Kentucky, the tree sometimes attains the height of 70 ft. or 80 ft., with a trunk 4 ft. in diameter; but it does not arrive at half that size at Harrisburgh, in Pennsylvania. On the trunk and large limbs of the old robinias, the bark is very thick, and deeply furrowed; but on the young trees it is comparatively smooth for the first 10 or 15 years. The young tree, till the trunk attains the diameter of 2 in. or 3 in., is armed with formidable prickles; but these disappear altogether as it grows old, and they are wanting, in some of the varieties, even when they are young. The wood, which is commonly of a greenish yellow colour, marked with brown veins, is hard, compact, and susceptible of a bright polish: it has a good deal of strength, and is very durable; but it has not much elasticity, and is somewhat liable to crack. The tree has one property almost peculiar to it, that of forming heart-wood at a very early age, viz. in its third year; whereas the sap-wood of the oak, the chestnut, the beech, the elm, and most other trees, does not begin to change into heart, or perfect, wood, till after 10 or 15 years' growth. (*Michx.*) In Britain, in the neighbourhood of London, the *Robinia Pseud-Acacia* sometimes attains as great a height as it does in any part of America; but, north of London, it is as small as it is in the north-east of Pennsylvania, or smaller. It grows with great rapidity when young; plants, in 10 years from the seed, attaining the height of from 20 ft. to 30 ft., or even 40 ft.; and established young plants producing shoots 8 ft. or 10 ft. long in one season. When the tree has once attained the height of about 40 ft. or 50 ft., it grows very slowly afterwards; but, whatever height it attains, there are very few specimens to be met with in England, that have more than 30 or 40 cubic feet of timber in the trunk. At 50 or 60 years of age, the trunk is not greatly increased in girth; but at that age the branches often contain as great a bulk of timber as the trunk, though, from not being straight, that timber is comparatively of little value, except for fuel. The greatest bulk of timber contained in any robinia that we have heard of is in one at Taverham, in Norfolk, which contains 89½ cubic ft. (*Withers's Treat.*, p. 234.) It stands among some silver firs, which are presumed to be about the same age, and which contain nearly 3 loads (about 150 ft.) of timber each; thus affording a tolerable criterion of the comparative rate of growth of the two trees. The trees of this species, and of several of its varieties, in the garden of the Horticultural Society, and in the arboretum of Messrs. Loddiges, have attained the

height of 30 ft. and upwards, in 10 years from the time they were planted. Cobbett and Withers record instances of much more rapid growth. The former, in his *Woodlands* (§ 382.), mentions a plantation at Coleshill, in which the trees averaged 19 ft. after being $\frac{1}{4}$ years planted; and others at Botley, which, in 11 years had attained the height of 40 ft., with trunks "3 ft. 2 in. round at the bottom" (*Ibid.*, § 358.); and in Withers's *Treatise*, p. 254., mention is made of 900 plants, placed $\frac{1}{4}$ ft. apart in 1824, which, in 1828, had reached to from 13 ft. to 16 ft. in height, and were to be cut down, and used as hop-poles.

A plantation of locusts, Scotch pines, sycamores, limes, Spanish chestnuts, beeches, ashes, and oaks was made in 1812, at Earl's Court, near Kensington, and the trees measured, at Cobbett's request, in 1827; when it was found that the locust had grown faster than any one kind of the other trees in the proportion of 27 to 22, and faster than the average of them in the proportion of 27 to 18. (See *Woodlands*, §. 375., and *Gard. Mag.*, vol. iii. p. 363.) This comparatively rapid growth of the locust, which is in a great measure confirmed by other measurements in Mr. Withers's *Treatise*, is owing to the spreading roots of the tree having the power of more rapidly extracting nourishment from the soil than the descending roots of the other trees among which it was planted; but these other trees, with descending roots, though they grow slower than the locust at first, would, in the course of 30 or 40 years, overtop it, and ultimately destroy it altogether, as has been proved in the Bois de Boulogne near Paris.

Geography. In North America, the locust tree, as it is there called, begins to grow naturally in Pennsylvania, between Lancaster and Harrisburgh, in the lat. of $40^{\circ} 20'$: west of the Alleghanies, it is found 2° or 3° farther north; because, on the west side of these mountains, the climate is milder, and the soil more fertile than on the east of them. It is most abundant in the south-west, abounding in all the valleys between the chains of the Alleghany mountains, particularly in Limestone Valley. It is common in all the western states, between the Ohio, the Illinois, the lakes, and the Mississippi. It is plentiful in Upper Canada, and also in Lower Canada; but it is not found in the states east of the river Delaware, nor does it grow spontaneously in the maritime parts of the middle and southern states, to the distance of from 50 to 100 miles from the sea. It is planted, however, in that region for purposes of both utility and ornament. It is observed by Michaux, that the locust forms a much smaller proportion of the American forests than the oaks and walnuts, and that it is nowhere found occupying tracts, even of a few acres exclusively. Hence the tree, where it is met with, is frequently spared by settlers, as being ornamental, and comparatively rare; in the same manner as the black walnut is frequently spared for the same reasons, and for its fruit. Hence, also, old specimens of these two trees, which have belonged to the aboriginal forests, are frequently seen growing in the midst of cultivated fields.

History. There is, perhaps, no American tree respecting which so much has been said and done, in Europe, as the locust. It was one of the first trees that we received from that country, and it has been more extensively propagated than any other, both in France and England. It has been alternately extolled and neglected in both countries; and even at the present time, though the beauty of its foliage and flowers is generally acknowledged, and though it has, at different periods, been enthusiastically praised by different writers, for the valuable properties of its wood, it cannot be considered as holding a high rank as a timber tree, or as being generally planted with a view to profit.

The seeds of this tree, it is stated in Martyn's *Miller* and most other British works, and even in the *Nouveau Du Hamel* and Baudrillart's *Dictionnaire*, were first sent to Europe to Jean Robin, gardener to Henry IV. of France, in 1601; but, according to Deleuze, as quoted, p. 136., and also to Adanson, in the article *Acacia*, in the French *Encyclopædia*, the locust was sent from

America to Vespasian Robin (son to Jean Robin), who was arborist to Louis XIII., and was planted by him in the Jardin des Plantes in 1635.

In England, it appears to have been first cultivated by the elder Tradescant; but whether he obtained it from France, or direct from Virginia, is uncertain. It is highly probable, that he may have received it from America even before Robin, as Parkinson, in his *Theatre of Plants*, published in 1640, mentions the tree as having been grown by Tradescant "to an exceeding height." The first tree planted in Paris still exists (as noticed p. 136.); and the first tree planted in Germany, in 1696, still remains, though in a very decayed state, in a court-yard in Vienna (as noticed p. 147.). Tradescant's tree was in existence when Sir William Watson visited his garden in 1749. (See p. 40.) The earliest notice of the robinia in England is that in Parkinson's *Theatre of Plants*, before referred to: it is not mentioned by Gerard, either in the first edition of his *Herbal*, published in 1597, or in that edited by Johnson, in 1629. Evelyn, in the first edition of his *Sylva*, published in 1664, says, "The French have lately brought in the Virginian acacia, which exceedingly adorns their walks. The tree is hardy against all the invasions of our sharpest seasons; but our high winds, which, by reason of its brittle nature, it does not so well resist; and the roots (which insinuate and run like liquorice under ground) are apt to emaciate the soil, and, therefore, haply not so commendable in our gardens as they would be agreeable for variety of walks and shade. They thrive well in His Majesty's new plantation in St. James's Park." (*Sylva*, ed. 1664, p. 64.) In the edition of the *Sylva* published in 1706, Evelyn speaks of two acacias, the gleditschia and the false acacia; "both which," he says, "deserve a place among avenue trees, and love to be planted among moist ground." Mortimer, in 1712, says, "A great number of acacias were formerly planted in St. James's Park; but, in consequence of some of their branches being broken by the wind, they were all cut down." Bradley, in 1718, speaks of the Virginian acacia as the only species of that tree that will stand the open air in England, and refers to some of them growing in the court before Russell House, Bloomsbury (now the British Museum), and in the Old Palace Yard, Westminster. None of these trees now exist. Ray, in his *History*, published in 1719, mentions the robinia as among the trees growing in the Bishop of London's garden at Fulham. According to Lysons there were two trees there in 1809; and the remains of one of them still exist (1836). (See p. 43.) Miller, in 1731, speaks of the robinia as very common in gardens near London, where there were, in his time, several large old trees. He says that they are very hardy, but will not endure being exposed to high strong winds, which break their branches, and render them unsightly. "Many people," he adds, "have neglected to cultivate them on that account; but they will do well if planted in wildernesses among other trees, where they will be sheltered, and make a beautiful variety." Miller mentions one 40 ft. high as a large tree; and he also states that, in his time, the robinia had ripened seeds in England, from which young plants had been raised. In 1752, he says that the robinia was generally propagated in English nurseries by suckers from the roots of old trees, but that he prefers raising them from seeds. Young plants, he says, frequently make shoots of from 6 ft. to 8 ft. in length in one season. "These trees," he adds, "were formerly in great request in England, and were frequently planted in avenues, and for shady walks; but their branches being generally broken or split down by the wind in summer, when they are clothed with leaves, the trees are rendered improper for this purpose; and their leaves coming out late in the spring, and falling off early in the autumn, occasioned their being neglected for many years; but of late they have been much in request again, so that the nurseries have been cleared of these trees; though, in a few years, they will be as little enquired after as heretofore, when those which have been lately planted begin to have their ragged appearance." (*Dict.*, 6th edit. in 1752.) In the seventh edition of his *Dictionary*, published in 1759, Miller says that young trees, two or three

years' seedlings, are 8 ft. or 10 ft. high. In Dr. Hunter's edition of Evelyn's *Sylva*, published in 1786, we have a history of the employment of the robinia in ship-building, communicated to the doctor by Joseph Harrison, Esq., of Bawtry, in a letter dated July 25. 1782. This gentleman had resided some time in Virginia; and he states that, about the year 1733, the first experiment was made respecting the application of the locust tree to any purpose in ship-building, by an ingenious shipwright, sent over to America by some Liverpool merchants to build two large ships there. This shipwright thought "that the oaks, elms, ashes, and many other timber trees common to both countries, were much inferior to the same sorts in England; but frequently spoke of the locust tree as of extraordinary qualities, both in strength and duration." He had observed some very old timber in houses in New England, that had been built of the wood of this tree, when the country was first settled, perfectly firm and sound; and, after having completed his engagement for his employers, he began to build a small vessel for himself; when, being at a loss for a sufficient quantity of iron, and having observed the extraordinary strength and firmness of the locust tree, he took it into his head that trenails, or tree-nails, that is, wooden pins, of that timber, might be substituted for iron bolts in many places where they would be least liable to wrench or twist (as in fastening the floor timbers to the keel, and the knees to the ends of the beams, which two articles take up a large proportion of the iron used in a ship), purposing, when he arrived in England, to bore out the locust trenails, and drive in iron bolts in their stead. The ship, being finished and loaded, sailed for Liverpool, and returned back to Virginia the next year; and the builder himself being the captain of her, he paid particular attention to see the effect of the locust trenails. After the strictest examination, he found that they effectually answered the purpose intended. It was, however, thought prudent to take several of them out, and to put in iron bolts in their room; and this operation afforded another proof of their extraordinary strength and firmness, as they required to be driven out with what is technically called a set bolt (an iron punch), just as if they had been made of iron; whereas oak trenails are usually bored out with an auger. This captain afterwards died in the West Indies; and the use of the locust for trenails was neglected for some years, till it was revived at the instance of Mr. Harrison, by a ship-builder of eminence at New York, where it has since been in general use. Till the value of the locust tree for trenails, or trunnels, as they are called by Cobbett, was proved in America, they were formed in Britain of the best oak timber; and, as the oak wood grown in Sussex is generally reckoned the best in the island, oak trenails were sent from that county to every part of Britain; but at present oak is only partially used for this purpose, locust trenails being imported from America to a very great extent.

Public attention being thus, about the latter end of the last century, powerfully directed to the locust, both in Europe and in America, various pamphlets and papers in the *Transactions* of societies began to be published on the subject. A *Treatise on the Common Acacia* was published at Bordeaux in 1762, and a *Memoir* on it in Paris in 1786. In the latter, it is recommended for planting on the banks of rivers, in order to strengthen the banks by its running roots, and the numerous suckers which they throw up. The writer also recommends it for pea-sticks, hop-poles, vine-props, hoops, wedges, cogs to wheels, &c.; and even as a substitute for saint-foin, as a forage crop, to be mown thrice a year, and either used green, or dried as hay and stacked mixed with straw for winter use. He mentions its various medical properties, and adds that a very agreeable syrup is made from the flowers. There is also a paper on the subject in the *Memoirs of the American Academy of Arts, &c.* for 1785. The writer says that the wood, when green, is of a soft texture, but it becomes hard when dry. He considers it as durable as the best white oak; and states that it is esteemed preferable to the timber of that tree, for the axletrees of carriages, trenails for ships, and many other mechanical purposes. It makes excellent fuel, being, like the ash, fit to

burn immediately after it is cut ; and its shade less injurious to grass than that of most other trees.

In the *Gentleman's Magazine* for 1791, there is a long account of a scheme by Mr. Ebenezer Jessup for growing locust trees for the use of the royal navy. It is there proposed, that an act of parliament be obtained, apportioning about 10,000 acres in the New Forest, and in the Forest of Dean, to be set apart for growing locust trees, live oak (*Quercus virens*), and white oak (*Quercus álba*), for the use of the royal navy. The distance at which Mr. Jessup proposes to plant these trees is $16\frac{1}{2}$ ft., so that he calculates an acre will produce 160 trees of about $1\frac{1}{2}$ ton each. The locust, he says, will be fit for ship-building in 25 or 30 years, the live oak in 40 years, and the white oak in 60 years, from the time of planting. He states that stakes made of the locust wood have stood exposed to the weather, to his *certain knowledge*, for 80 or 100 years before they began to decay ; and that the live oak and the white oak, though they do not attain so large a size as the British oak, produce a more durable timber. He recommends the locust tree to be planted in poor soil, but the oaks "in good rich land." In order to save government "any considerable expense," he proposes to prepare the soil, and take care of the trees afterwards, by the out-pensioners of Chelsea, who are to be sent in relays every six months, and to dwell in houses built for their accommodation in central parts of the forest ; every house to have a piece of ground allotted to it for a garden, &c. &c. (*Gent. Mag.*, vol. lxi. p. 699.) In February, 1793, (30^{me} Pluvisse, an 2,) the National Convention decreed that an impression of *L'Annuaire du Cultivateur* should be struck off, and distributed in the departments, the Committee of Public Instruction thinking it worthy of a place among the elementary books intended for the use of the national schools. In this work, every day in the year is marked by one or more natural productions, or their attendant phenomena ; and the 6th of May (14^{me} Prairial) was consecrated to the *Robinia Pseud-Acacia*, and a notice given of its appearance, propagation, culture, and uses.

A *Letter on the Acacia*, by Dr. Pulteney, was published in the *Gentleman's Magazine* for 1801, p. 1098., in which, quoting from Ray, he says the leaves are highly grateful to cattle, and that treatises have been written to recommend the cultivation of the tree for its young shoots as forage. Governor Pownall, in *Young's Annals of Agriculture*, vol. viii., states that several gentlemen in America have informed him, that, in the neighbourhood of New York, posts for rail-fencing made of the locust tree stood "wet and dry, next the ground," better than any other timber posts in common use ; and almost as well as posts of the swamp cedar (the deciduous cypress). This gentleman remarks that the locust wood which is used in America for ship-building, trenails, and posts, has commonly been grown in barren, sandy, or light soils ; and that in England, where it is generally planted in rich soils, and in sheltered situations, the tree may, probably, outgrow its strength ; and thus the branches may become so brittle as to be easily broken by the winds ; while the wood will be less hard and tenacious, and, in all probability, much less durable than in America. He therefore recommends planting the locust, in England, only on poor soils, when it is intended to employ the timber for useful purposes.

In the *Recreations of Agriculture* for 1802, there is a paper on the uses of the *Robinia Pseud-Acacia* in fencing, in which it is recommended as a hedge plant on poor, gravelly, sandy soils. Its young twigs are said to be covered with a kind of thorn that renders them terrible to animals of all sorts ; and, consequently, locust hedges can require no protection from cattle when young. The writer appears to have forgotten, or, perhaps, not to have known, that cattle are said to be remarkably fond of the shoots both in America and France. He recommends training each plant to a single shoot, in order that, after a certain time, the hedge may be cut down, and the plants which have composed it may be used for hop-poles, for posts and rails, and for other rustic purposes. Such hedges, he says, are common in Germany : the writer

adds, that, though seeds may be procured in the neighbourhood of London, yet that the best mode is to import them from North America; sending the order for that purpose in the month of June, and being particularly careful to get seeds of that year, because two years' old seeds will not grow. (*Recreations in Agriculture*, vol. vi. p. 560.) In France, in the year 1803, a work, entitled *Lettre sur le Robinier*, was published in Paris by M. François de Neufchâteau, containing the essence of all that had been previously published on the subject in France, supported by the republication of many previously written tracts, or extracts from them. A translation of M. François's work occupies the first 156 pages of Withers's *Treatise on the Acacia*; and, with a notice of the article by Adanson, in the *French Encyclopædia*, and another by Miller, editor of the *Journal des Forêts*, dated 1830, forms a very interesting history of the tree in France, from its first introduction into that country to the present time. The result of all that has been said in favour of the acacia in France, according to Miller, is, that it is generally employed in that country to decorate pleasure-grounds; but he is "not aware that there are any forest plantations of acacia, for the express purpose of raising timber for carpenter's work, and ship timber." (*Withers's Treatise*, p. 278.)

In the year 1823, an extraordinary sensation was excited in Britain respecting this tree by Cobbett. This writer while in America, from 1817 to 1819, chiefly occupied himself in farming and gardening in Long Island, near New York; and, during that period, as he tells us in his *Woodlands* (§ 326.), "was convinced that nothing in the timber way could be so great a benefit as the general cultivation of this tree." He adds: "Thus thinking, I brought home a parcel of the seeds with me in 1819, but I had no means of sowing it till 1823. I then began sowing it, but upon a very small scale. I sold the plants; and since that time I have sold altogether more than a million of them"! He elsewhere states, in the same work (§ 380.), that he sold one year's transplanted plants at 10s. per 100. He had a large kitchen-garden behind his house at Kensington, which he turned into a nursery; and he also grew trees extensively on his farm at Barnes, in Surrey. He imported American tree seeds, and grafts of fruit trees: and he strongly recommended all of these to the British public, in his *Political Register*, and in the *Woodlands*, which was published, in numbers, from 1825 to 1828. In these works, he more especially directed attention to the locust tree, urging, in his clear and forcible manner, the immense importance of this tree in ship-building; and he was the means of many thousands of it being planted in the southern and middle districts of England, and even as far north as Durham. The name of locust, as applied to this tree, was, before Cobbett's time, almost unknown in England, and many persons, in consequence, thought it was a new tree. Hence, while quantities of plants of *Robinia Pseud-Acacia* stood unasked for in the nurseries, the locust, which every one believed could only be had genuine from Mr. Cobbett, could not be grown by him in sufficient quantities to supply the demand. Cobbett imported the seeds in tons; but, when he ran short of the real American ones, he procured them, as well as young plants, from the London nurseries. This we state on the authority of the late Mr. William Malcolm of the Kensington Nursery, who sold him both seeds and plants. We do not say that there was anything wrong in Cobbett's doing this; but, had the public known that locust seeds and locust plants were so easily to be procured, it is probable that the locust mania would never have attained the height it did. We have ourselves, several times, accompanied planters to Cobbett's nursery to procure trees; and went once with a gentleman who had purchased a large estate in South Wales, who bought some thousands of locust plants to send to it. When he mentioned to us his intention, we told him that he might purchase the plants at half the price in the Bristol Nursery; and that, from the comparative shortness of the distance, he would not only save a considerable expense in carriage, but that the plants would be in a much fresher state, and, consequently, more likely to grow when they arrived at his place. No arguments of ours, however, were of any avail; and Cobbett's locust

trees were decidedly preferred, at any cost, to Miller's robinias. A notice of Cobbett's nursery, and of the various trees that he cultivated in it, will be found in his *Woodlands*, and in the *Gardener's Magazine*, vol. iii. p. 363. At present, the rage for planting the locust has altogether subsided; but the great importance of the tree in ship-building, and for supplying fuel, hop-poles, sticks for peas, and similar purposes, is about to be illustrated by an enthusiastic admirer of it, W. Withers, Esq., of Holt, Norfolk, author of a *Memoir addressed to the Society of Arts, on the Planting and Rearing of Forest Trees*, &c. &c. This gentleman has liberally and kindly sent us the proof sheets, as far as printed (to p. 320.), of his *Treatise on the Growth, Qualities, and Uses of the Acacia Tree*, &c., with liberty to make whatever use of them we choose. Mr. Withers commences by giving a translation of the *Lettre sur le Robinier*, &c., of M. François de Neufchâteau, (12mo, Paris, 1803,) before-mentioned; and abstracts from the *Pièces relatives à la Culture et aux Usages de cet Arbre*, which M. François had appended to his work. He then gives extracts from the writings of MM. F. C. Medicus and André Michaux on the subject; and, next, notices on the acacia by British writers. These form the first part of his work. The second consists of original communications, comprising various letters from noblemen and gentlemen in different parts of the country, who have planted the locust, who have large trees of it, or who have applied it to different purposes. The facts collected in this part of the work are confirmatory of the rapid growth of the tree in favourable soils and situations; and of the suitableness and durability of its timber for trenails, posts, and fencing, and also for axletrees of timber carriages; but they afford no evidence either of the tree producing a great bulk of timber, or of its timber being applicable to the general purposes of construction. Only one of the writers mentions acacia boards or planks; and, though some of them recommend the wood for hop-poles, there is no evidence given of the length of time that these poles will last. Some useful experiments, by different contributors, are detailed, showing the rate of growth of the tree, and the strength and elasticity of the timber, which will be hereafter noticed.

In France and the south of Germany, we are informed by Baudrillart, in the *Dictionnaire des Eaux et des Forêts*, the locust was at first received with enthusiasm as an ornamental tree; but was afterwards rejected, because it was discovered that its leaves appeared late in the season, its branches were brittle, its prickles disagreeable; and, above all, that it would not bear the shears. It was for a long time almost forgotten, till after the introduction of the modern style of gardening, when a reaction in its favour took place, and it was preferred to all other trees on account of the rapidity of its growth, and was found, also, to be a useful tree, particularly for fuel. In France, Baudrillart continues, many authors have written on the locust, and most of them have greatly exaggerated its merits. Among those who have determined its real merits best, he thinks, are M. Bosc, Professor of Naturalisation in the Jardin des Plantes; M. Mallet, Conservator of Forests at Poitiers; and the younger Michaux. These authors, he continues, while they pointed out the advantages of cultivating the locust, have, at the same time, shown the evils that must arise from exaggerating its merits. Thus, he says that M. François wrote in favour of planting this tree in particular soils and situations; but others recommended it to be planted every where; and, in consequence of its not succeeding in unsuitable soils, a third class of writers recommend the planting of the tree to be discontinued altogether. As an example of want of success in cultivating the locust, he refers to the heaths of Gondreville, where the tree has been planted extensively in a white sand, in which, though the *Pinus maritima* and *sylvêstris* and the birch thrive, it failed altogether, except on the banks of ditches. M. Baudrillart mentions several other cases, in which large tracts of country have been ploughed, and sown broad-cast with locust seed; and where the seeds came up, but the plants never did any good, owing to the lightness and sterility of the soil. Even in the Bois de Boulogne, where locust trees, when planted

among masses of other trees, grew rapidly for five or six years, far exceeding in height the birch, the perfumed cherry, the chestnut, the yew, and the common sallow, planted with them, they disappeared entirely after a certain number of years; the other trees mentioned having become more vigorous, and choked them. Locusts, not planted among masses of other trees, but by themselves, in a single row, exposed to the air on every side, succeed much better; because it is found from experience that they require a great deal of light and air for their leaves and branches, and a great deal of surface soil for their widely spreading creeping roots. M. Mallet had no better success in the Forest of Mareuil, in the department of Vienne, where the soil is moist and aquatic; nor in the Forest of Chatellerault, where it is dry and sandy. M. Baudrillart concludes by repeating what Michaux has stated; viz. that it is only in a favourable climate, and in a good soil, that the tree attains a great size, even in its native country. In France, and particularly in the neighbourhood of Paris, the tree is seldom seen of a greater height than 50 ft. or 60 ft. In Germany, the tree thrives in the middle states, attaining a considerable height even at Berlin and Munich. In Sweden and Denmark, in favourable situations, it seems to grow nearly as high as it does in France.

In America, the locust has been planted here and there about farm-houses, and along fences; and, since the forests were in a great measure destroyed in the war of independence, many persons have cultivated the tree for its timber, and have supplied trenails, from the larger trees, to the shipwrights of New York. These plantations seldom exceed the extent of 20 or 30 acres in one place, though several agricultural societies have offered premiums for their encouragement. Though the locust tree, in its natural habitats, has never been known to be attacked by any insect, yet, about the beginning of the present century, the plantations of this tree in the United States were generally attacked by a winged insect, which deposited its eggs in the bark; and the caterpillars produced from them penetrated into the centre of the trunk of the tree, mining it in every direction, so that the trunk became completely perforated, and was easily broken over by the wind. In consequence of the discouragement given by this circumstance to planting the locust in America, and the constant consumption in that country of the timber afforded by the indigenous trees, Michaux thinks that the time may come when the locust tree will be more abundant in Europe than in America. This insect is probably the *Cossus robinia* of Peck. (See Kirby and Spence's *Introduction to Entomology*, vol. iii. p. 223.) It does not appear, that, in America, a rich soil injures the tree, as has been alleged by Gov. Pownall (see p. 615); for Michaux says that, where it attains the largest size, and produces the best timber, in Kentucky and West Tennessee, the land, when cleared, will yield from 30 to 60 bushels of maize an acre, for several years in succession, without manure. In America, on the same land where the oak, the hickory, the beech, the chestnut, and the elm attain a large size, the locust does not exceed 40 ft. or 45 ft. in height. This speaks volumes against its value for general cultivation as a timber tree.

Properties and Uses. A cubic foot of locust wood, newly cut, weighs 63 lb. 3 oz.; half-dry, 56 lb. 4 oz.; and, when quite dry, only 48 lb. 4 oz. According to M. Hartig, its value for fuel, when compared with that of the beech, is as 12 to 15. For duration, this author places it immediately after the oak, before the larch and the Scotch pine. According to Barlow (*Withers's Treatise*, p. 256.), the strength of acacia timber, as compared with fine English oak, is as 1867 to 1672; the strength of ash being as 2026; beech, 1556; elm, 1013; Riga fir, 1108; Madeira larch, 1000; Norway spar (spruce fir), 1474; and teak, 2462. From some experiments made at Brest in 1823, and communicated by Dr. Bowring to Mr. Withers, the weight of acacia was found to be one sixth greater than that of oak; its strength as 1427 to 820; and its elasticity as 21 to 9. By experiments made in the yard of the Royal Naval College, communicated to Mr. Withers by Dr. Inman (*Treatise*, p. 265.), it appears that the lateral strength of the acacia in resisting fracture is greater than that of the oak in the proportion of 1 to 0.75. From all these experiments, how-

ever different the results, it may safely be concluded, that sound acacia wood is heavier, harder, stronger, more rigid, more elastic, and tougher, than that of the best English oak; and, consequently, that it is more fit than oak for trenails. The late Lord King, who had some large locust trees on his estate at Ockham Court, gives the following opinion of the strength and durability of the timber. He says, "It endures as posts longer than oak or any other wood, except yew; but it is not as well known that it never breaks to any strain: I can give you an instance in proof of this. We are in the habit of using a machine called, with us, the *hoisters*, for bringing home large trees without any other tackle. The axletree is always made of the best ash; and yet mine never lasted more than two years, without being broken with the strain of lifting trees from the ground, occasioned by the sudden force when the pole turns over. About 25 years ago, my carpenter put in an acacia axle, which lasted 11 years, and then was as sound as it was the first day; but, as the wheels were worn out, the carpenter thought it best to put in another acacia axle, as some of the pin-holes were a little worn; and I believe that axletree now remains in use." (*Withers's Treatise*, p. 283.) At Goodwood, in Sussex, there are a great many acacia trees in the plantations, which were planted in the days of Collinson and Miller. The timber has been chiefly used for out-door fences; and, after standing 30 years, is yet perfectly sound. It is there considered much superior to the oak, for its strength and durability. (*Ibid.*, p. 290.) At Cheam, in Surrey, on the estate of A. Palmer, Esq., there are acacia posts which have stood 30 years, and are quite sound; and trees which, after having been 14 years planted, are large enough for making such posts. (*Ibid.*, p. 289.) In the various communications to Mr. Withers, there is no evidence of the durability of the locust as hop-poles, notwithstanding all that Cobbett has said on the subject. One writer speaks of trying the young trees in that capacity; and another says that he found that the locust, when about the size of a stake, did not possess more durability than stakes of the oak or the beech, of the same dimensions. The sap-wood of the acacia, this writer adds, appears to be equally as rapid in decay as that of the oak. (*Ibid.*, p. 249.) The truth is, as Lord King and Lord Stanhope observe to Mr. Withers (*Ibid.*, 591. and 292.), the acacia is a branchy-headed tree, both when young and old; and is neither calculated to produce straight poles in the former state, nor much timber in the latter.

In America, according to Michaux, the greatest consumption of locust wood is for posts; which, if the tree is felled in winter, when the circulation of the sap is suspended, and the posts are allowed to become perfectly dry before they are set, are estimated to last 40 years. This duration, however, varies exceedingly, according to the soil and situation in which the trees have grown; those having the heart-wood red lasting twice as long as those in which it is white. Michaux has remarked that, if the trunks of the locust trees grown in the north of Pennsylvania exceed 15 in. in diameter, when they are cut down and split open, they are frequently found to be decayed at the heart; but that this is not the case with trees that have grown farther south: which shows that poor soil and a cold climate are not sufficient, as Governor Pownall seems to allege (see p. 615.), to make the tree produce good timber. The American shipwrights use as much locust wood as they can procure; finding it as durable as the live oak, and the red cedar; with the advantage of being stronger than the former, and lighter than the latter. It is difficult, however, to procure locust wood of sufficient size for ship-building; for, even in those districts where the tree thrives best, nine tenths of the trunks do not exceed 1 ft. in diameter, and from 30 ft. to 40 ft. in height. The wood is used for trenails in all the seaports of the middle states, to the exclusion of every other kind of timber. Instead of decaying, it acquires an extraordinary degree of hardness with time. In 1819, these trenails were 10 dollars a thousand at Philadelphia; and from 50,000 to 100,000 of them were annually exported to England.

Mr. B. Couch, late timber and store receiver at Plymouth Dockyard, writing to Mr. Withers in January, 1834, says, "I recollect that, about 30 years since, certain ship-owners in Scotland, considering that locust trenails were very durable, with great lateral strength, were in the habit of sending to the United States for a supply. I have reason to think that, in consequence of my mentioning the circumstance to a gentleman high in office, they have been contracted for and employed in the [English government] dockyards, where they have attained a very high character." He adds, "I speak of locusts the growth of the United States. I have had no experience, neither have I obtained any intelligence, respecting locusts the growth of England." (*Withers's Treatise*, p. 302.) Sir Robert Seppings also bears witness to the "excellent properties of the locust tree for the trenails of ships," which, he says, "have long been known and appreciated by the people of this country." (*Ibid.*, p. 267.) Writing to Mr. Withers in June, 1829, from the Navy Office, he observes, "We have for the last two or three years imported a considerable number of locust trenails from America." (*Ibid.*, p. 268.)

In civil architecture, in America, the locust is chiefly used for sills and wall-plates. The sills of doors, and the wooden framing of the half timber houses, which are placed immediately on the ground, are found to last longer, when made of locust wood, than those made from any other tree, except the red mulberry (*Morus rubra*). Michaux states that the locust wood is not employed in America for staves and hoops, or for making hedges, as it has been asserted to be by some writers; but that it has been extensively used by cabinet-makers; and that it is substituted by turners and toy-makers for the box. These are all the uses of the wood of the locust tree in America.

In France, it has been extensively cultivated in the Gironde, in cospes, which are cut at the age of 4 years for props to vines; and these props are found to last more than 20 years. Old trees, in the same district, are pollarded, and their heads cut off every third year, for the same purpose. The great inconvenience attending these props is in the prickles with which they are armed; but this may be avoided by the use of either of the strong-growing thornless varieties, viz. R. P. *inermis* and R. P. *spectabilis*. In Paris, many small articles are made of the wood; such as salt-cellars, sugar-basins, spoons, forks, paper-knives, &c. Michaux observes that the locust should never be grown in a poor soil, for any other purpose than for vine-props or fuel; for both which uses the plants, he says, should be cut over every fourth year. Even in that case, he adds, they will, in a few years, cease to grow vigorously; and will ultimately prove less profitable, on such soils, than the common birch.

Italy, and the southern departments of France, Michaux considers the countries where the greatest advantages may be expected from the rapid growth of the locust. In good soils, in such climates, at the end of 20 or 25 years, he says that a mass of wood may be obtained from the locust, twice as great as from any other species of tree. In Lombardy, the wood of this tree is used for many rural purposes. Young plants of it were formerly much employed in forming hedges; but this is now abandoned, because the tree was found to impoverish the soil; and, as it grew old, it lost its prickles; besides, from being continually pruned to keep it low, the hedge becomes thin and open at bottom, and the plants end in being little more than mere stumps. (See *Gard. Mag.*, vol. xi. p. 642.)

In countries with an agriculture in which clovers and root crops do not enter into the rotation, the leaves of the locust may form a substitute for these articles as provender for cattle. When the tree is cultivated for this purpose, it ought either to be treated like the furze, and mown every year; or the trees allowed to grow to the height of 8 ft. or 10 ft., and kept as pollards, the branches being cut off every other year. This cutting should take place in the middle of summer, at which time the branches can be dried for use during winter; and one or two shoots should be left on the tree to keep up vegetation, which shoots must be cut off during the following winter. In France, the green shoots, when cut off, are immediately tied up in little bundles; and, after

being exposed to the air for 7 or 8 days to dry, they are taken home, and put in a barn or into a rick, between layers of straw, to which they communicate their fragrance and sugary taste. When the shoots are to be eaten green, none are taken but those of the same season; because in them the prickles are herbaceous, and, consequently, do not injure the mouths of the animals. The roots of the locust are very sweet, and afford an extract which might supply the place of that obtained from liquorice roots; the entire plant is also said to afford a yellow dye. The flowers have been employed medicinally as antispasmodics, and to form an agreeable and refreshing syrup, which is drunk with water to quench thirst. M. François says he never drank any thing to be compared to a liquor distilled from locust flowers in St. Domingo. These flowers, he adds, retain their perfume when dried; and those of a single tree are sufficient to give a scent resembling that of orange blossoms to a whole garden.

As an ornamental tree, when full-grown, according to Gilpin, the acacia is an elegant, and often a very beautiful, object; whether it feathers to the ground, as it sometimes does, or is adorned with a light foliage hanging from the shoots: but its beauty, he adds, is frail; and "it is of all trees the least able to endure the blast. In some sheltered spot, it may ornament a garden; but it is by no means qualified to adorn a country. Its wood is of so brittle a texture, especially when it is encumbered with a weight of foliage, that you can never depend upon its aid in filling up the part you wish. The branch you admire to-day may be demolished to-morrow. The misfortune is, the acacia is not one of those grand objects, like the oak, whose dignity is often increased by ruin. It depends on its beauty, rather than on its grandeur, which is a quality more liable to injury. I may add, however, in its favour, that, if it be easily injured, it repairs the injury more quickly than any other tree. Few trees make so rapid a growth." (*Gilpin's Forest Scenery*, i. p. 72.)

On the whole, it would appear, that, in Britain, the locust is only calculated for favourable climates and good soils; and that, when grown in these with a view to profit as timber, it should be cut down at the end of 30 or 40 years. Perhaps it may prove more profitable as a copse wood, for producing fencing stuff, or fuel: but, even for these purposes, we feel confident that it cannot be grown for many years together, with advantage, on the same soil. We do not think it at all suitable for hop-poles; because, even when crowded together in nursery lines, it cannot be got to grow straight, and it almost always loses its main shoot: besides, if it did grow straight, there is no evidence to prove that stakes made from young locust trees, and used for hop-poles, are more durable than stakes of the ash, chestnut, or any other tree. It is worthy of notice, that Cobbett, apparently without ever having seen a hop-pole made of locust, boldly affirms that the tree is admirably adapted for that purpose; that trees from his nursery, after being 4 years planted on Lord Radnor's estate at Coleshill, were "fit for hop-poles, that will last in that capacity for 20 or 30 years at the least" (*Woodlands*, § 380.); that such poles are worth a shilling each (that is, nearly double what was at that time the price of good ash hop-poles); that 5 acres would thus, in 5 years, produce 529*l.*; and that each stump, left after the pole was cut down, would send up 2 or 3 poles for the next crop; which, being cut down in their turn, at the end of another 5 years, would, of course, produce two or three times the above sum"! (§ 382.); that locust wood is "absolutely indestructible by the powers of earth, air, and water;" and that "no man in America will pretend to say that he ever saw a bit of it in a decayed state." (*Ibid.*, § 328.) After this, it will not be wondered at that Cobbett should call the locust "the tree of trees," and that he should eulogise it in the following passage, which is so characteristic of the man, and so well exemplifies the kind of quackery in which he dealt, that we quote it entire:—"The time will come," he observes, "and it will not be very distant, when the locust tree will be more common in England than the oak; when a man would be thought mad if he used anything but locust in the making of sills, posts, gates, joists, feet for rick-stands, stocks

and axletrees for wheels, hop-poles, pales, or for any thing where there is liability to rot. This time will not be distant, seeing that the locust grows so fast. The next race of children but one, that is to say, those who will be born 60 years hence, will think that locust trees have always been the most numerous trees in England; and some curious writer of a century or two hence will tell his readers that, wonderful as it may seem, 'the locust was hardly known in England until about the year 1823, when the nation was introduced to a knowledge of it by William Cobbett.' What he will say of me besides, I do not know; but I know that he will say this of me. I enter upon this account, therefore, knowing that I am writing for centuries and centuries to come." (*Ibid.*, § 351.) The absurdity of the above passage renders it almost unworthy of comment; but we may remark that, even supposing all that Cobbett says in it of the application of the locust were true, the uses which he has enumerated do not amount to a hundredth part of those to which timber is applied in this country. Hence, were his predictions to be verified, and were the locust to become more prevalent than the oak, we should find its wood a miserable substitute, in the construction of ships and houses, for that of our ordinary timber trees. Every experienced planter or timber owner, both in Europe and America, has felt this; and this is the true reason why the tree never has been, and never will be, extensively planted.

There can be no doubt as to the durability of full-grown or matured locust wood, and of its fitness for posts, trenails, &c.; but there is no evidence, either in Mr. Cobbett's *Woodlands*, or in all that was printed in Mr. Withers's *Treatise*, when he kindly lent us the proof sheets, in April, 1836, that the locust is suitable for hop-poles, either in point of rapid growth, or of durability. In order to procure the latest information on this subject, we wrote to three individuals in the centre of hop countries, and to the Earl of Radnor, Robert Rich, Esq., Philip James Case, Esq., and some others, whose letters to Mr. Withers in favour of the locust are printed in his book. The general result of the whole is, that the locust has scarcely been tried for hop-poles; and that, where it has been put to this or analogous uses, it has failed. On Lord Radnor's estate, at Coleshill, his bailiff, the Daniel Palmer so often mentioned by Cobbett, says, "the acacias were tried here for espalier stakes, and soon decayed; none have been applied for poles or gate posts. Those planted on light land soon got stunted, but some of those in deep land grew well. I am of opinion they are not good for much until they get of a good size, and, of course, are full of heart, then they will last a long time as posts, &c." This, the reader will recollect, is Mr. Palmer's opinion, after an experience of 12 years; the locust trees at Coleshill having been planted in 1823 and 1824. We applied, for information on the subject, also to the Bishop of Winchester, as residing at Farnham, in the centre of a hop country; and, through His Lordship's kindness, we have received a letter from a gentleman, who states that the Messrs. Payne were the only hop-growers, at Farnham, who planted the locust with a view to the production of hop-poles. That the poles were not fit to cut till the trees had been planted 7 years; and that they have now been only used 2 years, so that Messrs. Payne cannot speak as to their durability. Maidstone being so celebrated for its hop plantations, we wrote to Messrs. Bunyard, nurserymen there; and from them we learn that the locust is considered with them too brittle for poles, and that it has not even been tried near Maidstone in that capacity, having been only used for supporting raspberries. Mr. Masters, the nurseryman, at Canterbury, informs us that the locust was planted in that neighbourhood by various hop-growers; that almost the whole of the plants were eaten by the rabbits; that some of the trees which had escaped were tried as poles, and not found more durable than other woods; that the stools did not throw up shoots nearly so well as those of other trees; and that the locust is now no longer thought of by the hop-growers near Canterbury. The other letters which we have received on the subject are to the same effect; though some of the writers are still great

admirers of Cobbett, and appear very reluctant to give any evidence that may impugn his statements. Most of them will be found included in an article entitled, "Results of a Correspondence to ascertain the Durability of Locust Hop-poles," in the 12th volume of the *Gardener's Magazine*.

The locust, though it may be grown as copse-wood, for being cut over every 5 or more years, or in a close wood, for being cut down or rooted up, at the end of 30 or 40 years, for its timber, can never be grown for undergrowth under any circumstances, for it will not endure the shade and drip of other trees. As an ornamental tree, it well deserves a place in every park, lawn, or shrubbery; but not in any quantity, because it is not calculated to produce effect in masses, but rather singly, in rows, or in small groups.

Poetical and Legendary Allusions. Perhaps no tree possesses more materials for poetry than the locust, and yet has been less noticed by poets. The poetical ideas connected with it arise from its being, when planted in shrubberies, the favourite resort of the nightingale, which probably chooses it for building its nest from an instinctive feeling of the protection afforded by its thorns. (*Syl. Flor.*, vol. i. p. 40.) In its native country, we are told that the American Indians make a declaration of love, by presenting a branch of the locust tree in blossom to the object of their attachment. (*Le Langage des Fleurs*, p. 114.) This tree is less injurious than any other to plants growing under its drip, from a singularity in the habit of its pinnated leaves; the leaflets of which fold over each other in wet weather, leaving the tree apparently stripped of half its foliage. The leaflets also fold up at night; and Philips mentions an instance of a child, who had observed this peculiarity in the tree, saying that "it was not bed-time, for the acacia tree had not begun its prayers." (*Syl. Flor.*, vol. i. p. 47.)

Soil and Situation. A sandy loam, rich rather than poor, is generally allowed to be the best soil for the robinia. Lord King truly observes that it requires a good garden soil to attain any size; though Mr. Blackie of Holkham says that there are innumerable locust trees growing at Holkham, upon "inferior sandy soils, where other forest trees barely exist." He adds, however, "They, no doubt, thrive best upon good land, and so do other trees; but they are inestimable in the quality of thriving where other trees will not grow." (*Withers's Treatise*, p. 283. and 233.) Their quality of thriving on poor soils is, no doubt, owing to their power of rapidly abstracting whatever nourishment such soils may contain, by their running roots; but, for the same reason, on such soils, they would soon become stunted, and good for little as timber trees. The only trees that will thrive, and ultimately become timber, on poor shallow soils, are the resiniferous needle-leaved kinds; such as the pine, the fir, the cedar, and the larch. In rich soils, the plants will produce shoots 6 ft. or 8 ft. long, for several years after planting; while in wet or poor soils they will not produce shoots above a fourth of that length. The situation ought to be at once airy and sheltered; as the tree is not fitted for being employed in exposed places, or as a screen for protection against wind. In general, it looks best planted singly on a lawn, or in small groups in a shrubbery, or on the margin of a plantation, where it is allowed to spread out its branches freely on every side, and to assume its own peculiar shape; feathering, as Gilpin says, to the ground.

Propagation and Culture. The locust may, with difficulty, be propagated by cuttings of the branches; but with great facility by cuttings of the roots, and also by large truncheons, and by suckers, as the latter are thrown out in great numbers, and to a great distance round the trees; but, in general, the simplest and best mode is by seed, which is procured in abundance, either from America, or from trees grown in England or France. The seed is ripe in October, and, being gathered, if not sown immediately, should be kept in the pods till the following spring. When sown in the autumn or spring it comes up the following summer; and the plants, at the end of the season, will be fit either for transplanting where they are finally to remain, or into nursery lines. The seeds, if exposed to the air, as we have already observed,

will not retain their vegetative properties for more than 2 years; but, if they are kept in the pod, and buried to a great depth in dry soil, they will remain good for 5 or 6 years, or perhaps longer. As seed-bearing trees seldom produce two abundant crops in succession, a reserve should be kept from one year to another. It is allowed, both in France and Britain, that the best seeds are those which are obtained from America. According to Miller, editor of the *Journal des Forêts*, M. Roland, sen., a distinguished French agriculturist, finds that American seed germinates best when sown late in the year. (*Withers's Treatise*, p. 280.) Cobbett recommends steeping the seeds before they are sown, by pouring boiling water on them, and stirring them about in it for an hour or more, till they swell. Probably, it may be worth while to steep the seeds, in some cases, in cold or tepid water, especially if the season should be far advanced; but pouring water upon them in a boiling state ought to be done with great caution; and boiling them, as Cobbett says (§ 383.) Judge Mitchell, in Long Island, advised him to do, is what no rational man would ever attempt, as even a short continuation in water, at the temperature of 212° , must, of course, destroy the vital principle. An experiment, by the author of the *Domestic Gardener's Manual*, is related in *Withers's Treatise* (p. 308.), by the results of which it appears, that "immersion in hot water accelerates germination, but tends to destroy or injure the seeds." In a future page (see App. II. to Leguminææ) it will be seen, that steeping Australia and Cape acacia seeds for 24 hours, in water which had been poured on them in a boiling state, or nearly so, accelerated their germination nearly 2 years.

The seeds should be sown in good free soil, rich rather than otherwise, an inch or two apart every way, and covered with light soil from a quarter to half an inch deep. In fine seasons, the plants will be from 2 ft. to 4 ft. high by the following autumn; the largest may then be removed to where they are finally to remain, and the others transplanted into nursery lines. In regard to the future removal of the locust, it may be observed, that it will transplant at almost any age, and with fewer roots than almost any other tree.

Accidents and Diseases. The liability of the branches to be broken off by high winds has been already mentioned; and also the American insect which perforates the wood of planted trees in that country. (See p. 618.) In Britain, the tree is not particularly liable to be attacked by any insect, or by any disease, either in its foliage or in its wood; though snails are said to devour the bark when the tree is young. Hares and rabbits, according to Mr. Blackie and others, in Mr. Withers's *Treatise*, also devour the bark of the locust, which they prefer to that of any other tree whatever; and cattle, it is well known, are exceedingly fond of browsing on its leaves. In a strong clay or moist soil, the wood of old trees is often found rotten at the heart.

Statistics. Robinia Pseud-Acacia in the Neighbourhood of London. At Syon, 81 ft. high, diameter of the trunk, at 1 ft. from the ground, 3 ft. 4 in., and of the head 57 ft., in loam on gravel. At Ham House, 50 ft. high, diameter of the trunk 3 ft. 6 in., and of the head 36 ft., in light loam on gravel. At York House, Twickenham, 50 years planted, 60 ft. high, diameter of the trunk 2½ ft., and that of the head 40 ft., in sandy loam on clay. At Kenwood, 80 years planted, 45 ft. high, diameter of the trunk 3 ft. 6 in., and of the head 38 ft., in sandy gravel, on clay and gravel. At Charlton House, a number of trees, from 60 ft. to 70 ft. high, with trunks from 2 ft. 10 in. to 3 ft. 6 in. in diameter.

Robinia Pseud-Acacia South of London. In Devonshire, at Kenton, 38 years planted, and 70 ft. high. In Hampshire, at Southampton, 50 years planted, and 70 ft. high; at Testwood, 12 years planted, and 58 ft. high. In Somersetshire, at Nethercombe, 11 years planted, and 36 ft. high, the diameter of the trunk 10 in., and of the head 18 ft. In Surrey, at Bagshot Park, 16 years planted, and 30 ft. high, the diameter of the trunk 12 in., and of the head 18 ft.; at Claremont, 70 ft. high, diameter of the trunk 4 ft., and of the head 50 ft., in sandy loam, on sand and gravel; at Ockham Court, a tree, 80 years old, has a trunk 2 ft. 8 in. in diameter, at a foot from the ground. In Sussex, at Goodwood, there are numerous trees, from 50 ft. to 60 ft. high, with trunks from 18 in. to 2 ft. in diameter; at Sandon Place, 90 years planted, and 75 ft. high, the diameter of the trunk 3 ft. 6 in., and of the head 51 ft. In Wiltshire, at Wardour Castle, 50 years planted, and 60 ft. high, diameter of the trunk 2 ft. 5 in., and of the head 54 ft., in loam, on clay, in a sheltered situation; at Longford Castle, 50 ft. high, diameter of the trunk 2 ft. and of the head 30 ft., in light loam on gravel, in an exposed situation. In the Isle of Jersey, in Saunders's Nursery, 10 years planted, and 30 ft. high.

Robinia Pseud-Acacia North of London. In Bedfordshire, at Amptill, 55 years planted, and 36 ft. high, diam. of the trunk 2½ ft., and of the head 44 ft., in loam on gravel, in an open situation. In Wiltshire, at Fonthill, 22 years planted, and 40 ft. high, diam. of the trunk 2 ft., and of the head 33 ft. In Cheshire, at Cholmondeley, 60 ft. high, diameter of the trunk 3 ft., in loam on

sand; at Eaton Hall, 7 years planted, and 22 ft. high. In Durham, at Southend, 18 years planted, and 31 ft. high. In Herefordshire, at Eastnor Castle, 12 years planted, and 20 ft. high, in unprepared soil on dry limestone. In Lancashire, at Latham House, 14 years planted, and 35 ft. high, in loam on sand. In Leicestershire, at Elvaston Castle, 35 years planted, and 43 ft. high. In Norfolk, in Mackay's Nursery, Norwich, 50 years planted, and 50 ft. high, diameter of the trunk 2 ft., and of the head 36 ft., in light soil on sand. In Oxfordshire, in the Oxford Botanic Garden, 60 ft. high, diameter of the trunk 2 ft. 3 in., and of the head 33 ft., in light loam on a shallow stratum of yellowish clay: the head is regular, and the trunk straight and free from branches to the height of from 20 ft. to 30 ft. In Radnorshire, at Maeslaugh Castle, 36 ft. high. In Staffordshire, in Teddesley Park, 40 years planted, and 28 ft. high; at Trentham, 45 ft. high. In Suffolk, at Great Livmere, 40 years planted, and 53 ft. high, diameter of the trunk 3 ft., and of the head 50 ft., in loose gravel, and in a situation somewhat sheltered; at Ampton Hall, 12 years planted, and 24 ft. high; at Finborough Hall, 70 years planted, and 70 ft. high, diameter of the trunk 2 ft. 8 in., and of the head 48 ft., in light loam on clay. In Warwickshire, at Messrs Pope's Nursery, near Birmingham, 10 years planted, and 16 ft. high. In Worcestershire, at Croome, 50 years planted, and 60 ft. high, diameter of the trunk 2 ft. 18 in., and of the head 50 ft., with a clear trunk of 20 ft. In Yorkshire, at Knedlington, 10 years from the seed, from 26 ft. to 28 ft. high, the diameter of the trunk from 6 in. to 1 in., and of the head 18 ft.; also, at the same place, trees, 8 years from the seed, 23 ft. high, diameter of the trunk from 4 in. to 5 in., and of the head 10 ft. These trees were raised by Mr. Cobbett, in his nursery at Kensington, and sent to Knedlington at the age of one year; so that they have attained the large sizes mentioned after having been respectively 9 years and 7 years planted. The soil in which they grow is a sandy loam on clay or sand, and it was trenched, a short time previously to their being planted, to the depth of 3 ft. (See *Gard. Mag.*, vol. xi. p. 251.)

Robinia Pseud-Acacia in the Environs of Edinburgh. At Hopetoun House, 30 ft. high. At Dalhousie Castle, 50 years planted, and 30 ft. high. At Gosford House, 30 years planted, and 30 ft. high. At Cramond House, 40 ft. high, in deep free red soil, in the kitchen-garden, the trunk nearly 2 ft. in diameter. At Grange House, above 30 ft. high. In Lawson's Nursery, 10 years planted, and 15 ft. high. "The finest group of trees that we know of," Sir T. D. Lauder observes, "is at Niddrie Mareschal, near Edinburgh. One of them measures 9 ft. round, at 3 in. above the ground: it divides into two great limbs, which are respectively 5 ft. 4 in. and 4 ft. 4 in. in girth. A second tree in the same group, at 3 in. from the ground, measures 6 ft. 5 in. round, and its three limbs measure respectively 3 ft. 3 in., 3 ft. 7 in., and 3 ft. 1 in.; and a third acacia measures 6 ft. 3 in. in girth, at 3 ft. from the ground." (*Lauder's Gilpin*, l. p. 144.)

Robinia Pseud-Acacia South of Edinburgh. In Ayrshire, at Kilkerran, 130 years planted, and 45 ft. high, diameter of the trunk 2 ft. 1 in., and of the head 60 ft.; at Rozelle, 50 ft. high, diameter of the trunk 2 ft. 3 in., and of the head 33 ft., in light sand on bog earth. In Kirkcudbrightshire, at St. Mary's Isle, 50 years, planted, and 46 ft. high, diameter of the trunk 2 ft., and of the head 42 ft., in a sandy soil on a stratum of sea shells. In Renfrewshire, at Erskine House, 50 ft. high. In Lanarkshire, in the Glasgow Botanic Garden, 12 years planted, and 22 ft. high. In Tweeddale, at Dawick, there is a tree "which measures 5 ft. 10 in. in girth, at 3 ft. from the ground, and 6 ft. 6 in. close to the ground." (*Lauder's Gilpin*, i. p. 144.)

Robinia Pseud-Acacia North of Edinburgh. In Aberdeenshire, at Thainston, the plant produces shoots 4 ft. in length in fine seasons; but they are almost always killed back in winter to within a few inches from the ground. In Angusshire, at Kinnaird Castle, 10 years planted, and 15 ft. high. In Argyllshire, at Toward Castle, 10 years planted, and 16 ft. high. In Banffshire, at Gordon Castle, 10 years planted, and 17 ft. high. In Clackmannanshire, in the garden of the Dollar Institution, 14 years planted, and 20 ft. high. In Perthshire, at Kinfauns Castle, 10 years planted, and 12 ft. high. In Rosshire, at Brahan Castle, 50 years planted, and 20 ft. high. In Stirlingshire, at Airthrey Castle, 43 years planted, and 62 ft. high, diameter of the trunk 2 ft., and of the head 30 ft., in light loam on gravel, and in a sheltered situation.

Robinia Pseud-Acacia in the Environs of Dublin. At Cypress Grove, 60 ft. high, diameter of the trunk 22 in., and of the head 30 ft. At Terenure, 20 years planted, and 25 ft. high, diameter of the trunk 6½ in., and of the head 9 ft.

Robinia Pseud-Acacia South of Dublin. In King's County, at Charleville Forest, 35 years planted and 50 ft. high, diameter of the trunk 2 ft. 6 in., and of the head 33 ft. In Wicklow, at Shelton Abbey, 50 years planted, and 65 ft. high, the trunk 2 ft. 1 in. in diameter.

Robinia Pseud-Acacia North of Dublin. In Downshire, at Ballyleady, 25 years planted, and 35 ft. high, trunk 9 in. in diameter, and the head 30 ft.; at Mount Stewart, 25 years planted, and 40 ft. high, the trunk 1 ft. in diameter, and the head 23 ft.

Robinia Pseud-Acacia in France. At Paris, in the Jardin des Plantes, the remains of the parent tree (planted by Vespasian Robin) 78 ft. high. At Villers, 20 years planted, and 60 ft. high. At Toulon, in the Botanic Garden, 50 years planted, and 60 ft. high. At Barres, 14 years planted, and 33 ft. high. At Nantes, in the nursery of M. De Nerières, 60 years planted, and 50 ft. high. At Metz, in the garden of the Baron Charles De Tschoudi, 60 years planted, and 60 ft. high.

Robinia Pseud-Acacia in Holland and the Netherlands. At Ghent, in the Botanic Garden, between 50 ft. and 60 ft. high. At Brussels, in the park at Lücken, 50 ft. high. In the Botanic Garden at Leyden, the remains of an old tree, 30 ft. high.

Robinia Pseud-Acacia in Germany. In Hanover, at Schwöbber, the remains of an old tree, which has been 120 years planted. In Saxony, at Wörlitz, 64 years planted, and 60 ft. high. In Austria, at Vienna, in the University Botanic Garden, 8 years planted, and 18 ft. high; in the park, at Laxenburg, 16 years planted, and 18 ft. high; at Kopenzel, 20 years planted, and 30 ft. high; in Rosenthal's Nursery 20 years planted, and 40 ft. high. In Prussia, at Berlin, in the Botanic Garden, 10 years planted, and 15 ft. high; at Sans Souci, 50 years planted, and 50 ft. high; in the Pfauen Insel, 40 years planted, and 50 ft. high. In Bavaria, at Munich, in the Botanic Garden, 24 years planted, and 40 ft. high.

Robinia Pseud-Acacia in Denmark, Sweden, and Russia. At Dronengard, near Copenhagen, 40 years planted, and 60 ft. high. In Sweden, at Lund, 56 ft. high, diameter of the trunk, 18 in., and of the head 30 ft. In Russia, at Moscow, the tree does not attain any considerable size, but it thrives in the Crimea, according to Desemet, in all its varieties. "A hedge of acacia is planted upon the foundations of the Palace of Yalomensk, in the neighbourhood of Moscow, in such a manner as to indicate the plan of the building. This palace was built by Peter the Great, and at a short distance from it is a tree, surrounded by a table and benches, under which young Peter received his lessons." (*Leitch Ritchie's Journey to St. Petersburg and Moscow*, 1836, p. 243.)

Robinia Pseud-Acacia in Switzerland and Italy. At Geneva, in the Botanic Garden, 30 ft. high; at Boudigny, and in the grounds of many villas in the environs of the city, from 50 ft. to 70 ft.

high. In Lombardy, in the palace gardens at Monza, there is a noble tree, only 29 years planted which is 75 ft. high, diameter of the trunk 2 ft., and of the head 40 ft.

Statistics of the Varieties.—*R. P. inermis.* In England, in Cheshire, at Eaton Hall, 4 years planted and 15 ft. high. In Ireland, at Cullenswood Nursery, 30 years planted, and 50 ft. high, diameter of the trunk 2 ft., and of the head 48 ft.

R. P. umbraculifera. In England, at the Duke of Devonshire's Villa at Chiswick, are the oldest specimens in the neighbourhood of London: they are grafted from 6 ft. to 8 ft. high on the species; and, after being about 15 years planted, have pendulous parasol-like heads, from 8 ft. to 12 ft. in diameter, and from 3 ft. to 5 ft. in height; a plant, in the garden of the Horticultural Society, grafted within 1 ft. of the ground, forms a bush 10 ft. high, and 12 ft. in diameter. In France, particularly in the neighbourhood of Paris, there are many fine specimens. In Austria, in the University Botanic Garden at Vienna, a plant, 25 years planted, is 20 ft. high. We have received the dimensions of many other specimens of this variety from different parts of Germany; but, as they all seem to have increased at about the same rate of growth, and none to have attained a greater height than 20 ft., we consider it unnecessary to enumerate them.

R. P. tortuosa. In England, in the garden of the London Horticultural Society, 10 years planted, and 15 ft. high; in the arboretum of the Messrs. Loddiges, in 1830, 20 ft. high, since cut down; in Sussex, at West Dean, 8 years planted, and 17 ft. high; in Cheshire, at Eaton Hall, 12 years planted, and 18 ft. high; in Essex, at Hylands, 10 years planted, and 20 ft. high; in Hertfordshire, at Cheshunt, 6 years planted, and 13 ft. high; in Staffordshire, at Alton Towers, 10 years planted, and 16 ft. high; at Trentham, 6 years planted, and 8 ft. high; in Suffolk, in the Bury Botanic Garden, 6 years planted, and 7 ft. high. In the Isle of Jersey, in Saunders's Nursery, 10 years planted, and 18 ft. high. In France, at Villers, 10 years planted, and 18 ft. high. In Austria, in the University Botanic Garden at Vienna, 20 years planted, and 30 ft. high; at Luxemburg, 20 years planted, and 10 ft. high; at Hadersdorf, 12 years planted, and 18 ft. high. In Hanover, at Harbücke, 8 years planted, and 10 ft. high.

R. P. sphaerifolia. In England, in the garden of the Horticultural Society, in 1834, 10 years planted, and 20 ft. high; in the arboretum of Messrs. Loddiges, in 1830, 10 years planted, and 27 ft. high; in Devonshire, at Kenton, 35 ft. high. In Scotland, in Haddingtonshire, at Tynningham, 73 years planted, and 33 ft. high. In France, at Rouen, in the Botanic Garden, 10 years planted, and 25 ft. high. In Austria, in the University Botanic Garden at Vienna, 35 years planted, and 36 ft. high. In Bavaria, at Munich, in the Botanic Garden, it has been 12 years planted, but is generally killed back every year to the ground.

R. P. amorphifolia. In England, in the garden of the London Horticultural Society, in 1834, 10 years planted, and 27 ft. high; and about the same height in the arboretum of the Messrs. Loddiges; at Kenwood, 40 years planted, and 35 ft. high, the diameter of the trunk 20 in., and of the head 30 ft.; in Surrey, at Bagshot Park, 16 years planted, and 30 ft. high; in the Goldworth Arboretum, 4 years planted, and 12 ft. high. In Prussia, at Sans Souci, 11 years planted, and 30 ft. high; at the Pfauen Insel, 10 years planted, and 32 ft. high.

R. P. procera. In England, in the garden of the London Horticultural Society, 10 years planted, and 30 ft. high; and there was one still higher in Loddiges's arboretum in 1830; in Devonshire, at Endsleigh Cottage, 12 years planted, and 30 ft. high, diameter of the trunk, at 1 ft. from the ground, 12 in., and of the head 20 ft.

R. P. pendula. In Germany, in Austria, at Brück on the Leytha, 15 years planted, and 12 ft. high.

R. P. monstrosa. In England, in the garden of the London Horticultural Society, in 1834, 10 years planted, and 12 ft. high; and about the same height in Loddiges's arboretum in 1830; in Sussex, at West Dean, 14 years planted, and 32 ft. high.

R. P. macrophylla. In England, in the garden of the London Horticultural Society, in 1834, 10 years planted, and 35 ft. high; and it was about the same height in the arboretum of Messrs. Loddiges in 1830; in Sussex, at West Dean, 14 years planted, and 27 ft. high; in Suffolk, at Ampton Hall, 13 years planted, and 34 ft. high; in Staffordshire, at Trentham, 6 years planted, and 13 ft. high.

R. P. microphylla. In England, this variety grows as rapidly as the species; and there are handsome trees of it in the garden of the London Horticultural Society, upwards of 30 ft. high. In Austria, at Vienna, in Rosenthal's Nursery, 16 years planted, and 15 ft. high; at Brück on the Leytha, 25 years planted, and 12 ft. high.

R. P. spectabilis. In France, at Villers, 10 years planted, and 36 ft. high.

Commercial Statistics. In London, plants of the species are 15s. a thousand for seedlings, and 40s. a thousand for transplanted plants, from 3 ft. to 4 ft. high; American seeds, 5s. per lb., and European seeds, 2s. per lb. Plants of the varieties are 1s. 6d. each, with the exception of *R. P. umbraculifera*; plants of which, grafted standard high, are from 5s. to 7s. each. At Bollwyller, transplanted plants of the species are 50 cents each; and of the different varieties, from 1 franc to 2 francs each. *R. P. pendula*, and *R. P. umbraculifera* are 2 francs each. At New York plants of the species are from 12 cents to 37½ cents each, according to their size; and of the varieties, from 37½ cents to 50 cents. Seeds were, in 1825, 2 dollars per lb., probably on account of the great demand created for them in England by the writings of Mr. Cobbett: at present they are 3s. 6d. per lb.

‡ 2. *R. [P.] viscosa* Vent. The clammy-barked Robinia.

Identification. Vent. Hort. Cels., t. 4.; Michaux, 2. p. 131.; N. Du Ham., 2. t. 17.; Dec. Prod., 2. p. 262.; Don's Mill., 2. p. 258.

Synonymes. *R. glutinosa* Curt. Bot. Mag., 560.; *R. montana* Bartram; the Rose-flowering Locust. *Engravings.* Vent. Hort. Cels., t. 4.; N. Du Ham., 2. t. 17.; Curt. Bot. Mag., t. 560., as *R. glutinosa*; our fig. 306.; and the plate in our Second Volume.

Spec. Char., &c. Branches and legumes glandular and clammy. Racemes crowded, erect. Bractees concave, deciduous, each ending in a long bristle.

The 3 lower teeth of the calyx acuminate. Roots creeping. (*Dec. Prod.*, ii. p. 262.) This kind of robinia is a native of South Carolina and Georgia, near rivers. It usually grows to the height of 30 ft. or 40 ft., and was introduced in 1797. The flowers are scentless, and are generally of a pale pink, mixed with white; though there are varieties, or, perhaps, only variations arising from difference of soil, with the flowers of a pale purple or violet colour. The bark, particularly that of the young shoots, which is of a dull red, is covered with a clammy substance, which, when touched, sticks to the fingers. In every other respect, this tree strongly resembles the common *R. Pseud-Acacia*, of which we believe it to be only a variety; though so distinct, from the clamminess of its bark, and the colour and want of scent in its flowers, that we have kept it apart. The clammy matter exuded from the bark of the young shoots is said to have been examined by Vauquelin, and found to be a new vegetable substance. In England, we have observed that this clamminess differs much in different trees, and in some is almost wanting.



Properties and Uses, &c. This tree, being of less magnitude and duration than the common locust, arrives sooner at perfection, and, consequently comes sooner into bloom. It also flowers a second time in some seasons, both in its native country and in England. As its flowers are large, and conspicuous from their colour, the tree well deserves a place in every ornamental plantation. The wood resembles that of the common locust; but the tree, even when full grown, is seldom found with a trunk above 10 in. or 1 ft. in diameter. In all other respects but those which have been mentioned, the tree is, and may be, treated like the common locust.

Statistics. In the neighbourhood of London, there are no very large trees; those in the Horticultural Society's Garden, and in the arboretum of the Messrs. Loddiges, being only about 30 ft. high. The rate of growth, in different situations and circumstances, is nearly the same as that of *R. Pseud-Acacia*, for the first 5 or 6 years. In Surrey, at Bagshot Park, 20 years planted, it is 20 ft. high; at St. Anne's Hill, 30 years planted, it is 33 ft. high; in Sussex, at West Dean, 14 years planted, it is 31 ft. high; in Berkshire, at White Knights, 34 years planted, it is 33 ft. high, the diameter of the trunk 9 in., and of the head 24 ft.; in Cheshire, at Eaton Hall, 12 years planted, it is 18 ft. high; in Worcestershire, at Croome, 30 years planted, it is 45 ft. high. In Scotland, at Perth, in the Perth Nursery, 35 years planted, it is 30 ft. high, diameter of the trunk 11 in., and of the head 22 ft. In Ireland, in the Glasnevin Garden, 20 years planted, and 24 ft. high, diameter of the trunk 8 in., and of the head 14 ft.

Commercial Statistics. Plants, in London, are from 1s. to 1s. 6d., and American seeds are 1s. an oz.; at Bollwyller, plants are from 1 franc to 1 franc 50 cents each; at New York, 37½ cents a plant.

‡ 3. *R. DU'BIA* Fouc. The doubtful Robinia, or False Acacia.

Identification. Fouc. in *Desv. Journ. Bot.*, 4, p. 204, but not of Poir.; *Dec. Prod.*, 2, p. 261.; Don's *Mill.*, 2, p. 238.

Synonymes. *R. hybrida Audub.*; *R. ambigua Poir. Suppl.*, 4, p. 690.; and, perhaps, *R. chinata Mill. Dict.*, No. 2.; *R. intermedia Soutange-Bodin* in *Ann. d'Hort. de Paris*, 2, p. 43.

Spec. Char., &c. Spines very short. Branches, petioles, peduncles, and calyxes furnished with a few glands, rarely clammy. Leaflets ovate. Racemes loose and pendulous. Bractees concave, caducous, ending each in a long bristle. Flowers sweet-scented, pale rose-coloured. The pods, according to Miller, are thickly beset with short prickles. (*Don's Mill.*, ii. p. 238.) This kind is said to be a hybrid between *R. Pseud-Acacia* and *R. viscosa*.

‡ 4. *R. HISPIDA* Lin. The hispid Robinia, or Rose Acacia.

Identification. Lin. *Mant.*, 101.; *Mill. Ic.*, t. 244.; *Curt. Bot. Mag.*; *Dec. Prod.*, 2, p. 262.; Don's *Mill.*, 2, p. 238.

Synonymes. *R. rosea N. Du Ham.*, 1, t. 18.; *R. montana Bartr. Voy.*, 2, p. 128.; *Æschynomene hispida Roxb.*

Engravings. *Mill. Ic.*, t. 244.; *Curt. Bot. Mag.*, 311.; *N. Du Ham.*, 1, t. 18., as *R. rosea*; and our *fig.* 307.

Spec. Char., &c. Spines wanting. Leaflets obovate. Branches and legumes hispid. Racemes loose; the 3 lower teeth of the calyx acuminate. (*Dec. Prod.*, ii. p. 262.) A shrub, or low tree, growing, in its native country (Carolina), to the height of 6 ft. or 8 ft. according to Marshall, and as high

as 20 ft. according to other authors. It was introduced into British gardens in 1758, and produces its large and beautiful dark rose-coloured flowers in June, often continuing in flower till October.

Varieties.

- ✱ *R. h. 2 nana* Dec. Prod., ii. p. 262., is a plant hardly a foot high, which is a native of pine woods in Carolina.
- ✱ *R. h. 3 rosea* Pursh has the leaflets, for the most part, alternate, and the branches smoothish. In its native habitats, on the high mountains of Virginia and Carolina, it grows, according to Pursh, to a considerable shrub; whereas the species is a low straggling plant. (*Fl. Amer. Sept.*, ii. p. 488.)
- ✱ *R. h. 4 macrophylla* Dec., *R. grandiflora* Hort., figured in our Second Volume, has the leaflets large, and ovate-roundish; and the branches and peduncles glabrous, and without prickles.

307



Description, &c. The species, and the different varieties, are shrubs, or low trees, with tortuous and very brittle branches; and leaves and flowers nearly twice the size of those of *Robinia Pseud-Acacia*. They form singularly ornamental shrubs for gardens; but, as standards or bushes, they can be only planted with safety in the most sheltered situations. A very good mode is, to train them against an espalier rail; and, on a lawn, this espalier may form some kind of regular or symmetrical figure: for example, the ground plan of the espalier may be the letters S or X, or a cross, or a star; which last is, perhaps, the best form of all, the different radii of the star diminishing to a point at the top. Such a star, in order to produce an immediate effect, would require to have three plants placed close together in the centre, from which the branches should be trained outwards and upwards. *R. hispida* is often grafted about 1 ft. above the surface of the ground; and, when the plant is not trained to a wall, or to some kind of support, it is almost certain, after it has grown 2 or 3 years, to be broken over at the graft. A preferable mode, therefore, for dwarfs, is to graft them on the root, or under the surface of the soil. In purchasing plants, this ought always to be borne in mind. In consequence of the liability of this shrub to be injured by the weather, it is comparatively neglected in British gardens; but, wherever a magnificent display of fine flowers is an object, it better deserves a wall than many other species; and it is worthy of being associated there with *Piptanthus nepalensis*, *Wistaria sinensis*, and other splendid Leguminææ. When grafted standard high, and trained to a wire parasol-like frame, supported on a rod, or post, 6 ft. or 8 ft. high, few plants are equal to it in point of brilliant display. At White Knights, there is a wall of some length covered with trellis-work, over which this species is trained; and the flowers hanging down from the roof present a fine appearance; though, as in the case of the covered walks of *laburnum* at White Knights, and at West Dean, the flowers are of a much paler hue than when fully exposed to the light and air.

Statistics. In England, in the neighbourhood of London, are various plants, from 6 ft. to 10 ft. or 12 ft. high; in Sussex, at Kidbrooke, there is one 15 ft. high; in Buckinghamshire, at Temple House, one, 12 years planted, is 20 ft. high; in Suffolk, in the Bury Botanic Garden, 12 years planted, and 13 ft. high, against a wall; in Worcestershire, at Croome, 30 years planted, 15 ft. high; in Cumberland, at Ponsonby Hall, 12 ft. high.—In Scotland, at Danbristell Park, 16 ft. high; in Aberdeenshire, at Thainston, it barely exists, even against a wall; in Argyllshire, at Hafton, 6 years planted, it is 9 ft. high; in Perthshire, at Kinfauns Castle, 8 years planted, it is 5 ft. high; in Forfarshire, at Airley Castle, it is 12 ft. high, against a wall.—In Ireland, in the Glasnevin Botanic Garden, 12 years planted, it is only 4 ft. high; but the diameter of the trunk is 4 in., and of the head 9 ft.; in Galway, at Coole, it is 7 ft. high.

Commercial Statistics. Plants, in the London nurseries, of the species, and all the varieties, are 1s. 6d. each, except *R. h. macrophylla*, which is 2s. 6d.; at Bollwyller, the species and varieties are all 1 franc 50 cents each; at New York, plants of the species are 37½ cents each.

GENUS XIII.



CARAGANA Lam. THE CARAGANA, OR SIBERIAN PEA TREE.
Lin. Syst. Diadélphia Decándria.

Identification. Lam. Dict., 1. p. 611., and Ill., t. 607. f. 1, 2.; Dec. Prod., 2. p. 268.; Don's Mill., 2. p. 243.

Synonyme. *Robinia* sp. *L.*

Derivation. *Caragan* is the name of *C. arboréscens* among the Mongul Tartars.

Description, &c. Trees or shrubs, natives of Siberia and of the East; their leaves abruptly pinnate, the leaflets mucronate, and the petioles either with a bristly or a spiny point; their flowers axillary, each on a distinct pedicel, usually several together, pale yellow, except in *C. jubata*, in which they are white tinged with red; their stipules usually become spines. (*Dec. Prod.*, ii. p. 268.) They are all ornamental or curious. Some of them, being natives of Siberia, like most other Siberian plants, vegetate early in spring; and their delicate pinnated foliage, of a yellowish green, independently altogether of their flowers, makes a fine appearance about the middle of April; or, in mild seasons, even as early as the middle of March. The flowers, which are of a bright yellow, appear about the end of April, in the earliest Siberian species; and those which flower latest are also latest in coming into leaf. Thus, in a group consisting of the different species of this genus, in the climate of London, some plants may be seen, in the month of May, covered with leaves and flowers; and others in which the buds have just begun to expand. The yellow colour prevails in every part of the plants of this genus, even to the roots; and, were it not that this colour is so abundant in common productions of the vegetable kingdom, there can be no doubt that the caragana would afford a yellow dye. The larger sorts are easily propagated by seeds, or cuttings of the root, and the more curious by grafting on *C. arboréscens*. The dwarf and pendulous-growing species, when grafted standard high on *C. arboréscens*, form very singular trees; and, though such trees cannot be recommended for general introduction into gardens or pleasure-grounds (for no kind of impression sooner fatigues the mind than that produced by excessive singularity), yet the occasional introduction of what is singular or unique, among what is natural or general, produces, by contrast, a striking effect; interrupts the ordinary train of impressions; and recalls the mind of the spectator from the beauties of nature to those of art.

♯ 1. *C. ARBORE'SCENS* Lam. The arborescent Caragana, or Siberian Pea Tree.

Identification. Lam. Dict., 1. p. 615.; Dec. Prod., 2. p. 268.; Don's Mill., 2. p. 243.

Synonyms. *Robinia Caragana* Lin. Sp., 1044., N. Du Ham., 2. t. 19., Pall. Fl. Ross., 1. t. 42.; *Caragana sibirica* Ray; fausse Acacie de Sibérie, Robinie de Sibérie, Arbre aux Pois des Russes, Fr.; Sibirische Erbsenbaum, Ger.; Gorochoik, Russ.

Engravings. N. Du Ham., 2. t. 19.; Pall. Fl. Ross., 1. t. 42., middle figure; and our plate of this species in our Volume II.

Spec. Char., &c. Leaves with 4—6 pairs of oval-oblong villous leaflets. Petiole unarmed. Stipules spinescent. Pedicels in fascicles. (*Don's Mill.*, ii. p. 243.)

Variety.

♯ *C. a. 2 inermis* Hort. has the branches without spines. There are plants of this variety in the Horticultural Society's Garden, and in the arboretum of Messrs. Loddiges.

Description, &c. A low tree, a native of Siberia, found in woods, and upon the banks of rivers. In the latter situation, Pallas informs us, it grows to the height of 18 ft. or more; but in arid places it is only a small shrub; in the latter state, forming, as we think, the varieties *C. (a.) Altagana*, and *C. (a.) microphýlla*. *C. arboréscens* forms an erect stiff tree, with numerous upright-

growing branches. The flowers are axillary, one on a pedicel; the pods are oblong-taper, and each contains 3 or 4 seeds. The wood is hard, compact, and very tough; yellow on the outside; and within, waved and striped with red, and with reddish brown. The bark is also very tough, and it is used as a substitute for ropes or cords, as the twigs are for withs. The seeds are stated by Pallas to be good food for poultry, and the leaves excellent fodder for cattle; they are also said to contain a blue colouring matter, like indigo. The species was introduced into Britain in 1752, and is not uncommon in British collections. The largest plant in the neighbourhood of London is at Syon, where it is 18 ft. high. In Ireland, in the Glasnevin Botanic Garden, is one, 20 years planted, which is 24 ft. high; the diameter of the trunk, at 1 ft. from the ground, is 7 in., and of the head, which is roundish and compact, 12 ft. In British nurseries, it is generally propagated by seeds, which are produced freely. The price of plants, in the London nurseries, is 50s. a hundred, or 1s. each; at Bollwyller, 50 cents each.

■ 2. *C. (A.) ALTAGANA* Poir. The Altagana Caragana, or Siberian Pea Tree.

Identification. Poir. Suppl., 2. p. 89.; Dec. Prod., 2. p. 268.; Don's Mill., 2. p. 243.

Synonymes. *Robinia Altägana* Pall. Fl. Ross., t. 42., L'Hérit. Stirp., t. 76.; *Caragana microphylla* Lam. Dict., 1. p. 615.

Derivation. *Altägana* is the name of the shrub in Siberia.

Engravings. Pall. Fl. Ross., t. 42., under the name of *Robinia Altägana*; L'Hérit. Stirp., t. 76.; and our fig. 308.

Spec. Char., &c. Leaves having 6 or 8 pairs of glabrous, obovate-roundish, retuse leaflets. Petiole unarmed. Stipules spinose. Pedicels solitary. Legumes rather compressed. (*Don's Mill.*, ii. p. 243.) A shrub, growing to the height of 3 ft. or 4 ft. in arid plains in Siberia, and probably only a variety of *C. arborëscens*. It was so considered by Pallas; and by others it has been confounded with *C. microphylla*, also, as we think, only a variety. It was introduced into England in 1789, and is not uncommon in British collections. It is usually propagated by grafting on *C. arborëscens*. Price of plants, in the London nurseries, 2s. 6d. each; and at Bollwyller, 1 franc.



■ 3. *C. (A.) MICROPHYLLA* Dec. The small-leaved Caragana, or Siberian Pea Tree.

Identification. Dec. Prod., 2. p. 268.; Don's Mill., 2. p. 243.

Synonymes. *Robinia microphylla* Pall. Fl. Ross., t. 42., f. 1. 2.; *Caragana Altägana* var., Poir. Suppl., 2. p. 89.

Engraving. Pall. Fl. Ross., t. 32., f. 1, 2., under the name of *Robinia microphylla*.

Spec. Char., &c. Leaves with 6—7 pairs of hoary retuse leaflets. Petioles and stipules rather spinose at the apex. Root creeping. (*Don's Mill.*, ii. p. 243.) A native of Siberia, and found in the desert of Baraba, and in other arid places. It was introduced into England in 1819, and differs very little from *C. Altägana*; it, like that plant, being doubtless only a variety of *C. arborëscens*.

■ 4. *C. (A.) REDOWSKI* Dec. Redowski's Caragana, or Siberian Pea Tree.

Identification. Dec. Légum., t. 11.; Don's Mill., 2. p. 243.

Engraving. Dec. Légum., t. 11., f. 45.

Spec. Char., &c. Leaves with two pairs of ovate, acute, smooth leaflets. Stipules spinose. Flowers yellow. (*Don's Mill.*, ii. p. 243.) A shrub, of which there are several specimens in the Horticultural Society's Garden, of the height of 4 ft. or 5 ft. It is a native of Siberia; and the plants referred to were raised from seeds received from Dr. Fischer of Petersburg, about 1820. In general appearance and habit of growth, it resembles *C. Altägana*, of which it is probably only a variety.

Variety.

- ✻ *C. (A.) R. 2 præcox* Fisch. only differs from *C. Redowski* in coming into flower earlier. The specimen in the Horticultural Society's Garden was in full leaf, and in flower, on April 30. 1836, when *C. frutescens* and *C. arborescens* had not a single leaf expanded.

✻ 5. *C. (A.) ARENARIA* *Donn and Sims.* The Sand Caragana.

Identification. Donn Hort. Cant.; Sims Bot. Mag., t. 1886.

Engravings. Sims Bot. Mag., t. 1886; and our fig. 309.

Spec. Char., &c. Leaves with, usually, 4 or more pairs of obovate leaflets. Pedicels usually twin, and shorter than the flowers. Stipules subulate. Flowers yellow. (*Don's Mill.*, ii. p. 243.) A low shrub, a native of Siberia; introduced in 1802; flowering in April and May; and, as we think, only another variety of *C. arborescens*. It ripens seeds in England, but is generally propagated by grafting; and the price, in the London nurseries, is the same as for *C. Altagana*.



✻ 6. *C. FRUTESCENS* *Dec.* The shrubby Caragana.

Identification. Dec. Prod., 2. p. 268.; Don's Mill., 2. p. 843.

Synonymes. *Robinia frutescens* *Lin. Sp.*, 1044., *Pall. Fl. Ross.*, t. 43.; *C. digitata* *Lam. Dict.*, l. p. 616.

Engravings. Swt. Fl.-Gard., t. 227.; *Pall. Fl. Ross.*, t. 43., as *Robinia frutescens*; and our fig. 310.

Spec. Char., &c. Leaves having 2 pairs of leaflets, which approximate near the top of the petiole: they are obovate-cuneate. Stipules membranous. Petiole furnished with a short spine at the apex. Pedicels solitary, twice the length of the calyx. Flowers yellow, resupinate. Leaves with a yellow hue. (*Don's Mill.*, ii. p. 243.)

Varieties. De Candolle mentions two forms of this species viz.:

- ✻ *C. f. 1 latifolia*, which has glabrous broadly obovate leaflets, and is frequent in gardens; there being a subvariety, with 2-flowered peduncles; and
- ✻ *C. f. 2 angustifolia*, which has glabrous oblong cuneate leaflets, and is found near Odessa (*Dec. Prod.*, ii. p. 268.)



Description, &c. The species is a shrub, a native of Russia, on the banks of the Wolga and other rivers. In open situations, according to Pallas, it does not exceed 5 ft. in height; but in woods and gardens it grows as high as 9 ft. or 10 ft., flowering in May, along with *Cytisus purpureus*. In British gardens, it is generally raised from layers, or by grafting, and is frequently found as high as 6 ft. or 8 ft. It was introduced in 1752, and is frequent in European gardens. Price of plants, in the London nurseries, 2s. 6d. each; at Bollwyller, 1 franc 50 cents.

✻ 7. *C. (F.) MO'LLIS* *Bess.* The soft Caragana.

Identification. Bess. Enum. Pl. Volh., p. 29.; Don's Mill., 2. p. 243.

Synonymes. *Robinia mollis* *Bieb. Fl. Taur. Suppl.*, 477.; *Robinia tomentosa* *Fisch. Hort. Gortch.*, 1818; *Caragana frutescens* var. *mollis* *Dec. Prod.*, 2. p. 268.

Spec. Char., &c. Leaves with 2 pairs of oblong, cuneate, approximate leaflets, near the tip of the petiole, clothed with soft hair. Petiole ending in a short spine. Pedicels solitary. Flowers yellow. (*Dec. Prod.*, ii. p. 268.) A shrub, a native of Tauria and Podolia, where it grows to the height of 2 ft. or 3 ft., and produces its yellow flowers in April and May. It was introduced in 1818, but is not common in collections.

✻ 8. *C. PYGMÆA* *Dec.* The pygmy Caragana.

Identification. Dec. Prod., 2. p. 268.; Don's Mill., 2. p. 243.

Synonymes. *Robinia pygmæa* *Lin. Sp.*, 1044., *Pall. Fl. Ross.*, 1. t. 45., *Amm. Ruth.*, t. 35.

Engravings. *Pall. Fl. Ross.*, 1. t. 45.; *Amm. Ruth.*, t. 35., as *Robinia pygmæa*; and our fig. 311

Spec. Char., &c. Leaves with 2 pairs of linear, glabrous, approximate leaflets near the tip of the petiole, which is very short. Stipules and petioles spinescent. Pedicels solitary, and nearly the length of the calyx. Calyx nearly equal at the base. Leaflets acute, crowded, usually in the axils of trifid spines. Flowers yellow. (*Dec. Prod.*, ii. p. 268.)

Variety.

- α *C. p. 2 arenaria* Fisch. in Litt. has linear-cuneate leaflets, and pedicels rather longer than the calyx.

Description, &c. A low shrub, scarcely a span high, on the Altaic Mountains, but growing much higher in favourable situations. It has large trifid spines, slender leaves, and small flowers. The leaflets are remarkable for being in fours, disposed in the form of a star, in the axils of the spines. The young shoots are of a fine yellow, very tough, and fit for being used as withs. Pallas says that, in favourable situations, this shrub attains the height of 6 ft.; but, in British gardens, it is seldom seen above 4 ft. high, except when grafted as a standard on *C. arborescens*, when it forms a small tree of very singular appearance. It was cultivated by Miller in 1751, and is not unfrequent in British gardens. It is generally propagated by suckers, or by grafting. Plants, in the London nurseries, are 2s. 6d., or, grafted standard high, 7s. each; and at Bollwyller, 1 franc 50 cents.

9. *C. SPINOSA* Dec. The spiny Caragana.

Identification. Dec. Prod., 2. p. 269.; Lindl. Bot. Reg., 1021.; Don's Mill., 2. p. 243.
Synonymes. *Robinia spinosa* Lin. Mant., 269.; *Robinia ferox* Pall. Fl. Ross., 1. t. 44., Itin., t. E. e. f. 2. and 3.; *Robinia spinosissima* Laxm. Nov. Act. Pet., 15. t. 30. f. 4.; *Caragana ferox* Lam. Dict., 1. p. 315.
Engravings. Lindl. Bot. Reg., t. 1021.; Pall. Fl. Ross., 1. t. 44.; Itin., t. E. e. f. 2. and 3., as *Robinia ferox*; Laxm. Nov. Act. Pet., 15. t. 3. f. 4., as *Robinia spinosissima*; and our figs. 312. and 313.

Spec. Char., &c. Leaves with 2—4 pairs of cuneate-linear glabrous leaflets. Stipules small, spinose.

Adult petioles permanent, strong, and spinose, twice the length of the leaflets. Flowers solitary, almost sessile, and of a bright yellow. Legume rather compressed. (*Don's Mill.*, ii. p. 243.) A spiny shrub, abounding in gravelly arid situations in Siberia, and also said to be plentiful in China, about Peking, where branches of it are stuck in clay upon the tops of the walls, in order that its spines may prevent persons from getting over them. (*Pall. Fl. Ross.*, i. f. 44.) In British gardens, into which it was introduced in 1755, this species grows to the height of 3 ft. or 4 ft.; and flowers in April and May.

It is propagated by seeds, cuttings, or grafting; and plants, in London, are from 1s. 6d. to 2s. 6d. each.

10. *C. TRAGACANTHOIDES* Poir. The Goat's-thorn-like Caragana.

Identification. Poir. Suppl., 2. p. 90.; Dec. Prod., 2. p. 269.; Don's Mill., 2. p. 244.
Synonymes. *Robinia tragacanthoides* Pall. Nov. Act. Pet., 13. t. 7., Astr., 115. t. 86.; *Robinia macracantha* Lodd. Cat.
Engravings. Pall. Nov. Act. Pet., 10. t. 7.; Astr., 115. t. 86.

Spec. Char., &c. Leaves with 2—4 pairs of oblong-lanceolate silky leaflets, ending in a little spine. Stipules spinescent. Adult petioles permanent, strong, and spinose, twice the length of the leaflets. Pedicels solitary, short. Legume hoary-villous. (*Don's Mill.*, ii. p. 244.) A low spiny shrub, a native of Siberia, among granite rocks. Introduced in 1816, and producing its yellow drooping flowers in April and May. When grafted



311



312



313

standard high, it forms a very singular object. Plants, in the London nurseries, 2s. 6d. each, or, grafted standard high, 7s.; and at Bollwyller, 3 francs.

11. *C. JUBATA* Poir. The crested Caragana.

Identification. Poir. Suppl., 2. p. 89.; Dec. Prod., 2. p. 269.; Don's Mill., 2. p. 244.

Synonyme. Robinia jubata Pall. in Act. Pet., 10. t. 6., Astr., p. 113. t. 85., Lodd. Bot. Cab., t. 522.

Engravings. Pall. in Act. Pet., 10. t. 6.; Astr., p. 113. t. 15.; Lodd. Bot. Cab., t. 522., as Robinia jubata.

Spec. Char., &c. Leaves with 4 or 5 pairs of oblong-lanceolate lanuginously ciliated leaflets. Stipules setaceous. Petioles somewhat spinose; adult ones deflexed, filiform, permanent. Pedicels solitary, very short. Legume glabrous. Flowers few and white, suffused with red. (*Don's Mill.*, ii. p. 244.) A low shrub, seldom exceeding 18 in. in height, of a curious shaggy appearance, occasioned by the footstalks of the leaves being bristly or thorny, and remaining on long after the leaflets have dropped off. It is a native of Siberia, near Lake Baikal; and was introduced into England, by Mr. Busch, in 1796. It produces its white flowers, tinged with red, in April and May, and is increased by grafting on *Caragana arborescens*. When grafted standard high, it forms a very singular-looking object.

12. *C. GRANDIFLORA* Dec. The great-flowered Caragana.

Identification. Dec. Prod., 2. p. 268.; Don's Mill., 2. p. 243.

Synonymes. Robinia grandiflora Bieb. Fl. Taur., 1. p. 168.

Spec. Char., &c. Leaves with 2 pairs of oblong-cuneated approximate leaflets, near the tip of the petiole, which is very short. Stipules and petioles spinose. Pedicels solitary, almost the length of the calyx, which is gibbose at the base. Legume terete, acute, brown, glabrous. Flowers 1 in. long, yellow. (*Don's Mill.*, ii. p. 243.) A shrub, a native of Georgia, near Teflis, producing yellow flowers, which are 1 in. long in June and July. It was introduced in 1823, and is in the Horticultural Society's Garden.

13. *C. CHAMLAGU* Lam. The Chamlagu, or Chinese Caragana.

Identification. Lam. Dict., 1. p. 616.; Dec. Prod., 2. p. 268.; Don's Mill., 2. p. 243.

Synonyme. Robinia Chamlagu L'Hérit. Stirp., N. Du Ham.

Engravings. L'Hérit. Stirp., t. 77.; N. Du Ham. Arb., 2. t. 21., as Robinia Chamlagu; and our fig. 314.

Spec. Char., &c. Leaves with 2 pairs of distant, oval, or obovate, glabrous leaflets. Stipules spreading, and, as well as the petioles, spinose. Pedicels solitary. Flowers pendulous, large, and yellow, at length becoming reddish. Root smelling like liquorice. (*Don's Mill.*, ii. p. 243.) A diffuse smooth shrub, a native of China, growing to the height of 4 ft., with a thick root and branching stem, with grey bark. The branches are alternate; at first upright, and then decumbent. The whole plant has a singular appearance, more especially when just going out of flower. It was introduced in 1773, and is not uncommon in collections. It is generally propagated by separating the offsets, or by seeds, or it may be grafted on *C. arborescens*. Grafted on this species, especially when the stock is 10 ft. or 12 ft. high, it forms a singularly picturesque pendulous tree; beautiful not only when it is in leaf or in flower, but from the graceful lines formed by its branches, even in the midst of winter, when they are completely stripped of their leaves. Plants, in the London nurseries, are from 1s. 6d. to 2s. 6d. each, and grafted standard high, 7s. 6d.; at Bollwyller, 1 franc; and at New York, 1 dollar.

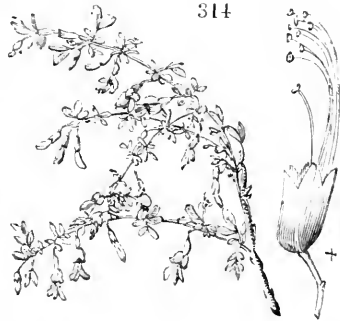

GENUS XIV.

HALIMODE'NDRON *Fisch.* THE HALIMODENDRON, or SALT TREE.
Lin. Syst. Diadélphia Decándria.

Identification. Fisch. in Litt.; Dec. Légum. Mém., 6.; Prod., 2. p. 269.; Don's Mill., 2. p. 244.
Synonyme. Halodendron Dec. Mém. ined. in Soc. Phys. Gen., March, 1824, but not of Petit Thouars.
Derivation. From *halimos*, maritime, and *dendron*, a tree; in reference to the habitat of the shrubs, which grow in dry naked salt fields by the river Irtis, in Siberia.

Description, &c. Deciduous shrubs, with silky leaves, and purplish flowers. There are only two species, one of which is probably only a variety. They are propagated by seeds, by cuttings of the roots, or by grafting on the common laburnum, or on the *Caragana arboréscens*.

❖ 1. *H. ARGENTEUM* Dec. The silvery-leaved Halimodendron, or Salt Tree.

Identification. Dec. Prod., 2. p. 269.; Don's Mill., 2. p. 244.
Synonymes. Robinia Halodendron *Lin. Fil. Suppl.*, 330., *Pall. Fl. Ross.*, t. 36.; *Caragana argentea* *Lam. in Pall. Itin. cd. Gall.*, App. ii. 360., t. 83. f. 1.
Engravings. *Pall. Fl. Ross.*, t. 36.; and our fig. 315.

Spec. Char., &c. Leaves hoary. Peduncles 2-flowered. (*Don's Mill.*, ii. p. 244.)

Varieties. De Candolle mentions two forms of this species.

- ❖ *H. a. 1 vulgare* Dec. Prod., ii. p. 269. — Leaves hoary or silvery. Standard the same length as the keel. (*Sims Bot. Mag.*, t. 1016.)
- ❖ *H. a. 2 brachysena* Dec. Prod. ii. p. 269. — Leaves hoary or silvery. Standard one half shorter than the wings and keel. Style short.

Description, &c. An irregular, much branched, rigid shrub, with a strigose grey bark, and leaves clothed with a whitish silky down. The flowers are numerous, resembling those of *Láthyrus tuberósus*, both in colour and size; and they smell sweet. It is a native of Siberia, in saline steppes, near the river Irtis; and, according to Pallas, it is much frequented by insects, especially of the genus *Méloe L.*, many species of which are peculiar to that region. It was introduced into Britain in 1779, by Dr. Pitcairn; and, according to Martyn's *Miller*, though it flourished in British gardens, it seldom, if ever, flowered there, "probably for want of the saline principle in the soil." It has been argued by some, that the halimodendron, and other trees which grow naturally in saline soils, should be supplied with sea salt in a state of culture: but, though this may be useful in some cases, experience proves that it is altogether unnecessary in others; and this is confirmed by the success with which the species before us is cultivated in British gardens. At present, it flowers freely from May to July, and, in moist seasons, later; and, when grafted standard high on the common laburnum, it forms one of the most graceful drooping trees that can adorn a lawn. There is a fine specimen of this tree in the Hammersmith Nursery, as there are of most species of *Caragana*, and of *Calóphaca wolgárica*. Price, in the London nurseries, from 1s. to 2s. 6d., grafted standard high, 7s. 6d.; at Bollwyller, 1 franc 50 cents; and at New York, 1 dollar.



❖ 2. *H. (A.) SUBVIRESCENS* Don. The greenish Halimodendron, or Salt Tree.

Identification. Don's Mill., 2. p. 244.
Synonymes. Robinia triflora *L'Hérit. Stirp. Nov.*, 162.; *H. argenteum* β *subviréscens* Dec. Prod., 2. p. 169.

Spec. Char., &c. Leaves greenish. The standard of the same length as that of the keel. Pedicels 3-flowered. (*Don's Mill.*, ii. p. 244.) A shrub, like the preceding one, of which it is, without doubt, only a variety.

GENUS XV.



CALOPHACA Fisch. THE CALOPHACA. *Lin. Syst. Diadélphia Decándria.*

Identification. Fisch. ined.; Dec. Prod., 2. p. 270.

Derivation. From *kalos*, beautiful, and *phakē*, a lentil; in allusion to the beauty of the plant, and to its being one of the leguminaceous kind.

Description, &c. There is only one species, which is a deciduous shrub, a native of Siberia.

♣ 1. *C. WOLGARICA* Fisch. THE Wolga Calophaca.

Identification. Fisch. in Litt.; Dec. Prod., 2. p. 270.; Don's Mill., 2. p. 244.

Synonymes. *Cytisus nigricans* Pall. *Itin.*, 3. p. 764. t. G. g. f. 3., ed. Gall. *Append.*, No. 358. t. 101. f. 1.; *Cytisus pinnatus* Pall. *Fl. Ross.*, 1. t. 47.; *Cytisus wolgaricus* *Lin. Fil. Suppl.*, 327., N. Du Ham., 1. t. 48.; *Colutea wolgarica* Lam.; *Adenocarpus wolgensis* Spreng. *Syst.*, 3. p. 226.

Engravings. Pall. *Itin.*, 3. p. 764. t. G. g. f. 3., ed. Gall., *Append.*, No. 358., t. 101. f. 1., as *Cytisus nigricans*; Pall. *Fl. Ross.*, 4. t. 47., as *Cytisus pinnatus*; N. Du Ham., 5. t. 48., as *Cytisus wolgaricus*; and our fig. 316.

Spec. Char., &c. Leaflets 6 or 7 pairs, orbicular, velvety beneath, as well as the calyxes. (*Don's Mill.*, ii. p. 244.)

Description, &c. A deciduous shrub, found in desert places near the rivers Don and Wolga, in a gravelly or sandy soil, producing its yellow flowers in June, and ripening seeds in August. It was introduced in 1786 though, being somewhat difficult to propagate except by seeds, which, however, in fine seasons, it produces in abundance, it is not so common as it ought to be in British gardens. Grafted standard high on the common laburnum, it forms an object at once singular, pictnresque, and beautiful, whether when covered with blossoms, or with its fine reddish pods. Price, in the London nurseries, 2s. 6d. each, and standard high, 7s. 6d.



GENUS XVI.



COLUTEA R. Br. THE COLUTEA, or *BLADDER SENNA.* *Lin. Syst. Diadélphia Decándria.*

Identification. R. Br. in Hort. Kew., ed. 2., vol. 4, p. 325.; Dec. Prod., 2. p. 270.; Don's Mill., 2. p. 244.

Derivation. From *kolouō*, to amputate. The shrubs are said to die if the branches are lopped off. *Koloutea* is also the name of a plant mentioned by Theophrastus.

Description, &c. Shrubs, with impari-pinnate leaves, and flowers disposed in axillary racemes that are shorter than the leaves; few in a raceme. (*Dec. Prod.*, ii. p. 270.) The flowers are yellow in most of the species, and are succeeded by bladdery legumes. Deciduous shrubs, and natives of the middle and south of Europe, the north of Africa, and Nepal. All that have hitherto been introduced into Europe are probably only varieties of one species.

♣ 1. *C. ARBORESCENS* Lin. THE arborescent Colutea, or *Bladder Senna.*

Identification. Lin. Sp., 1045.; Dec. Astr., No. 1.; Dec. Prod., 2. p. 270.; Don's Mill., 2. p. 245.

Synonymes. *C. hirsuta* Roth. *Fl. Germ.*, 1. p. 305.

Engravings. N. Du Ham., 1. t. 22.; Curt. Bot. Mag., t. 81.; and our fig. 317.

Spec. Char., &c. Leaflets elliptical, retuse. Peduncles bearing about 6 yellow flowers. Callosities of the standard short. Legumes closed. Wild in hedges and thickets in southern and middle Europe. (*Dec. Prod.*, ii. p. 270)

A rapid-growing shrub, attaining the height of 12 ft. or 14 ft. in 8 or 10 years; but, in British gardens, not of long duration. It is not uncommon in Italy; and on Mount Vesuvius is found even on the ascent to the crater, where there are scarcely any other plants. It grows wild in the warmer parts of Switzerland, and in the south of Germany, and in France; varying in magnitude according to the soil and the situation. It was introduced in 1570, and produces its yellow flowers from June to August; the flowers are succeeded by large bladder-like legumes, which, as they ripen, become of a reddish colour, and contain 15 or 20 seeds. These bladders, when pressed, explode with a crackling noise. On the Continent, the leaves have been recommended as a substitute for senna, and they are also said to afford a grateful food for cattle. The seeds, in doses of a drachm or two, are said to excite vomiting. In British gardens, the plant is chiefly valuable as a bulky fast-growing shrub, of the easiest culture, and fit for almost any situation. Price, in the London nurseries, 9*d.* each; at Bollwyller, 50 cents; and in New York, 37½ cents.



2. *C. (A.) CRUE'NTA* Ait. The bloody-flowered Colutea, or Oriental Bladder Senna.

Identification. Ait Hort. Kew., 3. p. 55; Dec. Astr., No. 3; L'Hérit. Stirp. Nov., 2. t. 41.; Don's Mill., 2. p. 245.

Synonymes. *C. orientalis* Lam. Dict., 1. p. 353, Ill., 624 f. 3., N. Du Ham., 1. t. 23.; *C. sanguinea* Pall.; *C. áptera* Schmidt Arb., t. 119.; *C. humilis* Scop.

Engravings. Lam. Dict., 1. p. 353.; Ill., 624 f. 3.; N. Du Ham., 1. t. 23.; Schmidt Arb., t. 119.; Krause, t. 105.; and our fig. 318.

Spec. Char., &c. Leaflets obovate, emarginate, glaucous. Peduncles bearing 4—5 flowers. Callosities of the standard obtuse, very small. Legumes opening at the tip. Corolla, in colour, between red and saffron-coloured, with a yellow spot at the base of the standard. (*Dec. Prod.*, ii. p. 270.) A shrub, like the former, but of smaller dimensions, and with leaflets more glaucous, and more retuse. A native of the Archipelago, Georgia, and the Levant. It was introduced into England in 1731, and produces its reddish copper-coloured flowers in June and July. Plants are common in the nurseries, and they are sold at the same prices as plants of the preceding species.



3. *C. (A.) ME'DIA* Willd. The intermediate Colutea, or Bladder Senna.

Identification. Willd. Enum., 771.; Dec. Prod., 2. p. 270.; Wats. Dend. Brit., t. 140.; Don's Mill., 2. p. 245.

Engraving. Wats. Dend. Brit., t. 140.

Spec. Char., &c. Leaflets obovate, glaucescent. Peduncles usually 6-flowered. Legumes closed at the apex. Flowers orange-coloured. (*Don's Mill.*, ii. p. 245.) A shrub, rather larger than the preceding sort, and differing from it chiefly in having orange-coloured flowers. It is, perhaps, a hybrid between the two preceding sorts.

❖ 4. *C. (A.) HALE'PPICA* Lam. The Aleppo Colutea, or Bladder Senna.

Identification. Lam. Dict., 1. p. 353.; III., t. 624. f. 2.; Dec. Astr., No. 2.; Don's Mill., 2. p. 245.

Synonymes. *C. Pocockii* Ait. Hort. Kew., 3. p. 55.; Schmidt Arb., t. 129.; *C. istria* Mill. Dict., No. 2., t. 100.; *C. procumbens* L'Hérit. Stirp. Nov., 2. t. 42.

Engravings. Schmidt Arb., t. 129.; Mill. Dict., No. 2. t. 100.; L'Hérit. Stirp. Nov., 2. t. 42.

Spec. Char., &c. Leaflets roundish elliptical, very obtuse, mucronate. Peduncles bearing 3 yellow flowers. Callosities of the standard lengthened, ascending. Legumes closed. Smaller than *C. arborëscens*. It often occurs, in middle Europe, that plants of *C. haléppica* are killed by the winter. (*Dec. Prod.*, ii. p. 270.) A shrub, growing to the height of 6 ft., and closely resembling *C. arborëscens*, of which it appears to be a variety. Price the same as that of *C. arborëscens*.

❖ 5. *C. NEPALE'NSIS* Hook. The Nepal Colutea, or Bladder Senna.

Identification. Hook. Bot. Mag., 2622.; Don's Mill., 2. p. 245.

Engravings. Hook. Bot. Mag., t. 2622.; and our fig. 319.

Spec. Char., &c. Leaflets roundish-elliptic, retuse.

Racemes drooping, few-flowered. Callosities of standard papilliform. Legumes rather coriaceous, pubescent. (*Don's Mill.*, ii. p. 245.)

A shrub, from Nepal, in 1822, producing its yellow flowers in August and September. In its native country, it grows to the height of 10 ft.; but it is not yet common in British gardens. Plants, in the Fulham Nursery, are 5s. each.

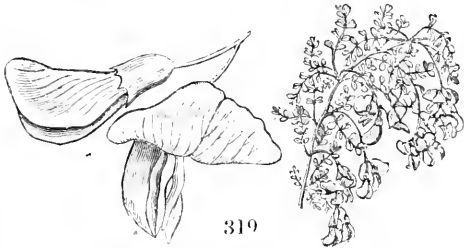

GENUS XVII.



ASTRAGALUS Dec. THE MILK VETCH. Lin. Syst. Diadélphia Decándria.

Identification. Dec. Astrag., No. 5. ed. maj. p. 22. and p. 79.; Prod., 2. p. 291.: Don's Mill., 2. p. 253.

Synonymes. *Astragalus* sp. of Lin. and others.

Derivation. From *astragalos*, the vertebra; the seeds in the legumes of some species being squeezed into a squarish form, so as to look something like the joints of the backbone; or, perhaps, from *astër*, a star, and *gala*, milk. It is also the name given to a shrub by Greek writers. (*Don's Mill.*, 2. p. 253.)

❖ 1. *A. TRAGACA'NTHA* L. The Goat's Thorn Milk Vetch, or Great Goat's Thorn.

Identification. Lin. Sp., 1073.; Pall. Astr., t. 4. f. 1, 2.; N. Du Ham., 2. t. 100.; Woodv. Med. Bot., 276. t. 98.; Wats. Dend. Brit., 84.

Synonymes. *A. massiliensis* Lam. Dict., 1. p. 320., Dec. Astr., No. 96., Don's Mill., 2. p. 266.

Engravings. Pall. Astr., t. 4. f. 1, 2.; Dub. Arb., 2. t. 100.; Woodv. Med. Bot., 276. t. 98.; Wats. Dend. Brit., t. 84.; Lob. Icon., 2. t. 27.; Garid. Aix, 469. t. 104.; and our fig. 320.

Spec. Char., &c. Peduncles usually 4-flowered, about equal in length to the leaves. Calyxes cylindrical, with 5 short blunt teeth. Leaves with 9—11 pairs of elliptic hoary leaflets. (*Don's Mill.*, i. p. 266.) The flowers are purplish or white, and are disposed on axillary peduncles, so short as to prevent them from being at all conspicuous above the leaves. A low, prickly, glaucous



shrub, with persistent leaves, seldom exceeding 1 ft. in height. After the leaflets drop off, the petioles become indurated, so as to give the plant the appearance of being densely covered with spines. It is a native of Marseilles and Narbonne, in sandy places, as well as of Corsica and Mauritania, and was introduced in 1640. It was treated by Miller as a distinct genus, under its old name of *Tragacantha*; and he describes four species; one of which was a native of Marseilles and Italy, with large white flowers, which appears to be Lamarck's *A. massiliensis*; a second, a native of Majorca and Minorca, and a third, a native of the islands of the Archipelago, also with white flowers; and a fourth, a native of Spain, with flowers of a dirty white. None of these, it would appear, are the same as the species now before us, which has decidedly purplish flowers. It is stated in Thompson's *Dispensatory*, and in books generally, that the *Astragalus Tragacantha* produces the gum tragacanth; but the accounts respecting the production of the gum by this plant are so unsatisfactory, that it is impossible to give credence to them. Tournefort says that he examined the plants which produce the gum tragacanth upon Mount Ida; and from his remarks it may be concluded that the gum is obtained from *A. Tragacantha* and *A. creticus* (fig. 321.); which last has not yet been introduced into England; but Siebuhr, in his *Voyage de Crète*, could not find any proof that the *A. creticus* produced any gum. La Billardière, who visited Mount Lebanon, says that the gum is there obtained from a species which he calls *A. gummiifer*, and that the shepherds go in search of it during night, or after a heavy dew; whereas Tournefort says that it can only be collected during the great heats of the day. On the whole, the subject of the gum appears involved in a degree of uncertainty not less than that of the species. All that we can state with certainty is, that there is a plant bearing the name of *Astragalus Tragacantha* in British gardens, and that it merits a place in collections, as a very curious little shrub. It is generally propagated by seeds, which it sometimes ripens in England, or by cuttings. It requires a dry soil, and a sunny situation.



App. i. *Other ligneous Species of Astragalus in Cultivation.*

In our *Hortus Britannicus* will be found above a dozen other species of *Astragalus*, marked as technically ligneous; but they are of such low growth, as to be much more fit for cultivating as

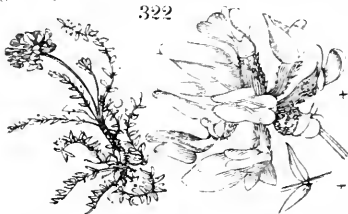

herbaceous plants, than as shrubs. If we were to admit them, we should be compelled to admit the common pink and carnation, and, indeed, all those herbaceous plants which retain their leaves during winter. On rockwork some of them may be introduced; and among these we may mention, as to be procured from Loddiges's arboretum, *A. atticus* Lodd. Cab.; *A. aristatus*

L'Herit. Stirp., 170., with yellow flowers, which is figured in Bot. Cab. t. 1278., and our fig. 322.; *A. brevifolius*, with a purplish flower, figured in Bot. Cab., t. 1388., and our fig. 323.; and *A. massiliensis* Lam., which is probably, as we have already stated, a variety of *A. Tragacantha*, with white flowers instead of purplish ones.

App. ii. *Hardy Species of Astragalus not yet introduced.*

A. aboriginum Richards in *Franklin's Journ. Append.*, p. 746. Plant suffruticose, erect. Leaves with 5 pairs of lanceolate-linear hoary-pubescent leaflets. Racemes axillary, loose, extending beyond the leaves. Native of arctic America. Flowers white or bluish. The keel decidedly blue. Roots long and yellow, like those of liquorice; and gathered in the spring, by the Cree and Stone Indians, as an article of food. (*Don's Mill.*, 2. p. 268.)

App. I. *Suffruticose hardy Species belonging to the Tribe Lòteæ.*

Dorycnium Tourn. is a genus, the species of which were included by Linnæus under *Lòtus*. They are herbs, or subshrubs, with trifoliolate leaves, and with the stipules in the same form as the leaflets. The flowers are usually numerous, in small heads, and white or pale red ; they are natives of Europe, and grow from 1 ft. to 6 ft. in height ; but, though technically they are ligneous, they are much better calculated for being treated as herbaceous plants than as shrubs. *D. suffruticosum* Vill., *Lòtus Dorycnium L.*, (*Lob. Icon.*, 2. p. 51. f. 1. and 2.) is a native of the south of Europe, with hoary leaves and shoots, and white flowers, with the keel reddish. It flowers from July to September, and has been in cultivation since 1640. *D. réctum* Ser. (*Barrel. Icon.*, t. 544.), *Lòtus réctus L.*, has pale rose-coloured flowers. *D. latifòlum* Willd. has white flowers. *D. hirsátum* Ser., *Lòtus hirsátus L.*, has larger pale red flowers. *D. tomentòsum* G. Don, *D. hirsátum* var. *incanum* Ser., has large pale rose-coloured flowers, and grows to the height of 4 ft. *D. argéntum* Delil. (*Fl. Ægypt.*, 113. t. 40.) is a native of Egypt, and has yellow flowers, streaked with bay colour.

App. II. *Half-hardy ligneous Species of Lòteæ.*

The number of half-hardy ligneous species belonging to this section is considerable : but, as they are all beautiful, and most of them natives of Australia, and not very tender, we shall notice one or two species of most of the genera ; referring the reader, for other species already in the country, to our *Hortus Britannicus* ; and, for those not yet introduced, to Don's *Miller*. All the species are of easy culture, in light sandy soil, in sand and peat, loam and peat, or sand, loam, and leaf mould ; and they are all readily propagated by cuttings in sand under a glass.

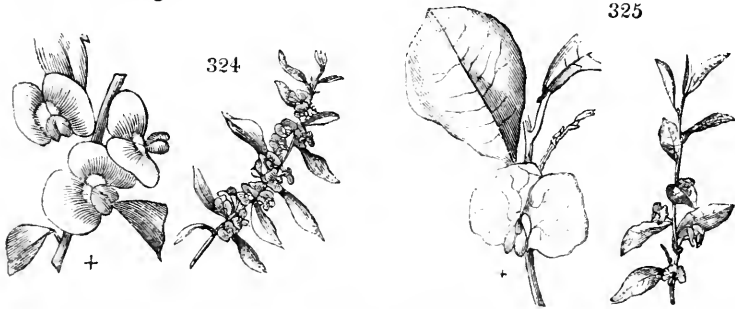

Hovea R. Br. is a very beautiful genus of New Holland shrubs, with purple or violet-coloured flowers, all of which will grow in cold-pits, or against a wall, if the frost be completely excluded. The handsomest species is considered to be

H. Celsi Bonp. (*Bot. Reg.*, 280., and our fig. 324.), a shrub, introduced in 1818, which grows to the height of 4 ft. or 5 ft. *H. latifòlia* Lodd. (*Bot. Cab.*, t. 30., and our fig. 325.) is a very fine species, with the standard of the flower blue, and the keel purple. *H. lanceolàta* Sims (*Bot. Mag.*, t. 1764.) has purplish blue flowers. One great advantage of all the species is, that they commence flowering in March, and continue profusely covered with flowers for 3 or 4 months. They are admirable conservatory plants.

Platylòbium ilicifòlium Swt. (*Fl. Austr.*, No. 2., note) is a singularly beautiful plant, known in the nurseries as *Hovea ilicifòlia* ; but it is rather difficult to cultivate. *P. chorozeamifòlium* Swt. (*Fl. Austr.*, No. 2.), the *Hovea chorozeamifòlia* of the nurseries, is a handsome little evergreen shrub, which, according to Sweet, will grow quite well in a pit, without any artificial heat.

Platylòbium Sm. is a genus of New Holland shrubs, of which four beautiful species have been introduced. *P. formòsum* Smith (*Bot. Mag.*, t. 463., and our fig. 326.) grows to the height of 4 ft., and produces its fine large yellow flowers,



tinged with red, from June to August. *P. triangulàre* R. Br. (*Bot. Mag.*, t. 1580.) is a native of Van



327

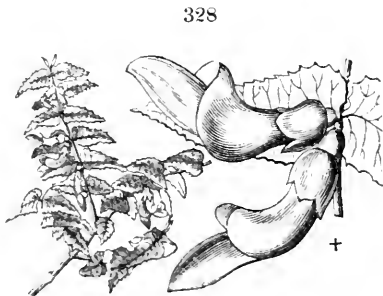

328

Diemen's Land, and, consequently, tolerably hardy. It also grows about the height of 4 ft., and produces its yellow flowers from June to September.

Bossiaea Vent. is a genus of New Holland shrubs, with compressed branches, sometimes apparently without leaves. *B. ensata* Sieb. (*Surt. Pl. Austr.*, t. 51.; the *B. rufo* of *Bot. Cab.*, t. 1119.) grows 2 ft. high, and produces its yellow flowers from April to June. *B. microphylla* Smith (*Bot. Cab.*, t. 756.) has the branches less compressed and leafy, and the flowers with the standard yellow, and red at the base, and the keel of a brownish purple. It grows to the height of 2 ft.

Goodia lotifolia Salisb. (*Bot. Mag.*, t. 953., and our fig. 327.,) is a native of Van Diemen's Land, which has been in the country since 1793. It grows to the height of 4 ft., and produces its yellow flowers, having the base of the standard red, from April to July. There are two other species, *G. pubescens* Bot. Mag., t. 1310., and *G. polysperma* Bot. Rep., t. 237.; both of which, being natives of Van Diemen's Land, are, doubtless, tolerably hardy.



329

Scittia dentata R. Br. (*Bot. Reg.*, t. 1233., and our fig. 328.) and *S. angustifolia* Bot. Reg., t. 1266., are elegant New Holland shrubs, growing to the height of 4 ft., and flowering from December to June.

Templetonia glauca Sims (*Bot. Cab.*, t. 764., *Bot. Reg.*, t. 759., and our figs. 329, 330.) and *T. retusa* R. Br. (*Bot. Mag.*, t. 2533.) are elegant New Holland shrubs, growing to the height of 3 ft., and flowering from March to June. The flowers are of a fine crimson colour.

Rufina Thunb. is an African genus, of which eleven species, natives of the Cape of Good Hope, have been described, and several have been introduced. The general appearance of these shrubs is that of *Cytisus* or *Spartium*; and they usually grow to the height of 3 ft. or 4 ft., and produce their yellow flowers in June and July. *R. triflora* Bot. Mag., t. 859., and our figs. 331, 332., will afford a fair specimen of the genus.

Fascia Dec. is a Cape genus, of which there are two species introduced: *F. amplexicaulis* Dec., and *F. rotifolia* Dec., the *Crotalaria amplexicaulis* of *Lam. Dict.*, 2. p. 194.

Borbonia L. is a Cape genus, of which 11 species have been described, and nearly half as many introduced. *B. crenata* L. (*Bot. Mag.*, t. 274.) grows to the height of 6 ft., and produces its yellow flowers, which are less villous than those of the other species of the genus, in July and August.

Achyrònia villosa Wendl. (*Hort. Herrcnh.*, 1. t. 12.) is a New Holland shrub, growing to the height of 2 ft. or 3 ft., with yellow axillary, pedicellate flowers, which appear in July and August.

Liparia sphaerica L. (*Bot. Mag.*, t. 1241.; *Bot. Cab.*, t. 642.) is a Cape shrub, with shining leaves, and flowers disposed in spherical heads, of a yellowish-brown colour, drying black. It grows to the height of 6 ft., flowering in July and August; and is a very handsome plant for a conservatory.



331



332

Pricstleya Dec. is a genus of Cape shrubs, of which 15 species are described in Don's *Miller*, and nearly half as many introduced. The species have simple, quite entire, exstipulate leaves, and yellow flowers, which are disposed either in heads, umbels, or spikes. *P. vestita* Dec. (*Bot. Mag.*, t. 2223.) grows to the height of 4 ft., and flowers in May and June.

Crotalaria is an extensive genus, of which no fewer than 143 species are described in Don's *Miller*. They are herbs, or subshrubs, with simple or palmately compound leaves, and flowers usually of a yellow colour. They are natives of Asia, Africa, and North America, chiefly herbaceous; but one or two of the Cape suffruticose species may be considered as half-hardy. *C. pulchella* Andr. (*Bot. Rep.*, t. 417.; *Bot. Mag.*, t. 1699.) is a native of the Cape of Good Hope, which grows to the height of 3 ft., and produces its large yellow flowers in July and August.

Hypocalyptus obscuratus Thunb. is a smooth shrub, with trifoliate leaves and purple flowers, a native of the Cape of Good Hope, introduced in 1823, and flowering in June and July.

Viborgia Spreng. is a Cape genus, of which 3 species have been described, and two are in cultiva-

tion. They are Cape shrubs, about 2 ft. or 3 ft. high, with trifoliolate leaves, and yellow flowers in racemes. *V. obovata* Thunb. (the *Crotalaria floribunda* of *Bot. Cab.*, t. 509., and our fig. 333.) will afford a specimen of the genus.

Loddigèsia Sims (named in honour of *Conrad Loddiges* of Hackney, to the liberality and kindness of whose sons our present work is much indebted) *oxalidifolia* Bot. Mag., t. 596., and our fig. 334, is a Cape shrub, with trifoliolate leaves and pinkish flowers, with the keel of a dark purple at the apex. It grows to the height of 3 ft., and is an elegant plant when in flower.

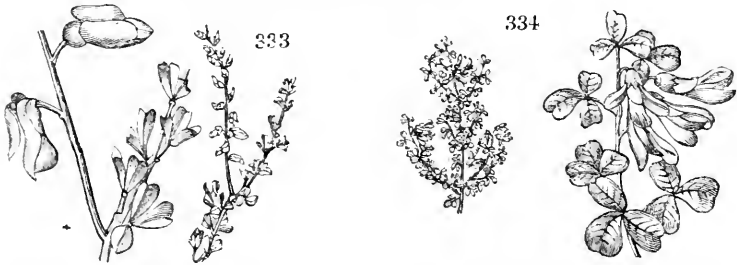

Dichilus Dec. is a Cape genus, of which 3 species have been described. They are subshrubs, growing to the height of 3 ft., with smooth trifoliolate leaves, and yellow flowers.

Lebeckia Thunb. is a Cape genus of shrubs, or subshrubs, with simple or trifoliolate leaves, with the general habit of *Genista*. Eleven species have been described, and 3 or 4 have been introduced. *L. sepiaria* Thunb., the *Spärtium sepiarium* of L., and *Pluk. Atl.*, t. 424. f. 1., was introduced in 1820, and grows to the height of 6 ft., producing its yellow flowers in April and May.

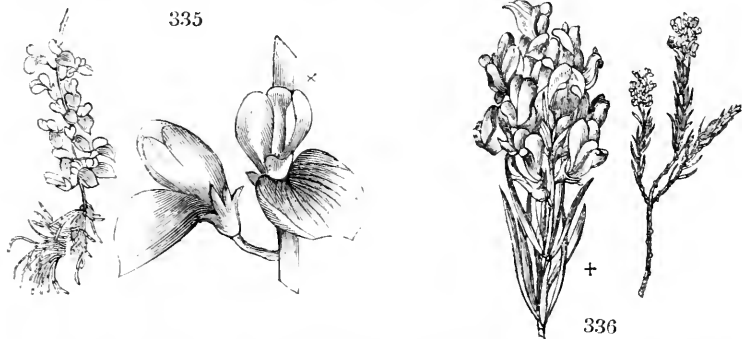

Sarcophyllum carnosum Thunb. (*Bot. Mag.*, t. 2502., and our fig. 336.) is a smooth Cape shrub, with fleshy filiform leaves, and yellow flowers, which appear from May to August.

Aspalathus L. is a genus of Cape shrubs, of which 86 species have been described in Don's *Miller*, and about that number introduced. They are almost all shrubs, or undershrubs, with leaves in fascicles, and yellow flowers furnished with bracteoles. *A. callosa* L. (*Bot. Mag.*, t. 2329., and our fig. 335.) which grows to the height of 4 ft., will serve to exemplify the genus.

Requienia Dec. is a genus of African shrubs, of which one species, *R. sphaerosperma* Dec. *Lég. Mém.*, 6. t. 38., is a Cape shrub, grows to the height of 1 ft.; but it is not yet introduced.

Anthyllis is a genus containing some undershrubs, natives of the south of Europe, which are half-hardy, and some of them neatly hardy. *A. Bivba Jovis* L. (*Bot. Mag.*, t. 1927., and our fig. 337.), the *Vulneraria Bárba Jovis Lam.*, and *Bárba Jovis argyrophylla Manch.*, is an evergreen shrub, which grows to the height of 8 ft.; a native of Spain, Barbary, the Levant, and Italy, on rocks; and it has been cultivated in frames in England since 1640. The leaves are pinnate, and the flowers pale yellow; the whole plant having a silvery appearance, whence it derives the names of Jupiter's beard, and the silver bush. The elegance of this shrub did not escape the ancients; and Pliny mentions its beauty; adding, that it dislikes water, and that it makes a very elegant ornament for gardens when clipped into a round shape. It is also mentioned by Dioscorides as good for healing wounds, by the application of its leaves. It is one of the finest shrubs that can be planted against a conservative wall. It will grow in any light soil, and is easily propagated by cuttings, or by seeds, which are sometimes ripened against a south wall.

A. cytisoides L. (*Barrcl. Icon.*, t. 1182.) a native of Spain, and the south of France, was introduced in 1731. It grows to the height of 2 ft., and forms a neat little frame shrub, almost hardy in the neighbourhood of London.

A. Hermanniæ L. (*Bot. Mag.*, t. 2376.) is a native of Corsica, Crete, and Palestine. It forms a spiny shrub, with pubescent leaves, and yellow flowers, which appear from April till July. It was introduced in 1789, and grows to the height of from 2 ft. to 3 ft. There is a plant of it which has been two years in the open border in the Kew Garden, without any protection whatever. *A. Aspalathi* Dec., *Spärtium ereticum Desf.*, (*Bot. Cab.*, t. 1169.) resembles the preceding species, and may possibly be only a variety of it.

A. crinacca L. (*Bot. Mag.*, t. 676.) grows about 1 ft. high, and has rushy branches, and bluish purple flowers.

A. *Genista* Dufour, A. *splendens* Willd., A. *indica* Lour., and A. *sericea* Lag., are species which have not yet been introduced. A. *heterophylla* L. is a procumbent species, a native of Portugal and Spain, introduced in 1768, but now, it is believed, lost.

Medicago L. is a genus chiefly consisting of herbaceous plants; but there are one or two shrubs or undershrubs belonging to it that may be considered half-hardy. The species are mostly natives of the south of Europe, the Levant, and the north of Africa. *M. arborea* L. (*N. Du Ham.*, t. 1. 44., and our fig. 338.), the lucerne en arbre of the French, is a native of Italy, where it grows to the height of 6 ft. or 8 ft., and flowers from May to November. It has been known to stand out 5 or 6 years in dry borders, without any protection, and to attain a considerable size when trained against a wall. In the Chelsea Botanic Garden there is a plant 11 ft. high, with a stem 6 in. in diameter; there is also one of considerable size in the Kew Garden; and there was formerly a large one trained against a wall in the gardens at Syon.

Melilotus arborea Castagne in Litt. (*Dec. Prod.*, 2. p. 187., *Doa's Mill.*, 2. p. 177.) is a shrub, with trifoliolate leaves, and stipules adhering to the petiole; cultivated about Constantinople, where it grows 15 ft. high, with a trunk 3 in. in diameter. It was introduced into this country in the year 1826, and produces its white flowers from July to September; but it is seldom to be met with in collections. It is, doubtless, as hardy as *Medicago arborea*.

Lötus L. contains two or three species, somewhat ligneous, that might deserve trial against a conservative wall. They are natives of the south of Europe, the north of Africa, and the Cape of Good Hope. *Lötus creticus* L. (*Cav. Icon.*, 2. p. 44. t. 156.) is a native of Syria, Candia, and Spain. It is a slender shrub, not higher than 1½ ft. or 2 ft., producing yellow flowers from June to September. *L. anthylloides* Vent. Malm., p. 92. t. 92., is a native of the Cape of Good Hope, with yellow flowers. *L. atropurpureus* Dec. has dark purple flowers. *L. jacobæus* L. (*Bot. Mag.*, t. 79., and our fig. 339.) is a native of the Cape De Verde Islands, and has been in culture since 1714. It grows to the height of 3 ft., with a dark purple corolla, almost black, and the standard yellowish. There is a variety with yellow flowers. This, and all the other species of *Lötus*, flower a great part of the year, and are, consequently, all very desirable for low conservative walls, of from 3 ft. to 5 ft. in height. *L. Broussonetii* L. and *L. spectabilis* are splendid Tencriffe species, introduced by P. B. Webb, Esq., and to be procured in the Milford Nursery.

Carmichaelia anstrælis R. Br. (*Bot. Reg.*, 912.) is a New Zealand shrub, with flat branches, and bluish flowers. The leaves, which are trifoliolate or pinnate, drop off soon after they are expanded. This shrub grows to the height of 6 ft. or 7 ft., flowering profusely from May to September. From its native country, there can be no doubt but it is as hardy as *Medicago arborea*, and that it would thrive equally well against a conservative wall.

Psoralea L. is a genus of herbaceous and suffruticose species, 64 of which have been described: they are natives of the south of Europe, Africa, and North America; and some few of the ligneous species are half-hardy.

P. bituminosa L. (*Lam. Ill.*, t. 614. f. 1.) is a native of the south of Europe, in exposed places, and has been an inhabitant of our green-houses since 1670. It is common in the rocks between Genoa and

Nice, where it is seldom seen higher than 2 ft. or 3 ft.; but, planted out in the open border, it attains twice or thrice that size. The flowers smell like black currants, and the leaves like bitumen. *P. glandulosa* L. (*Bot. Mag.*, t. 900., and our figs. 340, 341.) is a native of Chili; and, in gardens about London, it seems very nearly hardy. The flowers are bluish purple, and the wings and keel white. The whole plant, when bruised, has the smell of rue. In its native country, the leaves are applied to heal wounds, and an infusion of the roots is given as a purgative. There is a plant of this species in the open ground, in the HammeSmith Nursery, which has stood there several years, is now 7 ft. high, and flowers and ripens seeds every year; one in the garden of the Horticultural Society has stood against a wall since 1831, without protection: it grows rapidly, and appears quite hardy. *P. pubescens* Balb. (*Bot. Reg.*, t. 968.) is a native of Peru, with bright blue



340

flowers. *P. plicata* Delil. is a native of Upper Egypt; and *P. obtusifolia* Dec. is a native of the Cape of Good Hope; but neither has yet been introduced. There are some other ligneous species mentioned in Don's *Miller* as not being sufficiently known.

Indigofera L. is a genus including above 140 species, among which is *I. tinctoria*, which produces the common indigo of the shops. Some of the species are ligneous, and natives of Africa or Asia; but, as they are generally of low growth, they are not very desirable for planting out against a low wall. *I. denudata* Jacq. (*Bot. Cab.*, t. 500., and our fig. 342.) has red flowers, streaked with dark lines. It grows to the height of 2 ft., and flowers from May till July.

I. amara Ait. (*Bot. Reg.*, t. 300.) grows to the height of 3 ft., and has dark red flowers, which are produced in May and June. *I. atropurpurea* Hamilt. is a native of Nepal, introduced in 1816. It grows to the height of 5 ft. or 6 ft., and produces its dark shining purple flowers in July and August. *I. austrælis* Willd. (*Bot. Cab.*, t. 149., and our fig. 343.) is a native of New Holland. It grows to the height of 4 ft., and has rose-coloured flowers. *I. sylvatica* Steb. (*Bot. Mag.*, t. 3000.), the *I. angulata* of *Bot. Reg.*, t. 2758., is also a native of New Holland, and grows to the height of 8 ft. It is a very showy plant, producing its flowers from May to June. Various other green-house species, already introduced, will be found enumerated in our *Hortus Britannicus*; and many, not introduced, are described in Don's *Miller*.



338



339



341

312



343



Swainsonia Salisb. is a genus of elegant New Holland shrubs, all beautiful, and well deserving a place against a low conservative wall in a mild locality. *S. galegifolia* R. Br. (*Bot. Mag.*, t. 792., and

344

345

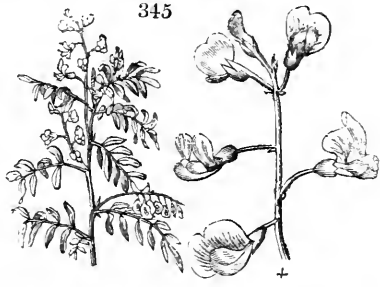
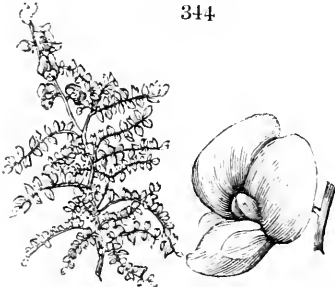

our fig. 344.) grows to the height of 3 ft. ; and produces red flowers from June to August. There is a variety of this with white flowers, figured in *Bot. Reg.*, t. 994. *S. coronillaefolia* Salisb. (*Bot. Mag.*, t. 1725.) and *S. lessertiaefolia* Dec. are rather herbaceous than ligneous ; but their flowers are large and handsome, and, when kept in a frame during winter, and turned out in the borders in spring, they make a fine appearance.

Lessertia Dec. contains some undershrubs, one or two of which have been introduced. *L. fruticosa* Lindl. (*Bot. Reg.*, t. 970., and our fig. 345.) is a native of the Cape of Good Hope, which grows to the height of 3 ft., and produces its purple flowers in July and August.

Sutherlandia frutescens R. Br., *Colutea frutescens* L. (*Bot. Mag.*, t. 181. ; and our fig. 346.) is a hoary shrub, with large, elegant, scarlet, showy flowers, a native of the Cape of Good Hope. It grows to the height of 3 ft. or 4 ft., flowering from June to August ; and, in very mild winters, it will stand in the borders without protection. *S. microphylla* Burch. is another Cape species, which has not yet been introduced.



346

Sect. III. HEDYSA'REÆ.

GENUS XVIII.



CORONI'LLA Neck. THE CORONILLA. *Lin. Syst.* Diadélphia Decándria.

Identification. Neck. Elem., No. 1319. ; Lam. Ill., t. 630. ; Dec. Prod., 2. p. 309.

Synonyme. Coronilla sp. of *Lin.* and others.

Derivation. From *corona*, a crown, in reference to the disposition of the flowers in crowns, or umbels, at the tops of the peduncles.

Description, &c. The ligneous species are hardy or half-hardy, deciduous or subevergreen, shrubs, natives of the south of Europe or Asia, with imparipinnate leaves, and flowers on pedicels disposed in umbels placed on axillary peduncles. They are all highly ornamental, and most of them produce seeds in England, by which, or by cuttings, they are easily propagated.

♣ 1. *C. E'MERUS L.* The Scorpion Senna Coronilla.

Identification. Lin. Sp., 1046.; Dec. Prod., 2. p. 309.; Don's Mill., 2. p. 274.

Synonymes. *F'nerus major Mill. Icon.*, t. 132. f. 1., and *E. minor*, f. 2.; *C. pauciflora Lam. Fl. Fr. Engravings.* Sims Bot. Mag., t. 445.; N. Du Ham., 4. t. 131.; Mill. Icon., t. 132.; and our fig. 347.

Spec. Char., &c. Shrubby, glabrous. Its leaves are attended by minute stipules, and have 5—7 obovate leaflets. Its flowers are yellow, disposed 3 upon a peduncle. The claws of the petals are thrice as long as the calyx. The legume is rather cylindrical than compressed, and its joints separate slowly and unobviously, but they do se-



parate. It is spontaneous in hedges and thickets of middle and southern Europe, and of Tauria. (*Dec. Prod.*, ii. p. 309.) Introduced in 1596, and flowering from April to June. Height 10 ft. Before the flowers are expanded, the corolla is partly red externally, mostly so towards the tips of the petals; and the mingling of the yellow flowers, with flower buds more or less red, and the elegant foliage, render this hardy shrub a very desirable one for its beauty. Perhaps it flourishes most in a sunny sheltered situation, and a dry soil. It bears clipping pretty well, and would form a beautiful hedge. Plants, in the London nurseries, are 9*d.* each; at Bollwyller, 50 cents; and at New York, 37½ cents.

♣ 2. *C. JU'NCEA L.* The rushy-branched Coronilla.

Identification. Lin. Sp., 1047.; Dec. Prod., 2. p. 309.; Don's Mill., 2. p. 274.

Engravings. Bot. Reg., t. 820.; Lodd. Bot. Cab., t. 235.; Barrel Icon., t. 133.; J. Bauh. Hist., 1. p. 2. t. 383. f. 2.; and our fig. 348.

Spec. Char., &c. Shrubby, glabrous. Branches rush-like, round, bearing but few leaves; the latter are attended by minute stipules, and have 3—7 leaflets, that are linear oblong, obtuse, and rather fleshy; the lowest leaflets being rather distant from the base of the petiole. The flowers are yellow, 5—7 in an umbel. The claws of the petals are scarcely longer than the calyx. The legume is rather compressed, and its joints separate obviously. (*Dec. Prod.*, ii. p. 309.) The whole plant is very glaucous. Native of the south of France, and introduced in 1756. It grows to the height of 2 ft. or 3 ft., and produces its bright yellow flowers in June and July. It deserves a place in collections, on account of the singularity of its rush-like slender branches, which, like those of *Spártium júnceum*, are partly destitute of leaves.



App. i. *Half-hardy ligneous Species of Coronilla.*

The half-hardy species of this genus are eminently beautiful, and some of them have been known to live for years in the open border, in a dry soil, in the neighbourhood of London. Against a wall, they will live with very little protection, producing their beautiful yellow flowers early in spring (one species, *C. stipularis*, in March); and continuing flowering throughout the summer. As they produce abundance of seeds, a stock of plants may always be kept in pots or cold-pits, and turned out into the open borders, where they will flower freely throughout the summer; and, if they should be killed during the succeeding winter, the loss can easily be supplied.

C. stipulàris Lam., the *C. valentina* of *Lin.*, and *Bot. Mag.*, t. 185., the *C. hispànica* of *Mill.*, and our fig. 349, is a native of the south of Italy, and has deep yellow flowers, very fragrant at night, which are produced from March to November. It has been in cultivation since 1506, and grows to the height of 3 ft. in British gardens.



349

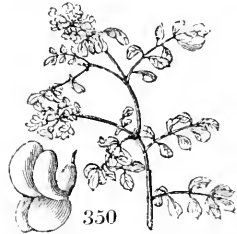

350

C. pentaphýlla Desf. is a native of Algiers, where it grows to the height of 4 ft. It was introduced in 1700, and flowers in June and July.

C. glauca L. (*Bot. Mag.*, t. 13., and our fig. 350.) is a native of France, about Narbonne. It was introduced in 1722, and grows to the height of 4 ft., producing its beautiful yellow flowers, which are fragrant in the day-time, but scentless at night, from May to September.

C. argentea L. is a native of Candia, said to have been introduced in 1664; "a very doubtful plant." (*Don's Mill.*, 2. p. 274.)

C. multiflora Dec. Prod., 2. p. 310., is a native of Spain, with pale yellow flowers, and is, perhaps, only a variety of some of the other species.

App. I. Hardy suffruticose Species of Hedysaræa.

Hedysarum fruticosum L. (*Gencl. Sib.*, 4. t. 22.) is an erect plant, with somewhat shrubby branches, very handsome when in flower, and extremely useful in the deserts of Siberia, in fixing the sand. It has been in cultivation since 1792, and grows to the height of 3 ft. or 4 ft.

App. II. Half-hardy ligneous Species of Hedysaræa.



351

The half-hardy species of this tribe are numerous; but, as most of them will live in a cold-pit, or even in the open garden, in the warmest parts of the south of England, we consider it advisable to notice at least one species of each genus.

Hippocrepis balcarica Jacq. (*Bot. Mag.*, t. 427., and our figs. 351, 352.) is a native of Minorca, with the general appearance of *Coronilla*. It has been in the country since 1776, flowering in green-houses, and cold-pits, from May to July.

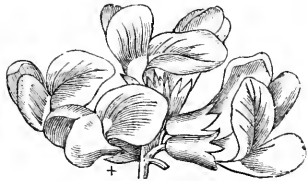

352

Adesmia Dec. is a genus of South American plants, some of which are shrubby: the appearance of several of them resembles that of *Génista*; and they are all of remarkably easy culture.

A. microphýlla Hook. (*Bot. Cab.*, t. 1691., and our figs. 353, 354.) is a dichotomous plant, resembling furze, a native of Valparaiso, introduced in 1776, quite hardy, and flowering throughout the summer.

A. Loudonia Hook. (*Bot. Reg.*, 1790., and our figs. 355, 356.) is a native of Valparaiso, where it grows to the height of 2 ft., with upright branches, which are copiously clad with hoary, pinnate, very silky leaves. It was introduced in 1832, and is nearly hardy.

A. viscosa Gill. et Hook. (*Swt. Fl. Gard.*, 2d ser. t. 230., and our fig. 357.) is a native of Chili, with clammy leaves and shoots; introduced in 1832, and producing its yellow flowers in August. It forms a very handsome shrub, of upright growth, with elegant leaves, having sometimes as many as 14 pairs of crenated leaflets. It appears to be as

hardy as *Edwardsia microphýlla*, or more so; for a plant in the Exotic Nursery, King's Road, has stood out against a wall with a western exposure, and attained the height of 10 ft.

A. uspaténtensis Gill. (*Swt. Brit. Fl. Gard.*, 2d ser. t. 222., is a slender, thorny, diminutive shrub, a native of Chili, introduced by Mr. Cuming in 1832. Its blossoms are of a rich yellow, streaked with red; and its legumes, when full grown, are adorned with long feathery hairs.

Uraria Desr. is a tropical genus, one species of which, *U. arborea* G. Don, *Hedysarum arboreum Hamilt.*, is a native of Nepal, where it grows to a tree 12 ft. in height.

Desmodium Dec. is a tropical genus, of which several species are natives of Nepal, and may probably be found half-hardy. The only ligneous species which is already introduced is *D. retusum*

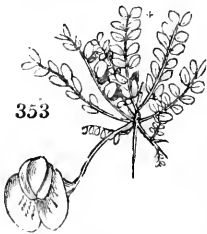

353



354



355

G. Don, *Hedysarum retusum* Hamilt., which is a shrub growing to the height of 2 ft., with large pinnate leaves, and leaflets nearly 2 in. long, and half an inch broad

Dicerma elegans Dec., *Hedysarum elegans* Lour., *Zornia elegans* Pers., is an erect shrub, growing to the height of 3 ft., with trifoliate leaves; a native of China, near Canton. It was introduced in 1819, and produces its yellow flowers in July and August.

Taverniera Dec. is a genus of shrubs, natives of Persia and Arabia, with simple and trifoliate leaves, and rose-coloured or yellow flowers. *T. nummularia* Dec. (*Lég. Mém.*, t. t. 52.), *Hedysarum Olivieri* Spreng., produces its rose-coloured flowers in June and July. It was introduced in 1836, and grows to the height of 2 ft.

Lespedeza Michx. is a genus of plants, chiefly natives of Siberia

and of North America, several of which are suffruticose; but none of them have been introduced except *L. frutescens* Pers. (*Jac. Vin.*, 3. 89.), which is a native of Carolina, where it grows 2 ft. or 3 ft. high, and produces its purplish flowers in July and August.

Flemingia semialata Roxb. Cor., 5. t. 249., is a deciduous shrub, a native of Nepal, introduced in 1805. It grows 3 ft. or 4 ft. high, and produces its pale red flowers in July and August.

Ebenus crética L., *Anthyllis crética* Lam., (*Bot. Mag.*, t. 1092.) is a shrub, a native of Candia, with large reddish or purple flowers, having the stamiferous tube elegantly striated, which was introduced in 1737. It grows to the height of 2 ft., and flowers in June and July.

Alhagi Maurorum Tourn., *Hedysarum Alhagi* L., *Alhagi mannifera* Desf., *Ononis spinosa* Hassiq., *Manna hebræica* D. Don, (*Prod. Fl. Ncp.*, 247.; *Rauw. Itin.*, 1. p. 94., icon.) is a native of the deserts of Egypt, Syria, Mesopotamia, and other eastern countries. It was introduced in 1714, but is seldom met with in green-houses. In its native country, it grows 2 ft. or 3 ft. high, and produces its purplish flowers, which are reddish about their edges, in July and August. The manna of the Jews is generally considered to have been produced from this plant; and the Arabians have a tradition, that it fell from the clouds upon it, to feed the Israelites in the desert. This, however, is contrary to what is recorded in the Scriptures; viz. that the miraculous manna appeared only on the rocks, and on the sand, and hence the surprise of the Israelites, who would not have been astonished if they had seen small portions of it on the plants; but who, finding it in such immense quantities on the ground, where they had never seen it before, could hardly believe it to be the same thing, and exclaimed in Hebrew, "Man?" that is to say What is it? whence, possibly, the name. The manna produced by the alhagi is a natural exudation from the leaves and branches, which takes place only in very hot weather. At first, it resembles drops of honey: but it granulates with the atmosphere into particles of different sizes, but seldom larger than a coriander seed. It is collected by the natives, more especially about Iaurus, where the shrub grows plentifully; but it is not known in this country as an article of foreign commerce; the manna of the druggists being the concrete juice of the *Orrus europæa*. The *Alhagi Maurorum* ought to be in all extensive collections, as a plant of historical interest. *A. camclorum*, a herbaceous species, introduced in 1816, produces a similar exudation, which is called Caspian manna. The plant is a native of the deserts of Tartary and Siberia, where it forms a food for camels; whence its name. (*Burnet's Outlines*, 2. p. 659.)



356



357

Chianthus puniceus Soland., the *Donia punicea* of G. and D. Don, (*Bot. Reg.*, t. 1775., and our fig. 358.) is a New Zealand shrub, introduced in 1832, or earlier. It was originally discovered by Sir Joseph Banks and Dr. Solander, in 1769, but was not noticed in any scientific work till a description of it was published in Don's *Miller*, in 1832. It appears to have been first grown in England by Wm. Leveson Gower, Esq., in his garden at Titsey Place, near Godstone, where it flowered in the summer of 1834. It was figured in the *Bot. Reg.*, in July, 1835; and in the *Hort. Trans.*, 2d series, vol. i. t. 22., in the same year. The seeds were sent home by the missionaries in New Zealand, where it is called *kowain-gutukaka*, or the parrot's bill; and where it is said to grow to the size of a large tree, though the specimens in Britain appear quite suffruticose, and have not reached a greater height than 4 ft. "From



358

the trials that have been made of the proper mode of managing it, both by Mr. Gower and the Rev. John Coleman, by whom it was given to the former gentleman, it would appear that it succeeds best when treated as a hardy plant, and turned out into a peat border; for in such a situation it has now been two years in Mr. Gower's garden, and the plants continue to look very healthy, with a profusion of blossoms forming for next year. Kept in the green-house, it was sickly, and did not flower in the hands of Mr. Gower's gardener; but Mr. Coleman succeeded in blossoming it in a large pot in a green-house, and in inducing it to ripen its pods. Considering the climate of New Zealand is, in some places, so much like that of England, that some species, such as *Edwardsia microphylla*, will bear the rigour of our winters, it is not improbable that this may also prove a hardy plant; if so, its extraordinary beauty will render it one of the most valuable species that has been introduced of late years; and, even if it should be no hardier than *Sutherlandia frutescens*, it will still form one of the most important and welcome of all the modern additions to our flower-gardens." (*Hort. Trans.*, 2d ser. i. p. 521.)

Sect. IV. PHASEOLEÆ.

GENUS XIX.

WISTARIA Nutt. THE WISTARIA. *Lin. Syst.* Diadélphia Decándria.

Identification. Nutt. Gen. Amer., 2. p. 115.; Dec. Prod., 2. p. 389.; Don's Mill., 2. p. 348.

Synonymes. *Glycine* sp. *L.*, *Thyrsanthus* *Elliot*, *Krahnbia* *Rafin.*

Derivation. Named in honour of *Caspar Wistar*, late Professor of Anatomy in the University of Pennsylvania. (*Don's Mill.*, ii. p. 348.) Nuttall first characterised and named this genus, from the American species, which he denominatèd *W. speciosa*; but which De Candolle has changed to *W. frutescens*. In De Candolle's *Prodromus*, and some other works, *Wistaria* is erroneously spelled *Wistèria*.

Description, &c. Leaves impari-pinnate, without stipules. Flowers in terminal racemes, blue lilac; when young, attended by bracteas, which afterwards fall off. (*Dec. Prod.*, ii. p. 390.) Deciduous twining shrubs, natives of North America, and China; of vigorous growth, and forming, when in flower, some of the most splendid ornaments of British gardens. They are quite hardy, will grow in any soil, and are generally propagated by layers of the young shoots, which will root at every joint if laid down during summer as they grow. They may also be propagated by cuttings of the roots; or by seeds.

‡ 1. *W. FRUTESCENS* *Dec.* The shrubby *Wistaria*.

Identification. *Dec. Prod.*, 2. p. 390.; *Don's Mill.*, 2. p. 348.

Synonymes. *Glycine frutescens* *Lin. Sp.*, 1067.; *Apios frutescens* *Ph. Fl. Am. Sept.*, 2. p. 474.; *Anonymos frutescens* *Walt. Fl. Car.*, 186.; *Wistaria speciosa* *Nutt. Gen. Amer.*, 2. p. 115.; *Thyrsanthus frutescens* *Elliot Journ. Acad. Sci. Philad.*; *Phaseoloides* *Hort. Angl.*, 55.; the Kidneybean Tree.

Engravings. *Bot. Mag.*, t. 2103.; and our fig. 359.

Spec. Char., &c. Wings of the corolla each with two auricles. Ovary glabrous. Flowers odorous. (*Dec. Prod.*, ii. p. 390.) An elegant deciduous climber, a native of Virginia, Carolina, and the Illinois, in boggy places. Introduced in 1724, and flowering from July to September. The flowers are of a bluish purple, and sweet-scented, the standard having a greenish yellow spot at the base. The plant is a free grower; and,



in 3 or 4 years, if planted in good soil, and in a favourable exposure it will attain the height of 20 ft. or 30 ft. It is readily propagated by cuttings of the root and by layers. Plants, in the London nurseries, are 1s. 6d. each; at Bollwyller, 1 franc 15 cents; and at New York 37½ cents.

‡ 2. *W. CHINE'NSIS* Dec. The Chinese Wistaria.

Identification. Dec. Prod., 2. p. 390.; Don's Mill., 2. p. 348.

Synonymes. *Glycine chinensis* Sims *Bot. Mag.*, t. 2083.; *G. sinensis* Ker *Bot. Reg.*, t. 650.; *Wistaria Consequana* Loudon *Gard. Mag.*, vol. ii. p. 422., vol. xi. p. 111., and in *Hort. Brit.*

Engravings. Swt. Brit. Fl.-Gard., t. 211.; *Bot. Mag.*, t. 2083.; *Bot. Reg.*, t. 650.; Lodd. *Bot. Cab.*, t. 773.; *Gard. Mag.*, vol. ii. p. 422.; and our fig. 360.

Spec. Char., &c. Wings of the corolla each with one auricle. Ovary villose. Flowers larger. (*Dec. Prod.*, ii. p. 390.) A vigorous-growing deciduous twiner; a native of China, introduced in 1816; flowering in British gardens in May and June, and sometimes producing a second crop of flowers in August. The flowers are larger than those of *W. frutescens*: they are disposed in longer and looser racemes, and are somewhat paler in colour. On established plants they are produced in great abundance; but they have not yet been succeeded by seeds in England. This plant may truly be considered the most magnificent of all our hardy deciduous climbers. It will grow wherever the common



360

laburnum will flourish; but, as its flowers are somewhat more tender than those of that tree, they are more liable to be injured by frosts in very late springs. It was first brought to England by Capt. Robert Welbanke, in May, 1816; and in the same month, but a few days later, another plant was introduced by Capt. Richard Rawes. Both were obtained from the garden of Consequa, a generous, but unfortunate, merchant of Canton, of whom a biography will be found in the *Gard. Mag.*, vol. xi. p. 111. One of the imported plants is in a pit in the garden of Rook's Nest, near Godstone in Surrey; but it is small when compared with one raised from it, which every one, who has ever entered the garden of the London Horticultural Society in May or June, for some years past, must have been struck with seeing against the wall. That plant has now (March, 1835) a stem the height of the wall (11 ft.), from which branches proceed on one side to the distance of 90 ft., and on the other to the distance of 70 ft. So vigorous is this plant, that there is no reason to suppose it will not, if allowed, extend to double or treble that distance. There can be no doubt but it is the most vigorous-growing, and abundant-flowering climber in British gardens. Plants, which were originally sold at six guineas, now cost, in the London nurseries, from 1s. 6d. to 2s. 6d. each; at Bollwyller, they are 3 francs; and at New York, 3 dollars.

App. i. *Other Species of Wistaria.*

W. floribunda Dec. Prod., 2. p. 390.; *Dolichos polystachyus* Thun. *Jap.*, 281.; *Houtt. Pfl. Syst.*, 8. p. 563. t. 64. fig. 2.; *Glycine floribunda* Willd.; *Dolichos japonicus* Spreng.; *Füdsi* Kæmpf.; has the stems and leaves glabrous, the racemes of flowers very long, and the corolla purple and white mixed. This species has not been introduced, though it was conjectured by Mr. Sweet that the shoots from the roots of an imported plant in the Fulham Nursery might be of this species, because the leaves were quite different from those of the upper part of the plant, being hairy, while the others were smooth. Mr. Sweet thought it likely that one species had been grafted on another; but it has since been observed, that all the root-shoots from vigorous plants have hairy leaves. On these grounds it was that *W. floribunda* was recorded into our *Hortus Britannicus* as having been introduced in 1820, and described there as a trailer, with shoots 10 ft. in length. On similarly slight foundations, we have no doubt, many species have been recorded both at home and abroad. In the year 1829, we brought over some plants, and a packet of seeds, from Carlsruhe, the produce of a plant growing there against the end of a hot-house, flowering freely, and producing seeds every year. This plant had been received by M. Hartweg, the director of the garden, as the *Glycine chinensis* of *Bot. Mag.*, t. 2083.; and, as when we saw it in November, 1828, it was without leaves, it appeared to us uncertain whether it was correctly named or not. Some of the plants raised from the seeds which we brought over, and gave to the Clapton Nursery, have since flowered and ripened seeds in the garden of F. Bernasconi, Esq., near Finner (See *Gard. Mag.*, vol. xii. p. 75. and p. 215.): but we received this in-

formation too late in the autumn of 1835, to be able to examine the plant, so as to determine any thing certain respecting its species. Possibly, it may be a new species; but we think it more probable, from the leaves of a plant in our own garden, also raised from the seeds we brought from Carlsruhe, which has not yet flowered, that it is nothing more than *Wistaria frutescens*.

App. I. Suffruticose hardy or half-hardy Species of Phaseolææ.



Lupinus arboreus Sims (*Bot. Mag.*, t. 628, and our fig. 361.), the tree lupine, is somewhat shrubby, and, as a standard, will grow to the height of 6 ft. Its native country is unknown; but it has been in cultivation in British gardens since 1793; and it produces its pale yellow flowers in July and August. There is a large plant of it, trained against a wall, in the garden of the London Horticultural Society; but, though it grows as high as the wall, it cannot be considered as truly ligneous; and it is rather tender. Flowers fragrant.

L. multiflorus Desrous., with azure blue flowers; *L. albibrons* Benth. *B. Reg.*, t. 1642., a shrubby Californian species, with deep blue flowers; *L. Marshallianus* Swt. *Fl.-Gard.*, 2d ser. t. 139., and our fig. 362.; *L. canaliculatus* Swt. *Fl.-Gard.*, 1st ser. t. 283.; *L. versicolor* Swt. *Fl.-Gard.*, 2d ser. t. 12.; *L. pulchellus* Swt. *Fl.-Gard.*, 2d ser., t. 67.; are all technically considered somewhat suffruticose, and will grow to the height of from 3 ft. to 6 ft. when trained against

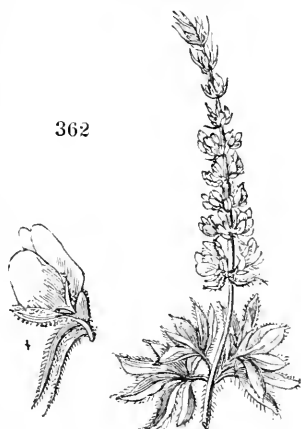

a wall, lasting 2 or 3 years, if not destroyed during winter by severe frost. There are also several other species described in Don's *Müller*, bearing the same general character, but most of which have not yet been introduced.

App. II. Half-hardy Species of Phaseolææ.

Dôlichos lignosus L. (*Smith Spic.*, t. 21.) is a ligneous climber, with rose-coloured flowers, having a purplish keel, which is tolerably hardy; it has been an inhabitant of our green-houses since 1776, and flowers in July and August.

Pachyrhizus trilobus Dec., *Dôlichos trilobus* Lour., is a twining shrub, a native of China and Cochinchina, where it is cultivated for the tubers of its roots, which are cylindrical, being about 2 ft. long, and are boiled and eaten by the natives, in the same manner as yams are in the West Indies. The flowers are of a bright purple, with a yellow spot in the centre of the standard. This species has not yet been introduced.

Mucuna macrocarpa Wall. (*Pl. As. Rar.*, l. p. 41. t. 47., and our fig. 363.) is a twining shrub, a native of Nepal, on the mountains. The flowers are party-coloured, the standard green, the wings purple, and the keel brown. The legumes are very large, as are the racemes of flowers. It has not yet been introduced, but, when it is, it will probably be found half-hardy or hardy.

Erythrina Crista-galli L. (*Smith Exot. Bot.*, 2. p. 95.; *Swt. Fl.-Gard.*, p. 214.), the coral tree, is a splendid plant, a native of Brazil, where it grows to the height of 20 ft. In British gardens, it will grow at the base of a wall, with a little protection during winter, and produce its bright deep scarlet flowers from May to July. *E. laurifolia* Jacq., the *E. Crista-galli* of *Bot. Reg.*, t. 313., is considered by some as a species; and by others as a variety of *E. Crista-galli*. It produces its rich but dull crimson flowers from July to September. No conservative wall ought to be without these plants, since they may be easily protected at the root by a little straw; and, even if killed down every year, they will produce shoots, which will terminate in long spikes of coral-like flowers every season. They require a deep sandy soil, somewhat rich; and are propagated by cuttings of the shoots, or division of the root. There are some other green-house species, not yet introduced, which are probably equally hardy with the above; and, probably, many of the tove species would stand out with some protection.



363

Sect. V. CASSIÆ.

GENUS XX.

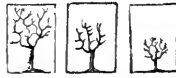
GLEDITSCHIA L. THE GLEDITSCHIA. *Lin. Syst. Polygàmia Dicècia.*

Identification. Lin. Gen., 1159.; Lam. Ill., p. 857.; Dec. Prod., 2. p. 479.; Don's Mill., 2. p. 428.

Synonyms. *Acacia* sp. *Pluk.*; Févier; *Fr.*, Gleditschie, *Ger.*

Derivation. In honour of *Gottlieb Gleditsch*, of Leipsic, once a professor at Berlin, and defender of Linnaeus against Siegesbeck; author of *Methodus Fungorum* (1753), *Systema Plantarum a Stamina situ* (1764), and many other smaller works.

Description. Deciduous trees. Branchlets supra-axillary, and often converted into branched spines. Leaves abruptly pinnate; in the same species pinnate, bipinnate, or, rarely, by the coalition of the leaflets, almost simple. Flowers greenish, in spikes. Among the ovaries, it often happens, especially among those of the terminal flowers, that two grow together by their seed-bearing suture, which is rather villose. (*Dec. Prod.*, ii. p. 479.) Deciduous trees of the 1st, 2d, and 3d ranks, natives of North America or China, of easy culture in good free soil; and, in Britain, generally propagated by imported seeds, or grafting. The species appear to be in a state of great confusion in British gardens; and, judging from the trees in the garden of the London Horticultural Society, and in the arboretum of Messrs. Loddiges, we should conjecture that there is, probably, not more than two species, the American, and the Chinese; possibly only one. The Chinese species is distinguished by its trunk being more spiny than its branches.

‡ 1. *G. TRIACÁNTHOS* *Lin.* The three-thorned Gleditschia, or *Honey Locust.*

Identification. Lin. Sp., 1509.; Dec. Prod., 2. p. 479.; Don's Mill., 2. p. 428.

Synonyms. *G. triacanthos* var. α *polysperma* *Mart. Mill.*; *G. meliloba* *Walt.*; *G. spinosa* *Du Ham.*; *Acacia triacanthos* *Hort.*; *Acacia americana* *Pluk.*; Févier d'Amérique, *Fr.*; Thorny *Acacia*, Sweet Locust, *United States*; Carouge à Miel, *Canada.*

Engravings. N. Du Ham., 4. t. 25.; Michx. Fil. Arb., 2. p. 164. t. 10.; Hort. Ang., t. 21.; Wats. Dend. Brit., t. 138.; *Pluk. Mant.*, t. 352. f. 2.; and the plates of this species in our Second Volume.

Spec. Char., &c. Spines simple or trifid; stout, at the very base compressed, in the upper part cylindrical, but tapered. Leaflets linear-oblong. Legumes flattish, rather crooked, many-seeded, and more than ten times as long as broad. (*Dec. Prod.*, ii. p. 479.) A tree of from 50 ft. to 80 ft. high, a native of Carolina and Virginia. Introduced in 1700; flowering in June and July.

‡ *G. t. 2 inermis* *Dec.*, *G. lævis* *Hort.*, (*Dec. Lég. Mém.*, 2. t. 22. fig. 109.; *Catesb. Carol.*, 1. t. 43.; *Pluk. Alm.*, t. 123. fig. 3.; and the plates of this variety in our Second Volume) has the stem and branches not spiny, or but very sparingly so.

Description. The three-thorned gleditschia, or honey locust, in favourable situations in its native country, attains the height of 70 ft. or 80 ft., with a trunk 3 ft. or 4 ft. in diameter; and clear of branches to the height of 30 ft. or 40 ft. In Britain, there are specimens of about 70 ft. in height. The bark of the trunk and branches is of a grey colour; and of the shoots and spines, when young, of a purplish brown. When the tree attains some age, the bark of the trunk detaches itself laterally, in plates of 3 in. or 4 in. in width, and 2 or 3 lines in thickness. The trunk and branches, when the tree is young, are covered with large prickles, which, though they are not ligneous, become hard, and remain on for several years, and offer a formidable defence. These prickles are not only produced by the young wood, but occasionally protrude themselves from the trunk, even when the tree is of considerable bulk and age. In general, the trunk presents a twisted appearance, and the branches proceed from it rather horizontally than in an upright direction. The pinnated foliage is particularly elegant, and of an agreeable

light shining green : it appears late in spring, the trees in the neighbourhood of London sometimes not being fully clothed till the middle or end of June ; and it begins to turn yellow, and drop off, early in autumn. The flowers are inconspicuous ; the male flowers being in the form of catkin-like racemes of nearly the same colour as the leaves. As far as we have observed, most of the plants in the neighbourhood of London produce only male flowers ; and we have not heard of any plant of this species having produced seeds in England, except those mentioned by Miller, which, however, did not ripen ; though we have seen trees at Alfort, near Paris, bearing their long crooked legumes, and retaining them even after the leaves had dropped. These crooked pendulous pods are from 12 in. to 18 in. long, and of a reddish brown colour ; they contain hard, smooth, brown seeds, enveloped in a pulpy substance, which, for about a month after the maturity of the seeds, is very sweet, but which, after a few weeks, becomes extremely sour. The rate of growth of this tree, for the first 15 or 20 years, is generally about the average of a foot a year ; but in favourable situations it will grow at double that rate. In the garden of the London Horticultural Society, and in the arboretum of the Messrs. Loddiges, plants 10 years planted were, in 1835, from 20 ft. to 25 ft. in height.

Geography. The sweet locust does not appear to have a very extensive range in the United States. It seems to belong more particularly to the country west of the Alleghanies ; and it is scarcely found in any part of the Atlantic states, unless it be in Limestone Valley, where the soil is generally rich, and the situation not exposed. In the fertile bottoms which are watered by the rivers that empty themselves into the Mississippi, in the Illinois, and still more in the southern parts of Kentucky and Tennessee, it is abundant in fertile soils. It is generally found growing with *Juglans nigra* and *Carya squamosa*, *Ulmus rubra*, *Fraxinus quadrangulata*, *Robinia Pseud-Acacia*, *Negundo fraxinifolium*, and *Gymnocladus canadensis*. It is never found but in good soil ; and its presence, Michaux observes, is an infallible sign of the greatest degree of fertility.

History. The tree was first cultivated in England, by Bishop Compton, in 1700 ; and Miller informs us, that it produced pods in the Palace Garden at Fulham, in the year 1728, that came to their full size ; but the seeds did not ripen. In Martyn's *Miller*, only one species is described, *G. triacanthos* ; *G. monosperma* and *G. hordida* being made varieties of it, and *G. polysperma* the normal form of the species. *G. triacanthos* was known in France in the time of Du Hamel, who recommends it as an ornamental tree, but liable to have its branches broken by the wind, more especially when the tree becomes forked at the summit, and two branches of equal size spread out on each side. In England, it was never recommended to be planted with any other view than as an ornamental tree, till Cobbett became a nurseryman, and suggested its use as a hedge plant. We do not know whether it has ever been tried for this purpose in England ; but Manetti informs us (*Gard. Mag.*, vol. xi. p. 643.) that it was used for hedges in Lombardy, but, like the robinia, when tried for the same purpose, it was soon given up. (See p. 620.)

Properties and Uses. The wood of this tree, when dry, weighs at the rate of 52 lb. the cubic foot : it is very hard, and splits with great facility, resembling in this and other respects the wood of the robinia ; but its grain is coarser, and its pores more open. The tree is most abundant in Kentucky ; and there only the wood is employed for any useful purpose, though even there it is but little esteemed. It is used neither by the builder, nor the wheelwright, but is sometimes employed by farmers for fences, when they cannot procure any more durable kind of wood. Michaux says that the only useful purpose for which he thinks the tree is fit, is for making hedges ; but, as we have already seen, it has not succeeded as a hedge plant in Europe. A sugar has been extracted from the pulp of the pods, and a beer made by fermenting it while fresh ; but this practice is by no means general, even in America, and is quite unsuitable for Europe. In Britain, this species, and all

the others of the genus, can only be considered as ornamental trees; but in that character they hold the first rank; their delicate acacia-like foliage, and the singularly varied, graceful, and picturesque forms assumed by the tree, more especially when young or middle-aged, together with the singular feature afforded by its spines, will always recommend it in ornamental plantations.

Soil and Situation, Propagation, &c. It requires a deep, rich, free soil, and a situation not exposed to high winds; the climate ought, also, to be somewhat favourable, otherwise the wood will not ripen; and it requires the climate of the south of England, or the summers of France, to ripen the seeds. The species is always propagated by seeds imported from America, or from the south of France, or Italy; for, though seed pods are seldom seen hanging from the trees in the neighbourhood of London, or even in the south of England, they are produced abundantly in various parts of France, even in the neighbourhood of Paris; and seeds are ripened in fine seasons in Austria. Cobbett directs the seeds to be prepared for sowing by soaking them for 12 hours, as directed for those of the robinia. (See p. 624.) The seeds, he says, when soaked and sown in March, will come up in a fortnight. They are best transplanted to where they are finally to remain when quite young; as they make but few fibrous roots, and these take, for the most part, a descending direction. The variety *G. t. inermis* can only be insured by grafting on the species. In general, however, abundance of plants without spines may be selected from beds of seedlings of *G. triacanthos*.

Statistics. Gleditschia triacanthos in the Environs of London. At Syon there is a tree 57 ft. high, diameter of the trunk 3 ft., and of the head 63 ft.; see the plate of this tree in Vol. II. In the garden of J. Nichols, Esq., the Chancellor's, Queen Street, Hammersmith, there is a tree of this species 47 ft. high, with a trunk 14 in. in diameter. At Purser's Cross, it is 40 ft. high; at Ham House, 30 ft. high. At Kenwood, 38 years planted, it is 44 ft. high; in the Mile End Nursery, 38 ft. high.

Gleditschia triacanthos South of London. In Dorsetshire, at Melbury Park, 25 years planted, and 25 ft. high, the diameter of the trunk 10 in. In Surrey, at Lady Tankerville's, at Walton on Thames, 60 years planted, and 65 ft. high, the diameter of the trunk 2 ft., and of the head 60 ft.

Gleditschia triacanthos North of London. In Monmouthshire, at Tredegar House, 50 years planted, and 40 ft. high. In Oxfordshire, in the Oxford Botanic Garden, 40 years planted, and 30 ft. high, the diameter of the trunk 11 in., and of the head 20 ft. In Suffolk, at Ampton Hall, 15 years planted, and 25 ft. high. In Warwickshire, at Whitley Abbey, 5 years planted, and 12 ft. high. In Worcestershire, at Croome, 30 years planted, and 40 ft. high. In Yorkshire, at Grimstone, 52 ft. high. At Kneadlington, 10 years from the seed, 15 ft. high.

Gleditschia triacanthos in Scotland. In Berwickshire, at the Hirsell, 6 years planted, and 8 ft. high. In Haddingtonshire, at Tynningham, 16 years planted, and 24 ft. high. In Ross-shire, at Brahan Castle, 20 ft. high. In Renfrewshire, in the Glasgow Botanic Garden, the tree is planted against a wall, but is generally killed down to the ground every year. In Sutherlandshire, at Dunrobin Castle, 16 years planted, 104 ft. high.

Gleditschia triacanthos in Ireland. At Cypress Grove, 15 years planted, and 20 ft. high. At Terenure, 15 years planted, and 10 ft. high. In Cullinstown Nursery, 20 years planted, and 30 ft. high. In Down, at Moira, near Belfast, 55 ft. high, diameter of the trunk 1 ft. 3 in., and of the head 36 ft.

Gleditschia triacanthos in Foreign Countries. In France, at Paris, in the Jardin des Plantes, 100 years planted, and 80 ft. high, and the diameter of the trunk 2 ft.; in the Botanic Garden at Toulon, 50 years planted, and 70 ft. high; at Colombier, near Metz, 70 years planted, and 55 ft. high, with a clear trunk of 30 ft.; at Nantes, in the nursery of M. De Nerrières, 40 years planted, and 50 ft. high. In Saxony, at Wörlitz, 46 years planted, and 40 ft. high. In Austria, near Vienna, at Laxenburg, 40 years planted, and 25 ft. high; at Brück on the Leytha, 45 years planted, and 47 ft. high. In Prussia, at Sans Souci, 45 years planted, and 50 ft. high. In Bavaria, at Munich, in the Botanic Garden, 24 years planted, and 30 ft. high. In Cassel, at Wilhelmshoe, 12 years planted, and 8 ft. high. In Denmark, at Dronninggaard, 40 years planted, and 16 ft. high. In Sweden, at Lund, 12 ft. high. In Russia, in the Crimea, the tree ripened seeds in 1827, and again in 1828 and 1829, from which young plants have been raised. (*Mém. de la Soc. Econ. Kar. de la Russ. Mérid.*, 1. p. 40.) In Italy, in Lombardy, at Monza, 29 years planted, and 30 ft. high.

Gleditschia triacanthos inermis. In England, in the environs of London, at Syon, 72 ft. high, diameter of the trunk 2 ft. 4 in., and of the head 71 ft.: see the plate of this noble tree in our Second Volume. In Hertfordshire, at Cheshunt, 8 years planted, and 17 ft. high. In Warwickshire, at Whitley Abbey, 6 years planted, and 14 ft. high. In France, at Martefontaine, 46 ft. high; and in the Toulon Botanic Garden, 36 years planted, and 50 ft. high. In Saxony, at Wörlitz, 35 years planted, and 30 ft. high. In Austria, at Laxenburg, near Vienna, 16 years planted, and 20 ft. high; at Brück on the Leytha, 40 years planted, and 45 ft. high. In Hanover, in the Botanic Garden at Göttingen, 25 years planted, and 30 ft. high.

Commercial Statistics. One year's seedling plants of the species, in the London nurseries, are 10s. per 1000; trees 6 ft. high, from 2s. to 2s. 6d. each; and seeds are 4s. per packet; and plants of *G. t. inermis* are 2s. 6d. each. At Bollwyller, plants of the species are 1 franc each; and of *G. t. inermis*, 1 franc 50 cents. At New York, plants of the species are from 25 cents to 50 cents each, and of the variety, *G. t. inermis*, 50 cents; and seeds of the species are 1 dollar per lb.

‡ 2. *G. (T.) MONOSPERMA* Walt. The one-seeded Gleditschia, or Water Locust.

Identification. Walt. Car., 254; Dec. Prod., 2. p. 479; Don's Mill., 2. p. 428.

Synonymes. *G. carolinensis* Lam. Dict., 2. p. 464; *G. aquatica* Marsh.; *G. triacantha* Gert. Fruct., 2. p. 149.

Engravings. Mill. Icon., 5; and our fig. 364; in which the male flower, the pod, and the seed, are of the natural size.

Spec. Char., &c. Spines slender, not rarely trifid, few. Leaflets ovate-oblong, acute. Legumes flattish, roundish, 1-seeded. (*Dec. Prod.*, ii. p. 479.) A deciduous tree of the largest size, a native of moist woods of Carolina, Florida, and the Illinois. Introduced in 1723, and flowering in June July.

Description. This tree, according to Michaux, is very distinct from *G. triacanthos* in the form of its fruits; which, instead of being long siliques, are flat round pods, containing only a single seed in each. In other respects, it closely resembles the honey locust, from which, in England, where neither of them ripens seeds, we consider it almost impossible to distinguish it. It grows to the height of 60 ft. or 80 ft.; and the bark, though smooth when the tree is young, yet cracks and scales off when the tree grows old, as in *G. triacanthos*. The leaves, Michaux

says, differ from those of *G. triacanthos*, in being a little smaller in all their proportions. The branches are armed with thorns, which are also less numerous, and somewhat smaller than those of *G. triacanthos*.

Geography, History, &c. *G. monosperma* is found but sparingly in North America. Whole days may be passed in going through a country abounding with the common species, without seeing a single plant of *G. monosperma*. It is found in the south of Carolina, in Georgia, and in East Florida; and always in rich moist soil; or in swamps which border rivers, and are occasionally overflowed by them. In such soils, it is found growing among *Taxodium distichum*, *Nýssa grandidentata*, *Acer rubrum*, *Quercus lyrata*, *Plánera crenata*, *Júglans cinerea*, and other species requiring deep, rich, moist soil. The tree was introduced into England in 1723, by Mark Catesby, and treated in all respects like *G. triacanthos*; of which it has, till lately, been considered only a variety. It is raised in the nurseries from imported seed; but whether the plants really turn out perfectly distinct, with respect to the form of their fruit, is uncertain; from their not having yet, as far as we know, fruited in England. We think it probable that the peculiarity of the fruit will be reproduced from seed in most cases; and we should not be more surprised at its doing so, than at particular varieties of pears and apples coming true from seed. It does not appear to have produced seeds in France, where it is not much cultivated, as it is thought to be more liable to injury from frost than *G. triacanthos*.

Statistics. The largest tree in the neighbourhood of London bearing this name is at Syon, where it is 80 ft. high, diameter of the trunk 2 ft., and of the head 40 ft.; and at Gunnersbury Park there is a tree 60 ft. high. In France, near Paris, at Scéaux, 50 ft. high. In Austria, at Vienna, in the Botanic Garden, 22 years planted, and 36 ft. high; at Laxenburg, 16 years planted, and 20 ft. high. In Hanover, in the Botanic Garden at Göttingen, 25 years planted, and 30 ft. high. Price of pods, in the London nurseries, 2s. a quart, and of plants from 2s. to 2s. 6d. each; at New York, plants are 50 cents each.

‡ 3. *G. (T.) BRACHYCARPA* Pursh. The short-fruited Gleditschia.

Identification. Pursh Fl. Amer. Sept., 1. p. 221; Dec. Prod., 2. p. 479; Don's Mill., 2. p. 428.

Synonymes. *G. triacanthos* β Michx. Fl. Bor. Amer., 2. p. 257.

Spec. Char., &c. Spines thick, short, not rarely three together. Leaflets oblong, obtuse. Legumes oblong, short. A native of the Alleghany Mountains, and of Virginia. (*Dec. Prod.*, ii. p. 479.)

This sort, we are inclined to agree with Michaux in thinking only a variety of *G. triacanthos*.

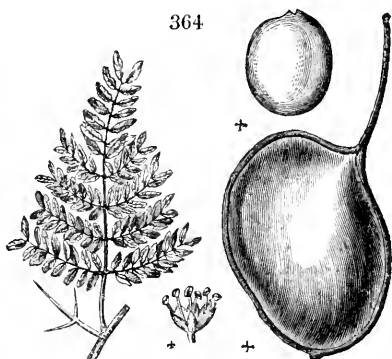

‡ 4. *G. SINE'NSIS* Lam. The Chinese Gleditschia.

Identification. Lam. Dict., 2. p. 465; Dec. Prod., 2. p. 479; Don's Mill., 2. p. 428.

Synonymes. *G. hórrida Willd. Sp.*, 4. p. 1098; Févier de la Chine, *Fr.*

Engravings. Dec. Légum. Mém., 1. t. 1.; and the plate of this species in our Second Volume.

Spec. Char., &c. Spines stout, conical; those on the branches simple or branched; those on the stem grouped and branched. The leaflets ovate-elliptical, obtuse. Legumes compressed, long. A native of China. The spines in this species are axillary, not distant from the axil. (*Dec. Prod.*, ii. p. 479.) A deciduous tree, very distinct, according to Desfontaines, from the American species. The spines, which are very strong and branchy, are more abundant on the trunk than on the branches, and are frequently found in bundles. The leaves are bipinnate, and the leaflets are elliptic obtuse, notched on the edges, smooth, shining, and much larger than those of any other species. (*Desf. Arb.*, ii. p. 248.) The pods are rarely above 6 in. long. The tree stands the cold better than the honey locust, and has ripened its fruit in Paris, in the Jardin des Plantes, and in the nursery of M. Cels. (*Diet. des Eaux et des Forêts*, vol. ii. p. 150.) The rate of growth, judging from young trees in the garden of the London Horticultural Society, and in the arboretum of the Messrs. Loddiges, is nearly the same as that of *G. triacanthos*. A full-grown tree of this species in the grounds at Syon, under the name of *G. hórrida*, 54 ft. high, diameter of the trunk 3 ft., and of the head 54 ft., is figured in our Second Volume. It is of less height, and with a more spreading head, than the American species in the same pleasure-grounds. It was introduced in 1774, and is generally propagated, in the British nurseries, by grafting on the common species.

Varieties.

‡ *G. s. 2 inermis* N. Du Ham., *G. japónica* Lodd. *Cat.*, *G. javánica* Lam., (see the plate of this tree in our Second Volume,) only differs from *G. sinensis* in being without spines, and being a less vigorous-growing tree. It seems a very desirable variety for small gardens.

‡ *G. s. 3 major* Hort., *G. hórrida major* Lodd. *Cat.*, seems scarcely to differ from the species.

‡ *G. s. 4 nana* Hort., *G. h. nana* in *Hort. Soc. Gard.*, (see the plate of this tree in our Second Volume,) is a tree of somewhat lower growth than the species, but scarcely, as it appears to us, worth keeping distinct.

‡ *G. s. 5 purpurea* Hort., *G. h. purpurea* Lodd. *Cat.*, (see our plate in Vol. II.,) is a small tree of compact upright growth, very suitable for gardens of limited extent.

Other Varieties of G. sinensis. In Loddiges's arboretum there is a plant marked *G. chinensis* (Potts), which was imported from China by the London Horticultural Society. It is, at present, a low bush, and may, perhaps, prove something distinct. There were also, in 1835, in the Horticultural Society's Garden, some plants without names, apparently belonging to this species; but, as we have already observed, the genus is in great confusion, and nothing perfectly satisfactory can be stated respecting it.

Statistics. The largest tree of this species in the neighbourhood of London is that at Syon, 54 ft. high, before noticed; in the Mile End Nursery is one 47 ft. high, diameter of the trunk 1 ft. 8 in., and of the head 46 ft.; in Dorsetshire, at Melbury Park, is one 26 years planted, and 25 ft. high; in Sussex, at West Dean, 14 years planted, and 42 ft. high; in Wiltshire, at Longford Castle, 25 years planted, and 25 ft. high; in Berkshire, at White Knights, 24 years planted, and 20 ft. high; in Suffolk, at Ampney Hall, 15 years planted, and 22 ft. high. In Scotland, in Lawson's Nursery, at Edinburgh, 10 years planted, and 12 ft. high; in the Perth Nursery, 25 years planted, and 7½ ft. high. In Ireland, in the Glasnevin Botanic Garden at Dublin, 20 years planted, and 12 ft. high. In France, in Paris, in the Jardin des Plantes, 40 ft. high; at Nerrrières, in the grounds of M. Vilmorin, 20 years planted, and 20 ft. high; in the Botanic Garden at Toulon, 50 years planted, and 36 ft. high. In Saxony, at Wörlitz, 36 years planted, and 30 ft. high; in Austria, at Vienna, in Rosenthal's Nursery, 17 years planted, and 20 ft. high. In Prussia, at Sans Souci, 10 years planted, and 16 ft. high. In Hanover, in the Botanic Garden at Göttingen, 25 years planted, and 30 ft. high.

‡ 5. *G. (s.) MACRACA'NTHA* Desf. The long-spined Gleditschia.

Identification. Desf. Arb., 2. p. 246; Don's Mill., 2. p. 428.

Synonymes. *G. ferox Baudr.*; Févier à grosses Épines, *Fr.*

Engraving. The plate of this species in our Second Volume.

Spec. Char., &c. Prickles strong, branchy, numerous. Leaflets lanceolate, somewhat rigid, notched, dentated. Pods elongated. (*Desf. Arb.*, ii. p. 246.) A deciduous tree with a prickly trunk; the prickles axillary, large; and the leaflets also large. It is said by Baudrillart to be a native of China (*Dict. des Eaux et des Forêts*, vol. ii. p. 150.); but when it was introduced is uncertain. The leaves are twice winged; the leaflets coriaceous, dark green, and shining on the upper surface. The young shoots are covered with extremely short hairs, and are of a purplish brown colour. On the whole, it bears a close resemblance to *G. sinensis*, of which it is, probably, only a variety. It is very hardy; and Desfontaines says that it fruits freely in France. The fruit ripens in the autumn; and the pods are long, pendulous, swelled, and rather cylindrical. They are filled with a sharp acrid pulp, somewhat resembling that of tamarinds, but the emanations from which, when inhaled, occasion sneezing.

Statistics. The largest tree in the neighbourhood of London is that at Syon, figured in our Second Volume: it is 57 ft. high, diameter of the trunk 3 ft., and of the head 63 ft. In Essex, at Audley End, is a tree, 60 years planted, which is 30 ft. high; and in Hertfordshire, at Cheshunt, one 7 years planted is 18 ft. high. In Ireland, at Terenure, is a tree 15 years planted, and 12 ft. high. Plants, in the London nurseries, are 3s. 6d. each; and at New York, 1 dollar.

‡ 6. *G. (s.) FEROX* Desf. The ferocious-prickled Gleditschia.

Identification. Desf. Arb., 2. p. 247.; Don's Mill., 2. p. 428.

Synonymes. *G. orientalis* Bosc; Févier hérissé, Fr.

Spec. Char., &c. Prickles large, robust, much compressed, trifid. Leaflets lanceolate, notched. (*Desf. Arb.*, ii. p. 247.) A tree, the trunk of which is thickly beset with strong branchy prickles, and which is supposed to grow from 30 ft. to 50 ft. in height; but of which the native country, and year of introduction into Britain, are unknown. Judging from the plants in the Horticultural Society's Garden, and those in the arboretum of Messrs. Loddiges, we should say it was only a variety of *G. sinensis*; though Desfontaines states the foliage and habit of growth to be somewhat different. It has not yet flowered in Europe. Plants, in the London nurseries, cost 2s. 6d. each.

‡ 7. *G. CASPICA* Desf. The Caspian Gleditschia.

Identification. Desf. Arb., 2. p. 247.; Don's Mill., 2. p. 428.

Synonymes. *G. caspiana* Bosc.

Spec. Char., &c. Prickles slender, trifid, compressed. Leaflets elliptic-lanceolate, obtuse. (*Desf. Arb.*, ii. p. 247.) A native of Persia, and found also near the Caspian Sea. Nothing is known of its flowers and fruit; but it strongly resembles *G. sinensis* (of which it is, probably, only a variety) in its leaves, general appearance, and habit. It was introduced into England in 1822; and there are plants of it in Loddiges's arboretum between 20 ft. and 30 ft. high. It is propagated by grafting on the common species; and plants, in the London nurseries, are from 1s. 6d. to 2s. 6d. each.

Variety.

‡ *G. c. 2 subvirescens* Hort., Févier verdâtre, Fr., is mentioned in the *Bon Jardinier* for 1836, as a variety of this species.

App. i. Other Sorts of Gleditschia.

Every modification of the species of this genus is so interesting, both in point of the elegance of its foliage, and the singularity of its prickles, that new varieties have been eagerly sought after by cultivators; and the genus seems particularly favourable to this desire, from the tendency of seedling plants to sport. Hence there are several names in collections, of which it is difficult to say anything satisfactory in the present young and immature state of the plants. In the Horticultural Society's Garden are *G. micracantha*, *G. Bôqui*, and *G. præcox*; and in Messrs. Loddiges's arboretum are plants marked *G. aquatica*, which are evidently the same as *G. monosperma*, *G. orientalis*, evidently *G. ferox*, *G. chinensis* (already mentioned); and some young plants without names. Though, from a careful examination of all the trees of this genus in the neighbourhood of London, last summer, we are of opinion that there cannot be more than two distinct species in British nurseries, yet we strongly approve of keeping all the varieties distinct; because, in point of ornament and effect in scenery, they are altogether as valuable as species. What two species, for example, can be more distinct than *G. triacanthos* and *G. t. inermis*, both in their winter and in their summer state, as may be seen by the plates in our Second Volume? *G. indica* Pers. is a Bengal species, not yet introduced, and probably tender.

GENUS XXI.



GYMNOCLADUS Lam. THE GYMNOCLADUS. *Lin. Syst. Diœ'cia*
Decândria.

Identification. Lam. Dict., 1. p. 733.; III., t. 823.; Dec. Prod., 2. p. 479

Derivation. From *gymnos*, naked, and *klados*, a branch; from the naked appearance of the branches during winter, when they seem, unless perhaps at the points of the shoots, totally devoid of buds.

Description. There is only one species, a deciduous tree, with upright branches, and inconspicuous buds.

‡ 1. G. CANADE'NSIS Lam. The Canada Gymnocladus, or Kentucky
Coffee Tree.

Identification. Lam. Dict., 1. p. 733., and III., t. 823.; Michx. Fl. Bor. Amer., 2. p. 241.; Dec. Prod., 2. p. 480.; Don's Mill., 2. p. 429.

Synonymys. *Guilandina dioica* Lin. Sp., 546.; *Hyperanthera dioica* Vahl Symb., 1. p. 31., *Duh. Arb.*, 1. t. 103.; *Nicker Tree*, *Stump Tree*, *United States*; *Bonduc*, *Chiquier*, *Fr.*; *Chicot*, *Canadianian*; *Canadischer Schusserbaum*, *Ger.*

Engravings. Reich. Mag., t. 40., *Duh. Arb.*, t. 103.; and our plates of this tree in Vol. II.

Spec. Char., &c. A deciduous tree, with branches blunt at the tip, bipinnate leaves, flowers in racemes, and whitish petals. The leaf has 4—7 pinnae; the lower of which consist each of but a single leaflet, the rest each of 6—8 pairs of leaflets. (*Dec. Prod.*, ii. p. 480.) A native of Canada, introduced in 1748; growing, in England, to the height of 30 ft. or 40 ft.; and flowering in August.

Description. In its native country, this tree grows to the height of 50 ft. or 60 ft., with a trunk from 12 in. to 15 in. in diameter. The branches have almost always an upright direction; and the appearance of the head, in the winter season, is remarkable, from being fastigiate, and from the points of the branches being few, and thick and blunt, as compared with those of almost every other tree. They are also wholly without the appearance of buds; and this latter circumstance, connected with the former, gives the tree, during winter, the appearance of being dead; and hence the Canadian name of *chicot*, or *stump tree*. The bark of the trunk is extremely rough, and detaches itself, after a certain age, in small, hard, transverse slips, rolled backwards at the end, and projecting sufficiently to distinguish the tree from every other, even at a distance. When the tree is clothed with leaves, the head forms a dense mass, roundish or oval. The leaves, on young thriving trees, are 3 ft. long, and 20 in. wide; but, on trees nearly full grown, they are not half that size. The leaflets are of a dull bluish green, and the branches of the petioles are somewhat of a violet colour. The flowers are white, in spikes of 2 in. or more in length: they appear from May to July, and are succeeded by large cimeter-shaped pods, 5 in. or more in length, and about 2 in. or more in breadth. The roots of the tree are few, thick, and directed downwards, as the branches are upwards, rather than horizontally.

Geography. The gymnocladus grows in Upper Canada, beyond Montreal, and on the borders of Lakes Ontario and Erie; but it is only sparingly found in these places, which are its northern limits. It is abundant in Kentucky and Tennessee, in the tracts which border the Ohio and Illinois rivers, between lat. 35° and 40° N. It is there found along with *Juglans nigra*, *Ulmus rubra*, *Liriodendron Tulipifera*, *Fraxinus quadrangulata*, *Gleditschia triacanthos*, and more especially with *Celtis occidentalis*. It is never found but on the very richest soils.

History. This tree was introduced into England in 1748, and was cultivated by Archibald Duke of Argyll, at Whitton, where it is believed the original tree still exists. Being very hardy, and remarkable for the beauty of its foliage during summer, it has found its way into most collections in England, and is also cultivated in France and the south of Germany.

Properties and Uses. The wood is very hard and compact; it is also strong and tough, and of a fine rose colour. In America, it is used both in cabinet-making and carpentry, and, like the wood of the robinia, it has the remarkable property of rapidly converting its sap-wood into heart-wood; so that a trunk 6 in. in diameter has not more than six lines of sap-wood, and may, consequently, be almost entirely employed for useful purposes. The seeds were, at one time, roasted and ground as a substitute for coffee in Kentucky and Tennessee; but their use in this way has been long since discontinued. The pods, preserved like those of the tamarind (to which this genus is nearly allied), are said to be wholesome, and slightly aperient. The live bark is extremely bitter; so that a morsel, no bigger than a grain of maize, chewed for some time, causes a violent irritation in the throat. In Britain, the only use of the tree is for ornamental purposes; and, considered as an object of curiosity and beauty, no collection ought to be without it.

Soil, Situation, Propagation, &c. A rich, deep, free soil is essential to the thriving of this tree; and such a soil is never met with naturally in exposed situations. The tree is generally propagated by imported seeds; but it will grow freely from cuttings of the roots, care being taken in planting to keep that end upwards which is naturally so.

Statistics. *Gymnocladus canadensis* in England. In the environs of London, at Whitton, 87 years planted, and 60 ft. high; at Syon, 54 ft. high, diameter of the trunk 18 in. and of the head 59 ft. (see our plate of this tree in Vol. II.); in the Mile End Nursery, 35 ft.; at Kenwood, 25 years planted, and 20 ft. high.—*South of London.* In Kent, at Cobham Hall, 25 years planted, and 20 ft. high. In Surrey, at St. Anne's Hill, 30 years planted, and 45 ft. high; at Claremont, 45 ft. high, the diameter of the trunk 18 in., and of the head 35 ft.; at Walton, 42 years planted, and 50 ft. high, diameter of the trunk 18 in., and of the head 33 ft.; at Farnham Castle, 45 years planted, and 25 ft. high, the diameter of the trunk 12 in., in poor soil on chalk.—*North of London.* In Cheshire, at Kimmel Park, 5 years planted, and 5 ft. high. In Hertfordshire, at Cheshunt, 7 years planted, and 12 ft. high. In Oxfordshire, in the Oxford Botanic Garden, 40 years planted, and 35 ft. high, the diameter of the trunk 1 ft. 2 in., and of the head 15 ft. In Worcestershire, at Croome, 40 years planted, and 60 ft. high, diameter of the trunk 18 in., and of the head 30 ft.

Gymnocladus canadensis in Scotland. In the Edinburgh Botanic Garden, 15 ft. high; in Lawson's Nursery, 10 years planted, and 6 ft. high; in the Glasgow Botanic Garden, 12 years planted, and 13 ft. high; in the Perth Nursery, 12 ft. high.

Gymnocladus canadensis in Ireland. In the Glasnevin Botanic Garden, 25 years planted, and 24 ft. high, diameter of the trunk 6 in., and of the head 7 ft.; at Terenure, 20 years planted, and 15 ft. high; in the Cullinstown Nursery, 10 years planted, and 15 ft. high.

Gymnocladus canadensis in Foreign Countries. In France, at Paris, in the Jardin des Plantes, 60 years planted, and 55 ft. high, the diameter of the trunk 20 in., and of the head 40 ft.; at Sec'aux, 18 years planted, and 30 ft. high; in the Botanic Garden at Toulon, 20 years planted, and 25 ft. high; in the Botanic Garden at Metz, 32 years planted, and 40 ft. high; at Colombier, near Metz, 60 years planted, and 65 ft. high. In Austria, at Vienna, 13 years planted, and 30 ft. high. In Prussia, at Berlin, at Sans Souci, 30 years planted, and 30 ft. high; in the Pfauen Insel, 8 years planted, and 22 ft. high. In Hanover, in the Botanic Garden at Göttingen, 25 years planted, and 30 ft. high. In Italy, at Monza, 29 years planted, and 40 ft. high.

Commercial Statistics. Plants in the London nurseries are 2s. 6d. each; at Bollwyller, 1 franc and 50 cents; and at New York, 50 cents.

GENUS XXII.



CERCIS L. THE JUDAS TREE. *Lin. Syst. Decándria Monogýnia.*

Identification. *Lin. Gen.*, No. 510.; *Lam. Ill.*, t. 328.; *Gært. Fruct.*, t. 144.; *Dec. Prod.*, 2. p. 518.; *Don's Mill.*, 2. p. 463.

Synonymes. *Siliquastrum Tourn. Inst.*, t. 414.; *Manch Meth.*; *Gaimier Fr.*; *Judasbaum, Ger.*

Derivation. From *kerkis*, a shuttlecock, the name given by Theophrastus to this tree.

Description, &c. Leaves simple, heart-shaped at the base, many-nerved, entire, protruded after the flowers; these borne in groups, each on a pedicel proceeding directly from the trunk or branches. (*Dec. Prod.*, ii. p. 518.) Deciduous trees of the third rank, or shrubs, natives of Europe, or North America.

† 1. *C. SILIQUA'STRUM L.* The common Judas Tree.

Identification. *Lin. Sp.*, 534.; *Dec. Prod.*, 2. p. 518.; *Don's Mill.*, 2. p. 463.

Synonymes. *Siliquastrum orbiculatum Manch Meth.*; *Love Tree*; *Gaimier commun, Arbre de Judée, Fr.*; *Arbol d' Amor, Span.*; *Judasbaum, Ger.*

Engravings. *N. Du Ham.*, t. 7.; *Bot. Mag.*, t. 1138.; *Mill. Icon.*, 253.; and the plates of this species in Vol. II.

Spec. Char., &c. Leaves very obtuse, and wholly glabrous. A native of the south of Europe, in sunny places, and on the banks of rivers. Flowers of a deep rose colour; in a variation, white. (*Dec. Prod.*, ii. p. 518.) A deciduous tree, a native of the south of Europe, introduced in 1596. Height from 20 ft. to 30 ft.

Varieties.

- ✻ C. S. 2 *parviflorum* Dec.—A shrub; its branches spotted with white; its flowers smaller by half than those of the species. A native of Bokhara. (*Dec. Prod.*, ii. p. 518.)
- ✧ C. S. 3 *flore albido*.—Flowers whitish. There is a plant of this in the London Horticultural Society's Garden.
- ✧ C. S. 4 *roscæ*.—A seedling, raised from foreign seeds, which has flowered in the Botanic Garden at Kew; has numerous flowers, which are brighter, and a shade darker, than those of the species; and they also appear about a fortnight later; but it is, perhaps, hardly worth noticing as a variety.

Description, &c. The common Judas tree, in the south of Europe, forms a handsome low tree, with a flat spreading head, in the form of a parasol; and it is a singularly beautiful object in spring, especially when it is covered with its numerous bright purplish pink flowers, which appear before the leaves, in May, and are produced not only from the young wood, but from wood of 6 or 8 years' growth, and even from the trunk. The leaves are round and heart-shaped, and are not liable to be attacked by insects. The flowers are succeeded by flat, thin, brown pods, nearly 6 inches in length, which remain on the tree all the year, and give it a very singular appearance in the winter season. In moist seasons, the tree often flowers a second time in the autumn. In the neighbourhood of London, the tree generally flowers freely; but the pods are not produced in abundance, unless the tree is planted against a wall; and only sparingly, and in the finest seasons, on standard trees. The rate of growth is about 18 in. a year, for the first ten years.

Geography and History. The Judas tree is found in a wild state in the south of France, in Spain, in Italy, about Rome; in Greece, in Japan, in Asiatic Turkey, and more especially in Judea. It was cultivated by Gerard in 1596, who has given a good figure of it, and says, "The Frenchmen call it *gnainier*, as though they should say, *vaginula*, or a little sheath: most of the Spaniards name it *algorovo loco*; that is, *Siliqua sylvestris fatui* (wild or foolish pod); others, *arbol d' amor*, for the braveness' sake. It may be called, in English, Judas tree; for it is thought to be that on which Judas hanged himself, and not upon the elder tree, as it is vulgarly said." (*Johns. Ger.*, 1428.) From the tree being easily propagated by seeds, which are received in abundance from the Continent, it has become very general in English gardens; in the neighbourhood of London as a standard, and, to the north, planted against a wall. The French plant it against walls, and also cover arbours with it; and, formerly, it used to be clipped into balls, and other geometrical figures, in British gardens.

Properties and Uses. The wood is very hard, and agreeably veined, or rather blotched or waved, with black, green, and yellow spots, on a grey ground. It takes a beautiful polish, and weighs nearly 48 lb. to the cubic foot. The flowers, which have an agreeable acid taste, are mixed with salads, or fried with batter, as fritters; and the flower buds are pickled in vinegar. In British gardens, the tree is planted as one of ornament; and, as it grows about the same height, and flowers about the same time, as the laburnum, the Guelder rose, and the hawthorn, it enters into beautiful combination with these and other trees. The foliage is hardly less beautiful and remarkable than the flowers; the leaves being of a pale bluish green on the upper surface, and of a sea-green underneath, and of a cordate uniform shape, apparently consisting of two leaflets joined together; which circumstance, combined with others, brings the genus in close alliance with that of *Bauhinia*.

Soil, Situation, &c. Like most of the Leguminææ, this tree prefers a deep, free, sandy soil, rich rather than poor; and it will only thrive, and become a handsome tree, in sheltered situations. In the northern parts of the island, it requires to be planted against a wall; and few ornamental trees better deserve such a situation. The species is propagated by seeds, and the varieties by grafting. The seeds are sown on heat early in spring, and come up the same season; and the plants will produce flowers in three or four years.

Statistics. Cér'cis Siliquástrum in the Environs of London. At Syon, 20 ft. high, the diameter of the trunk 14 in., and of the head 39 ft.; at Fulham Palace, 90 years planted, and 25 ft. high, the diameter of the trunk 17 in., and of the head 25 ft.; at Purser's Cross, in the Mile End Nursery, and in the grounds of an adjoining villa, from 20 ft. to 30 ft. high; at Kenwood, 38 years planted, and 18 ft. high; in the Brompton Nursery, a handsome tree, 21 ft. high; in the arboretum at Kew, 25 ft. high.

Cér'cis Siliquástrum South of London. In Hampshire, at Leigh Park, 7 years planted, and 10 ft. high. In Wiltshire, at Longford Castle, 30 ft. high, the diameter of the trunk 12 in. and of the head 20 ft.

Cér'cis Siliquástrum North of London. In Bedfordshire, at Amptill, 20 years planted, and 15 ft. high. In Berkshire, at White Knights, 25 years planted, and 20 ft. high. In Oxfordshire, in the Botanic Garden at Oxford, 16 years planted, and 18 ft. high. In Suffolk, at Ampton Hall, 10 years planted, and 12 ft. high. In Warwickshire, at Whitley Abbey, 18 years planted, and 13 ft. high. In Worcestershire, at Croome, 40 years planted, and 30 ft. high, diameter of the trunk 18 in., and of the head 18 ft.

Cér'cis Siliquástrum in Scotland. The tree is generally planted against a wall, and will cover about the same space as a peach tree in 10 or 12 years. There is a fine specimen in the Edinburgh Botanic Garden. In Berwickshire, at the Hirsell, a standard tree, 7 years planted, is 6½ ft. high. In Aberdeenshire, at Thainston, the tree makes shoots upwards of 2 ft. long every year; but they are generally killed back to the stump every winter; at Gordon Castle, 8 years planted, it is 9 ft. high against a wall.

Cér'cis Siliquástrum in Ireland. At Dublin, in the Glasnevin Botanic Garden, 25 years planted, it is 14 ft. high; at Terenure, 10 years planted, it is 10 ft. high; at Cullenswood Nursery, 30 years planted, it is 30 ft. high. At Castleton, it is 15 ft. high. In Connaught, at Coole, 10 ft. high. In Sligo, at Makree Castle, it is 12 ft. high, against a wall; the branches extending over a space 45 ft. in width.

Cér'cis Siliquástrum in Foreign Countries. In France, at Paris, in the Jardin des Plantes, 60 years planted, it is 40 ft. high, the diameter of the trunk is 29 in., and of the head 45 ft.; at Scéaux, 20 years planted, it is 40 ft. high; in the Botanic Garden at Toulon, 50 years planted, it is 35 ft. high; at Nantes, in the nursery of M. De Nerrières, 50 years planted, it is 30 ft. high. In Saxony, at Wörlitz, 25 years planted, and 10 ft. high; the tree requiring protection during winter. In Austria, at Vienna, in the University Botanic Garden, 9 years planted, and 16 ft. high. In Prussia, at Berlin, in the Pfauen Insel, 9 years planted, and 6 ft. high. In Hanover, in the Botanic Garden at Göttingen, 20 years planted, and 12 ft. high. In Italy, at Monza, 40 years planted, and 26 ft. high.

Commercial Statistics. Price of plants, in London, from 1s. 6d. to 2s. 6d. each; and seeds 1s. 6d. an ounce: at Bollwyller, 1 franc, and the white-flowered variety 2 francs: at New York, the species is 37½ cents.

‡ 2. *C. CANADÉNSIS L.* The Canada Judas Tree.

Identification. Lin. Sp., 534; Dec. Prod., 2. p. 518; Don's Mill., 2. p. 463.

Synonymes. *Siliquástrum cordatum Munch Meth.*; red Bird Tree, *Amer.*; Gainier de Canada, Bouton rouge, *Fr.*

Engraving. Mill. Icon., t. 2.; and our plate in Vol. II.

Spec. Char., &c. Leaves acuminate, villose beneath at the axils of the veins. As compared with *C. Siliquástrum*, its flowers are of a paler rose colour the legume is on a longer pedicel, and tipped with a longer style. A native of North America, on the margins of rivers, from Canada to Virginia. (*Dec. Prod.*, ii. p. 518.)

Varieties.

‡ *C. c. 2 pubescens Ph.*—Leaves pubescent on the under surface. (*Dec.*)

‡ *C. c. 3, Foreman's new variety*, is mentioned in Prince's *Catalogue*, published in New York, in 1829.

Description, &c. This tree bears a general resemblance to the preceding species; but it is more slender and smaller in all its parts; and it seldom rises higher than 20 ft. It is at once distinguished from *C. Siliquástrum* by its leaves being heart-shaped and pointed; they are also much thinner, more veined, and of a lighter green; and the flowers are generally produced in smaller numbers than in the other species. It is a native of North America, from Canada to Virginia, along the banks of rivers; and the flowers are there used by the French Canadians in salads and pickles, and the young branches to dye wool of a nankeen colour. The wood resembles that of the other species. The tree was introduced into England in 1730; but it has never been much cultivated; though, in France and Germany, it is considered to be

more hardy than the European species. In Britain, it is propagated by imported seeds, and is considered more tender than *C. Siliquastrum*; but it would probably be rendered more hardy by being grafted on that species.

Statistics. In the environs of London, it is seldom found higher than 10 ft. or 12 ft.; and then it has more the character of a bush than of a tree; but on the Continent there are some good specimens. In France, at Paris, in the Jardin des Plantes, 55 years planted, it is 36 ft. high, the diameter of the trunk, 10 in., and of the head 20 ft.; in the Rue Grenelle, in Paris, in the garden of the house No. 192., as we are informed by Mr. Blaikie, there is a tree 40 ft. high, with a trunk $1\frac{1}{2}$ ft. in diameter. In Saxony, at Wörlitz, 25 years planted, it is 10 ft. high. In Austria, at Vienna, in the University Botanic Garden, 9 years planted, it is 16 ft. high. In Italy, at Monza, 24 years planted, it is 13 ft. high.

Commercial Statistics. Plants, in the London nurseries, are 1s. 6d. each, and seeds 1s. 6d. per ounce; at Bollwyller, plants are 1 franc each; and at New York, the plants of the species are from 25 to 37½ cents each, and of "Foreman's new variety," 37 cents each.

App. I. Half-hardy Species of the Tribe Cassiæ.

Cesalpinia Ait. is a genus of beautiful flowering trees and shrubs, most of the species of which are natives of tropical countries, and which, in England, are generally kept in stoves; but there is one species, *C. Lebbekoides* Dec., a native of China, which, if once introduced, would probably be a valuable addition to a conservative wall.

Cædia varia L'Hérit. (*Don's Mill*, 2. p. 435.) is a shrub, a native of Arabia Felix, with impari-pinnate leaves; and flowers, at first white, but, as they fade, becoming rose-coloured. It was introduced in 1777, and might be tried against a wall.

Zuccagnia Cav. is a Chilian genus, of which the species are probably half-hardy. *Z. punctata* Cav. *Icon*, 5. p. 2. t. 403., has abruptly pinnate leaves, and saffron-coloured flowers. It grows to the height of 4 ft. or 5 ft.

Ceratonia Siliqua L. (*Bot. Rep.*, t. 567., and our figs. 365, 366) is a very interesting tree, a native of the south of Europe, particularly Spain; it is also found in Mauritania and the Levant. The leaves are abruptly pinnate; the leaflets oval, obtuse, flat, coriaceous, and of a shining dark green. The flowers are polygamous or dioecious, and without petals. The tree grows to the height of from 30 ft. to 50 ft. In the south of Europe, when the fruit is perfectly ripe, the pulp contained in the pods is eaten by men, the seeds by horses, and the husks by swine; hence, probably, the popular English name of sow's bread. When unripe, the fruit is considered very unwholesome, and even dangerous, to the cattle that feed on it. The Egyptians make a kind of honey of the pulp, which serves the Arabs instead of sugar; they also make a preserve like that made with tamarinds of the pods, which is a gentle laxative. This fruit was anciently supposed to be what St. John fed on in the wilderness; hence its name of St. John's bread; the seeds being said to be meant by the word translated "locusts;" and the pulp by the term "wild honey." The husks are thought to have been the dry and wretched food that the Prodigal Son was

365



366



driven to long for, in the last stage of his misery and starvation. The plant has been in British green-houses since 1750; and the male plant has flowered every autumn, for many years past, in the Mile End Nursery. This tree will very nearly stand the open air in the vicinity of Paris; and, if planted against a wall in the neighbourhood of London, it would probably stand with very little protection. Its fine large coriaceous dark green foliage ought to be a strong inducement for every one who has an opportunity to give it a trial. As a fruit tree, it may merit introduction into Australia, for which purpose the seeds can be readily procured from Spain. It is remarked in the *Nouveau Du Hamel*, l. p. 255., that, when the ripe fruit has been eaten by oxen or mules, the seeds which have passed through them without digestion vegetate much sooner than when they are sown in the natural manner. The tree is of slow growth, and the wood is extremely hard and durable. Its roots attach themselves so firmly to the soil, that, in Spain, even in the most exposed situations, in the gullies of mountains for example, the tree has never been known to be blown down by the wind, so as to be torn up by the roots, though large branches have been broken off it by storms.

Castanospermum australe Cunningham (*Hook. Bot. Misc.*, l. p. 241. t. 51. and t. 52.) is a New Holland tree, growing to the height of 40 ft. or 60 ft., the legumes of which are produced from two years' old wood; and they contain seeds as large as Spanish chestnuts, which are eaten roasted by the natives about Botany Bay. As one of the few New Holland trees which produce edible fruit, it is highly interesting, and well deserves a place against the conservative wall, adjoining *Ceratonia*.

Cassia L. is a genus consisting chiefly of tropical shrubs or herbs, with abruptly pinnate leaves, and yellow flowers, most of which require to be kept in the stove; but *C. Barclayana* Swt. (*Fl. Austr.*, t. 32., and our fig. 367.) and *C. australis* Hook. (*Bot. Mag.*, t. 2676., and our fig. 368.) are natives of New Holland, growing to the height of 3 ft. or 4 ft., and producing their fine showy yellow blossoms from June to August. The semina of the druggists is produced from the leaves of two species of this genus, *C. lanceolata* and *C.*



367

368



369

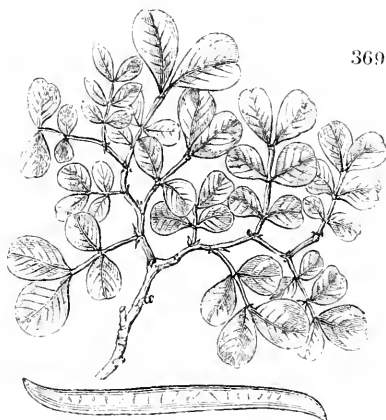

obovata, both stove plants, and natives of Egypt; though the latter, which is called Italian senna, is found about Rome.

Chamaefistula (from *chamai*, ground, and *fistula*, a pipe; on account of the species being comparatively dwarf, and of its cylindrical pods) Don's *Mill.*, ii. p. 451., is a genus separated from *Cassia*, and consists of 27 species. *C. corymbosa* G. Don, *Cassia corymbosa* Lam. (*Dict.*, i. p. 644., *Bot. Mag.*, t. 633., and our fig. 370.), affords a very good example of the genus. It is a native of Buenos Ayres, where it grows to the height of 8 ft. or 10 ft.; and it would form a very handsome plant against a conservative wall.

Schöbia stipulata Ait. and *S. alata* Thunb. are Cape shrubs, with crimson flowers, now kept in stoves and green-houses, but well deserving trial against a conservative wall. *S. latifolia* Jacq. (*Fragm.*, 23. t. 15. f. 4., and our fig. 369.) which was introduced in 1816, and grows to the height of 6 ft., will give an idea of the general appearance of plants of this genus. In their native country, the species of this genus are of slow growth, and they form bushes rather than trees. Mr. Bowie observes that planting them under the shade of taller-growing shrubs, or of trees, will draw them up, and, at the same time, not injure them, or preclude them from displaying their beautiful flowers. These flowers, in all the varied species of *Schöbia*, are produced occasionally on the old wood, though chiefly at the extremity of the young spring and summer shoots; a habit which ought always to be kept in view in pruning the plants.



App. I. Other half-hardy lignaceous Species of the Order Leguminæcæ.

There being no truly hardy species belonging to the tribes Dalbergiæcæ, Mimòscæ, and Geóffræcæ of this order, we are necessarily obliged to devote a separate appendix to them.

§ i. Dalbergiæcæ.

Sect. Char. The species are for the most part climbing shrubs, with impari-pinnate leaves, rarely, but sometimes, pinnately-trifoliolate, or simple. (*Don's Mill.*, ii. p. 373.)

Dérris sericea G. Don is a Nepal shrub, with small yellow flowers, and leaves covered with a silky pubescence. *D. trifoliata* Lour. is a climbing shrub, a native of China, not yet introduced.

Pterocárpus peltárius Dec. Lég. Mém., 10. t. 57. f. 2., is a tree, a native of the Cape of Good Hope, not yet introduced.

§ ii. Mimòscæ.

Sect. Char. Flowers regular, usually polygamous, rarely all hermaphrodite. Stamens inserted with the petals, free or monadelphous, equal in number to the petals, or forming a multiple of that number. Leaves abruptly pinnate, or abruptly bipinnate. (*Don's Mill.*, ii. p. 381.)

Prosòpis L. is a genus of Indian or American trees, of which scarcely any species have been introduced; but *P. glandulosa* Torrey (*Ann. Lyc.*, 2. p. 192. t. 2.) is a native of North America, on the Canadian river, where it is called the algaroba tree. There is a plant belonging to this genus, a native of Chili, and, possibly, hardy, *P. Siliquastrum* Dec. (*Don's Mill.*, ii. p. 400.), which has stood against the wall in the Horticultural Society's Garden, with very little protection, since the year 1832.

Lagonýchium Stephanianum Bieb. *Supp.*, *Acácia Stephaniana* Fieb. Fl. Taur., *Mimòsa micrantha* Vahl, (*Brcyn. Cent.*, 1. t. 56. f. 4.) is a small shrub, with scattered prickles, and bipinnate leaves, a native of the arid plains between Caucasus and the Caspian Sea; and of Persia, between Mossul and Bagdad. It was introduced in 1816, grows to the height of 2 ft., and flowers in July and August.

It will grow in a warm situation in the open border, and requires only a slight protection during the most severe winter.

Acacia Neck. This is a very extensive genus of shrubs or trees, with beautiful foliage and flowers, and of intense interest to the British gardener, because, in mild winters, they are found to live in the open air, as standards, attain a tree-like size in 2 or 3 years, and flower profusely, very early in the spring. They are all of easy propagation, either by cuttings or from seeds, either imported or produced in this country; and their growth is so rapid, that plants 2 years established have been known to make shoots 16 ft. long in one season. In dry sandy soils, and in sheltered situations, the greater number of the species of *Acacia* might be grown together as a wood or thicket, by which means the plants would protect one another; and though their tops might be annually killed down for 2 ft. or 3 ft. by the frost, yet, the dead portions being cut off annually in May, the plants would grow again with vigour. An Australian forest might not be realised in this way in England, but some allusion might be created to an Australian coppice wood. The genus *Acacia*, which, as G. Don observes, is a very polymorphous one, and may probably hereafter be separated into several genera, when the species are more perfectly known, is divided into numerous sections, from which we shall select a few species, and refer the reader for the rest to our *Hortus Britannicus*.

1. *Phyllodineæ*.

Sect. Char. Leaves of two forms: those in seedling plants are bipinnate; but in adult plants the leaflets are abortive, and there only remains the dilated petiole, which is called a phyllodium. The species are mostly natives of New Holland. (*Don's Mill.*, ii. p. 401.)

A. Capitata. Flowers collected into globular Heads; Heads solitary on the Peduncles.

a. *Stipules aculeate.*

A. alata R. Br. (*Bot. Reg.*, 326., and our *fig.* 371.) Stem bifariously winged; dilated petiole decurrent, 1-nerved, ending in a spine at the apex. Heads of flowers solitary, or in pairs. A native of New Holland, on the western coast. Introduced in 1803, and flowering from April to July. It grows to the height of 6 ft. or 10 ft.

A. armata R. Br. (*Bot. Mag.*, 1653., and our *fig.* 372.) has the phyllodia, or dilated petioles, ob-

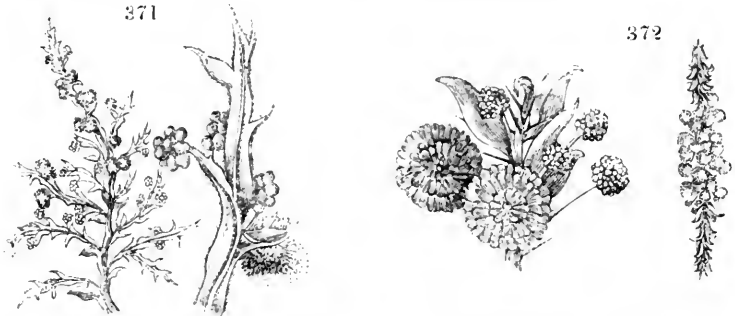

liquely ovate-oblong; the heads of flowers solitary, and the legumes velvety. This is a well-known inhabitant of our green-houses, in which it flowers from April to June, and frequently ripens seeds. It is a native of the southern coast of New Holland, and was introduced in 1802. It grows to the height of 8 ft. or 10 ft. in pots, and in a cold-pit, or against a wall: it requires only to have the frost excluded. There is a plant 10 ft. high, against a wall, in the Chelsea Botanic Garden; and there is one at Cuffnells, in Hampshire, which has stood against a wall with a north aspect since 1832, protected with a mat during frosty weather; and flowering freely in February, March, and April. In the Upway Nursery, near Rochester, plants have stood in the open border for 5 years, and have ripened seeds, which have dropped, and produced young plants. At Airthrey Castle, Stirlingshire, a plant of *A. armata* stood out against a wall, without the slightest protection, during the winters of 1833 and 1834; and, in 1835, was 4 ft. high.

A. juniperina Willd., *Mimosa juniperina* Vent. *Ill.*, *M. ulicifolia* Wendl., *A. verticillata* Sieb. (*Bot. Cab.*, t. 398., and our *fig.* 373.) is a native of the eastern coast of New Holland; which was introduced in 1790; and grows to the height of 8 ft. or 10 ft. It flowers from March to July; and sometimes, in fine seasons, ripens seed.

b. *Stipules not aculeate, and either very small or wanting.*

A. diffusa Ker (*Bot. Reg.*, t. 624.), *A. prostrata* Lodd. (*Bot. Cab.*, t. 631., and our *figs.* 374, 375.), has the dilated petioles linear, and the branches diffusely procumbent. It is a native of New South Wales, on the Blue Mountains; was introduced in 1818; and flowers from April to June.

A. stricta Willd., *Mimosa stricta* Bot. *Mag.*, t. 1121., and our *figs.* 376, 377., is an upright-growing shrub, from the eastern coast of New Holland, flowering from February to May. It was introduced in 1690, and grows to the height of 6 ft.

374



375



376



377

A. aurifolia Willd. (*Labill. Nov. Cal.*, p. 68. t. 68.), *Mimosa sirapiçifolia* L., has the dilated petioles obliquely ovate-oblong. It is a native of the Friendly Islands and the New Hebrides, as well as of New Caledonia, where it forms a tree from 20 ft. to 25 ft. in height. It was introduced in 1775; but, though a most desirable species for a conservative wall, it is not common in collections.

B. Capitato-racemosa. Flowers collected in globose Heads; the Heads disposed in Racemes along the axillary Peduncles. Stipules of all the Species nearly obsolete, or, when present, not aculeate. (Don's Mill., ii. p. 404.)

A. melanoxylon R. Br. (*Bot. Mag.*, t. 1659, figs. 378, 379.) has the dilated petiole lanceolate-oblong, rather falcate, obtuse, quite entire, and many-nerved. The flowers are few, and disposed as in the figure. This is a native of New Holland, and also of Van Diemen's Land; and, in mild winters, it will grow in the open air, in the neighbourhood of London, as a standard, attaining the height of 10 ft. or 12 ft., after being 2 or 3 years planted out. A fine tree of this species stood out three winters, in the garden of the Horticultural Society, as a standard, but was killed, or nearly so, by the severe frost of January, 1836. A plant against the wall in the same garden, which had stood

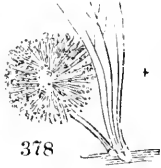

378

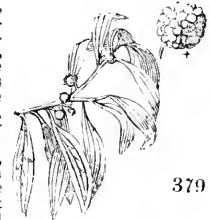

379

out since 1831, with no other protection than a projecting coping, was also much injured at the same time. Had there been a protection in front, and had the standard been covered with a mat, both would have escaped uninjured. In the Norwich Nursery, this acacia stands the winter.

A. heterophylla Willd., *Mimosa heterophylla* Lam. Dilated petioles, linear, attenuated at both ends, rather falcate, many-nerved; there are also, sometimes, bipinnate leaves at the tops of the branches. Heads of flowers disposed in a kind of raceme; 2-3 heads to each raceme. Introduced, in 1824, and, probably, tolerably hardy; as, in the garden of the palace at Caserta, near Naples, it was 50 ft. high in 1834.



380

A. myrtifolia Willd., *Mimosa myrtifolia* Sm., *A. lanata* Lodd. (*Bot. M.*, 302, and our fig. 380.) is a handsome and very hardy species, which has been in the country since 1789, and grows to the height of 6 ft. or 8 ft.

A. suaveolens Willd., the *Mimosa suaveolens* of Smith (*Lodd. Bot. Cab.*, 730., and our fig. 381.), has the dilated petioles

381



linear; tapering a little at the base, acute, mucronulate, 1-nerved, quite entire; the heads of flowers racemose; and the legumes glaucous from grey powder. The flowers are fragrant, and appear from February to June. This species was introduced in 1790, and grows to the height of 8 ft. or 10 ft.

C. Spicata. Flowers disposed in cylindrical Spikes. Stipules usually wanting, or, when present, small and not aculeate. (Don's Mill., ii. p. 406.)

A. Oxycedrus Sieb. (*Bot. Mag.*, t. 2928.), *A. taxifolia* Lodd. (*Bot. Cab.*, t. 1225., and our figs. 382, 383.), has the stipules spinose; the dilated petioles scattered, or somewhat verticillate, lanceolate-linear, and



382

383

ending in a pungent point. It is a native of New South Wales, and grows to the height of 10 ft., flowering from April to July.

A. verticillata Willd. (*Bot. Mag.*, 110., and our fig. 384.) has the dilated petioles linear, and disposed verticillately. It is a well-known species, easily recognised by the figure, a native of Van Diemen's Land, which has been in cultivation in England since 1780, flowering from March till May, and occasionally ripening seeds, even in the open air. A plant of this species in the Horticultural Society's Garden stood out as a standard, with very little protection, from 1832 till January, 1836; when it was killed, or much injured, by the severe frost. It had, however, no protection. One in the same garden, against the wall,



384

was also much injured; but it had no protection in front. *A. v. 3 latifolia* Dec. has stood out against a wall in the Horticultural Society's Garden since 1831.

2. *Conjugato-pinnatae.*

Sect. Char. Leaves with one pair of pinnae, each pinna bearing few or many pairs of leaflets. This is an artificial section, composed of a heterogeneous assemblage of species, the most part of which are not well known. (*Don's Mill.*, ii. p. 408.)

A. gummifera Willd. has the pinnae bearing 6 pairs of linear obtuse leaflets. It is a native of the north of Africa, near Mogador, where it forms a tree of the middle size, and yields the gum Arabic, in common with several other species. It was introduced in 1823.

A. coronillaefolia Desf. is a tree from the same country, introduced in 1817.

A. pulchella R. Br. (*Bot. Cab.*, t. 212. and our figs. 385, 386.) is a smooth shrub, with the pinnae bearing 5—7 pairs of oblong-ovate obtuse leaflets, and having its heads of flowers solitary. It is a native of New Holland; was introduced in 1803; and grows to the height of 5 ft. or 6 ft.

A. delincens Burch. (*Don's Mill.*, 2. p. 408.) and *A. viridramis* Burch. (*Ibid.*) are natives of the Cape of Good Hope, which have been some years in British green-houses. They both grow to the height of from 3 ft. to 6 ft., and continue flowering from April to July.



385

386

3. *Spiciflorae.*

Sect. Char. Leaves bipinnate, with few or many pairs of pinnae, each pinna bearing many pairs of leaflets. Flowers disposed in spikes. (*Don's Mill.*, ii. p. 409.)

A. *Unarmed Trees or Shrubs.*

A. lophantha Willd., *Mimosa elegans* *Bot. Rep.*, (*Bot. Cab.*, t. 716., and our fig. 387.), is a species in very general cultivation. It will grow to the height of 6 ft. or 8 ft. in 2 or 3 years from the seed, flowering the first year. It was introduced in 1803, from New Holland; and its fine yellow flowers, which are somewhat fragrant, are produced from May to July. There is a plant of it against the wall, in the Horticultural Society's Garden, 10 ft. or 12 ft. high; one at Abbotsbury Castle, Dorsetshire, growing as a standard in the open air, without the slightest protection, which is 40 ft. high, and ripens its seeds freely; and one in the grounds of E. Pendarvis, Esq., at Pendarves, Cornwall, which is 20 ft. high.



387

B. *Prickly or spiny Trees or Shrubs.*

A. cafra Willd., *Mimosa cafra* *Thunb.*, has leaves with 5—10 pairs of pinnae, each pinna bearing 20—30 pairs of lanceolate-linear leaflets. It is a native of the Cape of Good Hope, introduced in 1800; and forms a tree from 12 ft. to 20 ft. high.

A. albidia Delil. (*Fl. Egypt.* 143., t. 52. f. 3.), the Egyptian thorn, has straight stipular prickles, and leaves with 3—4 pairs of pinnae, each pinna bearing 9—10 pairs of oblong-linear glaucous leaflets. It is a native of Upper Egypt, where it grows to the height of 20 ft.

4. *Globiflora*

Sect. Char. Flowers collected into globose heads on the tops of the peduncles. Leaves bipinnate, with few or many pairs of pinnae, each pinna bearing few or many pairs of leaflets. (*Don's Mill.*, ii. p. 413.)

A. *Prickles stipular and straight. Legumes unarmed. Stamens 20, or more.*

A. *farnesiàna* Willd., *Mimosa farnesiàna* L., *Mimosa scorpioides* Forsk., *Gazia, Ital.*, (*N. Du Ham.*, 2. t. 28., and our *fig.* 388.) is a charming shrub or low tree, a native of St. Domingo, but in cultivation in the south of Europe, and north of Africa, in gardens, since the year 1611; when, according to Du Hamel, the first plant was raised from seeds, in the garden of the Villa Farnese, at Rome. It grows in the open air in the south of France, Spain, Portugal, and Italy, where it is highly valued for the beauty and fragrance of its flowers. It was introduced into England in 1556, and cultivated in green-houses; but, since the great influx of New Holland acacias, it has been comparatively neglected. In the year 1819, we saw it in the open ground in several Italian gardens.



388

B. *Prickles stipular, in Pairs, usually also petiolar, and along the Ribs of the Legume. Stamens 10.*

A. *Cavènia* Hook., *Mimosa Cavènia* Moll., is a tree, growing to the height of 20 ft. in the woods of Chili. The flowers are very fragrant, and the wood is considered to make the best charcoal.

C. *Unarmed. Anthers smooth. Stigma simple.*

A. *nigricans* R. Br., *Mimosa nigricans* Labill., (*Bot. Mag.* t. 2188., and our *figs.* 389, 390.) is a native of the south-west coast of New Holland; introduced in 1803; growing to the height of 10 ft.; and producing its fine yellow polyandrous flowers from May to July. The whole plant becomes black when dried; whence the specific name.

A. *strigosa* Link., *A. ciliàta* R. Br., has the general appearance of the preceding species, but flowers from March to July.

A. *glauca* Willd., *Mimosa glauca* L., (*Mill. Icon.*, 4. t. 4.) is a native of Carolina, with white decandrous flowers, which are produced in June and July. It was introduced in 1690, and grows to the height of 10 ft.

A. *Lambertiàna* D. Don (*Bot. Reg.*, t. 721.), which has purple flowers; A. *discolor* Willd. (*Bot. Mag.*, t. 1750.), which has yellow flowers; and A. *angulàta* Desf. and A. *pubescens* R. Br. (*Bot. Mag.*, t. 1263.), both which have also yellow flowers, are desirable species. The last three are from New Holland, and the first from Mexico.



389

390

A. *Julibrissin* Willd., *Mimosa Julibrissin* Scop. Del., i. t. 8., *Mimosa arborea* Forsk. and our *fig.* 391.; is a tree, a native of Persia, growing to the height of 30 ft. or 40 ft., which might almost have been included among our hardy species; but though, in the neighbourhood of London, it will grow against a wall without any protection, and flower in fine seasons, yet it will scarcely live in the open garden as a standard. According to Du Hamel, it is a native of Persia and China, and of various countries in the Levant, where it is also cultivated in gardens, for its large leaves, and its very large fragrant flowers, which, like those of the *A. farnesiàna*, are distinguished by their numerous purple stamens; each of the flowers appearing, from the length of the stamens, to terminate in a little bundle of silken threads, about an inch long; whence the Persian name of Ghulibrichim (*Julibrissin*), that is, silk rose; from which is derived its English name of the silk tree. Dr. Walsh informs us that the Turks are particularly fond of this tree, and that it is to be found in all the gardens of the Bosphorus. A tree in the garden

of the British palace at Constantinople has a trunk 1 ft. in diameter. The foliage, he says, is highly susceptible of the variations of the atmosphere. It affords a thick shade on a bright day; but, when it threatens rain, or when a cloud obscures the sun, the leaflets immediately close their lower surfaces together till the sun again appears. This beautiful phenomenon takes place, also, with all the New Holland species in which the leaves are not caducous, and more particularly with *A. dealbata*. *A. Julibrissin* was introduced into England in 1745, and is occasionally met with in collections. There is a large specimen of it in the Botanic Garden at Kew, which flowers frequently in August. There is one in the Fulham Nursery which also flowers. One in the Horticultural Society's Garden has not yet flowered. In the Bristol Nursery, there is one against a house, 20 ft. high, which is covered with a profusion of flowers every year. In the English garden at Caserta, near Naples, there is a tree which was upwards of 40 ft. high in January, 1835; and, at Monza, there is one, 24 years planted, which is also 40 ft. high.



391

A. decurrens Willd., *Mimosa decurrens* Vent. *Mal.*, t. 61., has leaves with 9—11 pairs of pinnae, each pinna bearing 30—40 pairs of narrow, linear, distant leaflets. It was introduced from New Holland in 1790, and flowers from May to July. It grows to the height of 20 ft.

A. mollissima Willd., *A. decurrens* var. β *mollis* Bot. *Reg.*, t. 371., *A. mollis* Sw., (*Fl. Austr.*, t. 12., and our figs. 392, 393.) closely resembles *A. decurrens*, and appears to us only a variety of that species. It was introduced in 1810; grows to the height of 20 ft.; and produces its yellow flowers in July and August.

392



A. dealbata Link Enum., ii. p. 415. (*Don's Mill.*, ii. p. 420., and the plate of this tree in our Second Volume) is the *A. affinis* of many British nurseries, and the black wattle mimosa of Van Diemen's Land. The origin of the specific name *affinis* is thus given by Dr. Neill, in *Gard. Mag.*, vol. xi. p. 432.:—“*A. affinis* seems to be a variety of *A. mollissima* Willd.; which variety Link regarded as a species, and called *A. dealbata*, but

393



which De Candolle, in his *Prodromus*, marks as ‘*Priori* (*A. mollissimæ*) *nimis affinis* ;’ meaning that, though he had followed Link in calling it a species, he considered it too nearly allied to *A. mollissima* to be so in reality: from which, apparently, some person fancied the word *affinis* to be a specific name, and adopted it accordingly.” *A. dealbata* has the leaves with 15 pairs of pinnae, and the flowers in lateral racemes. It is one of the hardiest species of the genus, and also one of the most rapid growth. It has been tried in the open air, as a standard, in various parts of Britain; and has stood out for several winters, and, in some places, grown to the height of 30 ft. There are three or four trees of this species in the garden of the London Horticultural Society, some of which are upwards of 20 ft. high; and none of them have been killed by the severe frosts of January, 1836. Some trees in the Kew Botanic Garden have stood out uninjured since 1828. In the Norwich Nursery, a tree, in November, 1834, was 16 ft. high; the trunk 5 in. in diameter; and the diameter of the head 12 ft. It grows in a light loam, with a sandy subsoil, and in a northern exposure. It had attained that height in 4 years after being planted out; and it flowers profusely in April, and sometimes ripens seeds. This tree was uninjured by the winter of 1835–6; another tree of the same species, and of nearly

the same height, which stood in a very exposed situation, lost a great part of its foliage, but was not otherwise injured, and in March was, as usual, covered with flower buds. In Somersetshire, at Beauchamp Parsonage, in March, 1835, a tree, between 16 ft. and 17 ft. in height, with a trunk 4 in. in diameter, was at that time covered with golden blossoms. This plant had only been planted out two years; when planted, it was turned out of a small pot, and was placed in a border of peat earth, where it grew to the height of 8 ft. the first summer, and showed blossoms the following autumn. (See *Gard. Mag.*, vol. xi. p. 250.) In Scotland, at Edinburgh, in the Botanic Garden, there is a fine specimen, as a standard, which was 16 ft. high, and covered with blossoms, in April, 1835. In the Caledonian Horticultural Society's Garden, there was, at the same time, one between 12 ft. and 14 ft. high; and in Dr. Neill's garden, at Canonmills, several trees, raised from seeds received from Van Diemen's Land, which were at that time 20 ft. high, and which had not suffered from the frost, though the thermometer had been as low as 25° Fahr. At Dundee, in Mr. Urquhart's nursery, there was also a fine specimen of this tree. A number of other specimens, standing in the open air, are recorded in vols. x. and xi. of the *Gardener's Magazine*. The tree is one of the most beautiful of all the acacias; its light delicate foliage, of a pale glaucous green, consisting of beautifully formed and graceful bipinnate leaves; the fine bloom which covers its branches, and, in young trees, even the stem; and its numerous heads of bright yellow fragrant flowers, which resemble golden balls, and which expand precisely at the season (February and March) when flowers are most desirable, because they are most rare, render this tree a most valuable addition to any pleasure-grounds. There is one remarkable peculiarity belonging to this tree, which deserves particular notice. While the delicate foliage is not materially injured by the cold of a British winter, the bark of the stem is liable to split, or become cracked, during severe frosts, especially for a few feet above the ground; and then disease and death are extremely apt to ensue. The preventive is simple, consisting merely in tying some straw round the stem at the end of November, or in encasing it in the manner recommended for *Magnolia grandiflora* (p. 266.), and removing the covering when the severity of winter is passed. (Dr. Neill, in *Gard. Mag.*, vol. xi. p. 432.) As confirmatory of the value of Dr. Neill's suggestions, we may refer to a case in the neighbourhood of London, where it is put in practice. A plant of *A. dealbata*, in a pot, and about 6 in. high, was, in May, 1834, turned out into the open garden; and at the end of the season it had produced a main stem upwards of 11 ft. in height, with numerous long lateral shoots. It was protected about half way up the stem with spruce fir branches on the approach of winter; and, though the severe frost of the 8th of January, 1835, killed the main stem down to the protected part, yet it pushed out again in the March following. (*Gard. Mag.*, vol. xi. p. 953.)

A. mollis Wall. (*Pl. Rar. Asiat.*, 2. p. 76. t. 177.) This is a tree which, from the description and figure, seems to bear a considerable resemblance to the three preceding sorts; but the heads of the flowers are in fascicles on long peduncles disposed in corymbs at the tops of the branches; the filaments are very long, and monadelphous at the base. The whole plant is covered with hairs in every part. It is a native of Nepal, where it is grown in gardens, and attains the height of 40 ft. or 50 ft. It is not yet introduced; but, if it should prove to be as hardy as *A. dealbata*, to which it appears closely related, it will be a most desirable species. (See the list of Himalayan Leguminaceæ likely to stand the open air in Britain, in p. 174.)

App. II. Remarks on cultivating the half-hardy Leguminaceæ in British Gardens.

Some valuable hints for raising the leguminous plants of Australia and the Cape of Good Hope from seeds, and for acclimatising them in British gardens, are given in the *Gardener's Magazine*, vol. viii. p. 5. These remarks are by Mr. J. Bowie, a collector at the Cape; at once a scientific botanist, and an excellent practical gardener; and we consider them of great value. As we have here given figures and descriptions of the principal half-hardy

Leguminæcæ, we think a summary of these hints on their culture will be interesting to our readers. Mr. Bowie took seeds of various species of the Australian *Acaciæ* with him from England to the Cape of Good Hope, and sowed them there immediately on his arrival. Many of them failed; but several came up, after having been three years in the ground. Seeds, also, of *Acacia longifolia*, saved at the Cape, and sown ten days after gathering, showed the same tardiness in vegetating. In both cases, the ground was duly kept moist by watering and shading, and no weeds were allowed to grow. After various experiments, Mr. Bowie found that nearly all of the Cape and Australian Leguminæcæ “thrive better by having water heated to 200°, or even 212° Fahr. poured over them, leaving them to steep, and the water to cool for 24 hours.” Where there is a numerous collection, and the quantity of seeds of each kind are few, he advises leaving them in their respective papers, and steeping the packets. The soil he recommends for leguminous seeds in general is, one part sandy loam, and three parts thoroughly decayed leaves. The seeds ought to be sown in pots of medium size, so as to maintain a more equal degree of moisture than can be obtained in pots either very large or very small; equable moisture being essentially necessary to the health and germination of all seeds, but more especially to those of seeds which lie a long time in the soil. The spring is the best season for sowing; because steeped seeds will come up the same season, if the pots are placed in a hot-bed. The plants should be transplanted while in a growing state, allotting to each species the peculiar soil required for it, as far as the requisite information for that purpose has been procured from the collector, or other sources. Whatever soil may be required for the plants, Mr. Bowie very properly remarks, care must be taken not to pulverise it too finely in sifting; for the taproot, in its descent, if it meets with any obstruction to its perpendicular direction, receives an impulse approaching to animal instinct; and, rounding the impediment, forms much sooner those lateral fibres and roots, which are to become the organs of nourishment for the future tree, &c. This will not be generally the case with plants placed in earth sifted as fine as snuff: the taproot will then descend without forming any lateral fibres; and the plant, circumscribed in its organs of nourishment, will soon display its state of health, by the sickly hue of the leaves, which will prematurely fall off; and, upon examination, the root will be found embedded, as it were, in a condensed cement, which all the efforts of nature cannot penetrate with fibrous roots.

As soon as the young plants are established in the pots, they must be removed from the frames, and plunged in prepared beds of decayed bark, formed at or under the level of the natural ground; and occasionally supplied with water, until the middle or latter end of August; when they are to be raised, and the taproot cut off, if it should have passed the aperture at the bottom of the pot. They may remain above ground until housed for winter; during which season as much air, and as little fire heat, as possible, should be given to them. In a general collection, it is impossible to allow every species its proper atmospherical temperature; but long confined air, and damp, are as injurious to vegetable, as they are to animal, life. There are, generally, some bright days occurring during the winter season in Britain: those opportunities should be embraced to purify the houses, by throwing open the doors and sashes, and keeping up a brisk fire in the morning, as often as may be judged necessary.

There are few Cape plants but what will resist the effects of some degrees of frost: the *Plectranthus fruticosus*, a native of the Cape forests, is the most susceptible of injury from cold; and, if properly placed in the house, proves a warning thermometer against direct injury, as it is the first to suffer, and, consequently, show, the increasing harm.

Of the South African Leguminæcæ, the following genera form striking and beautiful ornaments in their native wilds, particularly to those who are charmed with the outward appearance and various colours of flowers; and, although the nature of the soil where they are generally found in greatest numbers

be variable, a sandy loam, with decayed leaves, is the most genial to the growth of most species of Cape Leguminææ, and may, therefore, be used in general collections.

Omphalobium, *Schôtia*, *Sophora* sylvatica, *Cyclòpia*, *Sarcophýllum*, *Borbônia*, *Crotalària*, *Cýtisis*, *Anthýllis*, *Sutherlandia*, *Indigófera*, and *Aspálathus*, generally indicate the existence of a red sandy loam.

Acácia, *Virgília*, *Loddigèsia*, *Vibórgia*, *Ráfnia*, *Psoràlea*, *Onònis*, and *Cyclista*, thrive with great luxuriance on the margins of streams, in alluvial and vegetable soils; but many species of the same, and of other genera, vary from the general rules, and are found, either in pure sand, or in stiff clay, exposed, through great part of the year, to excessive heat and drought, or but slightly sheltered and nurtured by the mountains; but deriving much of their subsistence from the dewy clouds which those heights, as the clouds pass over them, arrest and condense. So readily do South African plants appear to accommodate themselves to soils and situations, that it is difficult positively to recommend any particular compost for them in garden culture. Practical experience must alone decide the best for the purpose.

Mr. Bowie recommends the forming of portable houses for the reception of Leguminææ, which would amply repay the amateur for the trouble and expense, by the splendour which plants having a sufficiency of room would exhibit. He therefore advises planting in beds of prepared soil, formed in such structures as fancy might determine, or circumstances permit, masses of Cape and Australian Leguminææ, arranging them so that every plant might receive an equal portion of the sun's rays through the day; placing the taller in the centre, and gradually diminishing the lines to the edge, where the minor kinds would form the border, and would not exceed the height of many species of the mosses.

If young plants (say of 3 years old) are intended for the above description of houses, they should be brought as early as possible to a fit state, by giving them larger pots than they would have allowed to them, were they intended for the stage or shelf of a green-house. As young plants will be small, in proportion to the space they are hereafter to fill, several of the species may be plunged over the rim of the pots, and marked for future removal. This will, without deranging the plan, allow sufficient room for those which remain: those to be removed, having a ball of earth attached to them, will be fit specimens to try in the open air.

For this trial in the open air, Mr. Bowie recommends a northern exposure for planting, rather than a southern one; as in the latter situation, after severe frosts, a sudden thaw does most mischief, and, in many instances, is the real cause of death to the plants. If large plants, thus exposed, appear killed by cold, too much haste must not be exercised in removing the roots; but the plants must be cut down; and the stem and the stool left in the ground for one or two years. When old plants are intended for the portable house, or for a conservatory, they should be headed down to a convenient height, allowing sufficient room for their heads to form free of the roof; and, as the various species of *Schôtia* flower occasionally on the old wood, and the others at the extremities of the young spring and summer shoots, these habits should be strictly attended to, and borne in mind, at all seasons.

Many persons regret the loss of old established plants; and, in the vain attempt to preserve them in a confined space, permit injuries to be inflicted upon them, by injurious pruning, which eventually render them unsightly and disagreeable objects for a house. They are then condemned, and, in the autumn, are left out, and exposed to every vicissitude of season; and no opportunity is thus given them to recover. Early in the spring these plants should be selected, and planted out in sheltered situations of the shrubbery. If this were done, they would, at least, have a chance of existence; and, if they should then die, their loss would not be so apparent. It has become a very common practice in Europe to plant exotic shrubs in front of the stoves and green-houses; but this is often done indiscriminately, and without reflecting on what will

probably be their ultimate height, or whether they can be kept within bounds by pruning, without injury or total prevention of flowering. This point requires consideration, or the plants are likely to become nuisances.

Omphalobium, *Virgilia*, *Sophora*, several *Psoraleæ* and *Cytisi*, form a distinct stem: *Schôtia*, *Indigófera*, *Psoràlea*, *Aspálathus*, *Podalýria*, *Lipària*, and *Borbònia*, as well as *Cyclòpia*, *Sarcophýllum*, and *Ráfnia*, form branching shrubs from the collar. In the three last-mentioned genera, this habit should be encouraged as much as possible, by cutting them down to the ground; which occasions the larger growth of the collar: and, in old plants, the appearance of nakedness would be but temporary; while the quick growth of numerous shoots would soon form them into dense bushes, and stronger and more characteristic masses of flowers. *Omphalobium* and *Schôtia* are of slow growth: planting them under the shade of others will draw them up to a requisite height without injury.

Mr. Bowie gives the following list of the average height which several species attain in their native habitations, as a guide to the cultivator in planting:—

	Ft.	In.		Ft.	In.
<i>Virgilia intrusa</i> and <i>capénsis</i>	25	0	<i>Indigófera cytisoides</i> - -	8	0
If <i>Virgilia</i> is deeply injured in the old wood, a gum exudes, which is used as gum Arabic.			<i>Podalýria styracifolia</i> - -	9	0
<i>Omphalobium</i> - -	12	0	<i>Aspálathus</i> - -	6 in. to	4 0
<i>Sophora sylvática</i> - -	16	0	<i>Ráfnia</i> (annual growth)	2 ft. to	3 0
<i>Psoràlea pinnàta</i> - -	15	0	<i>Sarcophýllum</i> (annual growth)	1	6
<i>Cyclòpia</i> - -	4 ft. to	10 0	<i>Lipària sphærica</i> - -	3	0
			<i>Acàcia capénsis</i> , or <i>nilótica</i>	20	0
			<i>Acàcia cáfra</i> - -	12	0

The latter thrives best by being cut down, and confined as a shrub to 6 ft. They both yield the gum Arabic.

Erythrina cáfra attains the height of 60 ft., but flowers at the height of 15 ft. *Erythrina nana*, introduced by Mr. Bowie into England in 1823, flowers at 2 ft.; and may be considered as half-shrubby, as it scarcely ever attains a permanent stem: it is a desirable plant.

A portable house, for the protection of half-hardy Leguminææ during winter, may be made in various forms, at very little expense. Two parallel walls, 6 ft. or 8 ft. high, and 15 ft. or 20 ft. apart, in the direction of north and south, will leave a space between, which may be covered every autumn with temporary rafters, on which may be placed the sashes of hot-beds not in use, alternating with boards. If moisture has been withdrawn from the soil, by drainage, and by covering with boards or with glass, or even by thatching the soil during heavy rains in autumn, so as to facilitate the ripening of the wood, there will be no difficulty in keeping the plants alive; and when they are cut in, in spring, they will push vigorously, and soon have a clothed appearance.

CHAP. XLII.

OF THE LIGNEOUS PLANTS BELONGING TO THE ORDER ROSACEÆ.

THE term *Rosææ* has been applied to this order, because all the species belonging to it agree more or less with the genus *Rosa*, in essential characters. It includes many genera belonging to the Linnæan class *Icosándria*.

Distinctive Characteristics. Flowers regular. Calyx, in most cases, with 5 lobes, the odd one posterior to the axis of inflorescence. Petals and stamens arising from the calyx. Stamens, for the most part, numerous.

Ovaries many, several, or solitary; each of one cell that includes, in most cases, 1 ovule; in some, 1 to many ovules. Style lateral or terminal. Leaves alternate, in nearly all stipulate; pinnately divided, or simple. (*Dec.* and *Lindley.*) Fruit, in many of the genera, edible.

Description, &c. The ligneous species which constitute this order include the finest flowering shrub in the world, the rose; and the trees which produce the most useful and agreeable fruits of temperate climates, viz. the apple, the pear, the plum, the cherry, the apricot, the peach, and the nectarine. The plants are, for the most part, deciduous low trees or shrubs, all producing flowers more or less showy; and the greater number fruits which are edible. They are chiefly natives of Europe and Asia; but several of them are also found in North America, and some in South America, and the north of Africa. The fruit-bearing species, and the rose, have followed man from the earliest period of civilisation, and are, perhaps, better known to mankind in general than any other ligneous plants. The medical properties of several of the species are remarkable, from the circumstance of their yielding the prussic acid; while others produce a gum nearly allied to the gum Arabic, which indicates a degree of affinity between this order and Leguminææ. The bark of some species, as of *Cérasus virginiana*, is used, in North America, as a febrifuge; and that of others, as the capollin cherry (*Cérasus Capöllin*), for tanning, in Mexico. The leaves of *Cratægus Oxyacantha*, *Prúnus spinosa*, *Cérasus sylvéstris*, and *Rösa rubiginösa* have been used as a substitute for tea, or for adulterating tea. The leaves and bark of the spiræas are said to be at once astringent and emetic. There are two characteristics of this order, with reference to its cultivation, which are of great importance to the gardener: the first is, the liability of almost all the species to sport, and produce varieties differing, in many cases, more from one another, than they differ from other species; and the second is, that they are remarkably subject to the attacks of insects and diseases. In point of cultivation, they almost all require a free soil, not overcharged with moisture, and rich rather than poor; and, while all the species are increased by seeds, which, for the most part are produced freely in Britain, almost all the varieties are best increased by grafting or budding; and not, as in some other orders, with equal ease by cuttings or layers.

Arrangement of the Genera. The ligneous genera are included by De Candolle in five tribes; and the following are their names and distinctions; the latter derived mainly from Decandolle's *Prodromus*, but partly from personal observation, and Lindley's *Introd. to Nat. Syst.*: —

Sect. I. AMYGDALÆE Juss.

Sect. Char. Fruit a drupe; the nut 2-ovuled, 1—2-seeded. Style terminal.

Calyx deciduous. Leaves feather-nerved, undivided, serrate, with the lower serratures or the petioles glanded. Stipules not attached to the petiole. Kernel containing more or less of hydrocyanic acid.

AMYGDALUS Tourn. Covering of the nut not very fleshy or juicy, its surface downy; nut even, or perforated with little holes. Young leaves folded flatwise. Flowers almost sessile, solitary or twin, protruded before the leaves.

PÉRSICA Tourn. Covering of the nut very fleshy and juicy, its surface downy or smooth; nut with wrinkled furrows. The characters of the other parts described under *Amygdalus* are the same in *Pérsica*.

ARMENIACA Tourn. Covering of the nut fleshy, juicy, its surface downy; nut obtuse at one end, acute at the other, furrowed at both lateral edges, in the other parts even. Young leaves with their edges rolled inwards. Flowers almost sessile, solitary or a few together, protruded before the leaves.

PRUNUS Tourn. Drupe ovate, or oblong; covering of the nut fleshy, juicy, its surface glabrous, and covered with a grey bloom; nut compressed, acute at both ends, indistinctly furrowed at the edges, in the other parts

even. Young leaves with the edges rolled inwards. Flowers upon pedicels, in groups resembling umbels, and produced before or after the leaves.

CERASUS *Juss.* Drupe globose, or with a hollow at its base; nut subglobose, even, its covering fleshy, juicy, and with a surface glabrous, and not covered with a grey bloom. Young leaves folded flatwise. Flowers upon pedicels, either in groups resembling umbels, and produced before the leaves, or in racemes terminal to the shoots, protruded along with them.

Sect. II. SPIRÆÆ *Dec.*

Sect. Char. Fruit of 5, or fewer, capsular carpels, which are distinct from the calyx (which is persistent in *Spiræa*, and, perhaps, in the other genera), and, in most cases, from each other; each contains 1—6 seeds. (*Lindley.*) Style terminal.

PURSHIA *Dec.* Lobes of calyx obovate, obtuse. Petals and stamens arising from the calyx. Stamens about 20. Carpels 1—2, ovate-oblong, tapered into the short style, pubescent; each includes 1 ovule inserted into its base, and opens by a longitudinal cleft.

KERRIA *Dec.* Lobes of calyx ovate, 3 obtuse, and 2 with a callous point. Petals and stamens arising from the calyx. Stamens about 20. Carpels 5—8, distinct, glabrous, terminated by a slender style, globose; each includes 1 ovule, which adheres to its side.

SPIRÆA *L.* Petals and stamens arising from a torus, to which the calyx adheres. Stamens 10—50. Carpels 1 to several, distinct; or, in a few cases, connate at the base; ending in short tips; sessile, or, in a few cases, stipitate; each includes 2—6 seeds, affixed to the inner suture.

Sect. III. POTENTILLÆ *Juss.* (Synon. *Dryadeæ Vent.*)

Sect. Char. Fruit an aggregation of carpels; their integuments dry or succulent; the carpels distinct from one another, and from the calyx, which is persistent, and surrounds them, and, in many, is subtended by as many bracteas as it has lobes; the bracteas alternate with the lobes. Style proceeding from a little below the tip of the carpel. Leaves, in most cases, pinnately divided. Stipules attached to the petiole.

RUBUS *L.* Integuments of carpels juicy.

POTENTILLA *Nestl.* Integuments of carpels dry.

Sect. IV. ROSÆ *Dec.*

Sect. Char. Fruit a hip; that is, with the tube of the calyx fleshy, of a pitcher shape, contracted at the mouth; and including an aggregation of carpels attached to its inner face. Style proceeding from the inner side of the carpel.

ROSA *Tourn.* Leaf impari-pinnate. Stipules attached to the petiole. Prickles simple.

LOWEA *Lindl.* Leaf simple. Stipules none. Prickles usually compound.

Sect. V. POMÆ *Lindl.*

Sect. Char. Fruit a pome; that is, with the tube of the calyx become very fleshy, and including, and connate with, the carpels. Carpels normally 5, with gristly or bony walls, including 1—2 seeds; in *Cydônia*, several. Habit, spiny or not; leaves, in most cases, undivided, in some pinnate. Stipules not connate with the petiole.

CRATÆGUS *Lindl.* Fruit ovate, not spreadingly open at the top. Carpels 1—5 prismatic nuts with bony shells, each including 1 seed. Spiny shrubs or low trees. Leaves angled or toothed; in most cases, deciduous. Flowers in terminal corymbs.

PHOTINIA Lindl. Carpels 2; when in the state of ovary, villose. Petals reflexed. Shrubs, or low trees. Evergreen. Flowers in terminal panicles. Leaves simple, leathery, sawed or entire. In *P. integrifolia*, the ovaries are 3, and each includes 2 ovules.

COTONEASTER Medik. Carpels 2—3; in the state of ovary enclosing 2 ovules. Shrubs or low trees. Leaves simple, entire, woolly beneath. Flowers in lateral spreading corymbs.

AMELANCHIER Medik. Ovaries 5, each divided by a partition, so that there are 10 cells; ovules, 1 in each cell. Ripe pome including 3—5 carpels. Petals lanceolate. Small trees. Leaves simple, serrate, deciduous. Flowers in racemes.

MESPILUS Lindl. Fruit top-shaped, spreadingly open at the top. Carpels 2—5 compressed nuts with bony shells, each including 1 seed. Small trees, spiny or not. Leaves lanceolate, serrulate, deciduous. Flowers large, subsessile, subsolitary.

PYRUS Lindl. Carpels 5, or 2—5. Seeds 2 in each carpel. Trees or shrubs. Leaves simple or pinnate, deciduous. Flowers in spreading terminal cymes or corymbs.

CYDONIA Tourn. Carpels 5, each including many seeds. Low trees.

Sect. I. AMYGDALÆ Juss.

GENUS I.



AMYGDALUS Tourn. THE ALMOND TREE. *Lin. Syst.* Icosándria Monogýnia.

Identification. Tourn. Inst., t. 402.; Dec. Fl. Fr., 4. p. 486.; Prod., 2. p. 330.; Don's Mill., 2. p. 482.

Synonymes. Amygdalóphora Neck.; Amandier, Fr.; Mandelbaum, Ger.

Derivation. From *amussō*, to lacerate, in reference to the fissured shell of the nut. Martinius suspects that it comes from a Hebrew word which signifies vigilant; because its early flowers announce the return of spring.

Description, &c. Deciduous shrubs or trees of the middle size, natives of the north of Africa, and the mountains of Asia; also of Russia, and the Levant. The fruit-bearing species are cultivated in the middle and south of Europe and the Levant; and are propagated chiefly by grafting; and the others by grafting, layers, or suckers. The almond was included by Linnæus in the same genus with the peach, of which it is, doubtless, the parent, as trees have been found with almonds in a state of transition to peaches. They have been separated into two genera, on account of certain technical distinctions in the fruit, which will probably be rejected, when, in consequence of extended experience, and a better knowledge of physiology, a more enlarged view shall be taken of the subject of establishing genera and species.

‡ I. *A. NA'NA* L. The dwarf, or shrubby, Almond.

Identification. Lin. Mant., 396.; Dec. Prod., 2. p. 530.; Don's Mill., 2. p. 482.

Synonymes. Prúnus inérmais Gmel.; *A. nana* var. *æ* vulgàris Dec.; Amandier nain Fr.; Zwerchemandel, Ger.

Engravings. ? Pluk. Alm., t. 11. f. 3.; Bot. Mag., t. 161.; N. Du Ham., 4. t. 30.; and our figs. 394, 395.

Spec. Char., &c. Leaves oblong-linear, tapered at the base, serrated, glabrous; flowers solitary, rose-coloured; calyx cylindrically bell-shaped; fruit of the same shape as that of *A. communis*, but much smaller. Frequent in Calmuck, and about Odessa. (*Dec. Prod.*, ii. p. 530.)

Varieties.

‡ *A. n. 2 geórgica* Dec. *A. geórgica* Desf. *Arb.*, 2. p. 221. *The Georgian dwarf Almond.*—It differs from the species in having the lobes of the calyx lanceolate, and as long as its tube; and the styles only tomentose at the base, being scarcely so there, and not protruded. A native of Georgia, which has been cultivated in the Geneva Botanic Garden.

- ♁ *A. n. 3 campéstris* Ser. *A. campéstris* Besser Enum., p. 46. No. 1425; *A. Besseriána* Schott in *Cat. Hort. Vindob.*, 1818. *The Field dwarf Almond*.—Leaves broader. Lobes of the calyx as long as the tube. Petals narrower, longer, and white. Styles tomentose at the base. The form of the nut, according to Besser, is various. Supposed to be a native of the south of Podolia. (*Dec. Prod.*, ii. p. 530.)
- ♁ *A. (n. 4) incána* Pall., *the hoary-leaved dwarf Almond* (*Pall. Ross.*, 1. p. 13. t. 7; *Smith Fl. Græc.*, t. 477; *Don's Mill.*, 2. p. 482.) has obovate leaves, clothed with tomentum beneath; and the branches are somewhat spiral. It is a native of Caucasus and the Levant, between Smyrna and Bursa; and produces its red flowers in March and April; but we have never seen it in British gardens. Guldenstadt considered it to be a variety of *A. nána*, which, we think, is extremely probable.
- ♁ *A. (? n. 5) sibirica* Lodd. *Cat.*, *the Siberian Almond*, is extant in some British botanical collections, where it is an upright shrub, about 4 ft. high, with wand-like shoots, clothed with fine, long, willow-like, glossy, serrate leaves; on account of which, and its upright habit of growth, the latter being different from that of all the other species and varieties of almond, it is valuable in every collection where variety of character is desired.

The plant which is usually called the dwarf double-blossomed almond, in British gardens, is *Cérasus japónica* flore pleno, or, as it is frequently named in the nurseries, *Amýgdalus púmila*.

Description, &c. All the different forms of the dwarf almond are low shrubs, seldom exceeding 2 ft. or 3 ft. in height. The leaves bear a general



394

resemblance to those of some of the species of willow, but are of a darker and more shining green, at least in the original species. The stems are not of long duration; but the plant throws up abundance of travelling suckers, by which it is continued naturally, and also propagated. It is common through all the plains of Russia, from 55° n. lat. to the south of the empire. The species is common in British gardens, and is propagated by suckers. It was introduced in 1683; and produces its pink flowers in March and April. It is



395

valuable on account of its early flowering, the gracefulness of the slender twigs, on which its flowers are produced before the leaves appear, and of its easy culture in any dry soil. Its fruit resembles that of *A. communis*, but is much smaller.

‡ 2. *A. COMMUNIS* L. The common Almond Tree.

Identification. Lin. Sp., 677; Dec. Prod., 3. p. 530; Don's Mill., 2. p. 482.

Engravings. N. Du Ham., 4. t. 29; and the plate of this tree in our Second Volume.

Spec. Char., &c. Leaves oblong-lanceolate, serrulate. Flowers solitary. Calyx of a bell-shape. Fruit compressed, and rather egg-shaped. (*Dec. Prod.*, ii. p. 530.) A tree, a native of Mauritania, and, as Royle observes, also found in the mountainous parts of Asia. It grows to the height of 20 ft. or 30 ft.; and was cultivated in Britain, in 1538. There are several varieties of it in cultivation on the Continent, for their fruit; and two or three in this country, partly for the same purpose, but chiefly for their flowers. The common almond, in a wild state, is found sometimes with the kernels bitter, and at other times with them sweet; in the same manner as the *Quérecus hispánica*, which, in Spain, generally bears sweet and edible acorns, sometimes produces only such as are bitter. For this reason, in the case of the almond, instead of giving one form as the species, we have followed De Candolle, and described both the bitter and the sweet almond separately, either of which may be considered as the species, and classed them with the varieties.

Varieties.

‡ *A. c. 1 amára* Dec. *The bitter-kernelled common Almond Tree.*

Identification. Dec. Fl. Fr., 4. p. 486; Du Ham., ed. 2. p. 114; Dec. Prod., 2. p. 530.

Synonymes. *Amandier amer*, Fr.; gemeine Mandelbaum, Ger.

Description, &c. Flowers large. Petals pale pink, with a tinge of rose colour at the base. Styles nearly as long as the stamens, and tomentose in the lower part. Seeds bitter. There are two forms of the bitter almond; one with a hard shell, and the other with a brittle one. The tree is cultivated in the south of France, in Austria, in Italy, in

Greece, &c., for its fruit, which is preferred for some purposes in medicine and in domestic economy to that of the sweet almond, particularly for giving a flavour; and for stocks for grafting the other varieties on, and the peach, apricot, and even the plum. Bitter almonds are generally mixed with sweet ones, in very small proportions, for making blancmange, &c. Plutarch mentions that a great drinker of wine used to escape becoming intoxicated by the use of bitter almonds; which, perhaps, may be accounted for from the contra-stimulus of the prussic acid, which is known to abound more in bitter almonds than in sweet ones.

‡ A. c. 2 *dulcis* Dec. *The sweet-kernelled common Almond Tree.*

Identification. Dec. Fl. Fr., 4. p. 486.; Prod., 2. p. 530.; Lam. III. t. 430. f. 2.

Synonymes. Amandier à petits Fruits, Amande douce, Fr.; süsse Mandel, Ger.

Engraving. Lam. III., t. 430. f. 2.

Description, &c. Leaves grey-green. Flowers protruded earlier than the leaves. Styles much longer than the stamens. Fruit ovate-compressed, acuminate. Shell hard. Kernel sweet-flavoured. Cultivated in the same places as the preceding sort, and generally propagated by grafting standard high on the bitter almond, or any strong-growing seedling almonds, in order to make sure of the fruit being sweet.

‡ A. e. 3 *flôre plêno* Baum. Cat. has double flowers.

‡ A. c. 4 *foliis variegâtis* Baum. Cat. has variegated leaves.

‡ A. c. 5 *fragilis* Ser. *The brittle-shelled common Almond Tree.*

Identification. Seringe in Dec. Prod., 2. p. 531.

Synonymes. A. *fragilis* Hell., l. p. 500.; Amandier des Dames N. Du Ham., 4. p. 113.,

Noisette Jard. Fruit., p. 7.; Coque molle, Amandier à Coque tendre, Fr.; Abellan, Provence.

Engraving. Noisette Jard. Fruit., p. 7. t. 3. f. 2.

Description, &c. Flowers protruded at the same time as the leaves, and of a pale rose colour. Petals broader, and deeply emarginate. Leaves shorter; the petioles thick. Fruit acuminate; shell soft; kernel sweet-flavoured. Cultivated for its fruits like the preceding sorts.

‡ A. e. 6 *macrocarpa* Ser. *The long-fruited common Almond Tree.*

Identification. Seringe in Dec. Prod., 2. p. 531.

Synonymes. Amandier à gros Fruits N. Du Ham., 4. p. 112., Noisette Jard. Fruit., p. 7.;

Amandier Sultane, Amandier des Dames, Amandier Pistache, Fr.

Engraving. Noisette Jard. Fruit., p. 7. t. 3.

Description, &c. Leaves broader, acuminate, scarcely grey. Peduncles short, turgid. Flowers of a very pale rose colour, large, protruded before the leaves. Petals broadly obovate, wavy. Fruit large, umbilicate at the base, acuminate at the tip; shell hard. There are two subvarieties, one with the fruit rather smaller, called, commonly, in France, amandier sultane; and another, with the fruit still smaller, called there amandier pistache; the kernels of both of which are considered remarkably delicate, and are preferred for the table. The flowers of this variety are always produced earlier than those of any other; and the kernels of the fruit are always sweet. In British gardens, the *A. c. macrocarpa* has much the largest flowers of any of the varieties; and, as none of them are cultivated in Britain for their fruit, this kind is by far the most desirable, on account of the magnitude and beauty of its flowers, which are white slightly tinged with pink. It is a vigorous large tree, of rapid growth, somewhat more fastigate than the species; and it is propagated by grafting on the common species, or any free-growing variety of plum. There are fine specimens in the garden of the Horticultural Society, and in the Hammersmith Nursery. Price of dwarf plants, 1s. 6d. each; standard high, 2s. 6d.

‡ A. e. 7 *persicoides* Ser. *The Peach-like-leaved common Almond Tree.*

Identification. Seringe in Dec. Prod., 2. p. 531.

Synonyme. Amandier-pêcher N. Du Ham., 4. p. 114., Noisette Jard. Fruit., p. 7.

Engraving. Noisette Jard. Fruit., p. 7. t. 3. f. 1.

Description, &c. Leaves similar to those of the peach tree. Fruit ovate, obtuse; its husk slightly succulent; the shell of a yellowish dark colour, and the kernel sweet-flavoured. Du Hamel has stated that its fruits vary upon the same branch, from ovate, obtuse, with the husk rather fleshy, to ovate, compressed, acuminate, and the husk dry. Cultivated in France and Italy for its fruit, but rarely found in British gardens. The *tuberes* of Pliny, Knight considers as swollen almonds, and the same as this variety, having raised a similar one by dusting the stigma of the almond with the pollen of the peach, which produced a tolerably good fruit. (See *Hort. Trans.*, iii. p. 4., and *E. of Gard.* edit. 1835, p. 920.)

Other Varieties. The almond, considered as a fruit tree, has given rise to some other varieties, which will be found treated of at length in French works on gardening, in the *Nouveau Du Hamel*, and the *Nouveau Cours d'Agriculture*.

General Description, History, &c. In British gardens, the common almond, grafted on the plum, standard high, forms a tree of 20 ft. or 30 ft. in height, with a spreading head, thin of branches; and it is commonly one of the first hardy trees which displays its blossoms. These generally expand, in Britain, in March, but in mild seasons even in February. At Smyrna, they appear in the beginning of February; in Germany, in the latter part of April; and at Christiania, in Norway, not till the beginning of June. (*Dec. Phys. Vég.*, ii. p. 717.) The blossoms are of a pale rose colour; and it has been observed, that, though spring frosts often destroy the germs of the fruit, they do not injure the beauty of the flowers, but even increase their brilliancy. An avenue

of almond trees, quite white with frost in the evening, will be of a brilliant rose colour the following morning, and will often retain its beauty for more than a month, the flowers never falling off till the tree is covered with verdure. Almond trees are, indeed, seldom good bearers: even in France, where the fruit is cultivated as an article of commerce, the tree is considered, on an average, only to bear a crop once in five years. From the head of the tree being open, the shoots are clothed with leaves and blossom buds to a great length; so that, when the latter expand, the branches seem wholly covered with them; a circumstance which is not found in trees having close dense heads, such as the common hawthorn. The almond, as a standard, is one of the principal ornaments of British shrubberies and plantations in spring; though it is neither a handsomely shaped tree, nor one of long duration. Contemporary blossoming trees are, the apricot, the sloe, the myrobalan plum, and the *Cérasus Pseudo-Cérasus*. The blossoms of all these trees come out before the leaves; and hence they produce the best effect when planted among evergreens. The chief distinction between the almond and the peach and nectarine is in the fruit; the former having the stone covered with a coriaceous dry hairy covering, while that of the latter is enveloped in a rich juicy glabrous one. The almond is mentioned by Pliny, and also the variety of it which he calls *Tuberes*; and which, as before observed (p. 675.), Mr. Knight considers to be the swollen, or peach, almond (*A. c. persicoides Ser.*), having raised a similar variety from fecundating the blossom of an almond with the pollen from a blossom of the peach, which produced tolerably good fruit. This, and other experiments, leave no doubt in our mind, that the almond and the peach are only one species. The almond tree is mentioned in Scripture as one of the choice fruits of Canaan; and by the earlier Roman writers, as well as by Pliny. Turner, and also Gerard, have treated of this tree; and the latter says that, though it is a tree of hot regions, yet we have them in our London gardens and orchards in great plenty, flowering betimes with the peach, and ripening their fruit in August. The tree, as we have already observed, is in very general cultivation in England, chiefly for its flowers; and in the middle and south of Europe, north of Africa, and part of Asia, for its fruit. Royle mentions that it has been introduced into India; but that it does not ripen its fruit in that country.

Properties and Uses. The wood of the almond is hard, and of a reddish colour: it is used in cabinet-making, especially for veneering; and it is employed to make handles for carpenters' and joiners' tools. The leaves of this tree are said to form an excellent nourishment for sheep and goats, and to fatten the former in a very short time; but it must always be mixed with other provender. The gum which exudes from the tree is used for the same purposes as that of the cherry and the gum Arabic, though it is not so easily dissolved in water as the last-mentioned kind. An oil is obtained, both from bitter and sweet almonds, by maceration and expression; that is, by forming a paste of the kernels, putting it in a bag, and subjecting it to the action of a powerful press. A liquid is also distilled from both sweet and bitter almonds, which, from the quantity of prussic acid which it contains, is found to be poisonous to animals. An essential oil is obtained from the expressed oil, by distillation, which is one of the most virulent poisons known. Almond oil is supposed to blunt acrimonious humours, and to soften and relax the solids; hence its use internally, as a remedy for coughs, pains of the chest, and inflammations; and externally, in tensions and rigidity of particular parts. On triturating almonds with water, the oil and water unite together by the mediation of the albuminous matter of the kernel, and form a bland milky liquor, called an emulsion, which may be given freely in inflammatory disorders. The sweet almonds, alone, are employed in making emulsions, as the bitter almonds impart their peculiar taste. Several unctuous and resinous substances, that of themselves will not combine with water, may, by trituration with almonds, be easily mixed into the form of an emulsion; and are thus excellently fitted for medicinal purposes. It is a singular fact, that the seeds of the bitter and sweet almond should

differ so essentially in their chemical compositions; the kernel of the bitter almond containing the deleterious principle of prussic acid, which does not exist in the kernel of the sweet almond, although found in its bark, leaves, and flowers. The existence of hydrocyanic, or prussic, acid, as a vegetable principle, was discovered in 1802, by Bohm, in the distilled water of bitter almonds. It was also discovered in the leaves of the common laurel, by Schrader, in the same year; in peach blossoms and leaves, by Vauquelin; in kirschwasser, by Von Ittner; and in the bark of the bird cherry, by Jahn. In all these, and many similar substances, the acid is modified by its combination with volatile oil. Hydrocyanic acid has recently been much used in pulmonary inflammation, asthmas, sympathetic coughs, &c. It is prepared by the Apothecaries' Company of London from cyanuret of mercury, hydrochloric acid, and water. Dr. Duncan, however, prefers the distilled water of bitter almonds, or laurel water, in these diseases, as being more manageable, and less liable to decomposition. Bitter almonds consist of 100 parts of fixed oil, 54 of albumen, 24 of liquid sugar, 6 of gum, 3 of fibre, 4 of pellicles, 5 of water, and 4 of acetic acid, out of 200 parts. (*Stephenson's and Churchill's Med. Bot.*, and *Don's Mill.*)

In domestic economy, sweet almonds, and also the common sort, are brought to the dessert in the husk, green, or imperfectly ripe; and also in a ripe state, with or without the husk; there is also a preserve made of green almonds. After they are ripe, they are frequently brought to table without the shell, and sometimes blanched; that is, deprived of the thick wrinkled skin which envelops the kernel, by putting them for a few minutes in scalding-hot water. The kernels are much used in cookery, confectionery, and perfumery, on account of their agreeable flavour. The leaves are employed, in common with those of the peach and nectarine, for giving a flavour to gin, whisky, and other spirits. In nursery gardening in France, the almond is much used as a stock for grafting the peach and the apricot. Almond stocks, however, are far inferior to plum stocks in point of hardiness, durability, and facility of transplantation. Almonds form an extensive article of commerce. The Valencia almond is sweet, large, flat, pointed at one extremity, and compressed in the middle. The Italian almonds are not so sweet, smaller, and less depressed in the middle. The Jordan almonds come from Malaga, and are the best sweet almonds brought to England. The bitter almonds come chiefly from Mogador. (*Thom. Disp.*) The British revenue, from the tax on Jordan almonds, according to McCulloch, was, in 1832, upwards of 5000*l.*; the duty being 4*l.* 15*s.* per cwt. The price of Jordan almonds, in London, in 1833, was from 75*s.* to 100*s.* per cwt.; Barbary bitter almonds, 31*s.* per cwt.; Valencia sweet almonds, from 72*s.* to 75*s.* per cwt. (*McCull. Dict.*)

Historical, Poetical, and Mythological Allusions. The beauty of the almond tree, its flowering at a period when most other trees appear scarcely to have escaped from the icy chains of winter, and the extraordinary profusion of its flowers, have combined to render this tree, from the earliest ages, a favourite of the poets. The first mention of the almond is found in Holy Writ, when Moses, to ascertain from which of the twelve tribes to choose the high priest, put twelve rods into the tabernacle, and found, the following day, the almond rod, which represented the tribe of Levi, covered with leaves and blossoms. Virgil, in the *Georgics*, welcomes it, when flowering profusely, as the sign of a fruitful season. Spenser, in his *Faerie Queene*, compares the nodding plumes of Prince Arthur's helmet to an almond tree.

— “ With blossoms brave bedecked daintilie ;
Whose tender locks do tremble every one,
At every little breath that under Heav'n is blown.”

Many modern poets have also noticed the almond tree; but, perhaps, the most beautiful of all the allusions to it is that by Moore:—

“ The hope, in dreams of a happier hour,
That alights on misery's brow,
Springs forth like the silvery almond flower,
That blooms on a leafless bough.”

The following is the origin assigned by Grecian mythology to this tree. Demophoon, son of Theseus, returning from Troy, was cast by a tempest on the coast of Thrace, where he was most hospitably received by the beautiful queen of the country, Phyllis. He won her heart, and became her husband; but scarcely were they united, when the death of his father recalled Demophoon to Athens; and he left Phyllis, promising to return to her in a month. When the given time had expired, the unfortunate queen wandered daily on the sea shore, looking in vain for her Demophoon; and when, at last, winter came, and still he returned not, after gazing for some time on the sea, in an agony of despair, she fell dead on the shore, and was changed by the pitying gods into an almond tree. Demophoon shortly after returned; and, being told what had occurred, flew to the tree, and clasped it in his arms, when the strong attachment of Phyllis, unable even then to restrain itself, caused the tree, though bare of leaves, to burst forth into blossoms.

Soil, Situation, &c. Any free soil, that it is not too moist, will suit all the varieties of the common almond when grafted on plum stocks; but, when not grafted, or when the stock is the common or any strong-growing seedling almond, the plants will not be of long duration, unless the soil is dry, sandy, or calcareous, and of some depth. The situation should be sheltered, because the branches are liable to be broken off by high winds. Plants, in Britain, are seldom raised from nuts, but are almost always propagated by grafting or budding. In France, as we have already mentioned (p. 677.), the almond is much grown by nurserymen, as a stock for the peach and the apricot. The bitter variety used to be preferred for this purpose; but in the Vitry nurseries near Paris, where the peach is extensively propagated, a vigorous-growing variety of the sweet almond is chiefly used as a stock. The kernels are sown in rows, in the month of March; they are budded the following August, and in the October of the second year they make fine showy plants. (*See Gard. Mag.*, vol. xii. p. 227.) The great advantage of these stocks to the nurserymen is, that, as they may be budded the very first year of their growth, on the spot where they are sown, a grafted tree may be obtained with them at the least possible expense. As the almond, however, sends down a taproot upwards of 2 ft. long the first season, it has been found that such a tree, when taken up for sale, has few fibres, and, consequently, little chance of growing. This has given rise to the practice of germinating the nuts in boxes of earth before sowing them, and pinching off the point of the radicle when about an inch in length; which causes it to throw out numerous horizontal roots: a very ingenious practice, which might be applied with advantage in many similar cases. This mode of germinating the nuts has another advantage; that of making sure of having plants the first season after planting, as, when it is not done, the seeds often lie in the ground two years. In planting the seed, care must be taken always to keep the sharp end of the seed downwards, otherwise the germination will be stayed, and also weakened. Plants will grow 4 ft. or 5 ft. high the first year. The tree bears chiefly on the young wood of the previous year, or on spurs of older wood. It requires but little pruning, except when it is wished to produce fruit of a large size, or to prolong the duration of the tree.

Statistics. There are abundance of large specimens of the common almond in the neighbourhood of London; some at Syon, and at Purser's Cross, are upwards of 30 ft. high. In the Fulham Nursery, 10 years planted, there is a tree 15 ft. high. In Dorsetshire, at Melbury Park, 15 years planted, there is one 35 ft. high, with a trunk 9 in. in diameter, and a head 22 ft. in diameter. In Hertfordshire, at Cheshunt, 7 years planted, it is 20 ft. high. In Rutlandshire, at Belvoir Castle, 18 years planted, it is 25 ft. high. In Worcestershire, at Croome, 25 years planted, it is 25 ft. high. In Yorkshire, at Grimstone, 13 years planted, it is 20 ft. high. In Scotland, at Edinburgh, in the Horticultural Society's Garden, 6 years planted, it is 11 ft. high. In Haddingtonshire, at Tynningham, 26 years planted, it is 24 ft. high. In Banffshire, at Gordon Castle, 16 years planted, it is 14 ft. high. In France, in the neighbourhood of Paris, it is frequently to be met with from 30 ft. to 40 ft. high; and in the south of Germany about the same height. In Italy and Spain it grows still higher. — *A. c. amara* in Suffolk, at Finborough Hall, 5 years planted, is 15 ft. high; at Great Livermere, 13 years planted, it is 21 ft. high. In Ireland, in Tipperary, at Clonmel, 15 years planted, it is 24 ft. high. — *A. c. macrocarpa*, in the London Horticultural Society's Garden, 6 years planted, is 20 ft. high; and in the Hammersmith Nursery, 4 years planted, it is 18 ft. high.

Commercial Statistics. Standards of the common almond, in the London nurseries, are 1s. 6d. each; at Bollwyller, 1 franc; and at New York, 50 cents. *A. e. macrocarpa*, in the London nurseries, is from 1s. 6d. to 2s. 6d. a plant.

§ 3. *A. ORIENTALIS* Ait. The Eastern Almond Tree.

Identification. Ait. Hort. Kew., ed. 1. i. p. 162, ed. 2., iii. p. 195.; Dec. Prod., 2. p. 530.; Don's Mill., 2. p. 482.

Synonymes. *A. argentea* Lam. Dict., 1. p. 103., N. Du Ham., 3 p. 115.

Engraving. Lodd. Bot. Cat., t. 1137.

Spec. Char., &c. Imperfectly evergreen. Branches and leaves clothed with a silvery tomentum; petiole of the leaf short, the disk lanceolate and entire. Flowers rose-coloured, and rather longer than those of *A. nana*. Calyx cylindrically bell-shaped. Fruit tipped with a point. (*Dec. Prod.*, ii. p. 530.) A tall shrub or low tree, growing to the height of 8 ft. or 10 ft.; and, according to Bosc, to the height of 15 ft. or 20 ft. It is a native of the Levant; introduced in 1756, and flowering in March and April. It is very striking, from the hoary, or rather silvery, appearance of its leaves; and it makes a handsome plant when budded standard high on the common almond or the plum. Specimens so budded may be seen in the Hammer-smith Nursery. It flowers less freely than the preceding sort; but deserves a place in collections on account of its fine silvery foliage.

App. i. *Other Species of Amygdalus.*

We have little doubt in our own mind, that all the foregoing sorts, except the last, belong to *A. nana* and *A. communis*; and that the almond, the peach, and the nectarine are as much modifications of one species, as the different varieties of cabbages are of the wild plant, *Brassica oleracea*. We admit the convenience, however, of giving the sorts different names, and keeping them distinct; and we have accordingly done so. To the kinds we have already enumerated we may add some others, which, whether they are varieties or species, we are unable to determine; but we see nothing in the specific character to render it impossible that they may be only varieties; and, when we consider the different modifications which the tree undergoes, under the different circumstances of climate and culture to which it has been subjected, we incline, as usual, to the side of simplification.

§ *A. Tournefortii* Bosc is said to be found in Asia Minor, Persia, and the adjoining countries. Rosier, and other French authors, consider it as the original type of the common species; but Bosc, who cultivated it in Carolina, says he considers it as a distinct species, because the extremities of its shoots were not thorny, as those of the common almond are in a perfectly wild state; and because it only grows to 3 ft. or 4 ft. in height. (*Bosc, in N. Cours complet d'Agriculture*, art. *Amandier*.)

§ *A. cochinchinensis* Lour. Fl. Cochin., p. 316. Native of Cochin-China, in woods. Corolla white. Kernel like the common almond in form and smell. Tree from 30 ft. to 40 ft. high. (*Don's Mill.*, ii. p. 493.)

§ *A. microphylla* H. B. et Kunth, Nov. Gen. Amer., 6. p. 245. t. 564. Native of Mexico, between Paehucha and Moran, on arid hills, at the height of 3900 ft. Flowers small, pink. Shrub, 3 ft. high. (*Don's Mill.*, ii. p. 493.)

GENUS II.



PE'RSICA Tourn. THE PEACH TREE. *Lin. Syst.* Icosándria Monogýnia.

Identification. Tourn. Inst., t. 400.; Mill. Diet.; Dec. Fl. Fr., 487.; Don's Mill., 2. p. 483.

Synonymes. *Amygdalus* sp. of *Lin.* and *Juss.*; *Trichocarpus* Neck. *Elém.*, No. 718.; Pécher, *Fr.*;

Pfirschenbaum, *Ger.*

Derivation. So named from the peach coming originally from

396

Description, &c. The species are well-known fruit trees, in cultivation in gardens throughout the temperate regions of the world: in the middle and south of Europe, the fruit ripens in the open air; but in the north of Germany and Russia, and in Denmark and Sweden, only against a wall, or under glass. The species have the same medicinal properties as those of *Amygdalus*, but in a slighter degree. The peach and the nectarine are by some botanists made distinct species; but there can be no doubt of their being only varieties of one kind,



1 2 3 4

which kind is itself nothing more than an improved or fleshy almond; the almond being to the peach and nectarine what the crab is to the apple, and the sloe to the plum. To prove that the peach and the nectarine are essentially the same species, we may mention that fruits of both have been found on the same branch; and a fruit has been even discovered with the smooth surface of the nectarine on one side, and the downy skin of the peach on the other side. (See *Gard. Mag.*, vol. i. p. 471., vol. iv. p. 53., and our fig. 396.)

‡ 1. *P. VULGARIS* Mill. The common Peach Tree.

Identification. Mill. Dict., No. 1; Dec. Fl. Fr., 4. p. 487.; Prod., 2. p. 531.; Don's Mill., 2. p. 483.
Synonymes. *Amygdalus Persica* Lin. Sp., 677., *Lam. Dict.*, 1. p. 99. No. 1—20. and 28—42., *Norsette Jard. Fruit.*, No. 1—16. 22—35; *Pêche duveleuse, Fr.*; *Pfirsche, Ger.*
Engravings. N. Du Ham., 1. 2—8.; Nois. Jard. Fruit. Icon.; and the plate of this tree in our Second Volume.

Varieties.

‡ *P. v.* 1, the freestone common Peach, has the flesh of the fruit parting from the shell of the nut (the stone). *Pêche, Fr.*

‡ *P. v.* 2, the clingstone common Peach, has the flesh of the fruit adhering to the shell of the nut (the stone). *Pavie, Fr.*

‡ *P. v.* 3 *flöre pleno* Hort. The double-flowering common Peach.

‡ *P. v.* 4 *alba* Lindl. The white-flowering common Peach, Bot. Reg., t. 1586. — “The white-blossomed

peach is a hardy ornamental shrub, with the habit of an almond. Its fruit has little merit.” (*Lindley.*) The flowers of this variety being produced as early as those of the common peach, their different colour will contribute to the variety of the shrubbery.

‡ *P. v.* 5 *foliis variegatis* Hort. The variegated-leaved Peach Tree.

‡ *P. v.* 6 *compressa* Hort., the flat Peach of China, (*Hort. Trans.*, iv. t. 19. and our fig. 397.) is chiefly remarkable for the form of its fruit, and for being nearly evergreen in its leaves.

In the Horticultural Society's Garden, against a wall, it keeps growing throughout the winter, when the weather is not too severe. (*Encyc. of Gard.*, ed. 1835, p. 908.)



‡ 2. *P. (v.) LE'VIS* Dec. The smooth-skinned Peach, or Nectarine Tree.

Identification. Dec. Fl. Fr., 4. p. 487.
Synonymes. *Amygdalus Persica* Lam. Dict., 1. p. 100. No. 21—27.; *A. Persica Nectarina* Ait. Hort. Kew., ed. 2. vol. 3. p. 194.; *Nois. Jard. Fruit.*, p. 89—90. No. 17—22.; *Pêche lisse, Brugnion, Fr.*
Engravings. Nois. Jard. Fruit., t. 20. f. 2, 3., t. 21. f. 3, 4.

Varieties. There are two forms of this kind, —

‡ *P. (v.) l.* 1, the freestone Nectarine, with the fruit parting from the nut. *Pêche lisse, Fr.*

‡ *P. (v.) l.* 2, the clingstone Nectarine, with the flesh adhering to the nut. *Brugnion, Fr.*

Description, &c. The different varieties of peach and nectarine, when treated as standard trees in the open garden, assume the general form and character of the almond; but, as they are more delicate, in consequence of being farther removed from their aboriginal state, they are of slower growth, form trees of less size, and are of shorter duration. The nectarine, as a standard in the open garden, forms a smaller and more delicate tree than the peach; and the double-flowered peach is of less vigorous growth than most of the single-flowered varieties.

Geography, History, &c. The peach is generally considered to be a native of Persia, in which country it is common, both wild and in a state of culti-

vation ; and where, according to Royle, both the free and clingstone varieties are known ; the former being called kulloo, and the latter karlee. The tree is found wild in different parts of the Himalayas, at elevations of 5000 ft. and 6000 ft. In the district of Bissehur there is a distinct kind, called bhence by the natives (*Pérsica saligna Royle*), which, though small, is juicy and very sweet. The nectarine is found in gardens in Northern India, where it is called shuftaloo, and moonidia (smooth) aroo (peach), though it does not perfectly ripen its fruit, nor is it known whence it was introduced, though, probably, from Caubul. (*Royle Illust.*, p. 204.) The Romans received the peach from Persia, during the reign of the Emperor Claudius. It is mentioned in the writings of Columella ; and several sorts are described by Pliny. It was in cultivation in England about the middle of the 16th century ; but, in all probability, was first introduced when the Romans had possession of the country. It is now in general cultivation as a fruit tree, against walls, in the middle and north of Europe ; as a standard tree, in fields and gardens, in Italy, Spain, and the north of Africa, and in various countries of the East, including Persia, India, and China. It was carried to North America by the first European settlers, probably at the end of the 16th, or the beginning of the 17th, century ; and it is now cultivated there, in extensive plantations, for the distillation of peach brandy, and for fattening hogs. These plantations grow with such luxuriance, that the orchards almost resemble forests. The nuts are sown, and no other care is bestowed on the plants than that of removing the larger weeds for a year or two. In four years they commence bearing, and continue to grow and to produce fruit for 20 or 30 years. In South America, the peach has been generally introduced by the Spaniards ; and Sir Francis Head, in his *Rough Notes*, mentions the beauty of the trees among the corn fields of Mendoza.

Properties and Uses. The fruit-bearing varieties are cultivated entirely for their fruit ; and those with double flowers, and variegated leaves, as ornamental objects in shrubberies. For this last purpose, what has been stated relatively to the almond will apply to the peach and nectarine ; and for their culture as fruit trees, we refer to our *Encyclopædia of Gardening*. Medicinally, and in domestic economy, the fruit, leaves, and flowers may be substituted for those of the almond. From the wood of the peach tree the colour called rose pink is procured. As an ornamental tree, the only varieties worth cultivating are, the Tunbridge peach, which will grow well as a standard ; the double-flowered peach, which is extremely ornamental, and groups well with the double-flowered cherry and plum ; and the variegated-leaved. The price of plants is the same as for the almond.

GENUS III.



ARMENTACA Tourn. THE APRICOT. *Lin. Syst.* Icosándria Monogýuia.

Identification. Tourn. Inst., t. 399. ; Juss. Gen., 341. ; Dec. Fl. Fr., 4. p. 485. ; Prod., 2. p. 531. ; Don's Mill., 2. p. 495.

Synonymes. Prúnus sp. of *Lin.* and others ; Abricotier, *Fr.* ; Aprikosenbaum, *Ger.*

Derivation. The genus is named *Armeniaca*, from the apricot being originally from *Armenia*. The popular English name was originally *præcocia*, from the Arabic, *berkoche* ; whence the Tuscan *baocche*, or *albicocco* ; and the English, *abricot*, or *apricock*, eventually corrupted into *apricot*. Some persons derive the name from *præcox*, from this fruit ripening sooner than most others.

Description, &c. A fruit tree, in general cultivation throughout the temperate regions of the globe, distinguished at first sight from the almond, peach, and nectarine, by its heart-shaped, smooth, shining leaves, and white flowers. There are several wild varieties, bearing flowers of different shades of pink, chiefly cultivated as ornamental. The great beauty of both the wild and the cultivated sorts of apricot is, that they come into bloom in Britain before almost every other tree ; the Siberian apricot flowering a fortnight, or more, before the common sloe or almond.

‡ 1. *A. VULGARIS* Lam. The common Apricot Tree.

Identification. Lam. Dict., 1. p. 2.; Dec. Prod., 2. p. 532.; Don's Mill., 2. p. 495.

Synonyme. Prunus Armeniaca Lin. Sp., 679.

Engravings. N. Du Ham., 1. t. 49.; and the plate in our Second Volume.

Spec. Char., &c. Flowers sessile. Leaves heart-shaped or ovate. A native of Armenia. (Dec. Prod., ii p. 532.)

Varieties. There are two forms of this kind of apricot, either of which may be considered as the species; and two varieties:—

‡ *A. v. 1 ovalifolia* Ser. *The oval-leaved common Apricot Tree.*—Leaves oval, fruit small. (*Nois. Jard. Fruit.*, t. 1. f. 2., t. 2. f. 1, 2.; *Lois. in N. Du Ham.*, 5. t. 50. f. 6.; and our fig. 398.) Synonymes: Abricot Angoumois, A. précoce, A. blanc, Fr.

‡ *A. v. 2 cordifolia* Ser. *The heart-shaped-leaved common Apricot Tree.*—Leaves heart-shaped, broad. Fruit larger. (*Nois. Jard. Fruit.*, t. 1. f. 3., t. 2. f. 3.; *Loisel. in N. Du Ham.*, 5. p. 167. t. 49.; and our fig. 399.)

‡ *A. v. 3 foliis variegatis* Hort. *The variegated-leaved common Apricot.*

‡ *A. v. 4 flore pleno* Hort. *The double-blossomed common Apricot.*—Grosier says that the Chinese have a great many varieties of double-blossomed apricots, which they plant on little mounds.

Description, &c. A tree, growing rapidly to the height of 20 ft. or 30 ft., with a handsome, spreading, somewhat orbiculate head, and branches furnished with numerous

398



buds, and clothed with large, heart-shaped, smooth, shining leaves. The flowers are white, and, appearing before the leaves, generally in March, are very ornamental at that season, when few trees are in flower except the almond

399

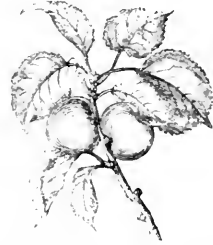

and the sloe. It is a native of Armenia, Caucasus, the Himalayas, China, and Japan, where it forms a large spreading tree. Both in Caucasus and China, it is more frequent on mountains than on plains, which affords a proof of its great hardiness; though in England it seldom ripens its fruit except when trained against a wall. The tree was cultivated by the Romans, and is described by Pliny and Dioscorides; and, though the first notice of its being in England is in Turner's *Herbal*, printed in 1562, yet there can be no doubt that it was introduced by the Roman generals. It is now in as universal cultivation for a fruit tree as the peach; and it is better deserving of a place in the shrubbery than that tree, on account of its more vigorous growth, and its much handsomer general shape, independently of its more beautiful leaves. Very few trees attain the appearance of maturity so soon as the apricot; a standard 10 or 12 years planted, in good loamy rich soil, will grow to the height of 20 ft., with a head 25 ft. in diameter, presenting all the appearance of a tree of 20 or 30 years' growth, or of a tree arrived at maturity. Hence the value of this tree in planting small places, which it is desired to make appear large and old. The same remark will apply to most other kinds of fruit trees treated as standards, and to different kinds of Crataegus, and all the wild varieties of the rosaceous fruit trees. The grounds of a small villa, planted with such trees alone, would assume quite a different character from those in which such trees were intermixed with rapid-growing sorts. In the former case, there would be unity of expression; in the latter, nothing, viewed as a whole, but discordance of parts, however much beauty there might be in the trees taken individually. Proofs of the rapid growth of the apricot may be seen in the standard apricot trees in the London Horticultural Society's

Garden. The best variety for producing fruit, as a standard, is the Breda apricot. (*Encyc. of Gard.*, ed. 1835, p. 918.) It is also a very handsome-growing plant, and its blossom buds, before they are expanded, are of a most beautiful and brilliant scarlet. There is a blotched-leaved variety of this kind of apricot. Price of plants the same as of those of the almond.

‡ 2. *A. DASYCÁRPA* Pers. The thick-fruited Apricot Tree.

Identification. Pers. Syn., 2. p. 36.; Dec. Prod., 2. p. 532.; Don's Mill., 2. p. 497.

Synonymes. *A. atropurpurea* Lois. in *N. Du Ham.*, 5. p. 172.; *Prúnus dasycarpa* Ehrh. *Beitr.*, 6. p. 90.; *P. Armeniaca nigra* Desf. *Cat.*, ed. 2. p. 206.; the black Apricot.

Engravings. *N. Du Ham.*, 5. t. 51. f. 1.; Lodd. *Bot. Cab.*, t. 1250.; and our figs. 400, 401

Spec. Char., &c. Leaves ovate, acuminate, doubly serrate. Petioles glanded. Flowers upon thread-



shaped pedicels. In the flowers of a plant in the Geneva Botanic Garden, the calyx was purple, and 6-lobed; the petals were 6; and the stamens 24. Native country not known. (*Dec. Prod.*, ii. p. 352.) A tree with a twisted trunk, resembling the common apricot, but smaller. Introduced in 1800, and flowering in April. It merits cultivation for its flowers, which are generally white, but which, in this country, from the earliness of their appearance, are not often succeeded by fruit, unless the tree is planted against a wall, when it can be protected

401

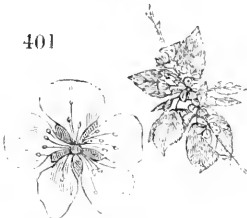

by netting. Trees of this kind are particularly desirable as standards among evergreens, planted on warm sandy declivities facing the south. They are also very desirable in the composition of spring-flowering hedges.

Variety.

‡ *A. d. 2 persicifolia* Lois. (*N. Du Ham.*, 5. p. 172. t. 52. f. 1.; and our fig. 402.)

Abricot noir à Feuilles de Pêcher, *Fr. The Peach-leaved thick-fruited Apricot.*—Leaves ovate and short, or lanceolate, with small lobes. Flesh of the fruit red, variegated with pale yellow. In Don's *Miller*, this kind is made a species. In the *Nouveau Du Hamel*, it is stated to be a very slight variety, which can only be continued by budding.



402

‡ 3. *A. (v.) SIBÍRICA* Pers. The Siberian Apricot Tree.

Identification. Pers. Syn., 2. p. 36.; Dec. Prod., 2. p. 532.; Don's Mill., 2. p. 498.

Synonymes. *Prúnus sibirica* Lin. *Sp.*, 679.

Engravings. Ammann *Stirp. Ruth.*, 272. t. 29.; Pall. *Fl. Ross.*, 1. t. 8.; and our plate in Vol. II.

Spec. Char., &c. Leaves ovate acuminate, of the form of those of the beech. The petioles long and glandless. Fruit small. A native of mountainous districts in the most remote parts of Siberia. Persoon has stated (*Syn.*, ii. p. 36.) that it varies with leaves linear-lanceolate. (*Dec. Prod.*, ii. p. 532.) A tree, having the general appearance of the common apricot, but smaller in its parts. According to Pallas, it is chiefly found in the Russian empire, on the mountains of Dahuria, growing upon the face of perpendicular rocks exposed to the sun. These low trees, in such situations, do not attain a greater height than that of a man; but they have trunks the thickness of the wrist, a rough and black bark, and hard wood. The Siberian apricot flowers in May, about the same time as the *Rhodo-*

déndron daüricum; growing on the south sides of the mountains, while the latter grows on the north sides. When both these plants are in flower, Pallas observes, the north sides of the mountains appear of a purple colour, and the south of a rose colour. (*Fl. Ross.*, i. p. 13.) In British gardens, the Siberian apricot forms a tree of nearly the same height as the common apricot, of which it appears to us nothing more than a variety. There is a specimen in the garden of the London Horticultural Society, from which our figure was taken, and which, in 1835, had attained the height of 12 ft. in 10 years. It is propagated by budding on the plum; and plants may be obtained in some of the nurseries at the usual price of worked trees; viz. 1s. 6d. for dwarfs, and 2s. 6d. for standards.

‡ 4. *A. (v.) BRIGANTIACA Pers.* The Briançon Apricot Tree.

Identification. Pers. Syn., 2. p. 36.; Dec. Prod., 2. p. 532.; Don's Mill., 2. p. 498.

Synonymes. Prunus brigantiaca Vill. Dauph., 3. p. 535., Dec. Fl.

Fr., No. 5789., Lois. in N. Du Ham., 5. p. 185.

Engraings. N. Du Ham., 5. t. 59.; and our fig. 403.

Spec. Char., &c. Leaves nearly heart-shaped, toothed with numerous sharp subimbricate teeth. Flowers in groups, almost sessile, scarcely protruded before the leaves. (*Dec. Prod.*, ii. p. 532.) A native of Dauphiné, which Seringe suggests to be the same as *A. sibírica*, and which, very probably, is only another variety of the common apricot. It grows only in one locality in France, and in another in Piedmont, where an oil called, commonly, in France, huile de marmotte, has for a long time been expressed from the seeds. In British gardens, into which it was introduced in 1819, it grows to the height of 14 ft. or 15 ft. in 10 or 12 years, flowering in March and April.



403

GENUS IV.



PRUNUS Tourn. THE PLUM. *Lin. Syst.* Icosándria Monogýnia.

Identification. Tourn. Inst., t. 358.; Juss. Gen., 341.; Dec. Fl. Fr., 4. p. 483.; Prod., 2. p. 532.; Don's Mill., 2. p. 498.

Synonymes. Prunophora Neck. Elem., No. 719.; Prunus sp. of *Lin.* and others.

Derivation. Said to be a word of Asiatic origin; the wild plant, according to Galen, being called *prumnos* in Asia. The Greek name for the plum is *prouñe*; it occurs in Theophrastus.

Description, &c. The species are chiefly deciduous low trees or shrubs, many of them spiny in a wild state; natives of Europe, Asia, and North America; and generally thriving best on calcareous soils. Most of them bear edible fruits; and all of them have showy blossoms. In British gardens, they are chiefly propagated by grafting, but some of them by layers; and they will grow in any soil that is tolerably free, and not overcharged with moisture. The epidermis of the bark of the plum, as well as that of the cherry, and perhaps that of some of the other genera of *Amygdalææ*, is readily divisible transversely, and may frequently be seen divided in this manner into rings on the tree. Upwards of 30 species are enumerated in our *Hortus Britannicus*; but we question much if one half of them are not mere varieties. The prices of most of the kinds, in British nurseries, are from 1s. to 1s. 6d. for dwarfs, and 2s. 6d. for standards; at Bollwyller, 1 franc for dwarfs, and 2 francs for standards; and at New York, 37½ cents for dwarfs, and 50 cents for standards.

‡ 1. *P. SPINOSA L.* The spiny Plum Tree, or common Sloe Thorn.

Identification. Lin. Sp. 681.; Smith's Eng. Flora, 2. p. 357.; Dec. Prod., 2. p. 532.; Don's Mill., 2. p. 498.

Synonymes. *P. sylvéstris Fuch. Hist.*, p. 404.; *Ray Syn.*, p. 462.; Blackthorn; Prunier épineux, Prunellier, Épine noire, or Mère-du-Bois, Fr.; Schleadorn, or Schlen Pflaum, Ger.

Engravings. Vahl Fl. Dan., t. 926.; and our plate in Vol. II.

Derivation. The name of Mère-du-Bois is applied to the sloe thorn in France, in the neighbourhood of Montargis, because it has been remarked there, that, when it was established on the margins of woods, its underground shoots, and the suckers which sprang up from them, had a constant tendency to extend the wood over the adjoining fields; and that, if the proprietors of lands adjoining forests, where the sloe thorn formed the boundary, did not take the precaution of stopping the progress of its roots, these would, in a short time, spread over their property; and the suckers which arose from them, by affording protection to the seeds of timber trees (which would be deposited among them by the wind, or by birds), would ultimately, and at no great distance of time, cause the whole to be covered with forests. (*N. Du Ham.*) We have observed the same thing to take place in England, and have referred to one particular case in our *Encyc. of Agr.*, ed. 2. § 4578.

Spec. Char., &c. Branches spiny. Leaves obovate, elliptical, or ovate; downy beneath, doubly and sharply toothed. Flowers produced before the leaves or with them, white, and solitary. Calyx campanulate; with lobes blunt, and longer than the tube. Fruit globose; the flesh austere. (*Dec. Prod.*, ii. p. 532.) A low tree or shrub, a native of Europe and Asia. Seringe, in *Dec. Prod.*, has described the following forms of this species:—

- ✕ *P. s. 1 vulgaris* Ser. *P. spinosa* Lois. (*N. Du Ham.*, 5. p. 185. t. 54. f. 1.) *The common Sloe Thorn.*—Leaves obovate-elliptical. Fruit dark purple. This may be considered as the normal form of the species.
- ✕ *P. s. 2 foliis variegatis* Ser. *The variegated-leaved Sloe Thorn.*—This has been found wild; but it is a plant of no beauty.
- ✕ *P. s. 3 microcarpa* Wallr. (*Exs. Cent.*, 1. No. 45.) *The small-fruited Sloe Thorn.*—Leaves elliptic, narrow, bluntnish. Fruit smaller than that of the species.
- ✕ *P. s. 4 macrocarpa* Wallr. (*Exs. Cent.*, 1. No. 45.) *The large-fruited Sloe Thorn.*—Leaves obovate, bluntnish. Fruit large, dark purple. This has been found wild in Germany; but Seringe doubts whether it be not identical with *P. domestica* Juliàna, or with *P. insititia*.
- ✕ *P. s. 5 ovata* Ser. (*Blackw. Herb.*, t. 494.) *The ovate-leaved Sloe Thorn.*—Leaves ovate, roundish.
- ✕ *P. s. 6 flore pleno.* *The double-flowered Sloe Thorn.*—This is a very beautiful variety, said to be in cultivation, and highly prized, in China and Japan; and found, some years ago, at Tarascon. The flowers are white, and are produced in such abundance as to entirely cover the branches. There are fine specimens of the double-blossomed sloe, in the Hammersmith Nursery, from 10 ft. to 12 ft. high; but they do not blossom there so freely as they are said to do in Japan. This kind is well deserving of cultivation: but the other varieties differ so slightly from each other, that they appear to us quite unworthy of being kept distinct; and we should not have noticed them, had they not found a place in such a work as De Candolle's *Prodromus*.

Description. The sloe, or blackthorn, is much more frequently seen as a large spiny shrub, than as a tree; but, when the suckers are removed from it, and all the strength of the plant is allowed to go into one stem, it forms a small scrubby tree of the most characteristic kind. The stems of the sloe differ from those of the hawthorn, in growing to the height of 3 ft. or 4 ft. before they branch off. The bark is black, whence the name of black thorn; and the leaves are dark green. The roots are creeping, and, in every soil and situation, throw up numerous suckers; so much so, that a single plant, in a favourable soil, would cover an acre of ground in a very few years. In hedges, in Britain, it is seldom seen above 20 ft. in height; but in woods and in parks, as single trees, we have seen it above 30 ft. high: for example, in Eastwell Park, in Kent. The flowers are solitary, and contain from 20 to 30 filaments, with orange-coloured anthers. The style is generally only one; but there are sometimes two. The drupe, which is black, exhibits a beautiful blue exudation, or bloom, when ripe; which, as in case of all bloom, whether on fruit or young shoots, is easily removed by handling.

Geography, History, &c. The blackthorn is found, generally throughout Europe, in hedges and copses, in fertile as well as in the most barren soils. It is a native of the south of Russia, Caucasus, and the banks of the Wolga,

but is wanting in Siberia. According to Pallas, it loves a wet, nitrous, and salt soil, flowering about the end of April. It is not a native of North America, but has been introduced there; and, according to Pursh, is now often found in hedges, particularly in Pennsylvania. It is also found in the north of Africa, and in the west and east of Asia. In Europe, it ceases to appear about Upsal, in Sweden; and, in Britain, it ends in Wales, with *Ulex europæa*; but, enduring a moister climate, it is found in highland valleys, where the furze does not grow. (*Watson*.) It does not appear to have been particularly noticed by the Greeks and Romans; but it has a place in all general works on plants, from the time of Fuchsins to the present day. According to some, it is the parent of the bullace plum (*P. insititia*); and, according to others, of *P. domestica* and all its varieties: with which last opinion we coincide.

Properties, Uses, &c. The wood is hard, and in colour resembles that of the peach, though without its beauty: it takes a fine polish; but it is so apt to crack, that little use can be made of it, except for handles for tools, teeth for hay-rakes, swingles for flails, and walking-sticks. The wood weighs, when dry, nearly 52 lb. per cubic foot. The branches, from being less spreading than those of the common hawthorn, make better dead hedges than those of that species; and, for the same reason, they are particularly well adapted for forming guards to the stems of trees planted in grass fields or in parks, to protect them from cattle. They are in general use for this purpose in France. They are also used as a substitute for stones and tiles in draining; and, formed into faggots, they are sold for heating bakers' ovens, and for burning lime or chalk, in kilns, &c. The living plant cannot be recommended for hedges, on account of the rambling habit of its roots, and the numerous suckers they throw up; and because it is apt to get naked below, from the tendency of the shoots to grow upright and without branches. These upright shoots make excellent walking-sticks, which, accordingly, throughout Europe, are more frequently taken from this tree than from any other. They are furnished with sharp thorns, which produce numerous thickly set knots. "The bark" as Cobbett observes in his *Woodlands*, "which is precisely of the colour of the horsechestnut fruit, and as smooth and bright, needs no polish; and, ornamented by the numerous knots, the stick is the very prettiest that can be conceived." (*Woodlands*, § 511.) Leaves of the sloe, dried, are considered to form the best substitute for Chinese tea which has yet been tried in Europe; and they have been extensively used for the adulteration of that article. They possess a portion of that peculiar aromatic flavour which exists in *Spiræa Ulmæria* L. (the meadow sweet), *Gaulthéria procumbens*, and some other plants, and which resembles the more delicate perfume of green tea. Cattle of every kind, and more especially sheep and goats, are fond of the leaves of the sloe thorn, both in a green and in a dried state. Dr. Withering remarks that a wound from the thorns of the sloe is much more difficult to heal than one from the spines of the common hawthorn; whence he concludes that there is something poisonous in the former. The fruit of the sloe is so harshly sharp and austere as not to be eatable till it is mellowed by frost. Its juice is extremely viscid; so that the fruit requires the addition of a little water in order to admit of expression. The juice of the ripe fruit is said to enter largely into the manufacture of the cheaper kinds of port wine; and, when properly fermented, it makes a wine strongly resembling new port. In France, a drink is made by fermenting the fruit with a certain quantity of water: it is acid and astringent, more especially if the fruit has been gathered before it is quite ripe. The habitual use of this drink is said to cause obstructions in the abdominal viscera. In France, the unripe fruit is pickled in salt and vinegar, as a substitute for olives; and, in Germany and Russia, the fruit is crushed, and fermented with water, and a spirit distilled from it. In Dauphiné, the juice of the ripe fruit is used for colouring wine. Letters marked on linen or woollen with this juice will not wash out. Medicinally, the bark is considered a febrifuge; and the leaves as an agreeable and useful astringent.

gent. The flowers, with their calyxes, are moderately purgative. The fruit has been considered a styptic from the time of Dioscorides. The juice obtained from the unripe fruit, and thickened to dryness by a gentle heat, forms the German acacia of the druggists, which was formerly sold under the name of Egyptian acacia; and which, Gerard says, it may be very well used in the stead of, as an astringent in hæmorrhages. The fruit of the sloe, though so astringent when first ripe, ceases to be so, and becomes laxative, when it is on the point of beginning to decay. In domestic economy, a very good preserve is made of it. The bark has been used in tanning leather; a decoction of it in alkali dyes yellow; and in sulphate of iron it forms a beautiful black ink. In Britain, at the present time, the most valuable use of the sloe thorn is for forming a protecting margin to ornamental plantations in parks, along with the *Ulex europæa*. (Sec p.573.) A picturesque group of three or four trees, and one sloe thorn planted in the same hole with one of the trees, will, in a few years, give the whole group a wild character, by the suckers that the sloe will throw up, and form an irregular, impervious, and natural-looking mass. As flowering the first of all the plum tribe, the sloe is a most desirable plant in shrubberies, more especially the double variety; and, where it abounds in thin woods, in which alone it will thrive, its stems and branches afford the cheapest and best protection to newly planted single trees. For this purpose, the lower ends of the thorn should be inserted in the soil, close by the root of the tree, and the upper parts tied close round the stem, by two or more willow withs, at 2 ft. or 3 ft. apart. No single tree fence is less unsightly, because none is less obtrusive. The fruit and blossoms of the sloe have furnished numerous poetical allusions for British song-writers; and there are but few popular ballads in the English language that do not contain some reference to this plant. The sloe prefers a strong calcareous loam. It may be propagated freely by suckers, or by seeds: the latter should be gathered in October, when the fruit is dead ripe, mixed with sand, and turned over two or three times in the course of the winter; and, being sown in February, they will come up in the month of May. The remaining treatment is mere routine.

§ 2. *P. INSITI' TIA* L. The engrafted Plum Tree, or Bullace Plum.

Identification. Lin. Sp., 680.; Dec. Prod., 2. p. 532.; Don's Mill., 2. p. 498.

Synonymes. *P. sylvestris præcox* Ælior *Tourn.*; *P. sylvestris major* *Ruy*; *Prunier sauvage*, *Fr.*; *Kirschen Pflaume*, *Ger.*

Engravings. Eng. Bot., t. 841.; Hayne Abbild., t. 65.; and our plate in Vol. 11.

Spec. Char., &c. Branches becoming spiny. Flowers in pairs. Leaves ovate or lanceolate; villose beneath, not flat. Fruit roundish. (*Dec. Prod.*, ii. p. 532.) Found wild in England, Germany, and the south of France, and also in Barbary. Seringe suggests that this species may be a variety of *P. spinosa*; and, as we are of the same opinion, we shall pass it over, only observing, that its fruit, which is globular, and usually black, is sometimes yellowish, or waxy, with a red tint, and sometimes red; it is also so much less austere than the sloe, as to make excellent pies and puddings, and a very good preserve. Plants are to be procured in the nurseries. The fruit of this plum is known, in Dauphiné, under the name of alfâtons; and in Provence they are called prunes sibarelles, because it is impossible to whistle after having eaten them, from their sourness. The wood, the branches, the fruit, and the entire plant are used, throughout France, for the same purposes as that of the sloe.

Varieties.

§ *P. i.* 1 *fructu nigro* Hort. The black-fruited, or common, Bullace.

§ *P. i.* 2 *fructu luteo-âlbo* Hort. The yellowish-white-fruited Bullace.

§ *P. i.* 3 *fructu rubro* Hort. The red-fruited Bullace.

§ *P. i.* 4 *flôre plêno* Hort., the double-flowered Bullace, is mentioned by Desceinet in *Mém. de la Russie Méridionale*, 1. p. 63.

§ 3. *P. DOMESTICA* L. The domestic cultivated Plum Tree.

Identification. Lin. Sp., 680.; Dec. Prod., 2. p. 533.; Don's Mill. 2. p. 499.

Synonymes. *P. sativa* *Fuchs* and *Ruy*; *Prunier domestique*, *Fr.*; *gemeine Pflaume*, *Ger.*

Spec. Char., &c. Branches spineless. Flowers mostly solitary. Leaves lanceolate-ovate, concave on the surface, not flat. Spontaneous in elevated places of the more southern parts of Europe. (*Dec. Prod.*, ii. p. 533.) In England, found sometimes in hedges, but never truly wild. A tree, from 15 ft. to 20 ft. in height, resembling the common sloe, but larger in all its parts, and without thorns. There are numerous varieties and subvarieties; but, as they belong more to pomology than to arboriculture, we shall here only notice those that have some pretensions to distinctness in an ornamental point of view.

‡ *P. d. 2 flore pleno* Hort. *The double-blossomed Plum.*—The flowers are large and handsome; but, if the plants are not carefully supplied with abundance of nourishment, they very readily degenerate into semidouble, or single ones.

‡ *P. d. 3 foliis variegatis* Hort. *The variegated-leaved Plum.*—There are few of the variegated-leaved *Rosaceæ* of any beauty; and this plant forms no exception to the general remark.

‡ *P. d. 4 myrobálana* Lin. Sp., 680. *P. Myrobálan Du Ham. Arb.*, ii. p. 111. t. 2. f. 15.; *P. mirobálana Lois.*; *P. cerasífera Ehrh. Beitr.*, 4. p. 17.; *Prunier myrobálan, or Cerisette, Fr.*; *Kirschpflaume, Ger.* *The Myrobálan, or Cherry, Plum.* (See our plate in Vol. II.)—Sepals narrow. Fruit globose, depressed at the base; umbilicus depressed; nut with a small point. (*Dec. Prod.*, ii. p. 533.) This sort well deserves culture as an ornamental tree, on account of its very early flowering. In England, it seldom produces fruit, as the blossoms, being more tender than those of the sloe, and appearing earlier than those of the fruit-bearing varieties, are generally injured by the frost. It is by some supposed to be a native of North America; but, according to Pursh, it is only found in that country near houses.

‡ *P. d. 5 m. foliis variegatis* N. Du Ham. *The variegated-leaved Myrobálan, or Cherry, Plum.*

‡ *P. d. 6 armenióides* Ser. *The Apricot-like Plum, or Drap d'Or.*—The leaves, the fruit, and the general habit of the plant bear some resemblance to those of *Armeniaca brigantiaea*.

Description, History, &c. The myrobálan plum tree appears to be the first remove from *Prunus insitítia*; and the apricot-like plum seems intermediate between the wild plum and the wild apricot. The varieties cultivated for their fruit have, in general, much larger leaves, and stronger young shoots, than the other sorts; they flower later, their blossoms are larger, and their fruit, particularly such sorts as the magnum bonum and the diamond plum, several times as large; the latter being upwards of $2\frac{1}{2}$ in. long. These fruit-bearing varieties are in universal cultivation in temperate climates; and for every thing of interest relating to them, as such, we refer to our *Encyclopædia of Gardening*, edit. 1835, p. 920. Those varieties which deserve culture as ornamental trees are considered, by Mr. Thompson of the Horticultural Society's Garden, to be, the red magnum bonum, which has a fastigate habit of growth; the Washington, which is a vigorous-growing tree, with a pyramidal head, and is a great bearer of fruit of excellent quality; and the wheat plum, which deserves a place in ornamental plantations for its bright fiery red-coloured fruit. The wood of the plum tree is hard, close, compact, beautifully veined, and susceptible of a fine polish. It weighs, when dry, 55 lb. 14 oz. to the cubic foot. Its colour is brought out by washing it with lime-water, and it is preserved by the application of wax as a varnish. In France and Germany, it is much sought after by cabinetmakers and turners, and also by musical instrument makers. The leaves are eaten by cattle; but both the leaves and the flowers are extremely liable to be attacked by insects, more especially in spring, from the hatching of the eggs which had been deposited in the buds, or on the bark, during the preceding season.

Properties and Uses. The use of the fruit in domestic economy, in Britain

for the dessert, and for making tarts and puddings, is well known. In France, plums are used principally dried, as an article of commerce.

Brignoles, Prunes, and French Plums. The kinds of plum usually employed for preserving, in France, are the Brignole, the prune d'Ast, the Perdrigon blanc, the prune d'Agen, and the Ste. Catherine. The first and second are grown principally near the little town of Brignoles, in Provence; and the Brignole is used for making the preserved plum sold in London, in round boxes divided with cut white paper, as a sort of dry sweetmeat. The fruit is large and yellow, with a reddish tinge on the side next the sun; and the flesh is rather insipid, and very sweet. The prune d'Ast is a large long plum, with a deep violet coriaceous skin, and abundant bloom, and is chiefly used for preparing what are called, in England, French plums. The Perdrigon blanc is generally used for prunes. The fruit is long, and narrow at the base, of a greenish white, tinged with red, with rather a leathery skin, and abundant bloom. The flesh is greenish, melting, and so sweet, as to have nearly the same flavour when eaten ripe from the tree, as when preserved. The Ste. Catherine plum is a large yellowish plum; the fruit of an oval shape, tapering towards the base; remarkably sweet, and of an agreeable flavour, when gathered from the tree. The prune d'Agen is nearly black, fleshy, and rather insipid, with a coriaceous skin, and abundant bloom.

The mode of preparing the Brignole plums is exactly the same now as, according to Olivier De Serres, was practised in the 16th century. The plums, which are called, in the country, pistoles, are not gathered till the sun has dried them from the dews; and the trees are slightly shaken, so that only the ripest of the plums may fall on table-cloths, laid on the ground under the trees, ready to receive them. The plums are spread out in shallow baskets, and placed in a dry and cool place. The next day the skin is peeled off them by women accustomed to the employment, who use their thumb-nails to raise the skin, frequently dipping their hands in water, to keep them cool. The use of any iron or steel instrument is strictly forbidden, as it would spoil the delicate colour and transparent appearance of the dried fruit. The plums are then placed on wooden sieves, or wicker frames, and exposed to the sun for several days; after which they are threaded at the tip on little rods, or wands, so as not to touch each other, and hung up to dry in the sun and air; being carefully placed under cover every night. When every particle of watery matter appears to be evaporated, the stones are taken out of the fruit by the hand, and the plums are pressed together in such a manner as to render them quite round. They are then again put on the wicker sieves, and exposed to the sun; and, when perfectly dry, are arranged carefully with white paper, cut at the edges, in little round flat boxes made of thin strips of the wood of the willow, for sale.

Preparations of Prunes and French Plums. The best prunes are made near Tours, of the Ste. Catherine plum and the prune d'Agen; and the best French plums are made in Provence, of the Perdrigon blanc, the Brignole, and the prune d'Ast; the Provence plums being most fleshy, and having always most bloom. Both kinds are, however, made of these, and other kinds of plums, in various parts of France. The plums are gathered when just ripe enough to fall from the trees on their being slightly shaken. They are then laid separately on frames, or sieves, made of wicker-work or laths, and exposed for several days to the sun, till they become as soft as ripe medlars. When this is the case, they are put into a spent oven, shut quite close, and left there for twenty-four hours; they are then taken out, and the oven being slightly reheated, they are put in again when it is rather warmer than it was before. The next day they are again taken out, and turned by slightly shaking the sieves. The oven is heated again, and they are put in a third time, when the oven is one fourth degree hotter than it was the second time. After remaining twenty-four hours, they are taken out, and left to get quite cold. They are then rounded, an operation which is performed by turning the stone in the plum, without breaking the skin, and pressing the two ends together between thumb and finger. They are then again put upon the sieves, which are

placed in an oven, from which the bread has been just drawn. The door of the oven is closed, and the crevices are stopped round it with clay, or dry grass. An hour afterwards, the plums are taken out, and the oven is again shut, with a cup of water in it, for about two hours. When the water is so warm as just to be able to bear the finger in it, the prunes are again placed in the oven, and left there for twenty-four hours, when the operation is finished, and they are put loosely into small, long, and rather deep boxes, for sale. The common sorts are gathered by shaking the trees; but the finer kinds, for making French plums, must be gathered in the morning, before the rising of the sun, by taking hold of the stalk between the thumb and finger, without touching the fruit; and laid gently on a bed of vine leaves in a basket. When the baskets are filled, without the plums touching each other, they are removed to the fruit-room, where they are left for two or three days exposed to the sun and air; after which the same process is employed as for the others; and in this way the delicate bloom is retained on the fruit, even when quite dry.

Zwetschen Wasser and Raki. Both these liquors closely resemble kirschwasser; and the former is prepared in the same manner. Raki is made in Hungary, by fermenting apples ground or crushed with bruised plums, and distilling the liquor. The spirit produced is said to be very agreeable to the taste, and, though not quite so strong, much more wholesome than brandy. In the south of France, an excellent spirit is obtained from the bruised pulp and kernels of plums, fermented with honey and flour, by distillation in the usual manner.

Soil, Situation, Propagation, &c. The plum prefers a free loamy soil, somewhat calcareous, and a situation open and exposed to the sun. The ornamental and fruit-bearing kinds are almost invariably propagated by grafting or budding; and this is generally performed on stocks of the muscle, St. Julien, or any of the free-growing-plums; or on the Mirabelle plum, when the plants are intended to form dwarfs. The stocks may either be raised from seeds, treated as recommended for those of the sloe, or from layers. Plants are obtained, by the latter mode, in a very simple and expeditious manner. The shoots of the preceding year, which have risen from the stools, are pegged down to the ground quite flat, and covered to the depth of an inch with soil. The entire shoot being thus covered and kept moist, there is an equal stimulus applied to all the buds on it; each of which produces a vertical shoot, a foot or two in length, according to the soil and the season; and each of these shoots, when taken off in the November following, is found to have abundance of roots. The branches which were laid down to produce these shoots are then cut off close to the stool; and the shoots produced from the centre of the stool, during summer, are, during winter, or early in spring, laid down in their turn, as above described. This is the practice in the Goldworth and other nurseries, where stocks are raised in immense quantities to supply the general demand of the trade.

✻ 4. *P. CA'NDICANS* Balb. The whitish-leaved Plum Tree.

404



Identification. Balb. Cat. Taur., 1813. p. 62.; ? Willd. Enum. Suppl., p. 32.; Dec. Prod., 2. p. 533.; Don's Mill., 2. p. 498.
Engraving. Our figs. 404. 405.

Spec. Char., &c. Branches pubescent.

Flowers 2 or 3 together, upon short pubescent peduncles. Calyx bell-shaped. Leaves broadly ovate, whitish beneath. Stipules of the length of the petiole, very narrow, and cut in a toothed manner. (*Dec. Prod.*, ii. p. 532.) A shrub, growing to the height of 6 ft. or 8 ft.; introduced in 1820, and producing its white flowers in April. It is not known of what country it is a native.

405



❖ 5. *P. COCOMILLA* Tenore. The Cocomilla Plum Tree.

Identification. Tenore Prod. Suppl., 2. p. 67.; Cat., 1819, p. 46.; Dec. Prod., 2. p. 533.; Don's Mill., 2. p. 498.

Spec. Char., &c. Flowers upon short peduncles, in pairs. Leaves obovate, crenulate, glabrous on both surfaces; the crenatures glanded. Fruit ovate-oblong, with a small point, yellow, ? bitter or ? acid. (*Dec. Prod.*, ii. p. 533.) A shrub, a native of Calabria, in hedges, where it grows to the height of 2 ft. or 3 ft., and produces its white flowers in April. It was introduced in 1824. The bark is febrifugal, and, in Calabria, is considered to be a specific for the cure of the pestilential fevers common in that country.

❖ 6. *P. MARI'TIMA* Wangenheim. The sea-side-inhabiting Plum Tree.

Identification. Wangenh. Amer., 103., according to Willd. Enum., p. 519.; Pursh Fl. Amer. Sept., 1. p. 532.; Dec. Prod., 2. p. 533.; Don's Mill., 2. p. 499.

Spec. Char., &c. Leaves lanceolate-ovate, serrate. Flowers in pairs. Fruit small, round, sweet, dark blue. (*Dec. Prod.*, ii. p. 533.) A shrub, a native of North America, in sandy soils, on the sea coast, from New Jersey to Carolina, where it grows to the height of 6 ft. or 8 ft. Introduced in 1818, and producing its white flowers in April and May. In its native country, these are succeeded by fruit, of the size of a pigeon's egg, dark purple, and, according to Pursh, very good to eat. There are plants in some of the principal European nurseries; but we are not aware of any of them having yet ripened fruit. *P. acuminata* Michx. (*Fl. Bor. Amer.*, p. 284.) is thought by Pursh to be identical with this species.

❖ 7. *P. PUBESCENS* Poir. The pubescent-leaved Plum Tree.

Identification. Poir. Suppl., 4. p. 584., not of Pursh; Dec. Prod., 2. p. 533.; Don's Mill., 2. p. 499.

Spec. Char., &c. Leaves with short pubescent petioles, and disks that are slightly pubescent, ovate, thickish, rounded, or shortly acuminate and unequally toothed. Flowers mostly solitary and nearly sessile. Fruit oval. (*Dec. Prod.*, ii. p. 533.) A shrub, growing to the height of 2 ft. or 3 ft., and producing its white flowers in May. It has been in cultivation in Britain since 1818; but its native country is unknown.

❖ 8. ? *P. DIVARICATA* Led. The divaricate (?-branched) Plum Tree.

Identification. Ledeb. Ind. Hort. Dorp., Suppl. 1824, p. 6.; Dec. Prod., 2. p. 534.; Don's Mill., 2. p. 504.

Spec. Char., &c. Branches spineless. Leaves with glandless petioles, and disks oblong-elliptical, tapered to both ends, concave above, serrate, glabrous, with the midrib bearded beneath. Flowers solitary, very numerous. Calyx reflexed. Fruit elliptical, yellow. (*Dec. Prod.*, ii. p. 534.) A shrub, growing to the height of 8 ft. or 10 ft. on Caucasus, and producing its numerous white flowers in April. It has been in cultivation in Britain since 1820; but it is not common in collections.

App. i. Other Species of Prunus.

P. microcarpa Meyer (*Virg. Pfl.*, p. 166.; *Don's Mill.*, 2. p. 504.) is described as an unarmed shrub, with leaves glabrous, conduplicate, ovate-elliptic, sharply serrated, and with flowers in umbels; the drupe and the nut oblong. It is a native of Caucasus, on Mount Bechvarmak; but has not yet been introduced into Britain.

P. tomentosa Thunb. (*Fl. Jap.*, 503., and *Don's Mill.*, 2. p. 498.) has the branches unarmed, and the peduncles solitary. The leaves are ovate and serrated, villous above, and, as well as the petioles, tomentose beneath. The flowers are white, and the drupe the size of a pea. A shrub, from 6 ft. to 8 ft. in height, a native of Japan, not yet introduced.

P. chinensis Blum. (*Bigcl.*, p. 1104.; *Don's Mill.*, 2. p. 504.) Leaves oblong, acuminate, furnished with two glands at the base, and unequally serrulated. Flowers in umbellate fascicles. Fruit round, and of a yellowish red. A tree, a native of China, not yet introduced.

Other Species. The genus *Prunus* L. formerly included one or two species now united with *Armeniaca* Tourn., and a number which have been separated from it, and formed into the genus *Cerasus* Juss. In consequence of this, there appears to us considerable confusion among the species of these three genera; and we think it likely, that, when the fruit of all the sorts has been seen, some of them will be restored to *Prunus*. Among these, we think, will be *Cerasus nigra* Lois., which, in the flowers, leaves, colour of the wood, and general habit of the plant, as shown in the plants bearing this name in the Hammersmith Nursery, has every appearance of being a variety of the common plum; or of that form of it known as *Prunus maritima*, which, with some others enumerated above, we cannot bring

ourselves to consider as distinct species. Numerous as are the cultivated fruit-bearing varieties of the common plum, it is clear that they might be increased *ad infinitum*; and it is also highly probable, that numerous varieties, with fruits totally different from those of the original species, might be procured by cultivating the North American species, *P. maritima* and *P. pubescens*; if, indeed, these are anything more than varieties of *P. domestica*. There are two forms, which every description of tree seems capable of sporting into, which are yet wanting in the genus *Prunus*, as at present limited; the one is with branches pendent, and the other with branches erect and fastigate. There can be no doubt but that an endless number of hybrids, varying in their leaves, blossoms, and fruit, might be produced by fecundating the blossoms of the plum with the pollen of the almond, the peach, the apricot, and the cherry; and, though some may be disposed to assign little value to these kinds of productions, yet it must not be forgotten that almost all the cultivated plants of most value to man have been produced by some kind of artificial process. Experiments of this kind, therefore, ought never to be discouraged. What culture has done we know; but what it may yet accomplish is concealed in the womb of time.

GENUS V.



CÉRASUS Juss. THE CHERRY. *Lin. Syst.* Icosándria Monogýnia.

Identification. Juss. Gen., 340; Dec. Fl. Fr., 4. p. 479.; Prod., 2. p. 535.; Don's Mill., 2. p. 504.

Synonymes. Cérusus and Laurocérusus *Tourn.*; *Prunus* sp. *Lin.*; *Cerisier*, *Fr.*; *Kirsche*, *Ger.*

Derivation. From *Cerasus*, the ancient name of a town of Pontus in Asia, whence the cultivated cherry was first brought to Rome, by Lucullus, a Roman General, 68 B. C.

Description, &c. Trees and shrubs, almost all deciduous, with smooth serrated leaves, and white flowers; and, generally, with light-coloured bark; natives of Europe, Asia, and North America. Some of them are cultivated for their fruit, and the others as ornamental. In British nurseries, they are generally propagated by grafting or budding on the *Cérusus sylvéstris*: they will grow in any common soil that is tolerably dry; and the price in European and American nurseries is, with a few exceptions, the same as that of common fruit trees. There is much confusion in all the species, more particularly as regards those which are natives of North America; and which, as Dr. Hooker judiciously observes, can only be "removed by carefully studying the plants in a living state, both during the season of the blossom and that of the fruit." (*Fl. Bor. Amer.*, i. p. 167.)

§ i. *Cerasóphora* Dec. *The Cherry-bearing Kinds.*

Sect. Char. Flowers produced from buds upon shoots not of the same year; and, in many instances, disposed umbellately. Leaves deciduous.

A. *Species cultivated for their Fruit.*

The Cherries cultivated in Gardens, according to Linnæus (*L. Pat.* in *Sp. Pl.*, and *L. Fil.* in *Mant.*) and almost all botanists to the time of De Candolle, have been referred to *Prunus àvium* L. and *Prunus Cérusus* L. (both, in our opinion, only varied forms of one species); the former being the mérisier of the French, and corresponding with the small wild black bitter cherry of the English (the *C. sylvéstris* of Ray); and the latter the cerisier of the French, and corresponding with the common red sour cherry of the English (the *C. vulgàris* of Miller). To these two species De Candolle, in the *Flore Française*, has added two others: *Cérusus Juliàna*, which he considers as including the guigniers; and *Cérusus durácina*, under which he includes the bigarreaus, or hard cherries. Under each of these four species, Seringe, in De Candolle's *Prodromus*, has arranged a number of varieties, with definitions to each group; but, as neither the species nor the groups appear to us distinct, we have adopted the arrangement of the author of the article on *Cérusus* in the *Nouveau Du Hamel*, as much more simple and satisfactory; and have referred all the cultivated varieties to the same species as Linnæus; substituting for *Prunus àvium* L., *Cérusus sylvéstris*, the synonym of Ray; and for *Prunus Cérusus* L., *Cérusus vulgàris*, already used to designate the same species in *Mill. Dict.*, and

by Loiseleur in the *Nouveau Du Hamel*. We shall slightly notice the groups included in the *Nouveau Du Hamel*, under each species; we shall afterwards give a list kindly furnished to us by Mr. Thompson of the London Horticultural Society's Garden, of the kinds of both species which he thinks most deserving of culture as ornamental trees; and our description, history, &c., will comprehend both species, and the races and varieties belonging to them. The arrangement of the varieties, and general culture of the cherry in the kitchen-garden and orchard, will be found at length in our *Encyclopædia of Gardening*; and, in a more condensed form, in our *Suburban Gardener*.

‡ I. C. SYLVESTRIS *Bauh.* and *Ray*. The wild black-fruited Cherry Tree.

Identification. Bauh. Hist., l. 1. 2. p. 220.; Ray Hist., 1539.; Pers. Syn. 2. p. 35.
Synonymes and Garden Names. C. avium *Mench Meth.*, 672., *Dec. Fl. Fr.*, No. 3786., *Dec. Prod.*, 2. p. 535., *Lois.* in *N. Du Ham.*, 5. p. 10., *Don's Mill.*, 2. p. 505.; C. nigra *Mill. Dict.*, No. 2., not of *Ait.*, *Ger. Em.*, 1505.; *Prunus avium Lin. Sp.*, 680.; P. avium var. α and β . *Willd. Baum.*, ed. 2. p. 308.; P. nigricans, and P. varia *Ehr. Beitr.*, 7. p. 126, 127.; Gean, Bigarreau, Corone, Coroon, Small Black, Black Hertfordshire, Black Heart, Black Mazzard, the Merry Tree of the Cheshire peasants, the Merries in Suffolk; Mérisier, Merise grosse noire, Guignier, Bigarreaulier, Heaumier, Fr.; Süsser Kirsche, Ger.

Derivation. This cherry is called Corone, or Coroon, in some parts of England, from *corone*, a crow, in reference to its blackness. Merry Tree and Merries are evidently corruptions of the word Mérisier; and Mérisier is said to be derived from the words *amer*, bitter, and *ceris*, cherry. Bigarreau is derived from *bigarrée* party-coloured, because the cherries known by this name are generally of two colours, yellow and red; and Heaumier is from the French word *heaume*, a helmet, from the shape of the fruit.

Spec. Char., &c. Branches vigorous and divaricate; the buds from which the fruits are produced, oblong-acute. Flowers in umbel-like groups, sessile, not numerous. Leaves oval-lanceolate, pointed, serrated, somewhat pendent, slightly pubescent on the under side, and furnished with two glands at the base. (*Dec. Prod.*, and *Nouveau Du Hamel*.) The colour of the fruit is a very deep dark red, or black; the flesh is of the same colour, small in quantity, austere and bitter before it comes to maturity, and insipid when the fruit is perfectly ripe. The nut is oval or ovate, like the fruit, firmly adhering to the flesh, and very large in proportion to the size of the fruit. The juice is mostly coloured; and the skin does not separate from the flesh. A tree, a native of Europe, found in woods and hedges; very dwarf in unfavourable soils and climates, but growing to the height of 40 ft. or 50 ft., or upwards, in dry fertile soils. The flowers are produced in April, and the fruit ripens in June or July. Under this species are included, in the *Nouveau Du Hamel*, the following races or groups:—

1. *Mérisiers*, or *Merries*, with black or yellow fruit.
2. *Guigniers*, or *Geans* (*C. Juliàna Dec.*), with red or black fruit, early or late, and including the tobacco-leaved guignier, or gean, of 4 to the pound (the *C. decumàna* of Delauney).
3. *Heaumiers*, the *Helmet-shaped Cherries*, (*C. Juliàna var. heaumiana Dec.*) somewhat resembling the bigarreau, but with less firm flesh.

Variety of this race used for ornamental purposes.

‡ *C. s. duràcina* 2 *flòre plèno Hort.*, the double-flowered wild black Cherry; Mérisier à Fleurs doubles, or Mérisier Renunculier, Fr.; is a very beautiful variety, known in the garden of the London Horticultural Society, as the double French white. The tree there, in 1835, was upwards of 20 ft. high, after having been 10 years planted.

4. *Bigarreauliers*, the *Bigarreau*, or *hard-fleshed Cherries*, (*C. duràcina Dec.*) with white, flesh-coloured, and black fruit, generally heart-shaped.

‡ 2. C. VULGARIS *Mill.* The common Cherry Tree.

Identification. Mill. Diet., No. 1.; N. Du Ham., 5. p. 18.
Synonymes and Garden Names. Prunus Cerasus *Lin. Sp.*, 679.; C. hortensis *Pers. Syn.* 2. p. 34.; C. caproniana *Dec. Fl. Fr.*, 4. p. 482., *Dec. Prod.*, 2. p. 536., *Don's Mill.*, 2. p. 507.; P. austera and P. ácida *Ehrh. Beitr.*, 7. p. 129. and 130.; Cherry, Kentish or Flemish Cherry, Morello, May Duke; Cerise de Montmorency, Cerise de Paris, Cerise à Fruits ronds, Cerisier du Nord, Cerisier, and Griottier in some provinces, Fr.; saure Kirsche, Ger.

Derivation. Caproniana is said to be derived from capron, the hautbois strawberry, probably from this cherry possessing so much more flavour than C. sylvestris. Morello is either from *morel* (*Morchella esculenta*), the flesh being of the same consistency as the flesh of that fungus; or, perhaps, from the French word *morelle*, a female negro. May Duke is a corruption of *Médoc*, the province

of France where the variety is supposed to have been originated. Griottier is said to be derived from *aigreur*, sourness, or sharpness, and applied to this cherry from the acidity of its fruit.

Spec. Char., &c. Tree small, branches spreading. Flowers in subsessile umbels, not numerous. Leaves oval-lanceolate, toothed, glabrous. The flowers are smaller than those of *C. sylvestris*. The fruit is round, melting, full of a watery sap, more or less flavoured, and almost always sensibly acid. The skin of the fruit is commonly red, but, in the numerous varieties in cultivation, passing into all the shades between that colour and dark purple or black. The skin of all the varieties of *C. vulgaris* separates easily from the flesh, and the flesh parts readily from the stone; while, in all the varieties of *C. sylvestris*, the skin is more or less adhering to the flesh, and the flesh to the stone. (*Nouveau Du Hamel*, v. p. 18.) This species forms a tree of less magnitude than that of *C. sylvestris*: it is never found in a truly wild state in Europe, and the aboriginal form is unknown. There are numerous cultivated varieties, which are classed by Loiseleur, in the *Nouveau Du Hamel*, in three groups, including in the first of these the four following varieties, which we particularise on account of their being purely ornamental.

Varieties.

‡ *C. v. 2 flore semipleno* Hort. *The semidouble common Cherry.*

‡ *C. v. 3 flore pleno* Hort. *The double-flowered common Cherry.*—All the stamens of this variety are changed into petals; and the pistillum into small green leaves, which occupy the centre of the flower. The flower is smaller and less beautiful than that of the double mérisier; but, as the tree does not grow so high, and as it can be grown as a shrub, it is suitable for planting in situations where the other cannot be introduced. It is commonly grafted on the *Prunus Mahaleb*. The flower is interesting in a physiological point of view, on account of its central green leaves illustrating Goethe's doctrine of vegetable metamorphoses. (See *Lindl. Introd. to Bot.*, p. 143.)

‡ *C. v. 4 persiciflora* Hort. *The Peach-blossomed common Cherry.*—The flowers are double, and rose-coloured. This variety was known to Bauhin and to Tournefort, but is at present rare in gardens. We have not seen it.

‡ *C. v. 5 foliis variegatis* Hort. *The variegated-leaved common Cherry.*

The fruit-bearing varieties are arranged in the Nouveau Du Hamel, under the following heads:—

1. Flesh whitish, and more or less acid; including the Montmorency cherry.
2. Flesh whitish, and only very slightly acid; including the English duke cherries.
3. Flesh red, including the griottiers, or morellos.

The following selection has been made by Mr. Thompson, with a view of exemplifying the different forms which the varieties of the cultivated cherries assume, as standard trees:—

The Bigarreau is a tree of vigorous growth, with large pale green leaves, and stout divergent branches.

Buttner's Yellow is a vigorous-growing tree, like the preceding, but with golden-coloured fruit.

The Kentish Cherry is a round-headed tree, with slender shoots, somewhat pendulous.

The May Duke is a middle-sized or low tree, with an erect fastigiate head.

The Morello is a low tree, with a spreading head, somewhat pendulous; most prolific in flowers and fruit; the latter ripening very late, and, from not being so greedily eaten by the birds as most other sorts, hanging on the trees a long time.

D'Ostheim is a dwarf weeping tree, a great bearer.

General Description. The cherry trees in cultivation, whether in woods or gardens, may, in point of general appearance, be included in three forms: large trees with stout branches, and shoots proceeding from the main stem

horizontally, or slightly inclining upwards, and, when young and without their leaves, bearing a distant resemblance to gigantic candelabras, such as the geans, and many of the heart cherries; fastigate trees of a smaller size, such as the dukes; and small trees with weak wood, and branches divergent and drooping, such as the Kentish or Flemish cherries, and the morellos. The leaves vary so much in the cultivated varieties, that it is impossible to characterise the sorts by them; but, in general, those of the large trees are largest, and the lightest in colour, and those of the slender-branched trees the smallest, and the darkest in colour; the flowers are also largest on the large trees. The fruits of all the sorts, with the exception of the Kentish and the morello cherries, are eagerly devoured by birds, from the stones dropped by which in the woods, all the varieties considered as wild have, probably, arisen. The distinction of two species, or races, is of very little use, with reference to cherries as fruit-bearing plants; but, as the wild sort is very distinct, when found in its native habitats, from the cherry cultivated in gardens, it seems worth while to keep them apart, with a view to arboriculture and ornamental planting. For this reason, also, we have kept *Cerasus semperflorans*, *C. Pseudo-Cerasus*, *C. serrulata*, *C. persicifolia*, and *C. Chamæcerasus* apart, though we are convinced that they are nothing more than varieties of the same species as the fruit-bearing cherries. The wild cherry is much more common, as a timber tree, in Scotland, and in France and Germany, than it is in England. In Scotland and France, there are two sorts planted for their timber, the red-fruited and the black-fruited; and it has been observed, that the red-fruited variety has larger leaves, which are paler, and more deeply serrated than the black-fruited variety, and that it grows more rapidly and vigorously. Cook mentions that he measured a wild cherry tree in Cashiobury Wood, that was 85 ft. 5 in. high (*Forest Trees*, &c., 3d. edit., 1724, p. 92.); and the Rev. Dr. Walker describes one at the Holm, in Galloway, as being 50 ft. high, in 1763. In consequence of its rapid growth, the red-fruited variety ought to be preferred where the object is timber, or where stocks are to be grown for fruit trees of large size. As a coppice-wood tree, the stools push freely and rapidly; and, as a timber tree, it will attain its full size, in ordinary situations, in 50 years; after which it should be cut down. Its rate of growth, in the first 10 years, will average, in ordinary circumstances, 18 in. a year.

Geography. The cherry, in a wild state, is indigenous in France and central Europe, including Italy, Spain, Portugal, Turkey, Greece, and the Mediterranean islands. It is also found in Russia, as far north as 55° or 56° N. lat.; and it ripens fruit in Norway and East Bothnia, as far as 63° N. lat., though it is not indigenous. It is found in the north of Africa, and in the north and east of Asia. In England, it is met with in woods and hedges. It grows on mountains to the height of 1600 ft. in the north of England; and a dwarf variety abounds at Barandam, in the neighbourhood of Sleaford, in Lincolnshire. It is found apparently wild in Scotland and Ireland; and there is a dwarf variety indigenous to Ross-shire.

History. All the ancient authors who speak of the cherry agree in assigning to that tree an Asiatic origin. Pliny states that it did not exist in Italy till after the victory which Lucullus obtained over Mithridates, King of Pontus, 68 B. C. Some modern authors, however, have doubted this, and among these are Ray, Linnæus, and the Abbé Rosier. According to Rosier, Lucullus brought into Italy only two superior varieties of cherry; the species which were the origin of all those now in cultivation being, before his time, indigenous to Italy, and to the forests of France, though their fruit was neglected by the Romans. Loiseleur, in the *Nouveau Du Hamel*, combats this opinion; stating that, though the wild cherry is undoubtedly indigenous to France, yet that it does not appear to have been so to Italy; and that even in France, only the *C. sylvestris*, or *mérisier*, is found in the forests; while the *C. vulgaris*, or *cerisier*, is never found in an apparently wild state in any country in Europe, except near human habitations. From this Loiseleur

concludes that, though the *mérisier* existed in France, it had probably never attracted the notice of the cultivated Romans, as, even if they had discovered the tree, they would have set little value on its bitter, austere, and nearly juiceless fruit; and that, when Lucullus brought either *C. vulgàris*, or some improved variety of it, from the country near Cerasus, they considered the fruit as new. At all events, it does not appear to have been cultivated before the time of Lucullus, though afterwards it made such rapid progress, that Pliny, in his *Natural History*, tells us, "In 26 years after Lucullus planted the cherry tree in Italy, other lands had cherries, even as far as Britain, beyond the ocean." It is curious, that, in Pliny's enumeration of the sorts of cherry cultivated in his time (A. D. 70), he mentions *C. durácina*, and *C. Juliàna*, both varieties of *C. sylvéstris*. The former, he says, are much esteemed; and "the Julian cherries have a pleasant taste, but are so tender, that they must be eaten where they are gathered, as they will not endure carriage." Pliny enumerates six other kinds, among which was one with quite black fruit, which was called *Aetia*; and another with very red fruit, which was called *Apronia*. As Pliny wrote above 100 years after the time of Lucullus, it is impossible now to ascertain whether all the cherries he mentions were introduced by that general, or originated by culture in Italy, &c. At all events, the tree appears to have rapidly become a universal favourite, and to have spread throughout all the Roman dominions. At present, it is extensively cultivated, as a fruit tree, throughout the temperate regions of the globe; but it does not thrive in tropical climates, and even attains a larger size in the middle and north of Europe than it does in the south.

In Britain, the testimony of most authors confirms the statement of Pliny, that the tree, or, at least, the cultivated cherry, was introduced by the Romans; and tradition says that the first cherry orchards were planted in Kent; a circumstance which seems confirmed by the celebrity which has been long maintained by that county for its cherries. Some writers assert that the cherries introduced by the Romans were lost during the period that the country was under the dominion of the Saxons, till they were reintroduced by Richard Harris, gardener to Henry VIII., who brought them from Flanders, and planted them at Sittingbourne, in Kent. The incorrectness of this story is, however, proved by the fact that Lydgate, who wrote in 1415 (during the reign of Henry V.), speaks of cherries being exposed for sale in the London market. Gerard, in his *Herbal*, published in 1597, figures a double and semidouble variety of cherry; and, of the fruit-bearing kinds, says that there were numerous varieties. Among others, he particularly mentions the black wild cherry, the fruit of which was unwholesome, and had "an harsh and unpleasant taste;" and "the Flanders, or Kentish, cherries," of which he says, that, when they are thoroughly ripe, they "have a better juice, but watery, cold, and moist." Gerard also speaks of the morello, or morel, which he calls a French cherry. In the survey and valuation, made in 1649, of the manor and mansion belonging to Henrietta Maria, Queen of Charles I., at Wimbledon, in Surrey, previously to its sale during the Commonwealth, it appears that there were upwards of 200 cherry trees in the gardens. (*Archæologia*, vol. x. p. 399.) From this period to the present day, cherries have been in great request, both as shrubbery and orchard trees.

In France, the cherry is highly prized, as supplying food to the poor; and a law was passed, so long ago as 1669, commanding the preservation of all cherry trees in the royal forests. The consequence of this was, that the forests became so full of fruit trees, that there was no longer room for the underwood; when, as usual, going to the other extreme, all the fruit trees were cut down, except such young ones as were included among the number of standard saplings required by the law to be left to secure a supply of timber. This measure, Bose remarks, was a great calamity for the poor, who, during several months of the year, lived, either directly or indirectly, on the produce of the *mérisier*. Soup made of the fruit, with a little bread, and a little butter, was the common nourishment of the woodcutters and the charcoal-burners

of the forest during the winter. At present, he says (writing in 1819), the fruit is wanting, and they have nothing to supply its place. The few cherries which they can gather from the remaining trees are eaten on the spot, or sold to make liqueurs.

Properties and Uses. The fruit of the cherry is a favourite with almost every body, and especially with children. The hard-fleshed kinds are considered rather indigestible when eaten in large quantities; but the soft-fleshed sorts, such as the morellos, are esteemed so wholesome as to be given in fevers, where there is a tendency to putridity. In France, the fruit, more especially of the soft-fleshed kinds, is dried by exposing it on boards to the sun, or in an oven moderately heated. It is also preserved in the same manner in Germany and in Russia. Ripe cherries are used for making cherry brandy; and preserves, marmalades, lozenges, and various other kinds of confectionery, are manufactured from them. An oil is drawn from the kernels, which is occasionally used for emulsions, and to mix in creams, sugar-plums, &c., to give the flavour of bitter almonds. The distillers of liqueurs make great use of ripe cherries: the spirit known as kirschewasser is distilled from them after fermentation; and both a wine and a vinegar are made by bruising the fruit and the kernels, and allowing the mass to undergo the vinous fermentation. The ratafia of Grenoble is a celebrated liqueur, which is made from a large black gean; from which, also, the best kirschewasser is made. Vinegar is also made from cherries.

Kirschewasser. The method of making this celebrated spirit is, to take bruised cherries, in which the greatest part of the kernels have also been broken, and to let them remain in a mass till the vinous fermentation is fairly established; after which the process of distillation is commenced, and continued as long as the liquor comes over clear; or till about a pint of liquor has been obtained from every 20 pints of fermented pulp. The kirschewasser comes from the still as clear as the purest water; and, in order that it may not receive any tinge which would lessen its value, it is always kept in stone vessels or bottles. More detailed methods of making it will be found in the *Gardener's Magazine*, vol. iv. p. 179.; and in the same work, vol. viii. p. 182. The best kirschewasser is made in Alsace in France, in Wirtemberg in Germany, and at Berne and Basle in Switzerland. Any cherry will produce it, but, as before observed, the wild black gean is greatly preferred.

Maraschino is also made from the cherry, much in the same manner as kirschewasser. The kind of cherry preferred for this purpose is a small acid fruit, called marasca, which abounds in the north of Italy, at Trieste, and in Dalmatia. That of Zara, in Dalmatia, is considered the best. All the fruit employed in making the Dalmatian maraschino is cultivated within 20 miles of this city, at the foot of the mountain Clyssa, between Spalatro and Almissa, on the side of a hill planted with vines. The chief difference between the preparation of this liqueur and kirschewasser consists in mixing the mass of bruised cherries with honey; and honey or fine sugar is added to the spirit after it is distilled. The genuine maraschino is as difficult to be met with as genuine Tokay; the greater part of that which is sold as such, being nothing more than kirschewasser mixed with water and honey, or water and sugar. The marasca cherry has been cultivated in France with a view to the manufacture of this liqueur in that country; and it has been said that it may be made just as good from the common wild black cherry. It is also said, that, in Dalmatia, the leaves of the tree are made use of in order to give the peculiar aroma which is so much esteemed in the maraschino; and that this perfume may be increased to any extent desired, by mixing the leaves of *Cérusus Mahaleb*, the perfumed cherry, with the fruit of the marasca, or even the common gean, before distillation.

Medicinally, the fruit of the cherry, more especially of the soft-fleshed varieties, is said to be cephalic and aperient. A water distilled from the fruit, without fermenting it, and which, consequently, contains no spirit, is employed as antispasmodic; and a ptisan from dried cherries boiled in water is very

useful in catarrhs. An infusion of the fruit in water is said to be very diuretic, and to have been applied with success in the dropsy.

The gum is said to have the same properties as gum Arabic, though it differs from it, in not dissolving readily in water. According to Hasselquist, a hundred men were kept alive during a siege, for nearly two months, without any other sustenance than a little of this gum taken occasionally into the mouth, and suffered to remain there till it was dissolved.

The bark of the cherry is composed of four layers, of which the outer three are formed of spiral fibres, in a transverse direction; while the fourth is composed of longitudinal fibres. The first and the second of these layers are hard and coriaceous; and the third and the fourth spongy. The two last are said to afford a fine yellow dye, and, in medicine, to serve as a substitute for the cinchona.

The leaves are said to be greedily eaten by animals of every description; and, as they contain hydrocyanic acid, they are used, like those of the peach, for flavouring liqueurs, custards, &c.

The wood of the wild cherry (*C. sylvéstris*) is firm, strong, close-grained, and of a reddish colour. It weighs, when green, 61 lb. 13 oz. per cubic foot; and when dry, 54 lb. 15 oz.; and it loses in the process of drying about a 16th part of its bulk. The wood is soft, easily worked, and it takes a fine polish. It is much sought after by cabinetmakers, turners, and musical instrument makers, more particularly in France, where mahogany is much less common than in Britain. In order to bring out its colour, and increase its depth of tone, it is steeped from 24 to 36 hours in lime-water, and polished immediately after being taken out. This process prevents the colour from fading when exposed to the action of the sun; and the wood, when so treated, may readily be mistaken for the commoner kinds of mahogany. In some parts of France, where the tree abounds in the forests, it is used for common carpentry purposes; and in others, casks for wine are made of it, which are said to improve the flavour of the wine kept in them. Where the tree is treated as coppice, it is found to throw up strong straight shoots, which, in a few years, make excellent hop-poles, props for vines, and hoops for casks. As fire-wood, like that of many other fruit trees, it will burn well as soon as it is cut down; but, if it is kept for two or three years, and then used as fuel, it will, when laid on the fire, consume away like tinder, without producing either flame or heat.

As a tree, the wild cherry is not only valuable for its timber, but for the food which it supplies to birds, by increasing the number of which, the insects which attack trees of every kind are materially kept under. This is one reason why cherry trees are generally encouraged in the forests of France and Belgium: an additional reason, in Britain, is the nourishment which they afford to singing birds, particularly to the blackbird and thrush. In all ornamental plantations, cherry trees are desirable on this account, and also on account of the great beauty of their blossoms, which are produced in the greatest profusion in most seasons. The morello and the Kentish cherries are desirable on account of the beauty of their fruit; which, being produced in immense quantities, and not being eaten by birds, remains on the tree till winter, and has an effect which is singularly rich and ornamental. On the Continent, and more especially in Germany and Switzerland, the cherry is much used as a road-side tree; particularly in the northern parts of Germany, where the apple and the pear will not thrive. In some countries, the road passes for many miles together through an avenue of cherry trees. In Moravia, the road from Brunn to Olmutz passes through such an avenue, extending upwards of sixty miles in length; and, in the autumn of 1828, as we have stated in the *Gardener's Magazine*, vol. iv., we travelled for several days through almost one continuous avenue of cherry trees, from Strasburg by a circuitous route to Munich. These avenues, in Germany, are planted by the desire of the respective governments, not only for shading the traveller, but in order that the poor pedestrian may obtain refreshment on his journey. All

persons are allowed to partake of the cherries, on condition of not injuring the trees; but the main crop of the cherries, when ripe, is gathered by the respective proprietors of the land on which it grows: and, when these are anxious to preserve the fruit of any particular tree, it is, as it were, tabooed; that is, a wisp of straw is tied in a conspicuous part to one of the branches, as vines by the road sides in France, when the grapes are ripe, are protected by sprinkling a plant here and there with a mixture of lime and water, which marks the leaves with conspicuous white blotches. Every one who has travelled on the Continent, in the fruit season, must have observed the respect that is paid to these appropriating marks; and there is something highly gratifying in this, and in the humane feeling displayed by the princes of the different countries, in causing the trees to be planted. It would indeed be lamentable, if kind treatment did not produce a corresponding return.

The double-flowered varieties are splendid garden ornaments; more particularly the double French, which appears to grow to a timber size, and produces blossoms almost as large as roses. The pendulous shoots and blossoms of the common double cherry are also eminently beautiful; and no lawn ought to be without a tree of each sort. They are admirable trees for grouping with the almond, the double-blossomed peach, the Chinese and other crab trees, and the scarlet hawthorn.

The pendulous-branched Cherries (of which there is one variety, Allcard's morello, that attains a considerable size, and bears excellent fruit, which, from its agreeable acidity, makes a most delicious jam), exclusive of *C. semperflorens* and *C. Chamæcerasus*, which are pendulous when grafted standard high, are most ornamental trees, planted singly.

Poetical and legendary Allusions. The cherry has always been a favourite tree with poets; the brilliant red of the fruit, the whiteness and profusion of the blossoms, and the vigorous growth of the tree, affording abundant similes: but the instances where they occur are too numerous, and too well known, to be suitable for quotation. In Cambridgeshire, at Ely, when the cherries are ripe, numbers of people repair, on what they call Cherry Sunday, to the cherry orchards in the neighbourhood; where, on the payment of 6*d.* each, they are allowed to eat as many cherries as they choose. A similar fête is held at Montmorency. A festival is also celebrated annually at Hamburg, called the Feast of the Cherries, during which troops of children parade the street with green boughs, ornamented with cherries. The original of this fête is said to be as follows:—In 1432, when the city of Hamburg was besieged by the Hussites, one of the citizens named Wolf proposed that all the children in the city, between seven and fourteen years of age, should be clad in mourning, and sent as suppliants to the enemy. Procopius Nasus, chief of the Hussites, was so much moved by this spectacle, that he not only promised to spare the city, but regaled the young suppliants with cherries and other fruits; and the children returned crowned with leaves, shouting “Victory!”, and holding boughs laden with cherries in their hands.

Soil and Situation. The cherry will grow in any soil not too wet, or not entirely a strong clay. It will thrive better than most others in dry, calcareous, and sandy soils; attaining, even on chalk, with a thin layer of soil over it, a very large size. In the District of Marne, in France, the road-side trees are generally cherries; many of which have trunks from 2 ft. to 3 ft. in diameter at a foot from the ground. Du Hamel found cherry trees succeed on poor sandy soils, where other trees had altogether failed. Dr. Walker mentions that the cherry tree always decays whenever its roots extend to water. The cherry tree will grow on mountains and other elevations, as may readily be supposed from its flourishing in high northern latitudes; but it does not attain a timber-like size, except in plains, or on low hills. It stands less in need of shelter than any other fruit-bearing tree whatever, and may often be employed on the margins of orchards, and for surrounding kitchen-gardens, to form a screen against high winds. Dr. Withering observes that

it thrives best when unmixed with other trees; that it bears pruning, and suffers the grass to grow under it. (*Bot. Arrangem.*, vol. ii. p. 456.)

Propagation and Culture. The common wild cherry (*C. sylvéstris*), when grown for stocks for grafting on, or for planting out with a view to the production of timber, is almost always raised from seed; but, as the roots throw up suckers in great abundance, these suckers might be used as plants; or cuttings of the roots might be employed for the same purpose; or stools might be formed, and treated like those of the plum. (See p. 690.) When plants are to be raised from seed, the cherries should be gathered when ripe, and either sown immediately with the flesh on, incurring the risk of their being eaten by birds or vermin, especially mice, during the autumn and winter; or, what is preferable, they may be mixed with four times their bulk of sand, and kept in a shed or cellar, being turned over frequently, till the January or February following. They may then be sown in beds, and covered with about half an inch or an inch of light mould. Great care must be taken that the seeds do not sprout while in the heap; because, unlike the horsechestnut, the acorn, and some other fruits, the cherry expands its cotyledons at the same time that it protrudes its radicle; and when both are developed before sowing, the probability is, that the germinated seeds will not live; because the cotyledons, in sowing, are unavoidably covered with soil, whereas nature intended them to be exposed to the light. The strongest plants, at the end of the first season, will be 18 in. or more in height, and may be drawn out from among the others, and transplanted into nursery lines; and, after they have stood there a year, they may be grafted or budded.

Pruning the Cherry Tree, whether in a young or old state, ought always to be performed in the month of August or beginning of September, and at no other season; because it has been found by experience, more especially by Mr. Sang, who appears to have been the first to record the fact, that, when pruned in the summer season, the trees are not liable to gum. When pruned in the winter season, or when a large branch is cut off any tree, or when the bark is injured, a flow of gum is almost the certain consequence, and this is almost as certainly the commencement of the decay of the tree.

Accidents and Diseases. The cherry is not particularly liable to have its branches broken by high winds or snow storms; but, as a fruit tree, its branches are frequently broken by carelessness in those who gather the fruit. The principal disease is the flowing of the gum, which, when once it has commenced, whether naturally, or from an accidental wound, generally continues till the tree dies: this it does by degrees, one branch or limb at a time, its decay being more or less rapid, according to the vigour of the tree. The thrush and the blackbird, it is well known, feed on cherries; and the woodpecker (*Picus viridis L.*) is said to be particularly fond of picking holes in the cherry tree, in search of the larvæ of insects. These holes, by admitting water, accelerate the decay of the heart-wood of the tree; but it is a mistake to suppose, as many do, that the decay originates with the woodpecker, who gets the credit of making the holes out of sheer mischief, or for amusement; the truth being, that decay has commenced, and that he is only in search of his food, which consists of the larvæ which have already begun to eat the wood of the tree.

Statistics. The largest specimen of *Cerasus sylvéstris* that we have heard of in the neighbourhood of London is in Surrey, at Claremont, where it is 60 ft. high. In Gloucestershire, on the northern extremity of the Cotswold Hills, on an estate of the Earl of Harrowby, 85 ft. high, and the trunk upwards of 3 ft. in diameter. In Suffolk, at Withermarsh Green, "the great cherry tree" is 46 ft. high; the girth of the trunk, at 12 ft. from the ground, is 9 ft.; and the diameter of the head, from north to south, is 74 ft., and from east to west, 62 ft. In Scotland, at Hopeton House, 70 ft., the diameter of the trunk 3 ft. 6 in., and of the head 40 ft., in black sand on gravel. In Shropshire, at Airthry Castle, 45 ft. high; the diameter of the trunk 2 ft., and of the head 56 ft.; at Sauchie, 59 ft. high; at West Plean, 30 ft. high; and in Bannockburn Wood, 40 ft. high. In Clackmannanshire, at the Dollar Institution, 12 years planted, it is 22 ft. high. In Perthshire, at Taymouth, 22 years planted, it is 35 ft. high. — *C. sylvéstris* flore pleno, in Radnorshire, at Maeslaugh Castle, is 25 ft. high, with a trunk 15 in. in diameter, and a head the diameter of which is 33 ft. In Staffordshire, at Teddesley Park, this variety, 14 years planted, is 17 ft. high. In Scotland, in Angusshire, at Kinnaird Castle, a double-flowering cherry, 120 years old, is 20 ft. high; the diameter of the trunk is 16 in., and of the head 30 ft.

Commercial Statistics. Seedlings for stocks, fit for transplanting, are 5s. per 100; and grafted and budded plants, dwarfs, from 1s. to 1s. 6d. each; and standards from 2s. to 2s. 6d. each. The French white is 2s. 6d. for dwarfs, and 5s. for standards. At Bollwyller, the double-flowered varieties are 80 cents each, and the fruit trees from 50 cents to 2 francs each.

B. *Species cultivated as ornamental or curious Trees or Shrubs.*

‡ 3. *C. (v.) SEMPERFLO`RENS Dec.* The ever-flowering Cherry Tree.

Identification. Dec. Fl. Fr., 4. p. 481., and Prod., 2. p. 557.; Don's Mill., 2. p. 13.

Synonymes. Prunus semperflorens Ehrh. Beitr., 7. p. 132.; P. serotina Roth Catal., 1. p. 58; the weeping Cherry, the Allsaints Cherry; Cerise de la Toussaint, Cerise de St. Martin, Cerise tardive, Fr.

Engravings. N. Du Ham., p. 30. No. 18. t. 5. f. A; and the plate in our Second Volume.

Spec. Char., &c. Branches drooping. Leaves ovate, serrated. Flowers protruded late in the season, axillary, solitary. Calyx serrated. Fruit globose and red. Its native country not known. (*Dec. Prod.*, ii. p. 537.) An ornamental tree, usually grafted standard high on the common wild cherry, or gean; growing rapidly for 8 or 10 years, and forming a round head, 8 ft. or 10 ft. high, and 10 ft. or 12 ft. in diameter, with the extremities of the branches drooping to the ground; and flowering and fruiting almost the whole summer. It forms a truly desirable small single tree for a lawn. A specimen in the Jardin des Plantes at Paris, 50 years planted, is 27 ft. high.

‡ 4. *C. SERRULA`TA G. Don.* The serrulated-leaved Cherry Tree.

Identification. Hort. Brit., p. 480.; Don's Mill., 2. p. 514.

Synonymes. Prunus serrulata Lindl. Hort. Trans., 7. p. 238.; the double Chinese Cherry; Yung To, Chinese.

Engravings. Our fig. 406.

Spec. Char. &c. Leaves obovate, acuminate, setaceously serrulated, quite glabrous. Petioles glandular. Flowers in fascicles. (*Don's Mill.*, ii. p. 514.) The flowers are white, slightly tinged with red, and double, though not so much so as the double French. (p. 693.) The tree is a native of China, much resembling the common cherry tree, but not of such vigorous growth; and only the double-flowered variety of it has been yet introduced. It was brought to England in 1822, and is singularly ornamental, flowering in April. There are several trees of it in the London Horticultural Society's Garden, from 6 ft. to 10 ft. high; but it will probably grow much higher.



406

‡ 5. *C. PSEUDO-CÉRASUS Lindl.* The False Cherry Tree.

Identification. Hort. Brit., No. 12663.; Don's Mill., 2. p. 514.

Synonymes. Prunus Pseudo-Cerasus Lindl. Hort. Trans., 6. p. 90.; P. paniculata Ker Bot. Reg., 800., but not of Thunb.

Engravings. Bot. Reg., t. 800.; and our fig. 407.

Spec. Char., &c. Leaves obovate, acuminate, flat, serrated. Flowers racemose. Branches and peduncles pubescent. Fruit small, pale red, of a pleasant subacid flavour, with a small smooth stone. (*Don's Mill.*, ii. p. 514.) A low tree, a native of China, where it is called by the same name as *C. serrulata*. It was introduced in 1819, and grows to the height of 8 ft. or 10 ft. The flowers are produced before those of any of the other cherries, and generally about the end of March, or the beginning of April. The tree is readily known from the other cherry trees, even when without its leaves, by its rough gibbous



407

joints, at which it readily strikes root; and is, consequently, very easily propagated. It has been tried by Mr. Knight, as a fruit tree; and he finds that it forces in pots better than any other variety. In the year 1824, a plant in a pot, in the peach-house of the London Horticultural Society's Garden at Chiswick, produced a crop of fruit, which ripened within 50 days from the time the blossoms opened. Mr. Knight tried some experiments with this tree, in his hot-houses at Downton Castle; where he found that, in a hot moist climate, it put out very numerous roots from the bases of its young branches; and that it might be very readily propagated by cuttings of these branches. (See *Hort. Trans.*, vol. vii., or *Gard. Mag.*, vol. iii. p. 182.) The tree is a desirable one for small gardens, on account of its very early flowering; and should be grouped along with *Armeniaca sibirica*, which flowers a little before it, being the earliest of the apricots and plums.

✻ 6. *C. CHAMÆCERASUS* Lois. The Ground Cherry Tree, or Siberian Cherry.

Identification. Lois, in *N. Du Ham.*, 5. p. 29.; *Dec. Prod.*, 2. p. 537.; *Don's Mill.*, 2. p. 513.

Synonymes. *C. intermedia* Lois, in *N. Du Ham.*, 5. p. 30.; *Prunus intermedia* Poir. *Dict.*, 5. p. 674.; *P. fruticosa* Pall., according to *Besser*; *Cerasus pumila* C. *Baule*, according to *Pall. Fl. Ross.*; *Chamæcerasus fruticosa* *Pers. Syn.*, 2. p. 34.

Engravings. *N. Du Ham.*, 5. p. 29. t. 5. f. A; *Hayne Abbild.*, t. 61.; and our *fig.* 408.

Spec. Char., &c. Leaves ovate-oblong, glabrous, glossy, crenate, bluntish, rather coriaceous, scarcely glanded. Flowers in umbels, which are usually on peduncles, but short ones. Pedicels of the fruit longer than the leaves. Fruit round, reddish purple, very acid. (*Dec. Prod.*, ii. p. 537.) A shrub, growing to the height of 3 ft. or 4 ft., a native of Siberia and Germany, introduced in 1587, and producing its white flowers in May, and ripening its fruit in August. It forms a neat little narrow-leaved bush, which, when grafted standard high, becomes a small round-headed tree, with drooping branches, at once curious and ornamental. It does not grow above a fourth part of the size of *C. semperflorens*; and, like it, it flowers and fruits during great part of the summer.



✻ 7. *C. PROSTRATA* Ser. The prostrate Cherry Tree.

Identification. *Seringe* in *Dec. Prod.*, 2. p. 538.; *Don's Mill.*, 2. p. 514.

Synonymes. *Prunus prostrata* *Lab. Pl. Syr. Dec.*, 1. p. 15.; *Lois*, in *N. Du Ham.*, 5. p. 182.; *Amigdalus incana* *Pall. Fl. Ross.*, 1. p. 15., according to *Loiseleur*; *Prunus incana* *Steven* in *Mém. Soc. Mosq.*, 3. p. 263.

Engravings. *N. Du Ham.*, 5. t. 53. f. 2.; *Pall. Fl. Ross.*, 1. t. 7., according to *Loiseleur*; *Bot. Mag.*, t. 136.; and our *fig.* 409.

Spec. Char., &c. Decumbent. Leaves ovate, serrately cut, glandless, tomentose, and hoary beneath. Flowers mostly solitary, nearly sessile. Calyx tubular. Petals ovate, retuse, rose-coloured. Fruit ovate, red; flesh thin. (*Dec. Prod.*, ii. p. 538.) A prostrate shrub, a native of the mountains of Candia, of Mount Lebanon, and of Siberia. It was introduced in 1802, and produces its rose-coloured flowers in April and May. There are plants of it in Loddiges's arboretum.



✻ 8. *C. PERSICIFOLIA* Lois. The Peach-tree-leaved Cherry Tree.

Identification. *Lois*, in *N. Du Ham.*, 5. p. 9.; *Dec. Prod.*, 2. p. 537.; *Don's Mill.*, 2. p. 513.

Synonymes. *Prunus persicifolia* *Desf. Arb.*, 2. p. 205.

Spec. Char., &c. Leaves ovate-lanceolate, acuminate, unequally serrate, glabrous, with two glands upon the petiole. Flowers numerous, upon slender peduncles, and disposed umbellately. Presumed to be a native of America, as it was raised from seeds sent from that country by Michaux. (*Dec. Prod.*, ii, p. 537.) A rapidly growing tree, attaining the height of the common wild cherry, and bearing so close a resemblance to it in almost every respect, that it is probably only a variety of it. There are trees of this kind of cherry in the Jardin des Plantes at Paris, of a pyramidal form, with a reddish brown smooth bark, flowers about the size of those of *C. Mahaleb*, and fruit about the size of peas. The wood is said to be harder and redder than that of the common wild cherry. According to Sweet, it was introduced into England in 1818; but we have never seen it.

‡ 9. *C. BOREALIS* Michx. The North American Cherry Tree.

Identification. Michx. Fl. Bor. Amer., 1. p. 286; Lois. in N. Du Ham., 5. p. 32. No. 22.; Dec. Prod. 2. p. 538.; Don's Mill., 2. p. 513.

Synonyms. *Prunus borealis* Poir. Dict., 5. p. 674.; the Northern Choke Cherry, Amer. Engravings. Michx. Arb. Amer., 3. t. 8.; and our fig. 410.

Spec. Char., &c. Leaves oval-oblong, acuminate, membranaceous, glabrous, denticulate and almost in an eroded manner: they resemble those of the common almond tree, but have the serratures inflexed, protuberant, and tipped with minute glandulous mucros. Flowers on longish pedicels, and disposed nearly in a corymbose manner. Fruit nearly ovate, small; its flesh red. (*Dec. Prod.*, ii. p. 538.) A small tree, growing to the height of 20 ft. or 30 ft., with a trunk 6 in. or 8 in. in diameter; a native of the northern parts of North America; and introduced into England in 1822. According to Michaux, it is not found in the southern states; but was principally observed by him in the district of Maine and the state of Vermont, where it is called the small cherry, and the red cherry. It flowers in May, and ripens its fruit in July. Michaux states that this cherry is remarkable for springing up spontaneously in all places which have been anciently cultivated, and even on those parts of forests which have been burned, either extensively by accident, or merely where a fire has been lighted by a passing stranger. In this respect, he says that it resembles the paper birch, which has the same peculiarity. Of all the cherries of North America, he observes, the *C. borealis* is the one that has the greatest analogy with the cultivated cherry of Europe; and hence he considers it the best American stock for the European cherry. Pursh describes it as a very handsome small tree, the wood exquisitely hard and fine-grained; but the cherries, though agreeable to the taste, astringent in the mouth, and hence called choke cherries. From the appearance of the trees in Messrs. Loddiges's arboretum, we should conclude it to be only a variety of *C. sylvestris*.

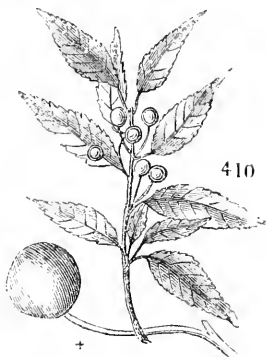

* 10. *C. PUMILA* Michx. The dwarf Cherry Tree.

Identification. Michx. Fl. Bor. Amer., 2. p. 286.; Lois. in N. Du Ham., 5. p. 31.; Dec. Prod., 2. p. 537.; Don's Mill., 2. p. 513.

Synonyms. *Prunus pumila* Lin. Mant., 73.; Pursh Fl. Amer. Sept., 1. p. 231.; *Cérasmus glauca* Mœnch Meth., 672.; Ragouminier, or Nega, or Menel du Canada, Fr.

Engraving. Mill. Icon., t. 80. f. 2.

Spec. Char., &c. Branches twiggly. Leaves obovate-oblong, upright, glabrous, indistinctly serrulated, glaucous beneath. Flowers upon peduncles, disposed rather umbellately. Calyx bell-shaped, short. Fruit ovate, black. (*Dec. Prod.*, ii. p. 537.) A low somewhat procumbent shrub, a native of North America, in Pennsylvania and Virginia, in low grounds and swamps. Introduced in 1756. It grows to the height of 3 ft. or 4 ft., and produces its flowers in May, which are succeeded by red and very acid fruit. It forms a curious and rather handsome tree, when grafted standard high, and is a fit companion for the other dwarf sorts, when so grafted. Sir W. J. Hooker suspects this to be the same as *C. depréssa*. It has been compared, Sir W. J. Hooker observes, in its general habit, to *Amýgdalus nana*; and such a comparison is equally applicable to *C. depréssa*. (*Fl. Bor. Amer.*, i. p. 167.)

★ 11. *C. DEPRESSA* Ph. The depressed, or prostrate, Cherry Tree.

Identification. Pursh Fl. Amer. Sept., 1. p. 332.; Dec. Prod., 2. p. 538.; Hook. Fl. Bor. Amer., 1. p. 168.; Don's Mill., 2. p. 514.

Synonymes. *C. pumila*, Michx. Fl. Bor. Amer., 1. p. 286., not *Prunus pumila* L.; *P. Susquehæna*, Willd. Enum., 519., Baumz., ed. 2. p. 286.

Spec. Char., &c. Branches angled, depressed, prostrate. Leaves cuneate-lanceolate, sparingly serrate, glabrous, glaucous beneath. Flowers in grouped sessile umbels, few in an umbel. Fruit ovate. (*Dec. Prod.*, ii. p. 538.) A prostrate shrub, a native of North America, from Canada to Virginia, on the sandy shores of rivers and lakes. It spreads its branches very much, and does not rise above 1 ft. from the ground. The fruit is black, small, and agreeably tasted; and, in America, is called the sand cherry. Introduced into Britain in 1805, and distinguished at sight from all the other species, not less by its prostrate habit, than by its glaucous leaves, which bear some resemblance in shape to those of *Amygdalus nana*; and, according to Sir W. J. Hooker, to those of *C. pumila*; with whom, judging from the plants under these names in the London gardens, we agree in thinking the species identical, notwithstanding the different descriptions given to the two kinds by botanists.

★ 12. *C. PYGMÆA* Lois. The pygmy Cherry Tree.

Identification. Lois. in N. Du Ham., 5. p. 32. and 21.; Dec. Prod., 2. p. 538.; Don's Mill., 2. p. 513.

Synonymes. *Prunus pygmæa* Willd. Sp., 2. p. 993., Pursh Fl. Amer. Sept., 1. p. 231.

Spec. Char., &c. Leaves ovate-elliptical, but tapered to the base, and rather acute at the tip, sharply serrated, glabrous on both surfaces, and with 2 glands at the base. Flowers of the size of those of *P. spinosa*, disposed in sessile umbels, a few in an umbel. Fruit black, of the size of a large pea, a little succulent. (*Dec. Prod.*, ii. p. 538.) A shrub, about 4 ft. or 5 ft. high, a native of the western parts of Pennsylvania and Virginia, introduced in 1823. It flowers in May, and its fruit is very indifferent.

† 13. *C. NIGRA* Lois. The black Cherry Tree.

Identification. Lois. in N. Du Ham., 5. p. 32. No. 22.; Sims Bot. Mag., t. 1117.; Hook. Fl. Bor. Amer., 1. p. 167.; Dec. Prod., 2. p. 538.; Don's Mill., 2. p. 513.

Synonymes. *Prunus nigra* Ait. Hort. Kew., 2d ed. 3. p. 193., Pursh Fl. Amer. Sept., 1. p. 331.; *P. americana* Darlington in Amer. Lyc. N. H. of New York.

Engravings. Bot. Mag., t. 1117.; and our figs. 411, 412.



411

Spec. Char., &c. Leaf with 2 glands upon the petiole, and the disk ovate-acuminate. Flowers in sessile umbels, few in an umbel. Calyx purple; its lobes obtuse, and their margins glanded. (*Dec. Prod.*, ii. p. 538.) A tall shrub or low tree, a native of Canada, and of the Alleghany Mountains; introduced in 1773. It flowers in April and



412

May; and its flowers, from the purplish tinge of the anthers, have a very pleasing appearance. The fruit, which, as far as we know, has not been produced in England, is described by Sir W. J. Hooker as being as large as a moderate-sized cherry, and, apparently, red. The leaves, the wood, and the general habit of the plant, as seen in the gardens about London, are much more those of a plum, than those of a cherry. It forms a very handsome small tree, producing its blossoms later than those of the common plum, but, like it, before the appearance of the leaves. There are plants in the Hammersmith Nursery, and in other gardens near London, which flower every year.

★ 14. *C. HYEMALIS* Michx. The winter Cherry Tree.

Identification. Lois. in N. Du Ham., 5. p. 194.; Dec. Prod., 2. p. 538.; Hook. Fl. Bor. Amer., 1. p. 168.; Don's Mill., 2. p. 514.

Synonymes. *P. hyemalis* Michx. Fl. Bor. Amer., 1. p. 281., Pursh Fl. Amer. Sept., 1. p. 331., Elliot Carol., 1. p. 512.; the black Choke Cherry.

Spec. Char., &c. Leaves oblong-oval, or oval, abruptly acuminate. Flowers glabrous, disposed umbellately. Lobes of the calyx lanceolate. Fruit nearly ovate, and blackish. (*Dec. Prod.*, ii. p. 538.) A shrub, growing to the height of 3 ft. or 4 ft., on the western mountains of Virginia and Carolina. The fruit is small, black, and extremely astringent, but eatable in winter. It is commonly called by the inhabitants the black choke cherry. It was introduced into England in 1805, but is not common in collections. Sir W. J. Hooker says that this species is unknown to him, and that Dr. Darlington thinks the *P. hyemalis* of Elliot is the *P. nigra* of authors, and his *P. americana*: such is the state of confusion which exists among the species of this genus. In all probability, if all the alleged species were grown in the same garden, not above half of them would be found distinct.

♣ 15. *C. CHICASA Michx.* The Chicasaw Cherry Tree.

Identification. Michx. Fl. Bor. Amer., 1. p. 294.; Lois in N. Du Ham., 5. p. 183.; *Dec. Prod.*, 2. p. 538.; Don's Mill., 2. p. 514.
Synonymes. *Prunus chicasa Pursh Fl. Amer. Sept.*, 1. p. 332.; *P. insititia Walt. Carol.*; Chicasaw Plum, in *Carolina*.

Spec. Char., &c. Branches glabrous, becoming rather spiny. Leaves oblong-oval, acute, or acuminate. Flowers upon very short peduncles, and mostly in pairs. Calyx glabrous, its lobes very short. Fruit nearly globose, small, yellow. (*Dec. Prod.*, ii. p. 538.) A shrub, growing to the height of 6 ft. in Virginia and Carolina, where it flowers in April and May; and the flowers are succeeded by a small, yellow, agreeably tasted fruit. According to Michaux, it was introduced into the cultivated parts of North America by the Chicasaw Indians; and hence it is commonly called the Chicasaw plum. Pursh observes that, as it generally occurs where ancient Indian camps have been formed, Michaux's conjecture may be correct. It was introduced into England in 1806, and plants of it are in Loddiges's arboretum. Sir W. J. Hooker observes that a plant which he received under this name appeared to him identical with *C. borealis*.

♣ 16. *C. PUBESCENS Scr.* The pubescent Cherry Tree.

Identification. Seringe in *Dec. Prod.*, 2. p. 538.; Don's Mill., 2. p. 514.
Synonymes. *Prunus pubescens Ph. Fl. Amer. Sept.*, 1. p. 331.; *P. sphærocarpa Michx. Fl. Bor. Amer.*, 1. p. 284., not of Swartz.

Spec. Char., &c. Young branches pubescent. Leaves with the disk shortly oval, serrulated, and usually with 2 glands at its base. Flowers in sessile umbels, few in an umbel; pedicels and calyxes pubescent. Fruit upon a short pedicel, globose, brownish purple, austere. (*Dec. Prod.*, ii. p. 538.) A low shrub, a native of the western parts of Pennsylvania, on the borders of lakes. Its flowers are smaller than those of any other American species; and they are succeeded by fruit of a brownish purple, very astringent. It was introduced into England in 1820, and there are plants of it in Loddiges's arboretum.

♣ 17. *C. PENNSYLVANICA Lois.* The Pennsylvanian Cherry Tree.

Identification. Lois in N. Du Ham., 5. p. 9.; *Dec. Prod.*, 2. p. 539.; Don's Mill., 2. p. 514.
Synonymes. *Prunus pennsylvanica L. Fil. Suppl.*, p. 252.; *Pursh, Fl. Amer. Sept.*, 1. p. 331.; *P. pennsylvanica Willd. Baum.* edit. 1811, p. 310.; *P. lanceolata Willd. Abb.*, p. 240.
Engraving. Willd. Abb., p. 240. t. 3. f. 3.

Spec. Char., &c. Leaves with two glands at the base of the disk, which is oblong-lanceolate, acuminate, and glabrous. Flowers disposed in grouped sessile umbels, which have something of the character of panicles. (*Dec. Prod.*, ii. p. 539.) A native of North America, found wild from New England to Virginia, in woods and plantations. According to Pursh, it very much resembles the common cherry. The fruit is small, but agreeable to eat. Sir W. J. Hooker considers this sort as synonymous with *C. borealis Michx.*, in which he may probably be correct. We have, however, kept them distinct; not only because the whole genus appears in a state of confusion, but because, though *C. pennsylvanica* is said to have been introduced in 1773, we have never seen the plant in a healthy state, and, consequently, feel unable to give any decided opinion respecting it.

♣ 18. *C. JAPONICA Lois.* The Japan Cherry Tree.

Identification. Lois in N. Du Ham., 5. p. 83.; Don's Mill., 2. p. 514.
Synonymes. *Prunus japonica Thunb. Fl. Jap.*, p. 201., and *Lindl. in Bot. Reg.*, t. 1801.; *P. sinensis Pers. Ench.*, 2. p. 36.
Engravings. *Bot. Reg.*, t. 1801.; and our *figs.* 413, 414.



413

Spec. Char., &c. Leaves ovate, acuminate, glabrous, shining. Peduncles solitary. Lobes of calyx shorter than the tube. (*Don's Mill.*, ii. p. 514.) A shrub, somewhat tender, growing 3 ft. or 4 ft. high, with numerous, slender, purplish or brownish red twigs, which are covered with a profusion of pale bluish-coloured flowers, from March to May. It was introduced from China about 1834, or earlier, by John Reeves, Esq. (*Bot. Reg.*, t. 1801.) The figure in the *Botanical Register* is from a plant which was grown in a green-house; and ours is from one which flowered in the open garden, which will account for the difference in their appearance.

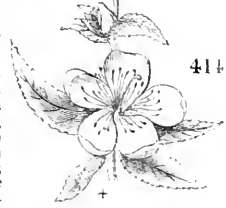

414

Variety.

♣ *C. j. 2 multiplex* Ser. *Amýgdalus púmila* Lin. *Mant.*, 74, *Bot. Mag.*, t. 2176, and of the Hammersmith and other nurseries; and our figs. 415, and 416. — Flowers semi-double, pink like those of the species.

There are two shrubs in British nurseries often confounded together under the name of *A. púmila*; the one is that now described, which may be known at any season by the purplish or brownish red colour of the bark of its young shoots; and, in summer, by its glabrous, finely serrated leaves, which have a reddish tinge on their margins, and on the midribs. The other, *C. sinénsis* described below, the *Prúnus japónica* of Ker, and of the Hammersmith and other nurseries, may be known in the winter season by the light green or greyish colour of the bark of its young shoots; by its larger, paler-coloured, and comparatively rugose leaves, doubly or coarsely serrated; and by its more compact habit of growth. The flowers of this sort are also on longer peduncles, resembling those of a cherry; while

415



416



those of *C. japónica multiplex*, the *Amýgdalus púmila*, or double dwarf almond of the nurseries, have much shorter peduncles, and are sometimes nearly sessile, giving the plant more the appearance of a *Prúnus* than that of a *Cérasus*. The *C. japónica multiplex* has been in cultivation in British gardens, under the name of *Amýgdalus púmila*, since the days of Bishop Compton; and, though it is stated in books to have been introduced from Atrica, there can be little doubt of its being of Asiatic origin. The great confusion which exists respecting these two plants, in botanical works, has induced us to examine, with particular attention, the plants of them that are in the Horticultural Society's Garden, and in the Hammersmith Nursery. In the former garden, there is at this time (June 10th, 1837) *Cérasus japónica* in its single state, but not in its double state; the plant bearing the name of *C. japónica flore pleno* being unquestionably the *C. sinénsis* described below, the *Prúnus japónica* of the nurseries. In the Hammersmith Nursery, there are some dozens of plants of *C. japónica multiplex*, there called *Amýgdalus púmila*, or the double dwarf almond, growing in parallel nursery lines, with some dozens of plants of *C. sinénsis*, there called *Prúnus japónica*, or the double Chinese almond. We have considered it necessary to be thus particular, to justify us for having deviated from the *Bot. Mag.* and *Bot. Reg.*

♣ 19. *C. SINÉNSIS* G. Don. The Chinese Cherry.

Identification. Don's Mill., 2, p. 514.

Synonymie. *Prúnus japónica* Ker in *Bot. Reg.*, t. 27.

Engravings. *Bot. Reg.*, t. 27; and our fig. 417.

Spec. Char., &c. Leaves ovate-lanceolate, doubly serrated, wrinkled from veins beneath. Peduncles sub-aggregate. (*Don's Mill.*, ii. p. 514.) There is no single state of this species in Britain, but there is a plant of the double variety against a wall in the Horticultural Society's Garden, named (June, 1836) *C. japónica flore pleno*; and, as noticed under the preceding sort, there are many plants in the Hammersmith Nursery, under the name of *P. japónica*, or the double Chinese almond. A highly ornamental shrub, which, like the preceding sort, grows to the height of 3 ft. or 4 ft., and is profusely covered with flowers, which appear about the end of April, and continue throughout May. The plant is somewhat more tender than *C. j. multiplex*, which is well known in gardens as a hardy border shrub; and, except in favourable situations, it requires to be planted against a wall. Flowers semi-double, with the petals red on the upper side, and white on the under. Though this and the preceding sort are quite distinct, there is nothing in that distinctness, as it appears to us, to determine that they are not varieties of the same species. Plants, in the London nurseries, of this and the preceding sort, are 1s. 6d. each; at Bollwyller, 1 franc. *C. japónica*, in its single state, has scarcely yet been propagated for sale.

417



☞ 20. *C. SALICINA* G. Don. The Willow-leaved Cherry Tree.

Identification. Don's Mill, 2. p. 514.

Synonymes. *Prunus salicina* Lindl. in *Hort. Trans.*; Ching-Cho-Lee, or Tung-Choh-Lee, *Chinese*.

Spec. Char., &c. Flowers usually solitary, shorter than the leaves. Leaves obovate, acuminate, glandularly serrated, glabrous. Stipules subulate, glandular, length of the petiole. Petiole glandless. (*Don's Mill*, ii. p. 514.) A shrub, growing to the height of 4 ft. or 6 ft., a native of China, introduced in 1822. The flowers are small and white, and the fruit about the size of those of the myrobalan plum. According to G. Don, it is nearly allied to *C. glandulosa*, mentioned below.

C. Species belonging to the preceding Subdivision (B.), not yet introduced.

☞ *C. Phóshia* Hamilt. (*D. Don Fl. Nep.*, p. 239.), *Prunus cerasoides* D. Don (*Prod. Fl. Nep.*, p. 289.; *Don's Mill*, ii. p. 505.), is a native of Nepal, where it is called phoshia, with flowers of a pale rose colour. It is a tree, and grows to the height of 15 ft. or 20 ft.

☞ *C. Púddum* Roxb. (*Wall. Pl. Rar. Asiat.*, ii. p. 37. t. 143.) is a native of Nepal, where it grows to the height of 20 ft. or 30 ft., with rose-coloured flowers, and fruit like that of a common cherry. Its wood is considered very useful. It flowers in October and November; and, in its native country, where it is called puddum, it is very abundant.

☞ *C. glandulosa*, ☞ *C. áspera*, and ☞ *C. incisa* Lois., are Japan shrubs, with rose-coloured flowers, described by Thunberg; and, after him, by Loiseleur, in the *Nouveau Du Hamel*; and in *Don's Mill*, ii. p. 513.

☞ *C. humilis* Moris. (*Elench. Sard.*, p. 17.) is a native of Sardinia, with the habit of *C. prostrata*, but differs from it in having the nerves of the leaves hoary, and the petals of the flowers of a pale rose colour. It flowers in June and July, and would be a desirable introduction.

§ ii. *Pàdi vèri* Ser. The true Bird Cherry Kinds of Cérasus.

Sect. Char. Flowers produced upon the shoots of the same year's growth as the flowers; the latter disposed racemously. Leaves deciduous.

A. *Species of Bird Cherry Trees already in Cultivation in Britain.*

☞ 21. *C. MAHÁLEB* Mill. The Mahaleb, or perfumed, Cherry Tree.

Identification. Mill. Dict., No. 4.; Dec. Fl. Fr., 4. p. 480.; Prod., 2. p. 539.; Don's Mill., 2. p. 514.

Synonymes. *Prunus Mahaleb* L. Sp., 678., Jacq. Fl. Austr.; Bois de Sainte Lucie, or Prunier odorant, Fr.; Mahalebs-kirsche, Ger.

Engravings. N. Du Ham., 5. t. 2.; Jacq. Fl. Austr., t. 227.; and the plate of this species in our Second Volume.

Spec. Char., &c. Leaves cordately ovate, denticulate, glanded, curved. Flowers in leafy subcorymbose racemes. Fruit black, between ovate and round. (*Dec. Prod.*, ii. p. 539. and *E. of Pl.*) A tree, a native of the middle and south of Europe, where it grows to the height of from 10 ft. to 20 ft., and upwards, flowering in April and May. Introduced in 1714.

Varieties. Besides one with variegated leaves, there are:—

☞ *C. M. 2 fructu flavo* Hort. has yellow fruit. There is a plant of this variety in the garden of the London Horticultural Society.

☞ *C. M. 3 latifolium* Hort. has broader leaves than the species.

Description. A handsome small tree, with a white bark, and numerous branches. The leaves somewhat resembling those of the common apricot, but of a paler green. The fruit in the species is much smaller than that of the wild cherry, black, and very bitter to the taste; but greedily eaten by thrushes and blackbirds. Gerard describes the fruit as being as hard as a bead of coral, and shining. The wood, the leaves, the flowers, and the fruit, are powerfully scented; the flowers so much so as not to be supportable in a room. The tree, in its native habitats, is seldom found above 18 ft. or 20 ft. high; but, in a state of cultivation, in good soil, it will grow to the height of

25 ft. or 30 ft.; averaging a rate of growth from 1 ft. to 18 in. annually for the first 10 years.

Geography, History, &c. It is found wild in the middle and south of France, the south of Germany, Austria, Piedmont, and in Crim Tartary; and it was found by Pallas in abundance on Mount Caucasus, where it differed from the European variety in the leaves and flowers coming out together, and in the leaves being more cordate and acuminate. The tree is very general in France, particularly in the mountainous districts. It is very common in the neighbourhood of Ste. Lucie, whence its name of bois de Ste. Lucie. Trees of it are sometimes found, in that neighbourhood, with trunks 4 ft. in circumference. The tree is very generally cultivated in England, as an ornamental plant. It was introduced in 1714, but was known long before, from the circumstance, as Gerard informs us, of "the cunning French perfumers making bracelets, chains, and such like trifling toys, of the fruit, which they send into England, smeared over with some old sweet compound or other, and here sell unto our curious old ladies and gentlemen, for rare and strange pome-ambers [scented balls], for great sums of money." (*Johnson's Gerard.*)

Properties and Uses. The wood of the mahaleb is hard, brown, veined, and susceptible of a high polish. Its smell is less powerful, and more agreeable, when it is dry, than when the sap is in it. In a dry state it weighs 59 lb. 4 oz. per cubic foot. In France, it is much sought after by cabinetmakers, on account of its fragrance, hardness, and the fine polish which it receives; and it is sold by them green, in thin veneers, because in that state it does not crack, or, at least, the slits, or chinks, are less perceptible. In the Vosges, in the neighbourhood of the Abbey of Ste. Lucie, a great deal of this wood is sold to turners, and for the manufacture of tobacco-pipes and snuff-boxes. In Lorraine, the wood of the mahaleb is often confounded with that of the *C. Pádus*; and the latter, also a handsome wood, is often sold for the former. The leaves are powerfully fragrant, more particularly when dried: they are greedily eaten by cattle and sheep, and they are used for giving flavour to game. The kernel of the nut is employed by perfumers to scent soap. The wood is highly prized as fuel, on account of the fragrance which it sends forth when burning; on which account it was planted, in many parts of France, by the ancient nobility, as undergrowth. It was also, for the same reason, planted as hedges. One of the principal uses in which the plant is at present employed in France is, as a stock on which to graft the different kinds of fruit-bearing cherries; for which it has the advantages of growing on a very poor soil; of coming into sap 15 days later than the common wild cherry, by which means the grafting season is prolonged; and, lastly, of dwarfing the plants grafted on it. In British gardens, it is partly used for this purpose, but principally as an ornamental shrub or low tree. As in the case of other dwarf species of a genus which will unite to a tall robust-growing species, the mahaleb, when grafted on the common wild cherry (*C. sylvéstris*), grows to a larger tree than when on its own roots.

Soil, Situation, &c. The mahaleb will grow in any poor soil that is dry, even in the most arid sands and naked chalks; and, as it forms a low bushy tree which is capable of resisting the wind, it may be planted in an exposed situation. When young plants are to be raised from seed, the fruit is sown as soon as ripe, or preserved among sand till the following spring, in the same manner as that of the cherry. (See p. 700.) Seedling plants generally grow 1 ft. in length the first year, and from 1 ft. to 18 in. the second year. The tree may also be propagated by layers, by slips from the stool, taken off with a few roots attached, and by suckers, or by cuttings from the roots.

Statistics. There are trees of *Cerasus Mahaleb* at Syon, and some other places in the neighbourhood of London, upwards of 20 ft. high. In Ireland, at Kilkenny, in Woodstock Park, there is one 22 ft. high, with a trunk 1 ft. 4 in. in diameter. In France, at Paris, in the Jardin des Plantes, a tree, 40 years planted, is 40 ft. high, the diameter of the trunk 17 in., and of the head 42 ft.; at Avranches, in the Botanic Garden, 30 years planted, it is 25 ft. high. In the London nurseries, seedlings, from 1 ft. to 2 ft. high, are 30s per hundred; and large plants, from 1s to 1s. 6d. each. At Bollwyller they are 50 cents each.

‡ 22. *C. PÀDUS* Dec. The Bird Cherry Tree.

Identification. Dec. Fl. Fr., 4. p. 580.; Prod., 2. p. 539.; Don's Mill., 2. p. 515.

Synonyms. Prunus Pàdus Lin. Sp., 677., Hook. Brit. Flora, p. 220., Smith Eng. Flora, 2. p. 354.; Bird Cherry, Fowl Cherry; Hag-berry, Scot.; Cerisier à Grappes, Mérisier à Grappes, Laurier-Putier, or Putiet, faux Bois de Ste. Lucie, Fr.; Hag-bier, Swedish; Traubeden Kirsche, Ger. Engravings. Eng. Bot., t. 1383.; and the plate of this species in our Second Volume.

Spec. Char., &c. Leaves ovate-lanceolate, somewhat acuminate, thin, serrulate, with the teeth rather spreading. Racemes long, leafy. Fruit round, bitter. Wild, on hills and in hedges, in Europe. (*Dec. Prod.*, ii. p. 539.) A low tree, indigenous in most parts of central Europe, and as far north as Lapland. Seringe, in *Dec. Prod.*, has characterised four forms of this species, as follows:—

‡ C. P. 1 *vulgaris* Ser. *C. Pàdus* Dec. (*Fl. Fr.*, iv. p. 580.) and *Lois.* (*N. Du Ham.*, v. t. 1.) — This kind has large flowers loosely disposed upon long pedicels, and black fruit.

‡ C. P. 2 *parviflora* Ser. (*Ed. Fl. Dan.*, t. 205.) — This has smaller flowers, upon shorter pedicels, which are disposed more densely; and black fruit.

‡ C. P. 3 *rùbra* Ser.—This has red fruit. It is the *C. Pàdus frùctu rùbro* of Dec. and of Loiselenr, in the places cited above; and, according to *Ait. Hort. Kew.*, 2d ed. p. 299., it is the *Prunus rùbra* of *Willd. Arb.*, 237. t. 4. f. 2.

‡ C. P. 4 *bractcòsa* Ser.—This has very numerous flowers, and their pedicels are attended by long bracteas. It is a very beautiful variety, distinguished by its long racemes of flowers at the points of the shoots, by which the latter are bent down, both when in blossom and when the fruit is ripe, so as to give the whole tree a pendulous appearance.

Description. In a wild state, the bird cherry forms a small tree, or large bush, of 10 ft. or 12 ft. in height; but, in good soil, and trained to a single stem, it will attain to double that height, or more, with a trunk upwards of a foot in diameter. The branches are spreading, and covered with a purplish bark, spotted with white. The leaves are finely serrated, smooth, and somewhat glaucous; and their scent, when bruised, resembles that of rue. The flowers are of a pure white, in copious, long, drooping clusters, making an elegant appearance in spring, but scarcely lasting a fortnight. The fruit is small, black, austere, and bitter, with a large corrugated nut. "Birds of several kinds soon devour this fruit, which is nauseous, and probably dangerous to mankind; though, perhaps, like that of the cherry laurel, not of so deadly a quality as the essential oil or distilled water of the leaves." (*Eng. Flora*, ii. p. 354.) The tree grows rapidly when young, attaining the height of 10 ft. or 12 ft. in 5 or 6 years; and, as it has a loose head, and bears pruning, it allows the grass to grow under it.

Geography, History, &c. The bird cherry is found wild in woods in most parts of Europe, and in the north-west of Asia. It grows on Mount Caucasus, in Russia, in Siberia as far as lat. 62° N., in Lapland as far as lat. 70° N., and in Kamschatka. It is to be found in every part of England, and in many places in Scotland and Ireland. In the north of England, according to Winch, it grows to the height of 1600 ft. above the level of the sea. In Scotland, it is common as an undergrowth, in native woods, more particularly in tolerably dry soils. It was known to Theophrastus (see p. 17.); and seems to have been first noticed by Matthiolus on the Continent, and by Gerard in Britain. Gerard says that, in his time, it grew wild in the woods of Kent, where it was used as a stock to graft cherries on, more particularly the Flanders cherry. In Lancashire, he says, it was found in almost every hedge.

Properties and Uses. The wood is hard and yellowish, and, in a green state, it has a disagreeable bitter odour and taste; whence the French name *putiet*, from *puer*. It is much sought after in France by the cabinetmakers and turners, who increase the beauty of its veining by sawing out the boards diagonally, that is, obliquely across the trunk, instead of parallel with its length.

The fruit, though nauseous to the taste when eaten fresh from the tree, gives an agreeable flavour to brandy; and is sometimes added to home-made wines. In Sweden and Lapland, and also in some parts of Russia, the bruised fruit is fermented, and a powerful spirit distilled from it. A strong decoction of the bark is considered by the Finlanders as antisiphilitic. Sheep, goats, and swine eat the leaves: cows are fond of them, but horses refuse them. (*Lin.*) In Britain, the principal use of the *Cerasus Pádus* is as an ornamental tree; and few make a finer appearance than it does, either when in flower, in April and May; or in August, when covered with its pendent racemes of black fruit. It comes into flower a little before the ornamental crab trees, and about the same time as the *Sórbus aucupária* and the *Acér platanóides*.

Soil, Situation, Propagation, &c. The bird cherry prefers a dry soil; but it will not thrive on such poor ground as the perfumed cherry. It will grow in almost any situation; but, to attain a timber-like size, it requires the shelter either of a favourable locality, or of adjoining trees. The species is propagated by seeds, which should be treated in all respects like those of *C. Mahaleb*. The red-fruited variety, which is properly a race, will frequently come true from seed; as, doubtless, will the early-flowering and late-flowering varieties, which may be observed in copse woods where this tree abounds. *C. P. bracteósa Ser.*, which is a very remarkable variety, and one which deserves a place in every collection, both on account of its large racemes of flowers and its fruit, will most certainly be continued by grafting or budding.

Accidents and Diseases. The leaves of the bird cherry seem to be more relished by the caterpillars of moths and butterflies, than those of other species of the genus. This may be observed where plants occur in the neighbourhood of London, where they may frequently be seen, in the beginning of June, almost entirely denuded of leaves, while other species of *Cerasus* around them have their leaves uninjured. In Belgium, where the tree is particularly abundant in the natural woods, and where the caterpillars are collected at certain seasons, in conformity with the provincial laws established for the preservation of forests, this tree is always found much more injured by them than any other. Hence, a writer in a Bavarian agricultural journal recommends planting in orchards one bird cherry in every square of 100 or 200 yards; to which tree, he says, all the moths and butterflies will be attracted, and on which they will deposit their eggs. The appearance of the bird cherry, he says, will soon become hideous, but the fruit trees will be safe. (See *Gard. Mag.*, vol. i. p. 81.)

Statistics. The largest bird cherry tree that we know of in the neighbourhood of London is at Syon, where it is 36 ft. high, with a trunk 11 in. in diameter. In Cheshire, at Eaton Hall, 14 years planted, it is 17 ft. high. In Durham, at Southend, 50 years planted, it is 22 ft. high. In Worcestershire, at Croome, 40 years planted, it is 35 ft. high. In Scotland, in the Glasgow Botanic Garden, 15 years planted, it is 22 ft. high; in Banffshire, at Gordon Castle, it is 40 ft. high; in Clackmannanshire, in the garden of the Dollar Institution, 12 years planted, it is 15 ft. high; in Perthshire, at Taymouth, 18 years planted, it is 30 ft. high. The Rev. Dr. Walker mentions, in his *Essays on Natural History*, two hag-berries growing together in the parterre below the terrace at Drumlanrig, in Nithsdale, in 1773. They were then about 70 years old, about 40 ft. high, and the trunk of the largest measured 8 ft. in circumference. The trees were at that time vigorous; but, on our sending to enquire after them in 1834, we found they no longer existed, and that the time when they fell, or were cut down, was unknown. In Forfarshire, at Kinnordy, there are some large specimens.

‡ 23. *C. VIRGINIA'NA Michx.* The Virginian Bird Cherry Tree.

Identification. Michx. Fl. Bor. Amer., 1. p. 285; Dec. Prod., 2. p. 539; Hook. Fl. Bor. Amer., 1. p. 169; Don's Mill., 2. p. 515.

Synonymes. *Prúnus rubra Ait. Hort. Kew.*, 1st ed., 2. p. 162, *Willd. Abb.*, 238. t. 5. f. 1.; *P. argúta Bigetow* in Litt.; *Cerisier de Virginie, Fr.*; *Virginische Kirsche, Ger.*; *Wild Cherry Tree, Amer. Engravings.* *Willd. Abb.*, 238. t. 5. f. 1.; *Michx. Fl. Arb. Amer.*, 2. t. 88.; our fig. 418.; and the plate of this species in our Second Volume.

Spec. Char., &c. Leaves oblong, acuminate, doubly toothed, smooth; the petiole bearing about 4 glands. Racemes straight, petals round. Fruit red. Different from the *Prúnus virginiana* of Miller, which is *C. (v.) serótina*. (*Dec. Prod.*, ii. p. 539.) A tree, attaining a large size in Virginia, Carolina, and Canada. Introduced into Britain in 1724, and flowering in May and June.

Description, &c. This tree, which is seldom found, in England, higher than 30 ft. or 40 ft., grows, on the banks of the Ohio, to the height of 80 ft. or

100 ft., with a trunk of 3 ft. or 4 ft. in diameter, rising straight and erect to the height of 25 ft., or nearly 30 ft. It varies much in size in different climates and soils; according to Dr. Richardson, being only about 20 ft. high on the sandy plains of the Saskatchewan; and, on the Great Slave Lake, in lat. 62°, seldom exceeding the height of 5 ft. The bark is so peculiar, that the tree can be known by it, even when without its leaves, or when its branches are too far above the eye for the leaves to be examined individually. The general surface of the bark is smooth; but it is blackish and rough, and detaches itself in narrow semicircular plates, which are hard and thick, and adhere a time to the trunk before dropping off. The leaves are 5 in. or 6 in. in length, oval, acuminate, very much pointed, and of a beautiful, smooth, shining green, with small reddish glands at the base. It has been remarked, in America, that the



leaves are more subject to be eaten by caterpillars than those of any other tree. It appears that Linnæus considered the *P. virginiana* as a variety of the common bird cherry; and Seringe, in De Candolle's *Prodromus*, also expresses a doubt whether it may not be a variety of that species. To those who have seen the two trees known by these names in the London gardens growing together, there can be so little doubt on the subject, that we are tempted to conclude that the *Prunus virginiana* of Linnæus, and *C. virginiana* of De Candolle, must be a different plant from the *C. virginiana* of British gardens. The two species are easily distinguished, in all their stages, by their wood, which is much darker, and more robust, in *C. Pádus*, than in *C. virginiana*; by their leaves, which are rough, thick, and not shining in the former; while in the latter they are thin, smooth, and shining. The leaves of *C. virginiana* remain on till late in the autumn, and sometimes till spring, retaining their colour till they drop off; so that the tree may be considered as sub-evergreen; while those of *C. Pádus* become yellow in August, about the time the fruit ripens, and soon afterwards drop off. Sir W. J. Hooker is of opinion that Michaux has confounded *C. virginiana* with *C. serótina*; but, as we believe them to be both the same, this is to us a matter of little consequence. If they are not distinct species, they are, at all events, very distinct races.

Geography, History, &c. In the Atlantic states of America, as well as in those of the west, this cherry is more or less abundant, as the soil and climate are more or less favourable to its growth; to which extremes of cold and heat in the seasons, and of dryness and humidity in the soil, are alike unfavourable. It abounds in the Illinois, in Genessee, and in Upper Canada; but is nowhere more profusely multiplied, nor more fully developed, than beyond the mountains in the states of Ohio, Kentucky, and Tennessee. In the state of Maine, where the winter is long and intense, it hardly exceeds 30 ft. or 40 ft. in height, and from 8 in. to 12 in. in diameter. In the southern and maritime parts of the Carolinas and of Georgia, where the summer is intensely hot, and where the soil is generally arid and sandy, it is rarely seen; and on the banks of rivers, where the ground is too wet, its dimensions are stunted; but in the upper parts of these states, where the climate is milder, and the soil more fertile, it is sufficiently common, though less multiplied there than in Virginia and Pennsylvania. Wherever it abounds, it is found associated with *Quercus macrocarpa*, *Juglans nigra*, *Gleditschia triacanthos*, *Ulmus rubra*, and *Gymnocladus canadensis*; forming immense masses of forest, which it adorns by its beautiful flowers in May, and which it contributes to stock with birds, by the great nourishment which it affords to them with its fruits in August, September, and October. The Virginian bird cherry appears to have been one of the first North American trees brought to England; the

species, or its variety *C. (v.) serotina*, having been cultivated by Parkinson in 1629, under the name of the Virginian cherry bay. The species is now very general in British collections; and in some places in Surrey, for example, in the neighbourhood of Chertsey and at Deepdene, it appears as if naturalised; plants springing up abundantly in the woods and in the wastes, from nuts dropped by the birds.

Properties and Uses. The wood of the Virginian bird cherry is of a light red tint, which deepens with age. It is compact, fine-grained, and takes a brilliant polish; it is also not liable to warp when perfectly seasoned. In America, it is extensively used by cabinetmakers for every species of furniture; and, when chosen near the ramification of the trunk, it rivals mahogany in beauty. The wood is generally preferred to that of the black walnut, the dun colour of which, in time, becomes nearly black. On the banks of the Ohio, it is employed in ship-building; and the French of Illinois use it for the fellos of wheels. The fruit is employed to make a cordial, by infusion in rum or brandy, with the addition of a certain quantity of sugar. The bark is bitter and aromatic, its taste being strong, penetrating, and not disagreeable. It is, undoubtedly, a useful tonic, and appears to possess, in some degree, narcotic and antispasmodic properties. The latter quality is strongest in the recent state of the bark, and in the distilled water. (*Michaux*, iii. p. 155.) In Europe, *C. virginiana* is planted solely as an ornamental tree; and, as such, it well deserves a place in every collection; and it should be planted in every shrubbery or wood where it is desirable to attract frugivorous singing birds. For soil, situation, propagation, culture, &c., see *C. Pàdus*.

Statistics. The largest trees in the neighbourhood of London are in the arboretum at Kew, where there is a tree upwards of 30 ft. high. There are, also, large trees at Syon, at Deepdene, at Lyne Grove, and St. Anne's Hill. The handsomest young tree of this kind that we know is in the Duke of Devonshire's grounds at Chiswick; where, after being 8 years planted, it has attained the height of 25 ft., forming a singularly rich and graceful tree. (See the statistics of *C. (v.) serotina*.) The price of seedlings, in the London nurseries, is 50s. per hundred, and of large plants 1s. 6d. each; at Bollwyler, seedlings are 15 francs a hundred, and large plants 1 franc each.

‡ 24. *C. (v.) SEROTINA* Loes. The late-flowering, or American, Bird Cherry Tree.

Identification. Loes. in *N. Du Ham*, 5. p. 3; *Dec. Prod.*, 2. p. 540; *Don's Mill.* 2. p. 515.

Synonyms. *Prunus serotina* Willd. *Abb.*, 259; *P. virginiana* Mill. *Diet.*, No. 2.

Engravings. Willd. *Abb.*, 259. t. 5. f. 1, 2; Wats. *Dend. Brit.*, t. 48; and our fig. 419.

Spec. Char., &c. Leaves ovate-lanceolate, rather coriaceous, glossy, serrated; the teeth imbricate, very numerous, and the lowest ones indistinctly glanded; midrib downy at its base. Floral leaves narrowed at the base. Racemes loose. Fruit black. (*Dec. Prod.*, ii. p. 540.) A tree, a native of North America, introduced in 1629.

Variety.

‡ *C. s. 2 retusa* Ser. — Leaves obovate, round, very obtuse, almost retuse, slightly villose beneath; midrib hairy above and below. A native of South America. (*Dec. Prod.*, ii. p. 540.)

Description, &c. This sort so closely resembles *C. virginiana*, that we have no doubt whatever of their being one and the same species. Sir W. J. Hooker observes: "That Michaux and others have confounded the *C. serotina* and the *C. virginiana* is quite certain; but it is still with me a matter of great doubt, how far the two are entitled to be ranked as species. The serratures and tufts of hair on the under sides of the leaves are, undoubtedly, variable; and we know how little dependence is to be placed upon the foliage of our own *Cérasus Pàdus*; a species so nearly allied to this, that Seringe (in *De Candolle's Prodrômus*) seems to doubt if it be really distinct." (*Fl. Bor. Amer.*, i. p. 170) By comparing the trees in the Lon-



don Horticultural Society's Garden, in Loddiges's arboretum, and at Syon, we think it will be difficult to discover anything like a specific distinction, or even sufficient to constitute a race.

Statistics. Under the name of *C. serótina*, we have received the dimensions of several trees, which we consider as those of *C. virginiana*; but we have placed them under this head, in conformity with the name sent us. In Surrey, at Bagshot Park, 40 years planted, and 55 ft. high. In Buckinghamshire, at Temple House, 40 years planted, and 30 ft. high. In Hertfordshire, at Cheshunt, 6 years planted, and 10 ft. high. In York-shire, at Grimstone, 13 years planted, and 20 ft. high. In Scotland, in Stirlingshire, at Callander Park, 16 years planted, and 20 ft. high. In France, at Barres, 13 years planted, and 18 ft. high. In Switzerland, in the Botanic Garden at Geneva, 35 ft. high, with a trunk $\frac{9}{4}$ in. in diameter. Price as in *C. virginiana*.

‡ 25. *C. (v.) CAPOLLIN* Dec. The Capollin Bird Cherry Tree.

Identification. Dec. Prod., 2, p. 539., Don's Mill., 2, p. 515.

Synonymes. *Prunus virginiana* *Flora Mexic. ic.* and *MSS.*; *P. canadensis* *Moc. et Sesse, Pl. Mex. ic. ined., Heru. Mex., 95.*

Engravings. *Fl. Mex. icon. ined.*; *Pl. Mex. icon. ined.*; *Hern. Mex. icon., 95.*; and our *fig. 420.*

Spec. Char., &c. Leaves lanceolate, serrated, and glabrous, resembling in form, and nearly in size, those of *Sáliz frágilis*. Racemes lateral and terminal. Fruit globose, resembling, in form and colour, that of *C. sylvéstris*. A native of Mexico, in temperate and cold places. (*Dec. Prod.*, ii, p. 539.) Seringe doubts whether the racemes are not slightly compound. Those produced on a plant bearing the name of this species, in the London Horticultural Society's Garden, are not. Its leaves, also, are much too broad and elliptical to resemble those of *S. frágilis*; but the leaves, the flowers, and the whole tree, bear so much resemblance to *C. virginiana*, that we have no doubt of its being only a variety of that species, but of larger and more luxuriant growth.

420



There are plants in the London Horticultural Society's Garden, in Loddiges's arboretum, and in the Hammersmith Nursery, which come into leaf, flower, and drop their leaves, at the same time as *C. virginiana*; but a vigorous tree, against a wall in the Horticultural Society's Garden, which flowers and fruits freely, retains its leaves nearly all the winter, in consequence of the protection it receives from the wall. This variety appears to have been introduced in 1820, by the London Horticultural Society; and it certainly deserves culture with *C. virginiana*, in preference to *C. serótina*, on account of its greater distinctness. The bark is said to be employed, in Mexico, as a febrifuge.

‡ 26. *C. (v.) CANADENSIS* Lois. The Canadian Bird Cherry Tree.

Identification. Lois. in N. Du Ham., 5, p. 3.; Dec. Prod., 2, p. 539.; Don's Mill., 2, p. 515.

Synonymes. *Prunus canadensis* *Wald. Sp.*, 2, p. 986., *Pursh Fl. Amer. Sept.*, 1, p. 330.

Engraving. *Fluk. Alm.*, t. 158. f. 4.

Spec. Char., &c. Leaves glandless; the disk broadly lanceolate, tapered into the petiole, wrinkled, downy, and green upon both surfaces. A native of North America. (*Dec. Prod.*, ii, p. 539.) Pursh says, "I strongly suspect this to be nothing more than *P. hyemalis*." In the *Nouveau Du Hamel*, and in Don's *Mitler*, it is characterised as a bird cherry tree; and in the latter as growing to the height of 20 ft. or 30 ft.; and as having been introduced in 1820, and producing its white flowers in May and June. We have never seen the plant.

‡ 27. *C. NEPALENSIS* Ser. The Nepal Bird Cherry Tree.

Identification. Seringe in Dec. Prod., 2, p. 540.; Don's Mill., 2, p. 515.

Spec. Char., &c. Leaves resembling in form those of *Sáliz frágilis*; long, lanceolate, acuminate, serrate, with blunt teeth, glabrous, whitish beneath; the veins much reticulated; and the axis of the larger of them hairy. Peduncle short, and, as well as the rachis, slightly villose. Calyx glabrous. A native of Nepal. (*Dec. Prod.*, ii, p. 540.) In Don's *Mitler*, this species of bird cherry is said to have been introduced in 1820; but we have never seen a plant of it.

B. *Species of Bird Cherry Trees which have not yet been introduced.*

‡ *C. paniculata* Lois. (*N. Du Ham.*, v. p. 7.), *P. paniculata* Thunb., not of *Bot. Reg.*, is said to be a Japan tree, resembling *C. Mahaleb*, but differing in having larger and more spreading panicles, smaller flowers, and longer leaves, which are attenuated at the base, and acutely serrated.

‡ *C. acuminata* Wall. (*Pl. Rar. Asiat.*, ii. p. 78. t. 181.) is a Nepal tree, growing to the height of 20 ft. or 30 ft., with the flowers in axillary racemes, and nodding, a little shorter than the leaves.

‡ *C. mollis* Dougl. (*Hook. Fl. Bor. Amer.*, p. 169.) is a tree, from 12 ft. to 24 ft. in height, with the racemes of flowers short, and pubescently tomentose. The leaves obovate-oblong, crenated, and pubescent beneath; and the fruit ovate. It is a native of the north-west coast of North America, on subalpine hills, near the source of the river Columbia, and also near its mouth. It resembles *C. pubescens* (see p. 705.) in habit; and has, like it, the young shoots dark brown and downy.

‡ *C. emarginata* Dougl. (*Hook. Fl. Bor. Amer.*, p. 169.) is a shrub, growing to the height of 6 ft. or 8 ft., with its flowers in corymbose racemes; oval, serrulated, glabrous leaves; and globose fruit, astringent to the taste. The leaves are 2 in. long; the flowers are white, and the wood red, with white spots. It is found wild about the upper part of the Columbia river, especially about the Kettle Falls.

‡ *C. capricida* G. Don. *The Goat-killing Bird Cherry. Prunus capricida* Wall., *P. undulata* Hamilt. in *D. Don's Prod. Nepal.*, p. 239.; *C. undulata* *Dec. Prod.*, ii. p. 540. Leaves elliptic, acuminate, coriaceous, glabrous, quite entire, with undulately curled margins. Petioles glandulous. Racemes either solitary or aggregate by threes, many-flowered, glabrous, shorter than the leaves. (*Don's Mill.*, ii. p. 515.) A handsome showy tree, probably evergreen, a native of Nepal, at Narainhetty; where the leaves are found to contain so large a quantity of prussic acid as to kill the goats which browse upon them. Royle seems to consider *C. undulata* and *C. capricida* as distinct species; and he observes that these, and "*C. cornuta*, remarkable for its pod-like monstrosity, are handsome showy trees, growing on lofty mountains, and worthy of introduction into England." (*Royle's Illust.*, p. 205.)

‡ *C. elliptica* Lois. (*N. Du Ham.*, v. p. 4.), *Prunus elliptica* Thunb., is described in the *Flora Japonica*, p. 199., as a tree, with elliptic, serrated, veiny, glabrous leaves, and drupes about the size of a small grape.

§ iii. *Laurocérasi. The Laurel-Cherry Trees.*

Sect. Char. Evergreen. Flowers in racemes.

‡ 28. *C. LUSITÁNICA* Lois. *The Portugal Laurel Cherry, or common Portugal Laurel.*

Identification. Lois. in *N. Du Ham.*, 5. p. 5.; *Dec. Prod.*, 2. p. 540.; *Don's Mill.*, 2. p. 516.

Synonymes. *Prunus lusitânica* *Lin. Sp.*, 678.; the Cherry Bay; *Cerisier Laurier du Portugal*, *Fr.*; *Azoreiro*, *Portuguese.*

Engravings. *Mill. Ic.*, 131. t. 196. f. 1.; *Dill. Elth.*, 193. t. 159. f. 193.; our *fig.* 421.; and the plate of the species in our Second Volume.

Spec. Char., &c. Evergreen. Leaves coriaceous, ovate-lanceolate, serrate, glandless. Racemes upright, axillary, longer than the leaves. (*Dec. Prod.*, ii. p. 540.) An evergreen low tree, introduced in 1648, the native country of which is supposed to be Portugal, or the Azores.

Variety.

- ‡ *C. l. 2 Híxa Ser.* *Prunus Híxa* Broussonet, according to *Willd. Enum.*, p. 517.; *P. multiglandulosa* *Cav.* in *Ann. Sc. Nat.*, 1801, 3. p. 59. — Leaves larger, with, according to Willdenow, their lowest teeth glanded. Racemes elongate. Flowers more loosely disposed. Spontaneous in the islands of Teneriffe, Grand Canary, and Palma. Mr. P. B. Webb informs us that this tree, in its native localities, attains the height of 60 ft. or 70 ft. It is much to be regretted that it has not yet been introduced into Britain.

Description. The Portugal laurel has an erect stem, regularly branched on every side; seldom exceeding 20 ft. in height; but in favourable situations, when pruned to a single stem, attaining the height of 30 ft. or 40 ft., or upwards. It is generally, however, seen as an immense bush. The bark of the trunk is white or greyish, and that of the young branches of a shining purplish black. The leaves are of a lucid green, and the flowers, which appear in June, and are in long bunches, are succeeded by oval berries of a dark purple when ripe. The tree grows freely in any soil that is very dry and poor, or very wet. It flowers and ripens its seeds freely in the neighbourhood of London, but rarely in the neighbourhood of Paris, where it requires protection during winter.



421

It is not of rapid growth, seldom making shoots more than 9 in. or 10 in. in length; but, when planted in good free soil, and trained to a single stem, plants, in the neighbourhood of London, will reach the height of from 12 ft. to 15 ft. in 10 years.

Geography, History, &c. The Portugal laurel was received from Portugal about 1648, the date of its culture in the Oxford Botanic Garden. According to the *Kew Catalogue*, it is a native of Portugal and Madeira; and according to the *Nouveau Du Hamel*, of Portugal and Pennsylvania. That it is not a native of Pennsylvania appears certain, from its not being included in any of the different American floras that have been published. P. B. Webb, Esq., informs us that, in 1827, he found the common Portugal laurel, on the Serra de Gerez, in Portugal, growing about half-way up the mountain, and forming a small tree, from 13 ft. to 20 ft. high: the hixa he found growing along with it, and forming a tree from 60 ft. to 70 ft. high. The Portugal laurel soon became a favourite in Britain; and, indeed, during the first half of the 18th century, this plant, the common laurel, and the holly were almost the only hardy evergreen shrubs procurable in British nurseries; in consequence of which they were planted every where. In the neighbourhood of Paris, the Portugal laurel is rather tender, seldom ripening its fruit, and frequently having its young shoots killed back by the frost; and in Germany it is almost every where a green-house shrub. The original tree, in the Oxford Botanic Garden, perhaps the first of the species that was planted in Britain (unless there was one also in the Eltham Botanic Garden, from which the plant was figured in the *Hortus Elthamensis*), was cut down about 1826. It was about 25 ft. or 30 ft. high; and the trunk, at 1 ft. from the ground, was nearly 2 ft. in diameter.

Properties and Uses, Soil, &c. In Britain, it is generally planted solely as an ornamental evergreen; but sometimes hedges are formed of it in nursery-grounds and flower-gardens. The berries are greedily eaten by birds, and, as well as those of the common laurel, form a favourite food for pheasants. What renders the tree particularly valuable, Miller observes, is its being "so very hardy as to defy the severest cold of this country; for, in the hard frost of 1740, when almost every other evergreen tree and shrub was severely pinched, the Portugal laurels retained their verdure, and seemed to have felt no injury." (*Diet.*, 6th edit. p. 5.) In British nurseries, it is propagated by seeds, which, before and after sowing, are treated like those of the common wild cherry (*C. sylvêstris*), or those of the bird cherry (*C. Pàdlus*).

Statistics. In the neighbourhood of London, at Syon, there are several Portugal laurels, 18 ft. and upwards in height, and with trunks 18 in. in diameter; and at Charlton House, an old tree girls 7 ft. 8 in. at 1 ft. from the ground; but the largest Portugal laurel in England is at Cobham Hall, in Kent, where it is 40 ft. high, with a trunk 2 ft. in diameter; and at Eastwell Park, in the same county, there is a tree, or rather bush, which, when we saw it in the autumn of 1826,

was covered with fruit, presenting one hemispherical mass of spikes. In 1835, this mass measured 30 ft. high, and 57 ft. in diameter. In Hampshire, at Alresford, 30 years planted, it is 17 ft. high; at Leigh Park, 7 years planted, it is 13 ft. high. In Herefordshire, at Stoke Edith Park, it is 30 ft. high, with a trunk 2½ ft. in diameter, and the diameter of the head 48 ft. In Lancashire, at Latham House, 60 years planted, it is 19 ft. high, diameter of the head 39 ft. In Derbyshire, at Foston Hall, 80 years planted, it is 17 ft. high, with a head 16 ft. in diameter. In Oxfordshire, at Blenheim, it is 17 ft. high, with a head 100 ft. in diameter. In Staffordshire, at Sandwell Park, 30 ft. high, and the diameter of the head 27 ft. In Yorkshire, at Hornby Castle, 60 years planted, 22 ft. high, and the diameter of the head 54 ft.; at Cannon Hall, 23 ft. high, and the diameter of the head 63 ft. In Scotland, near Edinburgh, at Gosford House, 30 years planted, it is 20 ft. high, diameter of the head 30 ft. In Ayrshire, at Brucefield, 30 ft. high, diameter of the trunk 2½ ft., and of the head 33 ft.; at Rozelle, 22 ft. high, diameter of the trunk 2 ft., and of the head 35 ft. In Berwickshire, at the Hirsell, 30 years planted, and 17 ft. high. In Renfrewshire, at Erskine House, 20 ft. high. In Angussire, at Kinnaird Castle, 30 years planted, and 25 ft. high, diameter of the trunk 22 in., and of the head 36 ft.; at Old Montrose, 60 years planted, and 35 ft. high. In Banffshire, at Gordon Castle, 45 ft. high, diameter of the trunk 2 ft. 6 in., and of the head 57 ft. In Clackmannanshire, at the Dollar Institution, 12 years planted, and 12 ft. high, the diameter of the trunk 8 in., and of the head 10 ft. In Fifeshire, at Dysart House, 14 ft. high, with a hemispherical head 25 ft. in diameter; at Largo House, a tree with a head 40 ft. in diameter; at Raith, 4 trees, 32 years planted, were measured by Mr. Sang in 1819, and the girt was found to vary from 3 ft. 10 in., to 5 ft. 2 in., at the surface of the ground. (*Plant. Kal.*, p. 558.) In Perthshire, at Taymouth, 100 years planted, and 40 ft. high, the diameter of the trunk 2½ ft., and of the head 60 ft. In Stirlingshire, at Airthrie Castle, 36 years planted, and 33 ft. high, diameter of the trunk 2 ft., and of the head 15 ft.; at West Plean, 24 years planted, and 22 ft. high; at Sancheie, 25 ft. high, the diameter of the trunk 1 ft., and of the head 29 ft. In Ireland, at Kilkenny, in Woodstock Park, 70 years planted, and 31 ft. high, the diameter of the trunk 3 ft. 10 in., and of the head 58 ft. In Wicklow, at Shelton Abbey, 40 years planted, and 35 ft. high, the diameter of the trunk 2½ ft., and of the head 39 ft. In Antrim, at Antrim Castle, 150 years planted, 18 ft. high, the diameter of the trunk 3 ft. 7 in., and of the head 36 ft. In Fermanagh, at Florence Court, 40 years planted, and 32 ft. high, diameter of the trunk 3 ft., and of the head 22 ft. In Louth, at Oriel Temple, 50 years planted, and 35 ft. high, the diameter of the trunk 2 ft., and of the head 35 ft.

Commercial Statistics. Seedling plants, in the London nurseries, are 5s. per 100; transplanted plants, a foot high, 20s. per 100; and berries 14s. per bushel: at Bollwyller, where it requires protection during winter, plants are 1 franc 50 cents each; and at New York, where it is also tender, plants are 1 dollar each.

■ 29. *C. LAUROCÉRASI'S Lois.* The Laurel Cherry, or common Laurel.

Identification. Lois in N. Du Ham., 5. p. 6.; Dec. Prod., 2. p. 540.; Don's Mill., 2. p. 516.

Synonymes. Prunus Laurocerasus Lin. Sp., 678.; Cherry Bay, Cherry Laurel; Laurier au Lait, Laurier Cerisier, Laurier Amandier, Fr.; Kirsche Lorbeer, Ger.

Engravings. Blackw. Herb., t. 512.; Du Ham. Arb., 1. p. 346. t. 133.; and our fig. 422.

Spec. Char., &c. Evergreen. Leaves coriaceous, ovate-lanceolate, remotely serrate, bearing upon the under surface of the disk 2—4 glands. Racemes shorter than the leaves. Fruit ovate-acute. Brought from Trebisond, in Asia Minor, into Europe, in 1576. (*Dec. Prod.*, ii. p. 540.)

Varieties.

■ *C. L.* 2 *variegata* Hort.—Leaves variegated with either white or yellow.

■ *C. L.* 3 *angustifolia* Hort., with leaves about a third part of the width of those of the species, and a more dwarf-growing plant. A very distinct variety, which seldom, if ever, flowers. In some nurseries, it is called *Hartògia capensis*, though this latter is a totally different plant. (See p. 495. and p. 504.)

Description. The common laurel, though it will grow as high as the Portugal laurel, is, in its habit, decidedly a shrub. It is known at once from all the other species of the genus by the largeness of its smooth, yellowish green, shining leaves, which in colour resemble those of the common orange; and in both colour and magnitude, and somewhat, also, in form, those of the broad-leaved variety of *Magnòlia grandiflora*. The young shoots, and petioles of the leaves, are of a pale green, which is not the case with the young shoots



of any other species of the genus. The growth of the common laurel is rapid for an evergreen, being at the rate of from 1 ft. to 3 ft. a year; but, as the shoots extend in length, they do not increase proportionately in thickness, and hence they recline; so that plants with branches 30 ft. or 40 ft. in length, though gigantic in size, still retain the character of prostrate shrubs. In England it flowers in April and May, and ripens its fruit in October. Notwithstanding the rapid and vigorous growth of this plant in ordinary seasons, it suffers a great deal more from very severe frosts than the Portugal laurel, and is sometimes killed down to the ground, which the latter never is in England.

Geography, History, &c. The common laurel is found wild in woody and subalpine regions in Caucasus, on the mountains of Persia, and in the Crimea, where, according to Pallas, it forms a large evergreen shrub, flowering in April. It was first received by Clusius, at the beginning of the year 1576, from David Ungnad (then ambassador from the Emperor of Germany to Constantinople), with some other rare trees and shrubs; which all perished by the severity of the winter, and the carelessness of those who brought them, except this plant and a horsechestnut. It was sent by the name of *Trabison curmàsi*, or the date, or plum, of Trebisond, a city of Asia Minor, on the Black Sea. Clusius relates that the plant of laurel was almost dead when it arrived; but he put it into a stove exactly as it came, in the same tub, and with the same earth. In the April following he took it out, cut off all the dead and withered branches, and set it in a shady place. In the autumn it began to push from the root; he then removed the living part into another tub, and took great care of it. When it was advanced in growth, he laid down the branches, which took root, and he distributed the plants which he thus raised among his friends and men of eminence. Such was the origin, in Europe, of a shrub now become so common every where. Clusius's plant died without flowering; but another, which he gave to Aicholtz, flowered in May, 1583; and a few years afterwards it flowered with Joachim Camerarius, at Nuremberg. Parkinson, in his *Paradisus*, published in 1629, says he had a plant of the bay cherry, as he calls it, by the friendly gift of Master James Cole, a merchant of London, then lately deceased; a great lover of all rarities, who had it growing with him at his country-house in Highgate, where it had flowered divers times, and borne ripe fruit also. He describes Master Cole's "as a fair tree," which he defended from the bitterness of the weather by casting a blanket over the top thereof every year, thereby the better to preserve it. In the first edition of Gerard's *Herbal*, published in 1597, the laurel is not mentioned; but in the appendix to Johnson's enlarged edition, published in 1633, it is said that the cherry bay "is now got into many of our choicest English gardens, where it is well respected for the beauty of the leaves, and their lasting, or continuall, greenness." Evelyn, in the 1st edition of his *Sylva*, published in 1664, says that "this rare tree was first brought from Città Vecchia, in 1614, by the Countess of Arundel, wife to that illustrious patron of arts and antiquities, Thomas Earl of Arundel and Surrey," to whom this country is indebted for the possession of the Arundelian marbles. Evelyn adds that he cannot easily assent to this tradition, though he had it from "a noble lord;" thinking it "more likely that it came from some colder clime." By the *History of the Arundel Family*, it appears that the Countess of Arundel set out to Italy in 1614, for the purpose of accompanying her two sons to England; and, as there are an immense number of very old laurels at Wardour Castle, the present seat of the family, it is probable that the tradition is correct; though the plant may also have been introduced by some other person. Ray, in 1688, relates that it was first brought from Trebisond to Constantinople; thence to Italy, France, Germany, and to England, where it was very common in gardens and shrubberies; that it increased, flowered, and fruited very well; was very patient of cold, and braved our winters, even in exposed situations; "that it roots easily, grows quick, and in a short time becomes a tree of tolerable size; but that it is not fitted for topiary work, on account of its thick and woody branches," &c. (*Hist.*,

p. 1550.) Miller, in 1752, says, "In warmer countries, this tree will grow to a large size; so that in some parts of Italy there are large woods of them; but we cannot hope to have them grow to so large stems in England; for, should these trees be pruned up, in order to form them into stems, the frost would then become much more hurtful to them than in the manner they usually grow, with their branches close to the ground: however, if these trees are planted pretty close together, in large thickets, and permitted to grow rude, they will defend each other from the frost, and they will grow to a considerable height; an instance of which is now in that noble plantation of evergreen trees made by His Grace the Duke of Bedford at Woburn Abbey, where there is a considerable hill entirely covered with laurels; and in the other parts of the same plantations there are a great number of these intermixed with the other evergreen trees, where they are already grown to a considerable size, and make a noble appearance." (*Dict.*, 6th edit., art. *Pà-dus*.) Bradley mentions that the common laurel was grafted on the cherry, and on the plum, in Mr. Whitmill's garden at Hoxton; and this practice is frequent among the Parisian gardeners; but the plants, especially when grafted standard high, never live more than a year or two. It is a remarkable fact, that the three shrubs, or trees, which constitute the principal evergreens of the London gardens, and which are to be found in every garden, large or small, without exception, viz. the holly, the common laurel, and the Portugal laurel, are found to be rather delicate in the neighbourhood of Paris; and hence the suburban gardens of that city are totally destitute of broad-leaved evergreens, and have a naked and cold appearance in the winter season, which is particularly and strikingly unpleasant to eyes accustomed to the clothed and cheerful aspect of our English gardens at that season. The same observations will apply to the gardens in Germany, Holland, and Belgium; in which latter country, though holly hedges have been formed in some places, yet, in severe winters, they are liable, in common with laurels and all our other broad-leaved evergreens, to be killed down to the ground. (*Les Agrémens de la Campagne*, &c., p. 205.)

Properties and Uses. In Britain, the common laurel is considered one of the most ornamental of our evergreen shrubs; and it is also used for covering walls, and for hedges, to afford shelter; for which last purpose it is extensively used in the market-gardens about Isleworth. Evelyn mentions a fine hedge, planted alternately with the variegated and the common laurel, and trained so as to have a chequered appearance, white and green; which, according to the taste of his time, was reckoned to have a splendid effect, though the variegation of this shrub is very irregular, not constant, and attended, in general, by mutilated leaves. He also says it may be trained so as to resemble the most beautiful headed orange tree in shape and verdure, and prognosticates that, in time, it may emulate some of our lofty timber trees, and be proper for walks and avenues. Cook, also, says that it is "a glorious tree for standards;" but we need only refer to what Miller says on the subject (see above), to show that these two authors were mistaken. The most general use of the common laurel, at present, is as an undergrowth in ornamental woods; and for this purpose it is employed, on an extensive scale, at Claremont, at Bagshot Park, at Stourhead, at Wardour Castle, at Woburn Abbey, and at a number of other places. At Claremont, the laurels are mixed with holly and box trees, which are allowed to grow up as standards, while the laurels are kept low. The effect of this, more especially in the winter season, is delightful, particularly on the sunny sides of the wooded banks. It is easy, while walking through these woods, to mistake midwinter for early spring. In the woods at Stourhead, the laurel undergrowths are unmixed with any other tree or shrub, except large beech trees; and the effect of a mass of shining evergreens beneath these lofty beeches, though powerful, is yet extremely monotonous. At Wardour Castle, the laurels grow among a mixed assemblage of trees and shrubs: they are cut down periodically; and they are found to make excellent fuel and fence-wood. Laurel leaves have a bitter

taste, and the peculiar flavour of prussic acid, which is common to bitter almonds, and to the kernels generally of the *Amygdalææ*. The flowers have a similar flavour; and the powdered leaves excite sneezing. The leaves, in consequence of their flavour, are used in a green state in custards, puddings, blanchmange, and other culinary and confectionery articles, but always in very small quantities. The distilled water from these leaves is a virulent poison; and the case of Sir Theodosius Boughton, who was poisoned by it in 1780, by his brother-in-law, Captain Donaldson, who was executed for the murder, is well known. On brutes the effect of laurel water is almost instantaneous. The case of Sir Theodosius Boughton, which was the subject of universal conversation at the time it occurred, Professor Burnet observes, "has rendered the poisonous properties of laurel water familiar to every one; and the fear it excited has unnecessarily extended the evil character of the leaves to the fruit, which is harmless, and, although not pleasant, is in some places made into puddings." Fortunately, the poison of the laurel, and of all the *Amygdalææ*, being prussic acid, the smell of that article is now so well known, and it is so difficult to be disguised, that few persons making use of it for illegal purposes can hope to escape detection. In France, the laurel is frequently planted in tubs, and trained in imitation of orange trees; and in London, the commencement of the orange season is announced at some of the shops dealing in that fruit, by a branch of laurel being affixed to the door, stuck all over with oranges, to imitate an orange tree covered with ripe fruit.

Soil, Situation, &c. Any soil tolerably dry will suit the common laurel; but, to thrive, it requires a sheltered situation, and a deep free soil. It thrives better as an undergrowth than, perhaps, any other ligneous plant, with the exception of the box and the holly. When treated in this manner, it requires to be cut down occasionally, or to have its branches pegged down to the ground, in order to insure a constant supply of young shoots from them; otherwise the plants are apt to become naked below. As it ripens seeds almost every year, in the neighbourhood of London, it might readily be propagated by them; but the most rapid, and the most common, mode is, by cuttings of the summer's shoots, taken off in autumn, with a small portion of the last year's wood, and planted in sandy soil in a shady border. These will root the following spring, and make good plants by next autumn. It is also propagated by layers; and, in the French nurseries, by grafting on the common wild cherry; but such plants, unless the graft is made on the root, are of very short duration. We are not aware that any attempt has been made to fertilise flowers of this species with those of the Portugal laurel, or of the Carolina bird cherry, though, perhaps, something worth the trouble might be obtained by so doing.

Statistics. There are large plants of the common laurel, drawn up among other trees, in almost all the old places in the neighbourhood of London. At Syon, at Claremont, and in the arboretum at Kew, there are straggling stems, 20 ft. to 30 ft. in height; but we are not aware of there being any detached bushes of this species, in the neighbourhood of London, to be compared with those to be found in some places in Scotland and Ireland. In Scotland, in Angusshire, at Kinnaird Castle, the common laurel, 20 years planted, is 15 ft. high, the diameter of the head 36 ft. In Argylshire, at Minward, 31 ft. high, the diameter of the head 56 ft., and of the trunk 6 ft. 9 in., the trunk branching off at 2½ ft. from the ground; another tree, at the same place, has a trunk which girths 4 ft. 11 in.; both trees are supposed to have been planted upwards of 130 years. In Stirlingshire, at Airthrie Castle, 43 years planted, it is 42 ft. high, with a trunk 2 ft. in diameter, and the diameter of the head 37 ft.; at West Plean, 24 years planted, it is 20 ft. high, the diameter of the trunk 10 in., and of the head 17 ft. In Ireland, in Tipperary, in the Clonmel Nursery, 25 years planted, it is 25 ft. high, and the diameter of the space covered by the branches is 60 ft. In Wicklow, at Shelton Abbey, 90 years planted, it is 45 ft. high, the diameter of the trunk is 6 ft., and of the head 101 ft. The head is oval, and is supported by a conglomeration of branches, which unite about 1½ ft. from the ground. It stands in a light loamy soil, on a substratum of shingle. There can be little doubt that this is the largest common laurel in the world. In 1825, this tree was measured by Mr. Mackay of the Trinity College Botanic Garden at Dublin, when it was found 24 ft. high, and the head 224 ft. 6 in. in circumference (*Dub. Phil. Journ.*, vol. i. p. 439.); so that, if the dimensions taken by Mr. Mackay, and those sent to us, are both correct, the rate of increase of this tree must be no less remarkable than its magnitude.

Commercial Statistics. Price of plants, in the London nurseries, 1 ft. high, 8s. per 100; and from 2 ft. to 3 ft. high, 16s. per 100: at Bollwyller, where it is marked in the catalogue as requiring to be protected through the winter, 1 franc 50 cents: and at New York, where it is also tender, 1 dollar.

‡ 30. *C. CAROLINIANA* Michx. The Carolina Bird Cherry Tree.

Identification. Michx. Fl. Bor. Amer., 1. p. 285.; Lois. in N. Du Ham., 5. p. 5.; Don's Mill., 2. p. 516.

Synonymes. *Prunus caroliniana* Ait. Hort. Kew., 2. p. 163.; *P. sempervirens* Willd. Enum.; *Párus caroliniana* Mill. Dict., No. 6.; Wild Orange, Amer.

Engravings. Michx. Arb. d'Amér., 3. t. 7.; and our fig. 423.

Spec. Char., &c. Evergreen. Leaves, with the petiole short; and the disk lanceolate-oblong, mucronate, even, rather coriaceous, mostly entire. Flowers densely disposed in axillary racemes, that are shorter than the leaves. Fruit nearly globose, mucronate. (*Dec. Prod.*, ii. p. 540.) An evergreen tree, of the middle size, a native of North America, from Carolina to Florida; introduced in 1759, and forming rather a tender evergreen shrub in British gardens.

Description, &c. In its native country, this tree, according to Michaux, grows to the height of 20 ft. or 30 ft., and ramifies at a short distance from the ground, forming a tufted head. The bark of the trunk is of a dun colour, and is commonly without cracks. The leaves are smooth, shining on their upper surfaces, and about 3 in. long. The flowers, which open in May, are white and numerous, being arranged in little bunches 1 in. or 1½ in. long, which spring from the axil of the leaf. The fruit is small, oval, and nearly black: it consists of a soft stone, surrounded by a small quantity of green pulpy substance, which is not eatable. The fruit hangs on during the greater part of the following year, so that the tree is at the same time laden with fruit and flowers. These flowers, Michaux remarks, are, of all others which he has observed in Carolina and Georgia, the most sought after by bees. The tree, he adds, may be considered as one of the most beautiful vegetable productions of the southern parts of the United States; and it is generally selected by the inhabitants to plant near their houses, not only on this account, but because it grows with rapidity, and affords an impenetrable shade. Pursh describes it as a handsome evergreen shrub, resembling *C. lusitánica*; but he says nothing of the flowers, which, from the figure in Michaux, from which ours was copied, appear to be almost without petals.

Geography, History, &c. This tree is found in the Bahama Islands; and in North America it appears to be confined to the islands which are on the coast of the two Carolinas, Georgia, and the two Floridas. On the mainland it is seldom found growing wild, even at 8 or 10 miles' distance from the sea. It was first made known to Europeans by Catesby; and the seeds were sent to Miller in 1759, under the name of bastard mahogany. Seeds of it are frequently imported from America, and abundance of young plants reared; but, as they are rather tender, and, north of London, would require the protection of a wall, they are very seldom seen in British gardens. The largest plant which we know of is in Hampshire, at Swallowfield, where, in 1833, it formed a bush 10 ft. high, with a head about 12 ft. in diameter, flowering and fruiting occasionally.

Properties and Uses. The wood is rose-coloured, and of a very fine grain; but, even in America, it is too scarce to be applied to useful purposes; the tree being there, as here, considered entirely as one of ornament. The bark of the roots smells strongly of prussic acid; and from it, Michaux observes, a fragrant spirituous liquor may be obtained.

423



Soil, Situation, &c. A deep, free, dry soil, and a sheltered situation, are essential to this species; which, north of London, as already observed, will be safest placed against a wall, or, probably, grafted on the Portugal laurel. In the London nurseries, it is propagated from seeds; and plants, of which there are now (1836) abundance in the Fulham, Epsom, and Milford Nurseries, are 1s. 6d. each.

App. i. *Other Species of Cerasus.*

In De Candolle's *Prodromus*, and in Don's *Miller*, two West Indian, and four South American, species are described; but only two of these (*C. sphaerocarpa* Loïs., *P. sphaerocarpa* Swartz, *Don's Mill.*, ii. p. 516.; and *C. occidentalis* Loïs., and *Don's Mill.*, ii. p. 516., *P. occidentalis* Swartz) have been introduced into Britain. They are both considered hot-house plants, but might, probably, be acclimatised. Rafinesque, under the article *Prunus*, in his *Medical Flora*, vol. ii. p. 433., says that he has prepared a monograph of 40 wild American species of *Prunus*; under which genus, with *Linnaeus*, he includes both plums and cherries; only 25 of which, he says, are described by authors: but we are not aware that any work of this description has been published.

Sect. II. SPIRÆÆ.

GENUS VI.



PURSHIA Dec. THE PURSHIA. *Lin. Syst.* Icosándria Monogýnia.

Identification. Dec. in *Trans. of Lin. Soc.*, 12. p. 157.; *Prod.*, 2. p. 541.; *Lindl. in Bot. Reg.*, t. 1446.; *Don's Mill.*, 2. p. 517.

Synonyme. *Tigárea* Ph. Fl. Amer. Sept., 1. p. 33., not of Aublet.

Derivation. *Frederick Pursh* first characterised the only known species in his *Flora Americae Septentrionalis*, and named it *Tigárea tridentata*. The generic name, however, having been preoccupied by Aublet, De Candolle has named the present genus after Pursh himself.

♣ I. P. TRIDENTATA Dec. The 3-toothed-leaved Purshia.

Identification. Dec. in *Lin. Trans.*, 12. p. 157.; *Prod.*, 2. p. 541.

Synonyme. *Tigárea tridentata* Ph. Fl. Amer. Sept., 1. p. 33. t. 15., not of Aublet.

Engravings. Ph. Fl. Am. Sept., t. 15.; *Bot. Reg.*, t. 1446.; and our *figs.* 424, 425.

Description, &c. A spreading subdecumbent shrub, scarcely exceeding 2 ft. in height, with numerous branches, small whitish leaves, and rather many



small yellow flowers, which begin to expand about the middle of May, and thence continue, successively, into June. The leaves are grouped, wedge-shaped, and ending in 2—3 teeth that are large for the size of the leaf, villose above, but covered beneath with a white tomentum. Buds scaly. Stipules none, or minute. (*Dec. Prod.*, ii. p. 541., and amplified from observation.)



A native of North America, in pastures by the river Columbia. It was almost the only shrub to be seen through an immense tract of barren sandy soil, from the head source of the Missouri, to the Falls on the Columbia, and from 38° to 48° N. lat. (*Douglas*, in *Hook. Bor. Amer.*) It was introduced in 1826. There are plants of this species, in the garden of the London Horticultural Society, about 2 ft. or 3 ft. high, which flower freely every year. They require a dry light soil; and cuttings of the young wood will root in sand under a hand-glass. Plants, in the London nurseries, not being much asked for, are 2s. 6d. each.

GENUS VII.

KERRIA Dec. THE KERRIA. *Lin. Syst. Icosándria Polygýnia.*

Identification. Dec. in Trans. of Lin. Soc., 12. p. 156.; Prod., 2. p. 541.; Don's Mill., 2. p. 517.

Synonymes. *Rúbus L.*, *Córchorus Thunb.*, *Spiræa Camb.*

Derivation. Named in honour of *W. Ker*, a collector of plants for the Kew Gardens.

§ 1. K. JAPÓNICA Dec. The Japan Kerria.

Identification. Dec. in Trans. of Lin. Soc., 12. p. 156.; Prod. 2. p. 541.

Synonymes. *Rúbus japonicus Lin. Mant.*, 245.; *Córchorus japonicus Thunb. Fl. Jap.*, 227., *Bot. Rep.*, t. 587., *Bot. Mag.*, t. 1296.; *Spiræa japonica Camb. Ann. Sci. Nat.*, 1. p. 389.; *Spirée du Japon, Fr.*

Engravings. *Bot. Rep.*, t. 587.; *Bot. Mag.*, t. 1296.; and our *fig.* 426.

Description, &c. A shrub, a native of Japan, introduced in 1700, and for a long time treated as a stove, and afterwards as a green-house, plant; but it has been ultimately found quite hardy. It has soft, and not very persistent, wood, clothed with a smooth greenish bark; twig-like branches; leaves that are ovate-lanceolate, and serrated with large and unequal teeth, feather-veined, and concave on the upper surface; stipules that are linear-subulate; and yellow flowers. The single-flowered state of this species has only lately been introduced; and

426



it flowered, for the first time in England, in the Chelsea Botanic Garden, in April, 1836. The double-flowered variety has become so common as to be found in the gardens even of labourers' cottages. It is a most ornamental and beautiful shrub, from its very numerous, large, golden, sub-globular blossoms, which begin to appear in February or March, and, in tolerably moist soil, and a warm situation, continue to be produced for several months. It is generally planted against a wall, more especially north of London. It is easily and rapidly propagated by its sprouting suckers. Plants, in the London nurseries, are 50s. per 100; at Bollwyller, it is 10 francs per 100; and at New York, 50 cents each.

GENUS VIII.

SPIRÆA L. THE SPIRÆA. *Lin. Syst. Icosándria Di-Pentagýnia.*

Identification. *Lin. Gen.*, No. 630.; *Gærtn. Fruct.*, 1. p. 337. t. 69.; *Dec. Prod.*, 2. p. 541.; *Don's Mill.*, 2. p. 517.

Synonymes. *Spiræa* sp. *Cambessedes Mon. Spir.* in *Ann. Sci. Nat.*, 1. p. 227.; *Spirée, Fr.*; *Spierstaude, Ger.*

Derivation. From *spira*, a cord, in reference to the supposed flexibility of the branches of some of the species; or, according to some, from *spiraō*, to wreath; in allusion to the fitness of the flowers to be twisted into garlands. *Spiræon* is Pliny's name for a plant the blossoms of which were used, in his time, for making garlands; but that plant is thought by some to have been the *Ibórnum Lantána*.

Description, &c. Low deciduous shrubs, with conspicuous flowers of considerable elegance and beauty. They are all readily propagated by suckers, which, in general, they produce in abundance. They will grow in any common soil; and the price of most of the sorts, in the London nurseries, is from 1s. to 1s. 6d. each, or from 50s. to 75s. per hundred; at Bollwyller, from 50 cents

to 1 franc each; and at New York, from 25 cents to 50 cents each. Seeds of one or two of the species may be procured, in London, at 6d. per packet.

§ i. *Physocárpos* Camb.

Derivation. From *phusa*, a bladder, and *karpos*, a fruit; in reference to the bladdery carpels.

Seet. Char. Ovaries connected at the base. Torus lining the calycine tube.

Carpels bladdery, rather membranous. Ovula 2—3, fixed to the seminiferous margin of the carpel, ovoid, at first horizontal, but at length suspended. Flowers hermaphrodite, disposed in umbels. Pedicels 1-flowered. Leaves toothed, or somewhat lobed, usually stipulate. (*Don's Mill.*, ii. p. 517.)

☞ 1. *S. OPULIFOLIA* L. The Guelder-Rose-leaved Spiræa, or Virginian Guelder Rose.

Identification. Lin. Sp., 702.; Camb. Mon.; Lois. in N. Du Ham., 6. p. 61. f. Dec. Prod., 2. 542.; Don's Mill., 2. p. 517.

Synonyme. Nine Bark, Amer.

Engravings. N. Du Ham., 6. t. 14.; and our figs. 427, 428.

Spec. Char., &c. Leaves lobed, or 3-lobed, and partaking of an ovate figure, doubly serrated, petioled, and many of them stipuled. Flowers white, numerous, disposed in stalked hemispherical corymbs; the pedicel of each flower slender and glabrous. Sepals spreading. Torus wholly connate with the tube of the calyx. Ovaries connate with each other at the base. Ovules in each 2—3, affixed to the margin, egg-shaped, at first horizontal, at length the one pendulous, the rest ascending. Carpels bladdery, rather membranaceous, large and diverging. Seeds obovate, glossy, and yellow. (*Dec. Prod.*, ii. p. 542.) A shrub, a native of North America, from Canada to Carolina; found on the banks



of rivers, particularly among the mountains, where it is generally known by the name of Nine Bark. It was introduced by Bishop Compton, in 1690; and, in British gardens, grows to the height of 8 ft. or 10 ft., flowering in June and July. It is hardy, and very ornamental, from its abundance of white flowers, which are produced in corymbs, and resemble those of the Guelder rose; and from the numerous inflated reddish capsules which succeed the flowers. The leaves, which are lobed and veined, die off of a purplish red mixed with yellow. In British nurseries, the plant is generally propagated by division of the root; but sometimes by layers, or by cuttings of the young wood put, in autumn, in a shady border, in a sandy soil.

Variety.

☞ *S. o. 2 tomentella* Ser. has the peduncles and calyx tomentose. (*Dec. Prod.*, ii. p. 542.) It is found at the Grand Rapids of the Columbia river.

☞ 2. *S. CAPITATA* Ph. The capitate-corymbed Spiræa.

Identification. Ph. Fl. Amer. Sept., 1. p. 342.; Camb. Monog.; Dec. Prod., 2. p. 542.; Don's Mill., ii. p. 518.

Synonyme. *S. opulifolia* var. Hook.

Spec. Char., &c. Leaves ovate, doubly toothed, almost lobed; beneath reticulate and tomentose. Flowers disposed in terminal subcapitate corymbs placed on very long peduncles. Calyx tomentose. Spontaneous in North America, on its eastern coast, and by the river Columbia. (*Dec. Prod.*, ii. p. 542.) According to Sweet's *Hortus Britannicus*, ed. 1830, p. 194., this was introduced into Britain in 1827. It has white flowers, and has produced them here in June and July. We have not seen the plant.

☞ 3. *S. MONO'GYNA* Torrey. The monogynous Spiræa.

A shrub growing to the height of 3 ft. or 4 ft. on the Rocky Mountains. (*Don's Mill.*, ii. p. 518.) No yet introduced.

§ ii. *Chamædryon* Ser.

Derivation. From *Chamædryis*, the name of the germander; from a similarity in the form of the leaves.

Sect. Char. Ovaries distinct. Torus with its base connate with the tube of the calyx, but with its tip separate. Carpels not inflated. Flowers each upon a distinct pedicel, and disposed in umbels or corymbs. Leaves entire, or toothed, without stipules. (*Dec. Prod.*, ii. p. 542.)

♣ 4. *S. CHAMÆDRIFO'LIA* L. The Germander-leaved Spiræa.

Identification. Lin. Sp., 701.; Camb. Monog.; Dec. Prod., 2. p. 542.; Don's Mill., 2. p. 518.

Synonymy. *S. cantoniensis* Lour.

Engravings. Pall. Fl. Ross., t. 15.; and our fig. 429.

Spec. Char., &c. Leaves ovate, cut at the tip in a serrated manner, glabrous. Flowers upon long slender pedicels, in hemispherical corymbs. Sepals veiny, reflexed. (*Dec. Prod.*, ii. p. 542.)

Varieties. Seringe enumerates the first four of the following forms of this species; to which, we think, might be added *S. ulmifolia*, *S. flexuosa*, *S. cratægifolia*, *S. betulæfolia*, and, perhaps, some others.

♣ *S. c.* 1 *vulgâris* Camb. Monog. — Leaves with the disks broad and glabrous; the petioles ciliated.

♣ *S. c.* 2 *mèdia* Ph. Fl. Amer. Sept., i. p. 342., Camb. Monog. — Leaves smaller, slightly villose upon both surfaces. Flowers smaller. Wild in Canada, and upon the rocks of Dauria.

♣ *S. c.* 3 *oblongifolia* Camb. Monog.; *S. oblongifolia* Waldst. et Kit. Pl. Hung., iii. p. 261. t. 235., and in *Hort. Brit.* — Leaves narrower, and less serrated.

♣ *S. c.* 4 *subracemosa* Ser. — Flowers distantly disposed along a lengthened rachis.

♣ *S. c.* 5 *incisa* Hort. (? *S. incisa* Thunb.) has been raised from seeds received from Germany through Mr. Hunneman; and it appears to be only a variety of this species.

Description, &c. A shrub, varying in height from 2 ft. to 6 ft., or more; a native of Siberia, Kamtschatka, Dauria, the north-west coast of America, and also of China and Japan. It is common throughout the whole of Siberia, Dauria, and Kamtschatka; and, in the latter country, the leaves are used as a substitute for tea; and the shoots, when straight, are bored for tobacco-pipes. It was introduced into England in 1789, under different names; and its numerous varieties have, we believe, given rise to several supposed species. In its wild state, it varies exceedingly in the magnitude of the entire plant, in the largeness or smallness of its leaves, and in their being more or less cut or serrated, and more or less smooth, or pubescent. In British gardens, it is a very ornamental hardy shrub, producing its corymbs of white flowers, which are tolerably large, in June and July; and they are succeeded by capsules, the seeds enclosed in which are grey and small, resembling sawdust. In Martyn's *Miller* it is stated, that this shrub makes beautiful garden hedges, being entirely covered with its white flowers in June. Though the seeds ripen in England, plants can seldom be raised from them; and, as this species does not produce suckers freely, it is generally raised by layers or cuttings.

429



♣ 5. *S. (C.) ULMIFO'LIA* Scop. The Elm-leaved Spiræa.

Identification. Scop. Fl. Carn., ed. 2. v. 1. p. 349.; Camb. Monog.; Lois. in N. Du Ham., 6. p. 4.; Dec. Prod., 2. p. 542.; Don's Mill., 2. 518.

Synonymy. *S. chamædrifolia* Jacq. Hort. Vindob., t. 140., Lindl. in Bot. Reg., t. 829.

Engravings. Scop. Fl. Carn., ed. 2. v. 1. t. 22.; N. Du Ham., 6. t. 13.; Jacq. Hort. Vindob., t. 140., as *S. chamædrifolia*; Bot. Reg., t. 1222.; Bot. Cab., 1042.; and our fig. 430.

Spec. Char., &c. Leaves ovate-lanceolate, acute, flat, sharply serrated, ciliated. Flowers terminal, in rather hemispherical corymbs. Sepals reflexed. A native of Carinthia and Siberia. (*Dec. Prod.*, ii. p. 542.) Introduced in 1790, and producing its white flowers in June and July. Height from 3 ft. to 5 ft. It is one of the handsomest species of this section. Seringe asks if it is not a variety of *S. chamædrifolia* L.; and Dr. Lindley (*Bot. Reg.*, t. 829.) appears to consider it as identical with that species.

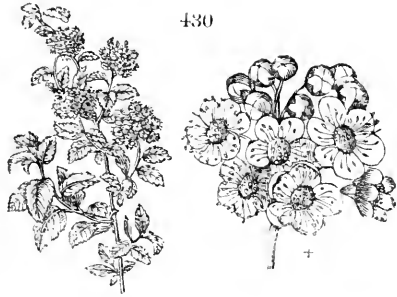

Variety.

♣ *S.* (c.) u. 2 *phyllantha* Ser.—In this variety a whorl of distinct leaves, that are petioled, lanceolate, and sharply serrated, occupies the place of the sepals, and is described as being these transformed. Petals and stamens are either not present, or deformed. Seringe appears to think the *S. foliosa* Poir. *Dict.*, 7. p. 553., is identical with this. (*Dec. Prod.*, ii. p. 542.)

♣ 6. *S.* (c.) *FLEXUOSA* Fisch. The flexible-branched *Spiræa*.

Identification. Fisch. in Litt.; Camb. Monog.; Dec. Prod., 2. p. 542.; Don's Mill., 2. p. 518.
Synonymæ. *S. alpina* Hort. Par., according to Camb. and Fisch. in Litt.
Engraving. Camb. Monog. Spir. in Ann. Sci. Nat., 1. t. 36.

Spec. Char., &c. Leaves lanceolate, glabrous; from the tip to the middle dentately serrate. Flowers in corymbs. Its native country is not stated. Seringe enquires if it is not a variety of *S. ulmifolia*. (*Dec. Prod.*, ii. p. 542.) Introduced in 1820; growing to the height of from 4 ft. to 6 ft.; and producing its white flowers in June and July. There are plants in the Horticultural Society's Garden, and at Messrs. Loddiges's.

♣ 7. *S.* (c.) *CRATÆGIFOLIA* Lk. The *Cratægus*-leaved *Spiræa*.

Identification. Lk. Enum., 2. p. 40.; Dec. Prod., 2. p. 546.; Don's Mill., 2. p. 518.
Spec. Char., &c. Leaves obovate, obtuse; in the terminal part doubly serrate; glabrous, reticulate on the under surface. Flowers white, disposed in terminal compound corymbs, whose composite parts are rather capitate. It is not stated of what country this kind is a native. (*Dec. Prod.*, ii. p. 546.) Introduced in 1823, and producing its white flowers in June and July. It grows to the height of from 4 ft. to 6 ft. There is a plant in the Horticultural Society's Garden.

♣ 8. *S.* (c.) *BETULIFOLIA* Pall. The Birch-leaved *Spiræa*.

Identification. Pall. Fl. Ross., 1. p. 75. t. 16.; Camb. Monog.; Dec. Prod., 2. p. 544.; Don's Mill., 2. p. 519.
Synonymes. ? *S. corymbosa* Raf. in *Desv. Journ. Bot.*, 4. p. 269.; ? *S. cratægifolia* Lk. Enum., 2. p. 40.
Engravings. Pall. Fl. Ross., 1. t. 16.

Spec. Char., &c. Leaves broadly ovate, serrated, glabrous; the petiole very short. Flowers in fastigate panicles. Carpels 5, upright, glabrous. A native of Siberia. (*Dec. Prod.*, ii. p. 544.) Said, also, to be found in North America, on the Blue Mountains, and in various other places on the western coast. (*Hook. Fl. Bor. Amer.*) It was introduced into England in 1812, and produces its whitish flowers in June and July.

♣ 9. *S.* *CANA* Waldst. et Kit. The hoary-leaved *Spiræa*.

Identification. Waldst. et Kit. Pl. Rar. Hung., 3. p. 252. t. 227.; Camb. Monog.; Dec. Prod., 2. p. 542.; Don's Mill., 2. p. 518.
Engravings. Waldst. et Kit. Pl. Rar. Hung., 3. t. 227.

Spec. Char., &c. Leaf ovate, of about the size of that of *Sâlix repens* or *S. argentea*, acute, perfectly entire, or slightly toothed, hoarily villose. Corymbs somewhat racemose; the lateral ones peduncled, of few flowers, and lax. Sepals spreading. Styles thick. Carpels divergent, rather villose. A native of the steep and high rocks of Croatia. (*Dec. Prod.*, ii. p. 543.) Introduced in 1825; said to grow to the height of 2 ft., and to flower in June and July. We have not seen the plant.

♣ 10. *S.* *TRILOBATA* L. The 3-lobed-leaved *Spiræa*.

Identification. Lin. Mant., 244.; Camb. Monog.; Dec. Prod., 2. p. 543.
Synonymæ. *S. triloba* Don's Mill., 2. p. 518.
Engravings. Pall. Ross., 1. t. 17.; Wats. Dend. Brit., t. 68., as *S. triloba*; and our *fig.* 431.

Spec. Char., &c. Leaves roundish, lobed, crenated, glabrous, reticulately veined. Flowers in umbel-like corymbs. Sepals ascending. Carpels glabrous. A native of the alps of Altai. (*Dec. Prod.*, ii. p. 543.) Introduced in 1801; growing to the height of 1 ft. or 2 ft.; and producing its abundant flowers in May. This species is very handsome, with branches spreading horizontally, and bearing, in the flowering season, numerous compact corymbs of pure white flowers; which, combined with the neat appearance of the plant, and its glaucous leaves, rounded in their outline, and yet lobed, render the species a very interesting and ornamental one.



431

❖ 11. *S. ALPINA* Pall. The Siberian alpine Spiræa.

Identification. Pall. Fl. Ross., 1. p. 82. t. 20., according to Camb. Monog.; Dec. Prod., 2. p. 543.; Don's Mill., 2. p. 518.

Engravings. Pall. Fl. Ross., 1. t. 20.; and our fig. 432.

Spec. Char., &c. Leaves lanceolate-oblong, sessile, serrulated, glabrous; the midrib pinnately branched. Flowers in terminal, stalked, and, in many instances, leafless, corymbs. Sepals ascending. (*Dec. Prod.*, ii. p. 543.) A native of the wooded alps of Siberia; introduced in 1806; growing to the height of from 4 ft. to 6 ft.; and flowering in June. Its flowers are white.



432

Remark. A kind of Spiræa is extant, in some English collections, under the name of *S. alpina*; which must be very distinct from the above, as it has its flowers in lateral umbels, in the mode of *S. hypericifolia*, to which, in its leaf, it also assimilates. It does not resemble that species in being of upright growth; nor is it so tall; but it is dwarfer, and spreadingly branched. Its flowers are produced in April, almost before the leaves, and perhaps earlier than those of any other kind of Spiræa in British collections: they are not white, as those of *S. hypericifolia*, but of a yellowish or greenish white. Plants of this kind were raised from exotic seeds, in the Cambridge Botanic Garden, before 1824.—*J. D.*

❖ 12. *S. HYPERICIFOLIA* Dec. The Hypericum-leaved Spiræa.

Identification. Dec. Fl. Fr., 5. p. 645.; Prod., 2. p. 543.; Don's Mill., 2. p. 519.

Synonyms. *Hypericum frutex Hort.*; Italian May.

Engraving. Our fig. 433.

Spec. Char., &c. Leaves obovate-oblong, 3—4-nerved, entire or toothed, glabrous, slightly downy; primary veins pinnately branched. Flowers in either peduncled corymbs, or sessile umbels. Pedicels glabrous, or slightly downy. Sepals ascending. A native of Europe and America. A species that presents diversified appearances. (*Dec. Prod.*, ii. p. 543.) Supposed by some to be a native of Canada; but Dr. Hooker thinks that, like most of the species of the section to which it belongs, it is only to be found wild in the Old World.



433

Varieties. Seringe has characterised 6 forms of this species, which he describes as follows:—

❖ *S. h.* 1 *uralensis* Ser. *S. crenata* Lin., Fisch. in Litt., and Don's Mill., ii. p. 519.; *S. hypericifolia* Camb. Monog.— Branches rigid, thickish. Leaves ovate-rounded; the whole margin crenated. A native of the Ural Mountains.

❖ *S. h.* 2 *Phukeneßiana* Ser. *S. hypericifolia* Lin. Sp., 701., and Don's Mill.,

ii. p. 519.; *S. h.* var. β , *Dec. Fl. Fr.*, v. p. 645., *Pluk. Phyt.*, t. 218. f. 5. — Leaves perfectly entire, glabrous. Flowers in sessile corymbs. A native of Canada.

- ✧ *S. h.* 3 *acuta* Ser. *S. acutifolia* Willd. *Enum.*, 540., *Camb. Monog.*, and *Don's Mill.*, ii. p. 519.; *S. sibirica Hort. Par.*, according to *Camb. Monog.*; *S. ambigua* Pall., and our fig. 434. — Leaves spatulate, elongate, acute, perfectly entire, or, rarely, 3—5-toothed, rather glabrous. Flowers in sessile corymbs.



- ✧ *S. h.* 4 *crenata* Ser. *S. obovata* Waldst. et Kit. ? in Willd. *Enum.*, 541., *Camb. Monog.*, *Barr. Icon. Rar.*, n. 1376. t. 564.; *S. hypericifolia* γ , *Dec. Fl. Fr.*, v. p. 645.; *S. crenata* *Lin. Sp.*, 701., *Camb. Monog.*, and *Don's Mill.*, ii. p. 519. and our fig. 435. — Leaves obovate.

- ✧ *S. h.* 5 *savranica* Ser. *S. savranica* Besser in Litt., and *Don's Mill.*, ii. p. 519.; *S. crenata* Pall. *Fl. Ross.*, i. p. 35. t. 19.; *S. hypericifolia* var. β *longifolia* Led. *Fl. Ross. Alt. Ill.*, t. 429.; and our fig. 436. — All parts pubescent. Leaves entire, or, at the tip, toothed. Flowers minute, disposed in dense terminal corymbs. It is wild about Barnaoul, and in Podolia.

- ✧ *S. h.* 6 *Besseriàna* Ser. *S. crenata* Besser, in Litt.; *S. savranica* β *Besseriàna* Don's Mill., ii. p. 519., *Lodd. Bot. Cab.*, t. 1252. — All parts rather glabrous. Leaves mostly entire. Flowers disposed in rather lax terminal corymbs. A native of Podolia and Caucasus.

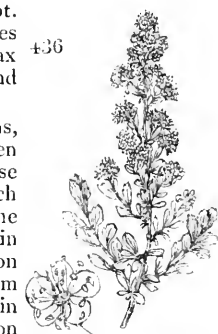

Description, &c. *S. hypericifolia* has small hard stems, with numerous side branches, clothed with a dark green bark, and with numerous wedge-shaped leaves, like those of St. John's wort, with glands in their substance, which give them the appearance of being punctured on the surface; whence the name. The flowers are white, in small sessile umbels, resembling those of the common hawthorn, but smaller; and whence, probably, and from its being common in Italy, and flowering very early in the spring, the name which it once bore in the London gardens, of Italian May. The flowers are produced in great abundance; and, when the shrub is allowed space to expand on every side, it forms a very beautiful bush in the flowering season. In England, it was first cultivated by Parkinson in 1640; and that author and Miller say that it came originally from North America: but Sir James Edward Smith thinks it more likely to be a native of Italy, as he found the hedges full of it between Terni and Foligno. Dr. Hooker, also, thinks it most likely to be a European species; though Pursh appears to have found it in a living state in dry swamps in Canada and New York. It forms handsome garden hedges, and will bear the shears, which were formerly applied to it, to shape it into artificial forms, when topiary work was fashionable in garden scenery. It is readily propagated by layers, or by detaching its suckers.

✧ 13. *S. (H.) THALICTRÖIDES* Pall. The Meadow-Rue-leaved Spiræa.

Identification. Pall. *Fl. Ross.*, 1. p. 54., and p. 78.; *Dec. Prod.*, 2. p. 543.; *Don's Mill.*, 2. p. 518.

Synonymy. *S. aquilegifolia* *Pall. Itin.*, 3. App. 734. No. 94.

Engravings. *Pall. Fl. Ross.*, 1. t. 18.; and our *fig.* 437.

Spec. Char., &c. Leaves obovate, obtuse, indistinctly 3-lobed, inconspicuously 3-nerved, glaucous beneath. Flowers in lateral sessile umbels. A native of the alps of Dahuria. (*Dec. Prod.*, ii. p. 543.) De Candolle asks whether this may not be a variety of *S. hypericifolia*; which, we think, it most probably is. In Martyn's *Miller*, it is said to be an intermediate species between *S. crenata* and *S. triloba*. Pallas says that it is found in Dahuria, along with *S. chamædrifolia* and *S. alpina* (No. 11. p. 726. *fig.* 432.). The name signifies that a leaf of this species of *Spiræa* resembles a leaflet of some kind of *Thalictrium*.



❖ 14. *S. PIKOWIENSIS* *Besser.* The Pikow Spiræa.

Identification. *Besser Enum. Pl. Pod.*, p. 46. No. 1428.; *Dec. Prod.*, 2. p. 543.; *Don's Mill.*, 2. p. 519.

Spec. Char., &c. Leaves with three primary veins, and serrate at the tip, cuneate-lanceolate, obtuse, rarely pointed. Flowers in peduncled corymbs. (*Dec. Prod.*, ii. p. 543.) It is a native about Pikow, in Podolia; and is said to grow from 3 ft. to 4 ft. in height. It produces its white flowers in June and July, and was introduced in 1807, but we have never seen it.

❖ 15. *S. CEANOTHIFOLIA* *Horn.* The Ceanothus-leaved Spiræa.

Identification. *Horn. Hort. Hafn.*, 2. p. 466.; *Dec. Prod.*, 2. p. 544.

Spec. Char., &c. Leaves ovate, rounded at the base, serrated from the middle to the tip with sharp unequal teeth. Flowers in indistinctly peduncled terminal corymbs. (*Dec. Prod.*, ii. p. 544.) A shrub, the native country of which is unknown, which is said to grow to the height of 3 ft. or 4 ft., to have been introduced in 1823, and to produce its white flowers in June and July. We have not seen the plant.

❖ 16. *S. CORYMBO'SA* *Raf.* The corymbose-flowering Spiræa.

Identification. *Rafin. Précis des Découvertes Somnologiques, ou Zoologiques et Botaniques* (Palermo, 1814, p. 36.; and in *Desv. Journ. Bot.*, 1814, p. 168.; *Lodd. Bot. Cab.*, t. 671.; *Dec. Prod.*, 2. p. 544.

Engravings. *Lod. Bot. Cab.*, t. 671.; and our *fig.* 438.

Spec. Char., &c. Leaves oval-oblong, unequally serrated, glabrous, green above, hoary below. Flowers trigynous, disposed in terminal corymbs. (*Dec. Prod.*, ii. p. 544.) A native of Virginia; introduced in 1819; growing to the height of 4 ft. or 5 ft.; and flowering in June and July. This is a very desirable species, on account of its large corymbs of white flowers, and its distinctness in external character.

Variety.

❖ *S. c. 2 soròria*, *S. soròria* *Penny* in *Hort. Brit.*, is a smaller plant, and flowers rather later than the species. It was introduced into the Epsom Nursery, from North America, in 1829. It seldom exceeds the height of 2 ft.; and its white flowers often remain on till October.



❖ 17. *S. VACCINIFOLIA* *D. Don.* The Vaccinium-leaved Spiræa.

Identification. *Don. Prod. Fl. Nep.*, 1. p. 227.; *Dec. Prod.*, 2. p. 546.; *Don's Mill.*, 2. p. 518.

Engravings. *Bot. Cab.*, t. 1403.; and our *fig.* 439.

Spec. Char., &c. Upright. Branchlets hairy. Leaves elliptical, acute, serrated at the tip, glabrous, glaucous on the under surface. Flowers white, disposed in terminal tomentose cymes, a few in a cyme. (*Dec. Prod.*, ii. p. 546.) A native of Nepal; introduced in 1820; growing to the height of 2 ft. or 3 ft.; and producing its white flowers in July and August.



❖ 18. *S. BE'LLA* Sims. The beautiful Spiræa.

Identification. Sims Bot. Mag., t. 2426; Don's Prod. Fl. Nep., p. 227; Dec. Prod., 2. p. 542; Don's Mill., 2. p. 518.

Engravings. Bot. Mag., t. 2426; and our fig. 440.

Spec. Char., &c. Stems erect, branched, glabrous, and reddish. Leaves ovate, acute, sharply serrated, whitishly tomentose on the under surface. Flowers pretty, rose-coloured, and laxly disposed. Lobes of the calyx deflexed. (*Dec. Prod.*, ii. p. 542.) A native of Nepal; resembling, in its mode of growth and foliage, *S. salicifolia*; but being very distinct from that species in its inflorescence; the flowers of *S. salicifolia* being produced in a spiked panicle, and those of *S. bella* in a corymb. It was introduced in 1820, and grows to the height of 3 ft. or 4 ft., producing its beautiful rose-coloured flowers in May and June. This species is as hardy, and as easily propagated, as that very common shrub, *S. salicifolia*; as, like that species, it emits, from under the soil, rooting sprouts, or suckers, which, when their leaves begin to turn yellow, at the end of their season of growth, may be detached, and planted separately, as distinct plants; and it is, at the same time, one of the most beautiful of the genus. No garden, however small, ought to be without it. Plants are 1s. each.

440



§ iii. *Spiræria* Ser.

Sect. Char. Ovaries distinct. Torus with its base connate with the tube of the calyx; its tip separate. Carpels not inflated. Inflorescence a panicle. Leaves serrate, without stipules. (*Dec. Prod.*, ii. p. 544.)

❖ 19. *S. SALICIFO'LIA* L. The Willow-leaved Spiræa.

Identification. Lin. Sp., 700; Camb. Monog.; Dec. Prod., 2. p. 544.

Synonymes. *Spiræa frutex* Hort.; Bridewort, Queen's Needle-work.

Engravings. Gmel. Fl. Sibir., 3. t. 49; Eng. Bot., t. 1468; and our fig. 443.

Spec. Char., &c. Stem and peduncles glabrous. Leaves lanceolate, serrated, and, more or less, doubly so; glabrous. Lobes of the calyx triangular, spreading. Carpels glabrous. (*Dec. Prod.*, ii. p. 544.) A native of Siberia, Tartary, and Bohemia; also of Canada, and, perhaps, of Britain.

Varieties. Seringe has characterised four forms of this species, as follows:—

❖ *S. s. 1 cárnea* Ait. Hort. Kew., ed. iii. p. 254, Camb. Monog., Eng. Bot., t. 1468, and our fig. 443.—Leaves lanceolate. Panicles consisting of racemes more or less spicated. Petals of a flesh colour. Bark of the branches yellowish. This is, by the reference to *Eng. Bot.* cited, the form which is found wild in Britain: whether it be indigenous or not, botanists are not agreed. Professor Henslow has referred it (*Catal. of Brit. Plants*) to his class "Possibly introduced by the Agency of Man."

❖ *S. s. 2 alpestris* Pall. Fl. Ross., i. p. 36. t. 22., Camb. Monog.; *S. alpestris* Don's Mill., ii. p. 519.—A small shrub. Leaves shorter than those of *S. s. cárnea*. Branches very short.

❖ *S. s. 3 paniculata* Willd. Sp., ii. p. 1055., Ait. Hort. Kew., ed. 2. iii. p. 254. *S. álba Ehrh. Beitr.*, vii. p. 137.—Leaves ovate-oblong. Petals white. Bark of the branches red. It is likely that this is also the *S. álba* of Miller, of *Wats. Deud. Brit.*, t. 133., and of *Muhlenberg's Catalogue of North American Plants*.

❖ *S. s. 4 latifolia* Willd. Sp., ii. p. 1055. *S. obovata* Raf. in Litt.,

not of Waldst. et Kit., according to *Willd. Enum.*, 541.; *S. carpinifolia* *Willd. Enum.*, p. 540., and *Don's Mill.*, ii. p. 520., *Wats. Dend. Brit.*, t. 66.; and our *fig.* 441.—Leaves ovate-oblong. Petals white. Bark of branches rather reddish.

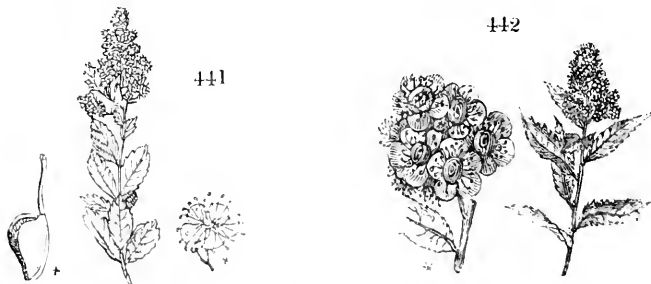

❧ *S. s. 5 grandiflora*. *S. grandiflora* *Lodd. Bot. Cab.*, t. 1988., and our *fig.* 442., has its pink flowers nearly twice as large as those of the species; and is a very ornamental free-growing shrub. It was raised by Messrs. Loddiges from seeds sent to them from Kamtschatka, in 1826, by M. Busch.

Description, &c. *S. salicifolia*, according to Pallas, grows as high as 6 ft., in favourable situations, in Russia and Siberia; but in England it is seldom found higher than 4 ft. It sends up numerous straight rod-like stems, and these and the lateral branches terminate in large, conical, spiked panicles, of pale red, or flesh-coloured, flowers. In deep moist soils, a sucker will attain the height of 4 ft. in one season, and flower. These suckers are produced in such abundance, that, in order to keep the shrub in a vigorous state, they ought to be cut down when they have flowered two years, in the same manner as is practised with raspberries; and the entire plant ought also to be taken up every three or four years, and separated; otherwise the old shoots are apt to die, and render the bush unsightly. It has been in cultivation in England since 1665; but whether it was introduced from some other country, or from localities where it is said to be found wild, is uncertain. According to Dr. Hooker and G. Don, it is wild in several parts of Scotland. Sir J. E. Smith believes it to be wild at Hafod, in Cardiganshire; the situation in which it grows there being perfectly swamps in the south of Europe. It is one of the hardiest of and is, also, very beautiful, from its long spicate panicles full of light feathery looking flowers. It will grow with more or less luxuriance, according to the degree of richness, and moisture of the soil.



like its native garden shrubs,



❧ 20. *S. TOMENTOSA* L. The downy Spiræa.

Identification. *Lin. Sp.*, 701.; *Camb. Monog.*; *Dec. Prod.*, 2. p. 544.; *Don's Mill.*, 2. p. 520.

Engravings. *Pluk. Phyt.*, t. 321. f. 5.; *Schmidt Arb.*, l. t. 51.; and our *fig.* 444.

Spec. Char., &c. Nearly all the parts of this plant are more or less clothed with tomentum, the under surface of the leaves most so. The tomentum upon the stem and peduncles, and perhaps elsewhere, is of a reddish colour. The leaves are ovate and serrated, the latter partly doubly so. Lobes of the calyx triangular and deflexed. Carpels divaricate. A native of Canada, and of mountainous situations in the west of North America. (*Dec. Prod.*, ii.

p. 544.) This species, in its mode of growth, resembles *S. salicifolia*, but differs from it in having rather smaller and more deeply serrated leaves, which are very tomentose beneath. The flowers are much smaller, and of a deeper red. Notwithstanding these differences, we are strongly inclined to think that it is only a variety (though we allow it to be a tolerably distinct one) of *S. salicifolia*. It deserves a place in every collection. It may be well to plant it in heath mould.

☉ 20. *S. LEVIGATA* L. The smooth-leaved Spiræa.

Identification. Lin. Mant., 244.; Camb. Monog.; Dec. Prod., 2. p. 544.; Don's Mill., 2. p. 519.
Synonymes. *S. altaicensis* Larm. Nov. Act. Petrop., 15. p. 555. t. 29. f. 2.; *S. altaica* Pall. Fl. Ross., 1. p. 272.

Engravings. Nov. Act. Petrop., t. 29. f. 2.; Pall. Fl. Ross., 1. t. 23.; and our fig. 445.

Spec. Char., &c. Leaves obovate-oblong, perfectly smooth, entire, sessile, tipped with a small mucro. Branchlets of the panicle cylindrical. Bractæas linear, rather shorter than the calyx. Lobes of the calyx triangular, ascending. (*Dec. Prod.*, ii. p. 544.) A native of Siberia, where, according to Pallas, it grows in valleys at the foot of the more lofty of the Altaian Mountains. The leaves are gently astringent, and are used by the natives as tea; and the shoots, which are long, tough, very straight, and of a proper thickness, are used by the Cossacks for ramrods, in the same manner as they do those of the cotoneaster. The flowers are white, and disposed in a different manner from those of most other plants of the genus. It was introduced in 1774, by Dr. Solander; and is a very interesting and handsome species, with a habit exceedingly dissimilar to that of spiræas in general.



☉ 22. *S. ARLEFO[\]LIA* Smith. The White-Beam-tree-leaved Spiræa.

Identification. Smith, in Rees's Cyclop., vol. 33.; Bot. Reg., t. 1365.; Dec. Prod., 2. p. 544.; Don's Mill., 2. p. 520.

Engravings. Bot. Reg., t. 1365.; and our figs. 446, 447.

Spec. Char., &c. Leaves elliptical, oblong, more or less lobed, toothed, pale, villose beneath. Panicle villose. (*Dec. Prod.*, ii. p. 544.) A native of North America, principally on the north-west coast; introduced in 1827, by the unfortunate Douglas (see p. 125.); and producing its numerous white flowers in June and July. It forms a free-growing dense bush, prolific both in leaves and flowers; and, as the latter appear at a season when the flowering of shrubs is comparatively rare, it is justly considered as a most valuable addition to British gardens. It is perfectly hardy, will grow in any free soil, and is easily propagated either by division or by seeds, which it ripens in abundance.



446



447

§ iv. *Sorbària* Ser.

Sect. Char. Leaves pinnate, resembling, as the name implies, those of the mountain ash, or other species of *Pyrus* belonging to the section *Sórbus*.

☉ 23. *S. SORBIFOLIA* L. The Sorbus-leaved Spiræa.

Identification. Lin. Sp., 702.; Camb. Monog.; Dec. Prod. 2. p. 545.

Synonymes. *S. pinnata* Mærch Meth., 633. Dr. Lindley, in his *Introduction to the Natural System*, p. 81. 83., mentions this species as one of a genus which he there names *Schizonótus*.

Engravings. Gmel. Fl. Sib., 3. p. 190. t. 40.; Schmidt Baum., 1. t. 58.; Krauss, t. 94.; Pall. Fl. Ross., 1. t. 88. and t. 24.; and our fig. 448.

Spec. Char., &c. Leaves stipuled, pinnate; the leaflets sessile, opposite, lanceolate, doubly and sharply serrated. Inflorescence a thyrselike panicle. Torus wholly connate with the tube of the calyx. Ovaries connate, 5. A native of Siberia, in moist places. (*Dec. Prod.*, ii. p. 545.)

Variety.

- *S. s. 2 alpina* Pall. *Fl. Ross.*, i. p. 34. and 89. t. 25., *Camb. Monog. S. grandiflora Hort. Brit.*, No. 29267., and *Sweet's Hort. Brit.*, p. 194.; *S. Pallasii* Don's *Mill.*, ii. p. 520. — Suffruticose. Flowers twice the size of those of the species, and disposed in corymbs. Leaves smaller, and serrately incised. A native of eastern Siberia and of Kamtschatka. (*Dec. Prod.*, ii. p. 545.) This is the *S. grandiflora* of *Sweet's Hort. Brit.*, and our *Hort. Brit.*, and is very different from *S. s. grandiflora*, the *S. grandiflora* of *Lodd.*, described before, among the varieties of *S. salicifolia*, p. 730.

448

Description, &c. *S. sorbifolia* is a branchy shrub, growing to the height of 6 ft. or 8 ft., with a round, brown-coloured, warty stem; the wood of which is brittle, and hollow within, with a soft ferruginous pith. The leaves are thin in texture, and bright green on both sides. The flowers are in terminating panicles, small and white: they are odorous, but not agreeably so. According to Pallas, it is a native of eastern Siberia, in boggy woods and wet mountains, where it grows along with *S. salicifolia*, and attains the height of 6 ft.; but, in dry rocky situations, it does not rise above 1 ft. in height, and is subherbacous. It was cultivated by Miller in 1759, and deserves a place in every collection, from its marked character, and from the beauty both of its foliage and its flowers. It throws up abundance of suckers, by which it is easily propagated.



App. i. *Species or Varieties of Spiræa not yet introduced.*

■ *S. Blumei* G. Don, *S. chamædrifolia japonica Blume Bijdr.*, 1114., is a native of Java and Japan, with white flowers, and is, probably, nothing but a variety of *S. chamædrifolia*, it being considered such by the discoverer, Blume, though elevated to the rank of a species by G. Don.

■ *S. lanceolata* Poir. (*Don's Mill.*, ii. p. 518.) is a native of the Mauritius and China, with leaves like those of *S. salicifolia*, and white flowers.

■ *S. argentea* Mutis has the whole plant clothed with silky silvery down. It is a native of New Grenada; and, if introduced, would probably be found, at first, rather tender; but, if our conjecture, as to the constitution of truly natural genera be correct, it will be found capable of being acclimated.

■ *S. Thunbergii* Blume, and *Don's Mill.*, 2. p. 319., is a native of Java and Japan, with linear-lanceolate leaves, and white flowers.

■ *S. magellanica* Poir, and *Don's Mill.*, 2. p. 519., has lanceolate leaves, and white flowers; and, being a native of the Straits of Magellan, will, doubtless, be found quite hardy.

■ *S. japonica* Sieb. ex Blume, and *Don's Mill.*, 2. p. 519., is said to resemble the preceding species.

■ *S. Menziesii* Hook. *Fl. Bor. Amer.*, p. 173., and *Don's Mill.*, 2. p. 520., is thus described:— Branches pubescent at the apex. Sepals reflexed. Leaves elliptic. Panicle crowded with rose-coloured flowers. It would be a desirable introduction, and will, doubtless, soon be procured.

■ *S. Douglasii* Hook. *Fl. Bor. Amer.*, p. 172., and *Don's Mill.*, 2. p. 520. From Dr. Hooker's description of this sort, it appears to us to be the same, or nearly so, as the preceding. It is a native of the north-west coast of America, about the Columbia and the Straits of Fucas where it is said to grow to the height of 4 ft. or 5 ft.

■ *S. callosa* Thunb., *S. expansa* Wall., is a native of Japan and Nepal, and said to differ from *S. salicifolia* in the leaves being nearly stalked. It grows to the height of 4 ft., and has showy red flowers.

■ *S. cærulescens* Poir. has sessile bluish-coloured leaves, and white flowers, and, being a native of India, would probably prove only half-hardy in British gardens.

■ *S. discolor* Pursh *Fl. Amer. Sept.*, 1. p. 342., is described by that botanist from specimens which he saw in a herbarium. It is said to be found on the banks of the Kookosky; to have discoloured leaves; and to grow to the height of about 5 ft.

Almost all the known species of *Spiræa* being quite hardy, of the easiest culture, and very free flowerers, it is much to be desired that a part or all of the above species could be procured. We recommend the subject to those who have friends and correspondents in the countries where these species are indigenous.

Sect. III. POTENTI'LLÆÆ.

GENUS IX.

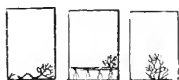
RUBUS L. THE BRAMBLE. *Lin. Syst. Icosándria Polygýnia.*

Identification. Lin. Gen., No. 364.; Dec. Prod., 2. p. 556.; Don's Mill., 2. p. 529.

Synonymes. Ronce, Framboisier, *Fr.*; Himbeere, Brombeerstrauch, *Ger.*

Derivation. From *rub*, red in Celtic; in reference to the colour of the fruit in some of the species.

Description. Deciduous subligneous shrubs, for the most part prostrate; with prickly stems, and digitate, pinnate, or lobed, leaves; but a few of them growing upright. The fruit of all of them is edible. Some of them, such as *R. fruticosus*, may be considered as sub-evergreen, as they retain the greater part of their leaves in a green state through the winter. All the kinds popularly called brambles may be considered as gigantic strawberry plants. The following excellent technical description is from Dr. Hooker's *British Flora*; and, though drawn up with a view to the British species, yet, as in these are included the raspberry, or upright-growing species, as well as the common brambles, it applies equally well to the whole genus.

"*Shrub-like plants, or herbs, with perennial roots.* The herbaceous species offer nothing very peculiar. In some species of the shrubs the stem is upright, or merely curved at the top; but, in the greater number, it is either prostrate, or, as is more generally the case, assurgent, arched, and decurved; and the ends of the shoot, and of the side branches, if it produce any, unless prevented by circumstances from reaching the ground, take root in the latter part of the year. In the winter the shoot is partially destroyed, the part next to the original root surviving, to produce flowering branches during the ensuing summer, and usually dying after the fruit has been perfected; young shoots, meanwhile, springing up by its side. The rooted ends also become distinct plants, at various distances from the parent root; often many yards. This mode of growth adds much to the difficulties in the discrimination of the species; since an acquaintance with both the leafy shoot, and the floriferous stem formed in the second year from its remains, is necessary. The best characters are found in the figure, the arms, and the leaves of the former. The *leaves* in all the British species of this division are, occasionally at least, quinate; and, with one exception, digitate, or somewhat pedate, from a partial junction of the stalks of the two lateral pairs of leaflets; the margins serrated, for the most part unequally and irregularly; the prickles on the leaf-stalks more curved than those on the stem. In some species the *inflorescence* is remarkable; but, in general, the panicle varies so much as to afford no good distinction. Nor can the arms of the calyx, nor the form of its segments, be depended on. The *petals* in all are delicate and crumpled, and, in several species, very considerable in size and width. There are some differences in the *fruit*, but they are rarely discriminative. In examining the figure of the leaves, the central leaflet is to be regarded: the lateral ones are always smaller, and of a narrower proportion. In several species, the leaves occasionally survive a mild winter, and are found the next season subtending flowering branches. The leaves of these branches are of less determinate figure; the number of their *leaflets* is reduced as they approach the inflorescence, and their place is supplied in the upper part of the panicle by, first trifid, and then simple, *bracteas*, formed by the coalescence of the *stipules*. These last are usually long and narrow, entire, or sometimes toothed and jagged, and issue from the petiole, for the most part a little above its base. They afford no distinguishing characters. No less than 48 supposed species of the genus are described and figured in the elaborate *Rubi Germanici* of Weihe and Nees von Esenbeck. (*Borrer, in Hook. Br. Fl., p. 243.*)

The number of species of *Rubus* described by Sir J. E. Smith in the last edition of his *English Botany*, published in 1824, as natives of England, are 14: Dr. Hooker, in his *British Flora*, published in 1831, enumerates 13; and Dr. Lindley, in his *Synopsis of the British Flora*, 2d edit., published in 1835, 21; which, he says, may be reduced to 5, or possibly to 2, exclusive of the herbaceous species. In our *Hortus Britannicus*, 68 species are enumerated, as having been introduced into Britain; and in *Don's Miller*, 147, as the total number described by botanists.

The remarks which Dr. Lindley has made on this subject appear to us extremely interesting and valuable, not only with reference to the genus *Rubus*, but to all genera that contain numerous species. Following out the principles laid down in the elaborate monograph of Weihe and Nees von Esenbeck, Dr. Lindley, in the first edition of his *British Flora*, advanced the number of British species to 23; "certainly," he observes, "not from any expectation that such species were either genuine, or likely to prove permanent, but with a view of following out the recognised principles of distinction, and showing whither they must inevitably lead." In the second edition, he observes: "This proceeding has not found favour in the eyes of those from whom I most expected applause: . . . it has had one good effect however; . . . it has led me to consider the subject very carefully, and to examine with more attention the nature of the principles upon which the modern and recognised species of *Rubus* have been established; I have also had six years of additional experience; and I am bound to declare, that I can come to no other conclusion than that with which I first started; namely, that we have to choose between considering *R. suberectus*, *R. fruticosus*, *R. corylifolius*, and *R. cæsius*, the only genuine species; or adopting, in a great measure, the characters of the learned German botanists, Weihe and Nees von Esenbeck, who have so much distinguished themselves in the elaboration of the genus. So clear is my opinion upon this point, that, if it had been possible to prove the four species to which I have alluded to be themselves physiologically distinct, I should at once have reduced all the others to their original species; but, as it is in the highest degree uncertain whether *R. fruticosus*, *R. corylifolius*, and *R. cæsius* are not as much varieties of each other as those which it would be necessary to reject, I have thought it better to steer a middle course, until some *proof* shall have been obtained either one way or the other. Accordingly, as will be seen by what follows, I have taken *R. fruticosus*, *R. corylifolius*, *R. cæsius*, and *R. suberectus* as heads of sections; and I have assigned to them characters which may be considered either as sectional or specific, according as the evidence may ultimately preponderate. I have also arranged as species under them those forms which are the best marked, and the most certainly distinguishable. This will bring the genus *Rubus* somewhat into the situation of *Rosa*; in which, I fear, we must be satisfied with leaving it for the present." (*Lind. Synop. Brit. Fl.*, 2d edition, p. 92.) It appears to us highly probable, that the four forms mentioned above are only varieties of the same species; and this would reduce the ligneous British rubuses to the raspberry and the bramble. The species exclusively North American, as far as we have observed them in the garden of the Horticultural Society, include four with the habit of raspberry, and three with the habit of the bramble; but the latter three, *R. flagellaris*, *R. inermis*, and *R. setosus*, are probably only varieties of the same species. The Nepal rubuses, as far as they have been hitherto introduced, are all brambles; but there is one, *R. cóncolor*, which, Mr. Royle observes, is found on lofty mountains, and comes near to the raspberry. *R. micranthus* is, perhaps, the only distinct species of Nepal bramble that has been introduced; some plants, raised from Nepal seeds, which may be observed in the Chelsea Botanic Garden, and in the garden of the Horticultural Society, being evidently nothing more than varieties of the British bramble. The course which we have adopted with respect to the ligneous species of this genus is, to give, first, a descriptive enumeration of all the ligneous species or varieties, indigenous or introduced, elaborated from

De Candolle's *Prodromus*, Don's *Miller*, and Lindley's *Synopsis*; and, next, a selected list of all those species and varieties, with references to the pages where they have been described and figured in the preceding descriptions. In giving these descriptions, those sorts which we consider to be only of interest to those who are fond of multiplying botanical distinctions will be found in smaller type, and may be passed over by those who do not wish to trouble themselves with minute differences.

The propagation of the shrubby, or raspberry-like, species of *Rúbus* is effected by suckers or seeds; that of the bramble division of the genus by pegging down the points of the shoots to the soil, when they will root, and throw out other shoots, which may again be pegged down; so that plants are procured from brambles much in the same way as from strawberries.

Most of the raspberry kinds, and a few of the ornamental brambles, are procurable, in British nurseries, at 1s. 6d. a plant; at Bollwyller, for from 1 franc to 1½ francs; and, at New York, for from 37½ cents to 50 cents. The fruit-bearing raspberries, in the London nurseries, at 4d. each.

§ i. *Leaves pinnate, of 3—7 Leaflets.*

❖ 1. *R. SUBERECTUS* Anders. The sub-erect Bramble.

Identification. Anders. in Linn. Soc.; Dec. Prod., 2. p. 556; Don's Mill., 2. p. 534; Smith Eng. Flora, 2. p. 406.

Synonymes. Lindley, in his *Syn. of the Brit. Flora*, has given the following:—*R. nescénsis* Hall; *R. plicatus* W. & N., not of *Suppl. to Eng. Bot.*, t. 2714, which is a smaller form of *R. affinis* W. & N.; *R. corylifolius* Wahlenb.

Engravings. Eng. Bot., t. 2572; E. of Gard., 1835, fig. 496.

Spec. Char., &c. Stem erect. Leaf of never more than 5 leaflets, digitate, occasionally pinnate, thin, shining, and plaited. Flowers in simple corymbose racemes. Prickles weak. Is found in Britain, in moist woods, and by the sides of rivulets, chiefly in the northern counties. (*Lindley, Synopsis of the Brit. Flora*, ed. 2. p. 92.) This is "the most frequent species, if species it be, in the upland zone." (*Watson, in Outl. Geog. Distr.*, p. 137.) The stems are biennial, and flower the second year, like those of the common raspberry, afterwards dying off. They grow nearly upright, without any support, and are between 3 ft. and 4 ft. high. The fruit consists of rather a small number of dark red, or blood-coloured, aggregate grains, said to be agreeably acid, with some flavour of the raspberry; whence it has been recommended by some as perhaps not unworthy of cultivation.

✧ 2. *R. AFFINIS* Weihe & Nees. The related Bramble.

Identification. Weihe and Nees's *Rubi Germanie*, p. 22. t. 3. and 36; Dec. Prod., 2. p. 560; Lindl. *Synops. Br. Fl.*, 2d ed. p. 92, 93.

Synonymes. Lindley mentions the following:—*R. collinus* Dec.; *R. nitidus* Smith in *Eng. Flor.*, *Lindley in Syn. Br. Fl.*, ed. 1; *R. plicatus* Borrer in *Eng. Bot. Suppl.*, t. 2714.

Engravings. Weihe and Nees's *R. G.*, t. 3. and 36; Eng. Bot. Suppl., t. 2714.

Spec. Char., &c. Stem arched, angled, prickly with strong recurved prickles, glabrous. Leaflets 3—5 in a leaf, ovate with a heart-shaped base, cuspidate, sharply serrated, flat at the base, a little waved towards the tip, having downy tomentum beneath. Flowers in a compound panicle, the component ones cymose. Sepals ovate-acuminate, externally naked, reflexed. Carpels large, blue-black. (*Dec. Prod.*, 2. p. 560.) A native of Germany, also of barren hills of Montpellier, and of Britain, in boggy places; and flowers in July and August. (*Lindley, Synopsis. Br. Fl.*)

Variety.

✧ *R. a. 2 bracteosus* Ser., *R. a. γ*, and *δ*, *Weihe and Nees's Rubi Germ.*, t. 3. b.—Bracteas very broad, undivided.

✧ 3. *R. FISSUS* Lindl. The cleft Bramble.

Identification. Lindl. *Synops. Brit. Flora*, ed. 2. p. 92.

Synonyme. *R. fastigiatus* Lindl. in his *Synops. Brit. Flora*, ed. 1., not of Weihe & Nees.

Spec. Char., &c. Stem arched. Leaves digitate, shining, frequently of 7 leaflets, that are much less membranous than those of *R. suberectus*. Flowers in simple racemes. Prickles strong, numerous. It differs from *R. affinis* W. & N. in its small racemes, and in its floral leaves never being large and orbicular, as they are in *R. affinis*. "The only specimen with which I am acquainted," adds Dr. Lindley, "is one sent to the garden of the Horticultural Society from Ayrshire." (*Lindley, Synopsis. Brit. Fl.*, ed. 2. p. 93.)

❖ 4. *R. MICRANTHUS* D. Don. The small-flowered Bramble.

Identification. Don *Prod. Fl. Nepal*, p. 235; Dec. Prod., 2. p. 557; Don's Mill., 2. p. 530.

Synonyme. *R. pauciflorus* Lindley in *Bot. Reg.*, *Hort. Brit.*, n. 13500.

Engravings. Bot. Reg., t. 854, as *R. pauciflorus* Lindl.; and our fig. 449. representing a sprig to the usual scale, and figs. 450. and 450 a representing the flowers and fruit of the natural size.

Spec. Char., &c. Upright. Stem round, branched, and bearing awl-shaped inflexed prickles, or straight prickles, and the branches recurved ones. Young branchlets rather glaucous at the extremity. Leaf pinnate, of 5—7 leaflets, that are ovate or oblong, mucronate, doubly serrated, plaited, green and glossy above, whitishly tomentose, or else glaucous, beneath. Petiole and rachis bearing prickles here and there. Petiole pilose. Stipules lanceolate, acuminate, membranaceous. Flowers small, reddish purple, disposed in a corymbose panicle. Petals clawed, shorter than the sepals. Fruit black. Closely related to the *R. distans* of D. Don. (*Dec. Prod.*, ii. p. 557.)



449

A gigantic bramble, a native of Nepal, introduced in 1822; growing to the height of 8 ft. or 10 ft., and flowering from May to August. It is easily distinguished from all the

450

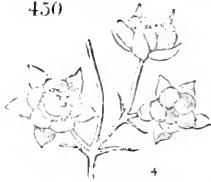

other brambles in British gardens, by its nearly erect, strong, smooth, dark mahogany-coloured shoots, and by its very long pinnate leaves. The flowers are small, and the petals are of a bright reddish purple, and shorter than the sepals. The fruit is of a blackish purple, of the middle size; depressedly spherical, and covered with a fine bloom. The grains are fleshy, with a sweet subacid taste. This species grows up suckers sparingly; but its magnificent shoots arch over after they get to 6 ft. or 8 ft. in height, and grow branching and flowering on every side, till they reach the ground, when their extreme points strike root, and form new plants. A plant in the Horticultural Society's Garden, in 1834, was 10 ft. high, with shoots nearly 20 ft. long.



450 a

5. *R. DISTANS* D. Don. The distant-leafleted Bramble.

Identification. Don Prod. Fl. Nepal, p. 256; Dec. Prod., 2. p. 557.; Don's Mill., 2. p. 530. *Synonyme.* *R. pinnatus* D. Don in *Prod. Fl. Nepal*, p. 254.

Spec. Char., &c. Stems round, bearing stout, compressed, recurved prickles. Leaves pinnate, resembling those of the hemp plant. Leaflets lanceolate, acutely serrated, distant, whitely tomentose beneath, and having numerous nerves. Stipules linear, at the tip subspathulate. Racemes corymbose. Peduncles short. Sepals tomentose, ovate, somewhat acuminate, as long as the petals. Carpels downy. (*Dec. Prod.*, 2. p. 557.) A native of Nepal, introduced in 1818, growing to the height of 6 ft. or 8 ft., and flowering in June and July. We have never seen the plant.

6. *R. STRIGOSUS* Michx. The strigose Bramble.

Identification. Michx. Fl. Bor. Amer., 1. p. 297.; Pursh Fl. Amer. Sept., 1. p. 346.; Dec. Prod., 2. p. 557.; Don's Mill., 2. p. 531. *Synonyme.* *R. pennsylvanicus* Poir. *Diet.*, 6. p. 246.

Spec. Char., &c. Stem round, very hispid. Leaves pinnately cut; those of the barren branches of 5 lobes, those of the fertile ones of 3. Lobes oval, unequally serrated, obtuse at the base, beneath lineated, and hoarily tomentose; the odd one, in most instances, almost heart-shaped. Flowers about 3 upon a peduncle. Peduncle and calyx hispid. Petals white, longer than the calyx. (*Dec. Prod.*, 2. p. 557, 558.) A native of North America, on mountains from Canada to Virginia; flowering in June and July. According to Pursh, it is an upright shrub, with fruit very agreeable to eat. There is a plant in the Horticultural Society's Garden, to which the name of *R. pennsylvanicus* is attached: but, it being in a weak state, we are not certain that it is the same species.

451



7. *R. OCCIDENTALIS* L. The Western, or American, Bramble.

Identification. Lin. Sp., 706.; Dec. Prod., 2. p. 558.; Don's Mill., 2. p. 531.

Synonyms. *R. virginianus* Hort.; *R. idæus fructu nigro* Dill. *Engraving.* Sloane Jam., t. 213. f. 1.; Dill. Hort. Elt., t. 247. f. 319.; and our fig. 451.

Spec. Char., &c. The whole plant is pretty glabrous. Stems round and whitish. Prickles recurved.

Leaves of the barren branches pinnate; of the fertile branches, trifoliolate. Leaflets ovate, incisely serrated, whitely tomentose beneath. Stipules very narrow, and bristle-like. Flowers in umbels. Peduncle prickled. Sepals lanceolate-linear, tomentose, longer than the petals, which are obovately wedge-shaped, two-lobed, and spreading. Fruit black, acid, of the form of that of *R. idæus*. Carpels numerous, rather glabrous; becoming, by drying, rugged, with little hollows. (*Dec. Prod.*, ii. p. 558.) A native of Canada and the West Indies; introduced in 1696; growing to the height of from 4 ft. to 6 ft.

❖ 8. *R. ASPER* D. Don. The rough-branched and petioled Bramble.

Identification. Don *Prod. Fl. Nepal*, p. 234; *Dec. Prod.*, 2. p. 558.; Don's *Mill.*, 2. p. 531.

Spec. Char., &c. Leaves pinnate; leaflets 7, elliptical, acuminate, sharply serrate, green, pilose beneath. Petioles and branchlets bearing prickles and glanded bristles. Stipules lanceolate, pointed. Flowers terminal, about 3 together. (*Dec. Prod.*, 2. p. 558.) A native of Nepal, said to be introduced in 1821, and to grow from 4 ft. to 6 ft. high; but we have not seen the plant.

❖ 9. *R. IDÆUS* L. The Mount Ida Bramble, or common Raspberry.

Identification. Lin. Sp., 706.; *Dec. Prod.*, 2. p. 558.

Synonymes. *R. frambesiænaus* Lam. *Fl. Fr.*, 3. p. 135.; Framboisier, *Fr.*; gemeine Brombeere, *Ger.* "The Raspis is called in Greeke ΒΑΤΟΣ ΙΔΑΙΑ; in Latin, *Rubus Idæa*, of the mountaine Ida, on which it groweth; in English, Raspis, Framboise, and Hinde-berry." (*Johns. Ger.* p. 1274.)

Engravings. Eng. Bot., t. 2442.; and our fig. 452.

Spec. Char., &c. Villose. Stem round, bearing slender recurved prickles.

Leaves pinnate; those of the fertile stems of 3 leaflets, those of the sterile stems of 5, rather palmately disposed. Leaflets ovate, incisely serrated, whitely tomentose beneath. Stipules very narrow and bristle-like. Flowers in a corymbose panicle. Sepals ovate-lanceolate, whitely tomentose, ending in a point. Petals obovate-wedge-shaped, entire, conniving, shorter than the calyx. Carpels numerous, tomentose. (*Dec. Prod.*, ii. p. 558.) A shrub, with biennial stems, a native of Europe, and, probably, of Asia, Africa, and America.

Varieties. There are varieties with red fruit, yellow fruit, and white fruit. (*Dec. Prod.*, ii. p. 558.) There is a variety which bears twice in the year.

❖ *R. i. 2 microphyllus* Wallr. *Sched.*, p. 256. — Leaves all of 3 leaflets.

Stem suffruticose; dwarfer and more bushy than the species. (*Dec. Prod.*, ii. p. 558.)

Description, &c. The common raspberry has a creeping root, with biennial stems, 3 ft. or 4 ft. high, pinnate leaves, and small white flowers. The fruit of the species, in a wild state, is crimson, and consists of numerous juicy grains, beset with the permanent styles; and highly fragrant, with a very deliciously sweet, and yet slightly acid, flavour, when eaten. It is a native of Europe, from Norway and Sweden to Spain and Greece, in woods. It is found in Asia, on

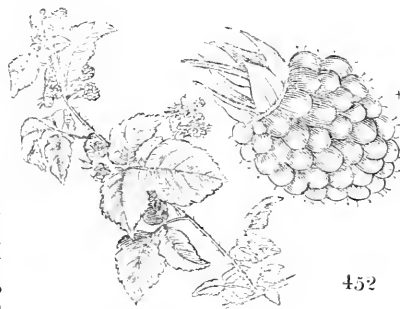

the Himalaya Mountains, and in other places; in the north of Africa; and, according to Pursh, in America, in hedgerows, from Canada to Pennsylvania, though it has been probably introduced into that country. It is found in every part of Great Britain, and in Ireland, in the agricultural and subalpine regions, in woods, and in moist wastes. Improved varieties of it have long been in cultivation in gardens, for the fruit, which is delightfully fragrant, and grateful to the palate in itself, and is used in numerous culinary and confectionery articles, as well as in liqueurs. In France, raspberries are very generally eaten at table, mixed with strawberries. A very refreshing summer drink is made of them, by simply bruising them in water, and adding sugar. They enter into the composition of different jellies, jams, ices, syrups, and ratafias;

and they are preserved, either alone, or along with currants. Infused in spirit, they communicate a most delicious perfume to it. Fermented, either alone, or mixed with currants or cherries, they make a very strong and agreeable wine; from which a very powerful spirit can be distilled. Raspberry wine was formerly much in use in Poland; the fruit being there abundant in the woods. In Russia, a mixture of raspberries and honey with water, fermented, makes a delicious hydromel. Raspberries are also dried in ovens for winter use. Raspberry vinegar is well known both in France and England; and, independently of its agreeableness when mixed with water, as a summer drink, it is excellent as a febrifuge. In England, raspberries are principally used for making raspberry jam and raspberry vinegar; and for pies and puddings, in combination with currants and cherries. They are excellent eaten with milk or cream, with the addition of sugar, when fresh; and are easily preserved in jars or bottles, entire, with or without sugar, for winter use. They are reckoned very wholesome, and children are seldom, if ever, injured by eating them. The roots of the raspberry plant are in demand by some French cooks; but we are uncertain to what use they are applied; probably in the dressing of game.

The Varieties cultivated in British gardens are numerous: twenty-one of the best, with their synonymes, are characterised in the London Horticultural Society's *Catalogue of Fruits* for 1831; among which, those differing most in general appearance, and, consequently, most suitable for being planted in an arboretum, are, the red Antwerp, the yellow Antwerp, the smooth cane (a large-growing and very distinct variety, which Miller considered as a species), and the old white, or perpetual-bearing.

Propagation and Culture. The raspberry requires a vegetable soil, rather moist, soft, and not very deep; because most of the roots, like those of all other plants that throw up numerous suckers, keep near the surface; and the situation should be shaded, rather than fully exposed to the meridian sun. In a wild state, it is almost always found more or less shaded by trees, but not under their drip; and in woods, the situation of which is rather low and moist, than hilly and rocky or dry. The root belongs to that description which is called travelling; that is, the suckers extend themselves all round the central plant, so as every year to come up in fresh soil. Hence, as Miller observes, a raspberry plantation requires to be renewed every five or six years. The raspberry, for this reason, has been considered as a good example of the doctrine of the excretion of plants, first broached by Brugman; afterwards explained in detail by De Candolle, in the *Physiologie Végétale*, vol. i. p. 219., and subsequently elucidated, by various experiments, by M. Macaire. (See *Suppl. Encyc. Agri.*, p. 1301.) This doctrine, which, in Britain, seems to have been first hinted at by Mr. Sheriff of Mungos Wells, and Mr. Towers, the author of the *Domestic Gardener's Manual*, is supposed to account scientifically for the effect of naked fallows on soils; but a sufficient number of experiments have not yet been made, to establish the doctrine on a secure foundation. (See *Gard. Mag.*, xii. p. 299.; and *Phil. Mag.*, 3d ser., vol. viii.) It is certain, however, that the raspberry, in a wild state, is continually changing its situation; and, in a state of culture, that it requires to be frequently taken up, and replanted in fresh soil. The seeds of the raspberry are said to retain the vital principle for a very long period; and a plant, now (1836) in the Horticultural Society's garden, was raised from seeds found in a barrow, or tumulus, in Wiltshire, opened in 1835; which, unless we can suppose the seeds to have been conveyed into the interior of the tumulus by insects or vermin, must have lain there many centuries.

§ ii. *Leaves digitate, of 3—5 Leaflets.*

* 10. *R. LACINIA'TUS W.* The cut-leaved Bramble.

Identification. Willd. Hort. Berol., p. 82. and t. 82.; Dec. Prod., 2. p. 558.; Don's Mill., 2. p. 532.
Engravings. Willd. Hort. Berol., t. 82.; Wats. Dend. Brit., t. 69.; and our *fig.* 453.

Spec. Char., &c. Stem rather round, bearing stout recurved prickles, compressed at the base. Leaflets 3—5, pinnately cut, sharply serrate, a little downy beneath. Flowers in loose panicles, white or rose-coloured. Sepals lanceolate, leafy at the tip, tomentose, prickled, reflexed. Petals wedge-shaped, 3-lobed at the tip. Carpels, roundish, dark coloured. (*Dec. Prod.*, ii. p. 558.) The appearance of this plant is that of the common bramble, except in the leaflets, which, from their being deeply cut, are strikingly different. Where it was first found is unknown; but it is, in all probability, only a variety of the common bramble, analogous to the cut-leaved variety of the elder (*Sambucus nigra laciniata*). Plants may be obtained at the principal nurseries.



433

* 11. *R. CÆSIUS* L. The grey Bramble, or Dewberry.

Identification. Lin. Sp., 706.; *Dec. Prod.*, 2. p. 558.; Don's Mill., 2. p. 533.
Engravings. N. Du Ham., 5. t. 92.; Hayne Abbild., t. 100.; Eng. Bot., t. 826.; and our fig. 434.

Spec. Char., &c. Stem trailing, round, in many instances suffused with a grey bloom, bearing slender and a little recurved prickles. Leaflets 3 in a leaf, ovate, doubly serrated or crenated, glabrous, or obscurely ciliated. Panicle almost simple. Sepals ovate-acuminate. Petals white. Fruit sweet. Carpels large, few, greyish. (*Dec. Prod.*, ii. p. 558.)



434

Varieties.

- * *R. c. 2 arrænsis* Wallr. Sched., p. 288.; *R. pseudo-cæsius* *Wiche*, according to Ern. Meyer in Litt. — Leaflets tomentose beneath. Branches puberulous.
- * *R. c. 3 grandiflorus* Ser. — Pubescent. Petals and sepals long.
- * *R. c. 4 parvifolius* Wallr. Sched., p. 228.; and our fig. 455. — Stem ascending, purplish, ultimately naked. Leaves small, incisely lobed. Peduncle 1—3-flowered. A native of herbage-covered hills.
- * *R. c. 5 foliis variegatis* Hort. has variegated leaves.

Description, &c. A low, weakly, straggling, prostrate plant, having the flowers with blush-coloured petals, and the fruit small, with few grains; but these large, juicy, black, with a fine glaucous bloom, and very agreeably acid. It is a native of Europe, and the north-east of Asia, in woods and hedges. By some it has been proposed to be cultivated on account of its fruit. (See *Encyc. of Gard.*, ed. 1835, p. 946.) This species, or race, varies exceedingly in different situations; whence have arisen the following varieties (12—16.), of more marked character than those already given, and which are considered by some as

species; in which form they are as follows:—

* 12. *R. NIRTUS* W. & K. The hairy Bramble.

Identification. Waldst. and Kit. Plant. Rar. Hung., 2. p. 150. t. 141.; Don's Mill., 2. p. 533.
Synonymes. *R. villosus* *Ait.*, var. *glandulosus* *Ser.* in *Dec. Prod.*, 2. p. 563.; *R. glandulosus* *Bell. App. Fl. Pedem.*, p. 24.; *R. hybridus* *Vill. Delph.*, 3. p. 359.
Engraving. Waldst. and Kit. Plant. Rar. Hung., 2. p. 150. t. 141



455

Spec. Char., &c. Stem weak, roundish, bearing slender, very acute, and rather recurved, prickles; and, as well as the peduncles and petioles, villose, and hispid with glanded hairs. Leaflets 3, rarely 5, ovate, doubly serrated, villose, thinish. Flowers in loose panicles. Sepals lanceolate, acuminate. A native of moist woods of Hungary. (*Dec. Prod.*, ii. p. 562.) According to our *Hortus Britannicus*, this was introduced into Britain in 1816; but, according to Dr. Lindley (*Synops. Brit. Flora*, ed. 2.), it is a native of Britain, and is "a strong glandular state of *R. cæsius*, approaching *R. Köhleri*," which he represents as one of that group of forms which he has associated with *R. corylifolius* as the type.

✱ 13. *R. SPRENGELII* Weihe. Sprengel's Bramble.

Identification. Weihe, according to Link Enum., 2. p. 62., and Spreng. Syst., 3. p. 528.; Don's Mill., 2. p. 533.

Synonymes. *R. vulpinus* Desf. *Cat. Hort. Par.*, p. 205.; *R. villosus* ♂ *vulpinus* Ser. in *Dec. Prod.*, 2. p. 564.

Engraving. *Ged. Fl. Dan.*, t. 1165.

Spec. Char., &c. This, as compared with *R. hirtus* Waldst. & Kit., has its stem, petiole, and peduncle very finely villos, and only very slightly hispid with glanded hairs. Leaves rather glabrous. (*Dec. Prod.*, ii. p. 564.) This, according to our *Hort. Brit.*, is a native of Germany, and was introduced into Britain in 1823; it has pink flowers.

✱ 14. *R. DUMETORUM* Weihe & Nees. The Bramble of the Thickets.

Identification. Weihe and Nees, on the authority of Lindley's *Synops. of the Brit. Flora*, ed. 2. p. 94.; *Hort. Brit.*, No. 28336.; Don's Mill., 2. p. 533.

Spec. Char., &c. Branches with scarcely any bristles. Stem leaves with 5 leaflets. Flowers in a leafy straggling panicle. Spontaneous in Britain in hedges and dry ditches. In affinity it is nearly half-way between *R. cæsius*, and *R. corylifolius*. (*Lindley, in Synops. of Brit. Flora*, ed. 2. p. 94.)

✱ 15. *R. FOLIOLOSUS* Don. The leafy Bramble.

Identification. Don *Prod. Fl. Nep.*, p. 256.; *Dec. Prod.*, 2. p. 559.; Don's Mill., 2. p. 533.

Synonymes. *R. microphyllus* Don *Prod. Fl. Nep.*, p. 254.

Spec. Char., &c. Branches with scarcely any bristles. Stem leaves with 5 leaflets. Flowers in a leafy straggling panicle. Spontaneous in Britain in hedges and dry ditches. In affinity it is nearly half-way between *R. cæsius*, and *R. corylifolius*. (*Lindley, in Synops. of Brit. Flora*, ed. 2. p. 94.)

✱ 16. *R. FLAGELLARIS* Willd. The Rod-like, or Runner, Bramble.

Identification. Willd. *Enum.*, 549.; *Dec. Prod.*, 2. p. 559.; Pursh *Fl. Amer. Sept.*, 1. p. 347.; Don's Mill., 2. p. 533.

Spec. Char., &c. Stem round, procumbent, bearing scattered, short, hooked, prickles. Branches round, glabrous. Leaflets 3, glabrous, unequally serrated; the middle one ovate, wedge-shaped at its base; the side ones rhomb-shaped. Nerves yellowish. (*Dec. Prod.*, ii. p. 559.) A native of North America, with procumbent stems, common in Virginia and Carolina, in fields and sandy woods; apparently only a variety of *R. cæsius*. It was introduced in 1789, and flowers in June and July.

Variety.

✱ *R. f. inermis* Ser.; *R. inermis* Willd. *Enum.*, p. 458., according to Link's *Enum.*, i. p. 62. — Stem whitish, and, as well as the peduncles, devoid of prickles. Leaflets tomentose beneath. (*Dec. Prod.*, ii. p. 559.)

✱ 17. *R. CORYLI-FOLIUS* Smith. The Hazel-leaved Bramble.

Identification. Smith *Fl. Brit.*, p. 542.; Smith in *Eng. Bot.*, t. 827.; Don's Mill., 2. p. 533.

Synonymes. *R. vulgaris* Weihe & Nees, according to Lindley, *Synopsis of Brit. Flora*, ed. 2. p. 94.; *R. nemorosus* Heyne, according to Sprengel and Goldbach.

Engravings. *Eng. Bot.*, t. 827.; and our *fig.* 456.

Spec. Char., &c. Stem angled, bearing straightish prickles. Leaflets 3—5, cordate-ovate, firm, doubly serrated, pilose beneath. Panicle nearly simple. Flowers white. Sepals ovate-acuminate, ultimately reflexed. Carpels purplish-blue, and large. (*Dec. Prod.*, ii. p. 559.) A native of Europe, especially of the southern part. Frequent in Britain, in hedges and thickets, flowering in July.

Varieties.

✱ *R. c. 2 canus* Wallr. *Sched.*, p. 231. — Leaflets all similar in form, roundish heart-shaped, whitish tomentose upon both surfaces.

✱ *R. c. 3 glandulosus* Wallr. *Sched.*, p. 231.; *R. glandulosus* Spreng., according to Wallr.; and our *fig.* 456. — Stems, petioles, and peduncles glandulous.

Description, &c. The stems are long and trailing, sometimes arching, glaucous and purplish in the sun, and green in the shade: they are brittle and full of pith. The flowers are large and white, and appear earlier than those of most of the British species. The berry is large, agreeably acid, of larger and fewer grains than in *R. fruticosus*, and of a browner black: they



are ripened before those of *R. fruticosus* and its allies. The young shoots of the current year sometimes take root at the extremity; and country nurses and quacks formerly used to pretend to cure children of the whooping-cough, by drawing them through the arch thus formed by the stem. (*Eng. Bot.*, ii. p. 409.)

According to Dr. Lindley, the following British kinds of *Rùbus* may be associated with *R. corylifolius* Smith, either as related species, or as varieties:—

R. macrophyllus Weihe & Nees, *Eng. Bot. Suppl.*, t. 2625. *The large-leaved Bramble.*

R. carpinifolius Weihe & Nees. *The Horn-beam-leaved Bramble.*

R. fusco-ater Weihe & Nees. *The brownish-black Bramble.*

R. Köhleri Weihe & Nees; *Eng. Bot. Suppl.*, t. 2605; *R. pallidus* Weihe & Nees, according to Lindley's *Syn. Köhler's Bramble.*

R. glandulosus Smith. *The glandulous-bristled Bramble.*

R. rudis Weihe & Nees; *R. echinatus* of ed. 1. of Lindl. *Synops.*, and our *H. B.*, No. 28335. *The rough Bramble.*

R. diversifolius Lindl. *Synops.*, ed. 1.; *R. diversifolius* Weihe, *Hort. Brit.*, No. 28330. *The diverse-leaved Bramble.*

Dr. Lindley has given brief distinctive characters of each of these kinds in his *Synopsis of the British Flora*, ed. 2.; to which work, and to our *Hortus Britannicus*, the reader is referred for more particulars respecting them.

✧ 18. *R. (C.) AGRESTIS* Waldst. & Kit. *The Field Bramble.*

Identification. Waldst. and Kit. *Plant. Rar. Hung.*, 3. p. 297. t. 268.; Dec. *Prod.*, 2. p. 559.; Don's *Mill.*, 2. p. 533.

Engraving. Waldst. and Kit. *Plant. Rar. Hung.*, 3. t. 268.

Spec. Char., &c. Stems suffruticose, procumbent, indistinctly angled, with straight, bristle-like prickles. Leaflets 3—5, roundish, lobed in a dentated manner, unequally serrated, hairy above, tomentose beneath. Calyx whitely tomentose and hispid, with glanded hairs. (*Dec. Prod.*, ii. p. 559.) A native of long neglected fields of Hungary and Transylvania. Seringe asks whether it may not be a variety of *R. tomentosus*, or rather of *R. corylifolius*.

✧ 19. *R. SPECTABILIS* Ph. *The showy-flowered Bramble.*

Identification. Ph. *Fl. Amer. Sept.*, 1. p. 348. t. 16.; Dec. *Prod.*, 2. p. 559.; Don's *Mill.*, 2. p. 533.

Synonyme. *R. ribifolius* Willd. *Herb.*, according to Steven.

Engravings. Ph. *Fl. Amer. Sept.*, t. 16.; *Bot. Reg.*, t. 1424; *Bot. Cab.*, t. 1602.; and our *fig.* 458.

Spec. Char., &c. Stem not bearing prickles, glabrous. Leaf of three leaflets, that are ovate, doubly and unequally

serrated, downy beneath. Flowers of an agreeable purplish colour, produced singly on terminal peduncles. Sepals oblong, rather abruptly acuminate, shorter than the petals. (*Dec. Prod.*, ii. p. 559.) An elegant shrubby bramble, growing to the height of 4 ft. or 5 ft., with subflexuose, round, smooth branches, and large dark-purple odoriferous flowers, which appear in April and May, and are succeeded by large dark-yellow fruit, of an acid and somewhat astringent taste, which make excellent tarts. It is a native of North America, on the banks of the Columbia, and was introduced in 1827 by Mr. Douglas. It merits a place in every collection, both as a flowering shrub, and for its fruit.

✧ 20. *R. ULMIFOLIUS* Schott. *The Elm-leaved Bramble.*

Identification. Schott in *Isis*, 1818, fasc. 5. p. 821.; *Lk. Enum.*, 2. p. 61.; Dec. *Prod.*, 2. p. 560.; Don's *Mill.*, 2. p. 534.

Spec. Char., &c. Stem decumbent, very prickly, frutescent. Branches very red. Leaflets 3—5, oval, rather heart-shaped, acutely and doubly crenated, tomentose beneath, without prickles. Flowers of a beautiful rose colour. (*Dec. Prod.*, ii. p. 560.) A native of Gibraltar, on the mountains; said to have been introduced in 1823. It flowers from June to September.

457



458

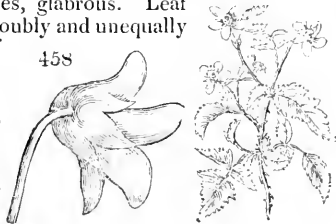

* 21. *R. LINKIÄNI*'S Ser. Link's Bramble.

Identification. Ser. in Dec. Prod., 2. p. 560.; Don's Mill., 2. p. 534.

Synonyme. *R. paniculatus* Schlecht., according to *Lk. Enum.*, 2. p. 61. and *Tratt. Ros.*, 3. p. 41., not of Smith.

Spec. Char., &c. Stem prickly. Leaflets 3—5, unequal, ovate acuminate, serrated, tomentose and hoary beneath. Flowers double, in a panicle. (*Dec. Prod.*, ii. p. 560.) It is said to have been introduced in 1821, and to produce double white flowers in June and July; but it is not stated of what country it is a native; and, whether it be any thing more than a double-flowered variety of the common bramble we have no means of ascertaining, never having seen the plant.

* 22. *R. FRUTICOSUS* L. The shrubby Bramble, or common Blackberry.

Identification. Lin. Sp., 707.; Weihe and Nees Rubi Germanici, p. 25.; Dec. Prod., ii. p. 561.; Don's Mill., 2. p. 534.

Synonymes. *R. discolor* and *R. abruptus*, in *Lindl. Synops. of Brit. Flora*, ed. 1.

Engravings. Eng. Bot., t. 715.; and our fig. 459.

Spec. Char., &c. Stem erect [and afterwards decurved], 5-angled, rather tomentose, bearing recurved prickles. Leaflets 3—5, ovate-oblong, acute, glabrous, beneath greyly tomentose, each on a secondary petiole. Panicle decomposed, narrow, straight. Flowers rose-coloured or white. Sepals reflexed, almost without prickles. Fruit of a purplish black. (*Dec. Prod.*, ii. p. 560.) A native of Europe, in hedges, thickets, and woods. In Britain abounding in the agricultural zone, and tolerably frequent in the upland zone; with, according to Mr. Winch, a limit similar to that of *Ulex europæa*.

*Varieties.*

* *R. f. 2 pomponius* Ser. *R. fruticosus* ♂ Weihe & Nees. (fig. 460.)—Flowers semidouble or double. Leaves pale green; leaflets obovate. Cultivated in gardens. This variety may be considered as highly ornamental, from the large size, and numerous petals, of its flowers, and from its very vigorous growth. Though it will thrive at the roots of trees, and in places where other ornamental plants will hardly grow, yet it produces most effect when it is trained against a wall; and it is thus treated in some of the principal gardens of Europe. One of the finest specimens we have ever seen of the double-flowering bramble was in the botanic garden at Pisa, in 1819, where it was trained against a wall, and covered with a profusion of large double white flowers, tinged with pink. Plants in the London nurseries, are 1s. 6d. each; and at Bollwyller 1 franc.

* *R. f. 3 tauricus* Hort. is a vigorous-growing plant, which produces by far the best fruit of any variety of bramble. There are plants in the Horticultural Society's Garden.

* *R. f. 4 flore roseo pleno* Baum. Cat., the double pink-flowered Bramble, is marked in the *Bollwyller Catalogue* at 3 francs a plant; but we have not seen it in British gardens.

* *R. f. 5 foliis variegatis*, the variegated-leaved Bramble, is not liable to the objections made to most variegated plants, it not having a diseased appearance.

* *R. f. 6 leucocarpus* Ser. — Fruit white. (*Dec. Prod.*, ii. p. 561.)

* *R. f. 7 inermis* Ser. — Stem without prickles. (*Dec. l. c.*)

* *R. f. 8 dalmaticus* Tratt. Ros., iii. p. 33.—Panicle very large, supradec-



compound, spreading. Flowers large, of a full rose colour. Calyxes without prickles. Peduncles mostly so. Leaves whitely tomentose beneath. A native of Dalmatia, in hedges, according to Portenschlag.

- * *R. f.* 9 *côncolor* Wallr. Sched., p. 233. — Leaves downy beneath, both surfaces of one colour. A native of Germany.
- * *R. f.* 10 *glandulosus* Wallr. Sched., p. 233. — Stems, petioles, and peduncles glabrous. A native of Germany.

The two following kinds of ligneous rubuses, found wild in Britain, Dr. Lindley supposes (*Synops. of Brit. Flora*, ed. 2.) to be closely allied to *R. fruticosus* L., or, perhaps, varieties of it.

- * *R. (f. 11) rhamnifolius* Weihe & Nees. *R. cordifolius*, in *Lindl. Synops. of Br. Fl.*, ed. 1.; and, it is most likely, *R. cordifolius* Weihe, *H. B.*, No. 13527. *The Buckthorn-leaved Bramble.*

- * *R. (f. 12) leucostachys* Schl. — *The white-spiked Bramble.*

Dr. Lindley has given distinctive characters to both of these kinds.

The following: *R. tomentosus* Weihe, and our *fig.* 461., *R. fastigiatus* Weihe, *R. ulzifolius* Weihe, *R. Ménkii* Weihe, *R. Schlechtendahlii* Weihe, *R. Schleicheri* Weihe, *R. horridus* Weihe, *R. nitidus* Weihe, and *R. rubricaulis* Weihe, are registered, and particulars given of them, in *H. B.*; and all of them, except the last, are described in *Dec. Prod.*, ii.; but, as we suppose many of them to be only modified forms of *R. fruticosus*, we shall omit their descriptions. Most of them are natives of Germany; but *R. horridus*, *R. nitidus*, and *R. fastigiatus* are also found wild in Britain.

Description, &c. The stems of this species, according to Sir J. E. Smith, are truly shrubby, of a dark red or purple, strongly angular, with intermediate furrows, many feet in length, tough and woody, biennial, if not perennial, flowering the second year; branched and leafy. The barren stems are smooth, arched, and sometimes taking root at their extremities; the blossom-bearing stems are erect, and slightly downy at the upper part. The leaves are firm and durable, and almost evergreen. The flowers are erect and handsome, and the petals of a delicate pink; rarely, if ever, white in Britain, though the authors of the *Rubi Germanici* describe them as generally white. The berry is nearly globular, and is composed of very numerous purplish black, smooth, juicy grains, of a sweet but mawkish flavour, ripening late in autumn. The ordinary season of ripening is early in September; but Sir J. E. Smith has remarked that the season of 1799 was so unfavourable, that scarcely any bramble-berries, or blackberries, as they are commonly called, were to be found ripe in October. This species is considered as being more common than any of the other brambles, and also as attaining a greater size. It is this sort which occurs most frequently in English hedges; and it has been justly remarked by H. C. Watson (*Outlines, &c.*, p. 137.), that brambles are more abundant, and much finer, in the hedges in England, than they are in Scotland; and that in the Highlands they form only a secondary feature in the physiognomy of vegetation. The cause why the brambles are so much finer in England than they are in Scotland is not altogether owing to the superiority of the English climate, but partly to the hedges in Scotland being formed solely of the hawthorn, and kept within much less bounds than they are in England. The bramble is never planted in Scotland, and is only occasionally found in hedges, in consequence of having been sown there by birds. It is always found to prosper best on a soil somewhat dry and gravelly; and, accordingly, Switzer, when speaking of choosing a soil and situation for a vineyard, recommends looking out for one where the bramble is abundant and vigorous.

Properties and Uses. The fruits, in some parts of England, are called bumblekites; and in others scaldberries, from their supposed quality of giving scald heads to children. They are considered astringent; but have been eaten by children, in every country where they grow wild, since the time of Pliny. They have also been used, both in France and England, to produce a sub-acid drink; an inferior description of wine; and, by fermentation and distillation, a strong spirit. In England, they are sometimes made into tarts; but

461



for this purpose they should be gathered before they are dead ripe; because, if left too long on the bush, they are apt to acquire a musty flavour. They are also used for making a rob, or jam, which is considered good for sore throats. In some parts of France, where they are called *mûres sauvages* (wild mulberries), they are used for colouring wine; and the red muscat of Toulon is so coloured. The juice, mixed with raisin wine before it has fermented, will give it both the colour and flavour of claret. Many medical properties were formerly attributed to this plant. In French Guiana, the fruit is gathered and given to swine. The leaves are sometimes used for feeding silkworms, as a substitute for those of the mulberry. They are much more astringent than the fruit; and a decoction of them, in the time of Gerard, was in repute as a gargle. The green twigs have been used in dyeing woollen, silk, and mohair, black. The common bramble has frequently been used for raising live hedges in a poor sandy soil (see *Martyn's Miller*, and *Young's Annals*, vol. ii. p. 342.); but it cannot be recommended for this purpose, on account of the great space which it occupies. On drift sands, the bramble may be sown or planted, with a view to fixing the soil, and as a preparation for forest trees. The shoots of *R. fruticosus*, and of all the strong-growing varieties of bramble, are used by thatchers for binding on their thatch; and the smaller shoots by the makers of straw beehives and straw seed-baskets, for sowing the different layers of straw rope together. For the latter purpose, the shoots are drawn through a cleft stick, as well to bruise them, and thus render them less liable to break when bent, as to deprive them of their prickles. Where *R. cæsius* abounds, its shoots are preferred by the makers of beehives, as being smaller and tougher; and those of *R. corylifolius* by the thatchers, as having fewer prickles. In landscape-gardening, where the object is to imitate wild nature, the common bramble forms an admirable plant; and, soon after the publication of Price's *Essays on the Picturesque*, it was used for this purpose at a few places, and, among others, at St. Mary's Isle; but there the contrast between wildness and high cultivation was not sufficiently great to render the effect produced of lasting interest. In consequence of feeling this, the braambles have, for a number of years past, been gradually being removed. Thickets of braambles, in some of the public squares in London, or in Hyde Park, or Kensington Gardens, would have the full effect of strongly contrasted character; but they could never be considered as producing scenery entitled to the appellation of artistical.

✱ 23. *R. SA'NCTUS* Schreb. The holy Bramble.

Identification. Schreb. Dec., p. 15. t. 8.; Desf. Cor., 80. t. 61.; Dec. Prod., 2. p. 561.; Don's Mill., 2. p. 535.

Synonymæ. *R. obtusifolius* Willd. *Enum. Suppl.*, 38., according to Link. *Enum.*, 2. p. 61. *Engravings.* Schreb. Dec., t. 8.; Desf. Cor., 80. t. 61.

Spec. Char., &c. Stem frutescent, indistinctly angled, downy, prickly with recurved prickles. Leaflets usually of 3 leaflets, rarely undivided. Leaflets ovate, obtuse, serrated, tomentose beneath. Flowers mostly terminal, in a sort of panicle. Sepals ovate, tomentose, reflexed, short. (*Dec. Prod.*, ii. p. 561.) A native of the East, but why called *sánctus* does not appear. It is a straggling prostrate plant, producing pink flowers in June and July, and said to have been in cultivation since 1823; but we have not seen it.

✱ 24. *R. CANE'SCENS* Dec. The grey Bramble.

Identification. Dec. Cat. Hort. Monsp., p. 159.; Fl. Fr., 5. p. 545.; Prod., 2. p. 561.; Don's Mill., 2. p. 535.

Spec. Char., &c. Stem shrubby, tall. Petioles and peduncles tomentose and prickly. Leaflets 5 or 3, obovate-oblong, toothed with a few large teeth, whitish and velvety upon both surfaces. Flowers in panicles. Calyx tomentose. (*Dec. Prod.*, ii. p. 561.) A native of the Alps of Piedmont, near Vinadio, with white flowers; said to have been introduced in 1820; but we have not seen the plant.

✱ 25. *R. SETO'SUS* Big. The bristly-stemmed Bramble.

Identification. Bigelow in Litt.; Dec. Prod., 2. p. 563.; Don's Mill., 2. p. 536.

Spec. Char., &c. Stem very hispid. Branches bristly at the tip. Leaves composed of a long petiole and 3 leaflets, that are obovate-wedge-shaped, serrated, and glabrous. Stipules spatulate-linear. Flowers upon filiform peduncles, and in racemes. Sepals lanceolate, tomentose, bristly. Petals obovate-wedge-shaped, longer than the sepals. (*Dec. Prod.*, ii. p. 563.) A native of North America, near Montreal, which we have not seen.

✱ 26. *R. ARGU'TUS* Lk. The sharp-toothed-leafleted Bramble.

Identification. Lk. *Enum.*, 2. p. 60.; Dec. Prod., 2. p. 563.; Don's Mill., 2. p. 537.

Spec. Char., &c. Stem frutescent, prickly and hairy. Prickles straightish, small. Leaflets 3-5, oblong, acuminate, rather tapered at the base, doubly and sharply serrate, downy beneath. Flowers

in a panicle. Corolla white. Petals tapered at the base. (*Dec. Prod.*, ii. p. 563.) A native of North America; said to have been introduced in 1823.

✱ 27. *R. CUNEIFOLIUS Ph.* The wedge-shaped-leafleted Bramble.

Identification. Ph. Fl. Amer. Sept., i. p. 347.; *Dec. Prod.*, 2. p. 563.; Don's Mill., 2. p. 537.

Synonymes. *R. parvifolius Walt. Fl. Carol.*, 149., *Tratt. Ros.*, 3. p. 49.

Spec. Char., &c. Imperfectly evergreen. Branches, petioles, and peduncles tomentose. Prickles recurved, scattered. Leaflets cuneate-ovate, in the terminal portion toothed, unequally plicate, and tomentose beneath. Flowers upon divaricate nearly naked pedicels, and disposed in terminal panicles. (*Dec. Prod.*, ii. p. 563.) According to Pursh, this is "a straggling briar, with a grey aspect; the berries hard and dry, and the flowers white." It is found in sandy fields and woods in New Jersey and Carolina, and was in cultivation in Britain in 1811.

✱ 28. *R. HISPIDUS L.* The hispid-stemmed Bramble.

Identification. Lin. Sp., 706.; *Dec. Prod.*, 2. p. 564.; Don's Mill., 2. p. 539.

Synonymes. *R. trivialis Michx. Fl. Bor. Amer.*, p. 296.; *R. procumbens*

Müht.; *R. flagellaris Willd.*, according to *Spreng. Syst.*, 2. p. 530.

Engravings. Hayne *Abbild.*, t. 71.; and our *fig.* 462.

Spec. Char., &c. Stem procumbent, round, very hispid, bearing scattered bristles and recurved prickles. Leaflets 3-5, wedge-shaped at the base, unequally toothed, pretty glabrous above. Flowers solitary, upon longish peduncles. Petals obovate. Carpels black. (*Dec. Prod.*, ii. p. 564.) A native of Canada, with procumbent stems, flowering in August, and said to have been in cultivation in Britain since 1759.



✱ 29. *R. LANUGINOSUS Stev.* The woolly Bramble.

Identification. Stev. Obs. ined. in H. Willd.; *Dec. Prod.*, ii., p. 564.; Don's Mill., 2. p. 538.

Spec. Char., &c. The flower-bearing stem 1 ft. high. Petioles and peduncles tomentose. Prickles straight, few. Leaflets 3, ovate, with a heart-shaped base and acuminate extremity, sharply toothed with mucronate teeth, villose on both surfaces. Panicles terminal, many flowered. Sepals upright, villose without, within whitely tomentose, shortly awned. Bractees awl-shaped. (*Dec. Prod.*, ii. p. 564.) A native of Caucasus and Siberia, with prostrate stems; said to have been introduced in 1820.

✱ 30. *R. CANADENSIS L.* The Canadian Bramble.

Identification. Lin. Sp., 707., exclusive of the synonyme of Mill. Icon.; Don's Mill., 2. p. 538.

Spec. Char., &c. Stem purple, almost glabrous. Leaflets 3-5, lanceolate, sharply serrate, glabrous on both surfaces. Stipules linear, a little prickly. (*Dec. Prod.*, ii. p. 564.) A native of North America, in rocky woody places from Canada to Virginia; with prostrate stems and white flowers; said to have been introduced in 1811.

§ iii. *Leaves lobed, not pinnate or digitate.*

✱ 31. *R. ODORATUS L.* The sweet-scented Bramble.

Identification. Lin. Sp., 707.; *Dec. Prod.*, 2. p. 566.; Don's Mill., 2. p. 539.

Synonymes. *R. occidentalis Hort.*, but not of Lin.; the Virginian Raspberry, the flowering Raspberry.

Engravings. Mill. Ic., t. 223.; *Bot. Mag.*, t. 323.; and our *fig.* 463.

Spec. Char., &c. Stem upright. Petioles, peduncles, and calyxes bearing glanded hairs. Disks of leaves 5-lobed, unequally toothed. Inflorescence subcorymbose. Flowers large, showy, red. Sepals ovate, longly acuminate, shorter than the petals. Carpels numerous, ovate, velvety. Style funnel-shaped. Fruit red. (*Dec. Prod.*, ii. p. 566.) This species is allied by its fruit to *R. idæus*. It is a native of North America, in woods; and has been in cultivation in Britain since 1739. It grows to the height of 4 ft. or 6 ft.; and produces its showy purplish red flowers, in abundance, from June to September. These are not succeeded by fruit in this country; but Pursh informs us that, in a wild state, the fruit is yellow, and of a very fine flavour, and a large size. "Cornutus, who first figured and described this plant, gave it the name of odoratus, on account of the fragrance of its foliage." (*Bot. Mag.*, t. 323.) It is abundant in the woods of Canada, and on the Alleghany Mountains.



✱ 32. *R. NUTKANUS Moc.* The Nootka Sound Bramble.

Identification. Mocino Pl. Nutk.; *Dec. Prod.*, 2. p. 566.; *Bot. Reg.*, t. 1368.; Don's Mill., 2. p. 540.

Synonymes. *R. odoratus Hort.*, but not of Lin.

Engravings. Mocino Pl. Nutk.; *Bot. Reg.*, t. 1368.; and our *fig.* 464.

Spec. Char., &c. Stem glutinous. Branches round, glabrous, rufous. Leaves 5-lobed, unequally toothed. Inflorescence subcorymbose. Flowers about

four in a corymb, white. Sepals ovate, longly acuminate, glabrous, as long as the petals. Allied to *R. odoratus*, but the peduncle and calyx are glabrous. (*Dec. Prod.*, ii. p. 566.) A native of the north-west coast of North America, from New California to Nootka Sound, and at various places between north latitude 43° and 52°, in mountains and woods. It was discovered by the unfortunate Douglas, and introduced into Britain in 1826. It grows, in good soil, to the height of 5 ft. or 6 ft., and has the general aspect and appearance of *R. odoratus*, except being of a paler green. It flowers from May to October, and the flowers are white. These are succeeded by large red berries, which are found to make excellent tarts; and the plant will probably soon be ranked as a fruit shrub. There are fine plants of this species in the Horticultural Society's Garden, and at High Clere; and they may be purchased in the London nurseries at from 1s. 6d. to 2s. each.



464

App. i. Species and Varieties of *Rubus* best deserving of Cultivation in British Gardens, as ornamental Shrubs.

A. Erect Raspberry-like Sorts.

- R. occidentalis*, the western, or black, Raspberry, No. 7.; and fig. 451. in p. 736.
R. nutkanus, the Nootka Sound Raspberry, No. 32.; and fig. 464. in p. 746.
R. odoratus, the sweet-scented, or Virginian, Raspberry, No. 31.; and fig. 463. in p. 745.
R. spectabilis, the showy-flowered Raspberry, No. 19.; and fig. 458. in p. 741.
R. idæus, the Mount Ida, or common, Raspberry, No. 9.; and fig. 452. in p. 737. The varieties of this species which are recommended are those enumerated in p. 738., as being most suitable for planting in an arboretum.

B. Shrubby Brambles.

- R. suberectus*, the sub-erect Bramble, No. 1. p. 735.
R. micranthus, the small-flowered, or Nepal, Bramble, No. 4.; and figs. 449—450.—450. a, in p. 736.
R. fruticosus, the shrubby Bramble, or common Blackberry, No. 20.; and fig. 453. in p. 742. The varieties recommended are, the double-flowered, the double pink-flowered (if it can be got), the variegated-leaved, and *R. f. taoricus*, on account of its large and excellent fruit.
R. corylifolius, the Hazel-leaved Bramble, No. 15.; and fig. 457. in p. 741.

C. Prostrate Brambles.

- R. cæsius*, the grey Bramble, or Dewberry, No. 11.; and fig. 454. in p. 739. The variety recommended, in addition to the species, is that with variegated leaves.
R. laciniatus, the cut-leaved Bramble, No. 10.; and fig. 455. in p. 739.

Remark. The plants in the last two groups are propagated by division of the roots, or by encouraging the points of the shoots to root, like the runners of a strawberry; and the plants in the first group by division of the root, or by suckers. All the kinds may be propagated by layers or cuttings of the current year's wood, with the leaves on in a growing state; and the cuttings in sand under a glass, but not readily.

App. ii. Other Sorts of shrubby Rubuses.

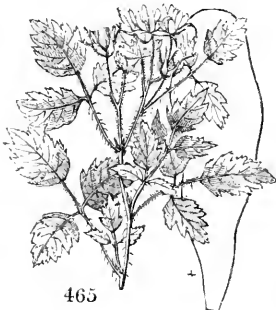

465

Of the 147 species described in Don's *Miller*, about 50 are included in the above list; and nearly 50 more are herbaceous, or green-house or stove plants. There remain between 40 and 50 names, which are chiefly of species not introduced.

R. macropetalus Doug. MS. in *Hook. Fl. Bor. Amer.*, p. 178. t. 59., and our fig. 465., is a native of low woods in the valley of the Columbia, with white flowers, and the general habit of *R. spectabilis*.

R. deliciosus Torrey in *Ann. Lyc.*, ii. p. 196., is a native of North America, among the Rocky Mountains; with purple flowers, succeeded by a very delicious fruit. It is a shrubby bramble, 5 ft. or 6 ft. high.

R. tiliaceus Smith in *Rees Cycl.*, vol. xxx., is a native of Upper Nepal, with white flowers, and leaves like



466

those of *Tilia álba*; *R. cordifólius* *D. Don* appears to be the same species, or perhaps a variety. There is a plant in the Horticultural Society's Garden.

R. acuminátus Smith, *R. betulinus* *D. Don*, is a native of Nepal, with leaves like those of the birch or hornbeam.

R. reflexus Ker (*Bot. Reg.*, t. 461; and our fig. 466.), *R. moluccânus* *Ait.*, but not of Lin., is a straggling shrub, a native of China, from which country it was brought to the Kew Garden in 1817. The leaves are oblong-cordate, 3—5-lobed, densely clothed with tomentum beneath, as are the stems and flower buds, and the flowers are white. It appears a very distinct species.

R. rosefólius Smith (*Don's Mill.*, 2. p. 529; *Bot. Cab.*, t. 158.) is a native of the Mauritius, with pinnate leaves. It is generally kept in the greenhouse.

R. r. 2 coronárius Sims (*Bot. Mag.*, t. 1783; and our fig. 467.), *R. sinéncis* *Hort.*, *R. Commersônia* *Poir.*, has double white flowers. This beautiful variety is rather tender; but a plant stood out against the wall in the Horticultural Society's Garden for two years.



467

GENUS X.



POTENTILLA *L.* THE POTENTILLA, or SHRUBBY CINQUEFOIL.
Lin. Syst. Icosándria Polygúnia.

Identification. *Lin. Gen.*, No. 865; *Nestl. Pot. Diss.*, 4to.; *Lehm. Pot. Diss.*, 4to.; *Dec. Prod.*, 2. p. 571.; *Don's Mill.*, 2. p. 549.

Derivation. From *potens*, powerful; in allusion to the supposed medicinal qualities of some species.

Description, &c. The ligneous species are low shrubs with pinnatifid leaves, natives of Europe and America, and of easy culture in a dry soil. They are propagated by seeds or cuttings; and, except the common species, *P. fruticósa*, are not much in cultivation. Of the varieties of *P. fruticósa*, *P. f. tenuiflora* *Ser.* seems the most showy. Those who wish to include as many species as they can in their arboretum, may subjoin to the genus *Potentilla* the genus *Cómarum*; *C. palústre* (*P. Cómarum* *Scop.*), a well-known British plant, having somewhat ligneous shoots. It grows to the height of 1½ ft. in marshy soils; has very handsome foliage, and flowers of a deep dingy purple; and may prove useful in particular situations on the margins of ponds.

§ 1. *P. FRUTICÓSA* *L.* The shrubby *Potentilla*, or *Cinquefoil*.

Identification. *Lin. Sp.*, 709.; *Dec. Prod.*, 2. p. 579.; *Don's Mill.*, 2. p. 560.; *Nestl. Pot.*; *Lehm. Pot.*; *Smith's Eng. Flora*, 2. p. 416.

Engravings. *Eng. Bot.*, t. 88.; *Nestl. Pot.*, 30. t. 1.; and our fig. 468.

Spec. Char., &c. Stem shrubby.

Leaves pinnately cut, hairy; the lobes oblong, lanceolate, entire, approximate, of nearly the same colour on both surfaces. Stipules lanceolate, membranaceous, acute. Inflorescence rather corymbose. Flowers yellow. Sepals pilose, lanceolate, acute, broad at the base. Bracteas linear-lanceolate, indistinctly petioled. Corolla longer than the calyx. Receptacle very hairy. (*Dec. Prod.*, ii. p. 579.) A native of England, Germany, the Pyrenees, and other places. Found in different parts in Middleton, Teesdale, in England; and Rock Forest, Clare, in Ireland; flowering in June. This species is the only one common in British nurseries.

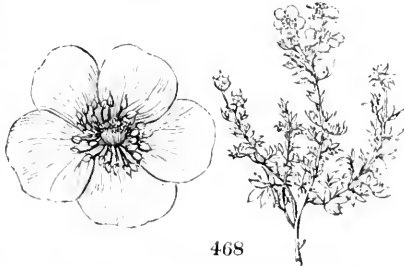

468

Varieties, according to *Seringe*, in *Dec. Prod.*

§ *P. f. 2 dahúrica* *Ser.* *P. dahúrica* *Nestl. Pot.*, 31. t. 1.; *Hort. Brit.*, No. 29143.; *P. fruticósa* β *Lehm. Pot.*, 32. — Glabrous. Lobes of the leaves 3—5, pinnately cut. Sepals

shorter and broader than the bracteoles. Spontaneous in Dahuria, and introduced into Britain in 1824; and producing its yellow flowers in July.

- ♣ *P. f. 3 tenuiloba* Ser. *P. fruticosa* 3 *Nestl. Pot.*, 30; *Lehm. Pot.*, 32, var. 2; *P. floribunda Ph. Fl. Amer. Sept. 1.* p. 355.; *Hort. Brit.*, No. 13578.; *Watson's Dend. Brit.*, t. 70.; *P. tenuifolia Schlectend. Bert. Mag.*, according to *Lehm. Pot.*, 32.; and our fig. 469. — Sepals and lobes of the leaves narrow, and with a slight hoary silkiness. A native of North America, found in bog meadows, and on the borders of lakes, in Canada, and on the mountains in the states of New York and New Jersey; where it is a low-growing shrub, not above 18 in. high. It was also found by Pallas in Siberia.



469

- ♣ 2. *P. GLABRA* Lodd. The glabrous Potentilla.

Identification. Lodd. *Bot. Cab.*, t. 914.; *Dec. Prod.*, 2. p. 584.; *Don's Mill.*, 2. p. 561.

Synonyme. *P. fruticosa alba* *Busch*, according to *Lodd. Bot. Cab.* t. 914.

Engravings. *Lodd. Bot. Cab.*, t. 914.; and our fig. 470.

Spec. Char., &c. Frutescent. Branches pendulous, purple. Leaves pinnately cut into 5 entire lobes. Flowers terminal, white, of the size of those of the wood strawberry (*Fragaria vesca*). (*Dec. Prod.*, ii. p. 584.) A beautiful little shrub, a native of Siberia; differing from *P. fruticosa* in being perfectly smooth in all its parts, and in having pendulous branches and undulated leaves. It thrives best in a mixture of loam and peat, is of slow growth, and difficult to increase, except by seed. It was sent by M. Busch of St. Petersburg, to Messrs. Loddiges, in 1822, and deserves a place in every general collection.

470

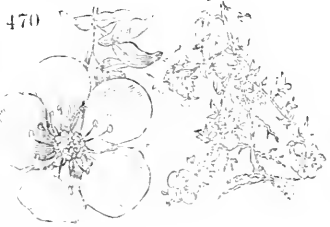

- ♣ 3. *P. SALESOVII* Steph. Salesovius's Potentilla.

Identification. Steph., according to *Willd. Enum.*, p. 552.; *Nestl. Pot.*, 31.; *Lehm. Pot.*, 35. t. 1.; *Dec. Prod.*, 2. p. 583.

Engraving. *Lehm. Pot.*, 35. t. 1.

Spec. Char., &c. Habit resembling that of *Cómarum palústre*. Stem suffruticose. Leaves pinnately cut, coriaceous. Lobes oblong, acutely serrate, pubescent above upon the veins, whitely tomentose beneath. Stipules lanceolate, very acute, entire, rather filmy at the edge. Flowers large, white, upon short peduncles, and grouped. Sepals lanceolate, very acute, broad, almost as long as the petals, which are obovate. Bracteoles very narrow, smaller than the sepals. Receptacle lanuginose. (*Dec. Prod.*, ii. p. 583.) A native of Siberia, introduced in 1823, and growing to the height of 1 ft. or 2 ft.; flowering in June and July.

Sect. IV. RO'SÆ Dec.

GENUS XI.



RO'SA *Tourn.* THE ROSE TREE. *Lin. Syst.* Icosándria Polygýnia.

Identification. *Tourn. Inst.*, 1. p. 636. t. 408.; *Lin. Gen.*, 631.; *Lam. Ill.*, t. 440.; *Lindl. Ros. Mon.*, Svo, 1820; *Pronville's Nomen. Rais*, 1818, *Monog. Ros.*, 1824; *Don's Mill.*, 2. p. 564.

Synonyms. *Rhodóphora* *Neck. Elem.*; *Rosier*, *Fr.*; *Rosenstock*, *Ger.*; *Roozeboom*, *Dutch*; *Rosajo*, *Ital.*; *Rosal*, *Span.*; and *Roseira*, *Portuguese*.

Derivation. From *rhos*, red, Celtic; in reference to the colour of the flowers of most of the species.

Description, &c. Shrubs, for the most part deciduous, with pinnate leaves, and large, showy, beautiful, and fragrant flowers. They are natives of Europe, and of the temperate regions of Africa, Asia, and America, but not of

Australia; and they have been in cultivation in the Old World, for the beauty and fragrance of their flowers, from time immemorial. As the culture of roses belongs more to floriculture than to arboriculture, it will be found given at greater length in our *Encyclopædia of Gardening*, than we should here feel ourselves justified in entering into; because the forcing of roses, for example, cannot be considered as belonging to arboriculture. Nevertheless, we shall, after having described the different species, and described or enumerated their principal botanical varieties, treat, in a succinct manner on all the points which merit the attention of either the arboriculturist or the florist. After each species, therefore, we shall only touch on those points of culture and management which are peculiar to it, reserving what is general to all the species for a concluding article.

The genus *Rosa* is in a state of confusion still greater than that which subsists among the different kinds of *Rubus*; nor can it well be otherwise, when we consider that the greater number of kinds in cultivation are garden productions, and that the wild kinds differ exceedingly according to soil and situation, and have been chiefly described by botanists from dried specimens. In general, if the reader considers the plant at the head of each section in our arrangement as a species, and all the others as varieties, or races; or, perhaps, as subspecies, or hybrids, which have originated between it and some other section, he will err on the safe side. Nature, it is observed in the *Nouveau Du Hamel*, “appears scarcely to have placed any limit between the different species of the rose; and, if it is already very difficult to define the wild species, which have not yet been modified by culture, it is almost impossible to refer to their original type the numerous varieties which culture has made in the flowers of species already so nearly resembling each other.” (*N. Du Ham.*, vii. p. 55.)

The best scientific work on the genus *Rosa* is considered to be the *Rosarum Monographia* of Dr. Lindley, in one vol. 8vo, published in 1819, in which above 100 sorts are described, and some of them figured. *A Collection of Roses from Nature*, by Miss Lawrence, contains figures of 90 sorts, and is a valuable popular work. An article on the Scotch roses, by Mr. Sabine, in *Hort. Trans.*, vol. iv., contains a copious account of the principal varieties which were raised, previously to the date of the paper, from the *Rosa spinosissima*. The last British popular work which we shall mention on the rose is the *New Descriptive Catalogue of Roses cultivated in the Sawbridgeworth Nursery*; which, for those who cultivate the rose as a florist's flower, is the best English work extant. (See a review of it in *Gard. Mag.*, vol. x. p. 509.) In France, the first grand work on roses was a folio volume, entitled *Les Roses*, by Redouté and Thory; previously to which, in 1800, was published *L'Histoire Naturelle de la Rose*, by Guillemeau. *Prodrome de la Monographie du Genre Rosier* was published by Thory in 1820; and, about the same time, a *Nomenclature Raisonnée*, by Pronville; and various nurserymen's catalogues, new editions of which, containing numerous additional sorts, are continually being published. In the *Bon Jardinier* for 1836 a good selection of sorts is given, and the names of all the principal persons by whom roses are cultivated for sale on the Continent. The substance of all that has been written on roses, as far as respects describing species and varieties, will be found in Don's *Miller*, vol. ii., which includes 205 species. The arrangement is nearly the same as that of Lindley's *Rosarum Monographia*; and the descriptions are taken either from that work, or from De Candolle's *Prodromus*, with a few exceptions.

We have adopted the arrangement in Don's *Miller*, with the exception of omitting the first section, *Simplicifolia*, now made a separate genus by Dr. Lindley; and we have taken a number of the specific characters from that work, translating the others from De Candolle's *Prodromus*.

The best collection of species and varieties of roses in the neighbourhood of London is in the arboretum of Messrs. Loddiges; and, perhaps, the best general collection of florist's roses is in the Hammersmith Nursery. In the Horticultural Society's Garden there is a good selection of florist's roses; there are also good collections in the Brenchly and Mansfield Nurseries, both

near Tunbridge Wells. The best collection of roses in England is, however, unquestionably, that of Messrs. Rivers and Son at Sawbridgeworth; and the best in France, that of the private garden of the Luxembourg Palace. This garden has long been under the management of Mr. Hardy, who has always been an assiduous collector of roses from all countries, and who has raised a great many new sorts from seed. In this garden there are some of, perhaps, the largest standard roses in the world, many of which have stems 4 ft. or 5 ft. high, and as thick as a stout man's leg. (See *Gard. Mag.*, ii. p. 215., and xii. p. 225.)

§ i. *Feroces* Lindl. Mon., p. 3.

Derivation. From *ferox*, fierce; in reference to the branches being thickly beset with prickles.

Sect. Char. Branches clothed with permanent tomentum. Fruit naked. The plants contained in this section are a truly natural group; they are low shrubs, losing their leaves early in autumn, and are then remarkable for their hoary branches, bristles, and numerous prickles. Their fruit is perfectly smooth, which separates them from the next section, in which the fruit is downy. Sepals usually toothed. (*Don's Mill.*, ii. p. 565.)

1. *R. FEROX* Lawr. The fiercely-prickled Rose.

Identification. Lawr. Ros., t. 42.; Don's Mill., 2. p. 565.

Synonymes. *R. kamtschatica* Red. Ros., 1. p. 47.; *R. kamshatica* β *ferox* Scr. in Dec. Prod., 2. p. 607.; *R. echinata* Dupont.
Engravings. Lawr. Ros., t. 42.; Red. Ros., 1. p. 47. t. 12.; and our fig. 471.

Spec. Char., &c. Prickles all alike in shape, and much crowded. Flowers large, red. Fruit globose, scarlet. (*Don's Mill.*, ii. p. 565.) A shrub, a native of Caucasus, introduced in 1796, growing to the height of 3 ft. or 4 ft., and flowering in July and August. A singular shrub, and on that account deserving a place in collections.



Variety.

1. *R. f. 2 nitens* Lindl. in *Bot. Reg.*, t. 824., *Ser.* in *Dec. Prod.*, ii. p. 607, has shining pale green glabrous leaves, and pale crimson flowers.

2. *R. (F.) KAMTSCHATICA* Vent. The Kamtschatka Rose.

Identification. Vent. Cels., t. 67.; Don's Mill., 2. p. 565.

Engravings. Vent. Cels., t. 67.; N. Du Ham., vol. 7. t. 10. f. 2.; and our fig. 472.

Spec. Char., &c. Prickles infra-stipular, falcate, large. Leaves opaque. Flowers solitary, deep red. Fruit spherical, scarlet, less than that of *R. ferox*. (*Don's Mill.*, ii. p. 565.) Native of Kamtschatka, in dry rocky places. Introduced in 1791; growing to the height of 3 ft. or 4 ft., and flowering in June and July. From the appearance of the plants bearing this name in the extensive collection in Messrs. Loddiges's arboretum, we should consider it to be only a variety of *R. ferox*. It is, however, very distinct, and well deserving a place in collections.



§ ii. *Bracteata*.

Sect. Char. Branches and fruit clothed with permanent tomentum. This section is readily distinguished from the last by the woolliness of the fruit. Leaves dense, usually shining, and prickles placed under the stipules in pairs. Sepals simple, or nearly so. (*Don's Mill.*, ii. p. 565.)

3. *R. BRACTEATA* Wendl. The large-bracted Rose.

Identification. Wendl. Obs., 50.; Hort. Herrenhaus., fasc. 4. p. 7. t. 22.; Red. Ros., 1. p. 35, ic.; Lindl. Ros. Mon., p. 10.; Dec. Prod., 2. p. 602.; Don's Mill., 2. p. 565.

Synonymy. Lord Macartney's Rose.

Engravings. Wendl. Hort. Herrenhaus., fasc. 4. t. 22.; Red. Ros., 1. p. 35, ic.; Vent. Cels., 28.; N. Du Ham., 7. t. 13.; and our fig. 473.

Spec. Char., &c. Evergreen. Branches upright, tomentose. Prickles stout, recurved, in many instances in pairs. Leaflets 5—9, obovate, subserrate, coriaceous, glossy, glabrous. Stipules scarcely attached to the petiole, bristle-shaped, but fringed. Flowers solitary, terminal, white,

large. Peduncles and calyces tomentose. Fruit globose, large, orange red. (*Dec. Prod.*, ii. p. 602.) Flowers showy, pure white, solitary, nearly sessile. Fruit spherical, orange red. Native of China. Introduced by Lord Macartney, in 1795; growing to the height of 5 ft. or 6 ft., and flowering from June to October. A very ornamental shrub, evergreen, with large white flowers, and numerous bright yellow stamens and styles. It flowers abundantly, but is rather tender. It succeeds best when trained against a wall.



473

Varieties

❖ *R. b. 2 scabrifolia* Lindl. (*Rosar. Monog.*, p. 10.; *Sims Bot. Mag.*, t. 1371.)—Branches bristly. Prickles smaller than in the species, and rather straight. A native of China, in the province of Tchetchiang. (*Dec. Prod.*, ii. p. 602.) In the collection of Messrs. Loddiges, besides *R. bracteata*, there are *R. b. varia*, and *R. b. flore pleno*.

❖ 4. *R. (B.) MICROPHYLLA* Roxb. The small-leafleted Rose.

Identification. Roxb. Fl. Ind. ined., according to Lindl. *Rosar. Monog.*, p. 9. 143, 146.; *Dec. Prod.*, 2. p. 602.; *Don's Mill.*, 2. p. 563.

Synonyme. Hoi-tong-hong, *Chinese*.

Engravings. Bot. Reg., t. 919.; and our fig. 474.

Spec. Char., &c. Stem almost without prickles. Leaflets glossy, sharply serrated, veiny beneath, with densely netted, anastomosing veins. Stipules very narrow, unequal. Flowers double, of a delicate rose-colour. Calyx densely invested with prickles. Sepals short, broadly ovate, echinate, ending in a point. Prickles having at the base two longitudinal furrows. (*Dec. Prod.*, ii. p. 602.) Flowers very large, double, and of a delicate blush colour. Native of China. Introduced in 1828, or before; growing to the height of 2 ft. or 3 ft., and flowering from August to October. An interesting little shrub, but somewhat tender, like *R. bracteata*.



474

❖ 5. *R. (B.) INVOLUCRATA* Roxb. The involucred-corymbed Rose.

Identification. Roxb. Fl. Ind. ined., according to Lindl. *Rosar. Monog.*, p. 8.; *Dec. Prod.*, 2. p. 602.; *Don's Mill.*, 2. p. 505.

Synonymes. *R. Lindleyana* Tratt. *Ros.*, 2. p. 190.; *R. palustris Buchan.* (*Ham.*) *MSS.*, according to Lindl. *Rosar. Monog.*, p. 8.

Engravings. Bot. Reg., t. 739.; and our fig. 475.

Spec. Char., &c. Shoots long, tender. Branches pale brown, tomentose, scarcely prickly. Leaflets 3—9, elliptical-lanceolate, tomentose beneath. Stipules hardly attached to the petiole, bristle-like-fringed. Flowers terminal, mostly solitary, white. Peduncles and calyces tomentose. (*Dec. Prod.*, ii. p. 602.) Seringe seems to consider this as a variety of *R. bracteata*. It is a native of Nepal and China, with white flowers in corymbs, surrounded by three or four approximate leaves. It was introduced in 1818; grows to the height of 3 ft. or 4 ft.; and flowers in June and July. Plants of this kind, which is very distinct both in its foliage and its flowers, are rare in collections. Being somewhat tender, it is greatly improved in growth by the protection of a wall, on which it makes a fine appearance. On the rose wall at Messrs. Loddiges, three years ago, there was a plant of *R. involucrata*, which had attained the height of the wall (11 ft.), and which flowered magnificently.



475

§ iii. *Cinnamomeæ* Lindl. Ros., p. 13.

Scot. Char. Plants setigerous or unarmed, bracteate. Leaflets lanceolate glandless. Disk thin, never thickened. This section is distinguished by its long lanceolate leaflets, without glands, upright shoots, and compact habit. Red flowers, never solitary, except by abortion, and always supported by bracteas. Round, small, red fruit (soon losing its long narrow

sepals), and with small, smooth, shining carpels. The shoots are usually setigerous next the ground; but rarely so towards the apex, except in one or two instances. *R. alpina* and *R. acicularis*, of the following division, sometimes have bracteas; but their sepals never fall off till the fruit is decayed. Sepals simple, entire, or nearly so, unless when mentioned otherwise. (*Don's Mill.*, ii. p. 565.) Plants of most of the species are in cultivation in British gardens.

✽ 6. *R. LUCIDA* Ehrh. The shining-leaved Rose.

Identification. Ehrh. Beitr., 4. p. 22.; Red. and Thor. Ros., 1. p. 45. ic.; Lindl. Rosar. Monog., p. 17.; Jacq. Fragm., t. 107. f. 3.; Dec. Prod., 2. p. 602.; Don's Mill., 2. p. 565.

Synonymes. *R. rubra lucida* Rossig. Ros., t. 7. and t. 25. f. 1.; *R. lucida* Jacq. Fragm., 71.; Rose Turneps; Rosier à Feuilles de Frêne, Fr.

Engravings. Red. and Thor. Ros., 1. p. 45. ic.; Jacq. Fragm., t. 107. f. 3.; Dill. Elth., 325. t. 245. f. 316.; N. Du Ham., vol. 7. t. 7.; and our fig. 476.

Spec. Char., &c. Prickles recurved, or none. Leaflets 5—9, lanceolate-elliptical, coriaceous, bluntly serrated, glossy. Stipules dilated, large, finely serrated, and extended as far as to the leaflets. Peduncles somewhat hispid. Flowers red, and opening late in the season. Sepals almost entire, appendicled, spreading. Fruit oblatly globose, a little hispid or glabrous, scarlet. (*Dec. Prod.*, ii. p. 602.) Flowers red, overtopped by the leaves and young branches. Fruit bright red. A native of North America, from New York to Carolina; near Boston, in bogs, and on the edges of marshes, and in Newfoundland. Growing from the height of 4 ft. to 6 ft., and flowering from June to August. A handsome species, on account of its shining foliage, and one which is very hardy; but the flowers have a very disagreeable smell.



✽ 7. *R. (L.) NITIDA* W. The glossy-leaved Rose.

Identification. Willd. Enum., 544.; Lindl. Rosar. Monog., p. 13.; Dec. Prod., 2. p. 603.; Don's Mill., 2. p. 565.

Synonymes. *R. Redutæa rufescens* Thory in Red. Ros., 1. p. 103. ic.; the dwarf Labrador Rose.

Engravings. Lindl. Rosar. Monog., p. 13. t. 2.; Redouté Ros., 1. p. 103. ic.; and our fig. 477.

Spec. Char., &c. Dwarf and reddish in aspect. Stem and branches almost covered with slender, rather equal prickles. Leaflets 5—9, rather rigid, lanceolate, glossy. Stipules large, finely serrated, extending as far as to the leaflets. Flowers red. Peduncle bristly. Sepals spreading. Fruit bristly, shining, and scarlet. (*Dec. Prod.*, 2. p. 603.) A shrub, a native of Newfoundland, beset with straight red spines. Flowers deep red. Fruit depressed, spherical, bright scarlet. Introduced in 1807; growing to the height of 2 ft., and flowering from June to August. This is an interesting plant, from its dwarf stature, its abundant reddish prickles, its glossy leaves, its flowers, and its fruit. Seringe seems to think it a variety of *R. lucida*. The *R. nitida*, which forms No. 36. in *Lodd. Cat.*, ed. 1836, is a variety of *R. ferox*.



✽ 8. *R. (L.) RA'PA* Bosc. The Turnip-fruited Rose.

Identification. Bosc Dict. d'Agric., according to Poir. Suppl., 4. p. 710.; Lindl. Rosar. Monog., p. 15.; Red. and Thor. Ros., 2. p. 7. ic.; Dec. Prod., 2. p. 602.; Don's Mill., 2. p. 565.

Synonymes. *R. turgida* Pers. Ench., 2. p. 49.; *R. fraxinifolia* Dumont in Cours. Bot. Cult.

Engravings. Red. and Thor. Ros., 2. p. 7. ic.; and our fig. 478.

Spec. Char., &c. Taller than *R. lucida*, and spreading. Branches without prickles. Leaflets oblong, undulate, shining. Fruit hemispherical. Closely allied to *R. lucida*, of which it is very likely a variety. (*Dec. Prod.*, ii. p. 602.) Petals always multiplied, smaller than those of *R. lucida*; bright red. Fruit deep red. Sepals compound. Native of North America, in the warmer states; growing from 3 ft. to 4 ft. high, and

flowering from June to August. This is only known in its double-flowered state in British gardens. It is a freely growing hardy plant, with large double flowers, and is desirable both in flower-gardens and shrubberies. It is not of a robust habit, but forms a bush about 3 ft., or perhaps more, in height. According to Dr. Lindley, this rose forms a taller bush than *R. lucida*, but is of a more straggling habit. It is, he says, "a naked straggling briar, with scarcely a vestige of prickles on the shoots; its flowers are on long stalks, the mouth of the fruit is so wide, that the fruit itself is nearly hemispherical; and the sepals are reflexed." (*Ros. Monog.*, p. 16.)



♣ 9. *R. Woo'DSI* Lindl. Woods's Rose.

Identification. Lindl. *Ros.*, p. 21.; Don's *Mill.*, 2. p. 566.
Synonymes. *R. lutea nigra* *Pronv. Nom.*, p. 24.
Engraving. Lindl. *Bot. Reg.*, t. 976.

Spec. Char., &c. Stipules and sepals connivent. Leaflets oblong, obtuse, glabrous. (*Don's Mill.*, ii. p. 566.) A low shrub, with dull dark branches. Flowers pink. Fruit ovate, naked. There is a plant which was gathered about Cumberland House Fort, which Mr. Borrer takes to be a variety of the present species, having the leaves downy beneath. A native of North America, near the Missouri, and north of the Saskatchewan, and as far as the Bear Lake; growing to the height of 2 ft. or 3 ft., and flowering from March to June.

♣ 10. *R. FRUTETORUM* Bess. The Coppice Rose.

Identification. Bess. ex Spreng. *Syst.*, 2. p. 548.; Don's *Mill.*, 2. p. 565.

Spec. Char., &c. Prickles almost stipular, strong, reflexed. Petioles unarmed, and, as well as the under surface of the leaves, villous. Leaflets elliptic. Peduncles very short, glabrous. Fruit globose, glabrous. (*Don's Mill.*, ii. p. 565.) Native of Volhynia. Introduced in 1818; growing to the height of from 5 ft. to 6 ft., and flowering in June and July.

♣ 11. *R. CAROLINA* Lin. The Carolina Rose.

Identification. Lin. *Sp.*, 703.; Don's *Mill.*, 2. p. 566.

Synonymes. *R. virginiana Du Roi Harbk.*, 2. p. 353.; *Rossig. Ros.*, t. 13.; *R. palustris Marsh. Arbr.*, 135.; *R. corymbosa Ehrh. Beitr.*, 4. p. 21.; *R. pennsylvanica Mich. Fl. Bor. Amer.*, I. p. 296.; *R. Hudsoniana Red. Ros.*, I. p. 95. t. 35.; *R. caroliniana Bigel. Fl. Bost.*, 121.

Engravings. *Red. Ros.*, I. t. 28. and t. 35.; Lindl. *Ros.*, t. 4.; *Rossig. Ros.*, t. 13.

Spec. Char., &c. Stipules convolute. Leaflets lanceolate. Sepals spreading. (*Don's Mill.*, ii. p. 566.) Branches green, or reddish brown. Cymes 1- or many-flowered. Flowers crimson. Petals concave or flat, crumpled. Fruit round, scarlet, hispid. Sometimes the ends of the shoots have no prickles. Native of New England, Virginia, and Canada as far as the Saskatchewan. Introduced in 1726; growing to the height of from 2 ft. to 8 ft., and flowering in June and July. As the name of *R. palustris* imports, it grows best in a marshy soil.

♣ 12. *R. LINDLEYI* Spreng. Lindley's Carolina Rose.

Identification. Spreng. *Syst.*, 2. p. 647.; Don's *Mill.*, 2. p. 565.

Synonymes. *R. laxa Lindl. Ros.*, 18. t. 3.; *R. carolina* s. *Ait. Hort. Kew.*, ed. 2. vol. 3. p. 260.; *R. carolina pimpinellifolia Andr. Ros.*, with a figure.

Engravings. Lindl. *Ros.*, 18. t. 3.; *Andr. Ros.*

Spec. Char., &c. Diffuse. Branches twiggy, almost unarmed. Leaflets oblong undulated, opaque, glaucescent. (*Don's Mill.*, ii. p. 565.) A spreading shrub, with reddish brown branches. Flowers rose-coloured, growing usually in pairs. Native of North America. In cultivation, growing from 3 ft. to 4 ft. high; and flowering in July and August.

♣ 13. *R. PARVIFLORA* Ehr. The small-flowered, or *Pennsylvanian*, Rose.

Identification. Ehrh. *Beitr.*, 4. p. 21.; Du Roi Harbk., 2. p. 354.; Don's *Mill.*, 2. p. 565.

Synonymes. *R. humilis Marsh. Arb.*, 136.; *R. caroliniana Mich. Fl. Bor. Amer.*, I. p. 295.; *R. carolina* γ et δ *Ait. Hort. Kew.*, ed. 2. vol. 3. p. 260.; *Pennsylvanian Rose Lawr. Ros.*, t. 3. et t. 66., and of the nurseries.

Engraving. Smith *Insect. Geogr.*, I. p. 49. t. 25.

Spec. Char., &c. Dwarf. Stipules linear. Prickles acicular. Leaflets lanceolate, smoothish, sharply serrated. Calyxes clammy. A very low weak plant. Flowers pale bluish, usually growing by pairs. (*Don's Mill.*, 2. p. 566.) It is a native of North America, on the declivities of hills, in the states of New York and Carolina, where it grows to the height of 2 ft., flowering from June till August. Introduced in 1724.

Variety.

♣ *R. p. 2 flore pleno* Red. *Ros.*, 2. p. 73.; and our fig. 479. — Flowers double, pale bluish, unexpanded. A neat little rose, but not in very general cultivation.



❧ 14. *R. FRAXINIFOLIA* Börk. The Ash-leaved Rose.

Identification. Börk. Holz., 301.; Ker Bot. Reg., t. 458.; Don's Mill., 2. p. 566.

Synonyms. *R. virginiana* Mill. *Dict.*, No. 10.; *R. blanda* α Sol. MSS., *Jacq. Fragm.*, 70. t. 105.; *R. eorymbosa* Bosc *Dict. d'Agri. ex Desf. Cat. Hort. Par.*, p. 272. ?; *R. alpina* β *Ait. Hort. Kew.*, ed. 2. vol. 3. p. 265.; *R. alpina lævis* Red. Ros., 1. p. 57.; *Lawr. Ros.*, t. 75.

Engravings. Ker Bot. Reg., t. 458.; *Jacq. Fragm.*, 70. t. 105.; Red. Ros., 1. t. 19.; *Lawr. Ros.*, t. 75.; and our fig. 480.

Spec. Char., &c. Tall, unarmed. Branches straight, glaucescent. Leaflets opaque, undulated, and glabrous. (*Don's Mill.*, ii. p. 566.) Branches dark purple, with a pale blue bloom. Flowers small, red, in few-flowered cymes. Fruit naked, small, round or ovate, of a dull pale red. A native of Newfoundland, and on the north-west coast of America; growing to the height of from 4 ft. to 6 ft., and flowering in May and June. There are plants of this very distinct species at Messrs. Loddiges's.



❧ 15. *R. CINNAMOMEA* Besl. The Cinnamon-scented Rose.

Identification. Besl. Hort. Eyst. Vern. Ord., 6. p. 5.; Lin. Sp., 703.; Don's Mill., 2. p. 566.

Synonyms. *R. fecundissima* Munch. *Hausv.*, 5. p. 279.; *Fl. Dan.*, t. 1214.; *R. majalis* *Herm. Diss.*, 8.

Engravings. Lindl. Ros. t. 5.; Red. Ros., t. 37. and t. 51.; *Fl. Dan.*, t. 1214.; and our fig. 481.

Spec. Char., &c. Tall, cinereous. Branches straight.

Prickles stipular, straightish. Stipules dilated, undulated. Leaflets oblong, obtuse, wrinkled, tomentose beneath. (*Don's Mill.*, ii. p. 566.) Flowers solitary, or 2—3 together, pale or bright red. Fruit round, naked, and crimson. The double-flowered variety is most common in gardens. A native of most parts of Europe. Growing to the height of 5 ft. or 6 ft., and flowering in May and June. A very desirable sort, on account of its fragrance, which resembles that of cinnamon. There is a semidouble variety; and the single state is supposed to be identical with *R. majalis* below.



❧ 16. *R. MAJALIS* Retz. The May Rose.

Identification. Retz. *Obs. Bot.*, 3. p. 33.; Don's Mill., 2. p. 566.

Synonyms. *R. mütica* *Fl. Dan.*, 688.; *R. spinosissima* *Gorter. Ingr.*, 78.; *R. collincola* *Ehrh. Beitr.*, 2. p. 70.; *R. cinnamomea* *Eng. Bot.*, 2388.

Engravings. *Fl. Dan.*, t. 688.; *Eng. Bot.*, t. 2388.

Spec. Char., &c. Dwarf, grey. Branches straight, coloured. Prickles scattered, nearly equal. Stipules linear. Leaflets oblong, flat, glaucous, and tomentose beneath. (*Don's Mill.*, ii. p. 566.) Flowers usually solitary, pale red. Fruit orange red, spherical, and naked. Native of Sweden and Lapland; and of Britain, near Pontefract, in Yorkshire; growing to the height of from 3 ft. to 4 ft., and flowering in May and June. This is supposed by some to be the single state of *R. cinnamomea*.

❧ 17. *R. DICKSONIANA* Lindl. Dickson's Rose.

Identification. Lindl. Hort. Trans., 7. p. 224., *Syn. Brit. Fl.*, ed. 2. p. 99.; Don's Mill., 2. p. 566.

Spec. Char., &c. Branches flexuous, setigerous, armed with a few slender, scattered prickles. Leaflets folded together, unequal, with coarse double serratures. Stipules, petioles, and sepals compound. Styles stretched out, glabrous. (*Don's Mill.*, ii. p. 566.) Flowers white. Native of Ireland; growing to the height of from 5 ft. to 6 ft., and flowering in June and July.

❧ 18. *R. TAURICA* Bieb. The Taurian Rose.

Identification. Bieb. *Fl. Taur.*, 1. p. 394.; Don's Mill., 2. p. 566.

Spec. Char., &c. Tall, cinereous. Prickles scattered, weak. Branches straight, unarmed towards the apex. Leaflets oblong, wrinkled, villous beneath. Sepals compound. Styles stretched out, glabrous. (*Don's Mill.*, ii. p. 566.) Habit of *R. cinnamomea*. Flowers red. Native of Tauria, in bushy places. Introduced in 1817; growing to the height of from 5 ft. to 6 ft., and flowering in June and July.

❧ 19. *R. DAHURICA* Pall. The Dahurian Rose.

Identification. Pall. *Fl. Ros.*, p. 61.; Lindl. Ros., p. 32.; Don's Mill., 2. p. 566.

Spec. Char., &c. Tall, much branched. Branches slender, coloured. Prickles stipular, spreading, a little recurved. Stipules linear. Leaflets oblong, wrinkled, tomentose beneath, deeply serrated. (*Don's Mill.*, ii. p. 566.) Flowers red. Fruit ovate, red. Native of Dahuria and Mongol Tartary, in birch woods. Introduced in 1824; growing to the height of from 4 ft. to 6 ft., and flowering in May and June.

§ iv. *Pimpinellifolia* Lindl.

Sect. Char., &c. Plants bearing crowded, nearly equal, prickles, or unarmed. Bractless, rarely bracteate. Leaflets ovate or oblong. Sepals connivent, permanent. Disk almost wanting. This section is essentially different from the last in habit, but in artificial characters they approach very nearly. It, however, may be distinguished by the greater number of leaflets; which vary from 7 to 13, and even to 15, instead of from 5 to 7. The flowers are also universally without bracteas; except in the *R. alpina*, *R. Sabini*, *R. Doniana*, and, perhaps, *R. marginata*. These having connivent permanent sepals, cannot be confounded with the preceding division; nor, on account of their disk, with the following. There is no instance of stipular prickles in the present tribe. The sepals are entire, or nearly so, unless when mentioned otherwise. (*Don's Mill.*, ii. p. 567.)

☞ 20. *R. ALPINA* Lin. The Alpine Rose.

Identification. Lin. Sp., 703; Don's Mill., 2. p. 567.

Synonymes. *R. rupëstris Crantz Austr.*, 85; *R. monspellaca Gouan Monsp.*, 255; *R. inermis Mill. Dict.*, No. 6.; *R. hybrida Vill. Dauph.*, 3. p. 554; *R. lagenaria Vill.*, l. c. p. 563; *R. biflora Krok. Fl. Sil.*, 2. p. 157.

Engravings. Jacq. Fl. Austr., t. 279.; Lindl. Bot. Reg., t. 474.; N. Du Ham., 7. t. 16.; Hayne Ab. bild., t. 34.; and our fig. 482.

Spec. Char., &c. Unarmed. Fruit elongated, pendulous. Peduncles hispid. (*Don's Mill.*, ii. p. 567.) Flowers erect, bluish-coloured, solitary. Fruit orange red, oblong or obovate, with long sepals, generally pendulous. Native of the Alps of Austria, hills in the south of France, Silesia, Bohemia, Dauphiné, Switzerland, &c. Introduced in 1683; growing to the height of from 5 ft. to 8 ft., and flowering in June and July.



Varieties.

☞ *R. a. 2 pyrenæica* Lindl. Ros., p. 37; *R. pyrenæica Gouan Ill.*, 31. t. 19.; *R. alpina Jacq. Hort. Schænb.*, 4. p. 416.; *R. hispida Krok. Siles.*, 2. p. 152.; *R. turbinata Vill. Dauph.*, 3. p. 550.; *R. alpina ð Dec. Fl. Fr.*, 6. p. 536.; *R. hispida* and *R. alpina coronata Desv. Journ. Bot.*, 1813, p. 119. ?; has the tube of the calyx and the peduncles hispid.

☞ *R. a. 3 pendulina* Lindl. l. c., Red. Ros., l. p. 57. t. 17.; *R. pendulina Ait. Hort. Kew. Læv. Ros.*, t. 91.; *R. a. latifolia Ser.* in Dec. Prod., 2. p. 612; has the leaflets numerous, and stems pendulous and coloured.

☞ *R. a. 4 pimpinellifolia* Lindl. l. c., Vill. Dauph., 3. p. 553.; *R. glandulosa Bell* in Act. Taur., 1790, p. 230.; *R. pygmæa Bieb. Fl. Taur.*, l. p. 397.; *R. pyrenæica ð Smith* in Rees's Cyclopædia.

☞ *R. a. 5 lagenaria* Ser. in Dec. Prod., 2. p. 611., has the stem and branches glabrous; the peduncles hispid; the neck of the calyx tapering; the leaflets lanceolate or oblong, and doubly and sharply serrated. It is a native of the Alps and Pyrenees.

☞ *R. a. 6 sorbinella* Ser. l. c. has the peduncles short and hispid, the calyx smooth, and the leaflets distant.

☞ *R. a. 7 hispida* Ser. l. c., *R. a. coronata Desv.*, has the branches armed with slender recurved prickles, and the leaflets elliptic.

☞ *R. a. 8 lævis* Ser., but not of Desv. or Red.; *R. Sanguisorba majoris*, &c., *Dill. Elth.*; *R. alpina glabra Desv.*; *R. a. vulgaris Red. Ros.*, 2. p. 111.; and our fig. 483., has the stem, peduncles, and calyx quite glabrous, and the fruit oblong.

☞ *R. a. 9 pyriformis* Ser. l. c. has the stem, &c., glabrous, and the fruit pear-shaped.

☞ *R. a. 10 setosa* Ser., *R. a. hircina Desv.*, has the stem smooth, but the peduncles and calyx beset with numerous long yellow bristles.

☞ *R. a. 11 globosa* Desv. has the stem and branches smooth, the peduncles and calyx hispid, and the fruit nearly globular. This variety was first called, by Desvaux, *R. canina ambigua*; and there is a subvariety of it with dark purple petioles and branches.

☞ *R. a. 12 helleborina* Ser. is a native of Russia, and has the leaflets large, approximate, and sharply and broadly toothed; the three terminal ones resembling those of *Helleborus lividus*.

☞ *R. a. 13 pilosula* Ser. has the peduncles pilose.

☞ *R. a. 14 turbinata* Desv.; *R. inermis DeClaus. Bon. Jard.*, for 1808, p. 717., *Red. Ros.* 2. p. 93., *Vill. Dauph.* 3. p. 550., but not of Ait.; *R. a. flore pleno*



Godefroy Cat.; *R. a. múltiplex Ser.*; *R. míxta Tratt. Ros.*, I. p. 136; is a very handsome variety with double red flowers and glaucescent leaves; the stem and branches are almost unarmed; the peduncles are hispid; and the sepals are dilated at their apex.

☞ 21. *R. SUÁVIS Willd.* The sweet Rose.

Identification. Willd. Enum. Suppl., p. 37.; Link. Enum., 2. p. 57.;

Don's Mill., 2. p. 567.

Engravings. Hayne Abbild., t. 40.; and our fig. 484.

Spec. Char., &c. Stem hispid. Leaves glabrous, glaucescent beneath. Peduncles and petioles clothed with glandular bristles. (*Don's Mill.*, ii. p. 567.) Petals deep purple, deeply 2-lobed. Fruit oblong, glabrous. Cultivated in 1818; growing to the height of 3 ft. or 4 ft., and flowering in June and July. This very distinct variety, or perhaps species, of rose is probably at present wanting in British collections; for it must not be confounded with *Rosa suaveolens* or with *Rosa suavifolia*, both described in *Le Botaniste Cultivateur* as varieties of *R. rubiginosa*, or synonymes to that species. The genus *Rosa* is, indeed, liable to such extreme variation, that it would not surprise us in the least to be informed that *R. suavis* (fig. 484.) is also a variety of *R. rubiginosa*. It is not known of what country *R. suavis* is a native; and this circumstance renders it not improbable that it may be a garden production.



484

☞ 22. *R. ACICULÁRIS Lindl.* The needle-prickled Rose.

Identification. Lindl. Ros., p. 44.; Don's Mill., 2. p. 567.

Synonyme. *R. alpina* & *aculéata Ser.* in *Dec. Prod.*, 2. p. 611.

Engraving. Lindl. Ros., t. 8.

Spec. Char., &c. Tall. Prickles acicular, unequal. Leaflets glaucous, wrinkled, rather convex. Fruit rather flask-shaped, drooping. (*Don's Mill.*, ii. p. 567.) Flowers solitary, pale blush, fragrant. Fruit obovate, naked, of a yellowish orange colour. Native of Siberia. Introduced in 1805; growing to the height of from 6 ft. to 8 ft., and flowering in May and June.

☞ 23. *R. LUTEÁSCENS Pursh.* The yellow American Rose.

Identification. Pursh. Fl. Amer. Sept., vol. 2. p. 735.; Lindl. Ros., p. 47.; Don's Mill., 2. p. 568.

Synonyme. *R. hispida Curt. Bot. Mag.*, t. 1570.

Engravings. Lindl. Ros., t. 9.; Bot. Mag., t. 1570.; and our fig. 485.

Spec. Char., &c. Prickles of branches crowded, unequal, slender, reflexed; of the branchlets, small and nearly equal. Leaflets flat, glabrous, simply serrated. (*Don's Mill.*, ii. p. 568.) Flowers pale yellow. Fruit large, ovate, black. Native of North America and Siberia. Introduced in 1780; growing to the height of from 4 ft. to 6 ft., and flowering in May and June. It forms a very distinct variety, or probably species, and, on that account, is well deserving a place in botanical collections.



485

☞ 24. *R. SULPHURÉA Ait.* The sulphur-coloured-flowered Rose.

Identification. Ait. Hort. Kew., 2. p. 201.; Lindl. Ros., t. 77.; Don's Mill., 2. p. 568.

Synonyms. *R. hemisphérica Herm. Diss.*, 18.; *R. glaucophylla Ehrh. Beitr.*, 2. p. 69.; *Rosa lutea*

Rose pleno Rai. Hist., 1475. No. 51.; *R. lutea Brot. Fl. Lus.*, 1. p. 337.; the double yellow Rose.

Engravings. Lindl. Ros., t. 77.; Bot. Reg., t. 46.; Red. Reg., 1. t. 3.; and our fig. 486.

Spec. Char., &c. Stipules linear, divaricate, dilated at the apex. Leaflets glaucous, flat-tish. Tube hemispherical. (*Don's Mill.*, ii. p. 568.) Stem prickles unequal, scattered. Flowers large, of a fine transparent yellow, always double. Native of the Levant. Introduced before 1629; growing to the height of from 4 ft. to 10 ft., and flowering in July. This sort does not flower freely, except in open airy situations; and, if trained against a wall, exposed to the north or east rather than to the south. Its flower buds are apt to burst on one side before they expand, and consequently to become deformed; to prevent this, the blossom buds should be thinned, and care taken that they have abundance of light and air. Watering it freely in the flowering season is also found advantageous; and the shoots, in general,



486

ought not to be shortened. This beautiful species is said to flower freely, if grafted on the musk cluster at 8 ft. or 10 ft. from the ground; or it will do well on the China rose. It is grown in great abundance in Italy, where its flowers produce a magnificent effect, from their large size, doubleness, and brilliant yellow colour. It is one of the oldest inhabitants of our gardens, though the exact year of its introduction is unknown. "Ludovico Berthema tells us, in 1503, that he saw great quantities of yellow roses at Calicut, whence it appears probable, that both the single and double-flowered varieties were brought into Europe by the Turks; as Parkinson tells us, in a work which he dedicated to Henrietta, the queen of our unfortunate Charles I., that the double yellow rose 'was first procured to be brought to England, by Master Nicholas Lete, a worthy merchant of London, and a great lover of flowers, from Constantinople, which (as we hear) was first brought thither from Syria, but perished quickly both with him, and with all other to whom he imparted it; yet afterwards it was sent to Master John de Franguerville, a merchant of London, and a great lover of all rose plants, as well as flowers, from which is sprung the greatest store that is now flourishing in this kingdom.'" (*Sylva Florifera*, ii. p. 190.)

25. *R. SPINOSISSIMA* L. The most spiny, or Scotch, Rose.

Identification. Lin. Fl. Suec., 442.; Sp., 491.; Don's Mill., 2. p. 568.

Engravings. Eng. Bot., t. 187.; Hayne Abbild., t. 37.; and our fig. 487.

Spec. Char., &c. Prickles unequal. Leaflets flat, glabrous, simply serrated. (*Don's Mill.*, ii. p. 568.) A dwarf compact bush, with creeping suckers. Flowers small, solitary, white or bluish-coloured. Fruit ovate, or nearly round, black or dark purple. Native of Europe; plentiful in Britain. Shrub, 1 ft. to 2 ft. high; flowering in May and June.

Varieties. A great many varieties have been raised of this rose, with flowers double, semidouble, white, purple, red, and even yellow. The first double variety was found in a wild state, in the neighbourhood of Perth, by Mr. Brown of the Perth Nursery, who raised a number of others from seed. Mr. Austin of the Glasgow Nursery also raised upwards of 50 select varieties; and, subsequently, the number of these varieties for sale in the nurseries has become so great, and they are changing their names so often, that it would be useless to attempt to give a list of them in this work. Those who wish to procure a collection will succeed best by procuring the latest descriptive catalogue of roses published by nurserymen. That of the Sawbridgeworth Nursery has been already mentioned (p. 749.); and we can also recommend those of Woods of Maresfield, and Hooker of Brechley, both in Kent; and the select lists of Messrs Loddiges, Mr. Lee, Mr. Donald, Messrs. Whitley and Osborne, and Messrs. Buchanan and Oldroyd.

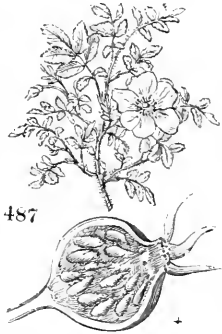

26. *R. HIBERNICA* Smith. The Irish Rose.

Identification. Smith in Engl. Bot., 2196.; Don's Mill., 2. p. 569.

Engraving. Eng. Bot., t. 2196.

Spec. Char., &c. Prickles unequal, slightly hooked, smaller ones bristle-formed. Leaflets ovate, acute, simply serrated, with the ribs hairy beneath. Sepals pinnate. Fruit nearly globular, smooth, as well as the peduncles. (*Don's Mill.*, ii. p. 569.) Flowers small, light bluish-coloured. Fruit orange-coloured. Native of Ireland, in the counties of Derry and Down, in thickets. A shrub, from 4 ft. to 6 ft. in height, and flowering from June to November.

27. *R. OXYACANTHA* Bieb. The sharp-prickled Rose.

Identification. Bieb. Fl. Taur., 3. p. 338.; Don's Mill., 2. p. 569.

Spec. Char., &c. Stems very prickly. Prickles setaceous, reversed. Petioles prickly and glandular. Leaflets sharply and simply serrated, glabrous. Sepals undivided. Peduncles clothed with glandular bristles; when in fruit, reflexed. Fruit nearly globose, glabrous. (*Don's Mill.*, ii. p. 569.) Flowers red. A native of Siberia. A shrub, from 3 ft. to 5 ft. high, and flowering in June and July.

28. *R. SANGUISORBIFOLIA* Donn. The Burnet-leaved Rose.

Identification. Donn Hort. Cant., ed. 8. p. 169; Don's Mill., 2. p. 569.

Synonymes. *R. spinosissima* var. *sanguisorbifolia* Lindl. Ros., p. 51; *R. spinos.* var. *macrophylla* Ser. in *Dec. Prod.*, 2. p. 609.

Spec. Char., &c. Tall. Prickles nearly equal. Leaflets 9—11, oblong, glabrous, simply serrated. Fruit globose, depressed, dark. (*Don's Mill.*, ii. p. 569.) Flowers white. This plant is easily distinguished from the last, by the greater number of its leaflets, the shortness of its peduncles, and by its globose depressed fruit. It is a shrub, from 3 ft. to 5 ft. high, and flowering in May and June.

29. *R. GRANDIFLORA* Lindl. The large-flowered Rose.

Identification. Lindl. Ros., p. 53; and Bot. Reg., t. 888; Don's Mill., 2. p. 569.

Synonyme. *R. pimpinellifolia* Bieb. Fl. Taur., 2. p. 394.

Engravings. Bot. Reg., t. 888; and our fig. 488.

Spec. Char., &c. Branches without bristles. Prickles nearly equal, distant. Leaflets flat, glabrous, simply serrated. (*Don's Mill.*, ii. p. 569.) Flowers white. Fruit dark. Native of Siberia. Introduced in 1815; growing to the height of from 4 ft. to 6 ft., and flowering in May and June. Of this rose Dr. Lindley remarks, that it differs from *R. spinosissima*, though scarcely so much as to render it a distinct species. "However," he says, "it is too remarkable a plant to escape notice; and, if it should hereafter be reduced to *R. spinosissima*, it must stand as a distinct variety." (*Ros. Monog.*, p. 54.) There are plants bearing this name in the collection of Messrs. Loddiges, which are very distinct in their appearance, and therefore it may safely be recommended to the notice of the botanical cultivator; and we think that even our engraving, small as it is, will justify the recommendation.



30. *R. MYRIACANTHA* Dec. The myriad-prickled Rose.

Identification. Dec. Fl. Fr., 4. p. 439; Don's Mill., 2. p. 569.

Synonymes. *R. parvifolia* Pall. Ross., 62. ?; *R. provincialis* Bieb. Fl. Taur., 1. p. 396. ?; *R. spinosissima* var. *γ* *myriacantha* Ser. in *Dec. Prod.*, 2. p. 608.

Engravings. Lindl. Ros., t. 10; and our fig. 489.

Spec. Char., &c. Prickles unequal, larger ones dagger-formed. Leaflets glandular, glabrous, orbicular. (*Don's Mill.*, ii. p. 569.) Flowers white. Native of Dauphiné, and near Montpelier. Introduced in 1820; growing from 1 ft. to 2 ft. high, and flowering in May and June. According to Dr. Lindley, this rose forms a diminutive shrub, with almost simple and erect shoots, resembling, in many respects, *R. spinosissima* in a stunted state; though the glands on its leaves appear sufficient to prevent the two sorts from being mistaken for each other. (*Ros. Monog.*, p. 55.) There are many varieties of *R. spinosissima* in the collection of Messrs. Loddiges, but none of them bearing this name; nor is it in their *Catalogue* as a separate species.

489

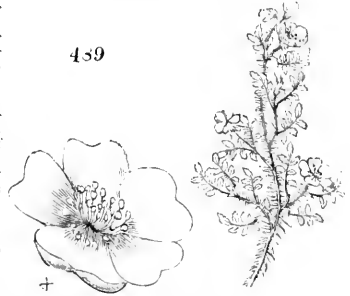

31. *R. INVOLUTA* Smith. The involute-petaled Rose.

Identification. Smith in Eng. Bot., 2068; Don's Mill., 2. p. 569.

Synonyme. *R. nivalls* Donn. Hort. Cant., ed. 8. p. 170.

Engraving. Eng. Bot., t. 2068.

Spec. Char., &c. Prickles very unequal, and very much crowded. Leaflets doubly serrated, pubescent. Petals convolute. Fruit prickly. (*Don's Mill.*, ii. p. 569.) Petals pale red, concave. Native of the Hebrides, in the Isle of Arran (*G. Don*), and in Glen Lyon. Shrub, 2 ft. to 3 ft. high, and flowering in June.

32. *R. REVERSA* Waldst. et Kit. The reversed-prickled Rose.

Identification. Waldst. et Kit. Hung., 3. p. 293; Don's Mill., 2. p. 569.

Engraving. Waldst. et Kit. Hung., 3. t. 264.

Spec. Char., &c. Prickles setaceous, nearly equal, reflexed. Leaves doubly serrated, pubescent. Fruit hispid. (*Don's Mill.*, ii. p. 569.) Flowers solitary, white, tinged with pink. Fruit ovate, dark purple. Native of Hungary, on the mountains of Matra, in stony places. Introduced in 1816; growing to the height of from 2 ft. to 5 ft., and flowering in June and July.

33. *R. SABI'NI* Woods. Sabine's Rose.

Identification. Woods in Lin. Trans., 12. p. 188; Don's Mill., 2. p. 569.

Engraving. Borr. in Eng. Bot. Suppl., t. 2595.

Spec. Char., &c. Peduncles, calyx, fruit, and branches bristly. Prickles scattered, straightish. Leaflets doubly serrated, nearly smooth, with hairy ribs. Sepals pinnate. (*Don's Mill.*, ii. p. 570.) Flower stalks rather aggregate. Petals fine red. Fruit ovate, bright scarlet. Native of Scotland, near Dunkeld; in England, in Cumberland, Northumberland, and Yorkshire. Shrub, from 5 ft. to 8 ft. high, and flowering in July.

34. *R. DONIANA* Woods. Don's Rose.

Identification. Woods in Lin. Trans., 12. p. 185; Don's Mill., 2. p. 570.

Synonyme. *R. Sabini* β Lindl. Ros., p. 59.

Spec. Char., &c. Peduncles bractless, bristly, as well as the globular fruit and calyx. Stem bristly and prickly, like the downy petioles. Leaflets elliptical, doubly and sharply serrated, hairy on both sides. Petals spreading. (*Don's Mill.*, ii. p. 570.) Flowers pink, expanded. Segments of the calyx simple. Native of the Highlands of Scotland, particularly on the mountains of Clova, Angusshire. Shrub, 4 ft. to 5 ft. high, and flowering in June and July. This rose was named in honour of Mr. Don of Forfar; and Sir Edward Smith observes of it: "It is much to be wished, that this rose should afford a permanent wreath in honour of its discoverer, one of the most indefatigable as well as accurate of botanists, who loved the science for its own sake, and braved every difficulty in its service. He infused the same spirit into his sons [two of whom, Prof. Don, and G. Don, author of *Don's Miller*, are well known in the botanical world], who are now living evidences of his knowledge, and of his powers of instruction." (*Smith's Eng. Fl.*, 2. p. 379.)

§ v. *Centifolia* Lindl.

Derivation. From *centum*, a hundred, and *folium*, a leaf; because the species contained in this section agree in character with the hundred-leaved rose, which is so extensively double as to seem to have a hundred petals.

Sect. Char., &c. Shrubs, all bearing bristles and prickles. Peduncles bracteate. Leaflets oblong or ovate, wrinkled. Disk thickened, closing the throat. Sepals compound. This division comprises the portion of the genus *Rosa* which has most particularly interested the lover of flowers. It is probable that the earliest roses of which there are any records of being cultivated belonged to this section; but, to which particular species those of Cyrene or Mount Pangæus are to be referred, it is now too late to enquire. The attar of roses, which is an important article of commerce, is either obtained from roses belonging to this division indiscriminately, as in the manufactory at Florence, conducted by a convent of friars; or from some particular kind, as in India. It appears, from specimens brought from Chizapore by Colonel Hardwicke, that *R. damascena* is there exclusively used for obtaining the essential oil. The Persians also make use of a sort which Kæmpfer calls *R. shirazensis* (from its growing about Shiraz), in preference to others: this may be either *R. damascena*, or *R. gallica*, or *R. centifolia*, or perhaps *R. moschata*. The species contained in the present section are all setigerous, by which they are distinguished from the following divisions: their thickened disk and divided sepals separate them from the preceding. To the section of *Rubiginosæ* the glanduliferous sorts approach; but the difference of their glands, the size of their flowers, and their dissimilar habit, prevent their being confounded. (*Don's Mill.*, ii. p. 571. adapted.)

§ 35. *R. DAMASCENA* Mill. The Damascus, or Damask, Rose.

Identification. Mill. Dict., No. 15; *Don's Mill.*, 2. p. 571.

Synonymes. *R. bœgica* Mill. Dict., No. 17; *R. calendaria* Munch. Hausv. ex Bork. Holz., 330, *Rossig. Ros.*, t. 8., and t. 33; *R. bifera* Poir. Suppl. 6. p. 276, *Red. Ros.*, t. p. 107, and p. 121; *Rose à quatre Saisons*.

Engravings. Redout. Ros., 1. t. 58.; and our fig. 490. of *R. d. coccinea*.

Spec. Char., &c. Prickles unequal, larger ones falcate. Sepals reflexed. Fruit elongated. (*Don's Mill.*, ii. p. 571.) Native of Syria. Flowers large, white or red, single or double. The present species may be distinguished from *R. centifolia* by the greater size of the prickles, the greenness of the bark, the elongated fruit, and the long reflexed sepals. The petals of this species, and all the varieties of *R. centifolia*, as well as those of other species, are employed indiscriminately for the purpose of making rose-water. A shrub, growing from 2 ft. to 8 ft. high, and flowering in June and July. This species is extremely beautiful, from the size and brilliant colour of its flowers.



490

Varieties. There are nearly 100 varieties which are classed under this species; but it is very doubtful whether many of them are not hybrids between this and

other sorts. Among the names of the varieties classed under this head are, the monthly blush; the blush damask; the red and white damask; the red and white monthly; the incomparable; the perpetual, commonly called Lee's perpetual, and also the crimson perpetual, and the rose du roi; and, perhaps, the handsomest variety of the species, the quatre saisons, of which there are six or eight subvarieties; the royal; and the York and Lancaster.

❖ 36. *R. CENTIFOLIA* Lin. The hundred-petaled, *Provence, or Cabbage, Rose.*

Identification. Lin. Sp., 704; Don's Mill., 2. p. 571.

Synonyms. *R. provincialis* Mill. Dict., No. 18.; *R. polyánthos* Rossig. Ros., t. 35.; *R. caryophyllæ* Poir. Suppl., 6. p. 276.; *R. unguiculata* Desf. Cat., 175.; *R. varians* Pohl Bohem., 2. p. 171.

Engravings. Rossig. Ros., t. 1.; Red. Ros., 1. p. 25. t. 1., p. 37. t. 7., p. 77. t. 26., p. 79. t. 27., p. 111. t. 40.; and our fig. 491., of the double-flowered variety.

Spec. Char., &c. Prickles unequal, larger ones falcate. Leaflets ciliated with glands. Flowers drooping. Calyxes clammy. Fruit oblong. (*Don's Mill.*, ii. p. 571.) Native of Eastern Caucasus, in groves. Flowers white or red; single, but most commonly double. This species is distinguished from *R. damascena* by the sepals not being reflexed, and the flowers having their petals curved inwards, so as, in the double state, to give the flower the appearance of the heart of a cabbage; whence the name of the cabbage rose. Its fruit is either oblong or roundish, but never elongated. From *R. gallica* it is distinguished by the flowers being drooping, and by the larger size of the prickles, with a more robust habit. A shrub, growing from 3 ft. to 6 ft. high, and flowering in June and July.



Varieties. Above 100 varieties are assigned to this species, which are classed in three divisions:—

❖ *R. c. 1 provincialis* Mill.; the *Provence, or Cabbage, Roses*; among which are the royal and cabbage blush; the carmine; the cluster; the Duchesse d'Angoulême, a very handsome white rose; the Provence, of which there are upwards of twenty subvarieties; the prolific; the striped nosegay; and the Versailles.

❖ *R. c. 2 muscosa* Mill., the *Moss Roses*; among which are the common single (fig. 492.), the common double, the blush, the dark, the striped, the white, and the crested moss; the last a variety recently obtained from France, by Mr. Curtis of the Glazenwood Nursery. (See *Bot. Mag.*, t. 3475.; and *Gard. Mag.*, vol. xii. p. 182.)

❖ *R. c. 3 pomponia* Dec., the *Pomponé Roses*; among which are the well-known rose de Meaux, an old inhabitant of the gardens; the mossy de Meaux, the dwarf, and small Provence; the rose de Rheims; and the common and prolific pomponé.

❖ *R. c. 4 bipinnata* Red. Ros., ii. p. 4., which has bipinnate leaves.



❖ 37. *R. GA'LIFICA* L. The French Rose.

Identification. Lin Sp., 704; Dec. Prod., 2. p. 603.

Synonyms. *R. centifolia* Mill. Dict., No. 41.; *R. sylvatica* Gater. Mont., p. 94.; *R. rubra* Lam. Fl. Fr., 3. p. 130.; *R. holosericea* Rossig. Ros., t. 18.; *R. belgica* Brot. Fl. Lus., 1. p. 338.; *R. blanda* Brot., 1. c.; Rose de Provins, Fr.; Essig Rose, Ger.

Engravings. Mill., fig. t. 221. f. 2.; Rossig. Ros., t. 17. 22. 25., fig. 6. 26. 28. 31. 36. 38. 39.; Red. Ros., 1. t. 25. 52., 2. 7, 8. 10.; and our fig. 493., which is of the variety called the Bishop Rose.

Spec. Char., &c. Prickles unequal. Stipules narrow, divaricate at the tip. Leaflets 5—7, coriaceous, rigid, ovate or lanceolate, deflexed. Flower bud ovate-globose. Sepals spreading during the time of the flowering. Fruit subglobose, very coriaceous. Calyx and peduncle more or less hispid with glanded hairs, somewhat viscose. A species allied to *R. centifolia* L., but with round fruit, and very coriaceous leaflets, with more numerous nerves, that are a little prominent, and are anastomosing. (*Dec. Prod.*, ii. p. 603.) Native of middle Europe and Caucasus, in hedges. The flowers vary from red to crimson, and from single to double; and there is one variety with the flowers double white. The petals of some of the varieties of this rose are used in medicine, particularly that called officinal; which, though not so fragrant as those of the Dutch hundred-leaved rose, also one of the varieties of this species, are preferred for their beautiful colour and their pleasant astringency. The petals of *R. gallica* are those which are principally used for making conserve of roses, and, when dried, for gargles: their odour is increased by drying. They are also used, in common with those of *R. centifolia*, for making rose-water and attar of roses. This rose was called by old writers the red rose, and is supposed to have been the one assumed as the badge of the House of Lancaster. This, also, is one of the roses mentioned by Pliny; from which, he says, all the others have been derived. It is often confounded with the damask rose; and is the *Rosa damascena* of the druggists' shops.



Varieties. The varieties of this species are very numerous; some of the principal are, the *cramoisie*, royal crimson, black damask, *Fanny Bias*, *Flanders*, *giant*, *gloria mundi*, *grand monarque*, the *Dutch*, the *blush*, the *bishop*, and *Singleton's* (*fig.* 493.), all old favourites in our gardens; *Malta*, *marbled*, several subvarieties; *mignonne*, six or eight sorts; *Morocco*, *negro*, *mottled black*, *Ninon de l'Enclos*, *Normandy*; *officinal*, or the rose of the shops, several varieties; *purple*, 14 sorts; *poppy*; *velvet*, several kinds; *ranunculus*, *rosa mundi*, *sultana*; and *Tuscany*. The *village maid*, a striped rose, introduced by Mr. Rogers of Southampton, probably belongs to this species. Besides these, and many others, which are garden sorts, there are the following distinct varieties:—

- ✱ *R. g. 2 pumila* Lindl. *Ros.*, p. 68.; *R. pumila* *Lin. Suppl.*, p. 262., *Jacq. Austr.*, ii. p. 59. t. 198.; *R. repens* *Munch. Hausv.*, v. p. 281.; *R. hispida* *Munch.*, l. c.; *R. austriaca* *Crantz Austr.*, t. 86.; *R. olympica* *Donn Hort. Cant.*, ed. 8. p. 170.; with red single flowers, and creeping roots. A native of Austria, Piedmont, Tauria, Caucasus, Iberia, and about Geneva.
- ✱ *R. g. 3 arvena* Lindl. *Ros.*, p. 69.; *R. arvena* *Krok. Siles.*, ii. p. 150.; has the leaves naked on both surfaces, and is a native of Silesia.
- ✱ *R. g. 4 inaperta* Ser. *Mel.*, i. p. 86., *the Vilmorin Rose*, has the branches and peduncles hispid from prickles; and the calyx campanulate and glandular. The flowers are double, and both white and red.
- ✱ *R. g. 5 Agatha* *Red. et Thor. Ros.*, iii. p. 35., with a fig.; *the Agatha Rose*; has the sepals more or less pinnate, and the flowers small and very double, with the outer petals spreading, but the inner ones concave.
- ✱ *R. g. 6 inermis* Ser. in *Dec. Prod.*, ii. p. 604. — *Glabrous*. Branches smooth. Peduncles hardly glandular. Tube of the calyx bell-shaped; Flowers purple and double; and sepals shortly and simply pinnate.
- ✱ *R. g. 7 parvifolia* Ser. in *Dec. Prod.*, ii. p. 664.; *R. parvifolia* *Ehr.*

Beitr., vi. p. 97., *Ker* in *Bot. Reg.*, t. 452., *Don's Mill.*, ii. p. 573.; *R. burgundiaca* *Rossig. Ros.*, t. 4.; *R. remensis* *Desf. Cat.*, t. 175., and our *fig.* 494. *The Burgundy Rose.*—A dwarf compact shrub, with stiff, ovate, acute, and sharply serrated small leaflets, and very double purple flowers, which are solitary, and have some resemblance, in form and general appearance, to the flower of a double-flowered Asiatic ranunculus. Besides these botanical varieties, given in *Don's Miller*, there are 19 in the *Nouveau Du Hamel*.



494

■ 38. *R. PULCHE'LLA* Willd. The neat Rose.

Identification. Willd. Enum., p. 545.; *Don's Mill.*, 2. p. 573.

Spec. Char., &c. Ovaries roundish-obovate. Peduncles and calyxes beset with glandular bristles. Petioles clothed with glandular pubescence, unarmed. Cauline prickles scattered. (*Don's Mill.*, ii. p. 573.) Native country unknown. Allied to *R. turbinata*; but the stems are much smaller; the flowers also smaller; and the form of the ovaries is different. Perhaps this is the rose de Meaux of the gardens, or some variety of *R. gallica*. It is a shrub, 2 ft. high, and produces its flowers in June and July. (*Don's Mill.*, ii. p. 573.)

Remark. Besides the above species and varieties, and numerous other garden varieties arranged under the different heads, the names of which we have not given, *Don* enumerates above 700 garden varieties, which he considers as "belonging to some of the species of the present section." (See *Don's Mill.*, ii. p. 573.)

§ vi. *Villosæ.*

Derivation. From *villosus*, villous; in allusion to the hairiness of the species.

Sec. Char. Surculi erect. Prickles straightish. Leaflets ovate or oblong, with diverging serratures. Sepals connivent, permanent. Disk thickened, closing the throat. This division borders equally close upon those of *Caninæ* and *Rubiginosæ*. From both it is distinguished by its root-suckers being erect and stout. The most absolute marks of difference, however, between this and *Caninæ*, exist in the prickles of the present section being straight, and the serratures of the leaves diverging. If, as is sometimes the case, the prickles of this tribe are falcate, the serratures become more diverging. The permanent sepals are another character by which this tribe may be known from *Caninæ*. *Rubiginosæ* cannot be confounded with the present section, on account of the unequal hooked prickles, and glandular leaves, of the species. Roughness of fruit, and permanence of sepals, are common to both. (*Don's Mill.*, ii. p. 576.)

■ 39. *R. TURBINATA* Ait. The turbate-calyxed, or Frankfort, Rose.

Identification. Ait. Hort. Kew., ed. 1. v. 2. p. 206.; Dec. Prod., 2. p. 603.; *Don's Mill.*, 2. p. 576.

Synonymes. *R. campanulata* *Ehrh. Beitr.*, 6. p. 97.; *R. francortiana* *Munch. Hausv.*, 5. p. 24.; *R. francfurtensis* *Rossig. Ros.*, t. 11.

Engravings. Jacq. Schönbr., 4 t. 415.; Jacq. Fragm., 71. t. 107. f. 2.; Red. Ros., 1. p. 127.; *Rossig. Ros.*, t. 11.; *Law. Ros.*, t. 69.; and our *fig.* 495.

Spec. Char., &c. Stem nearly without prickles. Branches smooth. Leaflets 5—7, ovate-cordate, large, wrinkled in a bullate manner, serrate, approximate, a little villous beneath. Stipules large, clasping the stem or branch. Flowers disposed subcorymbosely, large, violaceous red. Peduncles wrinkled and hispid. Calyx turbinate, smoothish. Sepals undivided,



495

subspathulate. (*Dec. Prod.*, ii. p. 603.) Flowers large, red, and loose; probably a native of Germany. Introduced in 1629; growing to the height of from 4 ft. to 6 ft., and flowering in June and July.

Varieties. De Candolle gives the two following forms of this species: the latter of which is most common in British gardens.

☞ *R. t. 1 francofurtana* Ser. *R. turbinata* *Red. et Thor. Ros.*, i. p. 127. *ic.*, and ii. p. 95. *ic.*, *Lindl. Rosar. Monog.*, p. 73.; *R. campanulata Ehrh. Beitr.*, vi. p. 97.; *R. francofurtana Gmel. Fl. Bad.*, ii. p. 405.; *R. francofurtensis Desf. Cat.*, 175. *The Frankfort Rose.*—Stem nearly without prickles. Petioles tomentose. Leaflets somewhat like the leaves of the hornbeam. Peduncles and calyxes hispid, with glanded hairs. Tube of the calyx hemispherically bell-shaped. Petals rosy, tinted with purple.

☞ *R. t. 2 orbessanea* Ser. *R. orbessanea* *Red. et Thor. Ros.*, ii. p. 21., *Lindl. Rosar. Monog.*, p. 142. *The Orbessan Rose.*—Stem prickly. Calyxes ovately bell-shaped. The peduncles rather hispid, with glanded hairs. Flowers rose-coloured, double. This is a very valuable kind of rose for shrubberies, &c., from its vigorous and durable habit of growth, its large size, and the abundance of its large flowers, which, though not elegant, are showy and ornamental.

☞ 40. *R. villosa* Lin. *The villous-leaved Rose.*

Identification. Lin. Sp., 704.; Don's Mill., 2. p. 576.

Synonymes. *R. mollis* Smith in *Eng. Bot.*, t. 2459.; *R. tomentosa* β *Lindl. Ros.*, p. 77.; *R. heterophylla* Woods in *Lin. Trans.*, 12. p. 193.; *R. pulchella* Woods l. c., p. 196.; *R. pomifera* *Herm. Diss.*, 16.

Engraving. *Eng. Bot.*, t. 2459.

Spec. Char., &c. Leaflets rounded, bluntish, downy all over. Fruit globose, rather depressed, partly bristly. Sepals slightly compound. (*Don's Mill.*, ii. p. 576.) Flowers red or pink. This is a very variable plant. Branches without bristles. It is native of Europe, in hedges; in Britain, in bushy rather mountainous situations, in Wales, Scotland, and the north of England, growing to the height of 5 ft. or 6 ft., and flowering in July.

Varieties.

☞ *R. v. 2 resinosa* Lindl. *Ros.*, p. 77., has narrow leaflets, and very red flowers. It is a dwarf, grey-looking shrub, a native of Ireland.

☞ *R. v. 3 pomifera* Desv. *Jour. Bot.*, 1813, p. 117.; *R. hispida* *Poir. Encyc. Bot.*, No. 15.; and Don's Mill., ii. p. 577.; has the ovaries and peduncles hispid, and the leaflets ovate, and white beneath from tomentum.

☞ 41. *R. gracilis* Woods. *The slender Rose.*

Identification. Woods in *Lin. Trans.*, 12. p. 186.; Don's Mill., 2. 570.

Synonyme. *R. villosa* Smith in *Eng. Bot.*, t. 583., excluding the synonyme and the fruit.

Engraving. *Eng. Bot.*, t. 583.

Spec. Char., &c. Peduncles usually in pairs, bristly, often bracteate. Branches, fruit, and calyx bristly. Larger prickles curved, usually twin. Leaflets doubly serrated, hairy on both sides. (*Don's Mill.*, ii. p. 570.) Petals slightly concave, of a pale pink. Fruit globular. Segments of the calyx simple. Growing to the height of 8 ft. or 10 ft., and flowering in July.

☞ 42. *R. tomentosa* Smith. *The tomentose, or woolly, leaved, Rose.*

Identification. Smith Fl. Brit., 539.; *Eng. Bot.*, 990.; Don's Mill., 2. p. 576.

Synonymes. *R. villosa* *Ehrh. Arb.*, p. 45., *Du Roi Harbk.*, 2. p. 341., *Fl. Dan.*, t. 1458.; *R. mollissima* *Börk. Holz.*, p. 307.; *R. dubia* *Wibel. Wirth.*, p. 263.; *R. villosa* β *Huds.*, 219.

Engravings. *Red. Ros.*, 2. p. 39. and p. 88.; *Eng. Bot.*, t. 990.

Spec. Char., &c. Leaflets ovate, acute, more or less downy. Fruit elliptical, hispid. Sepals pinnate. Prickles slightly curved. (*Don's Mill.*, ii. p. 576.) Petals white at the base. Native of Europe, in hedges and thickets; plentiful in Britain; growing to the height of 6 ft., and flowering in June and July.

Variety.

☞ *R. t. 2 scabriuscula* Smith *Eng. Bot.*, t. 1896. *R. cœtida* *Batard Suppl.*, 29., *Red. Ros.*, i. p. 131. — Leaves greener than those of

the species, nearly smooth, except the ribs, which are hairy. Native near Newcastle.

✻ 43. *R. SHERARDI* Davies. Sherard's Rose.

Identification. Davies Welsh Bot., 49; Don's Mill., 2. p. 576.

Synonymy. *R. subglobosa* Smith Eng. Fl., 2. p. 384; *R. tomentosa* var. ϵ and η Woods in Lin. Trans., 12. p. 201.

Spec. Char., &c. Prickles conical, hooked, compressed. Leaflets elliptical, acute, downy on both surfaces. Sepals pinnate. Fruit globular, abrupt, rather bristly. (*Don's Mill.*, ii. p. 576.) Found near Kingston upon Thames, near Tunbridge Wells, and on the Downs in Kent, in Cambridgeshire, and in the Isle of Anglesea. Peduncles from 1—8, the more numerous the shorter, beset with glandular bristles. Fruit large, and globular. A shrub, growing to the height of 6 ft., and flowering in June and July.

✻ 44. *R. SYLVESTRIS* Lindl. The Wood Rose.

Identification. Lindl. Syn. Brit. Fl., p. 101; Don's Mill., 2. p. 576.

Synonymy. *R. tomentosa sylvestris* Woods.

Spec. Char., &c. Stem erect, coloured, flexuous. Prickles hooked. Leaflets oblong, acute, hoary on both sides. Sepals diverging, deciduous before the fruit is ripe. Fruit elliptic, bristly. (*Don's Mill.*, ii. p. 576.) Native of Oxfordshire, in hedges. Growing to the height of 6 ft. or 8 ft., and flowering in June and July.

✻ 45. *R. MO'LLIS* Led. The soft-leaved Rose.

Identification. Led. ex Spreng. Syst., 2. p. 551; Don's Mill., 2. p. 577.

Synonymy. *R. Ledebourii* Spreng. Syst., 2. p. 551.

Spec. Char., &c. Ovaries ovate, glaucous, and prickly, as well as the peduncles. Branches unarmed and pubescent, as well as the petioles. Leaflets obtuse, doubly serrated, villous on both surfaces. (*Don's Mill.*, ii. p. 577.) Native of Caucasus. Introduced in 1818; growing to the height of from 4 ft. to 6 ft., and flowering in June and July.

✻ 46. *R. A'LIBA* Lin. The common white Rose.

Identification. Lin. Sp., 705; Lawr. Ros., t. 23. 25. 32. 37; CEd. Fl. Dan., t. 1215; Red. Ros. 1. p. 97. and p. 17; Don's Mill. 2. p. 577.

Synonymy. *R. usitatissima* Gat. Montaub., t. 94.

Engravings. Lawr. Ros., t. 23. 25. 32. 37; CEd. Fl. Dan., t. 1215; Red. Ros., 1. p. 17., and p. 97.; Gat. Montaub., t. 94.; and our fig. 496.

Spec. Char., &c. Leaflets oblong, glaucous, rather naked above, simply serrated. Prickles straightish or falcate, slender or strong, without bristles. Sepals pinnate, reflexed. Fruit unarmed. (*Don's Mill.*, ii. p. 577.) Native of Piedmont, Cochin-China, Denmark, France, and Saxony. Flowers large, either white, or of the most delicate blush colour, with a grateful fragrance. Fruit oblong, scarlet, or blood-coloured. A shrub, growing from 4 ft. to 10 ft. in height, and flowering in June and July.



496

Varieties. The garden varieties are very numerous; and some of the most beautiful are the double, semidouble, and single blush; the celestial, a well-known favourite; the great, small, and cluster maiden's blush; the double thornless; and the double, semidouble, and single white. The rose blanche à cœur vert, the bouquet blanc, and the blanche de la Belgique are well-known and beautiful French varieties of this species.

§ vii. *Rubiginosæ* Lindl.

Derivation. From *rubiginosus*, rusty; the leaves of the species being usually furnished with rust-coloured glands beneath.

Sect. Char., &c. Prickles unequal, sometimes bristle-formed, rarely wanting. Leaflets ovate or oblong, glandular, with diverging serratures. Sepals permanent. Disk thickened. Root-shoots arched. The numerous glands on the lower surface of the leaves will be sufficient to prevent anything else being referred to this section; and although *R. tomentosa* has sometimes glandular leaves, the inequality of the prickles of the species of *Rubiginosæ*, and their red fruit, will clearly distinguish them. (*Don's Mill.*, ii. p. 577.) This division includes all the eglantine, or sweet-briar, roses.

47. *R. LUTEA* Dodon. The yellow *Eglantine* Rose.

Identification. Dodon. Pempt, 187; Mill. Diet., No. 11.; Lawr. Ros., t. 12.; Curt. Bot. Mag., t. 363.; Don's Mill., 2. p. 577.

Synonymes. *R. Eglantèria* Lin Sp. 703., Red. Ros., 1. p. 69.; *R. fœtida* Herm. Diss., 18.; *R. chlorophylla* Ehrh. Beitr., 2. p. 69.; *R. cœrea* Rossig. Ros. t. 2.

Engravings. Lawr. Ros., t. 12.; Curt. Bot. Mag., t. 363.; Red. Ros., 1. p. 69.; Rossig. Ros., t. 2.; and our fig. 497.

Spec. Char., &c. Prickles straight. Leaflets deep green.

Sepals nearly entire, setigerous. Petals flat, concave.

Flowers deep yellow, large, cupshaped, solitary. Fruit

unknown. A shrub, a native of Germany and the south

of France; introduced in 1596; growing from 3 ft. to

4 ft. high, and flowering in June.

Varieties.

- 497
- 498
- 499
- 47. *R. l. 2 subrùbra* Red. Ros., iii. p. 73., with a fig.— Peduncles rather hispid and glandular. Leaves and petioles glabrous. Stem prickly at the base. Prickles unequal, scattered. Petals of a lurid red above, and yellowish beneath. Stigmas yellow. (*Don's Mill.*, ii. p. 577.)

- 48. *R. l. 3 punicea* Lindl. Ros., p. 84.; *R. punicea* Mill. Diet., No. 12., *Rossig. Ros.*, t. 5.; *R. cinnamomea* Roth *Fl. Germ.*, 1. p. 217.; *R. lutea bicolor* Jacq. *Vind.*, 1. t. 1., *Lawr. Ros.*, t. 6., *Sims Bot. Mag.*, t. 1077.; *R. Eglantèria punicea* Red. Ros., 1. p. 71. t. 24.; *R. Eglantèria bicolor* Dec. *Fl. Fr.*, iv. p. 437.; and our fig. 498.; has the petals scarlet above, and yellow beneath.

48. *R. RUBIGINOSA* Lin. The rusty-leaved Rose, *Sweet Briar*, or *Eglantine*.

Identification. Lin. Mant., 2. p. 594.; Dec. Prod., 2. p. 604.; Don's Mill., 2. p. 577.

Synonymes. *R. suavitolia* Lightf. Scot., 1. p. 261., *Fl. Dau.*, t. 870.; *R. Eglantèria* Mill. Diet., No. 4., *Lin. Sp.*, edit. 1. p. 491.; *R. agrèstis Savi* *Fl. Pis.*, p. 475.; *R. rubiginosa parviflora* Rau. *Enum.*, 135.

Engravings. Eng. Bot., t. 991.; Curt. Fl. Lond., t. 116.; Jacq. Austr., t. 50.; Lawr. Ros., t. 41. 61. 65. 72. and 74.; Schkuhr *Handb.*, t. 134.; and our fig. 499.

Spec. Char., &c. Prickles hooked, compressed, with smaller straighter ones interspersed. Leaflets

elliptical, doubly serrated, hairy, clothed beneath

with rust-coloured glands. Sepals pinnate, and

bristly, as well as the peduncles. Fruit obovate,

bristly towards the base. (*Don's Mill.*, ii. p. 577.)

Native throughout Europe, and of Caucasus. In

Britain, in bushy places, on a dry gravelly or chalky

soil. Leaves sweet-scented when bruised. Flowers

pink. Fruit scarlet, obovate or elliptic. A shrub,

growing from 4 ft. to 6 ft. in height, and flowering

in June and July.

Varieties.

- 49. *R. r. 2 Vaillantiana* Red. Ros., 3. p. 95., with a fig. — Fruit ovate and hispid. Prickles of the branches somewhat horizontal. Leaflets nearly glabrous above. Flowers white.
- 50. *R. r. 3 rotundifolia* Lindl. Ros., 88. — Branches flagelliform. Leaflets roundish and small. Tube of the calyx nearly globose, and glabrous. Flowers solitary. A native of Germany.
- 51. *R. r. 4 aculeatissima* Dup. Gym. Ros., 13. ex Red. et Thor. Ros., 2. p. 97. — Flowers usually solitary. Prickles straightish and very numerous. Usually cultivated in gardens.
- 52. *R. r. 5 nemoralis* Red. et Thor. Ros., 2. p. 23., with a fig. — Leaflets large and thin. Prickles straightish and few. A native of France.
- 53. *R. r. 6 umbellata* Lindl. Ros., 87.; *R. tenuiglandulosa* Mer. *Fl. Par.*, 189.; *R. r. Eglantèria cymbosa* Woods in *Lin. Trans.*; *R. sempervirens* Roth *Fl. Germ.*, 1. p. 218.; has flowers several in a fascicle. Fruit globose, almost smooth. Peduncles hispid. Branches very prickly; prickles hooked.
- 54. *R. r. 7 pibera* Ser. in *Dec. Prod.* has the leaflets and petioles puberulous.
- 55. *R. r. 8 grandiflora* Lindl. Ros. has large flowers and glabrous purple fruit. The leaflets are nearly naked, and the peduncles glabrous.
- 56. *R. r. 9 majora* Ser. has erect stems, broad leaflets, and semidouble flowers.

- ✻ *R. r. 10 spinulifolia* Ser. in *Dec. Prod* has large prickles, straight and somewhat deflexed; with oval leaflets, spinulose beneath.
 ✻ *R. r. 11 flexuosa* Lindl. Ros., 88.—Branches very flexible. Leaflets nearly orbicular. Bractes deciduous.
 ✻ *R. r. 12 parvifolia* Lindl. Ros., 145., is a dwarf shrub, with bristly branches, roundish leaflets, and flowers of a pale rose-colour.

Garden Varieties. Some of the best for an arboretum are, the blush, cluster, double, dwarf, semi-double, mossy, scarlet, tree double, and white semidouble.

✻ 49. *R. SUAVE'OLENS Pursh.* The sweet-scented Rose, *American Sweet Briar*, or *Eglantine*.

Identification. Pursh Fl. Amer. Sept., vol. 1. p. 346.; Don's Mill., 2. p. 578.

Synonymes. *R. rubiginosa* and *Eglantaria* of the Americans, *Rafin. Ros. Amer.* in *Ann. Phys.*, 5. p. 518.

Spec. Char., &c. Prickles scattered, straight. Petioles beset with glandular bristles. Leaflets ovate, serrated, sparingly glandular beneath. Flowers usually solitary. Peduncles bracteate. Fruit ovate. (*Don's Mill.*, ii. p. 578.) Native of North America. Leaves sweet-scented when bruised. Flowers pink. Sepals entire. A shrub, growing to the height of 5 ft. or 6 ft., and flowering in June and July.

✻ 50. *R. MICRA'NTHA Sm.* The small-flowered Rose, or *Sweet Briar*.

Identification. Smith in Eng. Bot., t. 240.; Don's Mill., 2. p. 578.

Synonyme. *R. rubiginosa* β *micrantha* Lindl. Ros., p. 87., with erroneous synonymes.

Spec. Char., &c. Prickles hooked, scattered, nearly uniform. Leaflets ovate, doubly serrated, hairy, glandular beneath. Sepals pinnate. Fruit elliptic, rather bristly, contracted at the summit. Stems straggling. (*Don's Mill.*, ii. p. 578.) Native of Britain, in hedges and thickets, chiefly in the south of England. Leaves sweet-scented. Flowers small, pale red. A shrub, from 4 ft. to 5 ft. in height, flowering in June and July.

✻ 51. *R. SE'PIUM Thuil.* The Hedge Rose, or *Briar*.

Identification. Thuil Fl. Par. 252.; Borr. in Eng. Bot. Suppl., t. 2653.; Don's Mill., 2. 578.

Synonymes. *R. helvética* and *R. myrtifolia* Hall; *R. canina* β *Dec. Fl. Fr.*, ed. 3. No. 3617.; *R. agróstis Savi Fl. Pis.*, 1. p. 474.; *R. biserrata*, *R. macrocarpa*, and *R. stipularis* Mer. *Fl. Par.*, 190., ex *Descv.*, f. 75.

Engraving. Eng. Bot. Suppl., t. 2653.

Spec. Char., &c. Prickles slender. Branches flexuous. Leaflets shining, acute at both ends. Flowers usually solitary. Fruit polished. Sepals pinnate, with very narrow segments. (*Don's Mill.*, ii. p. 578.) Native of Europe, in hedges; in England, near Bridport, Warwickshire. Flowers small, pink. A shrub, growing from 4 ft. to 6 ft. in height, and flowering in June and July.

✻ 52. *R. IBE'RICA Stev.* The Iberian Rose.

Identification. Stev. in Bieb. Fl. Taur. Suppl., 343.; Don's Mill., 2. p. 578.

Spec. Char., &c. Cauline prickles scattered, hooked, dilated at the base. Petioles glandular and prickly. Leaflets broad, ovate, glandularly biserrated, and beset with glands on both surfaces. Fruit ovate, smooth, or with a few bristles, as well as the peduncles. (*Don's Mill.*, ii. p. 578.) Native of Eastern Iberia, about the town of Kirzchival. Very nearly allied to *R. pulverulenta*, according to Bieberstein. A shrub, growing from 4 ft. to 6 ft. in height, and flowering in June and July. Introduced in 1820.

✻ 53. *R. GLUTINO'SA Smith.* The clammy Rose, or *Briar*.

Identification. Smith. Fl. Græc. Prod., 1. p. 348.; Fl. Græc., t. 482.; Don's Mill., 2. p. 578.

Synonymes. *R. rubiginosa crética* Red. Ros., 1. p. 93., and p. 125. t. 47.; *R. rubiginosa sphaerocarpa* *Descv. Journ. Bot.*, 1813, t. 118., *Cupan. Pamph.*, ed. 1. t. 61.

Spec. Char., &c. Branches pilose. Prickles numerous, falcate. Leaflets roundish, coarsely serrated, hoary, glandular, and viscid or both surfaces. Fruit and peduncles beset with stiff bristles. (*Don's Mill.*, ii. p. 578.) Flowers pale blush. Sepals subpinnate. Fruit scarlet. Native of Mount Parnassus, and of Sicily and Candia, on the mountains. Introduced in 1821; growing to the height of 2 ft. or 3 ft., and flowering in June and July.

✻ 54. *R. KLU'KII Bess.* Kluki's Rose, or *Sweet Briar*.

Identification. Bess. Cat. Hort. Crem., 1816, Suppl., 4. p. 19.; Bieb. Fl. Taur. Suppl., 343.; Don's Mill., 2. p. 579.

Synonymes. *R. rubiginosa* Bieb. Fl. Taur., No. 979., exclusive of the synonymes; *R. floribunda* Stev.; *R. balsamea* Bess.

Spec. Char., &c. Cauline prickles strong, compressed, dilated at the base, recurved. Petioles villous and prickly. Leaflets small, elliptic, acute, sharply biserrated, with the serratures glandular, villous above, but rusty and glandular beneath. Peduncles and fruit beset with glandular bristles. (*Don's Mill.*, ii. p. 579.) Flowers pink. Allied to *R. rubiginosa*, according to Bieberstein; but, according to Besser, to *R. alba*. Native of Tauria. Introduced in 1819; growing to the height of 5 ft. or 6 ft., and flowering in June and July.

✻ 55. *R. MONTEZUMÆ Humb.* Montezuma's Rose, or *Briar*.

Identification. Humb. et Bonpl. in Red. Ros., 1. p. 55.; Don's Mill., 2. p. 579.

Engraving. Humb. et Bonpl. in Red. Ros., 1. p. 55. t. 16.

Spec. Char., &c. Petioles armed with little hooked prickles. Branches unarmed. Leaflets ovate, sharply serrated, glabrous. Flowers solitary, terminal. Tube of calyx elliptic, and, as well as the peduncles, glabrous. (*Don's Mill.*, ii. p. 279.) Native of Mexico, on the chain of porphyry mountains which bound the valley of Mexico on the north, at the elevation of 1416 toises, on the top of Cerro Ventosa, near the mine of San Pedro. Flowers pale red. Sepals compound, dilated at the end. A shrub growing to the height of from 4 ft. to 6 ft., and flowering in June and July. Introduced in 1825.

§ viii. *Canina* Lindl.

Derivation. From *caninus*, belonging to a dog; because *R. canina* is commonly called the dog rose. The name is applied to this section, because all the species contained in it agree in character with *R. canina*.

Sect. Char., &c. Prickles equal, hooked. Leaflets ovate, glandless or glandular, with the serratures conniving. Sepals deciduous. Disk thickened, closing the throat. Larger suckers arched. (*Don's Mill.*, ii. p. 579.)

✽ 56. *R. CAUCA`SEA* Pall. The Caucasian Dog Rose.

Identification. Pall. Ross., t. 11.; Lindl. Ros., p. 97.; Don's Mill., 2. p. 579.

Synonymy. *R. leucantha* Bieb. *Fl. Taur. Suppl.*, 351.?

Engravings. Lind. Ros., t. 11.; and our fig. 500.

Spec. Char., &c. Prickles strong, recurved. Leaflets soft, ovate. Calyx and peduncles hispid. Sepals simple. Fruit smooth. (*Don's Mill.*, ii. p. 579.) Flowers large, growing in bunches, white or pale red. A shrub, growing to the height of from 10 ft. to 12 ft., and flowering in June and July. Introduced in 1798. This species, as grown in the collection of Messrs. Loddiges, is of a robust habit, with glaucous leaves, flowering and fruiting freely. The plant is a useful one for the filling up of large shrubberies.



✽ 57. *R. CANI`NA* Lin. The common Dog Rose.

Identification. Lin. Sp., 704.; Don's Mill., 2. p. 579.

Synonymy. *R. dumalis* Bechst. *Forstb.*, 241. and 939. ex *Rau.*; *R. andegavensis* Bat. *Fl. Main. et Loir.*, 189., *Red. Ros.*, 2. p. 9. t. 3.; *R. glauca* Lois. in *Desc. Journ.*; *R. arvensis* Schrank *Fl. Mon.*; *R. glaucescens* Mer. *Par.*; *R. nitens* Mer., 1. c.; *R. teneriffensis* Donn *Hort. Cant.*, ed. 8. p. 169.; *R. senticosa* Achar. *Acad. Handl.*, 34. p. 91. t. 3.

Engravings. Eng. Bot., t. 992.; Fl. Dan., t. 555.; Curl. Lond., t. 299.; Lawr. Ros., t. 21. 29.

Spec. Char., &c. Prickles strong, hooked. Leaflets simply serrated, pointed, quite smooth. Sepals pinnate. Fruit ovate, smooth, or rather bristly, like the aggregate flower stalks. (*Don's Mill.*, ii. p. 579.) Native throughout Europe, and the north of Africa; plentiful in Britain, in hedges, woods, and thickets. Flowers rather large, pale red, seldom white. Fruit ovate, bright scarlet, of a peculiar and very grateful flavour, especially if made into a conserve with sugar. The pulp of the fruit, besides saccharine matter, contains citric acid, which gives it an acid taste. The pulp, before it is used, should be carefully cleared from the nuts or seeds. A shrub, growing to the height of 6 ft. or 10 ft., and flowering in June and July.

Varieties.

✽ *R. c. 2 surculosa* Woods in *Lin. Trans.* only differs from the species in having remarkably strong shoots, bearing sometimes great plenty of flowers.

✽ *R. c. 3 nuda* Woods l. c. differs very slightly from the species.

✽ *R. c. 4 aciphýlla* Lind. Ros., p. 99.; *R. aciphýlla* *Rau.*, 69. with a fig., *Red. Ros.*, ii. p. 31. t. 13., and our figs. 501. 502.; is a very remarkable variety, from the straightness of its shoots, and its singular habit of growth. The leaves are smooth on both surfaces, and the flowers are smaller than those of the species.

✽ *R. c. 5 ægyptiaca* Lind. Ros., p. 99.; *R. indica* *Forsk. Ægyp. Descr.*, 113.; has the leaflets broader and more glabrous than the species.

✽ *R. c. 6 burboniana* Desv. *Journ. Bot.*, 1813; *R. gallica burbonica* *Red. Ros.*, i. p. 74.; has the leaflets rather cordate, and the flowers purple and semidouble.



- ♣ *R. c. 7 nitens* Desv. Journ. Bot., 1813, p. 114., Ser. Mel., i. p. 43.; *R. nitens* Desv. in *Mer. Fl. Par.*, 192.; has smooth shining leaflets, and ovate fruit.
- ♣ *R. c. 8 obtusifolia* Desv. Journ. Bot., 1813, p. 15.; *R. obtusifolia* Desv. Journ. Bot., ii. p. 1809, p. 317.; *R. leucantha* Lois. Bot. 1802, *Bast. Suppl.*, 32., *Dec. Prod. Fl. Fr.*, v. p. 535., but not of Bieb.; has the leaflets rather pilose beneath.
- ♣ *R. c. 9 glaucescens* Desv. Journ. Bot., 1813, p. 114.; *R. glaucescens* Desv. in *Mer. Fl. Par.*, 192.; *R. canina glauca* Desv. Journ. Bot., 1813, p. 116.; is a native of France, with slender prickles, and leaves that are glaucous beneath.
- ♣ *R. c. 10 Schottiana* Ser. in *Dec. Prod.*, ii. p. 116.; *R. glauca Schott* ex *Besser Enum.*, 64.; is a native of Podolia, with rugged unarmed branches and smooth fruit.
- ♣ *R. c. 11 pilosiuscula* Desv. Journ. Bot., 1813, p. 115.; *R. humilis* Bess. *Suppl. Cat. Crem.*, 4.; *R. nitidula* Bess. *Enum.*, p. 20. and 61.; *R. friedlanderiana* Besser. *Enum.*, 46. 60. 63.; *R. collina* Rau. *Enum.*, No. 163.; has the branches prickly, the petioles tomentose and hispid, and the fruit ovate and rather smooth.
- ♣ *R. c. 12 fastigiata* Desv. Journ. Bot., 1813, p. 114.; *R. fastigiata* Bast. *Suppl.*, 30., *Dec. Fr.* v. p. 535., *Red. Ros.*, ii. p. 3.; *R. stylosa* β Desv. Journ. Bot., ii. p. 317.; has the prickles strong, and the fruit smooth; it is a stiff upright-growing plant, a native of France.
- ♣ *R. c. 13 hispida* Desv. Journ. Bot., 1813, p. 114.; *R. canina* var. lanceolata, grandidentata, and ovoidalis Desv. l. c., p. 114. and 115.; *R. andegavensis* Bast. *Ess.*, 189., *Suppl.*, 29., *Dec. Fl. Fr.*, v. p. 539., *Red. Ros.* ii. p. 9.; *R. sempervirens* Bast. *Ess.*, p. 188., *Rau. Enum.*, 120., *Lindl. Ros.*, p. 142., but not of Lin.; has the fruit and peduncles hispid, and the branches prickly.
- ♣ *R. c. 14 microcarpa* Desv. Journ. Bot., 1813, p. 115., has the leaflets velvety beneath, and the fruit small, ovate, and glabrous. It is a native of France.
- ♣ *R. c. 15 Meratiana* Ser. in *Dec. Prod.*, ii. p. 614.; *R. biserrata* Mer. *Fl. Par.*, 190., *Red. Ros.*, iii. p. 27.; very closely resembles the species, except in the fruit being somewhat larger.
- ♣ *R. c. 16 ambigua* Desv. Journ. Bot., 1813, p. 114.; *R. malmundiarensis* Lejeune *Fl. Spa.*, i. p. 231., *Red. Ros.*, p. 34.; has the fruit and peduncles smooth.
- ♣ *R. c. 17 squarrosa* Rau. *Enum.*, 77.; *R. canina* β *Dict. Fl. Taur.*, i. p. 400., ex *Rau. l. c.*, has the leaflets doubly serrated, and is a native of Germany.
- ♣ *R. c. 18 rubiflora* Ser. in *Dec. Prod.*, ii. p. 614., has flowers resembling those of the common raspberry.

♣ 58. *R. FORSTERI* Sm. Forster's Dog Rose.

Identification. Smith *Engl. Fl.*, 2. p. 392.; Borr. in *Eng. Bot. Suppl.*, 2611.; Don's *Mill.*, 2. p. 580.

Synonyme. *R. collina* β and γ, *Woods* in *Lin. Trans.*, 12. p. 392.

Engraving. *Eng. Bot. Suppl.*, t. 2611.

Spec. Char., &c. Prickles scattered, conical, hooked. Leaflets simply serrated, smooth above, but hairy on the ribs beneath. Sepals doubly pinnate. Fruit elliptical, smooth, like the aggregate flower stalks. (*Don's Mill.*, ii. p. 580.) A native of Europe, in hedges; plentiful in England. Flowers pale red. A shrub, growing to the height of from 6 ft. to 8 ft.; flowering in June and July.

♣ 59. *R. DUMETORUM* Thuill. The Thicket Dog Rose.

Identification. Thuill. *Fl. Par.*, 250.; Bor. in *Eng. Bot. Suppl.*, t. 2610.; Don's *Mill.*, 2. p. 580.

Synonymes. *R. leucantha* β acutifolia Bast. in *Dec. Fl. Fr.*, 5. p. 535.; *R. sepium* *Borkh.* ex *Rau. Enum.*, 79.; *R. solstitialis* Bess. *Prim. Fl. Gall.*, 324.; *R. corymbifera* *Gmel. Fl. Bad. Als.*, 2. p. 427.

Engraving. *Eng. Bot. Suppl.*, t. 2610.

Spec. Char., &c. Prickles numerous, scattered, hooked. Leaflets simply serrated, hairy on both surfaces. Sepals pinnate, deciduous. Peduncles aggregate, slightly hairy. Fruit elliptical, smooth, as long as the bracteas. (*Don's Mill.*, ii. p. 580.) Native of Europe, in hedges; and found, in England, in the southern counties, but seldom in any abundance. Flowers reddish. A shrub, growing from 4 ft. to 6 ft. in height, and flowering in June and July.

☼ 60. *R. BRACTE'SCENS* Woods. The bractescent *Dog Rose*.

Identification. Woods in Lin. Trans., 12. p. 216; Don's Mill., 2. p. 580.

Spec. Char., &c. Prickles aggregate, hooked. Leaflets ovate, almost simply serrated, downy beneath. Bractes rising much above the fruit. Sepals pinnate, falling off. Peduncles aggregate, occasionally rather hairy. Fruit globose, smooth. (*Don's Mill.*, ii. p. 580.) Native of England, in hedges, about Ulverton, Lancashire; and Ambleton, Westmoreland. Flowers flesh-coloured. A shrub, 6 ft. to 7 ft. high, and flowering in June and July.

☼ 61. *R. SARMENTA'CEA* Swartz. The sarmentaceous *Dog Rose*.

Identification. Swartz MSS.; Woods in Lin. Trans., 12. p. 213; Don's Mill., 2. p. 580.

Synonymes. *R. glaucophylla* *Winch Geogr. Distrib.*, 45; *R. canina* *Roth Fl. Germ.*, 2. p. 560.

Engraving. Curt. Lond., fasc. 5. t. 34.

Spec. Char., &c. Prickles hooked. Leaflets ovate, doubly serrated, smooth, glandular. Peduncles aggregate, smooth or minutely bristly. Sepals pinnate, deciduous. Fruit broadly elliptic, naked. (*Don's Mill.*, ii. p. 580.) Native of Europe, common in hedges and bushy places; plentiful in Britain. Flowers pink, and fragrant. Fruit scarlet; as grateful to the palate, probably, as that of *R. canina*, with which this equally common plant is generally confounded. A shrub, 8 ft. to 10 ft. high; flowering in June and July.

☼ 62. *R. CÆ'SIA* Sm. The grey *Dog Rose*.

Identification. Smith Eng. Bot., t. 2367; Don's Mill., 2. p. 580.

Synonymes. *R. canina pubescens* *Afx. Ros. Succ. Tent.*, 1. p. 2; *R. canina* ζ *cæ'sia* *Lindl. Ros.*, p. 99.

Engraving. Eng. Bot., t. 2367.

Spec. Char., &c. Prickles hooked, uniform. Leaflets elliptical, somewhat doubly serrated, glaucous, hairy beneath, without glands. Sepals distantly pinnate, deciduous. Flower stalks smooth, solitary. Fruit elliptical, smooth. (*Don's Mill.*, ii. p. 580.) Native of Scotland, in the Highland valleys, but rare; at Taymilt, in Mid-Lorn, Argyleshire; and in Strath Tay, between Dunkeld and Aberfeldie, and by the side of Loch Tay. Flowers generally of a uniform carnation hue, but occasionally white. A shrub, from 4 ft. to 5 ft. in height; flowering in July.

☼ 63. *R. BO'RRERI* Woods. Borrer's *Dog Rose*.

Identification. Woods in Lin. Trans., 12. p. 210; Don's Mill., 2. p. 580.

Synonymes. *R. dumetorum* *Smith in Eng. Bot.*, t. 2579; *R. rubiginosa* ϑ *Lindl. Ros.*, p. 88; *R. rubiginosa inodora* *Hook. Lond.*, t. 117; *R. sepium* *Börkh. ex Rau. Enum.* 90. ? but not of Thuil; *R. affinis* *Rau. Enum.*, 79; *R. uncinella* β *Besser Enum.*, 64. ?

Engravings. Eng. Bot., t. 2579; Hook. Lond., t. 117.

Spec. Char., &c. Prickles hooked. Leaflets ovate, doubly serrated, hairy, without glands. Sepals pinnate, often doubly pinnate, deciduous. Flower stalks aggregate, hairy. Fruit elliptical, smooth. Native of Britain, in hedges and thickets. (*Don's Mill.*, ii. p. 580.) Flowers pale red. Fruit deep scarlet. A shrub, growing from 6 ft. to 10 ft. in height; flowering in June and July.

☼ 64. *R. RUBRIFO'LIA* Vill. The red-leaved *Dog Rose*.

Identification. Vill. Dauph., 3. p. 549; Don's Mill., 2. p. 581.

Synonymes. *R. multiflora* *Reyn. Act. Laus.*, 1. p. 70. t. 6; *R. rubicunda* *Hall. Fil. in Roem. Arch.*, 3. p. 376; *R. lurida* *Andr. Ros.*; *R. cinnamomea* γ *rubrifolia* *Red. Ros.*, 1. p. 134.

Engravings. Bell. in Act. Taur., 1790. p. 229. t. 9; Jacq. *Fragm.*, 70. t. 106; *Red. Ros.*, 1. p. 35. t. 4; Lindl. in Bot. Reg., t. 430; and our fig. 503.

Spec. Char., &c. Prickles small, distant. Leaflets ovate, and, as well as the branches, glabrous, opaque, discoloured. Sepals narrow, entire. Fruit ovate, globose, smooth. Flowers corymbose. Peduncles smooth. (*Don's Mill.*, ii. p. 581.) Native of Dauphiné, Austria, Savoy, Pyrenees, and Auvergne, in woods. Stems red. Leaves red at the edges. Flowers small, deep red. Sepals narrow, longer than the petals.



503

A shrub, growing to the height of 5 ft. or 6 ft., and flowering in June and July; and producing a pleasing effect in a shrubbery, from the pinkness of its foliage. At the funeral of Villars, who first named and described this rose, branches and flowers of it were cut and strewed over his grave.

Varieties.

☼ *R. r. 2 hispidula* Ser. *Mus. Helv.*, 1. p. 8. and p. 12. t. 1; *R. cinnamomea* *glauca* *Desv. Jour. Bot.*, 1813, p. 120, *Red. Ros.*, 1. p. 134. — Leaflets ovate. Flowers red. Fruit smooth and corymbose. Peduncles hispid; and sepals entire.

☼ *R. r. 3 Redoutèa* Ser. in *Dec. Prod.*, 2. p. 609. — Stems and branches reddish. Prickles slender, and hardly curved. Corymbs few-flowered. Petals a very pale red, with rose-coloured and dotted margins. G. Don supposes this a hybrid between *R. rubrifolia* and *R. spinosissima*.

☼ *R. r. 4 inermis* Ser. in *Dec. Prod.* has the stem and branches unarmed. It is a native of Switzerland.

☼ *R. r. 5 pinnatifida* Ser. in *Mus. Helv.*, 1. p. 11; *R. r. germinibus ovatis*, and *R. montana germinibus glabris* *Schleich. Cat.*, 1815, p. 24, and 46; *R. canina* *globosa* *Desv. Journ. Bot.*, 1813, p. 114; has the leaflets ovate; the flowers solitary and terminal; the sepals pinnatifid; and the fruit globose and smooth. It is a native of Switzerland.

■ 65. *R. INDICA* L. The Indian, or common China, Rose.

Identification. Lin. Sp., 705.; Don's Mill., 2. p. 581.

Synonyms. *R. sīnica* Lin. *Syst. Veg.*, ed. 13. p. 398.; *R. semperfloreus cārnea* *Rossg. Ros.*, t. 19.; *R. indica chinēnsis semiplena* *Ser. Mel.*, 1. p. 31.; *R. reclinata flore submultiplici* *Red. Ros.*, p. 79.; the monthly Rose, the blush China Rose, the Tea-scented Rose; Rosier Indien, Rose Th e, Fr.; Indische Rose, Ger.

Engravings. Lawr. Ros., t. 26.; Red. Ros., 1. p. 51. t. 142., p. 35. t. 15.; and our fig. 504.

Spec. Char., &c. Stem upright, whitish, or green, or purple. Prickles stout, falcate, distant. Leaflets 3—5; ovate-acuminate, coriaceous, shining, glabrous, serrulate; the surfaces of different colours. Stipules very narrow, connate with the petiole, almost entire, or serrate. Flowers solitary, or in panicles. Stamens bent inwards. Peduncle subarticulate, mostly thickened upwards, and with the calyx smooth, or wrinkled and bristly. (*Dec. Prod.*, ii. p. 600.) Native of China, near Canton. Flowers red, usually semidouble. Petioles setigerous and prickly. Petals obovate. A shrub, growing to the height of from 4 ft. to 20 ft., and flowering throughout the year. It was introduced in 1789.



504

Varieties. There are numerous varieties of this beautiful rose cultivated in England; but the garden varieties of it are very generally confounded with those of *R. semperfloreus*. The following are quite distinct; and may each be considered the type of a long list of subvarieties.

■ *R. i. 2 Noisettiana* *Ser.* in *Dec. Prod.*, ii. p. 600., *Don's Mill.*, ii. p. 581. *The Noisette Rose.* (*fig. 505.*) — Stem firm, and, as well as the branches, prickly. Stipules nearly entire. Flowers panicle, very numerous, semidouble, pale red. Styles exerted. This well-known and very beautiful rose is almost invaluable in a shrubbery, from its free and vigorous growth, and the profusion of its flowers, which are continually being produced during the whole summer. Numerous subvarieties have been raised of the Noisette rose, some of the most distinct of which are, the *R. i. N. purpurea* of Redout e, which has red flowers; *R. i. N. nivea*, the Aime Vibert of the French nurseries, which has double white flowers, and which is probably a hybrid between *R. indica* and *R. moschata*; *R. i. N. Smithii*, Smith's yellow Noisette rose, the flowers of which are very double, of a deeper yellow than the double yellow China rose (*R. i. ochroleuca*), and disposed in clustered corymbs of from 10 to 22, and are highly fragrant. This new kind of rose is perfectly hardy, is readily increased by cuttings, and may be regarded as a most valuable addition to our already numerous list of China roses. (*Brit. Flow.-Gard.* 2 Ser. t. 158.)



505

■ *R. i. 3 odoratissima* Lindl. *Ros.*, p. 106., *Bot. Reg.*, t. 864., *Don's Mill.*, ii. p. 582.; *R. odoratissima* *Sut. Hort. Sub. Lond.*; *R. indica fragrans* *Red. Ros.*, i. p. 6. t. 19.; and our *fig. 506.*; *the sweetest, or tea-scented, China Rose*; Rose  



506

Odeur de Thé, *Fr.*; has semidouble flowers, of a most delicious fragrance, strongly resembling the scent of the finest green tea. There are numerous subvarieties.

- *R. i. 4 longifolia* Lindl. *Ros.*, p. 106.; *R. longifolia* Willd. *Enum.*, ii. 1079., *Red. Ros.*, ii. t. 27.; *R. semperflorens* var. 7. *N. Du Ham.*, vii. p. 22.; *R. salicifolia* *Hort.*; and our *fig. 507.*; has the stems nearly unarmed, and long lanceolate leaflets.
- *R. i. 5 pumila* Lindl. *Ros.*, p. 106., is a dwarf variety, with purplish flowers, having ovate petals.
- *R. i. 6 caryophyllæa* Red. *Ros.*, iii. p. 69., has the flowers in a kind of panicle, and the leaflets large and thin.
- *R. i. 7 pannosa* Red. has the stems and branches prickly; the leaflets ovate, and red beneath, with the stipules so finely denticulated as to give them somewhat of a fringed or pannose appearance. Flowers drooping a little, purple on the outside, and with the inner petals rose-coloured.
- *R. i. 8 cruenta* Red., and *Don's Mill.*, ii. p. 582.; differing from the above principally in having the stems and branches almost unarmed, and the stipules almost entire.
- *R. i. 9 Fraseriana* *Hort. Brit.*, p. 211., and *Don's Mill.*, ii. p. 582.; a hybrid, with double pink flowers.
- *R. i. 10 riga* Lindl. *Bot. Reg.*, t. 1389., has double blush, changing to white, sweet-scented flowers. It is a hybrid between *R. i. odoratissima* and *R. arvensis*, brought from Italy, where it was raised by Mr. Clare. It grows freely, making shoots 10 ft. or 12 ft. long in a season.
- *R. i. 11 ochroleuca* *Bot. Reg.*, the *yellow China Rose*, has large cream-coloured flowers, deepening almost into yellow in the centre. It was introduced by Mr. Parks, in 1824, and has rapidly become a great favourite, in pots and ornamental flower-gardens.



• 66. *R. SEMPERFLORENS* Curt. The ever-flowering *China Rose*.

Identification. Curt. *Bot. Mag.*, t. 284.; *Smith Exot. Bot.*, 2. p. 91.; *Jacq. Schönbr.*, 3. p. 281.; *Don's Mill.*, 2. p. 582.

Synonymes. *R. diversifolia* *Vent. Cels.*, t. 35.; *R. bengalensis* *Pers. Ench.*, 2. p. 50.; *R. indica* *Red. Ros.*, 1. p. 49. t. 13., p. 123. t. 46., and 2. p. 37. t. 16.

Engravings. *Lawr. Ros.*, t. 23.; *N. Du Ham.*, vii. t. 18.; and our *fig. 508.*, of a double French variety. 518

Spec. Char., &c. Branches dark green, armed with scattered, compressed, hooked prickles, and a very few glands. Leaflets 3—5, ovate-lanceolate, crenate-serrated, shining above, but glaucous and slightly setigerous beneath. Sepals compound, narrow. Fruit spherical. (*Don's Mill.*, ii. p. 582.) Native of China. Flowers solitary, single, or semidouble, deep crimson. There are some very splendid varieties of this species, with semidouble crimson flowers, in our gardens; and the French appear to have some others still more beautiful, which have not yet been imported. A shrub, introduced in 1789, growing from 8 ft. to 10 ft. in height, and flowering throughout the year.



For this beautiful rose we are indebted to Gilbert Slater, Esq., Low-Layton, Essex, a gentleman to whose memory a genus has not yet been devoted, though he was the means of introducing several of our finest plants.

■ 67. *R. LAWRENCEANA* Swt. *Miss Lawrence's China Rose.*

Identification. Sweet Hort. Suburb.; Lindl. Ros., p. 110.; Don's Mill. 2. p. 582.

Synonymes. *R. semperflōrens minima Sims Bot. Mag.*, t. 1762.; *R. indica* var. *α acuminata Red. Ros.*, 1. p. 53.; *R. indica Lawrenceana Red. Ros.*, 2. p. 38.

Engravings. Red. Ros., 1. p. 53.; and our fig. 509.

Spec. Char., &c. Dwarf. Prickles large, stout, [nearly straight. Leaflets ovate acute, finely serrated. Petals acuminate. (*Don's Mill.*, ii. p. 582.) Native of China. Flowers small, single or semidouble, pale blush. A shrub, 1 ft. in height, which flowers throughout the year. The beautiful little plants called fairy roses are nearly all varieties of *R. Lawrenceana*; and they are well worthy of culture, from their extreme dwarfness (often flowering when not more than 6 in. high), and the beautiful colour of their miniature rose-buds, the petals of which appear of a much darker hue than those of the expanded flower.



§ ix. *Systylæ* Lindl.

Derivation. From *sun*, together, and *stulos*, a style; in reference to the styles being connected.

Sect. Char. Styles cohering together into an elongated column. Stipules adnate. The habit of this section is nearly the same as that of the last division. The leaves are frequently permanent. (*Don's Mill.*, ii. p. 582.)

■ ✕ 68. *R. SYSTYLA* Bat. The connate-styled Rose.

Identification. Bat. Fl. Main. et Loir. Suppl., 31.; Don's Mill., 2. p. 582.

Synonymes. *R. collina Smith in Eng. Bot.*, t. 1895.; *R. stylōsa Desv. Journ. Bot.*, 2. p. 317.; *R. brevistyla Dec. Fl. Fr. Suppl.*, p. 537.; *R. bibracteata Dec.*, l. c.; *R. systyla α ovata Lindl. Ros.*, p. 111.

Engraving. Eng. Bot., t. 1895.

Spec. Char., &c. Shoots assurgent. Prickles strong, hooked. Peduncles glandular. Sepals pinnate, deciduous. Styles smooth. Floral receptacle conical. (*Don's Mill.*, ii. p. 582.) Native of France and England, in hedges and thickets; common in Sussex; at Walthamstow, Quendon, and Clapton, near London; at Dunnington Castle, Berkshire; near Penshurst, Kent; and Hornsey, Middlesex; hills in the south of Scotland. Flowers fragrant, pink or almost white. Fruit ovate-oblong. A shrub, growing to from 8 ft. to 12 ft. in height, and flowering from May to July. There are several varieties, but they do not differ materially in appearance from the species.

■ ✕ 69. *R. ARVENSIS* Huds. The Field Rose.

Identification. Huds. Fl. Angl., ed. 1. p. 192., according to Lindl. Ros. Mon.; Lin. Mant., p. 245.; Dec. Prod., 2. p. 596.

Synonymes. *R. sylvēstris Hem. Diss.*, p. 10.; *R. scādens Mærch Weiss. Pl.*, p. 118.; *R. herpērhodon Ehrh Beitr.*, 2. p. 69.; *R. Hålleri Krok. Siles.*, 2. p. 150.; *R. fūscā Mærch Meth.*, p. 688.; *R. sērpens Ehrh. Arbor.*, p. 35.; *R. sempervirens Rossig. Ros.*; *R. repens Gmel. Fl. Bad. Als.*, 2. p. 418.; *Jacq. Fragm.*, p. 69. t. 104.; *R. rāmpans Reyn. Mém. Lavs.*, 1. p. 69. t. 5.

Engravings. Eng. Bot., t. 188.; Lawr. Ros., t. 86.; Red. Ros., 1. t. 33.; Sims Bot. Mag., t. 2054.; and our fig. 510.

Spec. Char., &c. Shoots cord-like. Prickles unequal and falcate. Leaves deciduous, and composed of 5—7 glabrous, or indistinctly ciliated, leaflets, glaucescent beneath. Stipules diverging at the tip. Flowers solitary or globose. Sepals almost entire, short. Styles cohering into an elongated glabrous column. Fruit ovate, or ovate-globose, coriaceous, crimson, glabrous, or a little hispid, as well as the peduncles. (*Dec. Prod.*, ii. p. 597.) In open situations, a trailing plant, sometimes rooting at the joints; but, in hedges, and among bushes, a climber by elongation; reaching to their tops, and covering them with tufts of foliage and flowers; the leaves remaining on late in the season; and the fruit often remaining on all the winter. The shoots are, in general, feeble, much divided, and entangled; and they generally produce, here and there, rugged excrescences, which readily take root. Hence, by budding the more rare sorts on the shoots, a little above these excrescences, and, after the buds have united, cutting off a portion of the shoot containing the excrescence at one end, and the inoculated bud at the other, and putting in these portions as cuttings, different varieties may be propagated with expedition and ease.



Varieties. Several varieties are enumerated and described in De Candolle's *Prodromus*; but the only ones which we think truly distinct, and of general interest, are the following:—

♣ ✕ *R. a. 2 ayreshirea* Ser. *R. capreolata* Neill in *Edin. Phil. Journ.*, No. 3. p. 102. Cultivated in British gardens under the name of the Ayrshire Rose.—Prickles slender, very acute. Leaflets ovate, sharply serrate, thin, nearly of the same colour on both surfaces. Peduncles hispid with glanded hairs, or wrinkled. A vigorous-growing climber, producing shoots sometimes 20 ft. in length in one season, and flowering profusely from the middle of May to the middle of September. One of the hardiest of climbing roses, and particularly useful for covering naked walls, or unsightly roofs. It is supposed by some to be of American origin, and to have been introduced into Ayrshire by the Earl of Loudon.

♣ ✕ *R. a. 3 hybrida* Lindl. Ros., 113., has semidouble flowers, of a most delicate flesh-colour, and is called, in the nurseries, the double hip rose; the term hip rose being applied by gardeners to the commonest wild roses.

♣ 2. 70. *R. (A.) SEMPERVIRENS* Lin. The evergreen (Field) Rose.

Identification. Lin. Sp., 704; Dec. Prod., 2. p. 597.; Don's Mill., 2. p. 583.
Synonymes. *R. scândens* Mill. Dict., No. 8.; *R. balearica* Desf. Cat. Pers. Ench., 2. p. 49.; *R. atrovirens* Viv. Fl. Ital., 4. t. 6.; *R. sempervirens globosa* Red. Ros., 2., with a fig.; *R. sempervirens* var. α scândens Dec. Fl. Fr., 5. p. 533.
Engravings. Lawr. Ros., t. 45.; Bot. Reg., t. 459.; and our fig. 511.

511

Spec. Char., &c. Evergreen. Shoots climbing.

Prickles pretty equal, falcate. Leaves of 5—7 leaflets, that are green on both sides, coriaceous. Flowers almost solitary, or in corymbs. Sepals nearly entire, longish. Styles cohering into an elongate pilose column. Fruit ovate or ovate-globose, orange-coloured. Peduncles mostly hispid with glanded hairs. Closely allied to *R. arvensis*, but differing in its being evergreen, in its leaves being coriaceous; and in its stipules being subfalcate, and more acute at the tip. (*Dec. Prod.*, ii. p. 597.) Native of France, Portugal, Italy, Greece, and the Balearic Islands. A climbing shrub, flowering from June to August. Introduced in 1629, and used for the same purposes as the Ayrshire rose; from which it differs in retaining its leaves the greater part of the winter, and in its less vigorous shoots.



Varieties. Several varieties are enumerated in De Candolle's *Prodromus*, and Don's *Miller*; but those only which we have seen, and consider worth mentioning, are,—

♣ ✕ *R. (a.) s. 2 Russelliana*, raised from seed by Mr. Sinclair of the New Cross Nursery; a very strong-growing variety, quite deciduous, with blush flowers.

♣ ✕ *R. (a.) s. 3 Clàrei* Bot. Reg., t. 1438. *The Rose Clare*.—An elegant variety, with deep red flowers. Both these varieties are as much entitled to be considered species, as many so designated in this enumeration.

♣ 2. *R. (a.) s. 4 Leschenaultiana* Red. et Thor. Ros., iii. p. 87. ic.—Germens ovate, and, with the peduncles, hispid with glanded hairs. Stem and petioles prickly, and having a violaceous bloom. Leaflets ovate-lanceolate. Stem 60 ft. to 70 ft. long. A native of Neelgherry Mountains, in Asia. This Seringe seems to consider as likely to be a distinct species.

♣ 71. *R. MULTIFLO'RA* Thunb. The many-flowered Rose.

Identification. Thunb. Fl. Jap., 214.; Dec. Prod., 2. p. 598.; Don's Mill., 2. p. 583.
Synonymes. *R. flava* Donn Hort. Cant., ed. 4. p. 121.; *R. florida* Poir. Suppl.; *R. diffusa* Rozb.
Engravings. Bot. Mag., t. 1059.; Bot. Reg., t. 425.; and our fig. 512.

Spec. Char., &c. Branches, peduncles, and calyxes tomentose. Shoots very long. Prickles slender, scattered. Leaflets 5—7, ovate-lanceolate

soft, finely wrinkled. Stipules pectinate. Flowers in corymbs, and, in many instances, very numerous. Buds ovate globose. Sepals short. Styles protruded, incompletely grown together into a long hairy column. (*Dec. Prod.*, ii. p. 598.) A climbing shrub, a native of Japan and China; introduced in 1822; and producing a profusion of clustered heads of single, semi-double, or double, white, pale red, or red flowers in June and July. It is one of the most ornamental of climbing roses; but, to succeed, even in the climate of London, it requires a wall. The flowers continue to expand one after another during nearly two months.



Varieties.

- 1 *R. m. 2 Grevillei Hort. R. Roxbúrgi Hort. ; R. platyphlla Red. Ros.*, p. 69. The Seven Sisters Rose. (*fig. 513.*)—A beautiful variety of this sort, with much larger and more double flowers, of a purplish colour; and no climbing rose better deserves cultivation against a wall. It is easily known from *R. multiflora* by the fringed edge of the stipules; while those of the common *R. multiflora* have much less fringe, and the leaves



are smaller, with the leaflets much less rugose. (See *Gard. Mag.*, vol. i. p. 468.) The form of the blossoms and corymbs is pretty nearly the same in both. A plant of this variety, on the gable end of Mr. Donald's house, in the Goldworth Nursery, in 1826, covered above 100 square feet, and had more than 100 corymbs of bloom. Some of the corymbs had more than 50 buds in a cluster; and the whole averaged about 30 in each corymb; so that the amount of flower buds was about 3000. The variety of colour produced by the buds at first opening was not less astonishing than their number. White, light blush, deeper blush, light red, darker red, scarlet, and purple flowers, all appeared in the same corymb; and the production of these seven colours at once is said to be the reason why this plant is called the seven sisters rose. This tree produced a shoot the same year which grew 18 ft. in length in two or three weeks. This variety, when in a deep free soil, and an airy situation, is of very vigorous

growth, and a free flowerer; but the shoots are of a bramble-like texture, and the plant, in consequence, is but of temporary duration. Mr. Donald's *R. Grevillei* died in three or four years.

‡ *R. m. 3 Russelliana* is a variety differing considerably, in flowers and foliage, from the species, but retaining the fringed foot-stalk; and is, hence, quite distinct from *R. sempervirens Russelliana*.

‡ *R. m. 4 Boursaulti Hort., Boursault's Rose*, is placed, in Don's *Miller*, under this species; though it differs more from the preceding variety than many species do from each other. It is comparatively a hard-wooded durable rose, and valuable for flowering early and freely. This is a very remarkable rose, from its petals having a reticulated appearance.

‡ ✱ 72. *R. BRUNO'NII* Lindl. *Brown's Rose*.

Identification. Lindl. Ros. Monog., p. 120. t. 14.; Dec. Prod., 2. p. 556.

Synonymy. *R. Brúwnii* Spreng. Syst., 2. p. 556.

Engraving. Lindl. Rosar. Monog., t. 14.

Spec. Char., &c. Shoots trailing. Prickles of the stem stout and arched. Leaflets 5—7, lanceolate, pilose on both surfaces; the under one glandulous, and of a different colour from the upper one. Stipules narrow, acute. Inflorescence corymbose. Peduncles and calyxes pilose, and a little hispid. Sepals entire, narrow, and longish. Styles cohering into a very long pilose column. Fruit ovate. A native of Nepal. (*Dec. Prod.*, ii. p. 598.) Leaves simply serrated. Flowers in terminal bunches, white or pale red. A rambling shrub, flowering in June and July. Introduced in 1822.

‡ ✱ 73. *R. MOSCHA'TA* Mill. *The Musk Rose*.

Identification. Mill. Dict., No. 13.; Red. et Thor. Ros., 1. p. 33. ic., and p. 99. ic.; Lindl. Rosar. Monog., p. 121.; Dec. Prod., 2. p. 598.; Don's Mill., 2. p. 583.

Synonymy. *R. opostemma Ehrh. Beitr.*, 2. p. 72.; *R. glandulifera Rozb.*

Engravings. Red. et Thor. Ros., 1. p. 33. ic., and p. 99. ic.; and our fig. 514.

Spec. Char., &c. Shoots ascending. Prickles upon the stem slender, recurved. Leaflets 5—7, lanceolate, acuminate, nearly glabrous, the two surfaces of different colours. Stipules very narrow, acute. Flowers, in many instances, very numerous; white, with the claws of the petals yellow; very fragrant. Lateral peduncles jointed, and, as well as the calyx, pilose, and almost hispid. Sepals almost pinnately cut, long. Fruit red, ? ovate. (*Dec.*)

Varieties.

‡ *R. m. 2 flore pleno* G. Don. *The double-flowered Musk Rose*.

‡ *R. m. 3 nivea* Lindl. (*Bot. Reg.*, t. 861.; and our fig. 515.) *R. nivea Dupont*, not of *Dec.*; *R. m. ? var. rosea Ser.* in *Dec. Prod.*—Leaflets 3—5, ovate-cordate, subacuminate, large. Flowers disposed in an imperfectly corymbose manner. Peduncle and calyx a little hispid. Petals white, or pale rose-coloured, large, obovate. This is a very beautiful variety: the petals are white, with a most delicate, yet rich, tinge of blush.

Description, &c. The branches of the musk rose are generally too weak to support, without props, its large bunches of flowers, which



514



515

are produced in an umbel-like manner at their extremities. The musky odour is very perceptible, even at some distance from the plant, particularly in the evening, —

“ When each inconstant breeze that blows
Steals essence from the musky rose.”

It is said to be a native of Barbary; but this has been doubted. It is, however, found wild in Tunis, and is cultivated there for the sake of an essential oil, which is obtained from the petals by distillation. It has also been found wild in Spain. The first record of the musk rose having been cultivated in England is in *Hakluyt*, in 1582, who states that the musk rose was brought to England from Italy. It was in common cultivation in the time of Gerard, and was formerly much valued for its musky fragrance, when that scent was the fashionable perfume. The Persian attar of roses is said to be obtained from this species. The musk rose does best trained against a wall, on account of the length and weakness of its branches; and Miller adds that it should always be pruned in spring, as in winter it will not bear the knife. It requires very little pruning, as the flowers are produced at the extremities of the shoots, which are often 10 ft. or 12 ft. in length. It flowers freely, and is well worthy of cultivation.

✻ 74. *R. RUBIFOLIA* R. Br. The Bramble-leaved Rose.

Identification. R. Brown in Ait. Hort. Kew., ed. 2. vol. 3. p. 260.; Lindl. Rosar. Monog., p. 123. ic.; Dec. Prod., 2. p. 598.

Engravings. Lindl. Rosar. Monog., t. 15.; and our fig. 516.

Spec. Char., &c. Stems ascending. Branches glabrous. Prickles scattered, falcate. Leaves pubescent beneath. Leaflets 3, ovate-lanceolate, serrate. Stipules narrow, entire. Flowers very small, of a rosy colour, mostly solitary. Buds ovate. Sepals ovate, short, simple. Peduncles and calyxes a little hispid. Styles cohering into a tomentose club-shaped column, as long as the stamens. Fruit pea-shaped. A native of North America. (*Dec.*) A shrub, from 3 ft. to 4 ft. in height, and flowering in August and September. Introduced in 1830.



Variety.

✻ *R. r. fenestrata* Lindl. Rosar. Monog., 125. t. 15.; *R. fenestrata* Don's Cat. Hort. Cantab., ed. 8. p. 170., and *Tratt. Ros.*, 2. p. 187. — Flowers solitary. Leaflets small. Calyxes and peduncles short.

§ x. *Banksianæ* Lindl.

Derivation. So called in consequence of all the species contained in this section agreeing in character with *R. Banksiæ*, a rose named in honour of Lady Banks.

Identification. Lindl. Ros., p. 123.; Don's Mill., 2. p. 584.

Sect. Char., &c. Stipules nearly free, subulate, or very narrow, usually deciduous. Leaflets usually ternate, shining. Stems climbing. The species of this section are remarkable for their long, graceful, and often climbing, shoots, drooping flowers, and trifoliolate shining leaves. They are particularly distinguished by their deciduous, subulate, or very narrow stipules. Their fruit is very variable. (*Don's Mill.*, ii. p. 584.)

✻ 75. *R. SINICA* Ait. The trifoliolate-leaved China Rose.

Identification. Ait. Hort. Kew., ed. 2. vol. 3. p. 261.; Lindl. Ros., p. 126. t. 16.; Don's Mill., 2. p. 584.

Synonymes. *R. trifoliata* Bosc Dict. ex Poir.; *R. ternata* Poir. Suppl., 6. p. 284.; *R. cherokeensis* Donn Hort. Cant., ed. 8. p. 170.; *R. nivea* Dec. Hort. Monsp., 137., Red. Ros., 2. p. 81. with a fig.

Engravings. Lindl. Ros., t. 16.; Hook. Bot. Mag., 2847.; Red. Ros., 2. p. 81.; and our fig. 517.

Spec. Char., &c. Stipules setaceous, deciduous. Cauline prickles equal, falcate. Petioles and ribs of leaves prickly. Peduncles and fruit beset with straight bristles. Sepals entire, permanent. Flowers white,



solitary. Fruit elliptic, orange-red. Disk conical. (*Don's Mill.*, ii. p. 584.) A rambling shrub, a native of China, introduced in 1759, and flowering in May and June.

‡ 76. *R. BA`NKSIÆ* R. Br. *Lady Banks's Rose.*

Identification. R. Br. in Ait. Hort. Kew., ed. 2. vol. 3. p. 256; Lindl. Rosar. Monog., p. 131; Dec. Prod., 2. p. 601.

Synonymes. *R. Banksiana* Abel Chin., 160.; *R. inermis* Roxb. ?

Engravings. Bot. Mag., t. 1954.; Red. et Thor. Ros., 2. p. 43. ic.; and our fig. 518.

Spec. Char., &c. Without prickles, glabrous, smooth. Leaflets 3—5, lanceolate, sparingly serrated, approximate. Stipules bristle-like, scarcely attached to the petiole, rather glossy, deciduous. Flowers in umbel-like corymbs, numerous, very double, sweet-scented, nodding. Tube of the calyx a little dilated at the tip. Fruit globose, black. A native of China. (*Dec. Prod.*, ii. p. 601.) A climbing shrub, flowering in June and July. Introduced in 1807.

Variety.

‡ *R. B. 2 lutea* Lindl. (*Bot. Reg.*, t. 1105., and our fig. 519.) has the flowers of a pale buff colour, and is a very beautiful variety.



Description, &c. This is an exceedingly beautiful and very remarkable kind of rose; the flowers being small, round, and very double, on long peduncles, and resembling in form the flowers of the double French cherry, or that of a small ranunculus, more than those of the generality of roses. The flowers of *R. Banksiæ* álba are remarkably fragrant; the scent strongly resembling that of violets.

‡ 77. *R. MICROCA`RPA* Lindl. *The small-fruited Rose.*

Identification. Lindl. Rosar. Monog., 130. t. 18.; Dec. Prod., 2. p. 601.

Synonymes. *R. cymosa* Tratt. Ros., 1. p. 87.

Engravings. Lindl. Rosar. Monog., t. 18.; and our fig. 520.

Spec. Char., &c. Prickles scattered, recurved. Leaflets 3—5, lanceolate, shining, the two surfaces different in colour. Petioles pilose. Stipules bristle-shaped or awl-shaped, scarcely attached to the petiole, deciduous. Flowers disposed in dichotomous corymbs. Peduncles and calyxes glabrous. Styles scarcely protruded higher than the plane of the spreading of the flower. Fruit globose, pea-shaped, scarlet, shining. Allied to *R. Banksiæ*. A native of China, in the province of Canton. (*Dec. Prod.*, ii. p. 601.) Flowers very numerous, small, white. A rambling shrub, flowering from May to September.



App. i. *Hardy Species of the Genus Rosa, not yet introduced.*§ i. *Feroces.*

R. rugosa Thun. (*Lindl. Ros.*, p. 5. t. 19.) is a native of Nepal, growing to the height of 3 ft. or 4 ft.

§ ii. *Bracteata.*

R. Lyellii Lindl. *Ros.*, p. 12. t. 1., is a native of Nepal; with densely villous leaves and shoots; and growing to the height of 3 ft. or 4 ft.

§ iii. *Cinnamomea.*

R. laxa Retz. (*Don's Mill.*, 2. p. 565.) is a native of Siberia with red flowers, and oblong glabrous fruit; growing to the height of 3 ft. or 4 ft.

R. kosingiana Bess. (*Don's Mill.*, 2. p. 565.) is a native of Podolia, at Tyra; growing to the height of 6 ft.

R. soongoricæ Buoge (*Don's Mill.*, 2. p. 566.) is a native of the Soongarian Desert; growing to the height of 6 ft.

R. aristata Lapey. (*Fl. Pyr.*, t. 105.) is a native of the Pyrenees; and, perhaps, a monstrosity of *R. cinnamomea*; growing to the height of 6 ft.

R. macrophylla Lindl. *Ros.*, p. 55. t. 6., and our fig. 521., is a native of Gossainthan; with red flowers, and villous fruit; growing to the height of 6 ft. Judging from the figure of this rose in Lindley's *Rosarum Monographia*, its bractæ are very large and long, nearly entire, naked, quite thin, and tinged with red; and the sepals are also very long, nearly triangular in shape, and simple, but dilated and toothed at their extremities. Dr. Lindley observes of this species; that it differs from *R. alpina* in the shape of its stipules, and in its great bractæ; that its leaves are the largest he has ever seen; that it cannot be confounded with any thing else; and that it may be considered the link between *Cinnamomea* and *Pimpinellifolia*.

§ iv. *Pimpinellifolia.*

R. Candolleana Don's *Mill.*, 2. p. 567.; *R. rubella* Lindl. *Ros.*, p. 40.; *R. pendula* Roth; *R. alpina* Pall.; *R. poliphylla* Willd.; *R. alpina* var. *rubella* Ser. in *Dec. Prod.*; *R. Candolleana* *pendula* Red.; *R. Candolleana* *elegans* Thor.; is a native of Germany and Siberia; with solitary deep red flowers, and scarlet fruit; and there is a variety with blackish brown fruit.

R. flava Wicks is a native of Siberia; with yellow flowers; growing to the height of 6 ft.

R. viminea Lindl. *Ros.*, p. 49.; *R. hirsuta* Lindl. ex Spreng. *Syst.*, 2. p. 549.; is a native of Siberia; with very large flowers; growing to the height of 1 ft.

R. Webbiana Wall. (*Royle Illust.*, p. 208. t. 42. f. 2.) is a native of Nepal; approaching *R. spinosissima*, but differs in the want of setæ, and in a tendency to convert the upper leaves into true bractæ; also, in the dark colour of its stem, which contrasts strongly with its white prickles

R. reclinata Red. *Ros.*, 3. p. 79., is supposed to be a hybrid between *R. alpina* and *R. indica*; with lurid purple flowers; of which there is a double-flowered variety.

§ v. *Centifolia.*

R. pygmaea Bieb. is a native of Tauria; perhaps a variety of *R. gallica*.

R. adenophylla Willd. is nearly allied to *R. turbinata* and *R. pulchella*.

R. verrucata Waitz. (*Don's Mill.*, 2. p. 573.) grows to the height of 6 ft.; and is, perhaps, a variety of *R. damascena*, as is *R. lepida*.

§ vi. *Villosa.*

R. hispida Poir. (*Don's Mill.*, 2. p. 577.), *R. villosa* var. *pomifera* Desv., is a native of Europe; growing to the height of 6 ft.

R. terebinthacea Bess. is a native of Podolia and Tyra.

§ vii. *Rubiginosa.*

R. montana Vill. is a native of the south of Europe; with small white flowers; growing to the height of 3 ft.

R. uncinella Bess. (*Don's Mill.*, 2. p. 578.) is a native of Volhynia and Tauria; growing to the height of 6 ft.

R. caryophyllacea Bess., *R. rubiginosa* var. *caryophyllacea* Ser. in *Dec. Prod.*, is a native of Podolia.

R. inodora Fries is a native of the north of Holland; and said to be the same as *R. Borreri*.

R. cuspidata Bieb. is a native of Tauria; with white flowers, and dark purple fruit.

R. agræstis Swartz is a native of Sweden.

R. pseudo-rubiginosa Lejeune is a native of France; with pinnate sepals, and red petals.

R. Wolfgaungiana Bess. and *R. dimorpha* Bess. are natives of Podolia.

R. Willdenowii Spreng., *R. microphylla* Willd., *R. arenaria* Bieb., is a native of Siberia.

R. floribunda Bess. is a native of Podolia.

§ viii. *Canina.*

R. ciliato-pétala Bess. is a native of Lithuania; allied to *R. villosa* and *R. caucásica*.

R. Gmelini Bunge (*Don's Mill.*, 2. p. 580., not p. 566.), *R. canina* *Seyres*, is a native of Siberia; growing to the height of 4 ft.

R. collina Jacq., *R. billica* Roth, *R. Jundzilli* Bess., *R. turbinella* Swartz, *R. nuda* Swartz, *R. corifolia* Fries, and *R. saratila* Stev. are described in *Don's Mill.*, 2. p. 581., as belonging to this section.

R. sericea Lindl. *Ros.*, p. 105. t. 12., *Royle Illust.*, t. 42. fig. 1., and our fig. 522., is a native of Gossainthan; with pale red flowers, and naked peduncles and fruit; growing to the height of 6 ft.

R. atropurpurea Brot. is common in the gardens of Lisbon; with semidouble flowers, about the size of those of *R. moschata*; and is, perhaps, the same as *R. semperflorens*.



§ ix. *Sýstyleæ.*

R. moschata nepalensis (fig. 523.) is a musk rose; a native of Nepal; perhaps the same as *R. Brundii* var. *nepalensis* *Bot. Reg.*, t. 829., and *Don's Mill.*, 2. p. 533.
R. evratina *Bosc.* is a native of Carolina; with large pale red flowers.

§ x. *Banksiànæ.*

R. hýstris *Lind. Ros.*, p. 129. t. 17., and our fig. 524., is a native of China and Japan; a rambling shrub, with flagelliform branches, large solitary flowers, and large oblong purple fruit.

App. ii. *Half-hardy Species of the Genus Ròsa, not yet introduced.*

§ iv. *Pimpinellifòliæ.*

R. nankinensis *Lour. Coch.*, 324., (*Don's Mill.*, 2. p. 569.) is a native of China; with small pale red double flowers; growing to the height of 1 ft.

§ viii. *Canìcæ.*

R. pseudo-indica *Lindl. Ros.*, p. 132., (*Don's Mill.*, 2. p. 582.) is a native of China; with the habit of *R. indica*, but with double deep yellow flowers.

§ x. *Banksiànæ.*

R. recurva *Roxb. (Lindl. Ros., p. 127. Don's Mill., 2. p. 584.)* is a climber; a native of Nepal.
R. triphýlla *Roxb.* is a climbing shrub; a native of China; perhaps the same as *R. microcarpa*, or a var. of *R. sinica*.
R. fragariaeflora *Ser. in Dec. Prod.*, 2. p. 601., is a climbing shrub; a native of China; with flowers the size and colour of those of *Fragaria vesca*.
R. amygdalifolia *Ser. in Dec. Prod.*, 2. p. 601., (*Don's Mill.*, 2. p. 585.) is a climbing shrub; a native of China; with large ovate fruit.

App. iii. *Uncertain Species of Ròsa.*

Above 100 species, "not sufficiently known," are described in *Don's Miller*; and, indeed, this phrase might be well applied to half those which are described in books, as known; the descriptions being frequently, and unavoidably, taken from dried specimens. In *Royle's Illustrations*, &c., there are also several species mentioned as natives of Nepal, no descriptions of which have yet appeared.

App. iv. *A practical Arrangement of Roses in actual Cultivation in the Nursery of Messrs. Rivers and Son, Sawbridgeworth, Hertfordshire.*

The preceding arrangement is chiefly calculated for the botanist; for, if any person were desirous of ordering a collection of roses according to the names given in it, he would find it quite impossible to accomplish his object either in Britain or on the Continent. In short, it may be considered as a botanical fiction, only calculated to communicate some general ideas as to the wild roses of Europe, and as to the origin of the different varieties in

cultivation. If a *Rosarium Monographia*, like that of Dr. Lindley, and a descriptive classification like that of the *Nouveau Du Hamel*, were to be made every seven years, though they might remain nearly the same with regard to the leading divisions, or types, of the varieties, they must necessarily be much changed in the details; owing to numbers of the varieties being almost annually lost, going out of repute, or actually changing their appearance from time and local circumstances; and from others being originated from seed, or becoming, from accidental circumstances, favourites with the public. Hence it is, that, whoever would wish to procure the best collection or selection of roses which are in existence at the time being, must resort to the latest and best *Catalogue of Roses* then actually in cultivation. Such a catalogue for Britain, in the year 1836, is that of Messrs. Rivers and Son of the Sawbridge-worth Nursery, Hertfordshire, from which we make the following extracts; recommending the catalogue itself (which, being a single sheet, can be sent by post to any part of the world) to those who wish the names of the sorts, and other particulars respecting them, in detail. The prices of the common kinds of roses in Messrs. Rivers's catalogue vary from 1s. to 3s. 6d. for dwarfs, and from 3s. 6d. to 5s. for standards; some varieties, which are rare, being from 7s. 6d. to 10s. 6d. each. The best plan for getting a good selection, in our opinion, is, to order a given number of sorts from each section, not to exceed a limited price per plant, or for the total number. When particular sorts are ordered by name, it may frequently happen that the plants of that sort are weak, or, from scarcity, dear; whereas, when a discretionary power is left with the nurseryman, if he is a man of character, he can always do more for his customer, than the customer can do for himself.

Moss Roses, 24 sorts. Messrs. Rivers's "collection of moss roses comprises many that are very beautiful and distinct; and some, perhaps, only fit for those amateurs who think that all *moss* roses are beautiful: one step further towards a dark crimson moss is made in the rouge du Luxembourg, which is very beautiful, and a most luxuriant grower. Most of the varieties prefer a cool soil, though the mossy de Meaux is, perhaps, an exception, as it seems to flourish better in light dry soils. The white moss, unless budded on the dog rose (*Rosa canina*), will not, in general, grow well: its sickly appearance, in some situations, may be often traced to its being worked on some improper stock: if on its own roots, in rich soils, it will often change to pale blush. All are well adapted for standards: but, to have them in perfection, in warm dry situations, in March, put round each stem, *on the surface of the soil*, the fourth of a barrowful of manure; on this place flints or moss, to take off its unsightly appearance, and make a little ornamental mount. This treatment will keep the soil cool, and make them bloom in a very superior manner, even in situations previously thought to be most ungenial to their culture. The manure should be spread on the surface in November, and lightly forked in."

Provence, or Cabbage, Roses, 25 sorts. "The Provence Rose is the *R. provincialis* of Miller's *Gardener's Dictionary*, the *R. centifolia* of modern botanists, and the Rose à Centfeuilles of the French. This is a most distinct and elegant family, and excessively fragrant. The footstalks of the flowers are slender, and the flowers large; so that, when in bloom, the plant has a peculiarly pendulous and graceful appearance. The moss rose is evidently a variety of this, as I have raised seedlings from the single moss which have lost all their mossy appearance, and have returned to the habit of the Provence rose."

Perpetual, or Autumnal, Roses, 50 sorts. "The perpetual, or autumn-flowering, roses are, perhaps, the most desirable of all the sections of the genus: they are highly fragrant, and, if possible, more so in September, October, and November, than in June. As every shoot, in most of the varieties, produces bloom, the soil cannot be too rich; for, with these, luxuriant growth will be sure to give abundance of flowers. A good practice would be, to cut off all the bloom-buds in June, and to shorten the shoots to about half their length;

and then to water them with manured water in July and August, which will make them shoot and bloom most luxuriantly all the autumn."

Hybrid China Roses, 89 sorts. These roses are all hybrids between *R. indica* and *R. gallica*: "they are all very beautiful, and have that pleasing, glossy, sub-evergreen foliage peculiar to the China rose, but make a great deviation from that section, in not being perpetual bloomers; in this division are some of the most beautiful roses known; and, among them, George the Fourth, raised from seed by T. Rivers, jun., may rank among the best. These are also all very robust, and will grow and bloom well in the most unfavourable rose soils: their peculiar habit and vivid colours render them particularly well adapted for standards."

Varieties of Rosa alba, 25 sorts. The roses in this section have their "branches green, and thinly set with thorns; leaves of a glaucous green; and flowers of the most delicate hues imaginable, from the purest white to a peculiarly vivid rose-colour; but so delicate in their gradations, that no terms can describe them accurately."

Damask Roses, 19 sorts. "In this distinct section are some of the most delicately beautiful roses in existence; in habit, they are much inclined to spread, their foliage is mostly pubescent, and in some varieties large, and very profuse. The original damask rose may be found in many old gardens, with ragged pale rose-coloured flowers, very fragrant, branches very thorny, and rudely straggling in their growth: it forms a good stock for many tender roses, not throwing up suckers."

Rosa gallica, or French Roses, 99 sorts. "The roses in this division have all stiff erect shoots, with dense foliage; the flowers are on short erect flower stalks, having rather a formal appearance; but, to compensate for this, they are trim and neat, and are well adapted for small gardens. Many of them differ in the pretty compact shape of their flowers from all other roses, and in brilliancy and diversity of colour cannot be surpassed. The spotted, striped, and marbled roses in this division are very novel and beautiful, and will be appreciated by those who admire variegated roses. In France, this is called the Provins rose, whence the confusion in most rose catalogues with the Provence rose; the Agatha rose is of this family, having curled leaves and pale flowers. Gallic roses are too lumpish and stiff in their growth for standards."

Select Roses of uncertain Origin, 25 sorts. "These are hybrid roses of unknown origin. The new white roses are, seemingly, varieties of that fine rose, the white globe hip, and are indeed beautiful."

Climbing Roses, 53 sorts. There are four sections of climbing roses, Ayrshire, Sempervirens, Multiflora, and Boursault. The Ayrshire climbing roses are all varieties of *R. arvensis*; and most of them have been raised from seed by Mr. D. Martin of Rose Angle, near Dundee. There are 14 varieties, all vigorous growers, making shoots from 12 ft. to 20 ft. every season. The most remarkable of these is the *R. a. ruga*, which is a hybrid between *R. arvensis* and *R. indica odorata*, and has the climbing habit and vigorous growth of one parent, with the large fragrant flowers of the other. There are 20 varieties of *R. sempervirens*, all decidedly climbers, and nearly evergreen; making long, slender, graceful shoots, though not with an equal degree of vigour to those produced by the varieties of *R. arvensis*. They are all quite hardy, and are remarkable for the neatness and elegance of their flowers. The triomphe de Bollwyller is a hybrid between *R. sempervirens* and *R. indica odorata*, and has large fragrant flowers. On this division Mr. Rivers observes: "It will be something of a novelty to apply climbing roses as underwood, but I know of no plant so eligible for elegant undergrowth, in a wilderness near pleasure-grounds, as the varieties of *R. sempervirens*: they grow in every description of soil with great luxuriance; under the shade of trees they are nearly evergreen; and, with their beautifully shaped and delicately coloured flowers, are calculated to form the prettiest mass of undergrowth it is possible to conceive. They grow with

increased vigour when their shoots are prostrate; and, if a large space is required to be covered with them, they may be planted thin, and the ends of the most vigorous shoots laid in the ground: in a few years, by these means, acres of ground may be covered with them. On standards with short stems they make very ornamental plants for lawns: if they grow luxuriantly, the ends of the shoots will descend, and, if not shortened, will produce, the following season, corymbs of flowers at every bud, forming a dome-shaped mass having a fine effect." (*Cat.*, p. 12.) They have, also, a fine effect trained *en pyramide* against a slight wooden or wire frame. The varieties of *R. multiflora*, 12 in number, are all distinguished by the fringed stipules to their leaves, already described p. 774. The original species is tender, requiring a south wall; but several of the varieties which have been produced by hybridisation are quite hardy. The Boursault roses, Mr. Rivers observes, are all subvarieties of *R. Boursaultii*, which he calls a variety of *R. alpina*, and the only one "thought worthy of cultivation." These roses may be easily distinguished by their long, purplish-red, and nearly thornless shoots, which are often 12 ft. or 15 ft. long in one season. There are 9 varieties. Besides the above great divisions, there are several climbing roses, which could not be classed under them. The most remarkable of these are, *R. Banksie* white and yellow, *R. sinica*, *R. Clarei*, *R. indica major*, and the climbing Provence. For the above remarks we are indebted to Mr. Rivers, jun.

Rosa indica, or China Roses, 70 sorts. "From six to eight months in the year, the roses in this division form bright ornaments to our gardens: many of the robust varieties make beautiful standards. They are all quite hardy, and some of the varieties of the most brilliant colours: others of the purest white. Some of the larger and more double flowers have a peculiar delicate blush, unlike any other rose."

Rosa indica odorata, or Tea-scented China Roses, 51 sorts. "These are China roses having a strong odour of tea: they are seminal varieties of the old blush tea-scented rose (*R. indica odorata*), and of *R. ochroleuca*, or the yellow China rose. They are more delicate than those of the preceding section as to cold in winter, and also in their flowers, as they seem to require the warm dewy nights of August and September to bring them to perfection. In hot weather, in June and July, they are very fleeting, as their flowers are large and of a delicate texture, soon fading in sunny weather. They require careful cultivation, and must have a raised border against a south, south-east, or west wall. This border should be a compost of rotten manure or leaves, light loam, and sand, equal parts, and raised about 18 in. above the surface. When grown as low standards, they are surpassingly beautiful: but they should be taken up in November, and their roots laid in mould in a shed, as our sharp winters would injure them, so as to prevent their blooming in perfection if left exposed."

Miniature, or dwarf, China Roses, from Rosa Lawrenceana, 16 sorts. "Some of these are known as fairy roses; and they indeed deserve the appellation: they are exceedingly well adapted for planting on rockwork; their minute and vivid flowers having an excellent effect in such situations. In the cool autumnal months, they bloom in great perfection."

Noisette Roses, 66 sorts. "These have resulted from a happy intermixture of the China rose with the old musk rose, and from it we have the annexed numerous varieties, partaking in a pleasing manner of both parents: in many, the clustered habit and peculiar fragrance of the musk rose prevails; in others, the perfume and magnificent flowers of the tea-scented roses are apparent: together forming a most elegant section. Some of the clusters of flowers are so large as to have 60 to 80 in one corymb. The constant succession of flowers, till the chills of November prevent the opening of the buds, makes them highly interesting: they are all very hardy, and, as standards, seem to show their varied characters with better effect than as dwarfs: they are also well adapted for rose pillars, as their shoots are long and flexible."

L'Ile de Bourbon Roses, 38 sorts. "This is a most beautiful section, scarcely known in this country. The original, or common, l'Ile de Bourbon rose was sent to France, in 1822, from the Mauritius, by the brother of M. Noisette, a nurseryman at Paris. It is semidouble, and seems to have the characters of a distinct species. It bears seeds in great profusion; but, though thousands of seedlings have been raised, the produce of good varieties has been but in small proportion to the bad. Like the China roses, of which they have been considered a division, they are perpetual bloomers; but they have a luxuriance and gracefulness quite their own. The perfect and elegant form of their flowers, the extremely delicate tints in some, and vivid rose-colour in others, will soon establish them in the favour of the rose amateur: as standards, they grow most luxuriantly, are quite hardy, and bloom in greater perfection late in autumn than any other perpetual rose."

Musk Roses, 10 sorts. "These are interesting from their powerful fragrance and autumnal flowering. The old white is one of the oldest inhabitants of the English gardens."

Macartney Roses and Rosa microphylla, 10 sorts. "Most of the annexed varieties of this interesting section are novelties. From their evergreen, shining, neat foliage, and elegant growth, they are quite worthy a place in the garden of the rose amateur. In cold soils, they will require a warm situation and raised border: but they are much hardier worked on the dog rose; and, as half standards, are beautiful; requiring the same treatment as standard tea-scented roses."

Sweet Briar, 17 sorts.

Scotch Roses, 27 sorts. "These are all derived from the *R. spinosissima*, or wild rose of Scotland; and they form so gay an assemblage among May flowers, that a clump or border ought to be devoted to them in every flower-garden. The shape of the flower is peculiar and similar, being nearly globular."

Miscellaneous Roses, sold at 2*l.* 10*s.* per 100, in pairs; 101 sorts.

Mr. Rivers has also given a synopsis of variegated roses, consisting of 42 sorts. He adds that the sections "of roses are now so well defined, that each ought to have its department: a clump of hybrids, for their gorgeous colours in June and July; of perpetuals, for their fragrance in the autumnal months; of Noisettes, for their elegance and abundance of flowers; of Scotch roses, for their precocity and humble growth; and of climbing roses, for pillars, which should be planted in a very rich soil, as they will then put forth strong central branches, of 8 ft. or 10 ft. in length, which, when fastened to the stakes, will furnish a plentiful supply of lateral blooming shoots for many seasons. Climbing roses will cover a sloping bank, as their flexible branches can be pegged to the ground in any direction, and will form a beautiful carpet of foliage and flowers; the dark crimson and white varieties blending with peculiar elegance. The perpetual, Ile de Bourbon, and Noisette roses, from their vigorous habits and tendency to flower, may be made fine objects for ornamenting halls, &c., during the autumnal months; for this purpose, they should be put into large pots, and well furnished with surface manure, and plenty of water in summer: their blossoms ought, also, to be cut off just before expansion. The crimson perpetual rose may also be forced with fine effect. 'The pots (twenty-fours of the London potteries, 8 in. deep, 7½ in. over) must be plunged in the natural soil to the rims, a deep frame placed over them, and the heat kept up with linings of hot dung, giving air as required. This fine autumnal rose, when forced, and blooming in March or April, is most beautiful: its too short flower stalks are lengthened by this mode of culture; its flowers are erect (unlike many other forced roses), and lose none of their colour or fragrance by the excitement they have undergone. For all these purposes," Mr. Rivers adds, "roses should be 'worked' on the dog rose stock, as its vigorous and easily excitable habit are quite necessary to bring the plants into a fit condition for forcing."

Geography. The rose, in some of its forms, is found in a wild state in

every country in the northern hemisphere, both in the Old and New World. It extends from Sweden to the north of Africa, and from Kamtschatka to Bengal and China. In North America, it ranges between the Hudson and the mountains of Mexico; but it is not found in South America, or in Australia. According to Dr. Lindley (*Ros. Monog.*, p. 29.), the species are all included between 70° and 20° north latitude, except *R. Montezumæ*, from Mexico, which is found in 19° north latitude, at an elevation of more than 9300 ft. above the level of the sea. 18 species, or sorts, are natives of Russia and the adjacent countries; 5 are common both to Europe and Asia; 15 have been found in China; and 6 in the north of India. Europe has 25 species, of which five sixths are found between the limits of 40° and 50° north latitude. "To the south of this range, they decrease in number much more rapidly than to the north. Britain, which lies just without its northern limits, has 10 species, Denmark 7, and Holland 13; whilst in Spain, Portugal, and the Levant, which bear nearly the same relation to it on the south, only 4 species have been observed. Many are peculiar to certain districts, as *R. revêrsa*, *R. myriacantha*, *R. hibêrnica*, and *R. involûta*; others to countries, as the *R. majalis* of Sweden and Denmark, and the *R. glutinosa* of the Levant. Some few are only confined by the extreme limits of the genus: thus *R. spinosissima* is alike common to the dreary wilds of Iceland, and to the sultry shores of the Mediterranean; and *R. canina* grows from the confines of Angermania in Sweden, to the most southern regions of Europe, thence extending into Egypt.

"In the north of Africa are 2 species peculiar to that country; and 2 others common to it and Europe. 14 species have been found in North America; none of which, except *R. Montezumæ* and *R. stricta*, have much general resemblance to European roses. It is not unworthy of notice, that the *R. levigata* of the woods of Georgia is so similar to the *R. sinica* of China, as not to be immediately distinguishable from it." (*Lindl. Monog.*, introd. p. 30.)

The rose, in a wild state, is more frequently found on soils that are dry and free, than on such as are moist and tenacious; and, with the exception of the climbing kinds, it is more common among bushes of its own height, than in woods; thus indicating to the cultivator that it ought neither to be altogether exposed to the sun, nor entirely excluded from its rays. In the north of Europe, wild roses have always single flowers; but in the south of Europe, particularly in the warmest parts of Italy, Greece, and Spain, it is not uncommon to find roses with double flowers growing spontaneously in the fields, woods, and meadows.

History. The rose is mentioned by the earliest writers of antiquity as an object of culture. Herodotus speaks of the double rose, and Solomon of the rose of Sharon, and of the plantations of roses at Jericho. Theophrastus tells us that the hundred-leaved rose grew, in his time, on Mount Pangæus; and it appears that the Isle of Rhodes (Isle of Roses) received its name from the culture of roses carried on there. Pliny mentions several sorts of roses which were cultivated by the Romans; and that those of Præneste, Campania, Miletus, and Cyrene were the most celebrated.

The Præneste roses are thought by Thory, De Leuze, and other French authors, to belong to the species *Rosa damascena*, No. 35. fig. 490. p. 759.; those of Campania to *Rosa centifolia*, No. 36. fig. 491. p. 760.; and those of Miletus to *Rosa gallica*, No. 37. fig. 493. p. 760. Pliny says nothing in the way of description of the roses of Præneste; but they are, no doubt, those referred to by Virgil, as "biferique rosaria Pæsti," the twice-bearing roses of Pæstum, a village of Latium, about twenty miles from Rome. Of the roses of Campania, Pliny says that they have a hundred leaves, and that they are found in Campania in Italy, and about Philippi in Greece. They do not grow naturally, he adds, in the neighbourhood of Philippi, but they were brought there from Mount Pangæus, which is not far thence,

and which produces roses that have a great number of leaves. The rose of Miletus is recognised as *R. gallica*, the rose de Provins of the French authors, from the character given it by Pliny, of having the flowers of a very deep red, with not more than a dozen petals.

The ancients do not appear to have known either the yellow rose or the white rose; at least, neither of these are mentioned by Theophrastus or Pliny, unless we except those which the latter calls the roses of Alabanda, in Caria, which had the petals whitish.

Roses were more highly prized by the Romans than any other flowers; and they had even attained to the luxury of forcing them. Under the reign of Domitian, the Egyptians thought of offering to that emperor's court, as a magnificent present, roses in the middle of winter; but this the Romans smiled at, so abundant were roses in Rome at that season. In every street, says Martial, the odour of spring is breathed, and garlands of flowers, freshly gathered, are displayed. "Send us corn, Egyptians! and we will send *you* roses." (*Mart.*, vi. 80.) The Roman physicians determined the kinds of plants proper to be admitted into the floral crowns put on the heads of the great men whom it was designed to honour at festivals; and these were, the parsley, the ivy, the myrtle, and the rose, which were all considered as antidotes to the evil effects of the vapours of wine. Rose trees were employed, both by the Greeks and the Romans, to decorate tombs; and instances are given of rose gardens being bequeathed by their proprietors, for the purpose of furnishing flowers to cover their graves. An old inscription found at Ravenna, and another at Milan, prove this custom, which is also alluded to by Propertius and other poets. The bitterest curses were imprecated against those who dared to violate these sacred plantations. Sometimes the dying man ordered that his heirs should meet every year, on the anniversary of his death, to dine together near his tomb, and to crown it with roses gathered from his sepulchral plantation. The first Roman Christians disapproved of the employment of flowers, either at feasts or on tombs, because they were so used by the pagans. Tertullian wrote a book against the employment of garlands; and Clement of Alexandria did not think it right that kings should be crowned with roses, as our Saviour was crowned with thorns.

Of the history of the rose, from the time of the Romans till the time of Tournefort, when botany became a science, very little is known; but there can be no doubt that in the dark ages they were held in esteem by all who could procure them. When Saladin took Jerusalem, in 1128, he would not enter the mosque of the Temple, then converted into a church by the Christians, till the walls had been thoroughly washed and purified with rose-water. It is added, that 500 camels were employed to convey this water, and that even these were hardly found sufficient; a tale, as Thory observes, worthy of the East. Voltaire says, that, after the taking of Constantinople by Mahomet II., in 1453, the church of St. Sophia was washed with rose-water in a similar manner, before it was converted into a mosque. We read in the *History of the Mogul Empire*, by Father Catron, that the celebrated Princess Nourmahal filled an entire canal with rose-water, upon which she was in the habit of sailing along with the Great Mogul. The heat of the sun disengaged the essential oil from the rose-water: this was observed floating upon the surface of the water; and thus was made the discovery of the essence, otto, or attar, of roses. Formerly it was the custom to carry large vessels filled with rose-water to baptisms. Bayle relates, upon this subject, that at the birth of Ronsard, his nurse, in the way to church, let him fall upon a heap of flowers; and that at this instant the woman who held the vessel of rose-water poured it upon the infant. All this, says Bayle, has been since regarded as a happy omen of the great esteem in which his poems would one day be held! Roses were often, in the days of chivalry, worn by the cavaliers at tournaments, as an emblem of their devotion to love and beauty.

In 1503, Ludovico Verthema, who had travelled in the East, observes that

Taessa was particularly celebrated for roses, and that he saw a great quantity of these flowers at Calicut. Sir John Chardin, in 1686, found the gardens of the Persians without "parterres, labyrinths, and other ornaments of European gardens, but filled with lilies, peach trees, and roses; and all modern travellers bear testimony to the esteem in which the flower is held in the East. Sir William Ouseley tells us, in his *Travels in Persia in 1819*, that when he entered the flower-garden belonging to the governor of the castle near Fassa, he was overwhelmed with roses; and Jackson, in his *Journey, &c.*, says that the roses of the Sinan Nile, or Garden of the Nile, are unequalled; and mattresses are made of their leaves for men of rank to recline on. Buckingham speaks of the rose plantations of Damascus, as occupying an area of many acres about three miles from that city; but we have said so much on the gardens of Syria and Persia, and of the roses forming a conspicuous article of culture in them, in the historical part of our *Encyclopædia of Gardening*, that we shall not dwell on the subject here, farther than to give the following quotation from Sir Robert Ker Porter's *Travels*:—

"On my first entering this bower of fairy land," says this gentleman, speaking of the garden of one of the royal palaces of Persia, "I was struck with the appearance of two rose trees full 14 ft. high, laden with thousands of flowers, in every degree of expansion, and of a bloom and delicacy of scent that imbued the whole atmosphere with exquisite perfume. Indeed, I believe that in no country in the world does the rose grow in such perfection as in Persia; in no country is it so cultivated and prized by the natives. Their gardens and courts are crowded by its plants, their rooms ornamented with vases filled with its gathered branches, and every bath strewn with the full-blown flowers, plucked with the ever-replenished stems. . . . But, in this delicious garden of Negaaristan, the eye and the smell are not the only senses regaled by the presence of the rose: the ear is enchanted by the wild and beautiful notes of multitudes of nightingales, whose warblings seem to increase in melody and softness with the unfolding of their favourite flowers. Here, indeed, the stranger is more powerfully reminded that he is in the genuine country of the nightingale and the rose." (*Persia in Miniature*, vol. iii.)

At marriages and other festivities, in the middle ages, the guests wore chaplets of roses. The author of the romance of *Perce Forest*, describing an entertainment, says, "Every person wore a chaplet of roses on his head. The constable of France, and, probably, other great officers at other courts, when he waited on the king at dinner, had one of these crowns. Women, when they took the veil, and when they married, were thus adorned. Warriors wore their helmets encircled with these flowers, as appears from their monumental figures. This fondness of our ancestors for this fragrant and elegant flower, and the various uses to which they applied it, explains a particular, that, at first sight, seems somewhat whimsical, which is, the *bushels of roses* sometimes paid by vassals to their lords." (*Histoire de la Vie Privée des Français*, vol. ii. p. 221.)

In Britain, one of the earliest notices of the rose occurs in Chaucer, who wrote early in the thirteenth century; and in the beginning of the fifteenth century, as we have already noticed (p. 33.), there is evidence of the rose having been cultivated for commercial purposes; and of the water distilled from it being used to give a flavour to a variety of dishes, and to wash the hands at meals; a custom still preserved in some of our colleges, and also in many of the public halls within the city of London.

Among the new year's gifts presented to Queen Mary in 1556, was a bottle of rose (rose) water, a loaf of sugar, cinnamon, and nutmeg (*Nichol's Illustrations*, note by T. G. C.); and, in 1570, we find among the items in the account of a dinner of Lord Leicester, when he was chancellor of the University of Oxford, 3 oz. of rose-water.

In an account of a grant by Richard Cox, Bishop of Ely, (18 Queen Elizabeth, 20th March, 1576,) to Christopher (afterwards Sir Christopher) Hatton, of great part of Ely House, Holborn, for twenty-one years, the

tenant covenants to pay, on Midsummer-day, a red rose for the gate-house and garden; and for the ground (fourteen acres), ten loads of hay, and 10*l.* per annum; the bishop reserving to himself and successors free access through the gate-house, for walking in the gardens, and gathering twenty bushels of roses yearly. (*Malcolm's London*, 4to, vol. ii. p. 231—237.) On this grant, Sir Thomas G. Cullum observes, that this deed affords us a pleasing instance of relaxation of feudal tyranny; the old manorial lords generally clogging their grants of land with oppressive services. In the same light we should consider the jocular tenures by which several manors, or parcels of land, were formerly holden. (*Cullum's Hawstead*, 2d edit. p. 118.) In 1597, we find Gerard speaking of the damask rose, or rose of Damascus, and the cinnamon rose, as common in English gardens. Hakluyt says that the rose of Damascus was brought to England by Dr. Linaker, physician to Henry VII.; and his successor, Sir Richard Weston, who wrote in 1645, says, "We have red roses from France." In the reign of James I., the keeper of the robes and jewels at Whitehall, amongst a variety of other offices, had separate salaries allowed him, "for fire to air the hot-houses, 40*s.* by the year;" and "for digging and setting of roses in the *Spring Gardens*, 40*s.* by the year." (*History of the First Fourteen Years of King James*. T. G. C.) As, during the middle ages, roses were in use in the festivals of the church throughout Europe, it seems probable that they would be generally introduced into the gardens of the priories and other religious establishments. The moss rose was brought to England from Holland early in the eighteenth century. Very little faith is to be placed in the assertions of persons ignorant of gardening and botany, as to the date of the introduction of particular plants; as a proof of which may be given the remarkable fact, that Madame de Genlis, when she was in England, saw the moss rose for the first time in her life; and, when she returned, took a plant with her to Paris, in order to introduce it into France; though the fact is, that it was originated in Provence. The musk rose, Hakluyt tells us, in 1592, was first obtained from Italy; and it also was common in the time of Gerard. The single yellow rose was known to Gerard, but not the double, which, Parkinson informs us, as noticed p. 757., was brought to England from Syria before 1629. One of the most valuable of roses, the China rose (*R. indica*), was first introduced in 1789; and it may be said to have created a revolution in the culture of roses, by the innumerable varieties which have been raised between it, the deep red China rose (*R. semperflorens*), introduced the same year, and the European roses.

Properties and Uses. The great use of the cultivated rose, in all countries where it is grown, is as a floriferous shrub; but it is, nevertheless, cultivated for the uses to which its flowers are applied in medicine and domestic economy in different parts of Europe, in the north of Africa, and more especially in Asia. In Syria, it has been cultivated from time immemorial; and, indeed, the aboriginal name of that country, Suristan, is said to signify the Land of Roses. The rose plantations of Damascus, those of Cashmere, of the Barbary coast, and of Fayoum in Upper Egypt, have been already mentioned as cultivated for making the attar, or essence, of roses from their flowers. In France, the rose de Provins is extensively cultivated in the neighbourhood of the town of that name, in the department of Seine et Mame, about 60 miles south-east of Paris; and also at Fontenay aux Roses, near Paris, for products of a similar nature. In Britain, in the neighbourhood of London, Edinburgh, and other large towns, and in many private gardens, the flowers are gathered for making rose-water, or drying as perfumes. The various preparations from the flowers are, the dried petals, rose-water, vinegar of roses, spirit of roses, conserve of roses, honey of roses, oil of roses, and attar, otto, butter, or essence, of roses. After making some general remarks, we shall notice the mode of preparing each of these articles.

The kind of rose cultivated for commercial purposes, in Syria, is generally said to be the damask, or Damascus, species; but, according to Langles (*Recherches sur la Découverte de la Rose, &c.*), it is the musk rose from which

the essence known as attar is procured. This rose, the flowers of which are not so double as those of many others, also flowers later than most of the sorts. According to Desfontaines and Langles, it is cultivated extensively near Tunis, in the neighbourhood of other African cities bordering the Mediterranean, at Fayoum in Upper Egypt, and also in Persia and in India. The hundred-leaved rose is the variety most commonly grown, both in France and England, for its petals. The rose de Provins, however, is cultivated on a large scale in the vicinity of Paris, on account, according to Bosc, of its tonic and astringent properties, which are diametrically opposite to those of most other roses, which are all more or less laxative or purgative. According to an analysis of the petals of the rose de Provins (*R. gallica*), as grown in the extensive plantations of Fontenay aux Roses, they are found to contain a certain gallic acid and tannin, which accounts for their medical properties. The petals of this rose are also the only ones that increase in fragrance in drying; all the other sorts being much less fragrant when dry, than when in a recent state.

The petals of roses ought always to be gathered as soon as the flower is fully expanded; and the gathering should never be deferred till it has begun to fade; because, in the latter case, the petals are not only discoloured, but weakened in their medical properties. They should be immediately separated from the calyx, and the claws of the petals pinched off; they are then dried in the shade, if the weather is dry and warm, or by a stove in a room, if the season is humid; care being taken, in either case, not to spread them on the ground, but on a platform raised 2 ft. or 3 ft. above it.

The drying should be conducted expeditiously; because it has been found that slowly dried petals do not exhale nearly so much odour as those which have been dried quickly; which is, indeed, the case with hay, sweet herbs, and odoriferous vegetables generally. After the petals are dried, they are freed from any sand, dust, or eggs of insects, which may adhere to them, by shaking them, and rubbing them gently in a fine sieve. After this, the petals are put into close vessels, from which the air is excluded, and which are kept in a dry airy situation. As it is extremely difficult to free the rose petals entirely from the eggs of insects, they are taken out of these vessels two or three times a year, placed in sieves, rubbed, cleaned, and replaced. Parmentier states that the petals of red roses keep longer than those of white ones. At one time, the dried petals of the roses of Provins were so celebrated, that, according to Pomel (*Histoire des Drogues*), they were sent as far as India; and M. Opois, apothecary of Provins, who has written a dissertation upon the roses in the neighbourhood of that town, affirms that, owing to the nature of the soil, and a superior mode of cultivation, the roses of Provins are more fragrant when dry, and better adapted for medicinal purposes, than any others whatever. Desfontaines asserts that apothecaries employ both pale and red roses; and that the petals of the Provins, of the hundred-leaved damask, and of the common damask, are used by them indifferently.

Rose-water is distilled from the petals of pale roses, in preference to deep red ones, mixed with a small quantity of water; and, in France, those of the musk rose are preferred when they can be obtained. This product of the rose was known to the Greeks in the time of Homer, and to Avicenna, among the Arabs, A. D. 980. It is more or less in use, in every civilised country, for the toilette, and on occasions of festivals and religious ceremonies. It is still used at the feasts of the corporate bodies of the city of London. Medicinally, it is applied to sore eyes, either alone, or with Goulard's extract, or other medicines.

Vinegar of Roses is made by simply infusing dried rose petals in the best distilled vinegar. It is chiefly used on the Continent, for curing headaches produced by the vapours of charcoal, or the heat of the sun. For this purpose, cloths, or linen rags, moistened with the vinegar, are applied to the head, and left there till they are dried by evaporation.

Spirit of Roses is procured by distilling rose petals in sand heat, with a

small quantity of spirits of wine. This produces a very fragrant spirit, which, mixed with sugar, makes the liqueur known in France by the name of *l'huile de rose*; it also forms the groundwork of the liqueur called *parfait amour*.

Conserve of Roses is prepared by bruising in a mortar the petals with their weight of sugar, till the whole forms a homogeneous mass. In the earlier ages, when, according to Rosembourg, in his *History of the Rose* (published in 1631), the rose was a specific against every disease, this conserve was thought a sovereign remedy for a cold. It was much in use in the time of Gerard, and is still employed in the composition of electuaries, and many other medicines.

Honey of Roses is made by beating up fresh rose leaves with a small quantity of boiling water; and, after filtering the mass, boiling the pure liquor with honey. This was formerly much in use for ulcers in the mouth, and for sore throats.

Oil of Roses is obtained by bruising fresh rose petals, mixing them with four times their weight of olive oil, and leaving them in a sand heat for two days. If the red rose de Provins be used, the oil is said to imbibe no odour; but, if the petals of pale roses be employed, it becomes perfumed. This preparation was celebrated among the ancients. Pliny says that, according to Homer, roses were macerated for their oil in the time of the Trojans. The oil is chiefly used for the hair, and is generally sold in perfumers' shops, both in France and England, under the name of *l'huile antique de rose*.

Essence, Attar, Otto, or, as it is sometimes called, *Butter, of Roses*, is the most celebrated of all the different preparations from this flower; and forms an object of commerce on the coast of Barbary, in Syria, in Persia, in India, and in various parts of the East. In England, it is usually called otto of roses, a corruption of the word attar, which, in Arabic, signifies perfume. This essence has the consistence of butter, and only becomes liquid in the very warmest weather. It is preserved in small flasks, and is so powerful, that touching it with the point of a pin will bring away enough to scent a pocket-handkerchief for two or three days. The discovery of the essence of roses dates from the year 1612, and is said to have been made by the mother-in-law of the Great Mogul, in the manner already mentioned, p. 785. The essence is still procured almost in the same manner in which it was when first discovered; viz. by collecting the drops of oil which float on the surface of vessels filled with rose water, when exposed to a strong heat, and then congealing it by cold.

Roses give more or less of this oil according to their kind, and the climate and soil in which they have been cultivated. The musk rose is considered the best, and the climate and soil of Cashmere the most favourable; the otto of roses procured from Persia is next in estimation to that of Cashmere; and that of Syria, and that of the Barbary states, are considered to be of very inferior quality. The manner of making the otto of roses in Cashmere is given by Dr. Donald Monro, in the *Transactions of the Society of Edinburgh*, vol. i. p. 12., published in 1790. The petals of the roses are put into a wooden vessel along with pure water, and exposed for several days to the heat of the sun. The oily particles, being disengaged by the heat, float upon the surface of the water; whence they are sucked up, from time to time, by applying to them some very fine dry cotton wool. From this wool the oil is pressed into little bottles, which are immediately afterwards sealed hermetically. The quantity of essence obtained from 100 lb. of rose petals scarcely amounts to half a drachm.

A wretched Substitute for Otto of Roses is said to be formed by the apothecaries of Paris: the petals of *Rosa damascena*, No. 35. p. 759., are boiled in a large caldron of water along with as much hog's lard as will cover its surface with a thin stratum of grease. The oil of the rose petals, on separating from them by boiling, unites with this grease, from which it is again separated by spirits of wine.

A Conserve of Roses was formerly made of the hips, or fruit, when ripe and

mellowed by the frost : this was done by removing the seeds and chaffy bristles which line the inside of the hip, and afterwards beating the pulpy matter up in a mortar with sugar. The mossy protuberance frequently seen on the wild rose and the sweet briar was also formerly used in medicine; but it is now neglected. It is produced by the puncture of the *Cynips rosæ*, and other kindred species of insects; and, among druggists, was known by the Arabic name of *bedeguar*.

For culinary and confectionery Purposes, rose-water is in much demand. Very good tarts are also made, on the Continent, of the conserve of the hips, as well as of the conserve of the petals; and rose-buds are preserved in sugar, and pickled in vinegar. The apple-bearing rose (*Rosa villosa pomifera*) produces the largest fruit of all, and is the best adapted for preserving; but *R. sýstyla* and *R. arvensis* are said by Mr. Joseph Woods (*Lin. Trans.*) to produce fruit, which, though of a smaller size, is of a higher flavour than that of any other species. (*Hort. Soc. Cat. of Fruits*, edit. 1826, p. 195.) The employment of the rose in the manufacture of liqueurs has been already mentioned. The green leaves of the sweet briar are sometimes, on the Continent, steeped in spirits of wine, to communicate to it a fragrance; and they are commonly used, in England, to put into cowslip wine, to give it a flavour. Tea has been also made of these leaves; and those of all the sorts, as well as the young tender shoots, are readily eaten by cattle, horses, and sheep. The points of the luxuriant shoots of sweet briar, deprived of their bark and leaves, and cut into short lengths, are sometimes candied like the blanched leaf-stalks of angelica and finocchio.

The Wood of the Rose is very hard and compact, and of a fine grain; and, if it could be procured of sufficient dimensions, it might serve as a substitute for box, in making mathematical instruments.

Hedges are formed both of the wild and of the cultivated rose; but they are not well adapted for the purposes of protection and enclosure, from their rambling habit of growth, the large space they occupy when unpruned, and their liability to become naked below when cut in on both sides, so as to occupy only the space allowed to a hedge of hawthorn. For garden hedges, however, many of the varieties are eligible, and more especially the fastigate-growing kinds; such as the *Rosa indica*, which, in warm sheltered situations, forms a very handsome evergreen hedge, flowering nearly all the year.

Undergrowths of Roses. Many of the climbing and trailing sorts, and particularly the evergreen varieties of these, are well adapted, as Mr. Rivers has observed (p. 781.), for undergrowths in open woods; but, in this case, the timber trees should not be so close as to touch each other with their branches, and, consequently, to exclude the direct rays of the sun from the roses. These, also, should be allowed, in some places, to climb to the tops of the highest trees, where they will flower profusely, and, in a few years, hang down; occasionally forming festoons from one tree to another in a manner singularly beautiful and picturesque. The different varieties of *Rosa arvensis*, especially the Ayrshire and evergreen roses, are particularly well adapted for this purpose. We have seen fine examples of the effect of climbing roses, produced in some neglected parts of the woods at Eastwell Park, Pains Hill, Claremont, and more particularly at Pepperharrow. At Spring Grove, the late Sir Joseph Banks had a Siberian variety of the *Rosa arvensis*, which produced a singularly rich and beautiful effect on a group of tall trees near the house. Mr. Beckford of Fonthill formed, about 1804, in his woods, several acres of undergrowths of roses of the very choicest kinds; and the effect was extraordinary (though it could not be called appropriate), while care was bestowed upon them; but, no sooner was the place quitted by Mr. Beckford, in 1826, and the plantation neglected, than they began to be choked up by brambles, and other plants sown by the birds, and to die off, till, when we visited the scene in 1833, we could not observe a single rose remaining. (See *Gard. Mag.*, vol. xi. p. 441.)

When verdant Sculpture or Architecture is to be employed in gardens, there are very few plants that will so soon cover frame work as the evergreen climbing roses; and they have the advantage over ivy of producing fine flowers, which are succeeded by fruits that attract singing birds; and over other rapid-growing climbers, such as the *Ampelopsis hederacea*, in addition to these advantages, that of being green all the year.

Poetical, mythological, historical, and legendary Allusions. The rose has been a favourite subject with the poets of all countries, in all ages; and a tolerably large volume might be formed, if all the poems written on it were collected, as there has, perhaps, never yet existed a poet of any eminence, who has not sung its praises. In mythological allusions it is equally rich. It was dedicated by the Greeks to Aurora, as an emblem of youth, from its freshness and reviving fragrance; to Venus, as an emblem of love and beauty, from the elegance of its flowers; and to Cupid, as an emblem of fugacity and danger, from the fleeting nature of its charms, and the wounds inflicted by its thorns. It was given by Cupid to Harpocrates, the god of silence, as a bribe, to prevent him from betraying the amours of Venus; and was hence adopted as the emblem of silence. The rose was, for this reason, frequently sculptured on the ceilings of drinking and feasting rooms, as a warning to the guests, that what was said in moments of conviviality should not be repeated; from which what was intended to be kept secret was said to be told "under the rose." The Greek poets say that the rose was originally white, but that it was changed to red, according to some, from the blood of Venus, who lacerated her feet with its thorns when rushing to the aid of Adonis; and, according to others, from the blood of Adonis himself. The fragrance of the rose is said by the poets to be derived from a cup of nectar thrown over it by Cupid; and its thorns to be the stings of the bees with which the arc of his bow was strung. Anacreon makes the birth of the rose coeval with those of Venus and Minerva:—

"Then, then, in strange eventful hour,
The earth produced an infant flower,
Which sprang with blushing tinctures drest,
And wanton'd o'er its parent breast.
The gods beheld this brilliant birth,
And hail'd the Rose—the boon of earth."

MOORE'S *Anacreon*.

Another fable relating to the birth of the rose is, that Flora, having found the dead body of one of her favourite nymphs, whose beauty could only be equalled by her virtue, implored the assistance of all the gods and goddesses to aid her in changing it into a flower which all others should acknowledge to be their queen. Apollo lent the vivifying power of his beams, Bacchus bathed it in nectar, Vertumnus gave its perfume, Pomona its fruit, and Flora herself its diadem of flowers. Other mythological writers relate that the beautiful Rhodante, Queen of Corinth, to escape the persecutions of her lovers, attempted to seclude herself in the temple of Diana; but, being forced by the clamour of the people from her sanctuary, prayed to the gods to change her into a rose; which still bears the blushes that dyed her cheeks when forced to expose herself to public gaze, and under which form she is still universally admired. A beetle is often represented, on antique gems, as expiring surrounded by roses; and this is supposed to be an emblem of a man enervated by luxury; the beetle being said to have such an antipathy to roses, that the smell of them will cause its death.

The Romans were very fond of roses. Pliny tells us that they garnished their dishes with these flowers; and we have already alluded (p. 785.) to their custom of wearing garlands of them at their feasts. Cleopatra received Antony, at one of her banquets, in an apartment covered with rose leaves to a considerable depth; and Antony himself, when dying, begged to have roses scattered on his tomb. The Roman generals, who had achieved any remarkable victory, were permitted to have roses sculptured on their shields. Rose-water was the favourite perfume of the Roman ladies; and the most luxurious even used it in their baths.

In the *East*, the rose has always been a favourite with the poets. They represent the nightingale as sighing for its love; and many beautiful verses are derived from this fable. "In a curious fragment by the celebrated Persian poet Attar, entitled *Bulbul Nameh*, The Book of the Nightingale, all the birds appear before Solomon, and charge the nightingale with disturbing their rest, by the broken and plaintive strains which he warbles forth all the night in a sort of frenzy and intoxication. The nightingale is summoned, questioned, and acquitted by the wise king; because the bird assures him, that his vehement love for the rose drives him to distraction, and causes him to break forth into those passionate and touching complaints which are laid to his charge." (*The Language of Flowers*, p. 116.) The Persians also assert that "the nightingale, in spring, flutters around the rose bushes, uttering incessant complaints, till, overpowered by the strong scent, he drops stupified on the ground." (*Ibid.*) Mr. Rivers, in the *Gard. Mag.*, vol. x. p. 133., mentions that Sir John Malcolm told him that, when in Persia, he had once breakfasted on an immense heap, or rather mount, of roses, which the Persians had raised in honour of him.

The Turks believe that roses sprang from the perspiration of Mahomet: for which reason, they never tread upon a rose leaf, or suffer one to lie on the ground; they also sculpture a rose on the tombstones of females who die unmarried. There are many legends related of roses in the East. The story of the learned Zeb, who intimated by a rose leaf that he might be received into the silent academy at Amadan, is well known. The vacant place for which he applied having been filled up before his arrival, the president intimated this to him by filling a glass so full of water, that a single additional drop would have made it run over; but Zeb contrived to place the petal of a rose so delicately on the water as not to disturb it in the least, and was rewarded for his ingenious allusion by instant admission into the society. According to the Hindoo mythology, Pagoda Siri, one of the wives of Vishnu, was found in a rose.

The Rose was also celebrated in the Catholic Church. "Marullus tells a story of a holy virgin, named Dorothea, who suffered martyrdom in Cæsarea, under the government of Fabricius, and who converted to Christianity a scribe named Theophilus, by sending him some roses, in the winter time, out of Paradise. A golden rose was considered so honourable a present, that none but crowned heads were thought worthy either to give or to receive it. Roses of this kind were sometimes consecrated by the popes on Good Friday, and given to such potentates as it was their particular interest or wish to load with favours; the flower itself being an emblem of the mortality of the body, and the gold of which it was composed of the immortality of the soul." (*Lindl. Ros. Monog.*, p. xv.) In an old mosaic, in the church of St. Susan, at Rome, Charlemagne is represented kneeling, and receiving from St. Peter a standard covered with roses. The custom of blessing the rose is still preserved in Rome, and the day on which the ceremony is performed is called *Dominica in Rosâ*. The rose was always considered as a mystical emblem by the Catholic church; and, as Schlegel observes, it enters into the composition of all the ornaments of Gothic churches, in combination with the cross. The seal of Luther was a rose. In 530, St. Médard, Bishop of Noyon, instituted a festival at Salency, his birthplace, for adjudging annually the prize of a crown of roses to the girl who should be acknowledged by all her competitors to be the most amiable, modest, and dutiful in the village; and he had the pleasure of crowning his own sister as the first rose queen. This custom was continued to the time of Madame de Genlis, who, in the first volume of her *Théâtre d'Éducation*, has written a beautiful little drama, entitled *La Rosière de Salency*, on the subject. In the middle ages, the knights at a tournament wore a rose embroidered on their sleeves, as an emblem that gentleness should accompany courage, and that beauty was the reward of valour. About this period, the rose was considered so precious in France, that, in several parts of the country, none but the rich and powerful were allowed to cultivate

it; but in later times we find it mentioned among the ancient rights of manors, that their owners were empowered to levy a tax, or tribute, on their tenants, of so many bushels of roses, which were used, not only for making rose-water, but for covering the tables with, instead of napkins. The French parliament had formerly a day of ceremony, called *Baillée de Roses*, because great quantities of roses were then distributed. Shakspeare, who, no doubt, followed some old legend or chronicle, derives the assumption of the red and the white roses, by the rival houses of York and Lancaster, from a quarrel in the Temple Gardens, between Richard Plantagenet, Duke of York, and the Earl of Somerset, the partisan of Henry of Lancaster. Finding that their voices were getting too loud, Plantagenet proposes that they shall

“ In dumb significance proclaim their thoughts ;”

adding,—

“ Let him who is a true-born gentleman,
And stands upon the honour of his birth,
If he supposes I have pleaded truth,
From off this briar pluck a white rose with me.”

To which Somerset replies, —

“ Let him who is no coward, nor no flatterer,
But dare maintain the party of the truth,
Pluck a red rose from off this thorn with me.”

Their respective followers gathered the different coloured roses; and hence, tradition says, these flowers were adopted as the badges of the houses of York and Lancaster, during the civil wars which afterwards desolated the country for more than thirty years. The *Ròsa álba* is said to have been the one chosen as the badge of the House of York, and the *Ròsa gállica* as that of Lancaster. The York and Lancaster rose, which, when it comes true, has one half of the flower red, and the other half white, was named in commemoration of the union of the two houses, by the marriage of Henry VII. of Lancaster with Elizabeth of York. It has been observed, that the roses on seals, &c., always appear very double, and as if copied from the form of *R. centifolia*; also, that the shoe ornament called a rosette has for its type a similar kind of rose. The roses used in Gothic architecture, on the contrary, are comparatively flat, with large open petals, like the *R. gállica*.

Soil and Situation. The common wild roses will grow in very poor soil, provided it be dry; but all the cultivated sorts require a soil naturally light and free, and more or less enriched. The situation should be open and airy, exposed to the east, or, in warm situations, to the north, rather than to the south; because the intensity of the sun's rays accelerates too rapidly the expansion of the flowers, and also diminishes the colour and fragrance of the petals. A rose-garden, fully exposed to the sun during the whole day, may have a useful degree of shade given to it by the distribution of a few standard roses of not less than 8 ft. or 10 ft. in height; or by the introduction of frames of wood or wire, in the forms of obelisks, gnomons, crosses, columns surmounted by globes, or cones, on which climbing roses may be trained. These, would produce no bad effect by their drip, and yet, by their shadow, which would vary with the position of the sun, they would afford a salutary protection to the dwarf roses by which they were surrounded; and thus effect, in some degree, the same object as a cool situation and exposure. The rose is one of those plants that will not thrive in the neighbourhood of towns where the prevailing fuel is pit-coal; hence the roses grown within a circle of ten miles of the metropolis are much inferior in beauty to those grown at double that distance: for example, at Sawbridgeworth in Hertfordshire, in the rose nurseries of Mr. Hooker at Brenchley in Kent, and in those of Mr. Woods at Maresfield in Sussex, and of Mr. Donald at Woking. The influence of the smoke of London on the roses grown in its neighbourhood is every year extending its circle; and roses which grow and flower very well in gardens, in situations where building is only commencing, gradually lose their vigour as the number of houses surrounding them is increased. The first effect of the smoke is to prevent the flower buds from opening freely, and the

next to diminish their number: the leaves then gradually become smaller, and the length of the shoots less; after which the plant weakens by degrees, and, in a few years, if a standard, it dies altogether, or, if a dwarf, barely exists, and seldom, if ever, flowers.

Situation in Garden Scenery. In country residences, roses are generally distributed in the margins of shrubberies along with other flowering shrubs: but, considering the culture they require, it is impossible they can thrive in such a situation; and, even if they did thrive, the kind of beauty which they would produce would be of a character so different from that of a general shrubbery, as, according to the principles of a reasonable taste, to require their exclusion from it. The only roses fit to be planted in a shrubbery are the single kinds, in their wild state. Roses, and all other kinds of shrubs or trees, that are far removed from a state of nature, and valued for something produced by art, either in their flowers, fruit, bark, or leaves, should be grown in situations where the art which produced the artificial effect can be employed. Hence all fruit-bearing trees and shrubs should be grown in orchards, in kitchen-gardens, or in some place by themselves, so as to admit of properly cultivating the soil, and managing the plants. Roses, and all double-flowering shrubs, ought, in like manner, to be grown by themselves; and the same principle will apply to shrubs having any peculiarity in their foliage, and even in their mode of growth. The continuation of the peculiarity may not always require a rich soil; on the contrary, it will generally be found to have been produced by a soil and situation of a peculiar nature: but that peculiarity of soil it is as much the object of art to imitate, as it is to form the rich soil, and favourable situation, which produce large or double flowers, or large and succulent fruit. Hence, to cultivate roses properly, they must be grown either in groups by themselves on a lawn, or in a flower-garden; or be connected into a system of groups, or beds, in a rosarium, or rose-garden.

Rosarium, or Rosetum. Where it is intended to plant a collection of roses, the best effect will be produced by devoting a group to each section; such as one to moss roses, another to Noisettes, a third to Scotch roses, &c. These groups ought generally to be planted with dwarfs rather than standards; because the former are more conveniently looked upon by the spectator: but a handsome standard may, frequently, occupy the centre of each group, if it is a circle or a square; and two or three in a line, or radiating from a point, if it is of a long or an irregular form. Sometimes a group may be surrounded by a row of standards, which, in that case, should have clear stems, not less than 7 ft. high, through which the dwarf roses may be seen by persons walking round the group. Standard roses, in general, have the best effect when formed into an avenue along the margin of a walk; and for this purpose they are very suitable for common flower-gardens, where the groups, instead of being planted with dwarf roses, are filled with herbaceous plants. The sizes of the different groups in a rosarium ought to be proportioned to the number of varieties belonging to the section to be planted in each. For these purposes, the catalogue of Messrs. Rivers may be taken as a basis; and, as it contains seventeen groups, exclusive of the climbers, these may be represented by seventeen circles of different diameters, or by seventeen squares, parallelograms, or clusters of irregular-shaped figures, bearing the same proportion to each other in regard to superficial contents. For each kind of rose to be planted in the group, a square yard ought to be allowed if a dwarf, and more if a standard; because, to admit of roses being displayed to the greatest advantage, every plant, whether a standard or a dwarf, ought to be free on every side. Fig. 525. is a design for a rosarium by E. B. Lamb, Esq., well known for his elegant designs in our *Encyclopædia of Cottage Architecture*, and our *Architectural Magazine*. The groups in this design are calculated to contain the entire collection of Messrs. Rivers, with the exception of the climbers, which, we think, have a better effect planted in an open arcade, or in a row of columns or obelisks, than crowded together in one group.

This design, which is to a scale of 40 ft. to 1 in., is calculated to include the whole of Mr. Rivers's collection, one plant of a sort; or two of those which are small in size, or tender, as the miniature China roses, and the musk rose. The climbers are proposed to be trained against pyramids formed of four iron rods, joined by horizontal wires; two sorts being placed at opposite angles of the pyramid, so that each sort may cover two sides. The pyramids may be 18 in. on the side at the bottom, and 15 ft. high; and they should be fixed in beds rising at least 6 in. above the surface of the soil. The pyramids are proposed to be distributed through the beds in such a manner as to afford a salutary degree of shade to the dwarfs. The dwarfs may be arranged in the following order; which is founded on the principle of adapting the number of sorts in each of Mr. Rivers's groups, to the sizes of the different beds.

1. *Provence, or Cabbage Roses, R. centifolia*, 25 sorts. Two pyramids.
2. *Rosa indica odorata, or Tea-scented China Roses*, 21 sorts. Three pyramids.
3. *Musk Roses*, 10 sorts. No pyramid.
4. *Hybrid China Roses*, 89 sorts. Three pyramids.
5. *Rosa alba, and its varieties*, 25 sorts. One pyramid.
6. *Select Roses of uncertain origin*, 25 sorts. One pyramid.
7. *Noisette Roses*, 66 sorts. Three pyramids.

8. *Rosa indica, or China Roses*, 70 sorts. Three pyramids.
9. *Scotch Roses*, 27 sorts. One pyramid.
10. *Rosa gallica, or Provins, or French Roses*, 99 sorts. Three pyramids.
11. *L'Île de Bourbon Roses, Rosa indica var.*, 33 sorts. One pyramid.
12. *Damask Roses, R. damascena*, 19 sorts. No pyramid.
13. *Sweet Briars*, 17 sorts. One pyramid.
14. *Miniature China Roses*, 16 sorts. No pyramid.

15. *Rosa bracteata and microphylla, and their varieties*, 10 sorts. No pyramid.
16. *Perpetual, or autumnal, Roses*, 5 sorts. Three pyramids.
17. *Moss Roses*, 24 sorts. Two pyramids.

In all, 17 groups of dwarfs, and 27 pyramids for climbers. Two sorts of climbing roses are proposed to be planted against each pyramid; which will thus include the whole of Mr. Rivers's collection, amounting to 54 sorts.

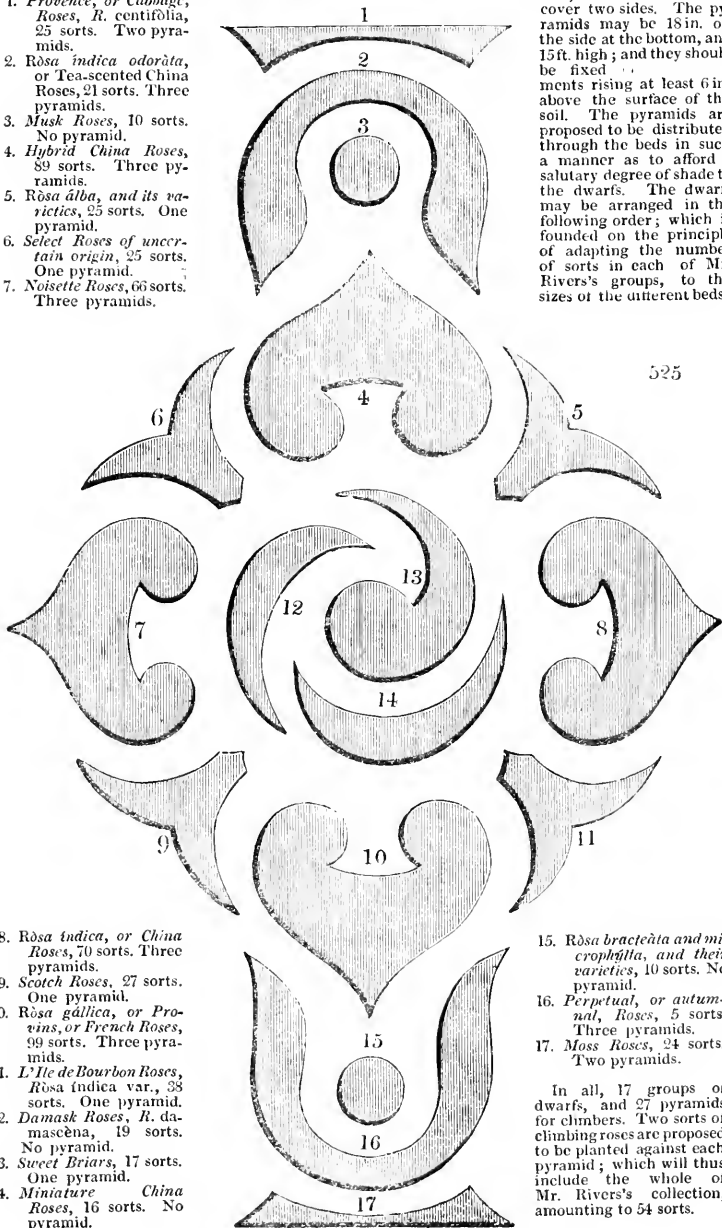

When a rosarium, the groups of which are disposed so as to form one symmetrical figure, is to be planted solely with dwarf roses, the walk which surrounds it ought always to be 2 ft. or 3 ft. above its level, in order that the spectator, after having studied the groups in detail, may be able to retire to the surrounding terrace walk, and get a birdseye view of the whole. This principle, indeed, is applicable to all symmetrical rosariums, cisterns, flower-gardens, American grounds, &c., which are to be planted with dwarfs. Where standards, whether roses or other shrubs, are used; either in groups alone, or interspersed with the dwarfs, as in *fig. 525.*; a surrounding terrace walk, though almost always desirable, is not so essential for the display of the beauty of the scene.

Where a rosarium cannot be formed in one compact whole, as in the design, *fig. 525.*, it may be laid out on each side of a leading walk, in various ways. The walk may be either straight, or regularly curved: in either case,

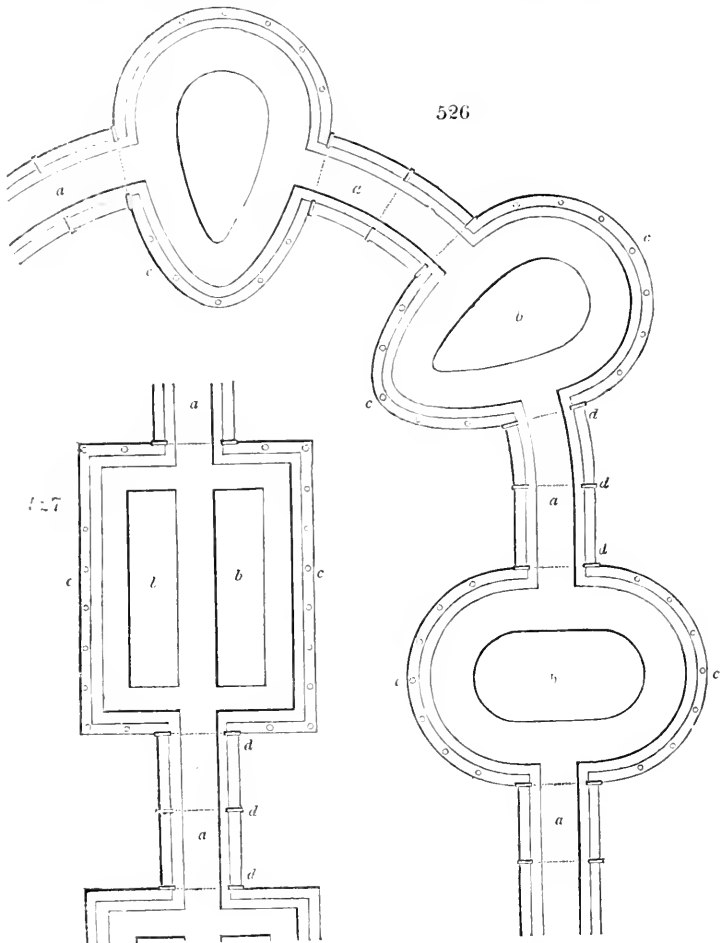

the climbing varieties may be used to form a sort of open arcade, to separate each section, as indicated in *figs. 526. and 527.* In these figures, *a* repre-

sents the arcade; *b b*, beds for the dwarf plants; and *c c*, rows of standards belonging to that section planted in small borders exterior to the walk. By having the portions of arcade always at regular distances from each other, the unity of effect in the perspective, to a person walking through it, will be kept up; while the bed, or beds, devoted to each section, though always of the same length, might be regulated, in point of breadth, so as always to give the precise superficial contents required. By surrounding these beds with a row of standards of the same kind as the dwarfs, the scene would be shut in; and, on that account, its effect would be stronger. Instead of separating each group into two beds to make room for the central walk, as in *fig. 527.*, they might be united in one, and surrounded by a walk, as in *fig. 526.*; but, though this might improve the view of a straight arcade from one end, we apprehend it would considerably lessen the enjoyment of walking through it, by the regularly repeated interruptions which the beds would produce. The piers of the arcade ought to present their edges to the walk; and they should not rise up out of the soil, or abruptly from the gravel, but from a plinth of stone on its margin: while the plants ought always to rise, not from the gravel or the turf, but from a dug spot; because no improved rose will thrive, for any length of time, in ground which is not frequently stirred and manured.

Arcades of Roses. When roses are grown in arcades, and the flowers are to be seen from below, the arches on which the plants are trained should always be at such a distance from each other as freely to admit the light between them; otherwise, the finest roses will be produced on the exterior surface of the arcade, and few or none be seen from the inside; the plants will, also, soon become naked below. The best mode for growing the plants, and displaying their blossoms to a spectator on the walk, is to form the arches of

the trelliswork, about 1 ft. or 18 in. in width; and to place them along the walk, not nearer than 6 ft. or 8 ft. apart, as indicated in *fig. 526.* at *d d d.* The reason why the edge of the arch of trelliswork is placed to the walk, and not its side, as usual, is, the better to display the roses on each face of the trelliswork to persons passing along the walk. The height of the summit of the arches ought to be regulated by the distances between them; making it such, that, when the spectator is standing beneath one arch, he may see the summit of another at an angle of from 30° to 40°. When diagonal arches are to be formed, single iron rods only may be employed, both for the cross arches, and those which are placed diagonally; but, though this forms the handsomest arcade to walk under, we do not think it displays the roses to the same advantage as the broad arches of trelliswork placed edgewise, which we have just mentioned; and of which *fig. 528.* shows the elevation and the ground plan. Where the flowers are to be seen from without, the arcade may be wholly covered with shoots; but, in that case, it must be understood to be formed for the shade, and not for the appearance which the flowers are to produce to a spectator walking through it.

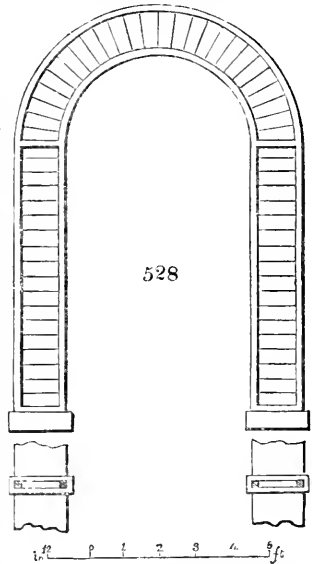

Espaliers of Roses, as a substitute for hedges in a flower-garden, may be formed, by training them either on a single wire fence (*fig. 529.*, of which *fig. 530.* is the ground plan), or on a double fence, composed of hoop-iron and wire, in the manner indicated in *fig. 531.* The standards, *a a*, are of hoop-iron, and are kept together at top by the rod *b*, which passes through them;

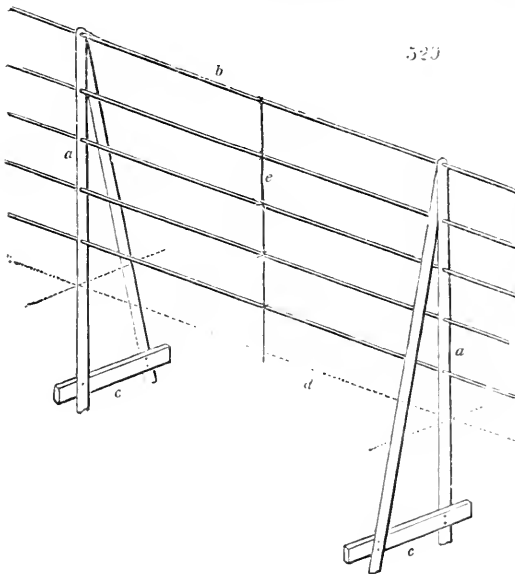

529

and their lower extremities are nailed to pieces of wood (c), which, when the fence is put up, are buried in the soil to the depth of 2 ft. or 3 ft., as indicated by the dotted line d, so as to keep the espalier firmly in its place. In the middle of each portion (such as that indicated in the figure) of the espalier, and equidistant from the standards of hoop-iron, is the standard of rod-iron (of the same thickness as that used for the horizontal rails), e; to which these rails are fastened with wire, merely for the purpose of keeping them steady, and at regular distances from each other. The espalier may be extended to any length, by inserting the ends of the horizontal rods in cylinders of tinned iron, as indicated at f,

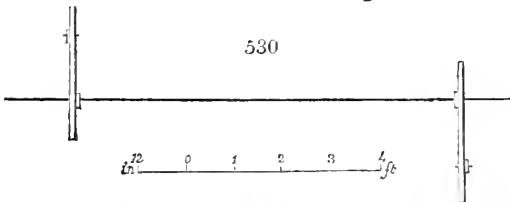

530

which is the tin cylinder, while g g are the ends of two rods which are to be inserted in it; or they may be joined in the manner of hooks and eyes, which is the strongest mode,

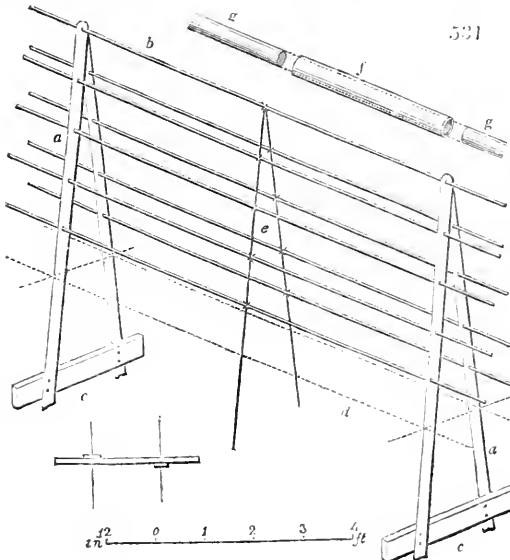

531

though not so neat as the other. The iron rods are generally about $\frac{1}{4}$ in. in diameter, and 16 ft. long. Espaliers of this kind, being broader at bottom than at top, admit of the rain falling on all the leaves from the top to the bottom; and, whether they are covered with shrubs or trees, for the sake of their flowers, or for their fruit, they are alike handsome and advantageous. Different sorts may be grown on each side of the espalier; or only one sort may be placed

in the centre; half its shoots being trained on one side, and the other half on the other side. We have had an espalier of this kind at Bayswater, covered with gooseberry bushes, since 1824. It has been twice painted with gas tar; and is now, 1836, nearly as strong as when it was first put up. The total expense was about 1s. 6d. for a foot in length.

Climbing Roses, treated as Standards, may be modified into various forms. One of the simplest is to train a plant to a pole, of from 10 ft. to 20 ft. in height, formed of a young larch of that length, the side branches of which have been cut off within 6 in. of the stem. Three such trees, placed together in the form of a triangle, about 2 ft. on the side at bottom, and terminating at a point about 20 ft. from the ground, produce a very good effect; and, if desirable, the triangle may be enlarged at the base, or the base may be formed into a square, and several poles used, so as to give the superstructure the character of a pyramid. Where there is no parterre rosarium, the climbing roses, planted against such pyramids, would form a very good substitute for one. Where the climbing sorts are to form part of a rosarium, and not to be planted on arcades or poles, they may be trained to three iron rods, joined by smaller rods, as exhibited in *fig. 536.*; or they may be trained to single rods, terminating in cups, parasols, or mandarin hats, as may be recommended for wistaria, and other twining plants, and as exemplified in *figs. 533, 534, and 535.* *Fig. 536.* may be executed in a very economical manner, by making

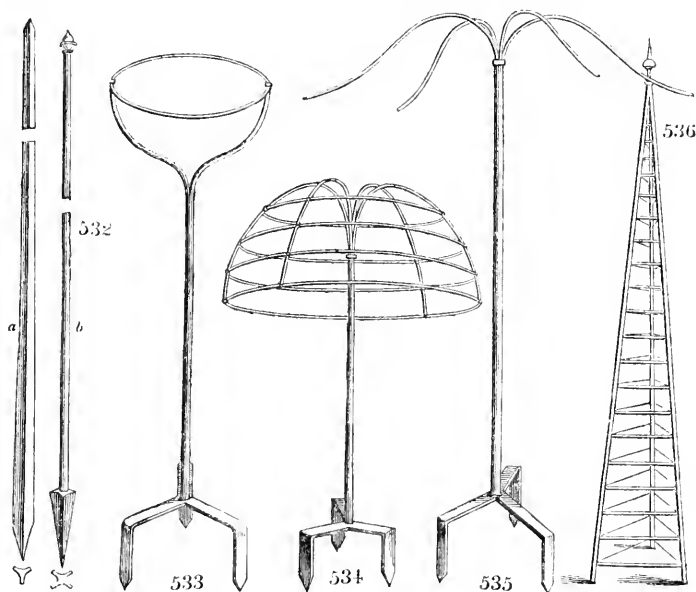

the standards of hoop iron, which would be kept steady by the small iron rods passed horizontally through them. It will be observed that this figure terminates in a ball and spike; the use of the latter is to prevent birds from perching upon the ball, and dirtying the foliage and flowers below. Where a collection of climbers is to be planted in a rosarium, or as a rose avenue in a flower-garden, a simple and permanent support, and one, at the same time, economical in point of expense, may be formed by single larch trees, with the stumps of the branches left on; or with hoop iron, joined by wires, as recommended above as a mode of executing *fig. 536.* This mode is particularly suitable where the object is to display flowers the whole height of the

standard; and answers best for those climbers which take their origin from *R. semperflorans* and *R. indica*; but for such vigorous-growing climbers as *R. sempervirens*, and of all the varieties that partake of the nature of *R. arvensis*, single stems, with a spreading top, will have the best effect; because, in these kinds, the beauty, for the most part, consists in the grace of the pendulous shoots, and their numerous tufts of foliage and flowers.

Walls covered with Roses. Roses are frequently trained against walls; and, where a collection of climbing sorts is so displayed, a very good mode to keep each sort within bounds, and to afford all an opportunity of equal display, is to place the plant in the centre of the space devoted to it, and to spread two leading shoots horizontally from it to the limits of the space allowed, and afterwards to train these

shoots perpendicularly upwards, as in *fig. 537*. The side shoots which are produced by these boundary stems are partly to be cut off, and partly to be trained horizontally, as indicated in the figure. This mode of training is very well exemplified in the Horticultural

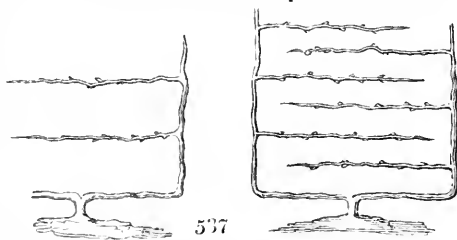

Society's Garden; but the collection not being all placed together in regular series, it does not produce so much effect as it otherwise would do.

Covering Rockwork with Roses. Some of the very low-growing kinds, such as *R. spinosissima*, produce a very good effect when planted among large blocks of stone, or in the crevices of natural rocks; but it must not be forgotten, that, in such situations, the soil cannot be properly cultivated, and, therefore, only unimproved varieties should be employed.

Baskets of Roses are frequently formed, in flower-gardens and on lawns, by pegging the branches of the roses close to the ground with hooks, and surrounding the group, which should be of a round, oval, or basket-like shape, with a low frame of wire, or lattice-work. In this case, the ground between the plants has a good effect when covered with live moss, pebbles, or shells. Sometimes roses of the dwarf-growing kinds are elevated in rustic basket-work, and placed in the rosarium or the flower-garden, or on the lawn. These baskets, and sometimes, also, the beds formed in imitation of baskets, have a handle placed over them to increase the illusion, over which climbing roses are trained.

Edgings to beds or borders, formed of low-growing roses, and hedges, as already mentioned (p. 790.), are not unfrequent in flower-gardens; but, as in the case of rockwork, these modes of growth are not adapted for the more choice kinds, from the difficulty of applying the proper cultivation.

Patches of Roses in Flower-Borders. The rose, both as a standard and as a dwarf, is one of the commonest ornaments of mixed flower-borders; and, since the introduction of the different varieties of *R. indica* and *R. semperflorans*, such borders have been farther enriched by planting annually patches of the hardiest and most free-flowering of these varieties, and treating them as herbaceous plants. Some of the Noisettes, and of the very dark-flowered varieties of *R. indica*, thus treated, produce a splendid effect. The plants may be struck from cuttings in heat the same season; or they may be raised in sand under a hand-glass, in a shady border, the preceding year, potted in autumn, kept in a cold-pit through the winter, and planted out in April or May, in holes filled with leaf-mould or rich free soil.

Propagation. The rose, till nearly the end of the eighteenth century, was, both on the Continent and in England, almost always propagated by taking up the plant, and dividing it, or by layers. Whether the practice of budding roses originated on the Continent or in England, we are uncertain; but we think there can be very little doubt that it was first practised in France: and

this practice has given rise to another revolution in rose culture, as remarkable as that already noticed (p. 800.) with regard to the treatment of China roses as herbaceous plants in beds or borders. When roses were propagated by layers or division, the plants formed small bushes, in the finer kinds seldom rising above 2 ft. or 3 ft. from the surface; but no sooner had the practice of budding exotic roses on the strong-growing wild kinds been adopted, than the idea occurred (probably between 1790 and 1800) of budding them standard high, and thus producing those tree roses with globular heads, covered with flowers, supported on stems from 4 ft. to 6 ft. in height, or higher, now so common in French and British gardens; and which are to be met with, more or less, in most fine gardens both in Europe and America.

The rose is now propagated by all the different modes capable of being applied to ligneous plants: that most generally in use with the ordinary sorts, in private gardens, is by suckers, or by taking up the entire plant, dividing, and replanting it. In nurseries, dwarf plants are generally raised by layers; and standards almost always by budding on stocks of the common wild rose. Dwarfs are also frequently propagated by budding on low stocks; and many of the kinds are increased by cuttings. New varieties, also roses for stocks in some cases, and the common sweet briar always, are raised from seed. We shall submit a few words on each of these modes of propagation, and refer the reader to our *Gardener's Magazine* for more minute details.

By Layers. These may either be made, during winter, of the preceding summer's shoots; or, in July, of the growing shoots of the current season. In the latter case, a whole year is gained, as layers made in July will be rooted, and ready to remove, the following November. The young shoots of some varieties of roses, such as the Vittoria, are very brittle, and are apt to break off at the point where the tongue of the layer is formed. To obviate this, it has been found, that, by inserting the knife in the middle of the shoot, instead of immediately under the bud, and merely producing a longitudinal slit of 3 in. or 4 in. in length, through two or three buds, and quite through the shoot; and by keeping this slit open with a little earth, a chip of wood, or, in short, whatever may be most conveniently at hand, more root fibres will be produced than by the common mode of layering; and no risk will be incurred of breaking the shoot. This mode of layering is the invention of Mr. James Monro of the Brechin Nursery (see *Gard. Mag.*, vol. ix. p. 301.); and it is calculated to be of the greatest value to propagators of roses. Mr. Monro, who, at first, used small stones to keep the slit open, afterwards applied a little decayed moss (*Hýpnum*), or, instead of this, a small portion of grafting clay, for that purpose.

By Cuttings. This mode is chiefly applicable to the varieties which partake of *Ròsa índica*, *R. semperflòrens*, *R. Boursaultii*, *R. Noisettiana*, &c. The cuttings may either be put in during the winter season, and protected by glass, or early in spring; or, in the course of the summer, they may be made of the young shoots with their leaves on. In either case, they are best planted in pots or pans, so as to be brought forward on a little heat. One of the most expeditious modes is, to put a plant or two of any of the roses that grow readily by cuttings into a hot-house or hot-bed, in January or February. The heat will cause them rapidly to throw up some young shoots; and, as soon as these have three or four leaves, they should be taken off, however tender or succulent they may be, taking care not to remove, shorten, or injure any of the leaves. After preparing the cuttings, they should be planted in sand, a glass put over them, and placed in the same heat as the plants. In three weeks, cuttings thus treated will have rooted, and will be ready to pot off. As the old plants continue to produce shoots, these may be taken off for cuttings; or the plants raised from cuttings may be topped for that purpose, till as many young plants are propagated as may be wanted. Mr. J. Elles, who practised this method at Longleat, says that he raised upwards of 100 plants of *Ròsa odoràta* in one season, from a small plant, which only afforded

three cuttings at the commencement. (*Gard. Mag.*, vol. vi. p. 428.) Plants raised in this manner flower almost immediately, and continue producing fresh blossoms throughout the whole summer: they are admirably calculated for being planted in groups in mixed flower-borders, and treated as herbaceous plants, as recommended p. 800.; and, when *R. i. odorata* is used, a few patches of it will perfume an entire garden.

By Budding. This is a very general mode of propagating the rose, and is almost always adopted when it is to be grown as a standard. Mr. Rivers is decidedly of opinion, that roses never bloom so finely as when budded; and that the most proper and durable stock is *R. canina*, with its varieties; while *R. arvensis* is, perhaps, the worst. The operation of budding, in France, is performed at any time, from February to September; but principally, as in England, during July and August. When performed in February, a portion of the wood is taken off along with the bud, and a cavity of the same shape is made in the stock to receive it; so that this mode of budding partakes much more of the nature of grafting than any of the other modes.

The rose is also budded in April, by removing the bark only, in the same manner as in summer; and this is what the French call budding à *l'œil poussant* (with the pushing eye); while the ordinary summer budding is called budding à *l'œil dormant* (with the sleeping eye). For the mode of budding with a portion of the wood attached, mentioned above, we are not aware that the French have any specific name; but we shall take the liberty of calling it niche budding, or notch budding, and the other two kinds spring budding and summer budding.

Niche Budding. The rose may be budded, in February or March, in the following manner:—To prepare the bud, a transverse cut is made into the wood, a little below an eye (*fig. 538. a*); which incision is met by a longer cut downwards, commencing at a

short distance above the eye, *b*; care being taken that a portion of wood is removed with the bark, as shown at *c*. This bud, with a portion of wood attached, is inserted in a niche in the stock, made as nearly as possible of the same size as that left in the scion

by the removal of the bud *c*, as shown at *g*. In placing the bud on the stock, the principal thing to be attended to is, to bring the horizontal edges of the base of the niche in the stock, and those of the bud which is to fit into it, into the most perfect contact possible; because the union is produced, not, as in common summer budding, by the junction of the soft wood of the stock with the rudiment of the soft wood on the inside of the bark of the bud, but by the junction of soft wood with soft wood, as in common grafting. Dr. Van Mons recommends the cut, or niche, in the stock to be made where there is already a bud; making the horizontal cut through the base of the bud. (See *Gard. Mag.*, vol. ii. p. 193.)

Spring Budding. When the rose is to be budded in spring, Dr. Van Mons recommends the scions to be cut off before winter, and stuck into the ground till the moment in spring, generally about the end of April or the beginning of May, when the bark of the stock will separate freely from the wood: the operation of budding may then be performed in the usual manner, with the slight modifications, in respect to future treatment, given in the following directions by Van Mons. The bark of the stock, as early in spring as it will separate from the wood, being cut like an inverted T, as shown at *d* in *fig. 539.*, the horizontal edges of this cut in the

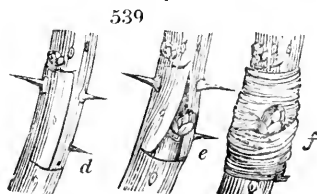
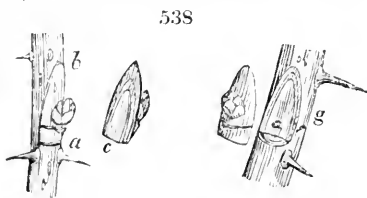

stock, and of the shield of bark containing the bud, must be brought into the most perfect contact with each other, as at *e*; and then bound with waterproof bast (*f*), without, however, applying grafting clay, or grafting wax. Eight days after the insertion of the bud, the stock is pruned down to the branch which is immediately above the opposite side; and this branch is stopped by being cut down to two or three eyes; all the side shoots are removed, and, in five or six weeks afterwards, when the bud has pushed its fifth leaf, the point of the shoot is pinched out, so as to compel the shoot to branch out; and the branches thus produced will bear flowers in August or September.

Summer Budding. This is almost the only mode of budding in general use, whether for the rose, or for any other tree or shrub, either in Britain or on the Continent. The most general method adopted, on the Continent, of performing it on the rose is that indicated by *fig. 539*, in which the two cuts in the bark form the letter T reversed, already detailed; whereas in England they form the letter T upright. Either mode may be adopted according to the season: in spring budding, the slit made in the form of a T reversed (thus, **L**) is the best; but in August, or summer, budding, the T slit ought to be made erect; because the junction, at this season, takes place by the descent of the sap; whereas in spring it is effected chiefly by its ascent. Where the shoots produced from the stock are weak, the buds may be inserted in the main stem; more especially if the stock is not very old, and the bark hard. Sometimes, buds inserted even in August will push the same season; more especially if the roots of the stock have been well supplied with water: but, whether they push the first season or the next, the points of the shoots produced ought to be pinched off at three or four joints from the stock, in order to cause them to branch out; because, when only one long single shoot is produced from each bud, it is liable to be broken off close to the stock, by the wind. Budding early in the season succeeds best on young wood; and, during August and September, it succeeds best on old wood. Buds of the China rose and its varieties, put in in July, frequently flower the same season. Twelve different modes of budding will be found described, and illustrated by engravings, in the *Gard. Mag.*, vol. ii. p. 191., and vol. x. p. 305.; and the various modes of propagating the rose by budding and grafting will be found explained, to those who have no practical knowledge of gardening, in the *Gard. Mag.*, vol. iv. p. 351. In this article, the writer directs the buds to be put in from the beginning to the end of August, either in the old or young wood, as may be most convenient, watering the root well, in dry seasons, for several days previous to the performance of the operation, in order to assist the bark to rise. Budding with the dormant bud is, he says, practised in May; sometimes with common roses, but more frequently with China roses, Banksias, Noisettes, &c. In general, two buds are sufficient for any stock; and these should be of only one variety, as two sorts seldom grow with equal vigour; and, of course, the one soon robs and destroys the other. The bast ligature which confines the buds should be pretty tight; and a laurel leaf may be slightly tied on with it, in such a way as to form an arch over the bud, to defend it from the sun and rain, both of which are as prejudicial as the air. The ligatures may be removed, in moist seasons, after a month; but, in hot weather, not for six weeks at least. The general season for budding in England is the end of July, and the beginning of August; but in France and Belgium, by watering the stocks, and the plants from which scions are to be taken, abundantly throughout the season, and by some variations in the mode of treatment according to the period of the year, the operation is performed from the beginning of June to the end of September. In budding in June, Dr. Van Mons first deprives the young shoots, from which he proposes to take buds, of their leaves; and, fifteen days afterwards, he finds the buds sufficiently swelled to allow their being taken off and inserted in the stocks. If the stock is allowed to have a leading shoot above the inserted bud, and this shoot is not shortened, the bud inserted will probably not push for six weeks or two months; but if this shoot is

shortened or cut off, and all those on the lower part of the stock removed, the new bud will push in two or three weeks; and will flower the same season, if treated as above directed for the shoots produced by buds inserted in April. The scion of a rose-tree, Dr. Van Mons observes, is seldom too dry for the buds to succeed, provided the shield is inserted with a thin bit of wood behind its eye; but when the bark is quite fresh, and full of sap, this thin bit of wood is unnecessary.

Grafting is occasionally employed for propagating the rose, particularly in the case of dwarfs. For this purpose, the scions should be collected in March, and stuck in a lump of clay, 1 in. deep: the clay should be pressed firmly to the ends of the scions, and the mass afterwards bedded in a pot full of earth, to prevent the moisture in the clay from evaporating, but not so as to cover the shoots. The pot of scions may then be set in any shed or outhouse, that is neither very dry nor very damp, for three weeks. The object of treating the scions in this manner is to retard their growth, in order that the stocks may be more forward in vegetation than the scions. In Flanders, where the cleft mode is commonly adopted, care is taken that the scion is of the same diameter as the stock, as in *fig. 540. a a*; or that the cleft in the stock is made sufficiently near one side, to admit of the bark of the scion fitting the bark

of the stock on both of its edges, as shown at *b b*. In grafting on the dog-rose, the same practice is followed, with this addition, that the shoulder *c* is very often made to the scion; care being taken that there is a bud on the wedge part of it (*d*), as shown at *e*. Whip, or splice, grafting is, also, sometimes practised with the rose; in which case, it is essential to have a bud left on the lower extremity of the scion, as indicated in *fig. 541*, which would otherwise die off. This, both in niche budding and in grafting, contributes materially to success, on the same principle that cuttings and layers are more certain of rooting when they are cut at a joint, than between the joints. The reason is, that the vital principle is there more powerful; and that the germs, both of buds and roots, are, in most plants, confined to the joints of the stems; though in some, as in the common elm, they appear to be distributed equally over every part of the stem and roots. In making the incision in the side of the stock which is to receive the scion that is to be applied in the whip, or splice, manner, the knife ought always to be entered at the base of a bud, and passed upwards.

The grafts, in Belgium, are tied on with fine bast, which is made water-proof by passing it first through a solution of white soap, and next through one of alum; a neutral compound being thus formed, which is insoluble in water. The ligature is covered with marly clay in the usual manner, or with grafting wax. (*Gard. Mag.*, vol. ii. p. 192.)

Stocks for grafting or budding Roses. On the Continent, as well as in England, these are generally procured from the woods and hedges, of an age and size fit for immediate use. The best season for collecting them is November; because they can then be immediately planted; and they will be in a fitter state for pushing out roots and shoots the following spring, than if they had not been obtained till that season, or even if they had been got out of the woods in autumn, and the planting delayed till spring. Stocks, so procured, have very few fibrous roots, which renders this attention to their early planting more necessary; though it must be confessed, that roses will grow with fewer fibrous roots than almost any other sort of ligneous plant. The best

540

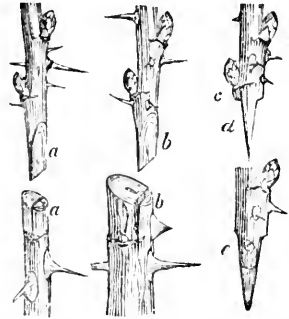

541

kind of wild rose for stocks, as already observed, is the *R. canina*; and the age of the plants, or the thickness of their stems, is of much less consequence than their being healthy, straight, and free from knots. For dwarfs, they need not exceed 1 ft. or 18 in. in height; but for standards they may vary from 3 ft. to 6 ft. and upwards. A very convenient height for displaying the rose to the human eye, is 4 ft., the head being pruned so as to rise about 18 in. higher. For a truly grand effect, however, and for forming avenues of roses along the walks in flower-gardens, between which the beds of flowers are to be seen, the stocks ought never to be less than 6 ft. high, and 7 ft. or 8 ft. would be better. Before planting the stock, cut it over at an angle of 50°, the upper part of the cut, or section, ending a quarter of an inch above a bud; or, if there are two buds nearly about the same height at the top of the stock, cut across from the one to the other, as in *fig. 542*, leaving about a quarter of an inch of wood above each bud. If the slope of the section is much greater than an angle of 50°, the wound will not become covered with bark, at least in most cases; and on its being completely covered depends the durability of the plant. Immediately after cutting the stock across, cover the wound with grafting clay, enveloping it with live moss, tied on with water-proof bast; or, as the practice is on the Continent, cover it with a composition made of the following ingredients: five eighths pitch, one eighth rosin, one eighth tallow, and one eighth bees' wax, all thoroughly incorporated; or, one half bees' wax, and one half pitch, which is the composition commonly used in France; or 1 lb. of white Burgundy pitch, $\frac{3}{4}$ lb. black pitch, $\frac{1}{4}$ lb. rosin, $\frac{1}{4}$ lb. bees' wax, 2 oz. of tallow, 1 oz. pounded mastic, and 1 oz. saltpetre, which is the mixture used in Belgium. Equal parts of bees' wax and pitch, with a very little tallow added, we have found the simplest and best mixture for covering wounds in ligneous plants of every kind; and, for covering grafts, it has only to be mixed with a very little sand. Put any of these mixtures into a pipkin, and keep it warm enough to melt for three quarters of an hour: when cooled a little, dip the extreme point of each stock in it, so as to leave a portion of mixture, equal to the thickness of two or three sheets of paper, over the section; or, if you have neglected to perform this essential operation till after the stocks are planted, the mixture may be applied warm with a small brush. In England, this process is too generally neglected; and the section is neither covered with grafting clay, nor grafting wax. The consequence of this neglect is, that the rains and the frost rot the wood during winter, and the drought cracks it during summer: it decays, and leaves the stock hollow; and, after being budded, and forming a head, the plant is only of three or four years' duration, instead of lasting seven or eight years. The nurserymen say that the price given will not repay them for taking so much trouble; but it would be much better for a purchaser to pay a higher price for plants so treated, than almost any prices for those in which this precaution has been neglected. When the stocks begin to push in March, rub off all the buds, except such as may be close to the margin of the section, which will generally be two, but never less than one, or more than four. The shoots produced from these buds are intended to be budded; and, therefore, on the 1st of July, the prickles should be removed from them on the places where the buds should be inserted, which ought to be not farther than 1 in. from their junction with the stock. The operation of budding may be performed from the end of July to the end of August; supplying the stock with abundance of water in dry seasons, as has been already recommended, to facilitate the rising of the bark. Mornings and evenings are the best times of the day for budding; and, when a northerly or easterly wind prevails, the operation ought not to be attempted, on account of the drying influence of these winds on the bark of the stock, as well as on the bud. In general, only one sort of rose ought to be put on one stock, for reasons already given. (p. 803.)

542



By Seed. The common single sweet briar is always raised from seed; and sometimes, also, the dog rose, for stocks. The other sorts of roses are only

raised from seed when it is thought desirable to procure new varieties. The seeds, in either case, are separated from the hips when the latter are fully ripe; and are either sown immediately, or mixed with sand and preserved till the following spring. They are then sown, and thinly covered with soil. The plants will come up the first season, and, with careful treatment, they will flower, in most cases, in the fourth or fifth year; but the varieties of *R. semperflorens* will frequently flower the second year, and sometimes even the first year.

Culture. The rose, in an artificial state, may be considered in the light of an herbaceous plant; in so far that it requires to be frequently taken up and replanted, that this may be done at almost any season, and, also, that it should have its old wood cut out every year, or every second or third year.

Planting roses should, in general, be performed in the autumn; but, with the more delicate varieties of China roses, and with *R. multiflora*, *R. moschata*, and their varieties, it may be deferred till spring. As roses have but few fibrous roots, the operation of planting them may be easily and rapidly performed; the chief point being to put some fresh soil in the hole along with the roots, and to press the earth firmly to them. In cold clayey soils, Mr. Rivers recommends, as the best compost for roses, rotten dung and pit sand; and in warm dry soils, rotten dung and cool loams. When standard roses are to be planted in a broad border, it is almost unnecessary to observe, that those nearest the walk should be the lowest, and those at the greatest distance from it the highest. A border 15 ft. or 20 ft. wide, planted in this manner, with five or six parallel rows, quincunx in the plan, and rising one above another in the elevation, has a very splendid effect when the plants are in flower.

Taking up and Replanting. The rose, whether grown as a standard or a dwarf, ought to be taken up every five or six years, even in good soils, and have its roots shortened and trimmed; a portion of the soil in which it grew should also be removed, and replaced by rich fresh loam. In unfavourable soils, Mr. Rivers remarks, this process ought to be performed every third or fourth year. Dr. Van Mons says that the practice in Belgium, even in the best soils, is to take up the plants at the end of eight years, and either replace them in fresh soil, or throw them away, and substitute young plants. In common flower-borders, where dwarf roses are not grafted, and where, of course, they produce suckers freely, they should be taken up every other year, and replanted; the digging and manuring of the border occasioning a change in the position of the soil relatively to that of the plant, and thus producing nearly the same effect as the partial renewal of the soil.

Planting to retard the Flowering of Roses. The rose may be taken up and replanted at any season, provided the shoots are shortened, and deprived of all their leaves; and the soil in which they are planted liberally supplied with water. Hence roses, taken up just before they are coming into flower, and properly pruned and replanted, will produce their flowers in November; or, by planting them in pots, and placing them in a shady situation, and then putting them under glass on the first appearance of frost, they may be made to produce their flowers about Christmas. Practices of this kind were formerly common among the florists of Paris, but have been, in a great measure, relinquished since the introduction of the sweet-scented China roses; which, placed in a moderate heat, under glass, in autumn, continue flowering all the winter. Roses may also be made to flower in the autumn by pruning them back in the spring, as soon as the flower buds are discoverable. The plant, in this case, as in that of taking up and replanting, makes a second effort to produce flowers, which effort is not attended with success till late in the season.

The *Rose des Quatre Saisons* is a good sort for employing in these operations; and Dumont observes that this rose, when pruned immediately after it has bloomed for the first time, may be made to produce its flowers during winter; being, of course, protected by a hand-glass, and covered with mats during very severe weather. In all experiments for forcing roses in the open air, it must be remarked, that it is essential for the soil to be fresh and rich, and the situation favourable.

Pruning. The rose requires to be pruned every year; the strong-growing hardy kinds in the autumn, or the beginning of winter, and the more tender kinds early in spring. Dumont recommends pruning the early-flowering sorts in autumn, and the late sorts during spring; but neither during winter. Rivers observes that pruning should always be performed in October or March; but October pruning, he says, will be found decidedly the most advantageous, as, the plant having less wood and fewer buds to nourish during the winter, the buds left will have acquired extra vigour for pushing in the spring. This is a valuable remark, and will apply to all ligneous plants whatever. In the operation of pruning three objects ought to be kept in view: the removal of the old wood, because, in most varieties, it is only the young wood that produces large and finely formed flowers; the thinning out and shortening of the young wood, that the flowers produced may be fewer, and consequently have more nourishment, and more light and air, and thus become stronger; and the forming of the head, or bush, into some symmetrical shape. Some varieties require much less pruning than others; and climbers, and most of the varieties of the Scotch rose, should, in general, only have their shoots thinned out, and should be but seldom, if ever, shortened. In shortening young shoots, not more than from two to three, or, at most, four buds, should be left on each. The cuts should be made close above the bud, about the thickness of a sixpence from it, and sloping away from it at an angle of about 45° . A standard rose, properly pruned, will, in general, present a head, in the winter season, not more than 1 ft. in diameter; nevertheless, some of the vigorous-growing kinds will flower very well with heads of twice or thrice that size. (See *figs.* 543, 544, and 545.) The peculiarities in treatment which different varieties require, whether as regards pruning, or other points of culture, will be found noticed under their respective names in preceding pages; and in Mr. Rivers's observations on the different sorts grown in his nursery: see p. 780. to p. 783.

Summer Pruning. By cutting out wood at different times during summer, a succession of roses may be produced, more especially in the Noisettes, and other China varieties, and in the rose des quatre saisons: but this practice should never be adopted as a general one; because, by occasioning extraordinary exertion in one season, it weakens the plants for the year following. The only kinds of summer pruning that we think generally applicable and unobjectionable are, thinning out with the finger and thumb the flower buds as soon as they are discernible, so as to leave no more than what the plant can bring to perfection; and, after these buds have expanded and begun to decay, cutting them off close to the floral leaf. In performing this last operation, none of the leaves ought to be cut off; because the effect of that would, with many varieties, be to occasion the production of a second shoot, and thus to weaken the plant, as well as to render it unsightly. There are some roses which have handsome calyxes, and others which produce large and showy coloured hips, such as the apple-bearing rose: in both these cases, instead of cutting off the decayed flower, the decayed petals only should be picked out; and this, also, should be done in the case of those roses which, when the stalks of the decayed flowers are cut off, are apt to produce summer shoots. In the case of single roses, the cutting off of the decayed flowers is not so necessary as in the double sorts; as it is the multiplicity of petals in a state of incipient decay which gives that slovenly appearance, so contrary to the spirit of what we call the gardenesque, and what our enlightened and elegant contemporary and friend, M. Soulange-Bodin, calls *la belle culture*, as being in gardening what the *belles lettres* are in literature, or the *beaux arts* in the arts.

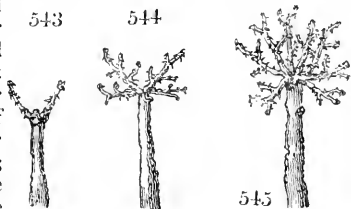

Staking and Training Standard Roses. All standard roses above 2 ft. high require to be supported by stakes; otherwise, when the head is loaded with leaves and flowers, it is very apt to be blown to one side, and either to become unsightly, or, probably, to be broken off. In country places, where wood is abundant, the stakes may be formed of poles or rods cut out of coppice-wood, or the thinnings of young plantations; and, of the former, those of the larch, the oak, and the ash will commonly be found to be the most durable. Where the thinnings of young plantations are employed for stakes, the most durable will be those of the larch; and, where roses are grown extensively in the country, the most economical mode of staking them would be, to make plantations of larches from time to time, planted close together, and to cut them down, as wanted, when of the proper size. Where neatness and permanence are desirable objects, however, nothing can equal the stakes of cast and wrought iron, manufactured by Cottam and Hallen of London, and R. Mallet of Dublin. These stakes will be found described and figured, and their weight and prices given, in the *Gardener's Magazine*, vol. viii. p. 556.; and it will be sufficient here to mention, that, in lengths of 7 ft., a dozen of them will weigh 108 lb., and cost 13s., if the stakes are formed wholly of cast iron; while, if formed of wrought-iron rods let into cast-iron sockets, and varying in size from 2 ft. to 6 ft. 6 in., they will cost from 2s. to 10s. 6d. per dozen. A considerable saving in the material used in these stakes is made by casting the sockets with flanches, or fins, *fig. 532. b.*, and also by casting the entire rod with fins, as in *fig. 532. a.* These stakes are calculated for roses which are to have their heads closely cut in: but the Noisettes, and various kinds of China roses, produce most effect when the shoots are allowed to grow to the length of 2 ft. or 3 ft., or more, from the stem. To train these shoots into a regular head, stakes with ring or parasol tops, such as *fig. 533.* or *fig. 534.*, are useful. In general, these stakes should not be fixed till after the roses have been planted two or three years, and have acquired strength sufficient to form a handsome head the first year the stake is placed beside them. When such a stake as *fig. 533.* is fixed in the ground, the ring at the top should stand about 1 in. or 2 in. higher than the top of the stock. This ring is fastened to the two iron limbs of the standard by nuts, and is unscrewed, and hung on one of the limbs while the standard is being fixed; it is then raised to its place under the branches of the tree, which, as already observed, should be sufficient in number and length to extend over the ring. Mr. Lawrence, of the Querns near Cirencester, who appears first to have adopted this mode of training, selects six or eight of the strongest shoots in spring, and ties them to the ring with tow twine; and if, from their length, this be not sufficient to prevent the shoots from blowing about, he ties strings to the ring, and extends them to pegs stuck in the ground. All the other shoots of the head are cut back in the usual manner. *Fig. 546.* is an accurate sketch, taken in 1831, from a bizarre de la Chine rose, which was at that time six years planted. It is needless to say, that it formed a truly splendid object. Those who dislike the appearance of the strings may adopt, as a substitute for them, the parasol stake. (*fig. 534.*) In the gardens at Gunnersbury, climbing roses of the more choice kinds are trained on wire domes, or demi-globes, or demi-ovals, 4 ft. or 5 ft. in height, and are found to produce an excellent effect. The wire rods are about a quarter of an inch in thickness.

Removing Suckers and Side Buds from the Stocks on which Roses are worked is an operation which should not be neglected. It has been remarked by Dumont, that suckers, when at a distance from the stem of the rose, do not appear to injure the plant; which, indeed, is the case with the suckers of all trees or shrubs that come up at a distance from the stem; this being one of the modes of propagation which nature has supplied to a considerable number of plants, both ligneous and herbaceous: but suckers from the base of the stem, and shoots from the stem itself, are less injurious in the case of the grafted rose, than in that of most other grafted plants. The reason is, or

546

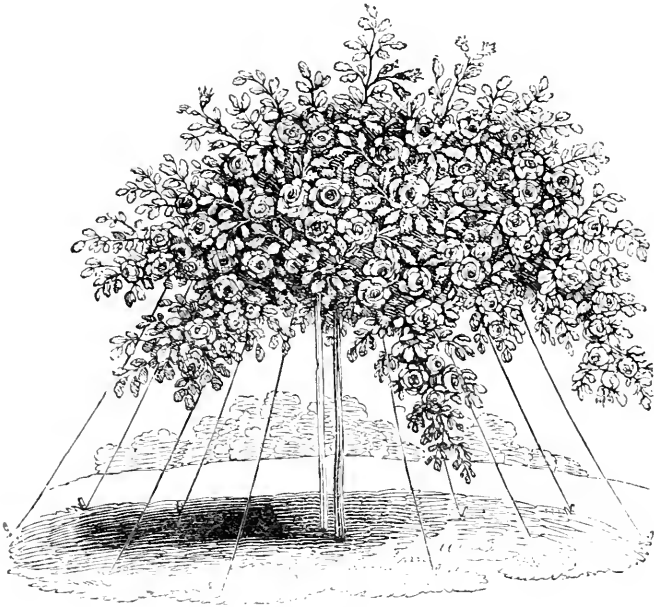

seems to be, that the rose stocks are always of much more robust habit, with reference to the scions grafted on them, than the stocks of any other grafted tree or shrub whatever.

Watering. All plants in a state of high culture require watering in the summer season, otherwise they will not develop their parts to a sufficient extent. The rose bush best produces its flowers in the three hottest months, June, July, and August; and neither in Britain, nor on the Continent, will roses expand their blossoms fully, or have strength to resist the attacks of insects, unless they are liberally supplied with water. Before they come into flower, the leaves should be syringed every evening in dry weather, and the root abundantly supplied either with common water, or liquid manure. Dwarf roses require less water than standards; because the nearness of the bush to the ground, by covering the soil, prevents evaporation. Lime water (that is, lime held in solution in water, and not such a mixture of lime and water as will leave a coating of lime on the plants) may be used, both with the syringe and at the root; and, though it will not entirely destroy the aphides, those great enemies of roses, yet it will check their increase, and it will totally destroy caterpillars of every kind. To destroy the aphides, after syringing with pure water or lime water, the plants should be sprinkled with the powdered leaves of tobacco, or refuse snuff, as directed under the head of Insects, and the syringing left off for a few days; after which they should be well washed with clean water.

Growing in Pots and Forcing. The dwarf-growing roses, and, indeed, most sorts as dwarfs, may be grown in pots; care being taken to turn them out of the pots once a year, and, after trimming their roots and shoots, to repot them in fresh soil. So complete is the command of the cultivator over a rose in a pot, that, with the aid of glass, a choice of sorts, and the power of applying a very little heat in the winter months, he may have roses in abundance all the year. Cabbage and moss roses, when they are to be forced, should be taken up out of the free ground as soon as they have done flowering,

and their wood is ripened; they should then be pruned and potted, and kept in a shady situation till taken into the house. Moss roses, introduced into a pit or hot-house on the 1st of October, will blossom by Christmas-day; those on the 1st of November, from the middle of January to the middle of February; those on the 1st of December, from the middle of February to the middle of March; those on the 1st of January, from the middle of March to the middle of April; those on the 1st of February, from the middle of April to the middle of May; and those on the 1st of March, from the middle of May to the middle of June; when some of the earlier varieties of moss rose will be in bloom in the open air. (See the details on forcing the rose, given in the *Gard. Mag.*, vol. i. p. 122.) During the forcing season, the plants ought to be supplied liberally with water of the same temperature as the air in which they are kept, and with as much light and air as can be admitted without chilling them; they may also be watered occasionally with liquid manure. Where a regular system of forcing roses is carried on, there should not be less than four houses or pits; viz. one for commencing the process, in which the temperature should not exceed 50° , and where the plants may remain a fortnight; another, to which they ought to be removed, where the temperature may be 60° or 65° ; a third, in which they ought to remain six weeks, or till they begin to flower, when they ought to be removed to the fourth house or pit, where they should be kept at a temperature of 60° (which is about that of living-rooms), to prepare them for being removed thither. (See *Encyc. of Gard.*, edit. 1835, § 6045.) Those, however, who are contented with *Rosa i. odorata*, or any other sweet-smelling variety of China rose, may have roses all the winter, without a tithe of this trouble and expense, by keeping them in a house or pit, at the temperature of 50° .

Insects. The insects that attack rose trees are of several kinds, all very destructive, and all very difficult to destroy; principally, because the means for their destruction are seldom resorted to till their ravages have commenced. The most numerous of these are the aphides, commonly called green flies, or plant lice, which are well known to all rose-growers. These insects lay their small black eggs in autumn, generally near the axils of the buds, so that the young brood may be conveniently placed for feeding on the tender shoots when they appear. In mild seasons, these eggs are hatched about the latter end of February, and the insects produced are few and inconspicuous, many being generally destroyed by the cold. Those that remain, after twice casting their skins, arrive at their full growth about April, when they begin to breed. "According to Richardson, the first brood consists entirely of females; and each of these produces a numerous progeny without the assistance of the other sex. These, though themselves produced from eggs, are viviparous. A third generation appears in May; and the months of June and July each supply two more. In the autumn, the eighth, ninth, and tenth generations are produced; two of them in August, and the last, which consists of both males and females, about the middle of September. From the females of this latter race the eggs are produced which are intended to perpetuate the species for the following year. The parent insects deposit their eggs as near as possible to the branch buds, that the future young may be the more easily supplied with nourishment (as before mentioned); and some continue to lay till the beginning of November. The eggs, at first, are green, but soon become perfectly black: they adhere to the branches by a viscous matter that surrounds them, and remain uninjured by the frost of winter." (*Phil. Trans.*, vol. xli. p. 182.)

It will be seen by the above, that the best time for destroying the aphid is while it remains in the egg state, as, if suffered to breed, it multiplies to a frightful extent. For this purpose, wash the stems and branches of the rose bushes, during winter, with a composition of strong tobacco water and soft soap; or, if this be thought too expensive, with water heated to a temperature of 200° ; in both cases, cleaning the branches, after the composition or hot water has been applied, with a small painter's brush. Should this precau-

tionary measure have been neglected, care should be taken to watch for the appearance of the first brood, and, as soon as the insects are perceived, to destroy them with lime or tobacco water, or by fumigation; taking care never to use the nearly boiling water after the buds are expanded, though it will not do the slightest injury before that period. Each succeeding brood being much more numerous than those which preceded it, is more difficult to destroy; till the summer broods, if suffered to appear, completely clothe the young shoots, so as to make them seem nearly three times their natural thickness. In this state, the best remedy is to put $\frac{1}{2}$ lb. of the best strong tobacco into a gallon of hot water, and, as soon as the infusion has become cold, to dip the young shoots into it, letting them remain a few seconds in the water, and, if they are in a very bad state, going over them a second time. After this the shoots should be carefully washed with clean water, and the insect will generally be found to be destroyed. (See *Gard. Mag.*, vol. x. p. 215.) Choice plants may be freed from the aphides by going over the whole plant with a soft brush; laying the infected shoots in the palm of one hand, and brushing off the insects with the other. Pruning is of little use, as the aphides generally attack all the young shoots of a plant at the same time. (See *Encyc. of Gard.*, edit. 1835, p. 1076.) The plants may also be syringed with water in the evening, and then dusted with powdered tobacco leaves, or refuse snuff; or they may be syringed with lime water. The prodigious fecundity of the *Aphis rosæ* almost surpasses belief. "Reaumur has calculated that, in five generations, one aphid may be the progenitor of 5,904,900,000 descendants; and in ordinary seasons, there are ten generations produced on rose bushes in the space of nine months." (See *Encyc. of Gard.*, p. 1076.)

The larva, or grub (*fig. 547. b*), of the lady-bird (*a*) should always be spared by gardeners, as it lives on the aphides. This grub is short and thick, of a blackish purple, spotted with yellow or black, and is very active. A few of these insects would soon clear a tolerably large rosarium of the aphides. The larvæ of several flies (*Syrphus Fr.*) (*c*) are furnished with a singular mouth, armed like a trident, with three points, for transfixing their prey, of which they devour amazing numbers. Small singing birds also destroy great numbers.



The caterpillars of several small moths, though not so destructive as the aphides, also materially injure the buds and young shoots of rose trees. One of these is of a green colour, with a few black hairs scattered on its body: it sews up the tender leaves by means of silken threads, and takes its station within, concealed from all observation. The leaves of the rose tree are often marked, in autumn, on their upper surfaces, in various directions, with broad brown lines, leaving a narrow black one running down the middle. This curious appearance is produced by the small caterpillar of a minute moth (*Microsètia ruficapitèlla Steph.*), which feeds inside the leaf. The caterpillar, when full grown, is nearly two lines long, and of a yellow orange colour, with a brown mark down the back. It lives upon the thickness of the pulp under the epidermis; and the brown mark is caused by the epidermis drying, in consequence of the insect having eaten the substance of the leaf beneath. The black mark is produced by its egesta, or excrement. The caterpillar is full grown about the 24th of October, when it eats its way out of the leaf for the first time, and crawls down the branches and stem, until it has found a convenient place to fix its cocoon. The perfect insect is called the red-headed pygmy by Haworth; and it is so small, that the expansion of its wings measures only two lines and three quarters. (*Ibid.*)

Others, and perhaps the most destructive, of the insect enemies of rose trees are the caterpillars, grubs, maggots, or larvæ, of one of the saw fly tribe (*Tenthredinidæ*), which, when full grown, just before they change into the pupa state, are about half an inch long, and of the thickness of a crow-quill,

with a brown, and sometimes rather glaucous, body, and a black head. These caterpillars are, at first, very small, and look like little brown grubs: they generally begin to appear in the latter end of April, or the beginning of May, when the rose-buds on the young shoots are only partially developed. At this season, the bushes should be looked carefully over, and the insects picked off with the hand. If this should be neglected, two or three buds in every cluster will be destroyed, or become what is commonly called wormeaten, producing only damaged or abortive flowers.

The leaf-cutter bees also frequently attack rose-leaves, out of which they cut circular pieces to serve for lining their cells. *Megachile Willughbiella*, and *M. centuncularis* (fig. 548.) are the kinds that most frequently attack rose trees.

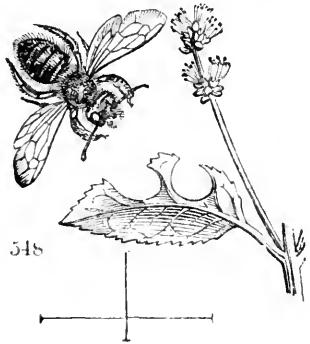

GENUS XII.



LOWEA Lindl. THE LOWEA. *Lin. Syst.* Icosándria Polygýnia.

Identification. Lindl. Bot. Reg., t. 1261.

Synonymy. *Rõsa* sp. Pall. and Lindl. in *Ros. Monog.*

Derivation. In compliment to the Rev. Mr. Lowe, Travelling Bachelor of the University of Cambridge; a gentleman now residing in Madeira, from whose botanical investigations of that island we expect important results. (Lindley in *Bot. Reg.*, t. 1261.)

Generic Character, &c. The genus *Lõwea* has been separated from that of *Rõsa* by Dr. Lindley, for the following reasons; which, independently of their application to this genus, we consider to be extremely interesting and important, in a physiological and systematic point of view. It has always appeared to us, since ever we began to think on the subject, that neither genera nor species ought to be founded upon mere technical differences in any one part of the plant, as the orders and classes are in the Linnæan system; but on all the parts of the plant, and on all the circumstances connected with it, as the orders and tribes are according to the natural system. "It is well known," Dr. Lindley observes, "that, since the days of Linnæus, the characters of the genera of flowering plants have been exclusively taken from the organs of fructification; while those of vegetation have been rigorously excluded. This has arisen from the former having been supposed, in all cases, to be more constant in their modifications, and less subject to variation than the latter. No other reason can be assigned for the value thus exclusively ascribed to the organs of fructification. It is, however, time that botanists should disembarass themselves of this ancient prejudice; and that they should admit publicly that by which they are constantly influenced in private; viz. that important modifications of the organs of vegetation are sufficient to divide into genera species which do not essentially differ in the organs of fructification. Of this the Indian cypripediums are one instance; the genus *Negúndo* is another; and the subject of this article is a third. The structure of the flower of *Lõwea* is, in every part, that of a rose; but its foliage is not even that of a rosaceous plant; there being no trace of stipulæ. The simple leaves are not analogous to the terminal pinna of a rose leaf; for there is no trace of the articulation upon the petiole, which is required to indicate a reduction of a compound leaf, as we find in *Bérberis*; neither can they be considered as confluent stipulæ, for the venation is not what would be found under such circumstances, but precisely that of an ordinary leaf." (*Bot. Reg.*, t. 1261.)

α 1, *L. BERBERIFOLIA* Lindl. The Berberry-leaved Lowea.

Identification. Lindley in *Bot. Reg.*, t. 1261.

Synonymes. *Rosa simplicifolia* *Sal. Hort. Allert.*, 359., *Parad. Lond.*, t. 101., *Olivier's Voyage*, 5. 49. atl. t. 43.; *R. berberifolia* *Pall.* in *Nov. Act. Petr.*, 10. 379. t. 10. f. 5.; *Willd. Sp.*, 2. p. 1063., *Atl. Hort. Kew.*, ed. 2., 3. p. 258., *Smith in Rees's Cyclopædia*, *Redouté Ros.*, 1. 27. t. 2., *Lindl. Rosarum Monog.*, p. 1., French edition, p. 23., *Dec. Prod.*, 2. p. 602., *Spreng. Syst.*, 2. p. 546., *Waltrich Monog.*, p. 25.

Engravings. *Bot. Reg.*, t. 1261.; *Parad. Lond.*, t. 101.; *Olivier's Voyage*, 5. 49. atl. t. 43.; *Nov. Act. Petropol.*, 10. t. 10. f. 5.; *Redouté Ros.*, 1. t. 2.; and our *fig. 549.*

Spec. Char., &c. Leaves undivided, without stipules, obovate-cuneate, serrated at the tip. Prickles decurrent, and of the colour of ivory. Sepals entire, subspatulate. Petals yellow, marked with purple at the base. (*Dec. Prod.*, ii. p. 602.) An undershrub, a native of Persia, near Amadan, where it abounds in saltish soil; and also in fields at the bottom of Mount Elwend, and in the Desert of Soongaria. It was introduced in 1790, grows to the height of 2 ft., and flowers in June and July.



Varieties. Seringe, in *Dec. Prod.*, has characterised three forms of this species under the name of *R. berberifolia* *Pall.*, which we give as varieties of *Lowea*, as follows:—

α *L. b. 1 glabra* Ser.—Prickles upon the stem stipular and scattered. Leaves spatulate.

α *L. b. 2 velutina* Ser.—Stem, prickles, and leaves velvety. Leaves spatulate-lanceolate. Prickles stipular and scattered. A native of Persia.

α *L. b. 3 Redouteana* Ser.: *R. berberifolia* *Red. et Thor. Ros.*, 1. p. 27., with a correct figure, *Lindl. Rosar. Monog.*, 1.; *R. simplicifolia* *Salisb. Prod.*, p. 359.—Prickles scattered, not stipular, numerous. Leaves lanceolate.

Description, &c. The plant of this species in the garden of the London Horticultural Society is an undershrub, with recumbent, slender, and rather intricate branches, and whitish leaves. It rarely flowers; and, in regard to its propagation and culture, Dr. Lindley, in the *Bot. Reg.* for August, 1829, remarks that no more appears to be now known of it, than was at the period of its first introduction in 1790. "It resists cultivation in a remarkable manner, submitting permanently neither to budding nor grafting, nor layering, nor striking from cuttings, nor, in short, to any of those operations, one or other of which succeeds with other plants. Drought does not suit it; it does not thrive in wet; heat has no beneficial effect, cold no prejudicial influence; care does not improve it, neglect does not injure it. Of all the numerous seedlings raised by the Horticultural Society from seeds sent home by Sir Henry Wilcock, and distributed, scarcely a plant remains alive. Two are still growing in a peat border in the Chiswick Garden, but they are languishing and unhealthy; and we confess that observation of them, in a living state, for nearly four years, has not suggested a single method of improving the cultivation of the species." (*Bot. Reg.*, 1261.) These plants still remain without increase: but young plants may be obtained in some of the nurseries, which have been raised from seeds; and at Vienna, as we are informed by Mr. Charles Rauch, it succeeds perfectly by budding on the common dog rose.

Sect. V. ΡΟ'ΜΕÆ Lindl.

GENUS XIII.



CRATÆ'GUS Lindl. THE THORN. *Lin. Syst.* Icosándria Di-Pentagýnia.

Identification. Lindl. in *Lin. Trans.*, 13. p. 105.; *Dec. Prod.*, 2. p. 626.; *Don's Mill.*, 2. p. 598.

Synonymes. *Cratægus* and *Méspilus* sp. of *Lin.* and others; *Néflier*, *Alisier*, and *Aubépine*, *Fr.*; *Doorn*, *Uzbeer*, and *Mispel*, *Ger.*; *Doorn*, *Dutch*; *Spino*, *Ital.*; and *Espino*, *Span.*

Derivation. From *kratos*, strength; in inference to the hardness and strength of the wood.

Description, &c. The species are small deciduous trees or shrubs, mostly natives of Europe and North America, and some of them of Asia and the

north of Africa. One of them, the common hawthorn, is well known, throughout the middle and north of Europe, as a hedge plant. The species all flower and fruit freely; and the wood of all of them is hard and durable, and the plants of considerable longevity. Almost all the flowers are white, and the fruit is generally red; though in some sorts it is yellow, purple, black, or green. All the species ripen fruit in the neighbourhood of London, most of them abundantly; by which, or by grafting, they are generally propagated. When the species, which have naturally a dwarf habit of growth, are intended to assume the character of low trees, they are grafted standard high upon *C. Oxyacantha*, *C. coccinea*, or on some other of the strong-growing kinds; in consequence of which practice, this genus furnishes a greater number of handsome small trees for ornamental grounds than any other ligneous family whatever. All the species will grow on any soil that is tolerably dry; but they will not grow vigorously in a soil that is not deep and free, and rich rather than poor. Whether as small trees or as shrubs, they are all admirably adapted for planting grounds of limited extent; and especially for small gardens in the neighbourhood of large towns. They are not only highly beautiful when in flower (a period which extends from the beginning of April to the end of July, commencing with *C. purpurea*, and ending with *C. cordata*), but also when they are covered with ripe fruit, which includes a period commencing with *C. purpurea* and *C. nigra*, in the beginning of July, and continuing till the following spring or summer; *C. mexicana*, *C. virginica*, and some other species, retaining their fruit all the winter. Of all the genera of hardy deciduous ligneous plants in cultivation in British gardens, there is not one which, taking it altogether, can be compared with the genus *Cratægus*. All the species may be trained either as small, handsome, exceedingly picturesque trees; or as beautiful and picturesque shrubs; at the pleasure of the cultivator. They have all a characteristic, neat, orderly manner of growth; neither so slow as to convey the idea of want of vigour, nor so rapid and robust as to be considered coarse and rambling. Their leaves are remarkably neatly cut, and finely tufted; their flowers appear in masses so abundant, in some species, as almost to cover the plant in the flowering season; and their fruit is produced in as great abundance as their flowers. The colour of the flowers is generally white, and they are mostly more or less fragrant; some of them, as the common hawthorn, being particularly so: their colour, though white at first, yet in some cases, as in that of the common double-flowered hawthorn, dies off of a very fine pink; and there are several pink flowered varieties of the common hawthorn which are strikingly ornamental. The fruit varies in size, from that of *C. spathulata*, which is not much larger than a mustard seed, to that of *C. mexicana*, which is about as large as a golden pippin apple. The colour of the fruit, as already mentioned, is red, yellow, black, or green, and includes many varieties of shade. The fruit of several species, such as *C. Azarolus*, *C. Aronia*, *C. odoratissima*, and *C. tanacetifolia*, are agreeable to the palate; and those of all the species are greedily devoured by singing birds of many kinds, especially the thrush family. Wherever, therefore, it is desirable to encourage singing birds, both as such, and for the good they do in keeping down insects, the genus *Cratægus* ought to be planted. All the species and varieties are exceedingly hardy; and, if there were a demand for them, they might be propagated in as great numbers as the common hawthorn. Most of the species would make excellent hedges; and, were it only the practice, in planting hedges along the sides of the public highways, to introduce here and there, as standards, thirty or forty sorts, which might be raised from seed, the ornament to the country would be such as those only can form an idea of who have seen the collections of *Cratægus* at White Knights near Reading, or at Courset near Boulogne, when the trees are in flower, and when they are in fruit. Finally, if a man were to be exiled to an estate without a single tree or shrub on it, with permission to choose only one genus of ligneous plants to form all his plantations, shrubberies, orchards, and flower-gardens, where would he find

a genus that would afford him so many resources as that of *Cratæ'gus*? The most complete collection of thorns in England is that in the arboretum of Messrs. Loddiges, where we examined, on June 18th, 1836, plants of nearly 80 sorts, all of which appeared to us to be distinct. There are only two or three kinds, that we know of, in England, not included in this collection, viz. *C. orientalis* var. *Leeana*, some varieties of *C. Oxyacantha*, and, perhaps, a few Nepal seedlings in the Horticultural Society's Garden, which may, probably, prove to belong to this genus. We shall give Messrs. Loddiges's list, together with our synonymes, in an Appendix, for the use of intended collectors or purchasers. There is a collection at Somersford Hall, in Staffordshire, nearly as complete as that of Messrs. Loddiges, which was made by General Monckton, who, like ourselves, is an enthusiastic admirer of this genus. The best collections in Scotland are in the Edinburgh Botanic Garden, and in Lawson's Nursery. At Terenure, near Dublin, the seat of Frederick Bourne, Esq., also an enthusiastic admirer of the genus, there is a collection almost as numerous as that of Messrs. Loddiges, selected by Mr. Bourne, personally, from almost all the principal nurseries in Europe. The best collection of full-grown trees of this genus, in England, is at White Knights; and of full-grown trees, in France, at Courset. The greatest number of species in one garden, in France, is, or was in 1828, in the Pépinière de Luxembourg. There are, also, good collections in the nurseries of MM. Audibert, at Tarascon; and of MM. Baumann, at Bollwyller. The best collection in Belgium is at Humbeque, near Brussels; and the best in Germany are those in the Floetbeck Nurseries at Hamburg, and in the Göttingen Botanic Garden. In Poland there was formerly a tolerably good collection in the Botanic Garden at Warsaw; and there is still a considerable number of species in the arboretum of Count Wodzicki, at Niezdsviedz, in the neighbourhood of Cracow, of which some account will be found in the supplement to the present volume. In Russia, in the Government Garden of Odessa, now under the care of M. le Chevalier Descemet, conseiller de cour, who was formerly a nurseryman at St. Denis, near Paris, there is a collection of 45 sorts, chiefly planted since 1820. In America, judging from the nurserymen's catalogues, the greatest number of sorts appears to be in Prince's Nursery, near New York; but the finest specimens are in Bartram's Botanic Garden, and at the Woodlands, and other places in the neighbourhood of Philadelphia.

The genus *Cratæ'gus* did not excite much attention till the commencement of the present century; since which period the number of sorts has been more than doubled, chiefly through the exertions of Messrs. Loddiges. From the excellent collection in the arboretum at Hackney, and from the duplicates of it in the Horticultural Society's Garden, almost all the species having fruited, we have been enabled to study the different sorts of this genus much more satisfactorily than those of most of the other genera we have treated on in this work; and we give the following enumeration, perfectly satisfied that the different kinds we have named are distinct; though we are by no means certain of what are entitled to be considered species, and of what are only varieties. Neither have we pretended to give strict definitions of either species or varieties; deeming such definitions, even when more correct than we could make them, of comparatively little use in practice. If definitions fully answered the end intended by them, there would not have been the confusion of names which now exists in every genus, except in those, all the species of which have been seen in a living state together, by one or by several botanists.

In classing the species of this genus, as in the case of most others, there are two modes which may be adopted. By one, the different sorts may be arranged in sections, according to some technical distinction, such as the size of the fruit, or that of the leaves; the entireness, or degree of incision, of the latter, &c.; and by the other mode the kinds may be thrown into natural groups, according to the majority of their points of resemblance. We have

adopted the latter mode, though, perhaps, not always the easiest for discovering the name of a single species; because, when once the species are known which form the types of the different groups, it will be found preferable to the other mode, both for ascertaining the names, and for studying the plants, and impressing their characters and images on the memory. In order, however, that our readers may have the benefit of both modes, we shall give, as an appendix to this genus, a technical classification of the species and varieties as drawn up for us by Mr. Gordon (a descendant of the brother of the celebrated Mile End nurseryman of that name), the foreman of the arbo-riticultural department in the London Horticultural Society's Garden.

The price of dwarf plants of almost all the species (except *C. Oxyacantha*), in the London nurseries, is 1s. 6d. each; and of standards, 2s. 6d.: at Bollwyller, 1 franc, or 1 franc and 50 cents; and standards, 2 or 3 francs: at New York, the price varies from 25 to 50 cents. If there were such a demand for the plants as we think there ought to be, seedlings of most of the species might be sold at about treble the price of the seedlings of the common thorn used in hedgemaking. (See *C. Oxyacantha*.)

§ i. *Coccinea*.

Sect. Char., &c. Leaves cordate, lobed, acutely serrated. Flowers and fruit large. The plants also large, and of free and vigorous growth.

‡ 1. *C. COCCINEA* L. The scarlet-fruited Thorn.

Identification. Lin. Sp., 682; Pursh Amer. Sept., 1. p. 337.; Dec. Prod., 2. p. 627.; Don's Mill., 2. p. 599.

Synonyms. *C. æstivalis* Booth; *Mespilus æstivalis* Wall. *Fl. Car.*; *M. coccinea* Mill., *Nouv. Du Ham.*; thornless American Azarole; Néflier écarlate, *Fr.*; scharlachrothe Mispel, *Ger.*

Engravings. Pluk., t. 46. f. 4.; Dend. Brit., t. 62.; Bot. Mag., t. 3432.; our fig. 564. in p. 851.; and the plate in our Second Volume.

Spec. Char., &c. Disks of leaves cordate-ovate, angled with lobes, acutely serrated, glabrous. Petioles and calyxes pubescent, glanded. Petals orbiculate. Styles 5. Fruit scarlet, eatable. (*Dec. Prod.*, ii. p. 627, 628.) A tree growing to the height of 15 ft. or 20 ft.; a native of North America, from Canada to Carolina, in hedges and woods; and, in May and June, producing its white flowers, which are succeeded by large scarlet haws, round, or somewhat pear-shaped, which ripen in September. In Britain, into which country this tree was introduced in 1683, it grows rapidly to the height of 20 ft. (or, in good soils, and sheltered situations, to 30 ft. or upwards), with a large upright trunk, dividing into many strong, irregular, smooth branches, so as to form a head of greater breadth than the entire height of the tree, in most varieties; though in others the head is more compact and fastigiata. Some of the plants are entirely without spines; and, in most, they disappear with age: among a number of seedlings, however, some will be found with spines of extraordinary dimensions, of which there is a remarkable example in a specimen plant, 10 ft. high, in the Fulham Nursery. The leaves are often 4 in. or 5 in. long, and 3 in. or 4 in. broad, particularly in the variety called *C. c. maxima*; of a pale green, and cut in the edges in a sharp shreddy manner, which gives them somewhat the appearance of being fringed. Both the leaves and fruit vary exceedingly in size, in plants raised from seed. The seedling plant before referred to, in the Fulham Nursery, has leaves twice as large as those of the grafted plant in the Horticultural Society's collection.

Varieties. It would be easy to procure as many varieties of this species as there are of the common hawthorn, by raising some thousands of plants every year from seed, and selecting from the seed-beds plants indicating any peculiarity of leaf, or of habit; but as, in the nurseries, the most rapid way of producing saleable plants of this, and all the other species and varieties of *Cratægus*, is found to be by grafting on the common hawthorn, very few seedlings are raised, and the varieties in cultivation are only the three or four following:—

- ‡ *C. c. 2 corállina*. *C. corállina* Lodd. *Cat.*; the *C. pyriformis* of some collections. (*fig. 565.* in p. 852.)—The leaves, and the entire plant, are, perhaps, rather smaller than in the species; the habit of the tree is decidedly more upright and fastigiata; and the fruit is smaller, long, and of a fine coral red; whence the name is probably derived, though, in the first edition of the Horticultural Society's *Catalogue*, it is called the red-branched hawthorn. The plants at Messrs. Loddiges's, however, exhibit only a slight degree of redness in the branches of the young wood.
- ‡ *C. c. 3 indentata*. *C. indentata* Lodd. *Cat.* (*fig. 566.* in p. 852.)—The leaves are smaller, and less lobed, than those of the species; the plant is, also, weaker, of upright habit, and with a smooth clear bark.
- ‡ *C. c. 4 máxima* Lodd. *Cat.* *C. c. spinosa* Godfrey; *C. ? flabellata* Hort.—The leaves are larger than those of any other variety; and the fruit is also large. As we have not seen living plants of *C. flabellata*, but only dried specimens sent from Tereure and the Humbeque Nursery, we are not absolutely certain that *C. flabellata* and *C. c. máxima* are the same; but we feel quite certain that they both belong to *C. c. coccinea*. We are informed that the *C. flabellata* of some nurseries is *C. tanacetifolia*; which certainly has its leaves more flabellate, or fan-like, than any variety of *C. coccinea*.

Statistics. The general rate of growth of *C. coccinea*, in the environs of London, is 10 ft. in 5 years, or 20 ft. in 10 years. There are old trees, between 20 ft. and 30 ft. high, at Syon, at Purser's Cross, at Kew, and at Ham House. In Kensington Gardens, a little to the right of the north entrance, there is a tree 20 ft. high, with diameter of the head 30 ft., and of the trunk 14 in. In Gloucestershire, at Doddington, 30 years planted, the tree is 20 ft. high, the diameter of the trunk being 16 in., and of the head 20 ft. In Lancashire, at Latham House, 14 years planted, it is 19 ft. high. In Worcestershire, at Croome, 25 years planted, it is 25 ft. high; at Hagley, 12 years planted, and 20 ft. high. At Yorkshire, at Grimston, 14 years planted, and 25 ft. high. In Scotland, in Ross-shire, at Brahan Castle, 26 ft. high. In Ireland, in the neighbourhood of Dublin, at Tereure, 25 ft. high; and at Oriel Temple, 23 ft. high. In France, in the Jardin des Plantes, it is 30 ft. high; at Nantes, in the nursery of M. De Nerrières, 20 ft. high. In Saxony, at Würnitz, 56 years planted, and 30 ft. high. In Austria, at Vienna, in the University Botanic Garden, 20 ft. high. In Prussia, in the Pfauen Insel, 20 years planted, and 10 ft. high. In Bavaria, at Munich, in the Botanic Garden, 24 years planted, and 20 ft. high. In Hanover, at Göttingen, in the Botanic Garden, 20 years planted, and 16 ft. high. In Italy, at Monza, 24 years planted, and 20 ft. high.

‡ 2. *C. GLANDULO'SA* W. The glandular Thorn.

Identification. Willd. Sp., 2, p. 1062., not of Michx.; Pursh. Amer. Sept., 1, p. 337.; Dec. Prod., 2, p. 67.; Don's Mill., 2, p. 599.

Synonymes. ? *C. sanguinea* Pall. *Fl. Ross.*, 1, t. 11.; ? *Méspilus rotundifolia* Ehrh. *Beitr.*, 3, p. 20.; *Pyrus glandulosa* Muench; *C. rotundifolia* Booth.

Engravings. ? Pall. *Fl. Ross.*, 1, t. 11.; Lod. Bot. Cab., t. 1012.; Dend. Brit., t. 58.; our *fig. 567.* in p. 853.; and the plate of this species in our Second Volume.

Spec. Char., &c. Leaves with the disk obovate-wedge-shaped, angled, glabrous, glossy. Petioles, stipules, and sepals glanded. Fruit oval, scarlet; nuts 4—5; flesh hard and dry. (*Dec. Prod.*, ii, p. 627.) A tree, a native of North America, in Canada and on the Alleghany Mountains, and also found on the Rocky Mountains. It was introduced into England in 1750, and forms a low, compact, bushy-headed tree, seldom exceeding 12 ft. or 15 ft. in height. It differs from the preceding sort in the stipules and calyxes being glandular, and in the head of the tree forming a dense mass of small twigs. This last circumstance, taken together with the size of the leaves and fruit, induces us to think that it may be only a stunted variety of *C. coccinea*. This might be tested by sowing its seeds, which are ripened about the same time as those of *C. coccinea*, and observing what kind of plants were produced. If several of these turned out to be *C. coccinea*, our conjecture would be confirmed. This sort of *Cratægus* being a small compact tree, of rather a fastigiata habit, and of comparatively slow growth, and yet being very prolific in its flowers and fruit, is well adapted for small gardens; and, if it comes true from seed, it would form the next best hedge plant to *C. Oxyacantha*. There are specimens of this tree at White Knights, which, in 25 years, have attained the height of 14 ft.; and at Croome, which, in 30 years, have attained the height of 25 ft.

Varieties.

- ‡ *C. g. 2 succulenta* Fisch., *Méspilus succulenta* Booth, has the fruit larger than that of the species, and succulent, juicy, and eatable. We have seen only one plant of this variety; but we are assured by our friend M. Fischer of Göttingen, that there are several in the botanic garden under his care, and in various other collections in Germany. The name is in the catalogue of Messrs. Booth of Hamburg. 550
- ‡ *C. g. 3 subvillòsa*, *C. subvillòsa* Fisch., (fig. 550., and fig. 568. in p. 853.) is apparently another variety of the preceding sort, or, perhaps more properly, of *C. coccinea*. It is very distinct in appearance, from its villous twisted leaves, and stunted tortuous shoots; but, from its having been only three or four years in the country, very little is known of its habit of growth, which seems to be rather more loose than that of *C. glandulosa*. There is a plant of this species, in the Horticultural Society's Garden, 5 ft. high, which last year ripened haws; and there is one, also, in Messrs. Loddiges's arboretum.

§ ii. *Punctatæ.*

Sect. Char. Leaves not lobed, large, with many nerves. Bark white, or ash-coloured. Fruit large, or small.

‡ 3. *C. PUNCTATA* Ait. The dotted-fruited Thorn.

Identification. Ait. Hort. Kew., 2. p. 169.; Jacq. Hort. Vind., 1. and 28.; Pursh Fl. Amer. Sept., 1. p. 338.; Dec. Prod., 2. p. 627.; Don's Mill., 2. p. 598.
Synonymes. *C. Crús-galli Du Roi*; *Méspilus cuneifolia Ehrh. Beitr.*, 3. p. 21.; *M. punctata Link Enum.*; *M. cornifolia Lam. Encyc.*, 4. p. 44.
Engravings. Jac. Hort., 1. t. 23.; our figs. 569. and 570. in p. 854.; and the plate in Vol. II.

Spec. Char., &c. Leaves obovate-wedge-shaped, glabrous, serrated. Calyx a little villose; its sepals awl-shaped, entire. Fruit usually dotted. (*Dec. Prod.*, ii. p. 627.) A tree, a native of North America, in the woods and swamps of Virginia and Carolina; where, according to Pursh, it grows to a handsome size, particularly the variety having yellow fruit. It was introduced into England in 1746; and, having been very generally planted, is now frequent in collections. The wood is so hard that the Indians of the west coast of America make wedges of it for splitting trees. The flowers are white, and appear in May and June; and the fruit, which, in general, is larger than that of *C. coccinea*, ripens in September, and drops, with the leaves, in November or December.

Varieties. There are three forms of this species in British gardens.

- ‡ *C. p. 1 rubra* Pursh, *C. edulis* Ronalds, (fig. 569. in p. 854.) is the most common, and is a spreading tree, growing to the height of from 15 ft. to 30 ft., with red fruit, and, when old, with few thorns.
- ‡ *C. p. 2 rubra stricta* Hort., *C. p. stricta* Ronalds, has the fruit red, like the preceding sort; but the general habit of the plant is fastigiata, like that of the following sort.
- ‡ *C. p. 3 aurea* Pursh; *C. p. flava* Hort., *C. dulcis* Ronalds, *C. edulis*, *Lodd. Cat.*, *C. pentagyna flava* Godfrey, (fig. 570. in p. 854.) is a fastigiata-growing tree, with yellow fruit, and also, when old, with few thorns.

Statistics. In the environs of London, at Syon, this tree is 31 ft. high; and at Ham House it is 31 ft. high. In Berkshire, at White Knights, 28 years planted, it is 20 ft. high. In Worcestershire,

at Croome, 25 years planted, it is 18 ft. high. In Ireland, at Orle Temple, 40 years planted, it is 30 ft. high, the diameter of the trunk 1 ft. 4 in., and of the head 34 in. In France, in the Jardin des Plantes, 35 years planted, and 25 ft. high. In Saxony, at Wörlitz, 35 years planted, and 20 ft. high. In Italy, at Monza, 24 years planted, and 20 ft. high.

‡ 4. *C. PYRIFO'LIA Ait.* The Pear-tree-leaved Thorn.

Identification. Ait. Hort. Kew., 2, p. 168.; Pursh Fl. Amer. Sept., 1, p. 337.; Dec. Prod., 2, p. 627.; Don's Mill., 2, p. 599.

Synonymes. *C. leucophloë'os* (white-barked) *Mench Weiss.*, p. 31. t. 2.; *C. radiata* *Lodd. Cat. edit.* 1836.; *C. tomentosa* *Du Roi Harbk.*, 1, p. 183.; *Méspilus latifolia* *Lam. Encyc.*, t. p. 444.; *M. Calpodendron* *Ehrh. Beitr.*; *M. pyrifolia* *Link Enum.*; *M. cornifolia* *Poir.*; *C. latifolia* *Ronalds*; *C. cornifolia* *Booth.*

Engravings. *Mench Weiss.*, p. 31. t. 2.; *Wats. Dend. Brit.*, t. 61.; *Bot. Reg.*, t. 1877.; our *fig.* 571. in p. 854.; and the plate of the species in our Second Volume.

Spec. Char., &c. In some instances spiny, in some without spines. Leaves ovate-elliptical, incisely serrated, obscurely plaited, a little hairy. Flowers 3-styled. Calyx slightly villose; its sepals linear-lanceolate, serrated. (*Dec. Prod.*, ii. p. 627.) The leaves of young trees are larger, and the fruit smaller, than those of most other species; the leaves are also more strongly plaited, having the appearance of being furrowed from the midrib to the margin. A native of woods and rocky places in North America, from Pennsylvania to Carolina. In Britain, this species forms a low tree, generally spineless, and of less compact growth than most other species, about 20 ft. or 25 ft. high: it is rather later in flowering than the preceding species; but it is very prolific in flowers; and these are succeeded by fruit, small, and of a yellowish red, which ripen early in September, and are more eagerly sought after by birds than those of any other species. When the fruit, which is of an orange colour, is not eaten by birds, it shrivels, turns black, and remains on the tree throughout the winter. It was introduced into England in 1765; and flowers in June.

Statistics. In Kensington Gardens, to the right of the Bayswater gate, there is a tree, upwards of 20 ft. high, which is profusely covered with flowers every year; in Somersetshire, at Hinton House, 18 years planted, it is 20 ft. high; in Surrey, at Bagshot Park, 20 years planted, it is 12 ft. high; in Lancashire, at Latham House, 12 years planted, it is 18 ft. high; in Pembrokehire, at Golden Grove, 30 years planted, it is 20 ft. high; in Worcestershire, at Hagley, 14 years planted, it is 22 ft. high, diameter of trunk 9 in., and of the head 18 in.; in Yorkshire, at Grimston, 14 years planted, it is 22 ft. high. In Scotland, at Edinburgh, in the Botanic Garden, 10 years planted, it is 18 ft. high; in Perthshire, at Kinfauns Castle, 15 years planted, it is 12 ft. high. In France, in the Jardin des Plantes, 35 years planted, and 25 ft. high. In Saxony, at Wörlitz, 35 years planted, it is 16 ft. high. In Italy, at Monza, 24 years planted, it is 18 ft. high.

§ iii. *Macracántha.*

Sect. Char. Leaves large, ovate-oblong, slightly lobed and serrated, with numerous nerves, and subplicate. Fruit small. Spines very long. Tree vigorous and spreading.

‡ 5. *C. MACRACA'NTHA Lodd. Cat.* The long-spined Thorn.

Synonymie. *C. spina longissima* in the Hammersmith Nursery.

Engravings. *Fig.* 572. in p. 855.; and the plate of this species in our Second Volume.

Spec. Char., &c. Spines long and numerous. Leaves ovate-oblong, somewhat acuminate, slightly lobed and bluntly serrated, nerved, and subplicate. Fruit small, or middle-sized, of a shining red, and very succulent when ripe. Tree spreading, and of very vigorous growth. The shoots straight, and tending upwards at an angle of 45°. A native of North America; and, in Britain, raised from seed, in 1819, in the nursery of Messrs. Falla, at Gateshead, near Newcastle; whence it was sent to the Edinburgh Botanic Garden, under the name of the large American azarole. It was sent, by Mr. Macnab, to the Garden of the London Horticultural Society, about 1825. This species promises to become a large and vigorous tree; and it seems to be distinct from any of the other large-leaved kinds; though, from the appearance of its spines, it may possibly belong to *C. Crús-gáli*.

Variety.

‡ *C. m. 2 minor* (*fig.* 573. in p. 855.) only differs from the species in having smaller fruit. There are plants at Somerford Hall.

§ iv. *Crus-galli*.

Sect. Char. Leaves without lobes, obovate-oblong or obovate-lanceolate, more or less serrated, and of a dark shining green, with petioles margined by the decurrence of the leaf. Fruit small, or middle-sized, round, dark green till nearly ripe, and, when ripe, scarlet. Spines very long, and bent like the spur of a cock.

‡ 6. *C. CRU'S-GA'LLI* L. The Cock's-spur Thorn.

Identification. Lin. Sp., p. 632.; Dec. Prod., 2. p. 626.; Pursh Fl. Amer. Sept., 1. p. 338.; Don's Mill., 2. p. 598.

Synonymes. *Crataegus lucida* Wang. Am., t. 17. f. 42.; *C. cuneifolia* Lodd. Cat.; *Mespilus lucida* Ehrh. Beitr.; *M. Crus-galli* Poir.; *M. hyemalis* Walt.; *M. cuneifolia* Mench; Néfier Pied de Coc, Fr.; glänzende Mispel, Ger.

Engravings. Wang. Am., t. 17. f. 42.; Dend. Brit., t. 56.; fig. 574. in p. 856.; and the plate of the species in our Second Volume.

Spec. Char., &c. Spines long. Leaves obovate-wedge-shaped, nearly sessile, glossy, glabrous, falling off late. Stipules linear. Lobes of the calyx lanceolate, and somewhat serrated. Styles 2. Fruit scarlet. (*Dec. Prod.*, ii. p. 626.) A native of North America, and common in woods and hedges, and on the banks of rivers, from Canada to Carolina; where it flowers in April and May, and ripens its small scarlet fruit in September and October. It was introduced into England in 1691; and has been more generally cultivated than any other of the American species. It grows to the height of 15 ft. or 20 ft., and sometimes higher. In its native country, according to Pursh, it is found in the three forms of *C. C. splendens*, *C. C. pyracanthifolia*, and *C. C. salicifolia*; to which, by cultivation, in Europe, several other varieties have been added. In the south of England, in warm sheltered situations, this species is subevergreen, retaining its leaves and fruit throughout the winter. There is a splendid specimen of it, which assumes this character, on the lawn in front of the mansion of Sketty Hall, near Swansea, the seat of that well-known botanist, L. W. Dillwyn, Esq., M. P.

Varieties.

‡ *C. C. 2 splendens* Dec. Prod., Ait. Hort. Kew., ii. p. 170., Pluk., t. 46. f. 1. *C. arbutifolia* and *C. splendens* Lodd. Cat. (*fig. 575.* in p. 856.)—Leaves obovate-wedge-shaped, and shining; and, being produced in abundance, the plant has a splendid appearance.

‡ *C. C. 3 pyracanthifolia* Dec. Prod., Ait. Hort. Kew., ii. p. 170. *C. pyracanthifolia* Lodd. Cat.; *Mespilus lucida* Dum. Cours. Bot. Cult., ed. 2. v. p. 448. (*fig. 580.* in p. 856.; and the plate in our Second Volume.)—Leaves oblong, with the upper part lanceolate; the lower part tending to wedge-shaped. This, even when only 3 or 4 years grafted, forms a singular little old-looking tree, spreading like a miniature cedar of Lebanon.

‡ *C. C. 4 salicifolia* Dec. Prod., Ait. Hort. Kew., ii. p. 170. *C. salicifolia*, (*fig. 578.* in p. 856., and the plate in our Second Volume.)—Leaves oblong, with the upper part lanceolate; the lower part tending to wedge-shaped. This forms a low flat-headed tree, like the preceding variety, as shown in *fig. 551.*; which is a portrait of a plant in Messrs. Loddiges's arboretum, that, in 1835, after being five years grafted at a foot from the ground, was not quite 5 ft. high. There were, at the same time, several other miniature trees of this



551



552

variety; some of them (such as *fig. 552.* to a scale of 2 in. to a foot, of which *fig. 553.* is a geometrical section to the same scale) not above 2 ft. high, and others from that height to 15 ft.; all of them bearing the same general character of a stunted cedar of Lebanon, like those in the Chelsea Botanic Garden, figured in a succeeding page. The miniature trees of this variety are admirably adapted for children's gardens.



‡ *C. C. 5 linearis* Dec. Prod. *Mespilus linearis* Desf. *Arb.*, ii. p. 156., *Poir. Suppl.*, iv. p. 70.; *C. linearis* Lodd. *Cat.* (*fig. 577.* in p. 856.)—Leaves linear-lanceolate. Spines, or thorns, few, and shortish. Styles 1—2. Fruit of a yellowish red.

‡ *C. C. 6 nana* Dec. Prod. *Mespilus nana* Dum. *Cours. Suppl.*, p. 386.—Branchlets tomentose in some degree. Leaves oval-lanceolate; the under surface paler than the upper. A shrub, or, when trained to a single stem, a miniature tree, as in *fig. 552.*

‡ *7. C. (C.) OVALIFOLIA* Horn. The oval-leaved Thorn.

Identification. Hornem. Hort. Hafn. *Suppl.*, 52.; Dec. Prod., 2. p. 627.; Don's Mill., 2. p. 596.

Synonymes. *C. elliptica* Lodd. *Cat.*; *C. Crús-gállii ovalifolia* Bot. Reg., t. 1860.

Engravings. Bot. Reg., t. 1860.; our *fig. 579.* in p. 856.; and the plate of this species in our Second Volume.

Spec. Char., &c. Leaves oval, serrated, a little pilose on both surfaces, and shining on the upper one. Stipules half-heart-shaped, incisely serrated, with glanded serratures. (*Dec. Prod.*, ii. p. 627.) A native of North America; and, according to Horneman, akin to *C. Crús-gállii*. (*Ibid.*) We feel convinced, indeed, that it is only a variety of that species. We allow, however, that it is very distinct; it being furnished with very few thorns, and having that loose spreading habit of growth which is characteristic of most of the varieties; for which reason, and, also, in order to allow those who differ from us in opinion still to recognise it as a species, we have given the details in the specific form. A plant of this sort, at Croome, in Worcestershire, 25 years planted, is 25 ft. high.

‡ *8. C. (C.) PRUNIFOLIA* Bosc. The Plum-leaved Thorn.

Identification. Bosc. *ined.*; Dec. Prod., 2. p. 627.; Don's Mill., 2. p. 598.

Synonymes. *Mespilus prunifolia* Poir. *Dict.*, 4. p. 443.; *C. caroliniana* Lodd. *Cat.*

Engravings. Bot. Reg., t. 1868.; our *fig. 576.* in p. 856.; and the plate of this tree in our Second Volume.

Spec. Char., &c. Leaves with the disk broadly ovate, unequally serrated, and glabrous; the petioles bearing a few glands. Sepals with glanded serratures. Peduncle and calyx a little villose. Seeds 2 in a pome. (*Dec. Prod.*, ii. p. 627.) A native of North America. This sort we consider also as only a variety of *C. Crús-gállii*; and it differs from the preceding one in having broader and shorter leaves, a more compact and fastigate habit of growth, and rather more thorns on the branches. The leaves of this and the preceding kinds die off of a much deeper red than the narrow-leaved varieties, which often drop quite green, yellow, or of a yellowish red.

Variety.

C. (C.) p. 2 ingestria, *C. ingestria* Lodd. *Cat.*, differs very little from the species. It was raised from seed, at Ingestrie, in Staffordshire, a few years ago; and is known, in some collections, as the Ingestrie thorn. There are plants at Messrs. Loddiges, and a tree in the collection at Somerford Hall, in Staffordshire.

Statistics of C. Crús-gállii and its Varieties. In the environs of London, *C. Crús-gállii splendens*, at Ham House, is 20 ft. high, the diameter of the trunk 16 in., and of the head 23 ft. Near the Fulham Nursery, the species, 30 years planted, is 30 ft. high; at Syon it is 20 ft. high, the diameter of the trunk 14 in., and of the head 29 ft.; the branches on every side being pendent to the ground. (See the plate of this tree in our Second Volume.) In the Surrey Zoological Gardens there is a fine specimen of *C. C. salicifolia*, which overhangs the water; there is also a large tree of this variety at Wimbledon House. In the Horticultural Society's Garden, and at Messrs. Loddiges's, *C. C. ovalifolia* and *C. C. prunifolia* are 15 ft. high. In Dorsetshire, at Melbury Park, 40 years planted, the species

is 24 ft. high, and the diameter of the head 28 ft. In Sussex, at West Dean, *C. C. splendens*, 15 years planted, is 13 ft. high, the diameter of the trunk 6 in., and of the head 21 ft. In Bedfordshire, at South-hill, 22 years planted, the species is 18 ft. high. In Berkshire, at White Knights, *C. C. salicifolia*, 35 years planted, is 20 ft. high, the diameter of the trunk 7 in., and of the head 26 ft. In Gloucestershire, at Dodington, 9 years planted, the species is 10 ft. high, the diameter of the trunk 7 in., and of the head 28 ft. In Hertfordshire, at Cheshunt, *C. C. salicifolia*, 15 years planted, is 21 ft. high, the diameter of the trunk 9 in., and of the head 26 ft. In Oxfordshire, at Oxford, in the Botanic Garden, 40 years planted, the species is 30 ft. high. In Staffordshire, at Trentham, *C. C. pyracanthifolia*, 21 years planted, is 20 ft. high. In Suffolk, at Livermere, 35 years planted, the species is 26 ft. high, the diameter of the trunk 1 ft. 14 in., and of the head 35 ft. In Yorkshire, at Grimston, 14 years planted, it is 20 ft. high. In Scotland, in Argyllshire, at Toward Castle, 10 years planted, it is 12 ft. high; in Perthshire, at Kinfauns Castle, 15 years planted, 12 ft. high; in Ross-shire, at Brahan Castle, 20 ft. high. In Ireland, at Dublin, in the Glasnevin Garden, *C. C. salicifolia*, 35 years planted, is 15 ft. high, the diameter of the trunk 9 in., and of the head 32 ft. In Galway, at Cool, the species is 21 ft. high, the diameter of the trunk 9 in., and of the head 25 ft.; in Louth, at Oriel Temple, 35 years planted, and 21 ft. high, the diameter of the trunk 1 ft. 3 in., and of the head 25 ft. In France, in the Jardin des Plantes, there is an avenue of *C. C. linearis*, averaging 15 ft. high. In Saxony, at Wörlitz, the species, 35 years planted, is 20 ft. high. In Italy, at Monza, the species, 24 years planted, is 16 ft. high; *C. C. linearis*, 24 years planted, is 12 ft. high; and *C. C. pyracanthifolia*, 8 years planted, is 10 ft. high.

§ v. *Nigra*.

Sect. Char. Leaves middle-sized, deeply lobed. Lobes pointed. Fruit round, black, or purple. Tree rather fastigate, with few or no spines. Bark smooth.

♀ 9. *C. NIGRA* *Waldst. et Kit.* The black-fruited Thorn.

Identification. Waldst. et Kit. Pl. Rar. Hung., t. 61.; Dec. Prod., 2. p. 628.; Don's Mill., 2. p. 599.

Synonymes. *Mespilus nigra* Willd. *Enon.*, 524.; *C. carpatica* Lodd. *Cat.*

Engravings. Waldst. et Kit. Pl. Rar. Hung., t. 61.; fig. 581. in p. 857.; and the plate of this species in our Second Volume.

Spec. Char., &c. Leaves sinuately lobed, and serrated, somewhat wedge-shaped, though truncately so, at the base; whitely villose beneath. Stipules oblong, serrately cut. Calyxes villose; the lobes slightly toothed. Styles 5. Fruit black. (*Dec. Prod.*, ii. p. 628.) A native of Hungary, where it forms a large bush, of 15 ft. or 20 ft. in height, throwing up numerous suckers from its widely spreading roots, which soon cover the ground with a forest of plants. In England, where it is generally propagated by grafting on the common thorn, it forms a very handsome, upright, somewhat fastigate tree, from 20 ft. to 30 ft. high, putting forth its leaves, in mild seasons, in February or March; flowering in April or May; and ripening its fruit in July and August. Nightingales are said to be attracted by this tree, probably because it is particularly liable to be attacked by insects, and because numerous caterpillars are to be found on it, about the time when the nightingale is in full song. It was introduced in 1819; and there are large and handsome specimens of it in the Garden of the Horticultural Society, and at Messrs. Loddiges's. There is also, in Sussex, at West Dean, a tree, 14 years planted, which is 19 ft. high; and one in the Botanic Garden, Edinburgh, 10 years planted, which is 15 ft. high.

♀ 10. *C. PURPU'REA* *Bosc.* The purple-branched Thorn.

Identification. Bosc. *ined.*; Dec. Prod. 2. p. 628.; Don's Mill., 2. p. 599.

Synonyme. *C. sanguinea* *Hort.*

Engravings. Wats. *Dend. Brit.*, t. 60.; our fig. 582. in p. 857.; and the plate of this species in our Second Volume.

Spec. Char., &c. Branches dark purple. Leaves ovate, cuneate at the base, lobed with broad lobes, serrated, glabrous, or pubescent beneath. Stipules somewhat circular, serrated with glanded serratures. (*Dec. Prod.*, ii. p. 628.) The native country of this species, according to De Candolle, is unknown; but, as we consider it to be nothing more than another form of *C. altaica*, we conclude it to be indigenous in the Altaic Mountains. It has been in cultivation in England since 1822, and flowers early in April; being the very first species of *Cratægus* that comes into flower in the neighbourhood of London, excepting always the Glastonbury thorn. It forms an upright, rigid, rather slow-growing tree, without thorns; it has a few small branches, and is not densely clothed with leaves. It has a starved and somewhat stunted appearance, and is readily known by the purple colour of its young shoots. The bark of the old wood is of a dark purple

or brown colour, and rough and scaly; the fruit is small, round, and most commonly of a dark purple; but it varies to pale yellow, or a milk white, and red, on the same plant. It ripens about the end of July, and is very soft and juicy, but soon drops off. The tree is interesting from its early flowering, and the dark colour of the anthers of its flowers, which contrasts strongly with the whiteness of the petals. The leaves are also large, and of a peculiar shape. (See p. 857.)

Variety.

‡ *C. p. 2 altàica*, *C. altàica* Led., *Lod. Cat.*, (fig. 583. in p. 858.) has the leaves somewhat more deeply lobed and finely serrated than those of the species.

§ vi. *Douglàsii*.

Sect. Char. Leaves small, and not lobed as in the preceding section; furnished with numerous parallel nerves, somewhat like those of *C. punctàta*. Spines rather numerous and rigid. Fruit small, and dark purple; pulp soft and watery.

‡ 11. *C. DOUGLA`SII* Lindl. Douglas's Thorn.

Identification. Bot. Reg., t. 1810.; Lodd. Cat., edit. 1832.

Synonyme. *C. punctàta* var. *brevispina* Douglas in Hook. *Fl. Bor. Amer.*, 1. p. 202.

Engravings. Bot. Reg., t. 1810.; our fig. 584. in p. 858.; and the plate of the species in our Second Volume.

Spec. Char., &c. A small tree. Branches ascending. Spines rigid, straightish, now short, now very long. Leaves some obovate, some oval, gashedly serrated, acute; at the base wedge-shaped, glabrous; in the autumn, remarkably leathery, and they then acquire a purplish cast, and are shining: they fall off at about the same time as those of *C. punctàta* and of *C. pyrifolia*. Flowers produced in May, and are of a middling size. Fruit small, and dark purple. (*Bot. Reg.*, t. 1810.) This is a very distinct sort, more particularly as it respects the colour of the fruit, and the colour and texture of the leaves. The general habit of the plant is fastigate; and it is one of the latest kinds in leafing in the spring. The flowers and fruit are produced in great abundance, and both are very ornamental. The fruit is very soft and juicy, and ripens early in August, but soon drops off.

§ vii. *Flàvæ*.

Sect. Char. Leaves small, obovate, slightly lobed, and serrated. Flowers frequently solitary. Spines numerous, straight, and more slender than in any other division. Fruit top, or pear, shaped; yellow, or greenish yellow.

‡ 12. *C. FLA`VA* Ait. The yellow-fruited Thorn.

Identification. Ait. Hort. Kew., 2. p. 169.; Pursh Fl. Amer. Sept., 1. p. 338.; Dec. Prod., 2. p. 628.; Don's Mill., 2. p. 600.

Synonymes. *C. glandulosa* Michx. *Fl. Bor. Amer.*, 1. p. 288., not of Walt.; *Méspilus Michauxii* Pers. *Syn.*, 2. p. 38.; *C. caroliniana* Poir. *Dict.*, 4. p. 442.; *C. flavissima* Hort.

Engravings. Fig. 585. in p. 859., and the plate of the species in our Second Volume.

Spec. Char., &c. Disks of leaves obovate-wedge-shaped, slightly lobed, crenately serrate, upon short petioles. Stipules glanded. Flowers mostly solitary. Sepals glanded. Fruit top-shaped, yellow, or yellowish green. Nuts 4 in a fruit. (*Dec. Prod.*, ii. p. 628.) A native of North America, from Virginia to Carolina. A spreading tree, of rapid growth; but the shoots are rather slender, and the species not very vigorous. The bark of the trunk is rough, and scales off. The flowers and the fruit are neither produced in abundance, nor make any great show; but the tree has a marked character from its general form, and the horizontal tendency of its branches. It was introduced in 1724; grows to the height of from 20 ft. to 25 ft., flowers in May, and ripens its haws in October. A tree at Holland House is 20 ft. high, with a head 25 ft. in diameter. There are larger trees at White Knights; and one at Grimston, in Yorkshire, 14 years planted, is 22 ft. high.

‡ 13. *C. (F.) LOBATA* Bosc. The lobed-leaved Thorn.

Identification. Bosc incd.; Dec. Prod., 2. p. 628.; Don's Mill., 2. p. 599.

Synonymes. *Méspilus lobata* Poir. *Synpl.*, 4. p. 71.; *C. lutea* Hort.

Engravings. Fig. 554.; and fig. 586. in p. 829.

Spec. Char., &c. Branches a little villose. Disks of leaves ovate, unequally serrated, or lobed, slightly downy beneath, upon very short petioles. Stipules cut. Flowers in loose corymbs. (*Dec. Prod.*, ii. p. 628.) A tree closely resembling *C. flava* in general appearance, and differing from it only in having some of the leaves with larger lobes, and some



554



of the spines larger. The flowers are sparingly produced, among dense tufts of leaves; and the fruit, which is green when ripe, is still less abundant. It is pear-shaped, and very different from every other kind of *Crataegus*, except *C. flava* and *C. f. trilobata*.

‡ 14. *C. (F.) TRILOBATA* Lodd. *Cat.* The three-lobed-leaved Thorn.

Identification. Lodd. *Cat.*, edit. 1832.

Synonymes. *C. spinosissima* Lec.

Engravings. Fig. 587. in p. 860.; and the plate in our Second Volume.

Description, &c. Leaves ovate-cuneate, notched and serrated. Petioles slender. Surface flat, shining, somewhat veined. Branches small, thickly beset with slender thorns. Habit spreading. A hybrid, raised from seed in the Hammersmith Nursery, about 1820, or before. It forms a tree in general appearance resembling *C. flava*, but with the branches much less vigorous, and more thorny. The fruit is yellow, slightly tinged with red; and what distinguishes it from the two allied sorts is, that its leaves die off, in autumn, of an intensely deep scarlet. The only large specimen we know of this kind of thorn is in the arboretum of Messrs. Loddiges; but there are young plants of it in the Hammersmith and other nurseries.

§ viii. *Apiifolia*.

Sect. Char. Leaves deltoid, or somewhat resembling those of the common thorn. The fruit is also of the same colour; but the tree has a totally different habit, having the shoots loose and spreading, weak, and almost without thorns.

‡ 15. *C. APIIFOLIA* Michx. The Parsley-leaved Thorn.

Identification. Michx. *Fl. Bor. Amer.*, 1. p. 287., not *Med.*; *Dec. Prod.*, 2. p. 627.; *Don's Mill.*, 2. p. 599.

Synonymes. *C. Oxyacantha* *Walt. Carol.*, 147.; *C. apiifolia major* *Lodd. Cat.*

Engravings. Fig. 589. in p. 860.; and the plate in Vol. II.

Spec. Char., &c. Leaves deltoid, cut into lobes that are acute and incisely toothed. Pedicels in the corymb villose, mostly simple. Tube of calyx villose. Sepals obscurely serrated. Fruit scarlet. (*Dec. Prod.*, ii. p. 627.) A native of moist woods in Virginia and Carolina. According to Nuttall, it is highly serviceable for the formation of hedges; but an imported plant in the arboretum of Messrs. Loddiges has a loose spreading head, with weak rambling branches, almost destitute of thorns, and by no means gives the idea of a plant adapted to hedges. All the species of *Crataegus*, however, are liable to vary in an extraordinary manner, and we have seen young

plants, grafted from this very tree, covered with spines. The species is said to have been introduced in 1812; but we have not heard of any plant larger or older than that of Messrs. Loddiges, which, in 1835, was 12 ft. high, after being 10 years planted: the same year, for the first time, it flowered, and ripened a few haws, which were almost solitary, and in form and colour resembled those of the common hawthorn.

Variety.

‡ *C. a.* 2 *minor*, *C. apiifolia* Lodd. *Cat.*, (*fig.* 588. in p. 860.) has the leaves smaller than those of the species, and more fringed at the edges, like those of the common parsley; but this fringed appearance is by no means constant, either in the variety or in the species. This variety forms a most ornamental low bush; or a beautiful pendent tree, when grafted standard high.

§ ix. *Microcárpa.*

Sect. Char. Fruit small, round, red. Flowers small, produced in corymbs, later in the season than in any of the other species. Spines few, but sometimes very large.

‡ 16. *C. CORDATA* Mill. The heart-shaped-leaved Thorn.

Identification. Mill. *IC.*, t. 179.; *Dec. Prod.*, 2. p. 628.; *Don's Mill.*, 2. p. 599.

Synonymes. *C. populifolia* Wall. *Car.*, 147.; *Mespilus acerifolia* Poir. *Dict.*, 4. p. 442.

Engravings. Mill. *IC.*, t. 179.; *Wats. Dend. Brit.*, t. 63.; *Bot. Reg.*, t. 1151.; *fig.* 590. in p. 861.; and the plate of this species in our Second Volume.

Spec. Char., &c. Disks of leaves cordate-ovate, angled by lobes, glabrous. Petioles and calyxes without glands. Styles 5 in a flower. (*Dec. Prod.*, ii. p. 628.) A native of hedges and rocky places, from Canada to Virginia. A compact close-headed small tree. The leaves of a deep shining green, and the flowers and fruit produced in numerous terminal corymbs. The size of the leaves varies exceedingly, according to the soil, and the age of the plant. This is a very distinct and handsome species; and, from the plant in Messrs. Loddiges's arboretum, we should think it would attain the height of 20 ft. or 30 ft. in about the same number of years. It was introduced in 1738, and flowers in the end of June or beginning of July.

Statistics. In Staffordshire, at Trentham, 26 years planted, and 11 ft. high; at Alton Towers, 10 years planted, and 16 ft. high. In Worcestershire, at Croome, 20 years planted, and 25 ft. high. In Scotland, in the Edinburgh Botanic Garden, 87 years planted, and 12 ft. high; at Hopetoun House, 18 years planted, and 12 ft. high.

‡ 17. *C. SPATHULATA* Elliott. The spathula-shaped-leaved Thorn.

Identification. Elliott *Fl. S. Car.*, 1. p. 552.; Lodd. *Bot. Cat.*, 1. 1261.

Synonyme. *C. microcárpa* Lindl., *Bot. Reg.*, t. 1846.

Engravings. *Bot. Cab.*, t. 1261.; *Bot. Reg.*, t. 1846.; *fig.* 591. in p. 861.; and the plate of the species in our Second Volume.

Spec. Char., &c. Subspinose. Leaves in fascicles, oblong-cuneated, 3-cleft, lobed and crenated, smooth, shining. Corymbs many-flowered. Calyx smooth; segments ovate, quite entire. Fruit ovate, subrotund, smooth, 5-celled; shell thin. (*Lindl. Bot. Reg.*, t. 1846.) A native of the upper districts of Georgia and Carolina; and growing to a small tree, from 12 ft. to 15 ft. high. Introduced by Lyon, in 1806; flowering in May and June, and ripening its small bright red fruit in October. In this country, it is a slow-growing, very neat, little tree, with slender, smooth, drooping branches, and something of the habit of *C. Oxycántha*. Its leaves have a very handsome appearance, and are remarkably shining, and deep green: they usually grow in clusters; have a long stalk, tapering upwards into a blade, which is sometimes nearly entire, with only a tooth or two at the end; sometimes they are 3-lobed, with crenated segments; and occasionally they are deeply 3-parted; their form is always more or less spathulate. The stipules of the more vigorous branches are large and leafy. The flowers are white, and appear in May, or the beginning of June, at the same time with those of *C. cordata*, and later than most others. The fruit is rather abundant, but small; and,

although bright red, does not make much show upon the branches. The sides of the stones of the fruit are unusually thin for a *Cratægus*. (*Bot. Reg.*, t. 1846.) Dr. Lindley adds that Elliott confounds this species with the *C. spatulata* of Michaux and Pursh; which, as described by these authors, he thinks must be a different species, in the way of *C. parvifolia*, and allied to the *C. virginiana* of the English nurseries. We can only repeat the hope we have so often expressed, that, ere long, all the species of *Cratægus* will be brought together in one garden, so as to be studied, by botanists, in a living state. *C. spatulata* is a beautiful little species, which well deserves a place in every collection; and, being of slow growth, it is particularly eligible for suburban gardens.

§ x. Azaròli.

Sect. Char. Fruit large, round or pear-shaped; good to eat; yellow or red; the yellow fruit generally produced on fastigiate species or varieties; and the red on trees with a spreading and rather a drooping head. Leaves wedge-shaped, 3-cleft or more, shining, pubescent or hairy. Spines few or none.

‡ 18. *C. AZARÓLUS* L. The Azarole Thorn.

Identification. Lin. Sp., 683.; Dec. Prod., 2, p. 629.; Don's Mill., 2, p. 600.

Synonyms. *Pyrus Azarórus* Scop. Carn., No. 597.; J. Bauh. Hist., 1, p. 67.; *Méspilus Azarórus* All. Ped., N. Du Ham., 4, p. 158.; Néflier Azarole, Néflier de Naples, Épine d'Espagne, Pommettes à deux closes, Fr.; Azarol Mispel, Ger.

Engravings. N. Du Ham., 4, t. 42.; Bot. Rep., t. 579.; fig. 592. in p. 862.; and the plate in our Second Volume.

Spec. Char., &c. Leaves pubescent, wedge-shaped at the base, trifid; lobes blunt, and with a few large teeth. Branchlets, corymbs, and calyxes pubescent. Sepals obtuse. Styles 1—3. Fruit globose, scarlet. Seeds usually two; and hence the name, common at Montpellier, *pommettes à deux closes*. (*Dec. Prod.*, ii. p. 629.) Native in small woods, and in rough places, in the south of France and in Italy. This species is decidedly a tree; never being found, in a wild state, with numerous distinct stems rising from the same root, like the common hawthorn; but always with a trunk more or less clothed with branches, to within 3 ft. or 4 ft. of the ground. The head is round and spreading; the branches rambling; the small shoots thick, and covered with a dark-coloured bark, frequently spiny when the plant is young, but spineless as it grows old. The flowers are produced in corymbs towards the extremities of the shoots: they are middle-sized; and are succeeded by fruit, round, and somewhat oval; varying exceedingly in dimensions, in plants raised from seeds, and also in colour, but most generally yellowish red. The fruit, when ripe, is mealy, and somewhat acid; and, in Italy and the Levant, it is occasionally sent to table. The tree, like almost every other of the species of *Cratægus*, is of great durability. Du Hamel mentions a plant, living in his time, in the Jardin du Val, that was sent to Louis XIV. from Spain; from which circumstance it was afterwards called, in France, *épine d'Espagne*. It was cultivated in England, by Tradescant, in 1656; and is recommended by Parkinson, London and Wise, and other old writers on gardening, to be cultivated for its fruit. Notwithstanding this circumstance, old trees are rarely to be met with in British Gardens; and the oldest plant that we know of, in the neighbourhood of London, is in the Fulham Nursery; where, however, it is not above 20 ft. high, but fruits abundantly every other year.

Varieties. In the *Nouveau Du Hamel*, six varieties are enumerated, viz.: 1. *Méspilus Arónia*, with the leaves hairy beneath; 2. Azarole, with large deep red fruit; 3. Azarole, with yellowish white fruit; 4. Azarole, with long fruit, of a whitish yellow; 5. Azarole, with double flowers; and, 6. the White Azarole of Italy. With the exception of the first-mentioned, none of these varieties, as far as we know, are in British gardens.

‡ 19. *C. (A.) MAROCCA'NA Pers.* The Morocco Thorn.

Identification. Pers. Syn., 2. p. 37.; Dec. Prod., 2. p. 628.; Don's Mill., 2. p. 600.

Synonymy. De Candolle expresses a doubt whether *C. maifra Lin. Fil. Sup.*, 253., be not a syn. of this species.

Engravings. Fig. 594. in p. 862.; and the plate in our Second Volume.

Spec. Char., &c. Leaves wedge-shaped, 3-lobed, and pinnatifid, glabrous, glandless. Stipules cut, rather palmately. Flowers upon long peduncles in terminal glabrous corymbs. Sepals obtuse. Styles 2. (*Dec. Prod.*, ii. p. 628.) Flowers very fragrant, and the petals of a very pure white. A native of Morocco; introduced in 1822, and flowering in May and June. A handsome tree, of more fastigate growth than *C. Azarölus*, but in others respects closely resembling that species, except in being smaller in all its parts. There is a very handsome tree of this kind (which we consider to be merely a variety of *C. Azarölus*) in the Horticultural Society's Garden, which is the only one we know of in England. It is nearly 20 ft. high, after being 10 years planted; and it flowered and fruited for the first time in 1835. It produces its leaves very early in the season, in mild winters even in January; and it retains them very late. It is a small, but decided tree, which may be considered one of the handsomest of the genus. The branches, though somewhat fastigate, are not rigid; and they will, probably, as the plant advances in age, become pendulous, like those of *C. Azarölus*.

‡ 20. *C. ARO'NIA Bosc.* The Aronia Thorn.

Identification. Bosc ined.; Dec. Prod., 2. p. 629.; Don's Mill., 2. p. 601.

Synonymy. *Méspilus Aronia Willd. Enum. Suppl.*, and *N. Du Ham.*, 4. p. 158. † *C. Azarölus* β *Willd. Sp.*; *C. fissa Lodd. Cat.*

Engravings. Poccocke *Cratæg.*, t. 85., according to Willdenow; fig. 593. in p. 862.; and the plate in our Second Volume.

Spec. Char., &c. Branchlets pubescent. Leaves pubescent on the under surface, wedge-shaped at the base, 3-cleft; lobes obtuse, entire, each ending in 3 obtuse mucronate teeth. Fruit yellow. (*Dec. Prod.*, ii. p. 629.) A native of Greece and the Levant; introduced in 1810; and forming a thick erect-branched tree of the third rank; remarkable for the abundance of its large yellow fruit, which are good to eat, and have been made into excellent tarts with Siberian crabs. There are fine specimens of this tree in the Garden of the Horticultural Society, from 15 ft. to 20 ft. in height. It was introduced in 1810. It produces its foliage early, and its flowers about the end of May, rather later than those of the common hawthorn. Its fruit ripens in August and September, and hangs on the tree till the leaves drop, in November or December.

‡ 21. *C. ORIENTA'LIS Bosc.* The Eastern Thorn.

Identification. Bosc ined.; Dec. Prod., 2. p. 629.; Don's Mill., 2. p. 600.

Synonymy. *Méspilus orientalis Poir. Suppl.*, 4. p. 72.; *C. odoratissima Bot. Rep. and Lodd. Cat.*

Engravings. Fig. 595. in p. 863.; and the plate in our Second Volume.

Spec. Char., &c. Branches whitely tomentose. Leaves 3-lobed, downy beneath; the two side lobes ovate, and having tooth-like incisions at the tip; the middle lobe trifid. Stipules broad and cut. (*Dec. Prod.*, ii. p. 629.) A native of the East; introduced in 1810, and growing to the height of 15 ft. or 20 ft. It forms a spreading, handsome, low tree, readily distinguished from most other species by its very hoary branches, which are loose, rambling, crossing each other, and somewhat pendulous. It is late in producing its leaves, and also its flowers: the latter generally appear with those of *C. tanacetifolia*, about the end of May (this year, 1836, on the 17th of June), and they are succeeded by numerous large fruit, of a yellowish red, or coral, colour, very agreeable to the taste, which ripen in August and September; and, by their number and brilliant colour, render the tree singularly ornamental till they are destroyed by the frost. There are several fine specimens of this species in the Garden of the London Horticultural Society, and at White Knights.

Variety.

‡ *C. o. 2 sanguinea*; *C. tanacetifolia* 2 taúrica *Dec.*; *C. sanguinea* *Schrader Index Sem. Hort. Acad. Gott.*, 1834; *C. orientalis* *Lindl. Bot. Reg.*, t. 1852.; and *fig. 596.* in p. 863.; has the fruit of a very dark purplish red, or port wine, colour. There are fine specimens of this variety in the Bishop of London's garden, and in the Fulham Nursery; and one plant in the Horticultural Society's Garden. Dr. Lindley considers this "the genuine *Méspilus orientalis* of Tournefort, with villous celery-like leaves, and a large, purple, 5-cornered, smooth fruit." It is a native of the Crimea, and the parts bordering on the Black Sea; and was introduced in 1810.

‡ 22. *C. TANACETIFOLIA Pers.* The Tansy-leaved Thorn.

Identification. *Pers. Syn.*, 2. p. 58.; *Dec. Prod.*, 2. p. 629.; *Don's Mill.*, 2. p. 601.

Synonymes. *Méspilus tanacetifolia Poir. Dict.*, 4. p. 440., and *N. Du Ham.*; *M. pinnata Dum. Cours.*, *Sm. Exot.*, t. 85. *De Candolle* doubts whether *Méspilus Celsiana* *Dum. Cours Suppl.* p. 286. be different from this species.

Engravings. *Bot. Rep.*, t. 591.; *Sm. Exot. Bot.*, t. 85.; *fig. 597.* in p. 863.; and the plate in our Second Volume.

Spec. Char., &c. Leaves pinnatifidly cut, hairy; lobes oblong, acute, having a few teeth. Sepals acutish, reflexed, hairy. Styles 5. Fruit globose, yellowish green. (*Dec. Prod.*, ii. p. 629.) A native of the East; introduced in 1789, and flowering in May and June.

Varieties.

‡ *C. t. 2 glabra* *Lodd.* (*fig. 598.* in p. 863., and the plate in our Second Volume) has shining leaves, and fruit about half the size of that of the species, of a reddish yellow. It is said to be a hybrid between *C. tanacetifolia* and *C. Oxycantha*; which, from the appearance of the plant, is extremely probable. It was introduced, by Messrs. Loddiges, from Germany, about 1810; and the plant in their collection was, in 1835, nearly 10 ft. high.

‡ *C. t. 3 Leciana.* *C. incisa* *Lee*; *Lee's Seedling Hort.* (*fig. 599.* in p. 864.; and the plate of this variety in our Second Volume.)—The plants of this variety in the Hammersmith Nursery somewhat resemble those of *C. orientalis*, but the leaves are much larger, and more deeply cut, and the trees are of a more robust, erect, and fastigate habit. In the Leyton Nursery, there is a plant of the same variety, which, 9 years planted, is 12 ft. high: it is of remarkably robust growth, and it flowered in June, 1836, for the first time. We have been informed that the fruit of this variety is yellow; and this circumstance, taken in connexion with its foliage and upright manner of growth, induces us to consider it a hybrid between *C. orientalis* and *C. tanacetifolia*. It is said to have been raised by the late Mr. Lee of the Hammersmith Nursery. It promises to form a splendid tree, most striking in appearance, from its large and deeply cut foliage, and its strong, upright, vigorous shoots; on which account, no collection, where there is room, ought to be without it.

Description, &c. A robust-growing fastigate tree, with upright rigid branches, commonly terminating in thorny points. The leaves and calyxes are covered on both sides with long hairs. The fruit is globular, slightly compressed, and has somewhat the appearance of being ribbed, like a melon: it is larger than that of any other species of the genus, except *C. Arónia* and *C. mexicana*; is of a greenish yellow when ripe; and is easily distinguishable by the bracteas generally adhering to it. The foliage is the latest in appearing of any of the species, except *C. orientalis*, which is frequently equally late. This species was introduced into France, from the Levant, by Tournefort, who says there are trees of it, in its native country, as large as oaks; that the bark of the trunk is dark grey, and much cracked; the branches tufted and spreading; and that the fruit, which is produced in twos and threes, on the points of the young thorny shoots, resembles a small apple, about an inch

in diameter, and is roundish, with fine angles, like the ribs of a melon; being lightly covered with down, and having a persistent calyx of 5 sepals, toothed like the leaves of the tree. Tournefort also notices the circumstance of one or two of the bractæas sometimes growing out of the flesh of the fruit, or being produced from its footstalk. The fruit, though agreeable, he says is not so much so as that of the azarole; but he thinks it might be improved by cultivation. It is much eaten by the Armenians. This species was introduced in 1789; and in 10 years it forms a tree 20 ft. high; readily distinguishable, at some distance, by the rough scaly bark of its trunk, and the stiff upright branches which form its head.

Statistics. In the environs of London, at Kenwood, 35 years planted, and 20 ft. high, the diameter of the trunk 9 in., and of the head 15 ft.; at Syon, 14 ft. high; in Dorsetshire, at Melbury Park, 20 years planted, and 17 ft. high; in Somersetshire, at Hinton House, 19 years planted, and 18 ft. high; in Surrey, at Farnham Castle, 50 years planted, and 20 ft. high; in Wiltshire, at Longleat, 40 years planted, and 20 ft. high; in Berkshire, at White Knights, 25 years planted, and 14 ft. high, the diameter of the trunk 9 in., and of the head 26 ft.; in Nottinghamshire, at Clumber Park, 18 ft. high; in Oxfordshire, in the Oxford Botanic Garden, 18 ft. high; in Pembroke-shire, at Golden Grove, 20 years planted, and 15 ft. high; in Staffordshire, at Trentham, 21 years planted, and 18 ft. high; in Suffolk, at Ampton Hall, 16 years planted, and 15 ft. high; in Worcestershire, at Croome, 20 years planted, and 25 ft. high. In Scotland, in Renfrewshire, in the Glasgow Botanic Garden, 12 years planted, and 11 ft. high; at Bothwell Castle, 45 years planted, and 30 ft. high, the diameter of the trunk 13 in., and of the head 40 ft., in prepared loamy soil, in a sheltered situation. In Ireland, in the Cullenswood Nursery, 12 years planted, and 21 ft. high; at Oriel Temple, 25 years planted, and 18 ft. high.

§ xi. *Heterophýlla.*

Sect. Char. Leaves cuneate, and sub-persistent. Fruit long, middle-sized, and crimson.

¶ 23. *C. HETEROPHYLLA* Flugge. The various-leaved Thorn.

Identification. Flugge Ann. Mus., 12. p. 423. t. 38.; Dec. Prod., 2. p. 629.; Don's Mill., 2. p. 600.; Lindl. in Bot. Reg., t. 1847.

Synonymes. *C. neapolitana* Hort.; *Méspilus constantinopolitana* Godfroy.

Engravings. Ann. Mus., 12. t. 38.; Bot. Reg., t. 1847.; fig. 600. in p. 864.; and the plate in our Second Volume.

Spec. Char., &c. Leaves bright; falling off late, lanceolate-cuneate, toothed at the apex, 3-cleft; segments serrate. Tube of the calyx fusiform. Cymes many-flowered. Flowers 1-styled. Fruit ovate, including one nut, with a hard bony shell, and one seed. Stipules large, pinnatifid. (Lindl. Bot. Reg., t. 1847.) The native country of this species is uncertain; and it is, probably, only a hybrid between the common hawthorn and the azarole, or some other European species. It forms a very handsome, somewhat fastigiate, or pyramidal, dense-headed, low tree; producing its leaves and flowers early in the spring, and retaining its leaves and fruit till the first autumnal frosts. The fruit resembles the common haw, but is narrower and longer, and the colour is a rich crimson. The species was introduced in 1816; but it is not common in collections. There are fine trees of it in the Garden of the London Horticultural Society, where it is extremely ornamental, both when covered with flowers in May, and with ripe fruit in September and October.

§ xii. *Oxyacánthæ.*

Sect. Char. Leaves obovate, trifid, or variously cut. Flowers numerous, in corymbs. Fruit generally red.

¶ 24. *C. OXYACANTHA* L. The sharp-thorned Cratægus, or common Hawthorn.

Identification. Lin. Sp., 683.; Dec. Prod., 2. p. 628.; Don's Mill., 2. p. 600.; Baxt. Brit. Fl. Pl., 2. t. 118.

Synonymes. The *Pyraeantha* of the Greeks; *Méspilus Oxyacantha* Gærtn., and *N. Du Ham.*; *E'pine blanche*, noble *E'pine*, Bois de Mai, Scuelleir Aubépine, Néflier Aubépine, *Fr.*; *Hagedorn gemeiner Weissdorn*, *Ger.*; *Hagetoon*, *Dan.*; *Hagetorn*, *Sued.*; *Bianco-spino*, *Ital.*; *Espino blanco*, *Span.*; *White Thorn*, *Maybush*, *Quiek*, *Quickset*, *May.*

Engravings. Gærtn. Fruct., 2. t. 87.; Eng. Bot., t. 2054.; Baxt. Brit. Fl. Pl., t. 18.; fig. 602. in p. 865.; and the plate in our Second Volume.

Derivation. Booth derives the word *Haw* from *hæc*, or *hæg*, a hedge; consequently he makes hawthorn signify hedgethorn. *Quick* signifies live; and was, probably, applied, from live hedges

made of hawthorn being used instead of fences of cut spray of trees. Whitethorn, from the profusion of its white flowers and its being thorny. May, and Maybush, have reference both to the time of flowering of the plant, and to its use in the May, or floral, games. The French name, Aubépine, refers to its flowering in spring, or in what may poetically be called the morning of the year; *aube* signifying the dawn of the day.

Spec. Char., &c. Leaves obovate-wedge-shaped, almost entire or trifid, or cut, glabrous, rather glossy. Corymbs of several flowers. Sepals glandless, acute. Styles 1—3. (*Dec. Prod.*, ii. p. 628.) Common in the hedges of Europe, and varying much in different situations.

Varieties. These are very numerous, and some of them very distinct. The reason why they are more numerous in this species than in most others is, that the plant, for the last half century and upwards, has been very extensively raised from seed, for making hedges; and curious nurserymen, when they have observed any plants indicating a striking peculiarity of foliage, or mode of growth, in their seed-beds, have marked them, kept them apart, and propagated them by budding or grafting. Another reason is, the many thousands of plants now growing in the hedges of this country, among which may be observed almost every variety of the species now in cultivation in gardens. In the environs of London, we have observed the scarlet-flowered variety repeatedly in hedges, and also varieties with variegated leaves, with woolly fruit, with yellow fruit, and with pendulous shoots. As to varieties in the leaves, they are endless; and the same may be said of the size, and of hardness, or fleshiness, of the fruit. In the following enumeration we have confined ourselves to plants which we have actually seen in the Horticultural Society's Garden, or in the arboretum of Messrs. Loddiges.

‡ C. O. 2 *obtusata* Dec. Prod. and Don's Mill. *Méspilus Oxyacantha integrifolia* Wallr. *Sched.*, 219.; *C. oxyacanthoides Thuill. Fl. Par.*, 245., *Lindl. Bot. Reg.*, t. 1128., *Dec. Fl. Fr.*, iv. p. 433.; *C. Oxyacantha Fl. Dan.*, t. 335.; the French hawthorn. (*fig.* 601. in p. 864., and the plate in our Second Volume.)—Leaves rather rhomb-shaped at the base, obovate, undivided, or with three obtuse lobes, crenate, of the same colour on both surfaces. Styles 1—3. A small tree, resembling, in general appearance, the common hawthorn, but distinguished from it by its smaller, obovate, less cut, flat, and shining leaves. *C. lucida* *Smith of Ayr*, *C. oxyacanthoides lucida* *Sweet*, is scarcely or not at all different from this variety.

‡ C. O. 3 *sibirica*, *C. sibirica* *Lodd. Cat.*, *C. monogyna* *L.*, (*fig.* 555.) is an early leafing variety, a native of Siberia. In mild seasons, it begins to put forth its leaves in January; and, in dry summers, it loses them proportionately soon in the autumn. On account of its early leafing and flowering, it well merits a place in collections. The flowers have only one style; but, as there are other varieties having only one style which do not flower early, we have not adopted Linnæus's name of *C. monogyna*.



‡ C. O. 4 *transylvanica* Hort., from the plant in the Horticultural Society's Garden, appears to be nearly, if not quite, the same as *C. O. sibirica*.

‡ C. O. 5 *quercifolia* Booth (*fig.* 608. in p. 866.) appears very distinct in regard to foliage; but there are only small plants of it in two or three places in the neighbourhood of London, all of which have been introduced lately from Mr. Booth of Hamburg.

‡ C. O. 6 *laciniata*, *C. laciniata* *Lodd. Cat.*, (*fig.* 603. in p. 865., and the plate in our Second Volume) has finely cut leaves; the shoots are

- comparatively slender, the plant less robust, and the fruit smaller, than in the species. It is a very distinct and elegant variety.
- ‡ C. O. 7 *pteridifolia*, *C. pteridifolia* Lodd. *Cat.*, *C. pectinata* Hort., (*fig.* 604. in p. 865.) resembles the preceding, but the leaves are longer in proportion to their breadth, and more elegantly cut. There are only small plants of this very elegant and most interesting variety in the Fulham Nursery, at Messrs. Loddiges, and in one or two other collections.
- ‡ C. O. 8 *eriocarpa* Lindl., *C. eriocarpa* Lodd. *Cat.*, (*fig.* 607. in p. 865., and the plate in our Second Volume) is a robust rapidly growing variety, with large leaves, and strong thick shoots; a clear white bark, and few thorns. It is very prolific in flowers, and the fruit which succeeds them is woolly in its young state, but not large. There are fine trees of this very distinct variety in the Horticultural Society's Garden. If ever the hawthorn should be cultivated for its timber, to supply the wood engravers as a substitute for box, this variety, and *C. O. melanocarpa* will deserve the preference.
- ‡ C. O. 9 *purpurea* Penny (*fig.* 611. in p. 866.) has large leaves, and the young shoots are of a dark purple colour. It was raised from seed, some years ago, in the Epsom Nursery, but has not yet flowered.
- ‡ C. O. 10 *Oliveriana*; *C. Oliveriana* Bosc, Dec. Prod., ii. p. 630., and Don's Mill., ii. p. 601.; *C. Oliveria* Lodd. *Cat.*; *C. orientalis* Lodd. *Cat.*; (*fig.* 606. in p. 865., and the plate in our Second Volume) has the leaves small and hoary, and the fruit also small and black. It forms a very distinct variety, and is accounted by some a species. There are handsome plants of it in the Horticultural Society's Garden.
- ‡ C. O. 11 *melanocarpa*, *C. fissa* Lee, *C. Oxyacantha platyphylla* Lodd. *Cat.*, *C. platyphylla* Lindl. in *Bot. Reg.*, t. 1874., (*fig.* 605. in p. 865., and the plate in our Second Volume) also has the fruit black, as the name implies. It differs from the preceding variety chiefly in being of more vigorous growth, and in having its leaves much less hoary. There is a tree of this variety, in the Hammersmith Nursery, of extraordinary vigour and beauty; it has not been above ten or twelve years planted; but it is upwards of 20 ft. high, with a straight smooth-barked trunk, and a head 25 ft. in diameter, or upwards, with branches depending to the ground on almost every side; and it is, perhaps, the handsomest young hawthorn in the neighbourhood of London. This variety flowers at the same time as *C. O. eriocarpa*, that is, about a week after the species; and the two trees so closely resemble each other in leaves and habit of growth, that, except when they are in fruit, they can only be distinguished by the darker colour of the bark of *C. O. melanocarpa*.
- ‡ C. O. 12 *aurea* Hort., *C. flava* Hort., (*fig.* 610. in p. 866.) has the leaves like *C. O. obtusata*, and the fruit roundish, and of a golden yellow. This is a very distinct variety, and ought never to be omitted in collections. The yellow haw, Hanbury observes, is a "most exquisite plant." The buds, which are among the first that come out in the spring, are of a fine yellow; and the fruit is of the colour of gold. The tree is a great bearer, and retains its fruit all the winter. There is a fine old specimen of this tree at Syon.
- ‡ C. O. 13 *aurantiaca* Booth is said to have orange-coloured fruit; but there are only small plants of it in the London gardens. Mr. Wilson found, in Ayrshire, a variety with greenish orange fruit. (*Hook.*)
- ‡ C. O. 14 *leucocarpa*, a variety with white haws, is said to have been discovered in a hedge near Bampton, in Oxfordshire; but we have never seen it. According to Hanbury, it is but a paltry tree, an indifferent bearer, and the fruit is of a dirty white.

- ‡ *C. O.* 15 *múltiplex* Hort., *C. O.* *flòre plèno* Hort., (*fig.* 609. in p. 866.) has double white flowers, which die off of a beautiful pink; and which, being produced in great profusion, and lasting a long time, render this a most desirable variety: accordingly, it is to be found in almost every shrubbery and garden.
- ‡ *C. O.* 16 *rosea* Hort.; *E'pinier Marron*, *Fr.*; (*fig.* 612. in p. 866.) has the petals pink, with white claws, and is a well-known and very beautiful variety. Ray informs us that this variety was found in an orchard hedge at Gaddington in Northamptonshire, and at Ricot Park and elsewhere in Oxfordshire. (*Syn.*, p. 454.)
- ‡ *C. O.* 17 *punicea* Lodd. Cat., *C. O.* *rosea supérba* Hort., has larger petals, which are of a dark red, and without white on the claws.
- ‡ *C. O.* 18 *punicea flore plèno* Hort. is said to be of as dark and brilliant a red as *C. O.* *punicea*, and to have double flowers. We have never seen this kind in blossom; but there are young plants of it in the Camberwell Nursery; and there is one specimen in the Horticultural Society's Garden.
- ‡ *C. O.* 19 *foliis aurèis* Lodd. Cat. has leaves variegated with yellow; but they have generally a ragged and diseased appearance, when fully expanded; though, like those of most other variegated deciduous plants, when first opening in spring, they are strikingly showy and distinct.
- ‡ *C. O.* 20 *foliis argéteis* Hort. has leaves variegated with white; but, like the preceding variety, it cannot be recommended as handsome at any other period than when the leaves are first expanding.
- ‡ *C. O.* 21 *stricta* Lodd. Cat., *C. O.* *rigida* Ronalds, has the shoots upright, and the general habit as fastigiate as that of a Lombardy poplar. It was discovered in a bed of seedlings in Messrs. Ronalds's Nursery, about 1825, and forms a very distinct and desirable variety.
- ‡ *C. O.* 22 *Celsiana* Hort. is also somewhat fastigiate in its habit; but it is a much more slender-growing plant; and we have never seen a specimen in a situation where it could display its natural form and mode of growth. There are several plants of it at Messrs. Lodiges's; but they are all crowded together.
- ‡ *C. O.* 23 *pendula* Lodd. Cat. has drooping branches. A very marked variety of this kind, which was picked out of a bed of seedlings by General Monckton, is in the collection of thorns at Somerford Hall. The branches come out of the main stem in whorls, and hang down almost perpendicularly, so as to give the plant somewhat the appearance of a distaff. Mr. Anderson, the curator of the Chelsea Botanic Garden, obtained pendulous-branched varieties of the common thorn, by grafting shoots from those bundles or conglomerations of slender shoots, resembling bird's nests, which are sometimes found in old trees; and he observes that, on whatever species of ligneous plant these bird's-nest-like conglomerations of shoots are met with, by grafting them on a tree of the same species, they will hang down, and constitute a pendulous variety. (See *Gard. Mag.*, vol. ix. p. 596.)
- ‡ *C. O.* 24 *reginæ* Hort. *Queen Mary's Thorn*. — The parent tree is in a garden near Edinburgh, which once belonged to the Regent Murray, and is now, 1836, in the possession of Mr. Cowan, a paper manufacturer. It is very old, and its branches have somewhat of a drooping character; but whether sufficiently so to constitute a variety worth propagating as a distinct kind, appears to us very doubtful. It may be interesting, however, to some Scotchmen, to continue by extension the individual tree under which the unfortunate queen is supposed to have spent many hours. The fruit of this variety is rather above the middle size, long, fleshy, of a deep red, and good to eat. A lithographic impression of this tree has been sent us by Dr. Neill,

and also a drawing of it, taken in 1836, by Mr. Maenab, jun. From Mr. Macnab's drawing, *fig. 556.* is reduced to a scale of an inch to 12 ft. The dimensions of the tree have been sent us by Mr. Barnet, of the Experimental Garden, Inverleith; from which we find that the height of the tree is 33 ft., and the diameter of the head 36 ft.; the trunk divides into two limbs, at 15 in. from the ground, one of which is 1 ft. 4 in. in diameter, and the other 1 ft. in diameter. The tree, Mr. Barnet informs us, is healthy and vigorous; though, if it be true that Queen Mary sat under its shade, it must be nearly 300 years old.

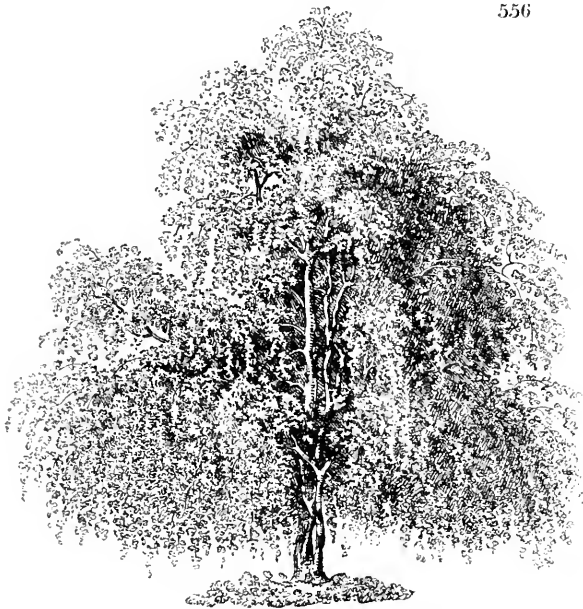

† C. O. 25 *præ'cox* Hort., *the early-flowering, or Glastonbury, Thorn*, comes into leaf in January or February, and sometimes even in autumn; so that occasionally, in mild seasons, it may be in flower on Christmas-day. According to Withering, writing about fifty years ago, this tree does not grow within the ruins of Glastonbury Abbey, but stands in a lane beyond the churchyard, and appears to be a very old tree. An old woman of 90 never remembered it otherwise than as it now appears. This tree is probably now dead; but one said to be a descendant of the tree which, according to the Romish legend, formed the staff of Joseph of Arimathea, is still existing within the precincts of the ancient abbey of Glastonbury. It is not of great age, and may probably have sprung from the root of the original tree, or from a truncheon of it; but it maintains the habit of flowering in the winter, which the legend attributes to its supposed parent. A correspondent (Mr. Callow) sent us, on December 1. 1833, a specimen, gathered on that day, from the tree at Glastonbury, in full blossom, having on it, also, ripe fruit; observing that the tree blossoms again in the month of May following, and that it is from these later flowers that the fruit is produced. (*Gard. Mag.*, vol. ix. p. 123.) Mr. Baxter, curator of the Botanic Garden at Oxford, also sent us a

specimen of the Glastonbury thorn, gathered in that garden on Christmas-day, 1834, with fully expanded flowers and ripe fruit on the same branch. The plants of this variety in the Horticultural Society's Garden, and at Messrs. Loddiges, flower sometimes in December, and sometimes not till March or April. Seeds of this variety are said to produce only the common hawthorn; but we have no doubt that, among a number of seedlings, there would, as in similar cases, be found several plants having a tendency to the same habits as the parent. With regard to the legend, there is nothing miraculous in the circumstance of a staff, supposing it to have been of hawthorn, having, when stuck in the ground, taken root, and become a tree; as it is well known that the hawthorn grows from stakes and truncheons; one of the finest trees in Scotland, viz. that at Fountains Hall, having been originated in that manner by a man still in existence. The miracle of Joseph of Arimathea is nothing compared with that of Mr. John Wallis, timber surveyor of Chelsea, author of *Dendrology* (see *Gard. Mag.*, vol. x. p. 51.), who exhibited to the Horticultural and Linnæan Societies, in 1834, a branch of hawthorn, which, he said, had hung for several years in a hedge among other trees; and, though without any root, or even touching the earth, had produced, every year, leaves, flowers, and fruit!

- ‡ *C. O. 26 monógyna*, *C. monógyna* Jacq., has flowers with only one style, like *C. sibírica*, but does not flower early, like that variety. It has been observed by botanists, that there is a great uncertainty in the number of styles in the genus *Crataégus*. According to D'Asso, the common hawthorn is constantly monogynous in Spain. Allioni states that this variety has the leaves more shining than those of the species; and that they are extremely smooth, and deeply cut into three or five lobes; the peduncles are, also, smooth; the segments of the calyx reflexed; and the fruit constantly contains only one seed. Sir James Edward Smith says, "Repeated examination has satisfied me, and many other English botanists, that flowers with a single style are equally frequent in Jacquin's *C. Oxyacántha* and in his *C. monógyna*, though by no means universal in either." (*Eng. Bot.*, ii. p. 360.) According to the letter of the Linnæan system, and to the generally received mode of forming generic and specific distinctions on differences in parts of the flower alone, without reference to other parts of the plant, *C. O. monógyna* ought to be made, not only a distinct species, but a distinct genus, since it does not even belong to the same order as the other varieties of the same species; or, at all events, it ought to be made a distinct species, and was so made by Jacquin and others. The truth appears to be, that *C. Oxyacántha*, like most of the other species of *Crataégus*, varies in having from 1 to 5 styles, though one or two are most frequent. It appears that the Siberian variety is also monogynous; but, as it is remarkable for its early flowering, we have kept it distinct under the name of *C. O. sibírica*. See No. 3.
- ‡ *C. O. 27 apétala* Lodd. Cat. — This remarkable variety has the flowers without petals, or very nearly so.
- ‡ *C. O. 28 lucida*. We apply this name to a very distinct and very beautiful-leaved variety, which forms a standard in the southern boundary hedge of the Horticultural Society's Garden, and which, we trust, will soon be propagated in the nurseries. The leaves are large, regularly cut, somewhat coriaceous in texture, and of a fine shining green. The plant is of vigorous growth.
- ‡ *C. O. 29 capitata* Smith of Ayr differs from the species chiefly in being of a somewhat more fastigiata habit, and in producing its flowers in close heads, mostly at the extremities of its branches.

‡ *C. O. 30 flexuosa* Smith of Ayr has the small branches twisted in a zigzag manner.

Description. The common hawthorn, in its wild state, is a shrub, or small tree, with a smooth blackish bark, and very hard wood. The branches are numerous and slender, furnished with lateral, sharp, awl-shaped spines. The leaves alternate and deciduous, on longish slender stalks, of a smooth deep green; more or less deeply 3-lobed or 5-lobed, cut and serrated, wedge-shaped or rounded. Stipules crescent-shaped, very variable in size. (*Smith.*) The flowers are corymbose, terminal, with white petals, but sometimes pink, or almost scarlet, and sometimes apetalous and sweet-scented. Styles several, few, or only one. According to Withering, the varieties found in our hedgerows have, most commonly, one style; and flowers with three styles are the most rare. On clayey soils, he says, the flowers are red, but on light soils, almost always white. (*Arrang.*, ii. p.459.) The usual time of the hawthorn flowering is May; but, in 1783, it began to flower on the 21st of March; and the year following it was six weeks later. It was almost as early in 1794, and as late in 1795. The extreme times of flowering in the Selborne Calendar are, April 20th to June 11th. (*Mart. Mill.*) The fruit, which is a pome, and is called a haw, is of a dark red, and varies exceedingly in size and shape: it is sometimes found yellow or black, or occasionally, but rarely, of a greenish orange, or a dirty white. The rate of growth, when the plant is young, and in a good soil and climate, is from 1 ft. to 2 ft. or 3 ft. a year, for the first three or four years; afterwards its growth is slower, till the shrub or tree has attained the height of 12 ft. or 15 ft., when its shoots are produced chiefly in a lateral direction, tending to increase the width of the head of the tree rather than its height. In a wild state, it is commonly found as a large dense bush; but, pruned, by accident or design, to a single stem, it forms one of the most beautiful and durable trees of the third rank that can be planted: interesting and valuable for its sweet-scented flowers in May, and for its fruit in autumn, which supplies food for some of the smaller birds during part of the winter. In hedges, the hawthorn does not flower and fruit very abundantly when closely and frequently clipped; but, when the hedges are only cut in at the sides, so as to be kept within bounds, and the summits of the plants are left free and untouched, they flower and fruit as freely as when trained as separate trees. The plant lives for a century or two, and there are examples of it between 30 ft. and 40 ft. in height, with trunks upwards of 3 ft. in diameter at 1 ft. from the ground.

Geography. The common hawthorn is found in most parts of Europe; from the Mediterranean as far north as $60\frac{1}{2}$ in Sweden; it is also found in the north of Africa, in Western Asia, and in the south of Russia. In Siberia, a variety with one style and red flowers, Pallas informs us, is abundant; particularly round Lake Baikal, where it grows to the height of 10 ft. or 12 ft. The species is found in every part of Great Britain; and, according to H. C. Watson, it rises a little higher on the mountains than *Ulex europæa*. It is always found in a dry soil; and when that is poor, and at a considerable elevation, the plants do not exceed 4 ft. or 5 ft. in height; but, in favourable soils and situations, it grows to the height of 12 ft. or 15 ft.; and when drawn up in woods, to the height of 20 ft. or 30.

History. *Cratægus Oxyacantha* was known to the Greeks under the name of *pyracantha* (see p. 17.); though it is uncertain whether it was employed by that people or the Romans for any useful purpose; the *oxyacantha* of the classics being by some considered as the *C. Pyracantha*, and by others as the common berry. It appears from Homer, that, when Ulysses returned to his father Laertes, the good old man had sent his servants into the woods to gather young thorns for forming hedges; and was occupied himself in preparing ground to receive them. (*Odyssey*, lib. xxiv.) These thorns might have been of the common hawthorn, or of some of the Oriental species of *Cratægus*, or of various other thorn-bearing plants. Varro calls a thorn hedge a natural and living guardian; and Columella prefers it before the constructed one, or dead hedge, as being more lasting and less expensive. (*De*

Re Rusticá, lib. xi.) In modern times, we find, from Crescentius (lib. v.), that hawthorn hedges were used in Italy before 1400. In England, they appear to have been in use from the time of the Romans. In all the old works on husbandry, directions occur for quicksetting ditches, and forming hedgerows; and in Standish's *Commons' Complaint*, published in 1611, the author gives directions for a *new method* of pruning "quickwood sets of white thorne," so as to make them thick at bottom; and advises, in certain cases, that three rows of quickthornes shall be set in each ridge, instead of two, as appears to have been the ordinary practice. In a black letter tract, called *An Olde Thrifte newly revived*, &c., published in 1612, very particular directions are given for enclosing young plantations "with a good ditch and quickset of white thorne, crab tree, and hollin, mixed together, or else any one of them (and by no means, if you can chuse, set any black thorne amongst it, for that it will grow into the field's ward, and spoyle pasture, and teare the wool of the sheepes backe)." In Tansser's *Five Hundred Points of good Husbandry*, directions are also given for making hedges:—

"Go plough or delve up, advised with skill,
The breadth of a ridge, and in length as you will;
Where speedy quickset for a fence you will draw,
To sow in the seed of the bramble and haw."

Most of these hedges, however, appear to have been made to enclose plantations; and hedges of hawthorn for fields were, probably, not general in England till the establishment of nurseries, about the beginning of the seventeenth century. The first planted hedges, in every country, would, doubtless, consist of shrubs dug up from the neighbouring woods; and those which appeared to be the most formidable from their spines, and, also, the most durable from the nature of their wood, would, doubtless, obtain the preference. But, in different parts of the country, this would give rise to hedges formed of different plants: in some places, the black thorn, or sloe (*Prunus spinosa*), in others, the hawthorn (*Cratægus Oxyacantha*), and in some the buckthorn (*Rhamnus catharticus*), might prevail. In all these hedges, there must necessarily have been a mixture of plants, from the difficulty of obtaining a number of one kind without sowing the seed for the purpose; so that hedges formed merely of chance plants, taken out of the woods, cannot even be considered as thorn hedges, and, doubtless, not as hedges entirely of hawthorn. In Evelyn's *Sylva*, published in 1664, he mentions a gentleman who had "considerably improved his revenue by sowing haws only, and raising nurseries of quicksets;" so that nurseries of these plants cannot, even then, have been common. Wherever originated, however, it is certain that hawthorn hedges were not generally planted, throughout England, to enclose the common corn fields and meadows till after the introduction of the Flemish husbandry into Norfolk, about the end of the seventeenth century. The first hawthorn hedges planted in Scotland, Dr. Walker informs us, were on the road leading up Inch Buckling Brae, in East Lothian; and at Finlarig, at the head of Tay, in Perthshire. They were planted at both places by Cromwell's soldiers. (*Essays*, p. 53.) Hawthorn hedges are now common in every part of the island, unless we except the mountainous districts of the Highlands of Scotland, and those parts of Ireland which are not yet in general cultivation; and no other plant whatever is found to answer equally well for this purpose. The raising of hawthorn plants for hedges has, for the last century, formed the most important part of the business of country nurserymen; and the profession of hedger and ditcher has been one of the most common among the country labourers of Great Britain for the same period. Since the peace of 1814, and the change in the prices of agricultural produce, fewer enclosures of open lands have taken place, and the demand for hedge plants has greatly diminished; but still, from the alterations which are constantly taking place in landed estates, the subdivision of fields, or the changes in the direction of fences, new hedges are constantly being planted; and there is not, perhaps, a plant grown by nurserymen for which there is a more steady and extensive demand than

the common hawthorn. It is also raised as a stock on which to graft other species of *Cratæ[^]gus*; and the scarlet-flowered and double-blossomed varieties are eminently popular as ornamental flowering low trees.

Properties and Uses. The wood of the hawthorn is very hard, and difficult to work: its colour is white, but with a yellowish tinge; its grain is fine, and it takes a beautiful polish; but it is not much used in the arts, because it is seldom found of sufficient size, and is, besides, apt to warp. It weighs, when green, 68 lb. 12 oz. per cubic foot; and, when dry, 57 lb. 5 oz. It contracts, by drying, one eighth of its bulk. It is employed for the handles of hammers, the teeth of mill-wheels, for flails and mallets, and, when heated at the fire, for canes and walking-sticks. The branches are used, in the country, for heating ovens; a purpose for which they are very proper, as they give out much heat, and possess the property of burning as readily when green, as in their dry state. They are not less useful in the formation of dead hedges, for the protection of seeds, or of newly planted live hedges, or of single trees; and they will last a considerable time without decaying; especially when they have been cut in autumn. The leaves are eaten by cattle, which, nevertheless, pay some regard to the spines by which they are defended. The fruit is astringent, and has been recommended in cases of dysentery; and sometimes employed with success in affections of the kidneys and bladder. In many of the departments of France, a fermented liquor is made from it, and mixed with cider and perry to augment its strength. M. Bosc says that, on this account alone, the hawthorn ought to be more cultivated in the north of France, since the drink formed from it might supply the place of beer, for which so much grain is required. The drink is, however, very intoxicating. (*Dict. des Eaux et des Forêts.*) In England, the leaves, when young, were used formerly in salads, and have been frequently employed, with those of the sloe, to adulterate tea. The hawthorn, like most other indigenous trees, was criticised by Gilpin, with reference to its claims to picturesque beauty. To this kind of beauty he allows it to have very slight pretensions; and his reasons in this, as in every other similar case, are elegantly expressed, and full of instruction to the landscape-gardener. "Its shape," he says, "is bad: it does not taper and point like the holly, but is rather a matted, round, heavy bush. Its fragrance, indeed, is great; but its bloom, which is the source of that fragrance, is spread over it in too much profusion: it becomes a mere white sheet, a bright spot, which is seldom found in harmony with the objects around it. In autumn, the hawthorn makes its best appearance. The glowing berries produce a rich tint, which often adds great beauty to the corner of a wood, or the side of some crowded clump." On this passage, Sir Thomas Dick Lauder observes, "We think Mr. Gilpin is peculiarly hard on the hawthorn. Even in a picturesque point of view, which is the point of view in which he always looks at nature, the hawthorn is not only an interesting object by itself, but produces a most interesting combination, or contrast, as things may be, when grouped with other trees. We have seen it hanging over rocks, with deep shadows under its foliage; or shooting from their sides in the most fantastic forms, as if to gaze at its image in the deep pool below. We have seen it contrasting its tender green, and its delicate leaves, with the brighter and deeper masses of the holly and the alder. We have seen it growing under the shelter, though not under the shade, of some stately oak; embodying the idea of beauty protected by strength. Our eyes have often caught the motion of the busy mill-wheel, over which its blossoms were clustering. We have seen it growing grandly on the green of the village school, the great object of general attraction to the young archins, who played in idle groups about its roots; and, perhaps, the only thing remaining to be recognised when the schoolboy returns as the man. We have seen its aged boughs overshadowing one half of some peaceful woodland cottage; its foliage half concealing the window, whence the sounds of happy content and cheerful mirth came forth. We know that lively season,—

‘ When the milkmaid singeth blythe,
And the mower whets his scythe,
And every shepherd tells his tale
Under the hawthorn in the dale ;’

and with these, and a thousand such associations as these, we cannot but feel emotions of no ordinary nature when we behold this beautiful tree.” (*Lauder’s Gilpin*, vol. i. p. 195.)

As a tree of the third rank, in ornamental scenery, few surpass the hawthorn; and, in parks, the haws afford food for small birds, and for deer. It also forms an ornamental undergrowth; and Sir Uvedale Price has recommended it to be planted in thickets, in order to afford a protection to timber trees, without the aid of fencing. As trees are frequently planted thick at first, with the intention of thinning them afterwards; and as this operation is almost always neglected, the same author suggests that, in extensive plantations, no more timber trees ought to be planted than are intended finally to remain; and that the interstices should be filled up with hawthorns, hollies, and other shrubs, or low trees.

By far the most important use of the hawthorn is as a hedge plant. For this purpose, it is planted in single or in double lines, most commonly along the margin of a ditch; though, however convenient this may be with respect to fencing the plants when young, and draining the soil, yet it is a great drawback to their progress afterwards, by preventing their roots from extending themselves, except on one side; and, by the drainage of the ditch, it also deprives them of their natural share of moisture. Wherever thorn hedges are planted, and intended to thrive, the ground ought to be trenched at least 2 ft. in depth, manured, if poor, and the plants inserted on a flat surface, so as to receive and retain the whole of the moisture that falls from the heavens. The margin of the ditch ought always to be 2 ft. or 3 ft. from the plants; and the earth excavated, instead of being raised into a ridge over the roots of the plants, and where it can be of little or no use to them, ought to be spread over the general surface, so as to increase the depth of nutritive soil. This mode of raising hedges would, doubtless, be attended with somewhat more expense, at first, than the present one; but it would be found cheaper in the end, by the more speedy production of a sufficient fence, and the consequent saving of temporary protecting fences. The prejudices, however, in favour of the present mode of hedging and ditching are so great, and are so generally diffused through every part of the country, that we can hardly hope that any new plan involving greater expense will be favourably listened to. It is necessary to have had some experience in planting, and to have participated in the enjoyment derived from seeing the extraordinarily rapid increase produced in plants by extraordinary care being bestowed on their culture, to induce a departure from ordinary practice. The object of planting and training hedges will be treated of at length in the succeeding part of this work; and, in the mean time, we may state that by far the best instructions which have been published for planting and raising hawthorn hedges will be found given by Mr. Stephens, in the *Quarterly Journal of Agriculture*, vol. ii. p. 621., and quoted in our *Encyclopædia of Agriculture*, 2d edit., p. 480.

Poetical and legendary Allusions. Hawthorn flowers have been identified with the floral games of May, and the beauties of spring, from time immemorial. Their scent is said to be not only reviving to the spirits, but to have the power of counteracting poison. They are regarded as the emblem of hope, and were carried by the girls in the wedding processions of the ancient Greeks, and laid on the altar of Hymen, which was lighted with torches made of the wood. The Troglodytes tied bunches of hawthorn to their dead, when they were buried. In some parts of France, the hawthorn is called l’épine noble, because it is supposed to have been the thorn used for crowning our Saviour; and the country people believe that it always utters groans and sighs on Good Friday. Others put a bunch of hawthorn in their hats during a thunder storm, to guard them from the lightning. The most remarkable legend connected with the hawthorn is that of the Glastonbury thorn. It

is said, that Joseph of Arimathea, after the burial of Christ, came to England, attended by twelve companions, to found the first Christian church in this island; and, guided by divine impulse, he proceeded to Glastonbury for that purpose. It was Christmas-day when he arrived at the spot where he had been commanded to build a church in honour of the Virgin Mary; and, finding that the natives did not appear inclined to believe in his mission, he prayed to God to perform a miracle to convince them. His prayer was immediately answered; and, on striking his staff into the ground, it immediately shot forth into leaves and blossoms. The legend adds that this thorn is still in existence, and still blossoms annually on Christmas-day. The French have a legend, that, on the day after the massacre of St. Bartholomew, on August 25th, an old thorn in the churchyard of St. Innocent, in Paris, came into blossom a second time.

The poets who have written on the hawthorn are almost as numerous as those who have written on the rose. Chaucer, in his *Court of Love*, makes all his court, on May-day, go forth, "both most and lest, to fetch the flouris fresh, and branche and bloome;" and

"Marke the faire blooming of the hawthorne tree,
Who finely cloathed in a robe of white,
Fills full the wanton eye with May's delight:"

and Shakspeare, in *Henry VI.*, asks:—

"Gives not the hawthorn bush a sweeter shade
To shepherds looking on their silly sheep,
Than doth a rich embroider'd canopy
To kings who fear their subjects' treachery?"

But, perhaps, no poet has ever conjured up a more beautiful picture of the hawthorn, than Goldsmith in his *Deserted Village*:—

"The hawthorn bush, with seats beneath the shade,
For talking age and whispering lovers made."

The custom of going a Maying, that is, going out early in the morning of the 1st of May to gather bunches of hawthorn flowers, is of very great antiquity. The Greeks and Romans gathered the May in honour of Flora, to whom the plant was dedicated, and whose festival began on May-day; and the Greeks, even of the present time, preserve the memorial of this custom by hanging a garland of hawthorn flowers against their doors on the 1st of May. In Britain, Stowe tells us that Henry VIII., with his queen Katherine, and the lords and ladies of their court, rode out a Maying, from Greenwich to Shooter's Hill; and in a curious M.S., entitled *The State of Eton School*, A.D. 1560, it is stated that, "on the day of St. Philip and St. James (May 1st), if it be fair weather, and the master grants leave, those boys who choose it may rise at 4 o'clock, to gather May branches, if they can do it without wetting their feet." In decking the May-pole with flowers, a branch of hawthorn was formerly always put on the top; but since the alteration of the style, in 1752, May-day occurring eleven days earlier, the hawthorn is seldom in blossom on that day, except in the southern parts of England. The hawthorn is the badge of the clan Ogilvy.

Soil and Situation. The hawthorn will do no good unless planted in a soil naturally dry and fertile, or that has been rendered so by art. The plant is never found naturally on a wet soil; and, if planted on such a soil, it soon becomes stunted, and covered with lichens and moss. The situation should be airy: but it will grow either in exposed places, or in such as are sheltered, and even shaded, by other trees. In cases of this kind, however, it neither forms a handsome tree, nor a close thick hedge.

Propagation and Culture. The species is almost always propagated by seeds, but sometimes by cuttings of the roots; which, when about half an inch in thickness, and 1 ft. or 18 in. in length, and planted with the root end undermost, speedily make large plants. Where old thorn plants are taken up, the roots may always be used for forming new hedges; but it must be acknowledged that, as they do not all send up shoots equally, some remaining

a year in the ground before they do so, the preferable mode is to plant them in a nursery for the first year; or, if this is not done, they ought to be planted thick, so as to make allowance for some not pushing till the second year, and some not pushing at all.

When the hawthorn is to be raised from seed, the haws should not be gathered till they are dead ripe; which will be in October or November. As many haws contain more than one seed, they ought not to be put in the ground entire, but, if they are to be sown immediately, they must be macerated in water till the pulp is separated from the nuts; and the latter should then be mixed with dry sand, to keep them separate, and to enable the sower to scatter them equally over the surface. But, as the seeds do not come up till the second year, a saving of ground is made by keeping them the first year in a heap mixed with a sufficient quantity of soil, to prevent them from heating, and to facilitate the decomposition of the pulp. These heaps are kept in the open air, and exposed to the full influence of the weather; care being taken to turn them over frequently, at least once a month, so as to equalise this influence. When the seeds are not to be prepared in a heap, they should be sown in November or December, as soon as separated from the pulp; but, when they are to be separated by decomposition, in what is technically called a rot-heap, they need not be sown till the February, or even the March, of the second year; by which means fifteen or sixteen months' use of the soil is saved. They may be sown thinly in beds, the seeds being scattered so as to lie about 1 in. apart every way, and covered about a quarter of an inch. The nursery culture required is mere routine. At the end of the first year's growth, the strongest of the plants may be thinned out from the beds, and planted in nursery lines; and in the autumn of the second year, the remaining plants may be taken up for the same purpose. Hawthorns ought always to be two years transplanted before they are employed for hedges; younger and untransplanted plants, though cheaper to purchase, are always the most expensive to the planter, as they require temporary protection for a longer period.

As stocks, hawthorn plants may be treated like stocks for fruit trees; and the different species and varieties may be budded and grafted on them in a similar manner. Not only the different species of *Crataegus*, but those of *Mespilus*, *Sorbus*, *Pyrus*, and even *Malus*, *Cydonia*, *Amelanchier*, and others, may be grafted on the common hawthorn; and in this way field hedges might be rendered ornamental, and even productive of useful fruits.

Statistics. Recorded old Hawthorn Trees. One is mentioned by Marsham, which, in 1755, stood by Hethel church, near Norwich, and measured in girth, at 4 ft. from the ground, 9 ft. 14 in.; one arm of it extending above 7 yards. (*Bath Soc. Pap.*, i. p. 66.) Dr. Walker notices the following large hawthorn trees in Scotland:—On the island in Loch Leven, in Fifeshire, in 1796, a tree girted 6 ft. 4 in., at 4 ft. from the ground; one at Castle Huntly, in Forfarshire, 6 ft. 10 in., at 3 ft. from the ground; one at Kinkarochie, in the parish of Scone, in Perthshire, 9 ft. in circumference at 4 ft. from the ground, the diameter of the head 42 ft.; at Blair, in Athol, a double-flowered hawthorn, standing in the "Wilderness," in 1770, 20 years planted, was 15 ft. high, with a trunk 2 ft. 4 in. circumference at 4 ft. from the ground. In Ireland, according to Hayes, the growth of the hawthorn far exceeds what takes place in England or Scotland. "There are, at Robert Stubber's, Esq., at Mayne, several white thorns of 7 ft. and 8 ft. in circumference, with heads finely formed, and great in proportion; so that, when in flower, there can be nothing more beautiful. I measured one 5 ft. 4 in. round the stem at 9 ft. high; the branches extending 15 yards; another, 7 ft. 6 in. round the stem, in the smallest part; the head entire, and covering a circle of 36 ft. in diameter; and a third, the branches of which extended round a very fair stem, 24 ft. on every side. This last is one of the most beautiful thorns I ever saw; but the largest I recollect to have ever seen is at Lord Gormanstown's, in the county of Meath. It was above 10 ft. in circumference, several years since it stood in the high road, and had received some injury, and was hooped round with bands of iron when I last saw it; so that, perhaps, it may have since decayed." (*Pract. Treat. on Plants*, p. 52.) There is a remarkable old thorn in Dalham Park, Suffolk, mentioned in Jesse's *Gleanings*, vol. iii. p. 272, but the dimensions are not given.

Crataegus Oxyacantha, and its Varieties, in the Environs of London. At Syon, and at various other places, the double-blossomed and the scarlet hawthorns are from 25 ft. to 30 ft. high. At Ham House there is a handsome tree of the variety with golden leaves, 13 ft. high. In the Hammer-smith Nursery, *C. O. melanocarpa* is 20 ft. high, diameter of the head 25 ft. and of the trunk 1 ft.

C. Oxyacantha, and its Varieties, South of London. In Devonshire, at Endsleigh Cottage, 20 years planted, and 22 ft. high, the diameter of the trunk 7 in., and of the head 14 ft.; and *C. O. rosea*, 20 years planted, and 18 ft. high, the diameter of the trunk 6 in., and of the head 12 ft. In Dorsetshire, at Melbury Park, the species, 100 years old, is 48 ft. high, the diameter of the trunk 2 ft. 2 in., and of the head 47 ft., in strong loam on clay; *C. O. rosea*, 50 years planted, and 22 ft. high, the diameter of the trunk 11 ft. 2 in., and of the head 30 ft., in loam on gravel; *C. O. praecox*, the Glastonbury thorn, 100 years planted, and 21 ft. high, the diameter of the trunk 1 ft., and of the head

25 ft. In Somersetshire, at Leigh Court, 14 years planted, 24 ft. high, the diameter of the trunk 7 in., and of the head 10 ft. In Surrey, at Claremont, 40 ft. high, the diameter of the trunk 18 in., and of the head 40 ft.; *C. O. rosea*, 30 ft. high, the trunk 14 in., and the head 24 ft. in diameter.

C. Oxyacantha, and its Varieties, North of London. In Berkshire, at White Knights, 30 years planted, and 20 ft. high; and *C. O. multiplex*, of the same age, 23 ft. high. In Buckinghamshire, at Temple House, the species 40 years planted, is 25 ft. high. In Cambridgeshire, at Wimpole, 25 ft. high. In Cheshire, at Kimmel Park, 34 ft. high, the diameter of the trunk 18 in., and of the head 22 ft. In Gloucestershire, at Doddington, *C. O. multiplex*, 30 ft. high, the trunk 19 in. diameter, and the diameter of the head 84 ft. In Nottinghamshire, in Clumber Park, the species is 36 ft. high. In Oxfordshire, in the Oxford Botanic Garden, *C. O. rosea*, 30 years planted, and 35 ft. high. In Pembrokehire, at Golden Grove, the species, 30 years planted, is 20 ft. high, diameter of trunk 18 in., and of the head 30 ft., on limestone; *C. O. multiplex*, 30 years planted, and 30 ft. high; *C. O. rosea*, 20 years planted, and 28 ft. high; and *C. O. aurea*, 20 years planted, and 15 ft. high. In Radnorshire, at Maeslough Castle, 29 ft. high. In Shropshire, at Hardwicke Grange, *C. O. multiplex*, 10 years planted, and 18 ft. high, the diameter of the trunk 9 in., and of the head 9 ft. In Staffordshire, at Trentham, *C. O. aurea*, 26 years planted, and 13 ft. high; at Alton Towers, *C. O. rosea*, 8 years planted, and 13 ft. high; at Wrottesley House, the species, 24 ft. high. In Suffolk, at Finborough Hall, 70 years planted, and 40 ft. high, the diameter of the trunk 3 ft., and of the head 40 ft., in clayey loam on clay; at Great Livermere, *C. O. rosea*, 35 years planted, and 27 ft. high, the diameter of the trunk 1 ft. 2 in., and of the head 34 ft.; *C. O. multiplex*, 35 years planted, and 35 ft. high. In Warwickshire, in a field near Rugby, there is a tree of the species, the branches of which are interwoven with one another like a piece of network, and hang down to the ground on every side, covering a space of 40 ft. in diameter, and the trunk of which is 5 ft. high, and 2 ft. 2 in. diameter, forming a singular and beautiful object; at Whitley Abbey, *C. O. præcox*, 13 years planted, and 10 ft. high. In Worcestershire, at Croome, the species, 20 years planted, is 25 ft. high; and *C. O. multiplex*, 25 years planted, is 25 ft. high.

C. Oxyacantha, and its Varieties, in Scotland. At Duddingston, near Edinburgh, is a tree of great age, which, in 1818, was measured by Sir Thomas Dick Lauder, and found to be, at 3 ft. above the root, 9 ft. in girt, and 12 ft. in girt a little way above the roots. This tree was measured for us, in 1836, by Mr. Barnet, curator of the Caledonian Horticultural Society's Garden: the total height is 43 ft., and the diameter of the space covered by the branches 44 ft.; the girt, at 3 ft. above the root, where it was measured by Sir T. Dick Lauder, is 9½ ft., and a little way above the root 10½ ft. At Barnton there is an old tree of the species 40 ft. high; diameter of the trunk, at 1 ft. from the ground, 3 ft. 6 in.; and at 4 ft., 4 ft. 1 in.; diameter of the head 44 ft. At Hopetoun House there is a tree of the species 20 ft. high, with a trunk 1 ft. 10 in. in diameter. In Ayrshire, at Kilkerran, it is 26 ft. high, the diameter of the trunk 2 ft., and of the head 27 ft. In Haddingtonshire, at Tynningham, 110 years planted, it is 46 ft. high, the diameter of the trunk 3 ft., and of the head 47 ft., in light loam on clay; and *C. O. multiplex*, 73 years planted, is 30 ft. high, the diameter of the trunk 1 ft. 10 in., and of the head 26 ft. At Fountains Hall there is a fine thriving tree, mentioned by Sir T. D. Lauder as having been produced from a hawthorn stake driven into a dead hedge. (*Laud. Gilt.*, I. p. 196.) In Renfrewshire, in the Glasgow Botanic Garden, *C. O. rosea*, 14 years planted, and 15 ft. high; and *C. O. multiplex*, of the same age, 13 ft. high. In Angusshire, at Kinnaird Castle, the species, 120 years planted, is 45 ft. high, the diameter of trunk 35 in., and of the head 40 ft., in sandy loam on clay; *C. O. rosea*, 40 years planted, and 30 ft. high. In Banffshire, at Gordon Castle, the species, 36 ft. high, the diameter of the trunk 1 ft. 4 in., and of the head 45 ft. In Fifeshire, at Danbristle Park, 35 years planted, and 30 ft. high.

C. Oxyacantha, and its Varieties, in Ireland. Near Dublin, at Cypress Grove, 27 ft. high, the diameter of the trunk 2 ft., and of the head 30 ft. At Terenure, *C. O. præcox* and *C. O. multiplex*, 40 years planted, and 20 ft. high. In Down, at Ballyleady, the species, 30 years planted, is 20 ft. high. In Fermanagh, at Florence Court, 40 years planted, and 30 ft. high. In Galway, at Cool, 28 ft. high, the diameter of the trunk 16 in., and of the head 47 ft., in loam on limestone. In Tyrone, at Barons' Court, 28 ft. high, with a head 60 ft. in diameter.

C. Oxyacantha, and its Varieties, in Foreign Countries. In France, at the Petit Trianon, near Versailles, 25 ft. high; at Toulon, in the Botanic Garden, 48 years planted, and 25 ft. high. In Saxony, at Wörlitz, 36 years planted, and 25 ft. high. In Prussia, in the Flauen Insel, 36 years planted, and 24 ft. high. In Bavaria, at Munich, in the Botanic Garden, 24 years planted, and 18 ft. high. In Sweden, in the Botanic Garden at Lund, *C. O. monogyna*, 22 ft. high. In Italy, at Monza, *C. O. monogyna*, 24 years planted, and 15 ft. high; and the species of the same age, 14 ft. high.

Commercial Statistics. Plants, in the neighbourhood of London, cost as follows:—One year's seedlings, from 2s. 6d. to 3s. per 1000; two years' seedlings, from 5s. to 6s. per 1000; transplanted plants, from 10s. to 15s. per 1000, according to their size. At Bollwyller, transplanted plants are 2 francs per 100. At New York, the *Cratægus Oxyacantha* is not cultivated as a hedge plant; but the varieties are propagated in the nurseries, and cost from 25 cents to 50 cents each.

§ xiii. *Parvifolia*.

Sect. Char. Leaves small, ovate, serrated or notched, but scarcely lobed.

Fruit green, or greenish yellow; rather large, hard.

25. *C. PARVIFOLIA* Ait. The small-leaved Thorn.

Identification. Ait. Hort. Kew., 2. p. 169.; Dec. Prod., 2. p. 627.; Don's Mill., 2. p. 598.

Synonyms. *Mespilus axillaris Pers. Syn.*, 2. p. 37.; *M. tomentosa Poir. Dict.*, 4. p. 443.; *M. xanthocarpus Lin. Fil. Suppl.*, 254.; *M. parvifolia Wats. Dend. Bril.*, *Cratægus tomentosa Lib. Sp.* 682., *Trew Ehr.*, t. 17.; *C. unidora Du Roi*; *C. viridis*, axillaris, betulifolia, florida, linearis, *Lodd. Cat.*; Gooseberry-leaved Thorn.

Engravings. *Trew Ehr.*, t. 17.; *Dend. Brit.*, t. 65.; *fig. 557.*; and *fig. 614.* in p. 867.

Spec. Char., &c. Leaves oval-lanceolate, incisedly serrated, pubescent. Flowers mostly solitary. Branchlets and calyxes villose. Stipules bristle-like.

Sepals serrated. Fruit almost top-shaped, yellow, or yellowish green. Nuts 5. (*Dec. Prod.*, ii. p. 627.) A native of North America; where, according to Pursh, it forms a low shrub in sandy shady woods, from New Jersey to Carolina. The leaves, he says, are small, and the fruit large, and of a greenish yellow. Seeds of this species were sent from Virginia



557

by Banister, and plants were raised from them in Bishop Compton's garden, at Fulham, previously to 1713: plants were afterwards raised by the Duke of Argyll at Whitton; in consequence of which it used formerly to be generally called Lord Iley's thorn. It forms a shrub, seldom exceeding 6 ft. or 7 ft. in height; having numerous slender branches, interwoven with one another, and armed with very long, slender, sharp thorns. The leaves are scarcely an inch long, but they vary much in breadth on the same plant, and in different seminal varieties. The flowers, which are white, are produced late in May and June; and the fruit also ripens late, hanging on the bushes all the winter. The largest plant that we know of this species is at Ham House, where it is evidently of considerable age, and, on its own root, has attained the height of 12 ft.; at White Knights, there are standards of it in the park, grafted on the common hawthorn, which are from 8 ft. to 10 ft. high; and, both there and at Ham House, they flower freely, and produce fruit every year.

Varieties.

✱ *C. p. 2 florida*, *C. florida* Lodd. *Cat.*, (*fig. 558.* and *fig. 613.* in p. 867.) has the leaves and fruit somewhat smaller and rounder than those of the species.

✱ *C. p. 3 grossulariaefolia*, *C. linearis* Lodd. *Cat.*, (*fig. 559.* and *fig. 616.* in p. 867.) has the leaves lobed, and somewhat like those of the gooseberry.

These varieties run so much into one another, that, unless they are seen together in a living state, as in Messrs. Loddiges's arboretum, it is difficult to distinguish them from the species, or from each other; for, however different the leaves may appear in our figures (see p. 867.), all the forms of these may occasionally be found on the same plant; and some plants of each variety are wholly without spines, while in others the spines are very numerous.



558

559

✱ 26. *C. VIRGINICA* Lodd. The Virginian Thorn.

Identification. Lodd. *Cat.*, ed. 1830, and ed. 1836.

Synonymy. *C. virginiana* Hort.

Engravings. *Fig. 560.*; and *fig. 615.* in p. 867.

Spec. Char., &c. Leaves obovate, cuneate, glabrous, shining, notched, but not lobed; small. Fruit round, rather larger than a common haw, green. A shrub, growing to the height of 4 ft. or 5 ft.; a native of Virginia; and introduced by Messrs. Loddiges in 1812. The plant bears a general resemblance to *C. spatulata* in its foliage and habit of growth; but the foliage of

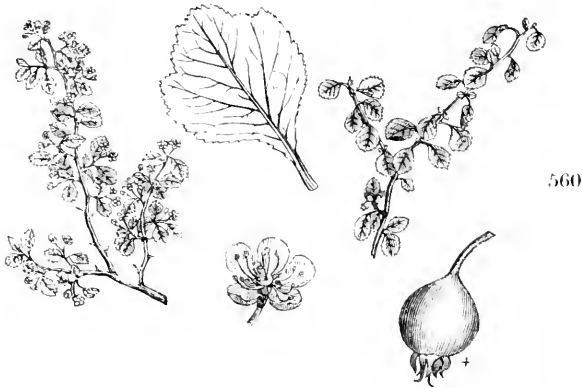

the latter is lobed, while that of the former is entire. The fruit of *C. virginica* is, also, six times larger than that of *C. spatulata*; and is of a dark green, while the other is of a bright red. The blossoms and fruit of *C. virginica* are, also, produced in corymbs of twos and threes; while those of *C. spatulata* consist of a considerable number of flowers. The species differ, also, in the foliage; which in *C. spatulata* has long winged footstalks, while in *C. virginica* the footstalks are short and slender. (See the leaves of *C. virginica* in *fig. 615.* in p. 867., of *C. spatulata* in *fig. 591.* in p. 861.)

§ xiv. *Mexicana.*

Sect. Char. Leaves large, oval-lanceolate, notched and serrated. Fruit large, green or greenish yellow.

† 27. *C. MEXICANA* *Moc. et Sesse.* The Mexican Thorn.

Identification. *Moc. et Sesse Fl. Mex. icon. inedit.*; *Dec. Prod.*, 2. p. 629.; *Swt. Brit. Fl.-Gard.*, 2d ser. t. 300.; *Don's Mill.*, 2. p. 601.

Synonyme. *C. stipulacea Lodd. Cat.*; see *Gard. Mag.*, ix. p. 630.

Engravings. *Swt. Brit. Fl.-Gard.*, 2d ser. t. 300.; our *fig. 617.* in p. 867.; and the plate of this species in our Second Volume.

Spec. Char., &c. Leaves oval-lanceolate, notched, and serrated; acuminate, somewhat ciliated at the base. Petioles short, channeled, and with a winged margin. Stipules stalked. Corymbs terminal. Petals scarcely longer than the calycine teeth. Stamens varying from 10 to 15. Styles 2, or rarely 4. Fruit large, pale green, or yellowish, when ripe; and, with the leaves, remaining on the tree all the winter in sheltered situations. Handsome, and resembling a small apple, but not good to eat. It is a low tree, a native of the table lands of Mexico, whence it was introduced in 1824, or earlier, apparently by Robert Barclay, Esq., of Bury Hill. (See *Gard. Mag.*, vol. ix. p. 630., and vol. xi. p. 473. and p. 583.) It was first described and figured from the garden of A. B. Lambert, Esq., of Boyton House, Wiltshire. It has fruited abundantly at Terenure, near Dublin, for several years; and, also, in the Garden of the Horticultural Society, and in the arboretum of Messrs. Loddiges. It is a most vigorous-growing species; and, when budded on the common hawthorn, it produces shoots from 5 ft. to 7 ft. long the first season; and there can be no doubt that it will form as large a tree as *Mespilus grandiflora*, which it strongly resembles in general

appearance and mode of growth. It grows readily by cuttings, or by budding or grafting. Against a wall in the Horticultural Society's Garden, it is completely evergreen.

§ xv. *Pyracantha*.

Sect. Char. Leaves oval-lanceolate, glabrous, entire, small, evergreen. Fruit numerous, of a bright coral colour.

■ 28. *C. PYRACANTHA Pers.* The fiery Thorn, or *Pyracantha*.

Identification. Pers. Syn., 2. p. 37.; Pall. Fl. Ross., 1. p. 29.; Dec. Prod., 2. p. 626.; Don's Mill., 2. p. 598.

Synonymes. *Mévilus Pyracantha L.*; evergreen Thorn; Buisson ardent, Fr.; immergrüne Mispel, Ger.

Engravings. Lob. Icon., 2. p. 182. f. 1.; Pall. Fl. Ross., t. 13. f. 2.; N. Du Ham., 2. t. 20. No. 2.; and our fig. 561.

Spec. Char., &c. Evergreen. Leaves glabrous, ovate-lanceolate, erenate. Lobes of the calyx obtuse. Styles 5. Fruit globose, scarlet, ornamental; continuing a good while upon the plant; which, on account of the colour of its fruit, and of its being a shrub, is called, in France, buisson ardent. (*Dec. Prod.*, ii. p. 626.) An evergreen shrub, a native of rugged places and hedges in the south of Europe. Introduced in 1629; flowering in May, and producing abundance of fruit, which are very ornamental, and remain on all the winter; especially when the shrub is trained against a wall. The berries are bitter, and are not so greedily eaten by birds, as those of some other kinds, unless in very severe winters. The plant is very hardy, and, in the open garden, forms a handsome evergreen bush; but it has been used since its first introduction chiefly for clothing naked walls; and no plant has a more showy appearance in winter, when it is covered with its brilliant scarlet berries, which has given rise to its French name of buisson ardent, or the burning bush. It thrives in any soil that is dry, and in a northern as well as a southern exposure. It is propagated by seeds or cuttings; but the strongest plants are obtained by budding it on the common thorn; and, if grafted standard high, it would form a most desirable evergreen low tree.



Variety.

- *C. P. 2 crenulata, C. crenulata Roxb. MSS., Lindl. in Lin. Trans., 13. p. 106., Don's Mill., ii. p. 598.; Mévilus crenulata D. Don, Prod., p. 238.* is a native of Nepal. There is a plant of this variety in the Garden of the Horticultural Society; where it was raised from seed in 1830, and now forms a bush 2 ft. high.

§ xvi. *Glauca*.

Sect. Char. Evergreen. Leaves elliptic, downy and glaucous beneath.

‡ 29. *C. GLAU'CA Wall.* The glaucous-leaved evergreen Thorn.

Identification. Wall. Cat., 673.; Lodd. Cat., ed. 1830, and 1836.

Engravings. Figs. 562, 563.

Spec. Char., &c. Leaves elliptic, tapering to both ends, acute, serrulated at the apex, downy and glaucous beneath, but glabrous above. Corymbs terminal, many-flowered. Calyx woolly. Flowers white. (*Don's Mill.*, ii. p. 598.) A native of Nepal, where it forms an evergreen tree, 20 ft. high. Plants of it were raised from seed, in the Garden of the London Horticultural Society, in 1828, one of which has stood as a bush in the open garden upwards of 5 years, and is nearly evergreen; and another, which has stood against a wall for the same period, is completely evergreen. The latter



of these plants flowered for the first time in 1836, and from it our figures were taken. As the foliage and habit of this species seem different from those of the genus *Cratægus*, when it produces fruit a new generic name will, probably, be assigned to it. In the mean time, *C. glauca* is a most desirable evergreen for training against a wall, in climates colder than that of London; and for forming dwarfs or standards, in similar, or warmer, climates. It forms a very suitable associate for *Photinia serrulata* and *P. arbutifolia*; and all of these plants succeed perfectly, when grafted on the common hawthorn.

App. i. *Synopsis of the Species of Cratægus growing, in 1836, in the Horticultural Society's Garden.* By Mr. Gordon.

The authorities after the names are, in most cases, those of the nurserymen, or other persons, from whom the plants were received by the Society.

§ i. MICROCA'RPE (or those with small fruit, resembling *C. microcarpa*). See p. 825.

Leaves lobed, or angulated, and shining. Spines middle-sized. Fruit very small, red, and remarkably late.

1. *C. microcarpa* *Dr. Lindley* (*Bot. Reg.*) fig. 591. in p. 861., and the plate in Vol. II. syn. *spatulata* *Loddiges* (*Hackney Nursery*). *florida* *Godfrey* (*Ville d'Avry Nursery, near Paris*).
Habit of the plant spreading and *pendulous*. One of the latest in coming into leaf, flower, and fruit.
2. *C. cordata* *Lodd.*, fig. 590. in p. 861., and the plate in Vol. II. syn. *acerifolia* *Fischer* (*Bot. Gard., Petersburg*). *populifolia* *Fischer*. *phanopyrum* of *Lin.* in foreign collections.
Habit erect. Leaves angulated, and the latest of all in flowering.

§ ii. OXYACA'NTHE (or those resembling the common Hawthorn). See p. 829.

DIVISION I. Leaves lacinate. Spines small. Fruit middle-sized, and mostly containing but one seed.

3. *C. Oxycantha*, fig. 602. in p. 865., and the plate in Vol. II. syn. *Oxycantha vulgaris* *Smith* (*Ayr Nursery*).
Habit rather spreading.
4. *C. Oxycantha flexuosa* *Smith*.
Habit spreading, and branches very much twisted. Very distinct.
5. *C. Oxycantha præcox* *Mr. G. Lindley* (*Norwich*). syn. *Glastonbury Thorn* *Ronalds* (*Brentford Nursery*).
Only differing from the common sort in its early habit.
6. *C. Oxycantha eriocarpa* *Dr. Lindley*, fig. 607. in p. 865., and the plate in Vol. II. Habit spreading, and very robust. Fruit red. One of the latest in leafing.
7. *C. Oxycantha capitata* *Smith*.
Habit erect, and only differing from the common in flowering more at the extremity of the branches.
8. *C. Oxycantha monogyna* *Dr. Lindley*. syn. *eriocarpa monogyna* *Godfrey*. *Oxycantha sibirica* *Lec* (*Hammer-smith Nursery*). *sibirica* *Loddiges*.
Habit spreading and dwarf. Fruit red. One of the earliest in leaf.
9. *C. Oxycantha flava* *Lindley*, fig. 610. in p. 866. Habit dwarf and spreading. Fruit yellow, remarkably sweet, and containing 3 or 4 seeds.
10. *C. Oxycantha flore pleno*. syn. *Oxycantha flore pleno rubro* *Ronalds*. *oxycanthoides flore pleno* *Sweet Cat.*, fig. 609. in p. 866.
Habit more compact than that of the common *Oxycantha*; and the leaves more shining, and rounder. It is called *C. O. fl. pl. rubro* by some; because the flowers, more especially on loamy soils, die off of a reddish colour; but the only kind with a double red flower is noticed under 19.
11. *C. Oxycantha lucida* *Smith*. syn. *oxycanthoides lucida* *Sweet*.
Habit rather spreading, and, probably, the single var. of the preceding.
12. *C. Oxycantha variegata* *Masters*, *Canterbury Nursery*.
Only differing from the common in the beautiful variegated leaves.
13. *C. Oxycantha transylvanica* *Booth* (*Hamburg Nursery*). syn. *Oxycantha quercifolia* *Booth*, fig. 608. in p. 866.
Habit rather erect. Fruit red, and rather robust.
14. *C. Oxycantha laciniata* *Lodd.*, fig. 608. in p. 866., and the plate in Vol. II. syn. *laciniata* *Lec*. *pterifolia* *Booth*, fig. 604. in p. 865.

- Habit pendulous. Fruit red, and very early in leaf.
15. *C. Oxyacantha pendula* Smith, see the plate in Vol. II.
syn. *Oxyacantha reginæ* M'Nab (Edinburgh Bot. Gard.).
Queen Mary's Thorn M'Nab., fig. 556., and the plate in Vol. II.
Habit pendulous. Fruit red; very early in leaf.
16. *C. Oxyacantha folio aúreo* Lodd.
Only differing from the common in its unsightly yellowish green leaves.
17. *C. Oxyacantha stricta* Ronalds, see the plate in Vol. II.
syn. *Oxyacantha rígida* Miller (Bristol Nursery).
vulgaris rígida Miller.
Habit fastigiate, and forming a head like the Lombardy poplar. Fruit red.
18. *C. Oxyacantha rósea* Austin (Glasgow Nursery).
syn. scarlet Thorn Ronalds.
Oxyacantha rubra Lec.
Only differing from the common in the deep tint of its flowers.
19. *C. Oxyacantha rósea superba* Turnbull (Perth Nursery).
syn. *Elegans* Miller.
punicea (of foreign collections.)
Only differing from the preceding in its dark crimson flowers. There is a new double scarlet (of *C. rósea superba*) at the Camberwell Nursery, of which I have only seen a very small plant.
20. *C. oxyacanthoides* Godefroy, fig. 601. in p. 864., and the plate in Vol. II.
syn. *triloba* Dr. Lindley (Bot. Reg.).
French Hawthorn (of some collections.)
Only differing from the common in its blunt, lobed, shining, and more entire leaves. See p. 830.
21. *C. Oxyacantha melanocarpa* Fischer, fig. 605. in p. 865., and the plate in Vol. II.
syn. *Oxyacantha platyphýlla* Lodd.
Oxyacantha incisa Lec.
incisa Ronalds.
Habit spreading and robust. Fruit black, and containing more than one seed.
22. *C. Douglásii* Dr. Lindley (Bot. Reg.), fig. 584. in p. 858., and the plate in Vol. II.
Habit erect. Fruit purple, and very late in leafing. See p. 823.
23. *C. apifolia* Lodd., fig. 588. in p. 860.
Habit rather pendulous and dwarf. Fruit red. See p. 826., and p. 825.
24. *C. apifolia major*, fig. 589. in p. 860., and the plate in Vol. II.
Only differing from the preceding in its more robust habit.

Division II. *Leaves* lobed, or lacinate. *Spineless*. *Fruit* small.

25. *C. heterophýlla* Godefroy, fig. 600. in p. 864., and the plate in Vol. II.
syn. *constantinopolitana* Godefroy.
Habit rather erect. Fruit red, and only 1-seeded. See p. 829.
26. *C. nigra* Lec, fig. 581. in p. 857., and the plate in Vol. II.
syn. *carpática* Loddiges.
Habit rather erect. Fruit black.
27. *C. purpurea* Ronalds, fig. 582. in p. 857., and the plate in Vol. II.
syn. *sanguinea* (of some collections).
altáica Loddiges, Dr. Ledebour.
Fruit black. (There is a variety with dark red fruit.) See p. 823.
28. *C. Oliveriana* Godefroy, fig. 606. in p. 865., and the plate in Vol. II.
syn. *olivæformis* Noisette (Paris Nursery).
olivæfolia Godefroy.
Habit spreading. Leaves pubescent. Fruit black. See p. 831.

§ iii. ARO'NIÆ (or those resembling the large-fruited *C. Arónia*). See p. 826.

Division I. *Leaves* incised and pubescent. *Spineless*. *Fruit* very large, red or yellow.

29. *C. Arónia* Lec, fig. 593. in p. 862., and the plate in Vol. II.
syn. *fissa* Loddiges.
Oliveriana M'Nab.
Habit upright. Fruit very large, and yellow.
30. *C. tanacetifolia* Lec, fig. 597. in p. 863., and the plate in Vol. II.
syn. *pinnata* Austin.
Habit erect, with few ramifications. Fruit yellow. The largest of all in the collection.
31. *C. tanacetifolia glabra* Loddiges, fig. 598. in p. 863., and the plate in Vol. II.
Chiefly differing from the preceding in its glabrous leaves.
32. *C. maurocæna* ? Godefroy, fig. 594. in p. 862., and the plate in Vol. II.
Habit rather upright. Fruit yellowish red.
33. *C. Azardus* Whitley (Fulham Nursery), fig. 592. in p. 862., and the plate in Vol. II.
Habit rather spreading. Fruit red.
34. *C. orientalis* (of *Pallas*) Lindley, fig. 596. in p. 863., and the plate in Vol. II.
Habit pendulous. Fruit dark-red.
35. *C. odoratissima* Austin, fig. 595. in p. 863., and the plate in Vol. II.
syn. *tomentosa* Ronalds. (This name, *tomentosa*, is properly a syn. to *parvifolia*.)
Habit pendulous. Fruit light red.

Division II. *Leaves* nearly entire, or lobed. *Spines* few, and rather large. *Fruit* large and yellow.

36. *C. mexicæna* Hort. Soc., fig. 617. in p. 867., and the plate in Vol. II. See p. 843.
syn. *stipulææ* ? Whitley.
Habit rather spreading. Fruit very large, yellow. This is nearly *evergreen*.

§ iv. COCCI'NEÆ (or those resembling *C. coccinea*). See p. 816.

Division I. *Leaves* 5-lobed, large, and in some more or less serrated. *Spines* large. *Fruit* large and numerous.

37. *C. coccinea* Ronalds, fig. 564. in p. 851., and the plate in Vol. II.
syn. *æstivális* Booth.
large-fruited American Azarole M'Nab.
thornless American (of some collections).
Habit fastigiate, or rather spreading. Fruit red. Spineless, except when young and growing vigorously.
38. *C. coccinea máxima* Loddiges.
syn. *coccinea spinosa* Godefroy.

Habit rather spreading. Fruit large and red.

39. *C. corállina* Loddiges, fig. 565. in p. 852.
syn. *coccinea pyriformis* (of some collections).
Habit rather upright. Fruit bright red.
40. *C. geórgica* Douglas.
Habit fastigiate, rather slender. Fruit red.
41. *C. subvillósa* Fischer, Petersburg, fig. 550., and fig. 568. in p. 853.
Habit spreading. Fruit red.
42. *C. glandulosa* Lindley, fig. 567. in p. 853., and the plate in Vol. II.
syn. *rotundifolia* Booth.
sanguinea of *Pallas*.

- Habit fastigiata. Fruit red.
 43. *C. glandulosa succulenta Fischer.*
 syn. *succulenta Fischer.*
Mespilus succulenta Booth.
 Only differing from the preceding in the fruit, which is large, and more succulent; whence the name.

DIVISION II. *Leaves* like those of the preceding division. *Spines* remarkably large. *Fruit* small.

44. *C. macracantha M'Nab, fig. 572.* in p. 855, and the plate in Vol. II.
 syn. *spinosissima longissima Lec.*
 Habit very much spreading, and robust.
 Fruit small, shining, and red.

DIVISION III. *Leaves* entire, or serrated. *Spines* less. *Fruit* large, and punctated

45. *C. punctata Austin, fig. 569.* in p. 854, and the plate in Vol. II.
 syn. *punctata rubra Loddiges.*
edulis Ronalds.

Habit spreading, horizontal. Fruit large, and red.

46. *C. punctata flava Austin, fig. 570.* in p. 854, syn. *dulcis Ronalds.*

pentagyna flava Godefroy.
 Habit spreading, like the preceding one.
 Fruit yellow, and large.

47. *C. punctata stricta Ronalds.*
 syn. *punctata rubra stricta Austin.*
 Habit fastigiata. Fruit large, and red.

DIVISION IV. *Only* differing from the last division in the fruit being very small.

48. *C. pyriformis Lec, fig. 571.* in p. 854, and the plate in Vol. II.

syn. *latifolia Ronalds.*
cornifolia Booth.
Calpodendron Fischer.

Habit spreading. Branches much twisted.
 Fruit small, red. This is the *C. flexuosa* of some foreign collections.

§ v. CRU'S-GA'LLI (or those resembling the Cock's-spur Thorn). See p. 820.

Leaves entire, or serrated, and shining. *Spines* large. *Fruit* middle-sized.

49. *C. ovalifolia Lindley, fig. 579.* in p. 856, and the plate in Vol. II.
 syn. *elliptica Loddiges.*
pennsylvanica Loddiges.

Habit very much spreading. Fruit red.

50. *C. prunifolia Loddiges, fig. 576.* in p. 856, and the plate in Vol. II.
 syn. *hybrida Booth.*
caroliniana Lec.

Habit rather erect. Fruit red.

51. *C. Crus-galli Lindley, fig. 574.* in p. 856, and the plate in Vol. II.
 syn. *cuneifolia Booth.*
hyemalis Fischer.
lucida Godefroy.

Habit spreading. Fruit red.

52. *C. Crus-galli splendens Lindley, fig. 575.* in p. 856.
 syn. *Crus-galli latifolia Booth.*
arbutifolia Masters.

Habit spreading. Fruit red.

53. *C. Crus-galli Pyracantha Masters, fig. 580.* in p. 856, and the plate in Vol. II.
 syn. *pyracanthifolia Lec.*

Habit spreading and slender. Fruit yellowish green.

54. *C. Crus-galli salicifolia Ronalds, fig. 578.* in p. 856.
 syn. *linearis Loddiges,* and *Lee, fig. 577,* in p. 856.

Habit of growth horizontal. Fruit yellowish green.

§ vi. VI'RIDES (or those resembling *C. viridis* and *C. lobata*, with hard green fruit). See p. 841. and p. 823.

Leaves small, lobed, or finely serrated. *Spines* small, and not numerous. *Fruit* small, green, and hard.

55. *C. viridis Loddiges, fig. 614.* in p. 867.
 syn. *parvifolia Pursh,* and *Loddiges, fig. 557.*

florida Lodd., fig. 613. in p. 867.

axillaris Audibert (Tarascon Nursery, South of France).

? ? *grossulariifolia Lec, fig. 559,* and *fig. 616.* in p. 867.

tomentosa of Pallas, not of others.
 Habit very dwarf, and rather rigid. Fruit green.

56. *C. virginiana Loddiges, fig. 615.* in p. 857.
 syn. *viridis* (of some collections).

The dwarfest of all in the collection. Fruit bright green.

57. *C. lobata, fig. 554,* and *fig. 586.* in p. 859.

syn. *spinosissima Lec.*

lutea (of some collections).

Habit straggling and robust. Fruit green.

Bark very rough.

58. *C. flava Loddiges, fig. 585.* in p. 859, and the plate in Vol. II.
 syn. *flavissima Godefroy.*

Michauxii (of some foreign collections).

Habit very spreading. Fruit yellowish green. Bark rough.

§ vii. PYRACA'NTHÆ. Leaves entire, evergreen. See p. 844.

Doubtful.

59. *C. Pyracantha, fig. 561.*

syn. *Mespilus Pyracantha Lindl.*

Habit bushy. Leaves ovate-lanceolate, nearly entire. Fruit numerous, flame-coloured red.

60. *C. P. crenulata Wall.*

Only differs from the preceding in having crenulate leaves.

61. *C. glauca Park's China, figs. 562, 563.*

Probably not a *Crataegus*, being evergreen.

Remarks. The preceding table, independently of its botanical merits, we consider of great value in a practical point of view; because it does not contain a single species or variety that is not, at the present moment (April, 1836), growing in the London Horticultural Society's Garden; and because it points out the names of the nurseries from which these plants were sent to the Society. Whoever, therefore, wishes to form a collection of *Crataegus* (and we do not think that there is another genus of hardy ligneous plants at all to be compared with it in point of beauty, variety, and general interest) can find no difficulty in gratifying his wishes. He may procure almost every species and variety from the principal London nurserymen, at from 1s. 6d. to 2s. 6d. each; or, if he does not choose to go to that expense, and is a Fellow of the Horticultural Society, he may obtain scions from the Society, at the grafting or budding season, which may be sent packed in moss, either in winter or summer, to the most distant parts of the island; and which may be grafted or budded on the common hawthorn. If hawthorn stocks should not be already provided, the buds or grafts may be inserted in the plants of a common hedge, at regular distances, and the shoots

produced trained as standards. All this might be done by any gentleman living in the country (whatever may be the soil or climate of his estate), who keeps a head gardener, without incurring 20s. of extra expense; and it would not be easy to point out any other mode, at once so simple and so effectual, for creating a botanical and floral interest in verdant scenery. Those who have not paid much attention to this family of low trees, we would recommend to visit the Horticultural Society's Garden in the months of May and September; and to observe, more particularly in May, the different varieties of *C. Oxyacantha*, *C. heterophylla*, *C. coccinea*, *C. Crús-gállii*, *C. punctata*, and *C. macracantha*; and, in September, *C. Ardnia*, *C. orientalis*, *C. tanacetifolia*, *C. maroccana*, *C. heterophylla*, and *C. cordata*; but, indeed, if we were to mention all the species and varieties which we think eminently beautiful, we should be compelled to repeat Mr. Gordon's enumeration.

App. ii. *Additional Species of Cratægus.*

Notwithstanding the number of sorts of *Cratægus* already in the country, there appear to be several yet to introduce; and it is highly probable that there are some European and Asiatic sorts, and many American kinds, as yet undiscovered by botanists. We are informed by a botanist who has lately travelled through a considerable part of the United States and of Canada, that numbers of sorts of *Cratægus* accompanied him almost every where; and that, from the different appearances they presented in different soils and situations, he was quite puzzled to know what to make of them. He made the same remark with respect to the genus *Quercus*. Mr. McNab, jun., of the Edinburgh Botanic Garden, has, we understand, brought from America a great number of seeds of the genus *Cratægus*, from which some new sorts may confidently be anticipated. The following names occur in De Candolle's *Prodromus*, and in Don's *Mill.*; some of which, in all probability, are mere synonyms of kinds already in the country; but others may belong to kinds not yet introduced.

§ i. *Leaves toothed, or nearly entire, never angularly lobed.*

C. subspinosa Dec. Prod., 2. p. 626. *Méspilus subspinosa Vent.*, is a native of Chili, with fruit only half the size of a pea, and nearly dry.

C. prunellifolia Bosc in Dec. Prod., ii. p. 627., the Prunella-leaved Thorn, is said to resemble in habit *Prunus spinosa*; but its native country and flowers are unknown. (*Don's Mill.*, 2. p. 598.)

C. latifolia Pers. (*Don's Mill.*, ii. p. 598.) is a native of North America, with oval red fruit; said to have been introduced in 179; but where it is to be found, or of what sort it is a synonyme, we have been unable to ascertain.

C. flexuosa Poir. (*Don's Mill.*, ii. p. 598.) is a native of Carolina, with entire obovate pubescent leaves; spines very long, and blackish; and fruit of a reddish yellow.

C. alpina Mill. Dict., No. 3., (*Don's Mill.*, ii. p. 599.) is said to be a native of Mount Baldo, and other Italian mountains; and, of course, was in cultivation in Miller's time: but of what sort it is a synonyme, or whether it is now in the country, is uncertain.

C. vilca Poir. (*Don's Mill.*, ii. p. 599.) has ovate pubescent leaves, long and strong spines; and its native country is unknown. From the description, it appears to be different from either the *C. Oxyacantha aurea* or the *C. flava* of British gardens.

C. pauciflora Pers., *Méspilus pauciflora Poir.*, is a native of Switzerland, about Lausanne, with solitary flowers; probably a variety of *Méspilus grandiflora*.

C. unilateralis Pers. (*Don's Mill.*, ii. p. 599.) is a native of Carolina, with the corymbs of flowers unilateral. Dried specimens are in the herbarium of A. B. Lambert, Esq.

C. licida Mill. Dict., No. 6., (*Don's Mill.*, ii. p. 599.) has lanceolate serrated leaves, very long spines, and pale red flowers. We do not know of any plant now in the country answering to this description.

§ ii. *Leaves variously lobed, or cut.*

C. turbinata Pursh (*Don's Mill.*, ii. p. 599.) is a native of Carolina and Virginia; and, according to Pursh, allied to *C. spathulata*.

C. pentágyna Waldst. et Kit. (*Don's Mill.*, ii. p. 599.) is a native of Hungary; and, obviously, only a variety of *C. Oxyacantha*.

C. kyrtóstyla Fing. (*Don's Mill.*, ii. p. 600.) is monogynous, with a curved style, as the name implies; and seems only a variety of the common hawthorn.

C. laciniata Dec. Prod., ii. p. 629., is a native of Sicily, with pinnatifid leaves, and white flowers; said to have been introduced in 1816, and to be allied to *C. Azarolus*; but we know nothing of the plant.

C. lævigata Dec. Prod., 2. p. 630., *Méspilus lævigata Poir.*, is a native of the Vosges.

C. Poirctiana Dec. Prod., 2. p. 630., *Méspilus lineáris Poir.*, has obovate leaves, somewhat lobed: its native country is unknown; but, though it is said to have been introduced in 1810, we have not seen the plant. From the leaves being lobed, it is evidently different from the *Méspilus lineáris* of the Jardin des Plantes, which is a synonyme of *C. Crús-gállii salicifolia*.

C. pectinata Bosc (*Dec. Prod.*, ii. p. 630.) is a native of Persia; said to be allied to *C. tanacetifolia*; and, if so, it cannot be the same as *C. Oxyacantha pectinata* of Booth.

C. trifoliata Bosc, *C. quinquelobata* Bosc, *C. odorata* Bosc, *C. obovata* Bosc, *C. flavescens* Bosc, *C. flabellata* Bosc, *C. bicida latifolia* Boll. Cat., and *C. licida média* Boll. Cat., are names to which no descriptions have been attached.

App. iii. *Alphabetical List of Sorts of Cratægus in the Arboretum of Messrs. Loddiges, as given in their Catalogue, 16th edition, 1836; with some Additions, taken from the Names placed against Plants in their Nursery, but not in the Catalogue; referred to the Species and Varieties of Cratægus as given in this Work.*

The use of this list is to assist persons who have purchased collections of *Cratægus* from Messrs. Loddiges, according to the names of the 15th and

16th editions of their *Catalogue*, 1833 and 1836, in identifying them with our names. Most of the collections of *Cratæ`gus*, not only in Britain but on the Continent, having been procured from the Hackney arboretum, we think this list will be of considerable utility both to nurserymen and amateurs. It is proper to observe, that the numerous synonyms in this list, and in that following (App. iv.), arise from the circumstance of Messrs. Loddiges collecting annually, from all quarters, whatever appears from the name to be a new sort, and growing the plants with the names attached to them which were received with them, for 2 or 3 years, till it has been clearly proved whether they are really new or not. It is only by this practice that collections of any kind can be rendered complete.

Those names which are applied to the same plants, both in the *Catalogue* of Messrs. Loddiges, and in the *Arboretum Britannicum*, are in small capitals.

Names placed against the Plants in the Arboretum of Messrs. Loddiges.	Names which the same Sorts bear in the Arboretum Britannicum.	Names placed against the Plants in the Arboretum of Messrs. Loddiges.	Names which the same Sorts bear in the Arboretum Britannicum.
altæica.	purpûrea.	odoratissima.	orientâlis.
apiifolia.	apiifolia mlnor.	Olivèria.	Oxyacantha Oliveriàna.
mâjor.	apiifolia.	orientâlis.	Oxyacantha Oliveriàna.
arbutifolia.	Crûs-galli splendens.	OXYACA`NTHA.	OXYACA`NTHA.
axillaris.	parvifolia.	APET`TALA.	APET`TALA.
AZARU`LUS.	AZARU`LUS.	AU`REA.	AU`REA.
betulerifolia.	parvifolia.	CAPITA`TA.	CAPITA`TA.
caroliniana.	Crûs-galli prunifolia.	fl. plèno.	multiplex.
carpathica.	nigra.	fl. rôseo.	rôsea.
Celsiàna.	Oxyacantha Celsiàna.	FOL. ARG`NTEIS.	FOL. ARG`NTEIS.
cerasifera.	Crûs-galli splendens.	FOL. AU`REIS.	FOL. AU`REIS.
COCCU`NEA.	COCCU`NEA.	incisa.	laciniata.
MA`XIMA.	MA`XIMA.	lutescens.	? lutea.
corallina.	corallina.	PE`NDULA.	PE`NDULA.
CORDA`TA.	CORDA`TA.	platyphÿlla.	melanocarpa.
CRU`S-GA`LLI.	CRU`S-GA`LLI.	PRÆ`COX.	PRÆ`COX.
cuneifolia.	nigra.	PUNI`CEA.	PUNI`CEA.
dentata.	Crûs-galli ovalifolia.	REGI`NÆ.	REGI`NÆ.
Douglâsii No. 1.	punctata.	STRIC`TA.	STRIC`TA.
Douglâsii No. 2.	Douglâsii.	tortuosa.	flexuosa.
edulis.	punctata flava.	PARVIFOLIA.	PARVIFOLIA.
elliptica.	Crûs-galli ovalifolia.	pectinata.	Oxyacantha pteridifolia.
criocarpa.	Oxyacantha criocarpa.	pentagyna.	purpûrea.
fissa.	Arònia.	pterifolia.	Oxyacantha pteridifolia.
FLA`VA.	FLA`VA.	pubescens.	tanacetifolia.
flavens.	punctata flava.	punctata.	pyrifolia.
florida.	parvifolia.	PURPU`REA.	PURPU`REA.
georgica.	spathulata.	pyracanthifolia.	Crûs-galli pyracanthifolia.
GLAU`CA.	GLAU`CA.	pyrifolia.	Crûs-galli pyracanthifolia.
glandulifera.	pyrifolia.	quercifolia.	Oxyacantha quercifolia.
GLANDULO`SA.	GLANDULO`SA.	radiata.	pyrifolia.
grossulariæfolia.	Crûs-galli prunifolia.	salicifolia.	Crûs-galli salicifolia.
HETEROPHY`LLA.	HETEROPHY`LLA.	sanguinea.	purpûrea.
hybrida.	Crûs-galli prunifolia.	sibirica.	Oxyacantha sibirica.
incla.	Oxyacantha laciniata.	SPATHULA`TA.	flava lobata.
indentata.	coccinea indentata.	flava lobata.	Crûs-galli prunifolia.
ingèstria.	? coccinea maxima.	mexicana.	glandulosa subvillidosa.
Kilmânii.	Oxyacantha laciniata.	TANACETIFO`LIA.	TANACETIFO`LIA.
laciniata.	parvifolia.	GLA`BRA.	GLA`BRA.
lineâris.	LOBA`TA.	tomentosa.	orientâlis.
LOBA`TA.	Crûs-galli pyracanthifolia.	TRILOBA`TA.	TRILOBA`TA.
lucida.	MACRACA`NTHA.	VIRGI`NICA.	parvifolia.
MACRACA`NTHA.	MACRACA`NTHA.	xanthocarpa.	Oxyacantha aurea.
melanocarpa.	Oxyacantha (fructu rubro).		
monogyna.	Oxyacantha monogyna.		
napolitana.	? coccinea.		
NIGRA.	NIGRA.		

App. iv. *Alphabetical List of the Species and Varieties of Cratæ`gus described in the Arboretum Britannicum, with the Names which are appended to the Specimen Plants of these Sorts in the Arboretum of Messrs. Loddiges.*

The use of this list is to make known to intended purchasers of sorts of *Cratæ`gus*, figured or described in the *Arboretum Britannicum*, under what names they must ask for them from Messrs. Loddiges. There are only a very

few sorts not in the collection at Hackney, but we have indicated where they may be procured. There are very full collections of *Crataegus* in the Hammersmith Nursery, in the Fulham Nursery, in the Camberwell Arboretum, and in Mr. Donald's arboretum at Goldworth; but these collections are without a number of sorts which are contained in the arboretum at Hackney.

Those names which are applied to the same plants, both in the *Arboretum Britannicum* and in Messrs. Loddiges's *Catalogue* for 1836, are in small capitals; and those taken from the Hackney arboretum *Catalogue*, where there are more synonyms than one, are in italics.

Names in the Arboretum Britannicum.	Names in the Arboretum Hackniense.	Names in the Arboretum Britannicum.	Names in the Arboretum Hackniense.
1. <i>apiifolia</i> .	<i>apiifolia</i> major.	43. <i>Ox. FO'LII AU'REIS.</i>	<i>Ox. FO'LII AU'REIS.</i>
2. minor.	<i>apiifolia</i> .	44. <i>LACINIA'FA.</i>	<i>LACINIA'FA.</i>
3. <i>AZAROLUS.</i>	<i>AZAROLUS.</i>	45. <i>leucocarpa.</i>	We have not seen a plant of this variety, but there can be no doubt that it exists somewhere.
4. (<i>Azarolus</i>) <i>Aronia.</i>	fissa.	46. <i>lucida.</i>	There is a plant in the Hort. Soc. Garden.
5. (<i>Azarolus</i>) <i>maroc- cæna.</i>	We know of only one tree of this sort in England, that in the Hort. Soc. Garden, of which there is a portrait in our Second Volume.	47. <i>melanocarpa.</i>	A plant of <i>Ox.</i> , with red fruit, has the name of <i>melanocarpa</i> attached to it.
6. <i>COCCI'NEA.</i>	<i>COCCI'NEA.</i>	48. <i>monógyna.</i>	<i>Ox. monógyna.</i>
7. <i>corállina.</i>	<i>corállina.</i>	49. <i>múltiplex.</i>	<i>flöre plëno.</i>
8. <i>indentáta.</i>	<i>indentáta.</i>	50. <i>obusáta.</i>	Wanting. There is a plant in the Hort. Soc. Garden.
9. <i>MA'XIMA.</i>	<i>COCCI'NEA MA'XIMA.</i>	51. <i>Oliveriána.</i>	{ <i>Ox. Olivéria.</i>
10. <i>CORDA'TA.</i>	<i>CORDA'TA.</i>	52. <i>PE'NDULA.</i>	{ <i>orientális.</i>
11. <i>CRU'S-G'ALLI.</i>	<i>CRU'S-G'ALLI.</i>	53. <i>PRÆ'COX.</i>	<i>Ox. PE'NDULA.</i>
12. <i>lineáris.</i>	<i>lineáris.</i>	54. <i>PRÆ'COX.</i>	<i>PRÆ'COX.</i>
13. <i>nána.</i>	We are not aware of there being any plants of this variety in the London collections.	55. <i>pteridifolia.</i>	{ <i>pterifolia.</i>
14. <i>ovalifolia.</i>	<i>elliptica</i>	56. <i>PUNI'CEA.</i>	{ <i>pectináta.</i>
15. <i>prunifolia.</i>	<i>caroliniana.</i>	57. <i>punica fl. pl.</i>	<i>Ox. PUNI'CEA.</i>
16. <i>pyracanthifolia.</i>	<i>pyracanthifolia.</i>	58. <i>purpurea.</i>	There are plants in the Camberwell Arboretum.
17. <i>salicifolia.</i>	<i>salicifolia</i>	59. <i>quercifolia.</i>	There are plants in the Epsom Nursery.
18. <i>spléndens.</i>	{ <i>arbutifolia.</i>	60. <i>REGI'NÆ.</i>	<i>quercifolia.</i>
19. <i>DOUGLA'SII.</i>	<i>spléndens.</i>	61. <i>ròsea.</i>	<i>Ox. REGI'NÆ.</i>
20. <i>FLA'VA.</i>	<i>DOUGLA'SII</i> No. 2.	62. <i>sibirica.</i>	<i>fl. ròsea.</i>
21. (<i>flava</i>) <i>lobata.</i>	<i>FLA'VA.</i>	63. <i>STRÍ'CTA.</i>	<i>sibirica.</i>
22. (<i>flava</i>) <i>trilobata.</i>	<i>lobata.</i>	64. <i>transylvánica.</i>	<i>Ox. STRÍ'CTA.</i>
23. <i>GLANDULO'SA.</i>	<i>trilobata.</i>	65. <i>PARVIFOLIA.</i>	There is a plant in the Hort. Soc. Garden.
24. <i>subvillòsa.</i>	<i>GLANDULO'SA.</i>	66. <i>flòrida.</i>	{ <i>PARVIFOLIA.</i>
25. <i>succulénta.</i>	<i>subvillòsa.</i>	67. <i>grossulariæfolia.</i>	{ <i>avilàris.</i>
26. <i>GLAT'CA.</i>	There was, in 1835, a plant of this variety in the Hort. Soc. Gard., which has since been removed.	68. <i>punctata.</i>	{ <i>betulifolia.</i>
27. <i>HETEROPHY'LLA.</i>	<i>GLAT'CA.</i>	69. <i>aúrea.</i>	{ <i>flava.</i>
28. <i>MACRACA'NTHA.</i>	<i>HETEROPHY'LLA.</i>	70. <i>rùbra.</i>	There are plants in the Hort. Soc. Garden.
29. minor.	<i>MACRACA'NTHA.</i>	71. <i>rùbra strícta.</i>	There are plants in the Hort. Soc. Garden.
30. <i>mexicana.</i>	We received specimens of a variety, to which we have given this name, from Somersford Hall.	72. <i>PURPU'REA.</i>	<i>PURPU'REA.</i>
31. <i>nigra.</i>	<i>stipulæca.</i>	73. <i>altáica.</i>	<i>altáica.</i>
32. <i>orientális.</i>	<i>carpathica.</i>	74. <i>Pyracántha.</i>	<i>Méspilus Pyracántha.</i>
33. <i>sanguínea.</i>	{ <i>odoratissima.</i>	75. <i>crenulata.</i>	There are plants in the Hort. Soc. Garden.
34. <i>OXYACA'NTHA.</i>	<i>toméntosa.</i>	76. <i>pyrifolia.</i>	There are plants in the Hort. Soc. Garden.
35. <i>APE'TALA.</i>	Wanting. There are plants in the Fulham Nursery under the name of <i>C. orientális.</i>	77. <i>SPATHULA'TA.</i>	{ <i>SPATHULA TA.</i>
36. <i>aurantiaca.</i>	<i>OXYACA'NTHA.</i>	78. <i>TANACETIFO'LIA.</i>	{ <i>geòrgica.</i>
37. <i>AU'REA.</i>	<i>APE'TALA.</i>	79. <i>GLA'BRA.</i>	<i>TANACETIFO'LIA.</i>
38. <i>CAPITA'TA.</i>	There is a plant in the Hort. Soc. Garden.	80. <i>Lecæna.</i>	{ <i>pubèscens.</i>
39. <i>CELSiána.</i>	<i>Ox. AU'REA.</i>	81. <i>VIRGI'NICA.</i>	{ <i>TANACETIFO'LLIA GLA'BRA.</i>
40. <i>ERIOCA'RPA.</i>	<i>CAPITA'TA.</i>		There are plants in the Hammersmith Nursery.
41. <i>flexuòsa.</i>	<i>CELSiána.</i>		<i>VIRGI'NICA.</i>
42. <i>FO'LII ARGE'NTIES.</i>	<i>ERIOCA'RPA.</i>		
	<i>tortuòsa.</i>		
	<i>FO'LII ARGE'NTEIS.</i>		

In the above list, and in that which precedes it, there are one or two cases attended with some doubt, from the smallness of the plants; they being only received into the collection the last or the preceding spring, and having not yet flowered. The principal case of doubt is *C. lutescens* Lodd. *Cat.*; and we have accordingly put a point of interrogation before *C. Ox. lutea*, which we consider to be its synonyme. Before those names which we consider somewhat doubtful, we have also placed points of interrogation.

Cratægus coccinea. The scarlet-fruited Thorn.
Leaves and fruit of the natural size.

564

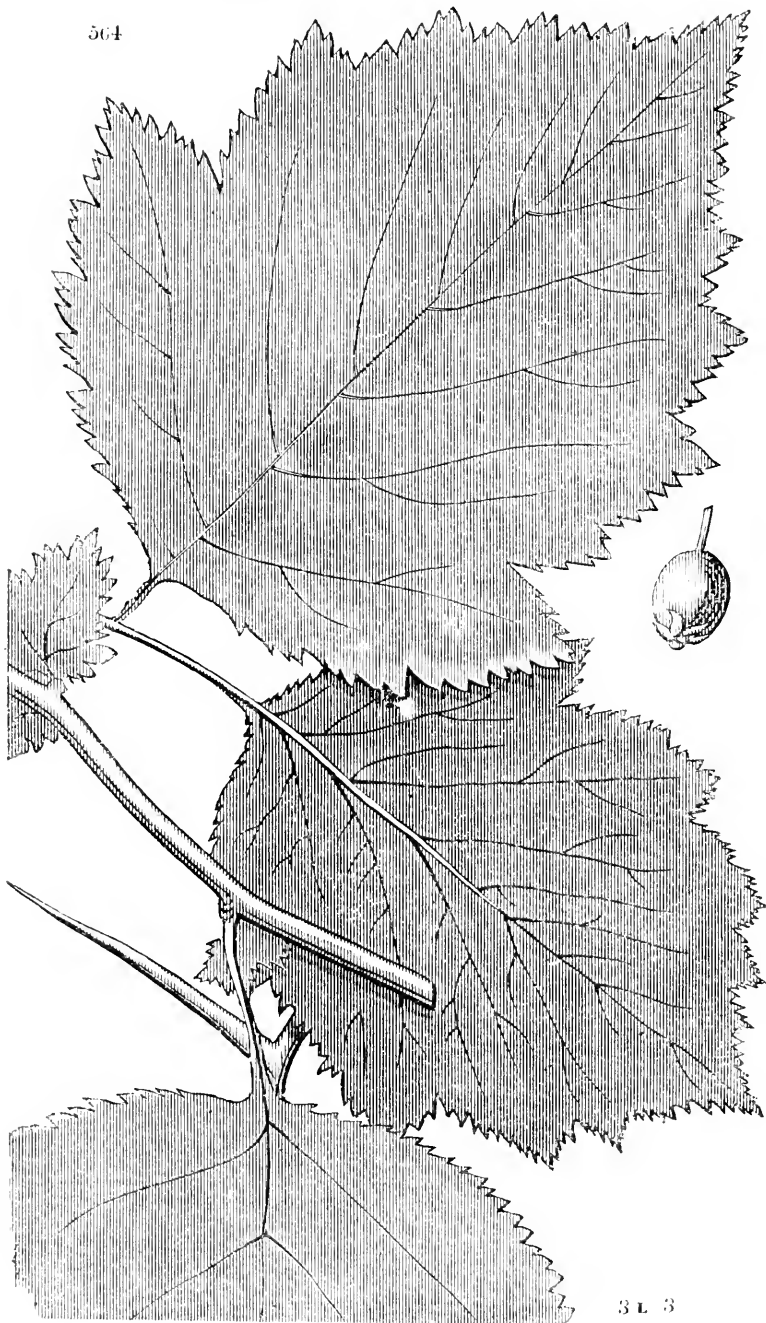

Crataegus coccinea corallina, and *C. c. indentata*. The coral-fruited Thorn, and the indented-leaved Thorn.

Leaves and fruit of the natural size.

565

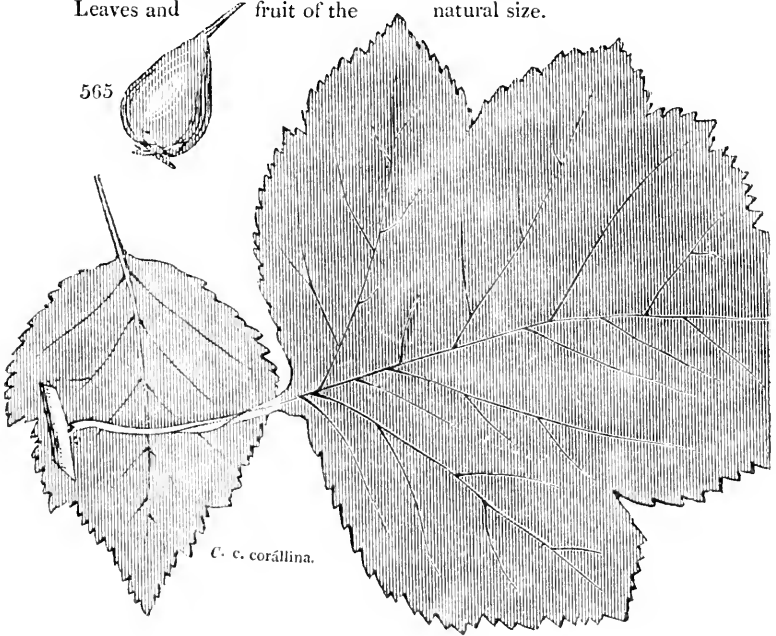

C. c. corallina.

566

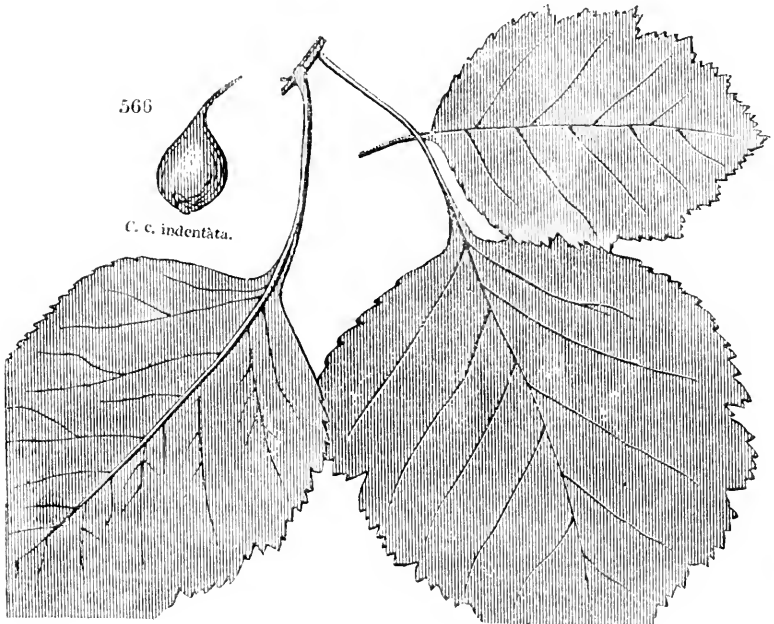

C. c. indentata.

Cratægus glandulosa, and *C. g. subvillosa*. The glandular Thorn, and the subvillose-leaved glandular Thorn.

Leaves and fruit of the natural size.

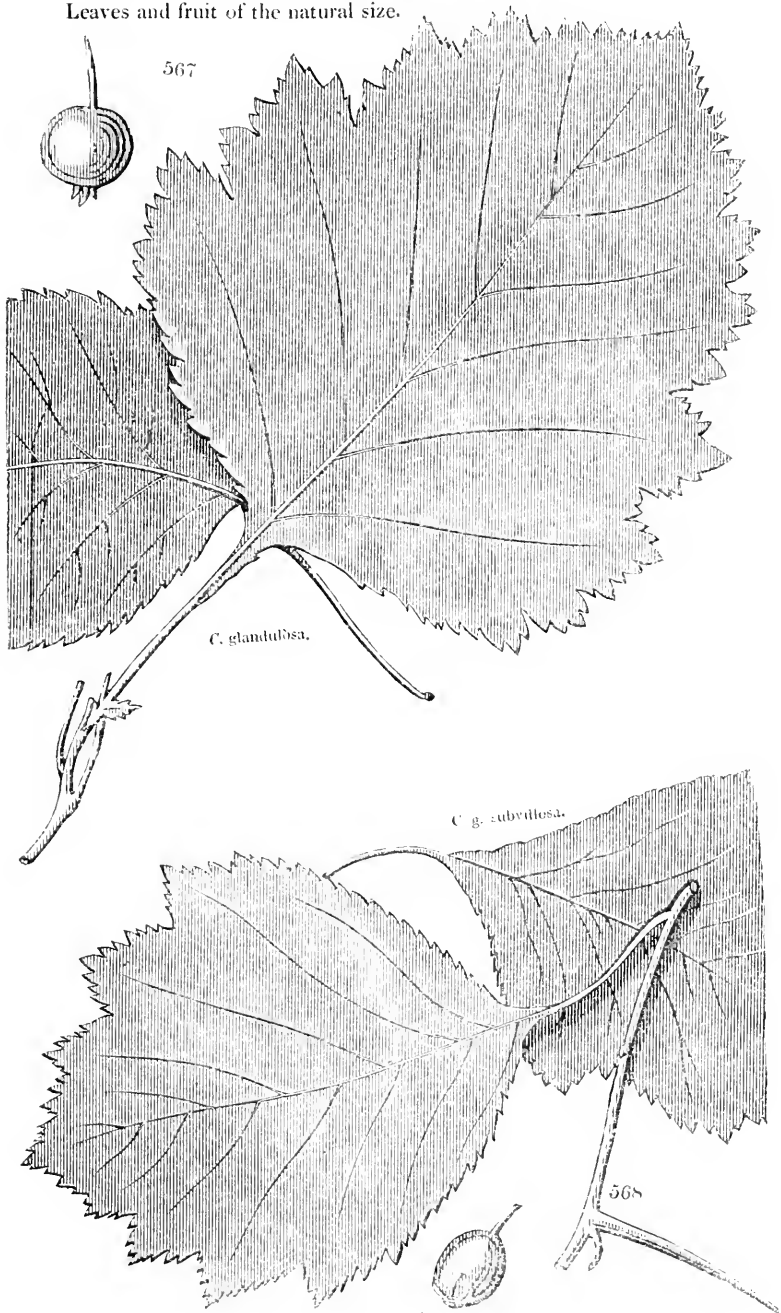

C. glandulosa.

C. g. subvillosa.

568

Crataegus punctata, and *C. pyrifolia*. The dotted-fruited Thorn, and the Pear-leaved Thorn.

Leaves and

fruit of the

natural size.

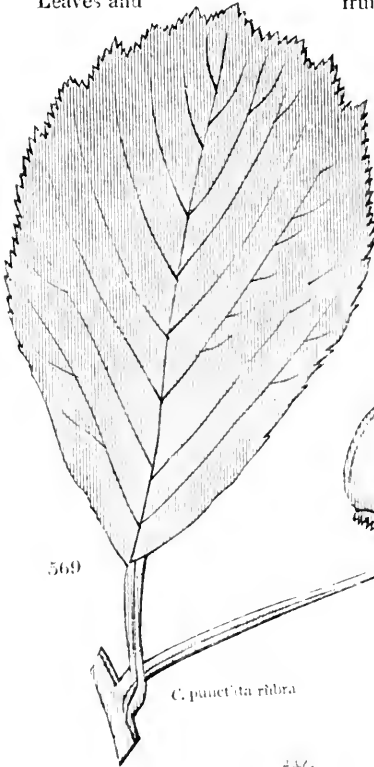

C. punctata ridra

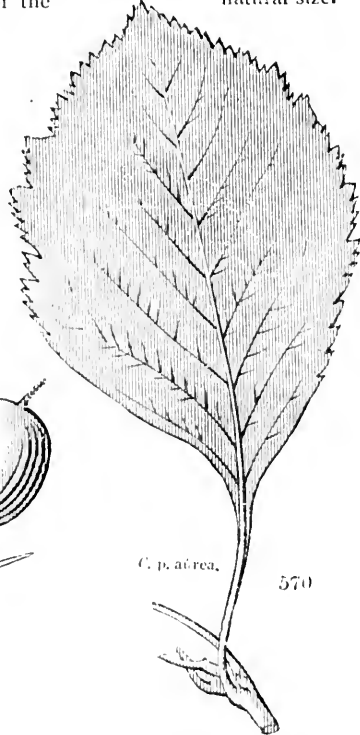

C. p. aurea.

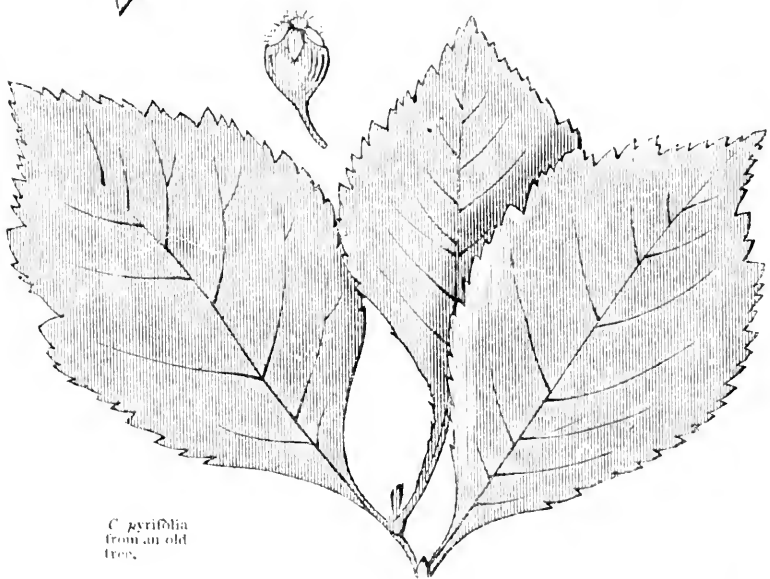

C. pyrifolia
from an old
tree.

Cratægus macracantha. The long-spined Thorn.
Leaves and fruit of the natural size.

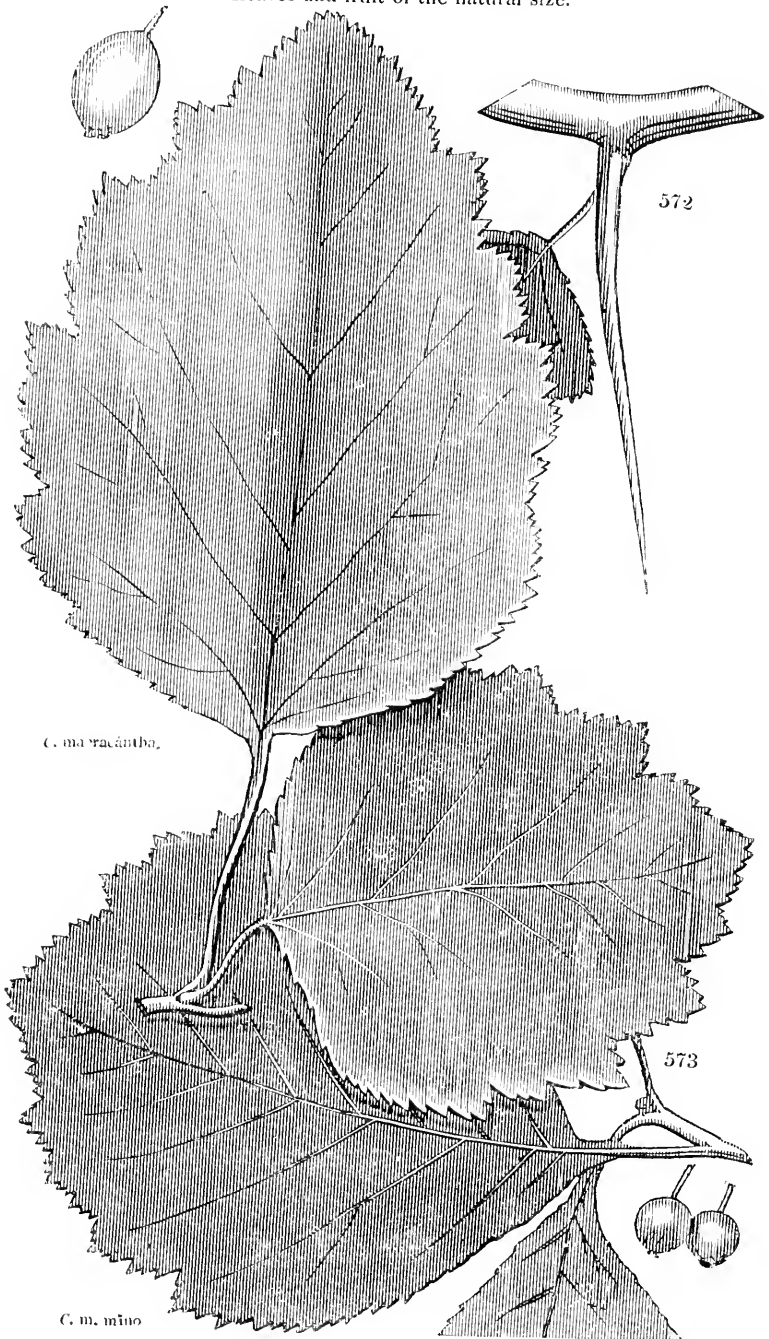

C. macracantha.

C. m. mīno

Crataegus Crús-gálli, et var. The Cock's-spur Thorn, and its varieties.
Leaves and fruit of the natural size.

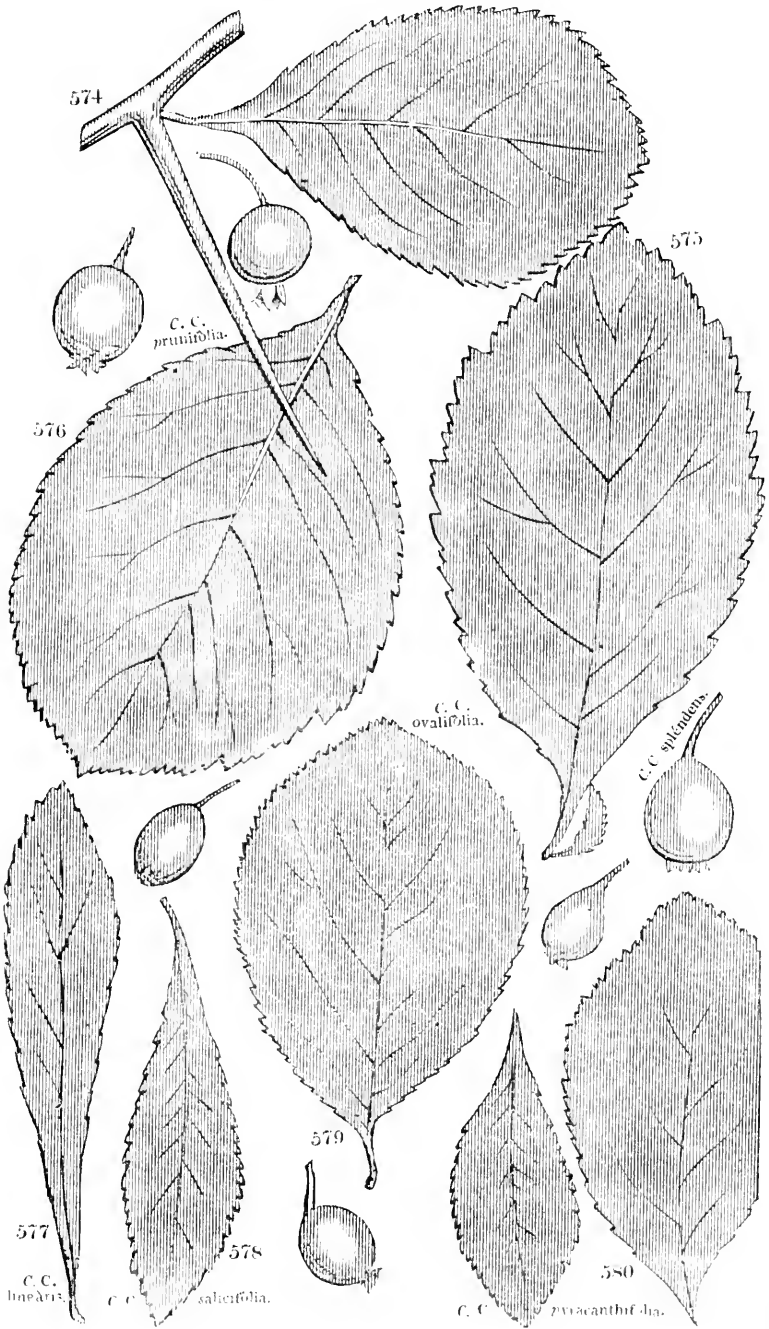

Cratægus nigra, and *C. purpurea*. The black-fruited Thorn, and the purple-branched Thorn.

Leaves and fruit of the natural size.

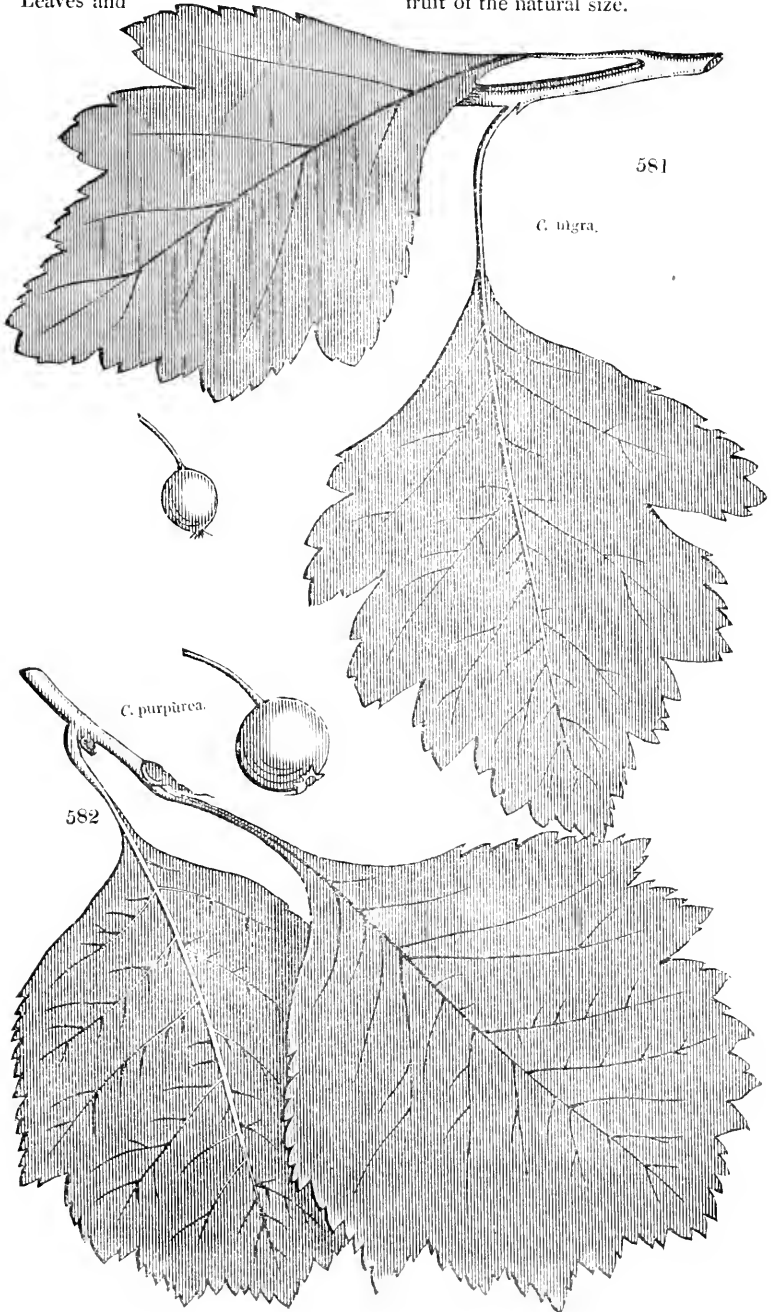

Crataegus purpurea altaica, and *C. Douglàsii*. The Altaic purple-branched Thorn, and Douglas's Thorn.

Leaves and fruit of the natural size.

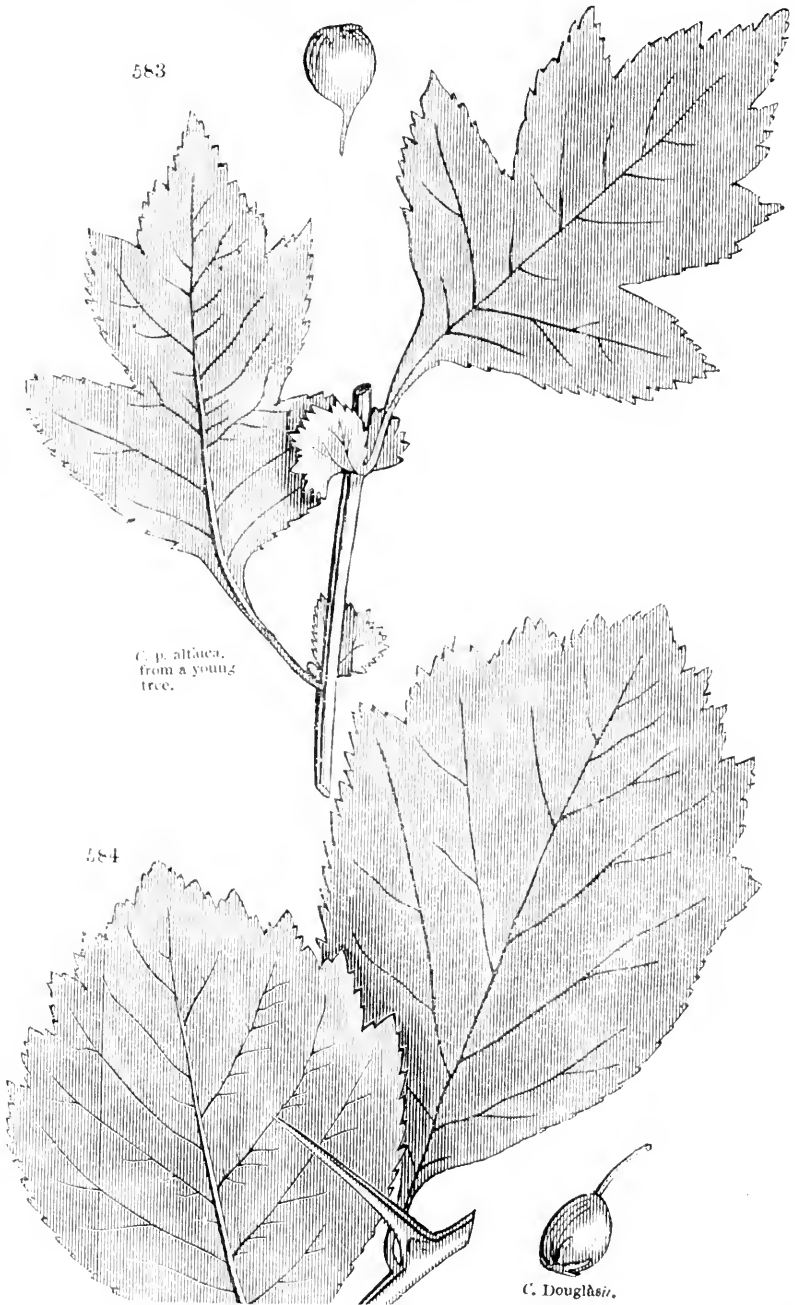

Cratægus flava, and *C. lobata*. The yellow-fruited Thorn, and the lobed-leaved Thorn.

Leaves and fruit of the natural size.

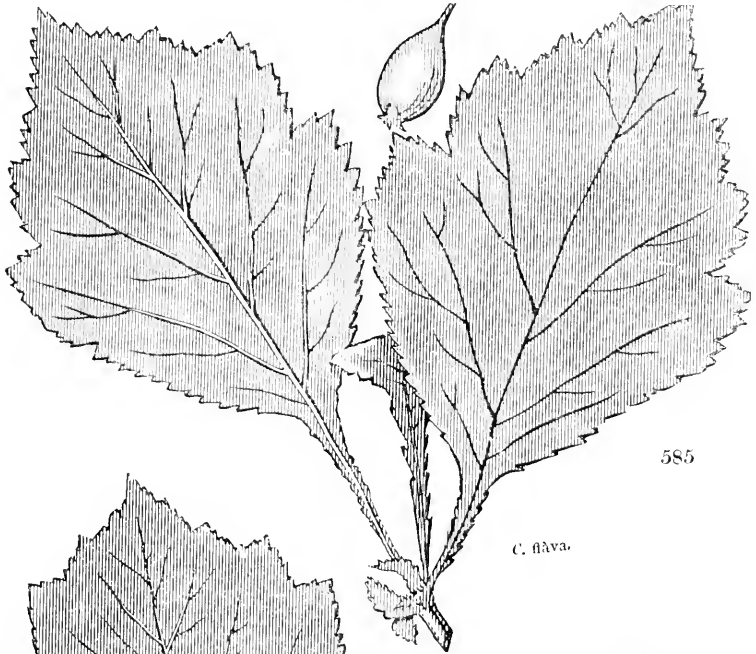

C. flava.

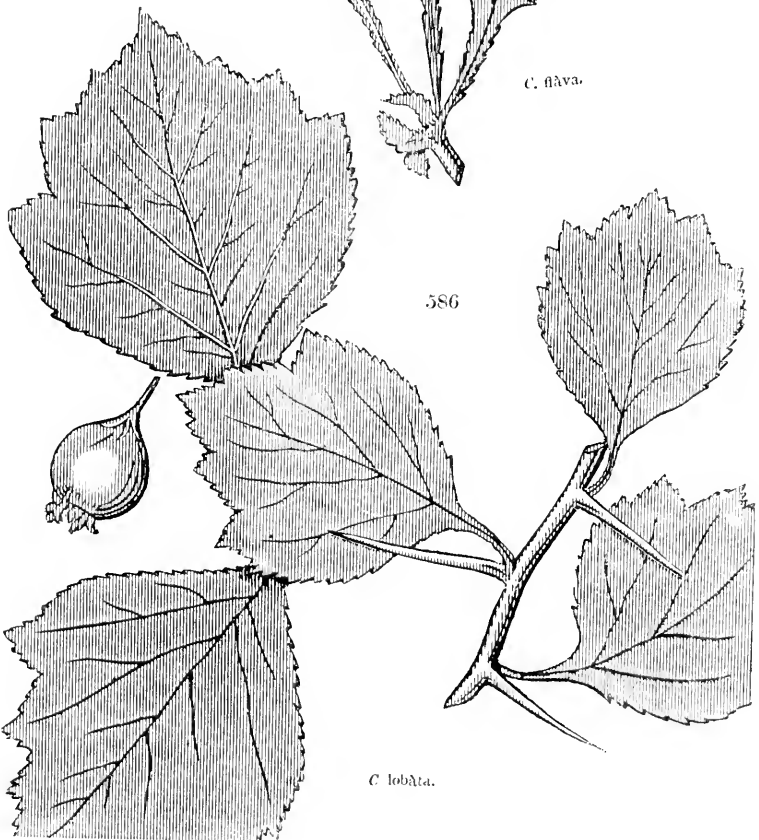

C. lobata.

Cratægus trilobata, and *C. apiifolia*. The three-lobed-leaved Thorn, and the Parsley-leaved Thorn.

Leaves and fruit of the natural size.

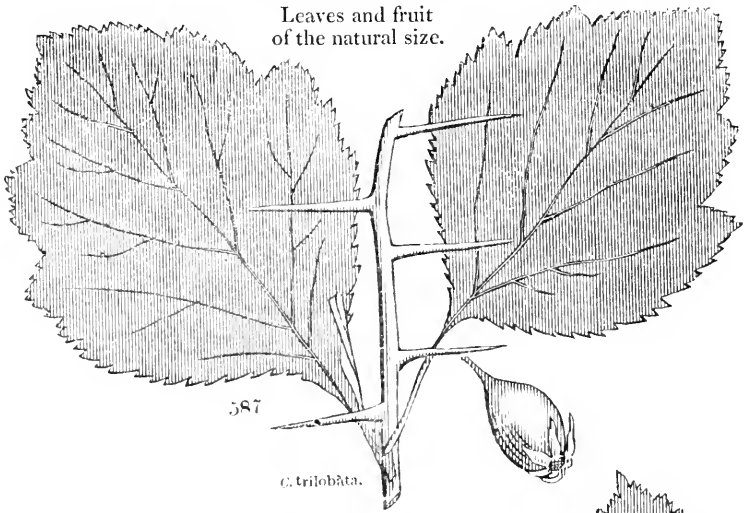

C. trilobata.

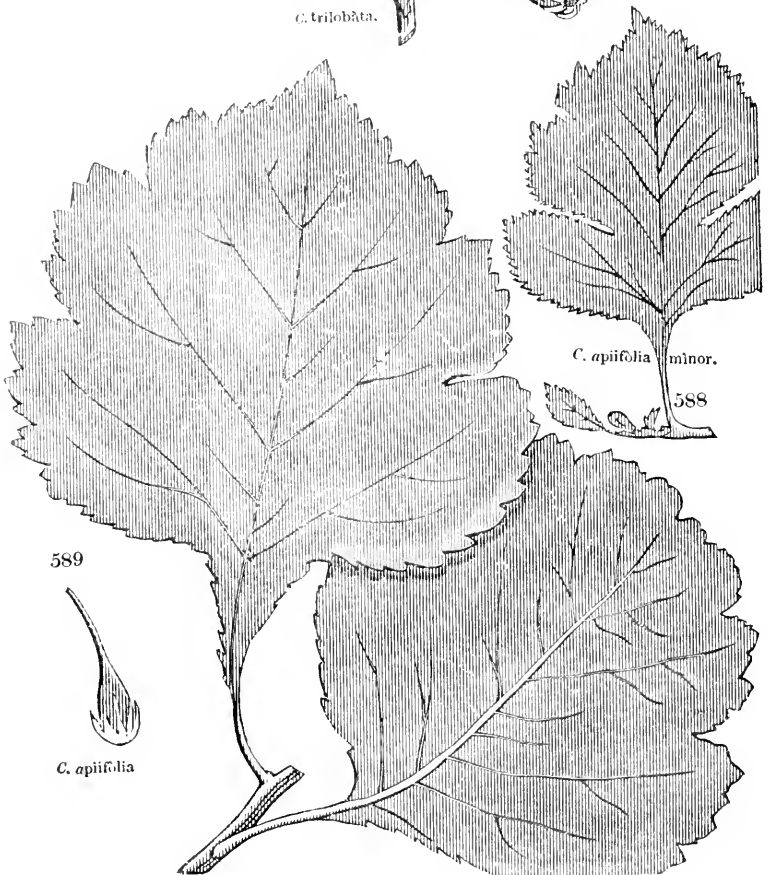

C. apiifolia

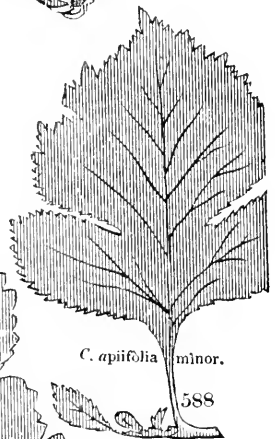

C. apiifolia minor.

588

Cratægus cordata, and *C. spathulata*. The heart-shape-leaved Thorn, and the spathula-shape-leaved Thorn.

Leaves and fruit of the natural size.

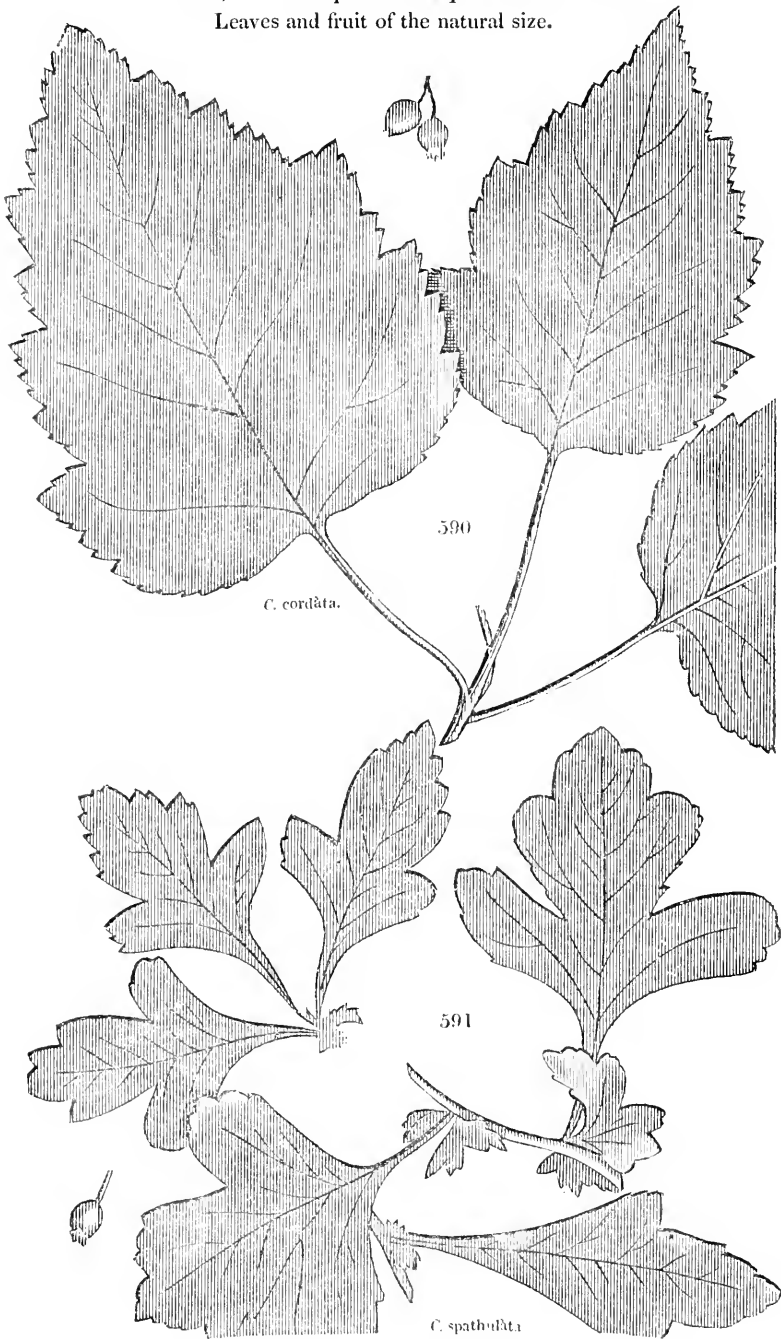

Crataegus Azaròlus, *C. Arònia*, and *C. maroccàna*. The Azarole Thorn, the Aronia Thorn, and the Morocco Thorn.
 Leaves and fruit of the natural size.

592

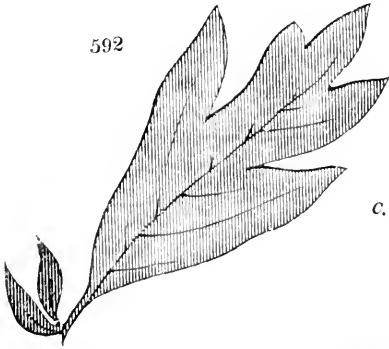

C. Azaròlus.

593

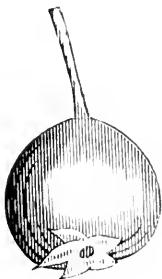

C. Arònia.

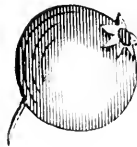

C. maroccàna.

594

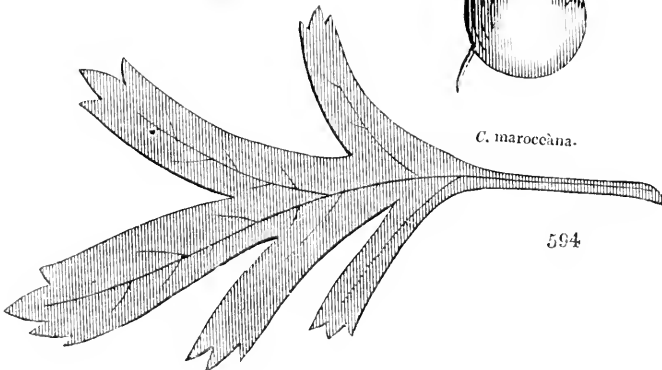

Cratægus orientális, et var., and *C. tanacetifolia*, et var. The Eastern Thorn, and the Tansy-leaved Thorn, with Varieties.

Leaves and fruit of the natural size.

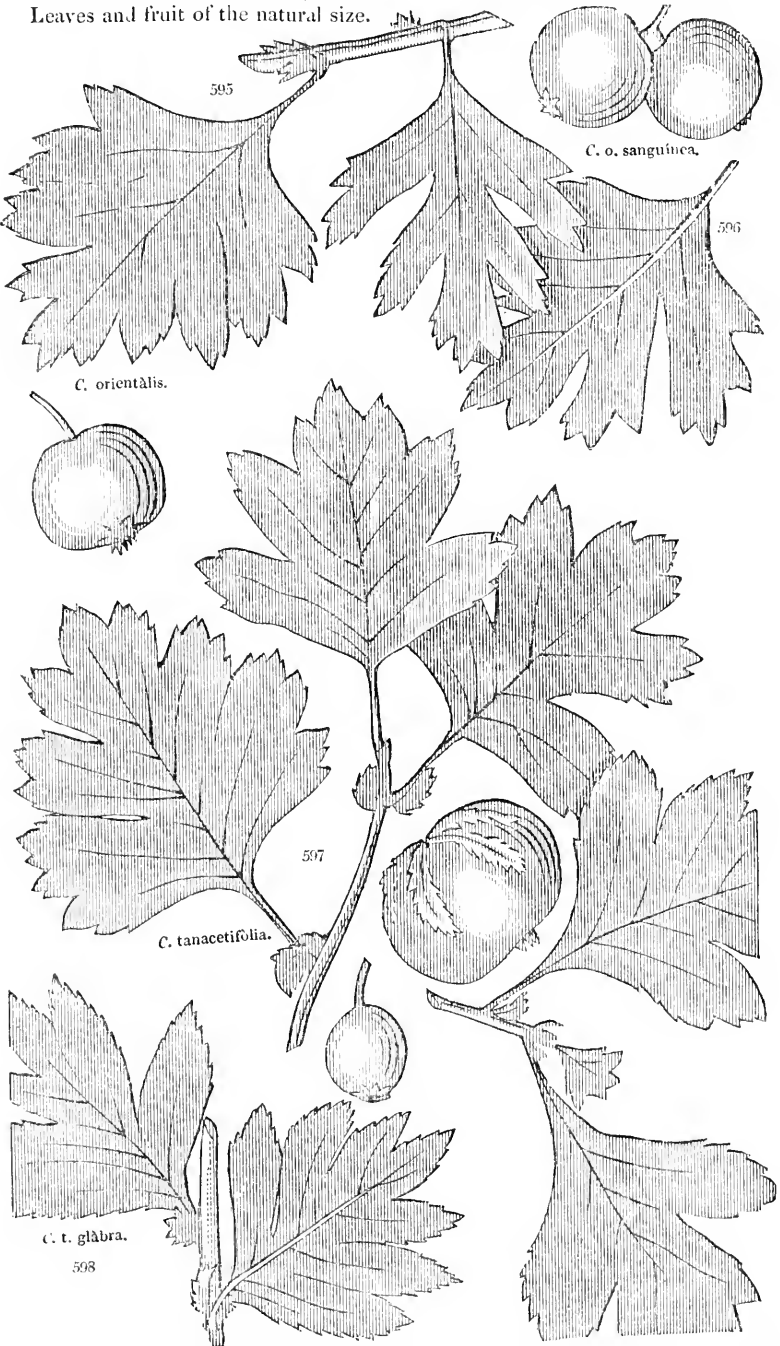

595

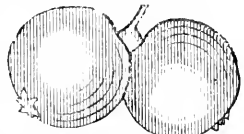

C. o. sanguinea.

596

C. orientális.

597

C. tanacetifolia.

C. t. glàbra.

598

Cratægus tanacetifolia Leeàna, *C. heterophýlla*, and *C. Oxyacántha obtusàta*. Lee's Tansy-leaved Thorn, the various-leaved Thorn, and the obtuse-leaved Hawthorn.
Leaves and fruit of the natural size.

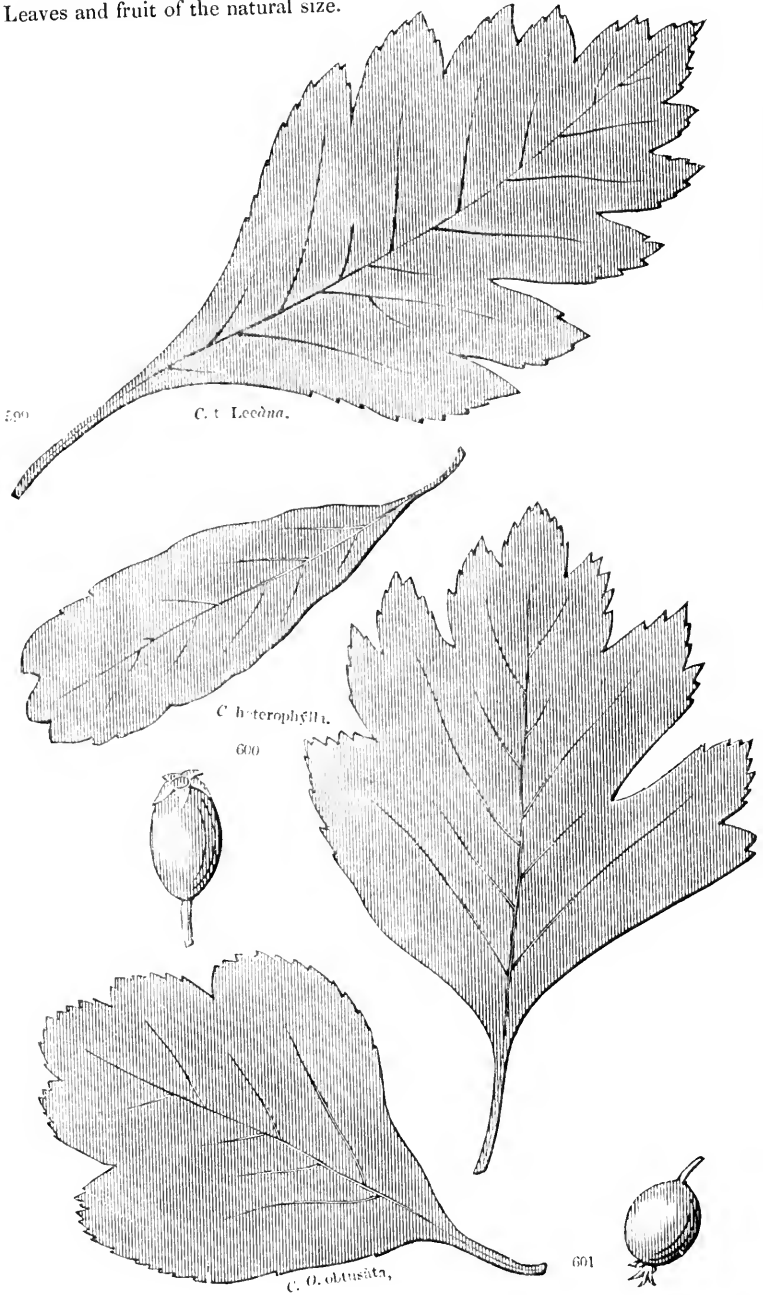

Cratægus Oxyacantha, et var. The common Hawthorn, and Five of its Varieties.

Leaves and fruit of the natural size.

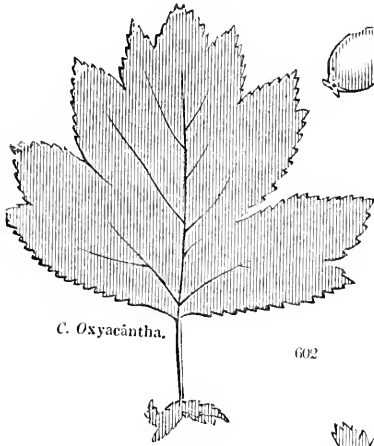

C. Oxyacantha.

602

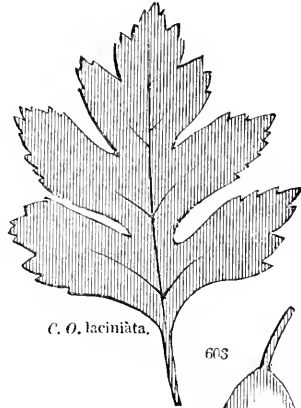

C. O. laciniata.

603

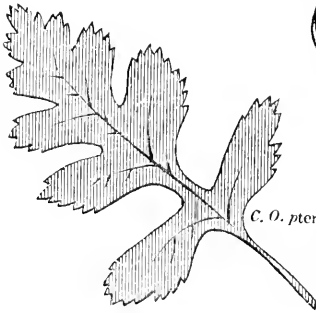

C. O. pteridifolia.

604

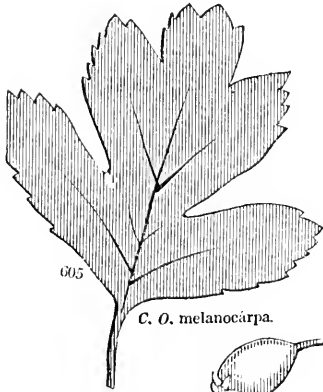

605

C. O. melanocarpa.

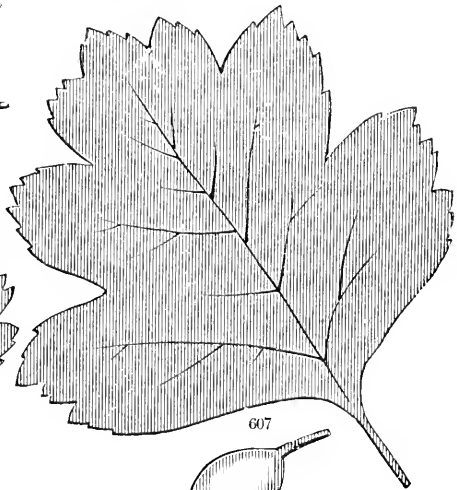

607

eriocarpa.

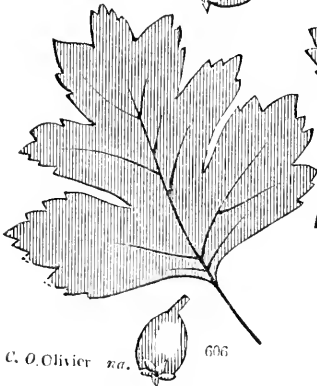

C. O. Olivier var.

606

Crataegus Oxyacantha var. Five Varieties of the Hawthorn.
Leaves and fruit of the natural size.

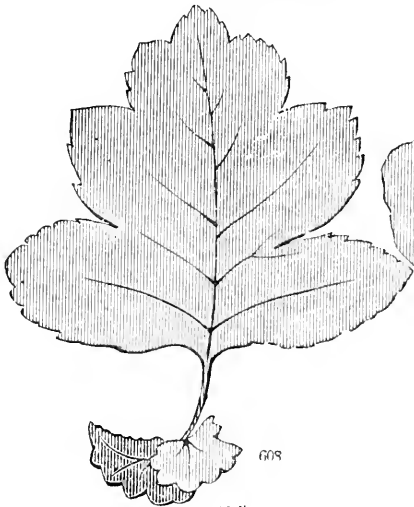

C. O. quercifolia.

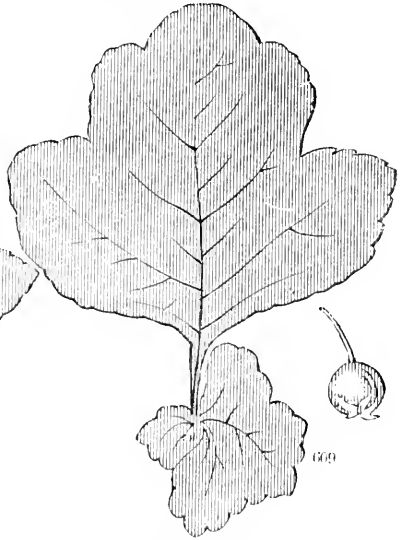

C. O. multiplex.

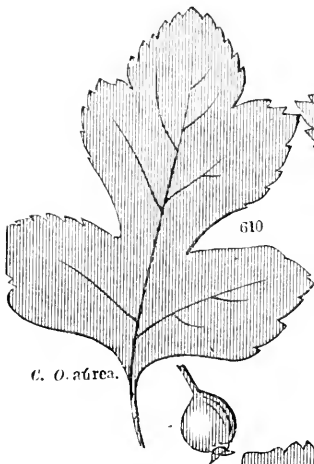

C. O. aurea.

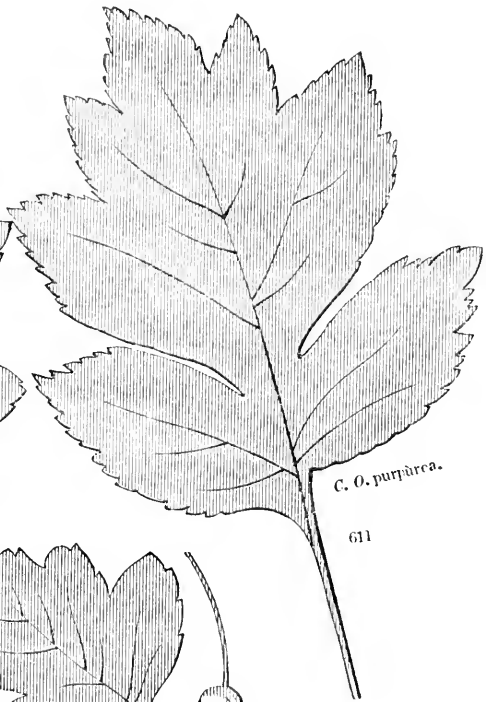

C. O. purpurea.

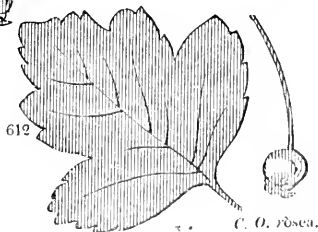

C. O. rubra.

Crataegus parvifolia, *C. p. florida*, *C. p. grossulariaefolia*, *C. virginica*, *C. mexicana*. The small-leaved Thorn, the Florida Thorn, the Gooseberry-leaved Thorn, the Virginian Thorn, and the Mexican Thorn.

Leaves and fruit of the natural size.

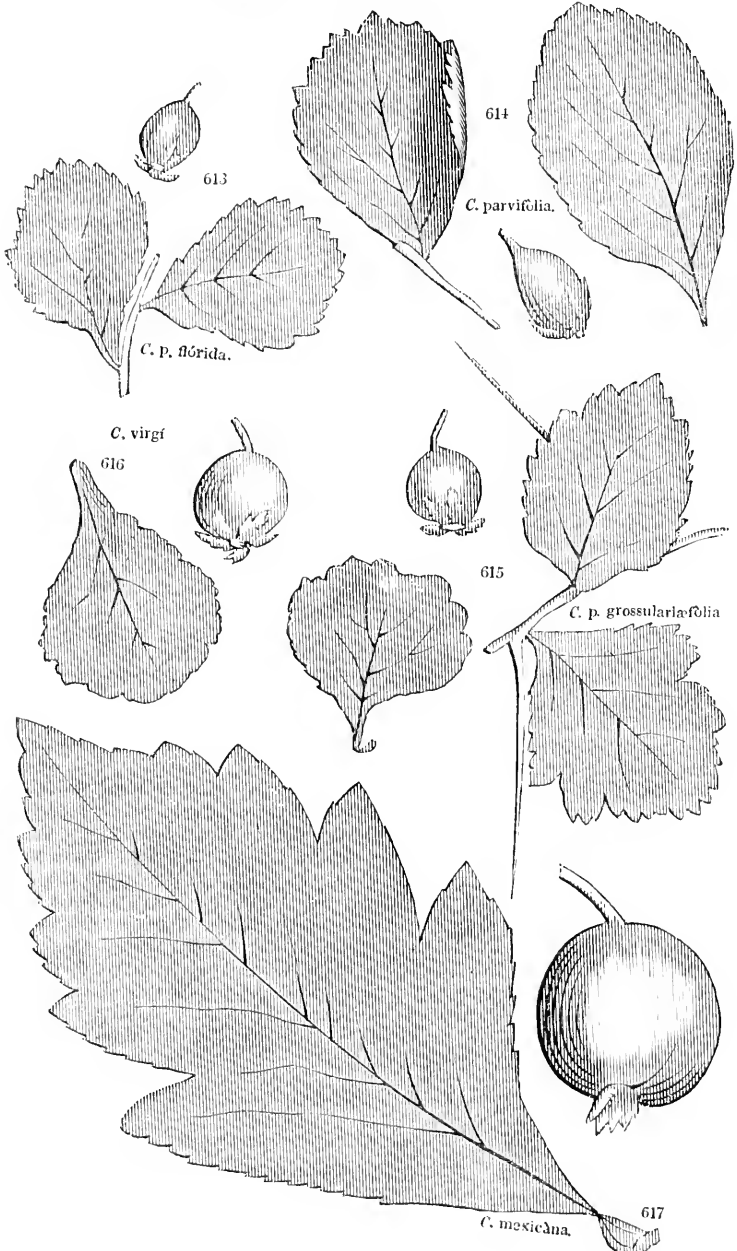

GENUS XIV.

**PHOTÍNIA** Lindl. THE PHOTINIA. *Lin. Syst.* Icosándria Di-Pentagýnia.

Identification. Lindl. in *Lin. Soc. Trans.*, 13. p. 103.; *Dec. Prod.*, 2. p. 631.; *Don's Mill.*, 2. p. 602.

Synonyme. *Cratægus* sp. *L.*

Derivation. From *phôteinos*, shining; in allusion to the lucid surface of the leaves.

Description, &c. Evergreen trees, with undivided, coriaceous, serrated, or entire, leaves. Flowers, in most, in terminal corymbose panicles; and small fruit, at least which has appeared small, as far as it has been seen in an unripe state. (*Dec. Prod.*, ii. p. 631.) The garden treatment of this genus is exactly the same as that of *Cratægus*, except that the species are somewhat more tender. They are eminently ornamental.

‡ 1. *P. SERRULATA* Lindl. The serrulated-leaved Photinia.

Identification. Lindl. in *Lin. Soc. Trans.*, 13. p. 103.; *Dec. Prod.*, 2. p. 631.; and *Don's Mill.*, 2. p. 602.

Synonyme. *Cratægus glabra* *Thunb. Fl. Jap.*, 205., *Bot. Mag.*, *Lodd. Bot. Cab.*, *Colla Hort. Ripul.*

Engravings. *Bot. Mag.*, t. 2105.; *Bot. Cab.*, t. 248.; *Colla Hort. Ripul.*, t. 56.; and the plate of the species in our Second Volume.

Spec. Char., &c. Leaves oblong, acute, serrulated. Pedicels longer than the calyx. Buds large, red. (*Dec. Prod.*, ii. p. 631.) A native of Japan and China; introduced in 1804, and forming a very handsome, evergreen, low tree. It is commonly grafted or budded on thorn stocks; and it also does well upon quince stocks. In the neighbourhood of London, it flowers between the middle of April and the middle of May; but it has not yet produced fruit in England. The largest and oldest plants are at White Knights, where it was planted in 1804; and, in 1835, formed a large bush, or tree, nearly 15 ft. high. In Essex, at Highlands, 8 years planted, it is 12 ft. high. In Hertfordshire, at Cheshunt, 6 years planted, it is 10 ft. high. In Pembrokeshire, at Golden Grove, 30 years planted, it is 12 ft. high. In Devonshire, at Killerton, 8 years planted, it is 10 ft. high; at Luscombe, 8 years planted, and 16 ft. high, with a head 14 ft. in diameter. In Hampshire, at Leigh Park, 7 years planted, it is 11 ft. high. In Scotland, in Argyllshire, at Toward Castle, 6 years planted, it is 7 ft. high. In Ireland, in Cork, at Castle Freke, it is 8 ft. high. The largest plants, as standards, in the neighbourhood of London, are at Syon, where, in 8 years, it has attained the height of from 12 ft. to 15 ft., flowering occasionally. In the Botanic Garden at Kew, and in the Horticultural Society's Garden, there are trees against walls which flower freely every year. In the neighbourhood of Paris, *Photinia serrulata* is found quite hardy, and it retains the greater part of its leaves during winter. In 1829, there were numerous trees of it at Coomb-la-Ville. In Britain, in situations too cold for planting this tree as a standard, it well deserves a place against a wall, for its large, deep green, shining leaves, which, when they appear in spring, are of a dark brownish red; while those of the preceding year, when they drop off, which is for the most part in May, are of an intensely deep red, or scarlet. Fit associates for it against a wall are, *P. arbutifolia*, *Cratægus glauca*, *C. mexicana*, *Raphiölepis indica*, and *Eriobötrya japonica*. Price of plants, in the London nurseries, 1s. 6d. each; at Paris, 1 franc; at Bollwyller, 2 francs; and at New York, ?.

‡ 2. *P. ARBUTIFÖLIA* Lindl. The Arbutus-leaved Photinia.

Identification. Lindl. in *Lin. Soc. Trans.*, 13. p. 103.; *Dec. Prod.*, 2. p. 631.; *Don's Mill.*, 2. p. 602.

Synonyme. *Cratægus arbutifolia* *Ait. Hort. Kew.*, ed. 2. vol. 3. p. 252.

Engravings. *Bot. Reg.* t. 491.; and our *fig.* 619.

Spec. Char., &c. Leaves with the disk oblong-lanceolate, acute, distantly serrated, six times longer than the petiole, which is red. The panicle, in this species, is not corymbose. (*Dec. Prod.*, ii. p. 631.) A native of Cali-

fornia; introduced in 1796, but hitherto little cultivated. In its native country, it forms a tree from 10 ft. to 20 ft. high; but in England it has scarcely been tried as a standard, though there can be no doubt that it is as hardy as, or harder than, *P. serrulata*. Against a wall, it has flowered in the Horticultural Society's Garden, in July and August. It may be propagated with the greatest facility by budding it on the common hawthorn; and, in the colder parts of England, would be valuable as an evergreen for a wall. Plants, in the London nurseries, are 2s. 6d. each. In the Fulham Nursery is a variety known there as *P. a. serotina*.



‡ 3. *P. INTEGRIFOLIA* Lindl. The entire-leaved Photinia.

Identification. Lindl. in Lin. Trans., 13. p. 103; Don's Mill., 2. p. 602.

Synonymes. *Pyrus integrifolia* Wall. ex D. Don Prod. Fl. Nep., p. 237.

Spec. Char., &c. Leaves elliptic, acuminate, quite entire. Panicle diffuse. Pedicels bractless. Ovary 3-celled; cells biovulate. (*Don's Mill.*, ii. p. 602.) A tree, growing to the height of 20 ft., a native of Nepal; introduced in 1820.

‡ 4. *P. DU'BIA* Lindl. The doubtful Photinia.

Identification. Lindl. in Lin. Trans., 13. p. 104; Don's Mill., 2. p. 602.

Synonymes. *Mespilus bengalensis* Roxb.; *M. tinctoria* D. Don. Prod. Fl. Nep., 238.; *Crataegus*

Shicola Ham. MSS.

Engraving. Lin. Trans. 13. t. 10.

Spec. Char., &c. Leaves lanceolate, distantly serrated. Panicle corymbose, pilose. Fruit 2-celled. Seed 1, large, and clothed with a loose testa. Fruit sometimes 1-celled from abortion, and 2-seeded. (*Don's Mill.*, ii. p. 602.) A tree, 20 ft. high, a native of Nepal; introduced in 1821. It appears nearly allied to *Raphiölepis*. Hamilton states that the bark is used, in Nepal, to dye cotton red.

App. i. *Species of Photinia not yet introduced.*

P. bengalensis Wall. is a native of Bengal; and is, doubtless, rather tender.

P. Sieboldii Don's Mill., 2. p. 602.; *Mespilus Sieboldii* Blum. Bidjr., 1102.; is a native of China.

P. laevis Dec. Prod., 2. p. 631.; *Crataegus laevis* Thunb. Fl. Jap., 204.; is a Japan tree, growing to the height of 20 ft.

P. villosa Dec. Prod., 2. p. 631.; *Crataegus villosa* Thunb. Jap., 204.; is a native of Japan, with compound umbels, and the fruit villous.

All these sorts appear to be well worth procuring, being apparently all evergreens, with fine large shining leaves.

GENUS XV.



COTONEA'STER *Med.* THE COTONEASTER. *Lin. Syst.* Icosándria Di-Pentagýnia.

Identification. *Med. Gesch. Bot.*, 1793.; Lindl. in Lin. Soc. Trans., 13. p. 101.; Dec. Prod., 2. p. 632.; Don's Mill., 2. p. 603.

Synonyme *Mespilus* sp. *Lin.*

Derivation. *Cotoneaster*, a sort of barbarous word, signifying quince-like. The quince was called *Cotonea* by Pliny; and *aster*, a corruption of *ad instar*, is used occasionally to express similitude. The genus, and *C. frigidia* in particular, is not unlike the quince in its leaves. (*Lindley in Bot. Reg.*, t. 1187. and 1229.)

Description. Small trees of Europe and India. Leaves simple, entire; the lower surface covered with hairs. Flowers in spreading lateral cymes. Petals small, continuing long upon the plant. Bractes awl-shaped, deciduous. (*Lindley in Bot. Reg.*, t. 1229.) The species are very desirable garden shrubs, or low trees, from the beauty of their foliage, their flowers, and their

fruit; the fruit of *C. frígida* and *C. affinis*, in particular, being produced in great abundance, and, being of an intense scarlet colour, have a very splendid appearance, and remain on the trees the greater part of the winter. The cotoneasters are all readily propagated by seeds, cuttings, layers, or grafting on *C. vulgàris*, on the common quince, or on the hawthorn. Though the greater part of the species are natives of Asia, yet in Britain they are found to be as hardy as if they were indigenous to the north of Europe, most especially those of them that are true evergreens. This is a fact well worthy of being noticed, as proving the positive advantages likely to accrue to any one country from introducing into it the productions of every other country, however different some of these countries may be in civil and geographical circumstances. It affords a fine illustration of that law of Providence, by which man is enabled, by labour, knowledge, and research, to add greatly to his stock of enjoyment and happiness.

§ i. *Leaves deciduous. Shrubs.*

❧ 1. *C. VULGARIS* Lindl. The common Cotoneaster.

Identification. Lindl. in Lin. Soc. Trans., 13, p. 101.; Dec. Prod., 2, p. 632.; Don's Mill., 2, p. 603.
Synonymes. *Méspilus* Cotonéaster Lin. Sp., 686., *Ed. Fl. Dan.*, t. 112.; *Néflier* cotoneux, Fr.; Quitten-Mispel, Ger.

Engravings. *Ed. Fl. Dan.*, t. 112.; *Eng. Bot. Suppl.*, t. 2713.; and our fig. 620.

Spec. Char., &c. Leaves ovate, rounded at the base. Peduncles and calyxes glabrous. (*Dec. Prod.*, ii. p. 632.)

A native of sunny parts of subalpine hills of Europe and of Siberia. It has been in cultivation in British gardens since 1656, and was always considered a foreign plant, till it was lately found, in a wild state, at Orme's Head, in Caernarvonshire. (See Smith's *Eng. Flora*, vol. iv. p. 268.; and *Mag. Nat. Hist.*, vol. vi. p. 55, 56.) In its wild state, this species forms a shrub from 2 ft. to 3 ft. high; but in cultivation it attains the height of 4 ft. or 5 ft.; and, grafted standard high on the hawthorn or the mountain ash, it forms a very curious, round-headed, pendent-branched tree, as may be seen in the Garden of the Horticultural Society, and in the Hammersmith Nursery. It flowers in April and May, and ripens its fruit in July and August.

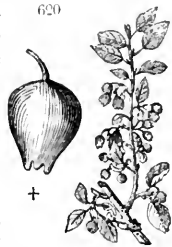

Varieties. The following three forms of this species are to be met with, both in a wild state, and in gardens:—

❧ *C. v. 1 erythrocarpa* Led. *Fl. Alt.*, ii. p. 219., has the fruit red when ripe.

❧ *C. v. 2 melanocarpa* Led.; *Méspilus* Cotonéaster *Pall. Fl. Ross.*, i. p. 30. t. 14.; *M. melanocarpa* *Fisch.*; *C. melanocarpa* *Lod. Cat.*; has the fruit black when ripe.

❧ *C. v. 3 depréssa* Fries *Nov. Succ.*, p. 9., *Dec. Prod.*, ii. p. 632., is rather spiny, with lanceolate acutish leaves, and fruit including 4 carpels. It is a native of the rocks of Sweden near Warberg.

❧ 2. *C. (v.) TOMENTOSA* Lindl. The tomentose, or woolly, Cotoneaster.

Identification. Lindl. in Lin. Soc. Trans., 13, p. 101.; *Dec. Prod.*, 2, p. 632.; Don's Mill., 2, p. 603.
Synonymes. *Méspilus* tomentosa *Willd. Sp.*, 2, p. 1012., not Lam.; *M. eriocarpa* *Dec. Fl. Fr. Synops.* and *Suppl.*, No. 5691.

Spec. Char., &c. Leaves elliptical, obtuse at both ends. Peduncles and calyxes woolly. (*Dec. Prod.*, ii. p. 632.) A shrub, like the preceding species, of which it appears to us to be only a variety, found wild on the rocks of Jura, and in other parts of the Alps of Switzerland; and in cultivation in British gardens since 1759.

❧ 3. *C. (v.) LAXIFLORA* Jacq. The loose-flowered Cotoneaster.

Identification. Jacq. ex Lindl. *Bot. Reg.*, t. 1305.; Don's Mill., 2, p. 604.
Engravings. *Bot. Reg.*, t. 1305.; and our figs. 621. and 622.



Spec. Char., &c. Leaves oblong, obtuse at both ends, smooth above, and woolly beneath. Cymes paniced, pilose. Calyxes quite smooth. Flowers pink. (*Don's Mill.*, ii. p. 604.) Branches brownish purple, with an ash-coloured cuticle, which peels off. A shrub, flowering in April, and having the same general appearance and habit as *C. vulgaris*, but differing from it in having large loose racemes, and in the colour of its flowers, and their greater number. It was raised in the Garden of the Horticultural Society, from seeds sent by Professor Jacquin of Vienna, in 1826. Its native country is unknown. Plants, in the London nurseries, are 2s. 6d. each.



§ ii. *Subevergreen or deciduous. Tall Shrubs, or low Trees.*

‡ 4. *C. FRIGIDA* Wall. The frigid Cotoneaster.

Identification. Wall. ex Lindl. Bot. Reg., t. 1229.; and Don's Mill., 2. p. 604.
Synonymy. *Pyrus Nissia* Ham. in Prod. Fl. Nep., p. 257., Dec. Prod., 2. p. 634.
Engravings. Bot. Reg., t. 1229.; and the plate of this species in our Second Volume.

Spec. Char., &c. Branchlets woolly. Leaves elliptical, mucronate, coriaceous, crenulated, glabrous, woolly beneath when young. Corymbs paniculate, terminal, white and woolly. Pomes spherical. (*Dec. Prod.*, ii. p. 634.) A native of the higher mountains of the northern region of Nepal, at Gossainthan; and introduced into England in 1824. It is a remarkably robust-growing, subevergreen, low tree, producing shoots 3 ft. or 4 ft. long every season, when young; and, in 3 or 4 years from the seed, becoming very prolific in flowers and fruit. "Snow white with blossoms," Dr. Lindley says, "during April and May, and crimsoned with bunches of bright red haws in September and October." (*Bot. Reg.*, t. 1229.) As the fruit, with the greater part of the leaves, remain on all the winter, the tree makes a splendid appearance at that season; and, in sheltered situations, in the neighbourhood of London, it may be considered as an evergreen. It is very hardy; the specific name of *frigida* being given to it on account of the coldness of the locality in which it was found. It is propagated by grafting on the common hawthorn. Plants, in the London nurseries, cost, at present, 2s. 6d. each; but, from the facility with which they may be raised from seeds, or by grafting, whenever there is a demand for them, they will, no doubt, fall to the usual price of grafted *Rosaeæ*, § *Pomeæ*.

‡ 5. *C. (F.) AFFINIS* Lindl. The related (to *C. frigida*) Cotoneaster.

Identification. Lindl. in Lin. Soc. Trans., 13. p. 101.; Dec. Prod., 2. p. 632.; and Don's Mill., 2. p. 603.
Synonymy. *Mespilus integerrima* Hamilt. MSS.; *M. affinis* D. Don Prod. Fl. Nep., 238.
Engraving. Our plate in Vol. 11.

Spec. Char., &c. Leaves ovate, with a small mucro at the tip, and tapered at the base. Peduncles and calyxes woolly. (*Dec. Prod.*, ii. p. 632.) A native of Chittong, a town of Lower Nepal; introduced in 1828, and forming a robust shrub, or low tree, in general habit and appearance so like the preceding sort, as to induce us to think that they are only different forms of the same species. They are, however, different in foliage, and on that account worth keeping distinct. In the arboretum of the Messrs. Loddiges there is a plant under the name of *C. kumana*, which, from the shape of the leaf, and general appearance of the plant, may possibly be a variety of this species. As, however, it has not yet flowered in this country, we are unable to state anything certain respecting it.

‡ 6. *C. ACUMINATA* Lindl. The acuminated-leaved Cotoneaster.

Identification. Lindl. in Lin. Soc. Trans., 13. p. 101.; Dec. Prod., 2. p. 632.; Don's Mill., 2. p. 603.

Synonymy. *Mespilus acuminata* Lodd. Bot. Cab., t. 919.

Engravings. Lodd. Bot. Cab., t. 919.; Lin. Soc. Trans., 13. t. 9.; and the plate of this species in Vol. 11.

Spec. Char., &c. Leaves ovate, acuminated, rather pilose on both surfaces.

Peduncles glabrous, 1—2, rather reflexed, shorter than those of *C. vulgaris*,

C. tomentosa, or of *C. affinis*. Calyxes glabrous. (*Dec. Prod.*, ii. p. 632.)

A native of Nepal; introduced in 1820, and forming a vigorous-growing,

fastigate, leathery-leaved shrub, or very handsome subevergreen low tree.

It flowers in April and May, and the flowers are succeeded by abundance

of scarlet fruit, which remain on all the winter. It is a very distinct, and

a most desirable, species. Plants, in the London nurseries, are 1s. 6d. each;

and at Bollwyller, 1 franc and 50 cents.

‡ 7. *C. NUMMULARIA* Lindl. The money-like-leaved Cotoneaster.

Identification. Lindl. in Hort. Trans., 6. p. 396.

Derivation. Probably from the roundness of the leaf, resembling the general form of coins.

Engraving. Our plate in Vol. 11.

Spec. Char., &c. Disk of leaf flat, orbicular, or elliptical, ending in a micro,

in some instances emarginate. Petiole of about the length of the stipules,

which are linear-lanceolate, membranous, and soon fall off. Bark, buds,

flower buds, stipules, petiole, the under surface of the disk of the leaf and

part of the upper surface of the midrib, tomentosely hairy, while in a

young state; the bark, petioles, midrib on its upper surface, and calyx,

become glabrous when old. Flowers in axillary cymes, few in a cyme. Style

and carpel, which has a bony shell, mostly solitary. Erect, branched in a

spreading manner; branchlets straight, slender. An elegant low tree, a

native of the mountain region of Nepal, introduced in 1824, growing about

15 ft. high, and producing its white flowers in April and May.

§ iii. *Leaves evergreen, leathery. Low Shrubs, with prostrate Branches; Trailers, but not properly Creepers.*

‡ 8. *C. ROTUNDIFOLIA* Wall. The round-leaved Cotoneaster.

Identification. Wall. Cat.; Lindl. Bot. Reg., 1229.

Synonymy. *C. microphylla* β *Uva-ursi* Lindl. Bot. Reg., t. 1187.; *C. Uva-ursi* Hort.; the Bear-berry-leaved Nepal Cotoneaster.

Engravings. Bot. Reg., t. 1187.; and our figs. 623. and 624.



623

Spec. Char., &c. Leaves roundish, pi-

lose beneath, evergreen. Peduncles

1-flowered. Producing its white flowers

in April and May. (*Don's Mill.*,

ii. p. 604.) A shrub, growing to the

height of 3 ft. or 4 ft.; a native

of Gossainthan; and introduced in

1825. Dr. Lindley says that "na-

tive specimens have convinced him

that this is a distinct species from

C. microphylla" (*Bot. Reg.*, t. 1229.);

from which it differs, he says, "in being a plant of more vigorous growth;

in having somewhat larger and flatter leaves; and in bearing flowers more

frequently in twos and threes than singly. (*Ibid.*, t. 1187.) The shoots are

rigid, and thickly clothed with leathery evergreen leaves; and the flowers,

which are numerous, are succeeded by bright scarlet fruit, which remain

on the plant all the year. It is a most desirable shrub for a small garden,

for clothing a naked wall, covering rockwork, or grafting standard high,

so as to form a pendent evergreen tree. Dwarf plants, in the London

nurseries, are 2s. 6d. each; standards, from 5s. to 7s. The specific name

of *rotundifolia* is rather unfortunate for this species, *C. nummularia* hav-

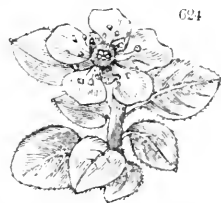

624

ing leaves more decidedly round: *microphýlla* is better; but *U'va-úrssi*, we think, would be best, both because it resembles *Arctostáphylos U'va-úrssi* in appearance and habit, and because, though a native of Asia, it is equally hardy with that plant. It might be grafted standard high in every hawthorn hedge in the north of Scotland.

■ 9. *C. (R.) MICROPHY'LLA* Wall. The small-leaved Cotoneaster.

Identification. Wall. ex Lindl. Bot. Reg., t. 1114.; Don's Mill., 2. p. 604.

Engravings. Bot. Reg., t. 1114.; and our fig. 625.

Spec. Char., &c. Leaves oblong, obtuse, pubescent beneath, evergreen. Peduncles usually 1-flowered. (*Don's Mill.*, ii. p. 604.) Flowers white, and produced in May and June. Introduced in 1824. Notwithstanding the high authority of Dr. Lindley, we cannot help considering this only a variety of the preceding species. It is exceedingly hardy, and forms a fine plant on rockwork, or on a lawn, where it has room to extend itself. "Its deep glossy foliage, which no cold will impair, is, when the plant



625

is in blossom, strewed with snow-white flowers, which, reposing on a rich couch of green, have so brilliant an appearance, that a poet would compare them to diamonds lying on a bed of emeralds." (*Lindl.*) "It is deserving of notice, that the peculiar flavour, which, in *Rosæcæ*, is attributed to the presence of prussic acid, is so strong in this plant, that, before flowering, it would be taken for a *Prúnus*; a remarkable fact in a tribe of plants which are reputed to possess, exclusively, malic instead of prussic acid." (*Idem.*) A plant of *C. microphýlla*, at High Clere, of about 10 years growth, was, in 1835, 6 ft. high, and formed a dense bush, covering a space 21 ft. in diameter. Its branches are strong and rigid; its foliage of an intense green, lucid, with scarcely any veins, and of leathery texture; and it is never without a profusion of scarlet berries. Grafted standard high on the thorn, or any of its congeners, this shrub forms a singular and beautiful evergreen drooping tree: or it will cover a naked wall nearly as rapidly as ivy; and it possesses a decided advantage over that plant, and particularly over the variety called the giant ivy, in its shoots, which may be prevented from extending many inches from the face of the wall, and, consequently, being not likely to injure the plants growing near it. Were the practice of training trees and shrubs in architectural or sculptural shapes again to come into fashion, there are few plants better adapted for the purpose than this and the preceding sort of *Cotoneáster*. To some, it may appear in bad taste to revive the idea of verdant sculptures; but such is the ardent desire of the human mind for novelty, that we have no doubt clipped trees and shrubs will, at no distant period, be occasionally reintroduced in gardens. The contrast produced by beauties of this kind, in the midst of a profusion of natural and natural-like scenery, is delightful.

■ 10. *C. (R.) BUXIFO'LIA* Wall. The Box-leaved Cotoneaster.

Identification. Wall. ex Lindl. Bot. Reg., t. 1229.; Don's Mill., 2. p. 604.

Spec. Char., &c. Leaves ovate, woolly beneath, evergreen. Peduncles 3-flowered, woolly. Flowers white. (*Don's Mill.*, ii. p. 604.) A native of Neelgherry; introduced in 1824; and apparently a variety of *C. rotundifolia*, from which it differs in having the peduncles 2 and 3-flowered, but scarcely in any thing else.

App. i. *Species of Cotoneáster not yet introduced.*

C. bacilláris Wall. *ined.* Lindl. in Bot. Reg., t. 1229., has obovate leaves and many-flowered cymes. It is a native of Kamaon.

C. obtusa Wall. *ined.* Lindl. in Bot. Reg., t. 1229., is a native of the mountains of Nejal and Kamaon, with many-flowered, crowded, glabrous cymes.

As there is every probability that all the cotoneasters, even though natives of Asia, are quite hardy, the introduction of new species or varieties is ardently to be desired by every lover of ligneous plants.

GENUS XVI.



AMELANCHIER Med. THE AMELANCHIER. *Lin. Syst.* Icosándria Di-Pentagýnia.

Identification. Med. Gesch., 1793; Lindl. in *Lin. Soc. Trans.*, 13. p. 100; Dec. Prod., 2. p. 632; Don's Mill., 2. p. 604.

Synonymes. *Mespilus L.*; *Pýrus W.*; *Arónia Pers.*

Derivation. According to Clusius, *Amelancier* is the old Savoy name for *A. vulgaris*. (*E. of Pl.*) *Amelanchier* is the Savoy name for the medlar.

Description, &c. Small trees, natives of Europe and North America, with simple, serrated, deciduous leaves, white flowers in racemes, and linear-lanceolate deciduous bracteas. (*Dec. Prod.*, ii. p. 632.) In British gardens, they are cultivated for their flowers, which are white, abundant, showy, and produced early in the season; for their fruit, which ripens in June; and for the deep red, or rich yellow hue, which their foliage assumes in autumn. They are propagated by grafting on the hawthorn or the quince; or the weaker on the stronger-growing species of the genus.

‡ 1. *A. VULGARIS* Munch. The common Amelanchier.

Identification. Munch Meth., 682; Dec. Prod., 2. p. 632; Don's Mill., 2. p. 604.

Synonymes. *Mespilus Amelanchier* Lin. Sp., 685; *Jacq. Fl. Austr.*, t. 300; *Pýrus Amelanchier* Willd. Sp., 2. p. 1015; *Arónia rotundifolia Pers. Syn.*, 2. p. 39; *Crataegus rotundifolia Lam.*; *Sorbus Amelanchier* Crantz; *Alisier Amelanchier*, *Amelanchier des Bois*, *Néflier à Feuilles rondes*, *Fr.*; *Felsenbirne*, *Ger.*

Engravings. *Jacq. Fl. Austr.*, t. 300; *Bot. Mag.*, t. 2430; our fig. 626; and the plate in Vol. II.

Spec. Char., &c. Leaves roundish-oval, bluntish, downy beneath, afterwards glabrous. Fruit dark blue. (*Dec. Prod.*, ii. p. 632.) A native of mountainous woods, among rocks, in different parts of the Continent of Europe; the Alps, the Pyrenees, and at Fontainebleau; and in cultivation in England since 1596. It forms a most desirable low tree, on account of its early and numerous flowers, which cover the tree like a white sheet, about the middle of April, and, in very mild seasons, even in March. The fruit is round, soft, and eatable: it ripens in July, and soon drops off, or is eaten by the birds. There are trees of this species at Syon, from 15 ft. to 20 ft. in height.

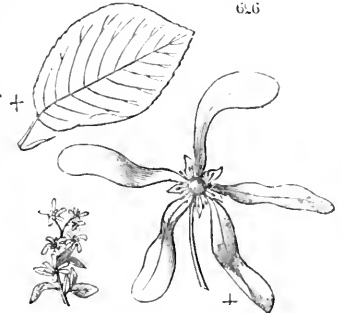

‡ 2. *A. (V.) BOTRYA'PIUM* Dec. The Grape-Pear, or Snowy-blossomed Amelanchier.

Identification. Dec. Prod., 2. p. 632; Hook. Fl. Bor. Amer., 1. p. 202; Don's Mill., 2. p. 604.

Synonymes. *Mespilus canadensis* Lin. Sp., 185; *M. arborea Michx. Arb.*, 2. t. 66; *Crataegus* race *mösa Lam. Dict.*, 1. p. 84; *Pýrus Botryapium* Lin. *fl. Suppl.*, p. 255; *Arónia Botryapium Pers. Syn.*, 2. p. 39; the Canadian Medlar, Snowy Mespilus, June Berry, wild Pear Tree; *Alisier de Choisy*, *Amelanchier de Choisy*, *Alisier à Grappes*, *Fr.*; *Traubenbirne*, *Ger.*

Engravings. Schm. Arb., t. 84; Wild. Abbild., t. 79; Krause, t. 56; the plates of this species, in a young and an old state, in Vol. II.; our fig. 629, from a specimen taken from the tree in the Horticultural Society's Garden, with the leaves and flowers fully expanded; and



figs. 627. and 628., copied from Michaux's *North American Sylva*; fig. 627. showing the plant in spring before the flowers are fully opened; and fig. 628. showing the plant in fruit. Both differ in some respects from fig. 629. See Sir W. J. Hooker's remarks under *A. ovalis*, No. 4.

Spec. Char., &c. Leaves oblong-elliptical, cuspidate, somewhat villous when young, afterwards glabrous. Native of Virginia and Canada. (*Dec. Prod.*,

ii. p. 632.) A shrub, or low tree, closely resembling the preceding species ; and by some botanists considered as only a variety of it. In America, it grows to the height of 30 ft. or 40 ft., with a trunk 10 in. or 12 in. in diameter. The flowers expand in the beginning of April ; and they are succeeded by small fruit of a purplish colour, and of an agreeable sweet taste, which ripens in the beginning of June, before that of any other tree or shrub. Of this fruit the largest tree rarely yields more than half a pound. The wood of the tree is white, and it exhibits no difference between the heart and the sap : it is longitudinally traversed by small bright red vessels, which intersect each other, and run together ; a physiological peculiarity which, Michaux observes, occurs also in the red birch. In British gardens, it may be found from 12 ft. to 20 ft. high, covered with its white flowers in early spring, and very ornamental in autumn, from the fine dark red which its leaves assume before dying off.

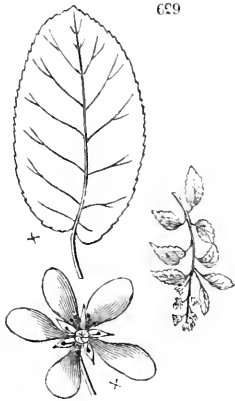

§ 3. *A. (v.) SANGUINEA* Dec. The blood-coloured Amelanchier.

Identification. Dec. Prod., 2. p. 633 ; Lindl. in Bot. Reg., t. 1171 ; Hook. Fl. Bor. Amer., 1. p. 203 ; Don's Mill., 2. p. 604.
Synonyms. *Pyrus sanguinea* Pursh Fl. Amer. Sept., 1 p. 340 ; *Arđonia sanguinea* Nutt. ; *Mespilus canadensis* γ *rotundifolia* Michaux Fl. Bor. Amer., 1. p. 391.
Engravings. Bot. Reg., t. 1171. ; and our figs. 630, 631.

Spec. Char., &c. Leaves oval, obtuse at both ends, mucronate, finely serrated, somewhat heart-shaped at the base. Flowers few in a raceme. Calyx glabrous. Petals linear, obtuse. Fruit eatable. (*Dec. Prod.*, ii. p. 633.)

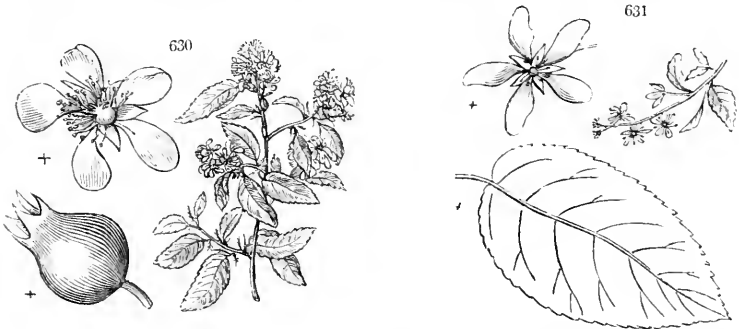

This plant differs principally from *A. (v.) Botryapium* in the fewer flowers, much shorter raceme, and shorter, broader, and more ovate petals ; and in the young leaves being perfectly destitute of pubescence. According to Pursh, it is a small tree with blood-red branches ; whence, probably, the specific name ; though in *Don's Miller* it is called the bloody-fruited Amelanchier. It is a native of Hudson's Bay, and was introduced into Britain in 1824. Judging from the plant in the Horticultural Society's Garden, we are strongly inclined to think it only a variety of *A. (v.) Botryapium* ; but, though we are of this opinion, and, in fact, consider all the amelanchiers known as only different forms of one species, in the same manner as *Pyrus nivālis*, *P. sināica*, *P. salicifolia*, *P. clæagnifolia*, and others, are only different states of the wild pear (*P. communis*), yet, as in the case of that species, we think they are as well worth keeping distinct, and of being cultivated, as if they were species. What advantage, then, it may be asked, is gained by calling them varieties, instead of species ; or even by proving them to be only varieties, if that could be done ? To this we answer, first,

that truth and facts ought to be pursued for their own sake; secondly, that if what are now considered species can be proved to be varieties, it will save botanists and gardeners much trouble in seeking for permanent or specific distinctions where none really exist; thirdly, it will greatly assist the memory, by grouping related kinds together; and it will be a guide to collectors in their choice of sorts. See what we have advanced on this subject in p. 216.

‡ 4. *A. (v.) OVALIS* Dec. The oval-leaved Amelanchier.

Identification. Dec. Prod., 2. p. 632.; Don's Mill., 2. p. 604.

Synonyms. *Crataegus spicata* Lam. Dict., 1. p. 84. ?; *Mespilus Amelanchier* Walt. Car., p. 184.; *A. parviflora* Dougl. MS.; *M. canadensis* var. *α ovalis* Michx. Am., 1. p. 291.; *Pyrus ovalis* Willd. Sp., 2. p. 1014.; *Aronia ovalis* Pers. Syn., 2. p. 240.; *Amelanchier du Canada*, *Alisier à Épi*, Fr.; *rundblättrige Birne*, Ger.

Engraving. Fig. 632.

Spec. Char., &c. Leaves roundish-elliptical, acute; when young, rather velvety beneath; when adult, glabrous. Raceme coarctate. Petals obovate. Calyx pubescent. (*Dec. Prod.*, ii. p. 632.) A native of North America, throughout Canada, from Lake Huron to the Rocky Mountains. It was introduced in 1800, grows to the height of a low tree, and produces its flowers and fruits at the same time as *A. Botryopium*. Of this species Sir Wm. Jackson Hooker observes, "I am sometimes disposed to agree with Dr. Torrey, who suspects this to be only a variety of *A. Botryopium*;" and he adds that Michaux seems to have included *A. Botryopium* and *A. vulgaris* under his *A. canadensis*.

A. ovalis, according to Dr. Richardson, abounds in the sandy plains of the Saskatchewan, where its wood is prized by the Cree Indians for making arrows and pipe stems; and it is thence termed by the Canadian voyagers bois de flèche. Its berries, which are about the size of a pea, are the finest fruit in the country; and are used by the Cree Indians both in a fresh and in a dried state. They "make excellent puddings, very little inferior to plum-pudding." (*Hook. Fl. Bor. Amer.*, i. p. 203.) As far as we are able to judge, this, and the two preceding forms, belong to one species. There are trees of both species in the Horticultural Society's Garden, within a very few yards of each other; and it is from examining these at different seasons that we have arrived at the above conclusion.



Variety.

‡ *A. (v.) o. 2 subcordata* Dec. *Aronia subcordata* Raf.; *Mâlus microcarpa* Raf.—A native of mountains near New York. (*Dec. Prod.*, ii. p. 632.)

‡ *A. (v.) o. 3 semi-integrifolia* Hook. *Fl. Bor. Amer.*, p. 201.—Leaves for the most part separated at the apex. A native about the Grand Rapids, and at Fort Vancouver, on the Columbia.

‡ 5. *A. (v.) FLORIDA* Lindl. The flowery Amelanchier.

Identification. Lindl. Bot. Reg., t. 1589.; Gard. Mag., vol. ix. p. 484.

Engravings. Bot. Reg., t. 1589.; and our fig. 634. to a scale of 2 in. to 1 ft., and fig. 633. of the natural size.

Spec. Char., &c. Leaves oblong, obtuse at both ends, coarsely serrate in the terminal portion, glabrous in every state. Bracteas and stipules feathery at the tip, soon falling off. Flowers in upright racemes, many in a raceme. Calyx glabrous externally; its segments longer than, or at least as long as, the stamens. (*Lindley in Bot. Reg.*, t. 1589.) A handsome hardy shrub, or low tree,



in habit and general appearance like *A. (v.) Botryàpium*; but at once recognised as distinct by the shortness of its stamens. The leaves of this plant somewhat resemble those of the hornbeam; the flowers are white, with petals varying in length, some having measured more than $\frac{3}{4}$ of an inch. It flowers later, and the fruit ripens later, than in any of the other sorts. It was discovered by Mr. Douglas, on the north-west coast of North America, and sent to England by him in 1826. There is now a good specimen of the tree in the Horticultural Society's Garden, upwards of 10 ft. high. In general habit, it is somewhat more fastigiata than the other sorts, unless we except *A. sanguinea*, to which, Dr. Lindley observes, it is very near akin. Possibly a distinct species, but we doubt it.

Variety.

- ‡ *A. (v.) f. 2 parvifolia*, the *A. parvifolia* of the Horticultural Society's Garden, is of a dwarf habit, not growing above 3 ft. or 4 ft. high, and smaller leaves. It appears to us only a variety of *A. (v.) florida*; which, like all the species of the genus, varies exceedingly, according to soil, situation, age of the plant, stock on which it is grafted, &c. It is from having observed the extraordinary difference in the appearances which the same plant assumes in the different London nurseries, that we have been tempted to hazard the conjecture that they have all probably originated in the same species. We have now before us specimens of *A. (v.) florida*, from the Fulham Nursery, with leaves $1\frac{1}{2}$ in. broad, and $2\frac{1}{2}$ in. long, with their margins deeply notched; while those from the Horticultural Society's Garden are about two thirds of the size, and quite entire. We have also leaves of *A. Botryàpium* from the Fulham Nursery, 4 in. long including the footstalk, and $3\frac{1}{4}$ in. without it; and 2 in. broad; while those from the Horticultural Society's Garden are only $1\frac{3}{4}$ in. long, and 1 in. broad; and those from Messrs. Loddiges are still smaller.

GENUS XVII.



ME'SPILUS *Lindl.* THE MEDLAR. *Lin. Syst.* Icosándria Di-Pentagýnia.

Identification. Lindl. in *Lin. Trans.*, 13. p. 99; Dec. Prod., 2. p. 633; Don's Mill., 2. p. 6.

Synonymes. *Mespilus* sp. of Lin. and others; *Mespilophora* sp. of Neck.

Derivation. From *mesos*, a half, and *pilos*, a bullet; fruit resembling half a bullet.

Description, &c. Deciduous trees of the middle size, natives of Europe; the first species is cultivated for its fruit, which is eatable, and the seeds of which are accounted anti-lithic; and the other as an ornamental shrub, or low tree, of the general character of a *Cratægus*, to which genus it may indeed be considered as properly belonging. They are propagated by grafting on the quince, the wild pear, or the common hawthorn. The price, in the nurseries, is the same as for *Cratægus*.

‡ 1. *M. GERMA'NICA L.* The German, or common, Medlar.

Identification. *Lin. Sp.*, 684; *Pall. Fl. Ross.*, t. 13. f. 1.; *Dec. Prod.*, 2. p. 633; *Don's Mill.*, 2. p. 605.

Engravings. *Pall. Fl. Ross.*, t. 13. f. 1.; and the plate of this species in our Second Volume.

Spec. Char., &c. Leaves lanceolate, tomentose beneath, undivided. Flowers solitary. (*Dec. Prod.*, ii. p. 633.) A deciduous tree of the second rank; a native of Europe and the west of Asia, in bushy places and woods; and said to be found, also, in Kent, Sussex, Surrey, and about Chester, in England; apparently in a truly wild state in Sussex. (See *Mag. Nat. Hist.*, vol. ix. p. 86.) It flowers in May and June, and the fruit ripens in October and November. This tree was known to the Greeks, and has been in cultivation in British gardens for an indefinite period; not only the species, but several varieties,

being mentioned by Turner, Gerard, Parkinson, and other early British writers on botany and gardening. For its culture as a fruit tree, we refer to the *Encyclopædia of Gardening*, edit. 1835. As an ornamental tree, it well deserves a place in every collection, from the tortuous fantastic appearance of its branches, its large white flowers, its large leaves, and the rich-looking persistent calyxes which accompany its fruit.

Varieties. De Candolle gives the following forms of this species, which may be considered as natural varieties:—

- ‡ *M. g.* 1 *sylvêstris* Mill. Dict., No. 1. — Spiny. Fruit small. It loses its spines in a state of cultivation.
- ‡ *M. g.* 2 *stricta* Dec., Ait. Hort. Kew., ii. p. 172., Dod. Pempt., 801. — Spinless. Leaves doubly serrated.
- ‡ *M. g.* 3 *diffusa* Dec., Ait. Hort. Kew., ii. p. 172., Du Ham. Arb. Fr., i. t. 3. — Thornless. Leaves nearly entire. Fruit, in many instances, abortive of seeds.

In the *Horticultural Society's Fruit Catalogue*, the following four cultivated sorts are given, which may be considered as artificial varieties:—

1. *Blake's large-fruited Medlar.*
2. *Dutch Medlar.* — Fruit the largest of any.
3. *Nottingham, or common, Medlar.* — Fruit obovate, middle size, and of the best quality: the only sort worth cultivating for its fruit in England.
4. *The stoneless Medlar.* — Fruit small, and of little merit.

The fruit of the medlar is not eaten till in a state of incipient decay, when it is very agreeable to some palates; though it is, as Du Hamel observes, more *un fruit de fantaisie*, than one of utility. A number of trees of the different varieties may be seen in the orchard of the Horticultural Society's Garden, where they have taken very picturesque shapes.

Statistics. In some of the old gardens about Twickenham, the traveller may see from the road medlar trees from 25 ft. to 30 ft. high, with heads from 30 ft. to 40 ft. in diameter. At Syon, and at Ham House, there are medlars 35 ft. high. In Devonshire, at Bystock Park, a tree, 12 years planted, is 14 ft. high. In Surrey, at Bagshot Park, one, 20 years planted, is 18 ft. high; at Claremont, an old tree is 20 ft. high. In Wiltshire, at Longford Castle, there is a tree 15 ft. high, with a trunk 1 ft. in diameter, and the diameter of the head 25 ft. In Radnorshire, at Maeslough Castle, there is one 24 ft. high. In Scotland, in the Glasgow Botanic Garden, 16 years planted, it is 15½ ft. high; in Banilshire, at Gordon Castle, 24 ft. high; in Stirlingshire, at Callander Park, 40 years planted, it is 12 ft. high. In Ireland, in the Glasnevin Botanic Garden, 35 years planted, and 16 ft. high; in Galway, at Castle Coole, 16 ft. high.

‡ 2. *M. SMITHII* Dec. Smith's Medlar.

Identification. Dec. Prod., 2. p. 633; Don's Mill., 2. p. 605.

Synonymes. *M. grandiflora* Smith Exot. Bot., 1. p. 33; *M. lobata* Poir, Hook. in Bot. Mag. t. 3342.

Engravings. Smith Exot. Bot., 1. t. 18.; Bot. Mag., t. 3442; and the plate of this species in our Second Volume.

Spec. Char., &c. Leaves oblong, elliptic, serrated, pubescent on the nerves beneath. Flowers usually solitary. (*Don's Mill.*, ii. p. 605.) The native country of this tree has not been ascertained. The flowers are white, and are one half smaller than those of the common medlar. The stipules of the sterile branches are large and foliaceous. A tree, growing to the height of 20 ft., and flowering in May and June; readily propagated by grafting on the common thorn. It is as hardy as the common medlar, and well deserves a place in ornamental plantations for the beauty of its flowers, which are produced in great profusion. The general aspect and habit of the tree are those of a *Cratægus*; and, indeed, it is by many persons considered as more properly belonging to that genus than to *Mespilus*. A scarlet-flowered variety of this species would be a most charming garden plant.

Statistics. There are fine old specimens of *M. Smithii* at Syon, Purser's Cross, Ham House, and Fulham Palace, from 20 ft. to 25 ft. high. In Sussex, at West Dean, 15 years planted, it is 19 ft. high, the diameter of the trunk 9 in., and of the head 24 ft. In Wiltshire, at Wardour Castle, 30 years planted, it is 40 ft. high, the diameter of the trunk 1 ft. 2 in., and of the head 21 ft., in loamy soil, on retentive clay. In Oxfordshire, in the Oxford Botanic Garden, 18 years planted, it is 24 ft. high. In Scotland, in Forfarshire, at Airlie Castle, 8 years planted, it is 9 ft. high. In Ireland, in the Glasnevin Botanic Garden, 20 years planted, it is 10 ft. high. Price, in the nurseries, the same as for *Cratægus*.

GENUS XVIII.



PY`RUS *Lindl.* THE PEAR TREE. *Lin. Syst.* Icosándria Di-Pentagýnia.

Identification. *Lindl. Lin. Soc. Tr.*, 13. p. 97.; *Dec. Prod.*, 2. p. 633.; *Don's Mill.*, 2. p. 605.

Synonymes. Pýrus, Málus, and Sórbus, *Tourn.*; Pýrus and Sórbus, *Lin.*; Pýróphorum and Apyróphorum, *Neck.*

Description. Low trees, and some shrubs; almost all deciduous; natives of Europe, Asia, and North America. Some of them in great estimation throughout the world for their fruit; and others cultivated chiefly for their flowers. Under the genus Pýrus, botanists have lately united the Linnæan genera Pýrus and Sórbus, together with several species formerly included under Méspilus, Cratæ`gus, and other genera. Taking the generic character from the fruit, this union appears strictly in accordance with the canons laid down by botanists: but we cannot help stating our opinion, that it would be much more convenient, in a practical point of view, in establishing genera, to take into consideration the leaves, the character of the vegetation, the physiology, and even the habit, of the plant, than merely to draw the distinctive characteristics from the parts of fructification. In consequence of attending only to these parts of plants, the genus Pýrus, as at present constituted, contains species, such as the apple and pear, which will not graft on each other; a circumstance which clearly shows that the union of these two kinds of plants in one genus is not a natural one. We not only think that no plants should be comprehended in the same genus which will not graft reciprocally on each other, but that plants of different habits or constitutions should not be united; and, consequently, that twining plants should not be united with trees and upright shrubs; nor deciduous trees and shrubs with evergreens. In short, as we have stated in p. 812., we would form genera on a kind of natural system, from all the circumstances of the plant taken together, and not from any particular part, or circumstance, or class of circumstances, belonging to it. We think we may refer, in confirmation of the propriety of this doctrine, to the excellent observations that have been quoted from Dr. Lindley, under the head of Lówea; not without a hope, as it was in the commencement of Dr. Lindley's botanical career that he brought so many species, dissimilar in habits, together into the genus Pýrus, that he will, in accordance with what he has stated in the passage referred to, be at some future time induced to separate them, and to restore the genera Málus, Sórbus, Aria, and Arónia. We request our readers to observe that here, as in other similar cases, we merely state our opinion; and that we by no means consider ourselves entitled to separate assemblages of species, or to alter established names, in any manner whatever. No one ought to do this who has not attained a degree of rank in the botanical world to which we have no pretension: and hence, in all those cases in which we have assumed a species to be a variety, we have only indicated our opinion in parentheses, leaving the reader to adopt it, or not, as he chooses. We may be allowed, however, to throw out suggestions for the consideration of botanists; and, as these are always made with the most perfect good feeling, and are merely submitted as speculative, with a view to do good, we hope our readers will receive them in the same spirit as that in which they are made. When a more perfect knowledge is obtained of all the vegetable productions of the earth, we have no doubt that it will be found necessary to remodel the whole of the genera, as well as to give new and characteristically composed names to all the species; a labour which, great as it may appear at present, will be diminished to a degree scarcely credible, when the present chaos of names, and, apparently, of species, is reduced by simplification.

To return to the genera Pýrus, we believe we may assert that some of the species it contains are, and have been for ages, the most universally

cultivated of all ligneous plants; the apple and the pear being highly esteemed fruits, both in the temperate and transition zones of both hemispheres. These, and all the species of the genus, are propagated by grafting on the wild varieties of each division. We have before stated the price of the grafted fruit trees which belong to *Rosaceæ* to be, about London, from 1s. to 1s. 6d. each for dwarfs, and from 2s. 6d. to 5s. each for standards; at Bollwyller, francs may be substituted for shillings; and at New York, cents for halfpence; the American cent being about equal to the English halfpenny, or the French sous, and, of course, worth 5 French centimes.

§ i. *Pyróphorum* Dec.

Sect. Char. Petals spreading, flat. Styles 5, distinct. Pome more or less top-shaped, or subglobose, without a concavity at the base. Pedicels simple, umbeled. Leaves simple, not gianded. (*Dec. Prod.*, ii. p. 633.) This section comprehends all the pears, properly so called.

‡ 1. *P. COMMUNIS* L. The common Pear Tree.

Identification. Lin. Sp., 686; Dec. Prod., 2. p. 633; Don's Mill., 2. p. 605.

Synonyms. *P. A'chras* Gærtn. *Fruct.*, 2. p. 44. t. 87.; *P. sylvêstris* Dod. *Pempt.*, 800.; *Pyrâster Ray Syn.*, 452.; *Poirier*, *Fr.*; gemeine Birne, or Birnebaum, *Ger.*; Pero, *Ital.*; Pera, *Span.*; and Gruschka, *Russian*.

Engravings. Blackw. *Herb.*, t. 453.; *Eng. Bot.*, t. 1784.; and the plate of this species in our Second Volume.

Spec. Char., &c. Branches and buds glabrous. Leaves ovate, serrated, glabrous upon both surfaces. Flowers corymbose. Wild in the woods of Europe, or cultivated in gardens. (*Dec. Prod.*, ii. p. 634.)

Varieties. De Candolle mentions two forms of the wild species, comparatively permanent; to which we have added several others, the result of cultivation, and which are more or less accidental or temporary. To these we might have subjoined a class of wild pears with hoary leaves, such as *P. nivalis*, *P. salicifolia*, &c., which we consider as varieties, or races, though commonly treated as species; but we have preferred giving them afterwards as distinct sorts.

‡ *P. c.* 1 *A'chras* Wallr. *Sched.*, p. 213.—Spiny leaves; woolly when young, but afterwards glabrous; the disk ovate, acuminate, entire; the petiole long. Tube of the calyx woolly when young, afterwards becoming glabrous. Pome with its basal part long.

‡ *P. c.* 2 *Pyrâster* Wallr. *Sched.*, p. 214., Gærtn. *Fr.*, t. 87. f. 2. — Spiny. Leaves roundish, acute, sharply serrated, glabrous even when young. Tube of the calyx, while young, glabrous. Pome rounded at the base.

‡ *P. c.* 3 *fôlis variegâtis* has variegated leaves.

‡ *P. c.* 4 *fructu variegâto* has the skin of the fruit variegated with yellow and white.

‡ *P. c.* 5 *sanguinolênta*, the *sanguinole Pear*, has the flesh of the fruit red, or reddish; and, though small and gritty, is not bad to eat when ripe.

‡ *P. c.* 6 *flôre plêno*; Poire de l'Arménie *Bon. Jard.*, p. 43.; has double flowers.

‡ *P. c.* 7 *jâspida*; Bon Chrétien à Bois jaspé *Bon Jard.*, edit. 1836, p. 424.; has the bark of the wood striped with yellow.

‡ *P. c.* 8 *sativa* Dec.—Without spines. This is the cultivated variety, of which there are very numerous subvarieties in gardens. For these De Candolle refers us to Miller's *Dictionary*, and to Du Hamel's *Des Arbres Fruitiêrs*; but, at the present time, by far the most complete collection in the world, of cultivated pears, is in the garden of the London Horticultural Society; and they are described in the *Fruit Catalogue* (edit. 1831) of that body. From this catalogue Mr. Thompson has made for us the following selection of sorts which are at once deserving of culture as ornamental trees, and as producing fruit of first-rate excellence.

Beurré Diel. Leaves large, and flowers very large. A hardy tree, somewhat fastigate in its shape; a great bearer, and deserving of exten-

sive cultivation on account of its fruit, independently altogether of its handsome shape and large flowers.

Beurré de Rans (not *Beurrée rance*, as commonly written, which means rank, or rancid). Branches spreading, or pendulous. The best very late pear yet known. It bears very well as a standard.

Bezi de la Motte. Leaves remarkably narrow.

Glout Morceau. Branches spreading. Head pyramidal. A hardy tree, and a great bearer. The fruit of most excellent flavour, and hanging late on the tree. The plate of this variety in Vol. II. is the portrait of a tree in our garden at Bayswater, planted in 1825; the trunk of which is covered with ivy; and which, notwithstanding this, is loaded with fruit almost every year, without any care or attention whatever being bestowed upon it.

Napoléon. Leaves broad and shining. Blossoms large. The tree vigorous, and a good bearer. The fruit excellent.

Swan's Egg. A handsome pyramidal tree, and an excellent bearer.

The fruit roundish, or obovate. This is one of the commonest pear trees in the market-gardens about London; and we have introduced the name here from having ourselves observed the handsome shapes taken by the trees. The fruit, however, as compared with that of the sorts recommended above by Mr. Thompson, is not worth cultivating; though, in the months of November and December, it is more abundant in the London markets than that of any other variety.

The following *Scotch pears* are recommended by Mr. Gorrie, as forms adapted for landscape scenery; but little can be said in favour of their fruit, as compared with that of the new Flemish varieties.

The Benvie, the Golden Knap, and the Elcho take fastigate forms; the latter more especially, Mr. Gorrie says, may be called the Lombardy poplar of the pear tribe. These trees generally attain the height of from 45 ft. to 50 ft. in as many years, in the Carse of Gowrie, in Perthshire.

The busked Lady and the Pow Meg take spreading orbiculate forms, such as will assort with the *Acer Pseudo-Platanus*, and may be called the oaks and elms of the pear family. (See *Gard. Mag.*, vol. iv. p. 11.)

Description. The pear tree, in a wild state, has a pyramidal-shaped head, with thorny branches, at first erect, and afterwards curved downwards and pendulous. The roots are few, and descend perpendicularly, with few lateral ramifications, except in shallow and rich soil. The leaves vary exceedingly in different soils, and in different parts of Europe and Asia: in Britain, they are generally green, and slightly tomentose, and do not differ greatly in magnitude; but in the woods of Poland, and in the vast steppes of Russia, the leaves of the wild pear trees are commonly white with down, and vary so exceedingly in their dimensions, as to include what are called the willow-leaved, the sage-leaved, the elæagnus-leaved, and other narrow-leaved varieties, which by many are considered to be species. The fruit of the pear, in a wild state, is seldom more than a fourth part of the size of even the most ordinary cultivated varieties; and it is also austere, and unfit to eat. The plant is always found on a dry soil, and more frequently on plains than on hills or mountains; and solitary, or in small groups, rather than in woods and forests. The rate of growth is 2 ft. or 3 ft. a year for the first 6 or 7 years; in 10 years it will attain the height of 20 ft. in gardens; and in 30 years the height of 50 ft., with a trunk from 1 ft. to 18 in. in diameter; which may be considered its average dimensions in Britain. The tree is of great longevity. M. Bosc says that he has seen trees that were considered to be more than 400 years old; and Mr. Knight believes that there are trees of the Teynton squash (a famous perry pear) which existed as early as the beginning of the fifteenth century. All writers on trees, from Theophrastus to the present day, agree that, as the tree grows old, it increases in fruitfulness; which is, indeed, the case with most other trees.

Geography. The pear is a native of Europe, and of Western Asia, the Himalayas, and China; but not of Africa or America. It is found wild in most counties of England, and in Scotland, as far north as Forfarshire; but, probably, in some localities, the apparently wild pears have sprung up from seeds, carried from the gardens of the monasteries, and other religious houses, by birds. It is found in Europe, from Sweden to the Mediterranean; and in Asia, as far east as Japan and China. According to Mirbel, the pear every where accompanies the apple; but, while the latter, or, at least, the variety (or species, as it is considered by some), *P. Malus coronaria*, is indigenous to North America, no species or variety of pear has ever been found wild in that country. In England, according to Gerard, the wild pear is to be found in woods, and on the borders of fields. According to Withering, it grows in hedges and woody wastes. It loves, he says, a fertile soil and sloping ground, and will not thrive well in moist bottoms. It stands the severest winters, and does not destroy the grass growing under it near so much as the apple, on account of its pyramidal growth and descending roots. Near London, it grows in hedge wastes to the north of Finchley; and, according to H. C. Watson (*New Botanists' Guide*, p. 88.) and Cooper (*Flora Metropolitana*, p. 27.), it is found about Thames Ditton.

History. The pear is mentioned, by the earliest writers, as common in Syria, Egypt, and Greece; from which latter country it appears to have been brought into Italy. Theophrastus speaks of the productiveness of old pear trees; and Virgil mentions some pears which he received from Cato. Pliny, in his 15th book, describes the varieties in cultivation in his time as being exceedingly numerous; and mentions a number which were named after the countries from which they were received. Of all pears, he says, the Crustumine is the most delicate and agreeable. The Falernian pear was esteemed for its juice; and the Tiberian pear, because it was preferred by the Emperor Tiberius. There were "proud pears," which were so called because they ripened early and would not keep, and "winter pears," pears for baking, &c., as at the present day. "All pears whatsoever," Pliny observes, "are but a heavy meat, unless they are well boiled or baked." When the cultivated pear was introduced into Britain is uncertain; but there can be little doubt that it was brought here by the Romans; and it is by no means improbable that all our wild pears have originated in the seeds of these cultivated sorts, accidentally disseminated by birds. The pear is mentioned by Chaucer; and, in the time of Henry VIII., it appears that the warden (so called from its property of keeping) was in cultivation; for, among certain charges in an old account-book in the Exchequer, 3s. 4d. is mentioned for "medlars and wardens," and 12d. for "pears," probably some commoner sort. In Gerard's time, the Katherine pear (a small red early fruit, still occasionally sent to market, No. 172. *Hort., Soc. Cat.*, and called by Gerard *Pyrus superba*, sive *Katherina*) was considered the best: but he enumerates 7 sorts, all of which, he says, and many more sorts of "tame peares," and those "most rare and good, are growing in the ground of Master Richard Pointer, a most cunning and curious graffer and planter of all manner of rare fruits, dwelling in a small village neere London, called Twicknam; and also in the ground of an excellent graffer and painfull planter, Mr. Henry Banbury, of Touthill Street, neere Westminster; and likewise in the ground of a diligent and most affectionate lover of plants, Mr. Warner, neere Horseydowne, by London; and in divers other grounds about London." To this, Johnson, in his improved edition of Gerard's *Herbal*, in 1596, adds: "Most of the best peares are at this day to be had with Mr. John Miller, in Old Street, in whose nursery are to be found the choisest fruits this kingdome yeelds." (*John. Ger.*, p. 1458.) The number of cultivated varieties known in Philip Miller's time amounted to above 250, from which he selects 70 or 80 as the best; and Du Hamel enumerates 119, to which he says 30 or 40 more indifferent sorts may be added. The number has been constantly increasing, both in France and England; and a great accession has been made to the number of the best sorts, from Belgium, in consequence of many thousand seedlings having been raised by Dr. Van Mons of Louvain, and other amateurs of

that country. All these have been collected by the London Horticultural Society, Mr. Braddick, and some other persons; and most of them have been proved in the Horticultural Society's Garden: a Herculean task, which has been commenced on sound principles, judiciously pursued, and successfully accomplished; and the credit of which is due to Mr. Sabine. The number of names of pears in the Horticultural Society's *Fruit Catalogue*, published in 1831, exclusive of synonymes, is 677; which number may be considered as including all the best sorts then known, but to which additions are making annually. For selections of these sorts suited to the various purposes of fruit-growers, we refer to the *Gardener's Magazine*, vol. xi. p. 34.; to the *Encyclopædia of Gardening*, edit. 1835, § 4840.; and to the lists of pear trees in our *Suburban Gardener*.

Properties and Uses. The wood of the wild pear is heavy, strong, compact, of a fine grain, and slightly tinged with red. It weighs, green, 79 lb. 5 oz. per cubic foot; and, when dry, from 49 lb. to 53 lb. This wood, in common with that of all the Rosæcæ, is liable to have its natural colour changed by steeping it in water; which ought, therefore, to be avoided when it is intended for particular purposes. It is readily stained black, and then so closely resembles ebony as to be scarcely distinguishable from it. According to Du Hamel, it is, next to the true service (*P. Sórbus doméstica*), the best wood that can be employed by wood engravers; which use Gerard also seems to hint at when he says it "likewise serveth to be cut into many kindes of moulds; not only such prints as these figures are made of, but also many sorts of pretty toies, for coifes, brest-plates, and such like, vsed among our English gentlewomen." (p. 1459.) For the wood engraver, however, it is far inferior to the box; though it is allowed to be very hard and homogeneous, and yet easy to cut, and, when perfectly dry, not liable either to crack, or to warp. For coarse engravings on wood, such as large plans, &c., we have no doubt that it would succeed perfectly. When it can be obtained, it is much used by turners and pattern makers; also for joiners' tools, and to make various articles which are dyed black in imitation of ebony. As fuel, the wood of the pear is excellent, producing a vivid and durable flame, accompanied by intense heat. It also makes excellent charcoal. The leaves, according to Withering, afford a yellow dye, and may be used to give a green to blue cloths.

The great use of the pear tree, however, is as a fruit tree. The fruit is used in the dessert, and for stewing and preserving. It is also occasionally used in tarts, though very inferior for this purpose to apples. In France and Belgium, the fruit is very generally dried in ovens, in which state it forms an article of commerce both domestic and foreign, and will keep a year. It is also dried in this manner in Russia; and, when stewed, is excellent, either as a substitute for pies and puddings, or as forming part of the dessert. Pears are dried in France in two ways: one, for family use, by putting them, without their being pared, into an oven, after the bread is drawn, either on the bricks, or on raised frames of tin or boards. The pears are put in two, three, and sometimes even four times, according to their size, and to the degree of heat that there is in the oven. The only things that it is necessary to attend to are, to take care that the oven is not so hot as to burn the pears, and that they are not left in so long as to make them hard. Melting sugary pears, of the middle size, are the best for this purpose; and, when properly prepared, they may be kept in bags, in a dry place, for several years. The second mode is that used for preparing the pears sold in boxes at the grocers' shops; and rather small pears are considered best. They must be gathered before they are quite ripe, and care taken to preserve the stalk. They are then parboiled in very little water, peeled, and placed on dishes with the stalks uppermost. In this state a kind of syrup runs from them, which must be carefully poured off, and set on one side. They are next placed on raised frames, and put into an oven after the bread has been drawn, or heated to a similar degree, and left there 12 hours; after which they are taken out and steeped in the syrup, which has been sweetened with sugar, to which have been added a little cinna-

mon and mace, and a small quantity of the best brandy. The pears, when taken out of the syrup, are again placed in the oven, which should not be made quite so hot as it was the first time. The operations of alternately steeping and drying are repeated three times, and are finished by putting the pears, for the fourth time, in the oven, and leaving them there till they are quite dry; when, if they have been properly treated, they will be of a clear pale brown, with fine and half-transparent flesh. They are then arranged in boxes garnished with white paper, and kept in a dry place, or offered for sale. They will remain good for three years, but are considered best the first year. (*Nouv. Cours d'Agr.*, vol. xii. p. 146.)

Perry is also made from pears, for which purpose the pear tree is extensively cultivated in different parts of Worcestershire and Herefordshire; and it is also so employed in various parts of France and Germany. The sorts used for making perry are such as have an austere juice; such as the squash, the Oldfield, the Barland, the huff-cap, the sack pear, the red pear, and the Longland, which last, though considered inferior to the others, is the pear most generally in use. (*Herefordshire Report*, p. 78.) Perry is made in the same manner as cider, see p. 894. The pear trees for producing the fruit should be planted in rows, not less than 18 yards asunder, to allow the air to have free access to the trees. The pears should be gathered before they begin to fall; and they should be ground as soon as possible. Perry will not always be so clear, when racked off, as cider; but it may be fined in the usual manner by isinglass, in the proportion of $1\frac{1}{2}$ oz. or 2 oz. to a cask of 110 gallons. Every tree when full grown, and in good soil, will produce about 20 gallons of perry a year, and some in Herefordshire have yielded a hogshead in one season. An acre of land is generally planted with 30 pear trees, and the produce in most cases, and with similar advantages of soil and situation, is found to be one third more than that of an orchard planted with apple trees. Pears, by the Romans, were considered as an antidote to the effect of poisonous mushrooms; and to this day perry is said to be the best thing that can be taken after a surfeit of that vegetable. In England, an agreeable wine is made from a mixture of pears with crab apples; and the same thing is done in France, where it is called piquette, and is used by the country people as a substitute for wine when the vintage has been unfavourable.

Soil and Situation. It is essential that the soil should be dry; and, where the tree is intended to grow large, and be productive, it ought to be deep and good. In respect to situation, where the pear tree is grown for its timber, or its effect in landscape scenery, it may either be planted at regular distances, as in an orchard, in lines in a hedgerow, or in scattered groups. There are few trees better adapted for being grown in hedgerows than the fastigate-growing varieties of pear, because their roots descend perpendicularly, and can, therefore, never interfere with the plough; and the heads, whether fastigate or spreading, it is known from experience, do very little injury to pasture. If, therefore, fastigate-growing trees, producing excellent sorts of fruit, were planted in all hedges, a very great benefit would result to the proprietors and to the public; and that such will be the case we have little doubt, when once it is more generally known that the trees producing the exquisitely flavoured new kinds, in the Horticultural Society's Garden, and now to be procured in most nurseries, are as hardy and as prolific as those producing the "choke pears" of Gerard, or the commonest sorts brought to market at the present day: sorts that the late eminent fruiterer, Mr. Grange, used to observe, were such "as no gentleman would eat." We wish we could strongly impress on the minds of our readers this most important fact; viz. that the very best kinds of pears might be produced with the very same trouble and expense as are now employed to produce some of the most inferior description; and that the quality of the timber, and the effect of the tree in landscape, may be as good in a tree producing a fine-flavoured, juicy, melting fruit, as in one producing fruit that is dry, hard, and gritty, or flavourless and mealy.

Propagation and Culture. The wild pear is continued by seed; and the

varieties cultivated for their fruit are budded or grafted on stocks of different kinds. For the poorer soils, and exposed situations, stocks of the wild pear of the given locality must, doubtless, be the best, because they must be the hardest: but it is found from experience, and it is consistent with physiological principles, that, on good soils, or where the pear is to be cultivated entirely as a fruit tree, both the tree and the fruit will grow larger when the stock is a seedling pear of some vigorous-growing variety. (See *Bosc* in *N. Cours d'Agri.*, and *Baudril.* in *Dict. des Eaux, &c.*) Such stocks, it has also been found by the French gardeners, throw the scions sooner into bearing than wild stocks; though it is reasonably conjectured that the trees will not prove quite so durable. When dwarf trees are required, the pear is grafted on the quince, the medlar, or the thorn; or on the mountain ash, or some other species of *Sorbus*. It grows remarkably well on the common hawthorn; though, unless the graft be made under ground, it does not form a very safe and durable tree; because, as the scion increases faster in diameter than the stock, it is liable to be blown off. When the graft, however, is made close to the surface of the ground, or immediately under the surface, the root swells in nearly the same proportion as the scion, and there is no danger of the tree being blown down, or of its not being sufficiently long-lived. In the Fountain Bridge Nursery, near Edinburgh, which was occupied, about the middle of the last century, by Gordon, the author of the *Gardener's Dictionary*, there were standards, in 1806, with trunks above a foot in diameter, and heads in proportion. These, judging from the suckers that used to rise up in the ground round the base of their trunks, were all grafted on the common thorn. Where hawthorn hedges are planted on good soils, and grow vigorously, we would recommend, when the hedge, in the routine course of management, is cut over by the ground, grafting a stump, or root, with a pear scion at every 20 ft. In this case, supposing the stock to be five or six times the diameter of the scion, the single shoot of pear produced the first year by the scion would be such as entirely to overtop the numerous shoots of the same year produced by the adjoining thorn stumps; and, by careful removal of suckers, and training for a year or two, the hedge would soon be furnished with handsome vigorous standard pear trees. This we conceive to be the only practical mode of introducing standard pear trees into a hedge already some years planted; but when, on planting a hedge, it is determined to have standard pear trees in it, we would recommend standards on wild pear stocks to be procured from the nursery, and planted at the same time as the hedge plants. There is no such thing as accomplishing, with success, the introduction of young trees among old established trees, either in a close hedge, or in a close wood. In France, and in some parts of England, wild pear trees and crabs rise up accidentally in the seed-beds of hawthorns, in the nurseries; and are, consequently, planted out with the thorns in the hedgerows, where they become trees, and produce fruit; from which source some good new varieties have been obtained in both countries. This naturally suggests the idea of planting pear and crab stocks in a hedge along with hawthorn plants, in a regular and systematic manner; and grafting or budding these with suitable varieties, when they have attained sufficient height for becoming standards. This, though not the most rapid mode, is yet by far the most economical, of introducing fruit trees in hedgerows. We would, therefore, strongly recommend those who are favourable to our views in regard to the introduction of fruit trees in hedges, to introduce into every newly planted hedge a stock, either of pear, apple, cherry, or plum, at every 20 ft., 30 ft., or 40 ft. distance, according to circumstances, and to cause these to be trained up with single stems, and grafted or budded when of the proper height. Even if these plants were not trained up to single stems, or grafted, they could never do any harm to the hedge; because it is well known, that very good hedges have been formed of crabs, wild pears, and wild plums or damsons. The oldest British writers on husbandry, such as Standish, Tusser, &c., have recommended this practice;

and the objection made now to it by proprietors is the same as it was in former days. "The poore will breake downe our hedges, and wee shall haue the least part of the fruit;" but, notwithstanding this fear, we repeat, with Gerard, whose words we have above quoted, "Forward, in the name of God, grafte, set, plant, and nourish up trees in euery corner of your ground: the labour is small, the cost is nothing; the commodity is great: your selues shal haue plenty; the poore shall haue somewhat in time of want to relieve their necessity; and God shall reward your good mindes and diligence." (*Herbal*, p. 1459.) In the autumn of 1828, when in the south of Germany, we were much struck with the beauty and value of the lines of fruit trees which bordered all the public roads; the apples and pears having their branches bent to the ground with fruit. On our return, we published the following observations in the *Gardener's Magazine*, which were met by exactly the same objections from our correspondents as those stated by Gerard to have been urged in his time, nearly 300 years ago:—"The common objection to planting fruit trees in hedges is, that depredations would be made on them by the poor; but it is to avoid such depredations on the fruit trees of the rich, and to assist in humanising and rendering better and happier the poor, that we are desirous of introducing fruit trees every where. If the poor in Britain and Ireland were rendered what the poor are in Wurtemberg and Baden, fruit trees here would be as safe as they are there. If apples and pears were as commonly grown as potatoes and turnips, depredations would not be more frequently committed on the one kind of crop than on the other. The cherry and the pear are particularly eligible as hedgerow fruit trees, and would supply kirschwasser (see p. 697.) and perry; and entire hedges might be made of many sorts of plums and apples, for plum brandy (see p. 690.) and cider, besides the common culinary purposes of the fruit." (*Gard. Mag.*, vol. v. p. 115.)

A valuable application of the new sorts of pears is, to insert scions of them on old pear trees of inferior sorts, after heading the latter down. As grafts can readily be procured from the Horticultural Societies of London and Edinburgh, by all who are fellows of these societies, for the trouble of asking; and, by those who are not fellows of any society, for a mere trifle, from the nurserymen; there can be no sufficient excuse for not performing this important operation whenever an opportunity is afforded.

It may be alleged by some, that nurserymen will not sell grafts or scions; but, if any refuse to do this, all that is requisite is, to purchase a plant from them, and cut the shoots off it, treating these shoots as scions for budding or grafting are usually treated. If the plant is purchased in the summer, in time for budding from its shoots, an arrangement may be made with the nurseryman for letting it stand in the nursery till the drawing season, in the autumn; when it will most likely have made a second series of shoots, which may be either cut off for grafting; or the plant may be removed, and serve as a tree. We mention this, to show that no nurseryman has anything to gain by refusing to sell grafts, either of fruit trees, or of any other tree. Some very interesting experiments on grafting cankered pear trees with new vigorous-growing Flemish sorts will be found detailed by Mr. Rivers, in the 12th volume of the *Gardener's Magazine*; by which it appears, that trees in such a diseased state that their trunks were eaten through in every direction by an insect in the larva state (probably the *Dórcus*

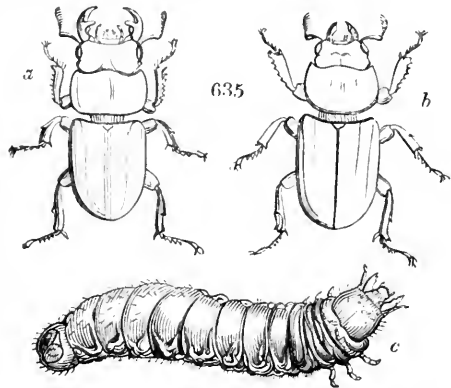

parallelospēdus *Stephens*, or lesser stag beetle, *fig. 635.*; in which *a* is the male, *b* the female, and *c* the larva), were, when grafted, so completely restored to vigour as to stop the ravages of this destructive insect. As the pear grafts readily on the different species of *Sórbus*, whenever these trees abound in woods, they may be changed into the finest sorts of French and Flemish pears, by the simple process we have been recommending.

Accidents, Diseases, Insects, &c. The pear, as a standard tree, is not liable to have its branches broken off or disfigured by the wind; nor is it nearly so liable to canker as the apple tree. It is liable to the attacks of insects, but certainly not so much so in fields as in gardens, and perhaps no where to the same extent as the other edible fruit-bearing *Rosàcæ*. On a large scale, there is, perhaps, no cure worth attempting for insects or mildew on the leaves; but shallow planting, surface manuring, and re-grafting, are excellent preventives and correctives for these and all other evils to which the pear, and all other *Rosàcæ*, are liable. The larva of the *Zeuzèra æ'sculi Lat.*, the Wood Leopard Moth, (*fig. 636.*; in which *b* is the larva, and *a* three of its spiracles or breathing apertures,) lives upon the wood of the pear, as well as on that

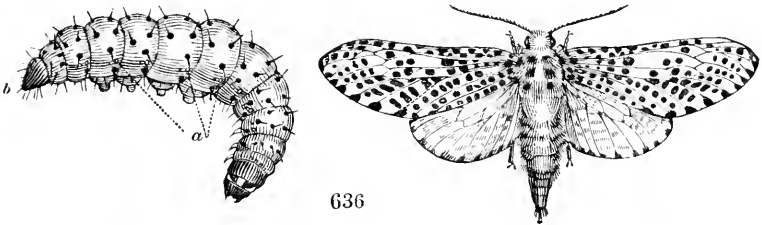

636

of the apple, service, quince, and probably of all the *Rosàcæ*; as it is known to do on the horsechestnut, lime, walnut, beech, birch, and oak. Some idea may be formed of the manner in which this insect commits its ravages, by inspecting *fig. 637.*, which is a longitudinal section of part of the trunk of a

in. 1 0 1 2 3 4 5 6 7 in.

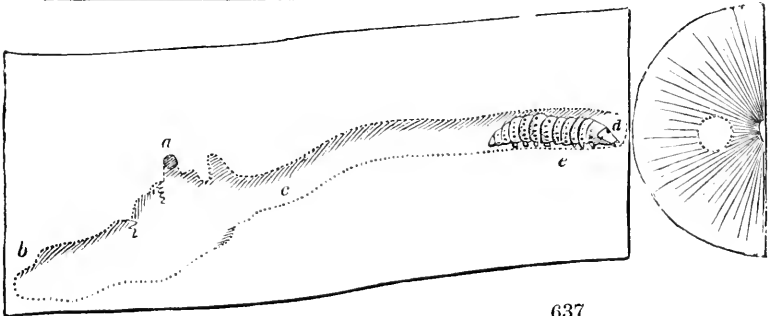

637

pear tree, to a scale of $3\frac{1}{4}$ in. to a foot. The egg of the insect having been laid on or in the bark, the young larva appears to have entered by forming a small hole at *a*, and to have taken a downward direction in the soft wood; as the cavity was not more than an eighth of an inch sunk into the wood till reaching *b*, where it was rather more than three eighths, and was, when the section was made, partly filled with the excrements of the larva. At *c*, the cavity begins gradually to approach the centre of the tree, and take a regular shape, and continues at about half an inch in diameter as far as *d*; the distance from *b* to *d* being $11\frac{1}{2}$ in.; and the distance from *d* to the circumference of the tree $1\frac{1}{2}$ in., as shown by the transverse section at *f*. The larva of this insect is of a deep

yellow, dotted with black, and it has a black head and tail, and very powerful jaws. It is believed that it remains at least two years in the larva state; a month and a few days in the pupa state; and two months or more as a perfect insect or imago. Some exceedingly interesting information respecting this insect will be found in the *Mag. Nat. Hist.* vol. ii. p. 66. and 291., and also in the *Gard. Mag.*, vol. xii. *Æcidium cancellatum* Sowerb. is a fungus that originates in the leaves of pear trees; and in moist seasons, and in close situations, it sometimes appears to a great extent, occasioning a premature falling of the leaves. There seems to be no remedy, but that of increasing the airiness of the situation, and this may always be done to a certain extent by thinning out the branches of the tree. An engraving of this fungus, which is commonly called the blight, together with some interesting remarks on it, will be found in the *Gard. Mag.*, vol. ix. p. 32, 33.

Statistics. The oldest pear trees in the neighbourhood of London are at Twickenham, where they may be seen from 50 ft. to 60 ft. high, with trunks from 18 in. to 3 ft. in diameter; and, in all probability, were from the nursery of Gerard's "curious and cunning grafter, Master Richard Pointer," whose real name was Corbett, and who was father to Bishop Corbett, the poet. (See *Encyc. of Gard.*, edit. 1835, § 1307.) In the Fulham Nursery, there is a seedling pear, 50 years planted, which is 60 ft. high. In Nottinghamshire, at Old Basford, there is a pear tree of the kind known as the brown dominion, which, in 1826, was upwards of a century old. It is 10 ft. high, with a head 54 ft. in diameter, and a trunk 2 ft. 3 in. in diameter. From 1806 to 1826, the produce of this tree, on an average, was 50 pecks of pears a year. In the year 1823, it bore 107 pecks, each peck containing 120 pears; and in 1826 it produced 100 pecks of 279 pears each; which, when gathered, weighed 20 lbs. each peck; making a total of a ton weight of pears in one year. As the tree grows older, the fruit becomes larger and finer; so that it requires more than 100 pears less to fill the peck now, than it did 26 years ago. This increase in the size of the fruit is, doubtless, owing to the field in which the tree stands being frequently top-dressed with manure. In Herefordshire, "A very extraordinary tree, growing on the glebe land of the parish of Hom-Lacey, has more than once filled 15 hogsheads of pery in the same year. When the branches of this tree in its original state became long and heavy, their extreme ends successively fell to the ground, and, taking fresh roots at the several parts where they touched it, each branch became as a new tree, and in its turn produced others in the same way. Nearly half an acre of land remains thus covered at the present time [1805.] Some of the branches have fallen over the hedge into an adjoining meadow, and little difficulty would be found in extending its progress." (*Rep.*) Being anxious to know the present state of this celebrated tree, we wrote to a highly valued friend, residing at Hereford, respecting it, and we have been favoured with the following reply:—"I have been this morning to see the far-famed pear tree. It once covered an acre of land, and would have extended much further had nature been left to her own operations. It is now not a quarter the size it once boasted; but it looks healthy and vigorous, and when I saw it, it was covered with luxuriant blossoms. The original trunk is still remaining; and there are young shoots which are only yet approaching the ground, but which seem nearly ready to take root in it. The tree would completely have covered the vicarage garden if it had been allowed to remain. It is said to have been in its greatest perfection about 1776 or 1777. There is another tree of the same kind in the neighbourhood. *Hereford, May 18, 1836.*" In Scotland, there are several large pear trees. Near Edinburgh, at Restalrig, in a garden adjacent to what was the house of Albert Logan of Restalrig, who was attainted in the reign of James VI. (of Scotland, and the First of England), and which was probably planted before his forfeiture, the tree, at 2½ ft. from the ground, girths 12 ft. It is of the kind called the golden knap, which, in Scotland, is generally considered as the best kind of tree to plant, when it is wished to produce timber. Dr. Neill has mentioned a number of very old pear trees, standing in the neighbourhood of Jedburgh Abbey, and in fields which are known to have been formerly the gardens of religious houses in Scotland, which were destroyed at the Reformation. Such trees are, for the most part, in good health, and are abundant bearers; and as some of them must have been planted when the abbeys were built, they are, probably, from 500 to 600 years old.

‡ 2. *P. (C.) SALVIFOLIA* Dec. The Sage-leaved, or *Aurelian*, Pear Tree.

Identification. Dec. Fl. Fr., 531., in a note; Prod., 2. p. 634.; Don's Mill., 2. p. 622.

Synonymy. Poirier Sauger *D'Ourch* in *Bibl. Phys. Econ.*, Mai, 1817, p. 299.

Spec. Char., &c. Branches thick. Buds tomentose. Leaves lanceolate, entire, tomentose all over when young; when adult, glabrous on the upper surface. Fruit thick, long, fit for making perry. Wild and cultivated about Aurelia, in France. (*Dec. Prod.*, ii. p. 634.) Introduced by the London Horticultural Society, in 1826; and, in our opinion, only a variety of the common wild pear.

‡ 3. *P. (C.) NIVALIS* Lin. *fil.* The snowy-leaved Pear Tree.

Identification. Lin. *fil. Suppl.*, 253.; Jacq. Fl. Austr., t. 107.; Dec. Prod., 2. p. 634.; Don's Mill., 2. p. 623.

Engraving. Jacq. Fl. Austr., t. 107.

Spec. Char., &c. Leaves oval, entire, obtuse, white and silky beneath. Corymbs terminal. Fruit globose, very acid, except when ripe and beginning to decay, when it becomes very sweet. (*Dec. Prod.*, ii. p. 634.) A native of the Alps of Austria, where it grows to the height of 10 ft. or 12 ft. It was introduced into the Horticultural Society's Garden in 1826, or before;

and is already 15 ft. high, forming a very handsome white-foliaged tree; though, as we think, decidedly only a variety, or race, of the common wild pear. There are very handsome small trees of this sort, besides those in the Horticultural Society's Garden, at Bagshot in Surrey, and at Grimston in Yorkshire; some of which, in both places, are 20 ft. high, and are very prolific in flowers and small green fruit.

‡ 4. *P. (C.) SINAIICA* Thouin. The Mount Sinai Pear Tree.

Identification. Thouin Mém. Mus., 1. 170. t. 9.; Dec. Prod., 2. p. 634.; Don's Mill., 2. p. 622.

Synonymes. *P. Sinài Desf. Arb.*, 2. p. 144., *N. Du Ham.*, 6. t. 57.; *P. pérsica Pers. Syn.*, 2. p. 40.; the Mount Sinai Medlar.

Engravings. Mém. Mus., 1. t. 9.; *N. Du Ham.*, 6. t. 57.; *Dend. Brit.*, t. 49.; and our plate in Vol. 11.

Spec. Char., &c. Very much branched, and spreading. Buds whitishly pubescent. Leaves ovate-oblong, subacute, very minutely crenated, whitishly pubescent beneath; above glabrous, and almost shining, falling off late. (*Dec. Prod.*, ii. p. 634.) A native of Mount Sinai, whence it was brought to the Paris Garden early in the present century, and introduced into England in 1820. It so closely resembles the preceding sort, as hardly to be distinguishable from it; and we have no doubt that seeds of either, if sowed to a considerable extent, would produce plants of both kinds.

‡ 5. *P. (C.) SALICIFOLIA* L. The Willow-leaved Pear Tree.

Identification. Lin. Suppl., 255.; Dec. Prod., 2. p. 635.; Don's Mill., 2. p. 622.

Engravings. Pall. Itin., 3. p. 374. t. N. f. 3.; *Fl. Ross.*, 1. t. 9.

Spec. Char., &c. Buds whitely tomentose. Leaves linear-lanceolate, acute, entire, hoary, particularly upon the under surface. The disk three times as long as the petiole. Flowers upon short pedicels, disposed in corymbs, a few in a corymb. (*Dec. Prod.*, ii. p. 634.) A native of Siberia, common in the deserts between the rivers Cuma and Terec; and found, also, on Caucasus, and in Persia, generally accompanied by *C. Oxycántha* and *Prúnus spinósa*. It was introduced into England in 1780; and forms a very distinct variety; attaining the height of 20 ft. or 25 ft. There are fine trees of this sort, 20 ft. high, at White Knights.

‡ 6. *P. (C.) ELEAGNIFOLIA* Pall. The Oleaster-leaved Pear Tree.

Identification. Pall. Nov. Act. Petr., 7. 1789, p. 355. 7.; Steud. Nom. Bot.; Dec. Prod., 2. p. 634.; Don's Mill., 2. p. 622.

Synonymes. *P. orientális Horn. Suppl.*, 52., from the synonyme of Tournefort cited.

Spec. Char., &c. Leaves oblong, lanceolate, acute, entire, tomentose on both surfaces. The disk scarcely longer than the petiole. Flowers in corymbs. (*Dec. Prod.*, ii. p. 634.) A native of the woods of Iberia, Tauria, and Caucasus; and so closely resembling the preceding sort, as, in our opinion, not to be distinguishable from it by any permanent marks. Introduced in 1800; and to be found in the Horticultural Society's Garden, and at White Knights.

‡ 7. *P. (C.) AMYGDALIFORMIS* Vil. The Almond-shaped Pear Tree.

Identification. Vill. Cat. Strasb., 322.; Dec. Suppl., 531.; Dec. Prod., 2. p. 634.; Don's Mill., 2. p. 622.

Synonymes. *P. sylvéstris Magnol Bot.*, 215.; *P. salicifolia Lois. Not.*, 79.

Spec. Char., &c. Spiny. Buds tomentose. Leaves oblong, acute, entire; tomentose all over when young; when adult, glabrous on the upper surface. The disk six times longer than the petiole. Flowers in corymbs. (*Dec. Prod.*, ii. p. 634.) Wild in rough places in France, in Provence, Dauphiny, and Languedoc; and very closely resembling the preceding sorts. It was introduced in 1810; and the finest plant that we know of it, in the neighbourhood of London, is at Kenwood; where it is 22 ft. high, with a very irregular picturesque head, and many of the side branches sweeping the ground. In May, it is completely covered with white blossoms, and in autumn with small green fruit, which drop off with the first severe frost.

‡ 8. *P. SINE'NSIS* Lindl. The Chinese Pear Tree.

Identification. Lindl. Hort. Trans., 6. p. 396.; Don's Mill., 2. p. 622.

Synonymes. *Pyrus communis Lois. Cochin.*, p. 321.; *P. sinica Royle Illustr.*, p. 207.; *Ri vulgo Nas, Japanese, Kämpf. Amœn.*, fasc. 804.; the Sandy Pear, Snow Pear, Sand Pear; *Sha lee, Chinese.*

Engravings. Bot. Reg., t. 1148.; and our plate in Vol. 11.

Spec. Char., &c. Leaves cordate, apiculated, shining, serrated, and, when young, pubescent beneath. Peduncles corymbose. Calyx glabrous inside. Fruit warty and bony. (*Don's Mill.*, ii. p. 622.) The flowers are white, slightly tinted with pink; and they appear in April and May. It was introduced in 1820. The tree is a native of China and Cochin-China; and grows to the height of 15 ft. or 20 ft. In the *Botanical Register*, Dr. Lindley observes that *P. sinensis* differs from the common pear in having longer and greenish branches, and larger, more lucid, and almost evergreen leaves; insipid, apple-shaped, warty, very gritty fruit; and a calyx, the inside of which is destitute of the down that is found on all the varieties of the European pear. The tree is perfectly hardy, and it is ornamental; but it is worthless as a fruit tree. (*Bot. Reg.*, t. 1248.) The tree vegetates very early in spring; when it is easily recognised by the deep rich brown of its young leaves and shoots. (*Hort. Trans.*, vol. vi. p. 397.) Royle says, this is the only kind of pear known in the gardens of India, into which it was introduced from China; and that it more nearly resembles the English baking pear than any other. (*Illustr.*, p. 206.)

‡ 9. *P. BOLLWYLLERIANA* Dec. The Bollwyller Pear Tree.

Identification. Dec. Fl. Fr. Suppl., p. 530; Prod., 2. p. 634; N. Du Ham., 6. p. 191; Don's Mill., 2. p. 522.

Synonyms. *P. bollwylleri* J. Bauh. Hist., 1. p. 59. ic.; *P. Pollvèria* Lin. Mant., 234; *P. auricularis* Knoop. Pomol., 2. p. 38. t. 4, according to Reichenbach.

Engravings. J. Bauh. Hist., ic.; Knoop. Pomol., 2. p. 38. t. 4, according to Reichenbach; N. Du Ham., 6. t. 58; and our plate of this species in Vol. II.

Spec. Char., &c. Buds downy. Leaves ovate, coarsely serrated, tomentose beneath. Flowers many in a corymb. Fruit top-shaped, small, yellowish within. (*Dec. Prod.*, ii. p. 634.) Cultivated in the Bollwyller Gardens, from the time of J. Bauhin; and, according to Du Hamel, named either from the village of Bollwyller, in Alsace, in the neighbourhood of which it was found in a hedge, as we are informed by Dr. Lippold; or after a baron of that name, in whose garden it was first cultivated. It is a very distinct variety, with large rough leaves, having somewhat the appearance of those of the apple. The fruit is turbinate, small, orange yellow, and unfit to eat. The tree produces fewer branches than any other species or variety of pear; and these branches are upright, thick, and rigid. It has been in cultivation since 1786, having been introduced by Græffer, gardener to the Earl of Coventry, at Croom, and afterwards to the King of Naples. There is a fine tree of this species at Kenwood, 26 ft. high; another, of the same height, at White Knights; and one in the Oxford Botanic Garden, 34 ft. high.

‡ 10. *P. CRENA'TA* Don. The notched-leaved Pear Tree.

Identification. D. Don. Prod. Fl. Nep., p. 237; Dec. Prod., 2. p. 634; Don's Mill., 2. p. 622.

Engravings. Bot. Reg., t. 1655; and our figs. 638, 639.

Spec. Char., &c. Branchlets whitely tomentose. Leaves oval, acute, erenated; glabrous above; whitely tomentose beneath when young. Petioles long.

Corymbs simple, and woolly. Sepals ovate, subacute. (*Dec. Prod.* ii. p. 634.) A native of Suembu, in Upper Nepal; and found from an elevation of nearly 12,000 ft. downward to 9000 ft., and lower. Introduced into Britain in

638



639

1820. It approaches to *P. bollwylleri*; but its leaves are erenated, and not serrated; and its flowers are more numerous. The fine large leaves

of this species render it very desirable as an ornamental plant. Dr. Lindley, after describing it, says: "Nature seems to have intended it to brave the utmost inclemency of climate; for, in its own country, in the earliest spring, the leaves, while still delicate and tender, are clothed with a thick white coating of wool; and the flowers themselves are so deeply immersed in an ample covering of the same material, as to bid defiance to even Tartarian cold. But, in proportion as the extent of the distribution of the plant descends towards the plains, or as the season of warm weather advances, it throws off its fleecy coat, and at length becomes as naked, and as glittering with green, as the trees which have never had such rigour to endure. In England, it scarcely acquires any part of its natural woolliness, but is as naked as our common beam tree." (*Bot. Rec.*, t. 1655.) There are plants of this species in the Garden of the Horticultural Society, and in the arboretum of Messrs. Loddiges; but their general appearance seems to us much more like that of an *Aria* than of a *Pyrus*.

‡ 11. *P. VARIOLO'SA* Wall. The variable-leaved Pear Tree.

Identification. Wall. Cat. 680.; Don's Mill., 2. p. 622.

Synonymy. *P. Pishia* Ham. ex Herb. Lin. Soc.

Engraving. Our plate in Vol. II.

Spec. Char., &c. Leaves ovate, acuminate, crenate, glabrous in the adult state, on long petioles; when young, clothed with yellowish tomentum beneath. Umbels terminal. Pedicels and calyxes woolly. (*Don's Mill.*, ii. p. 622.) A tree, a native of Nepal and Kamaon; where it is said by Mr. Royle to grow to a great height. It produces its white flowers, slightly tinged with pink, in April and May; and they are succeeded by pear-shaped fruit, which remain on the tree all the winter, and even till the flowers are produced the succeeding season; and at last die off of the colour of a ripe medlar. It was introduced in 1825, or earlier; and a plant, in the Fulham Nursery, ripened fruit in 1832. According to Royle, the fruit is not edible until it becomes somewhat decayed. In the open air, in mild winters, this species is subevergreen; and, against a wall, in the Horticultural Society's Garden, it is completely so. It forms a very handsome tree, very hardy, and of tolerably rapid growth, which is well worth a place in every collection.

App. i. *Species of Pyrus belonging to the Section Pyrôphorum, and not yet introduced.*

P. cuneifolia Gus. Pl. Rar., p. 202., Don's Mill., 2. p. 622., is a native of Calabria, on hills; said to be allied to *P. parviflora* Desf., and *P. salicifolia* L.

P. parviflora Desf. Cor., 78. t. 58.; *P. sylvestris crética* C. Bauh. Pin., p. 439., Don's Mill., 2. p. 623.; is a native of Candia, with red flowers; and is said to grow from 20 ft. to 30 ft. high.

P. Michauxii Bosc in Poir. Suppl., 4. p. 432., Don's Mill., 2. p. 623., is a native of North America, with globose fruit, growing to the height of 20 ft.

P. indica Colebr. Wall. Pl. Rar. Asiat., 2. t. 172., Don's Mill., 2. p. 622., is a native of the mountains of Sihat, in Bengal, with white flowers, fruit about the size of the wild pear, and leaves lobed in the young plants.

§ ii. *Mâlus.*

Sect. Char. Petals spreading, flat. Styles 5, more or less strictly connate at the base. Pome mostly globose, depressed, and invariably having a concavity at its base. Flowers in corymbs. Leaves simple, not glanded. (*Dec. Prod.*, ii. p. 635.) This section includes all the apples and crabs.

‡ 12. *P. MÂ'LUS* L. The common, or wild, Apple Tree.

Identification. Lin. Sp., 686.; Smith's Eng. Flora, 2. p. 362.; Lindl. Synop., 2d edit., p. 105.; Dec. Prod., 2. p. 635.; Don's Mill., 2. p. 623.

Synonymy. *P. Mâlus mitis* Waltr. Sched., p. 215.; *Mâlus communis* Dec. Fl. Fr.; Pommier commun, Fr.; gemeine Apfelbaum, Ger.

Engravings. Our plates in Vol. II.

Spec. Char., &c. Leaves ovate, acute, crenated, woolly on the under surface. Flowers in corymbs. Tube of calyx woolly. Styles glabrous. Wild in woods and way sides in Europe. (*Dec. Prod.*, ii. p. 635.) Cultivated in gardens, it is wholly, or conjointly with other species or races, the parent of innumerable varieties, termed, generally, in England, cultivated apple trees; and in France, pommiers doux, or pommiers à couteau. We adopt the specific name *Mâlus*, to indicate what may be called the actual form, for the sake of convenience, though many of the cultivated varieties are derived not only from the wild apple, or crab, of Europe, but from the crabs of Siberia. We shall designate these crabs as varieties of *P. Mâlus*, and afterwards make a selection from the cultivated sorts, of such as we think suitable for being planted for their timber, or as ornamental trees. We are aware that objections may be taken to this mode, as deviating from the arrangement given by De Candolle, who places the *P. acérba* as the first, and *P. Mâlus*, as the second species of this division; but it is so utterly impossible to refer the different varieties correctly to the wild forms from which they have been obtained, that we consider the priority of names as a matter of no sort of consequence. Besides, as we have, as usual, only indicated our own deviations from established authorities in parentheses, those who differ from us in opinion will find no difficulty in recognising the names and descriptions of De Candolle, and of the others who have followed in his footsteps.

‡ 13. *P. (M.) ACÉRBA* Dec. The sour-fruited Apple, or common Crab Tree

Identification. Dec. Prod., 2. p. 635.; Don's Mill. 2. p. 623.

Synonymes. *Pyrus Mâlus austera* Wallr. *Sched.*, 215.; *Mâlus acérba* *Merat. Fl. Par.*, 187., *Dec. Suppl.*, 530.; *M. communis sylvêstris* Desf.; *P. Mâlus sylvêstris* *Fl. Dan.*, t. 1101.; *P. Mâlus* Smith *Eng. Bot.*, t. 179.; Pommier sauvageon, Fr.; Holzapfelbaum, Ger. *Engraving.* Fl. Dan. t. 1101.

Description, &c. Leaves ovate, acute, crenated, glabrous even when young. Flowers in corymbs. Tube of the calyx glabrous. (*Dec. Prod.*, ii. p. 635.) A native of woods and way sides in Europe. This form, according to De Candolle, yields many subvarieties with sour fruit, called, in Britain, cider apples; and in France, generally, pommiers à cidre.

‡ 14. *P. (M.) PRUNIFOLIA* W. The Plum-tree-leaved Apple Tree, or Siberian Crab.

Identification. Willd. Sp., 2. p. 1018.; Dec. Prod., 2. p. 635.; Don's Mill., 2. p. 646.

Synonymes. *P. Mâlus* *et Ait. Hort. Kew.*, 2. p. 175.; ? *Mâlus hÿbrida* Desf. *Arb.*, 2. p. 141.

Engravings. Mill. Ic., t. 269.; and the plate in our Second Volume.

Description, &c. Leaves ovate, acuminate, serrated, glabrous. Peduncles pubescent. Tube of calyx glabrous. Styles woolly at the base; and, as appears from *Mill. Ic.*, t. 269., with the styles twice as long as the stamens, and the fruit subglobose, yellowish, and anstere. (*Dec. Prod.*, ii. p. 635.) A native of Siberia; introduced in 1758. According to Mr. Knight, some of the finest varieties raised by him are from cultivated apples fecundated with the blossoms of this tree. The progeny he found formed more hardy trees than any other kinds, and that they produced earlier and more highly flavoured fruit.

‡ 15. *P. (M.) BACCATA* L. The berry-like-fruited Apple Tree, or Siberian Crab.

Identification. Lin. Mant., 75.; Amm. Ruth., t. 31.; Pall. Fl. Ross., t. 10.; Dec. Prod., 2. p. 635.; Don's Mill., 2. p. 646.

Synonyme. *Mâlus baccata* Desf. *Arb.*, 2. p. 141.

Engravings. Amm. Ruth., t. 31.; Pall. Fl. Ross., t. 10.; and the plate in Vol. II.

Description, &c. Disks of leaves ovate, acute, equally serrated, glabrous, the length of the petiole. Flowers grouped. Sepals deciduous. (*Dec. Prod.*, ii. p. 635.) A native of Siberia and Dahuria, and only differing from the preceding sort, of which it is, doubtless, a subvariety, in not having a persistent calyx.

‡ 16. *P. (M.) DIOICA* W. The diœious-sexed Apple Tree.

Identification. Willd. Arb., 263.; Spec., 5. p. 1018.; Dec. Prod., 2. p. 635.; Don's Mill., 2. p. 646.

Synonymes. *P. apétala* Münch. *Hause.*, 5. p. 247., on the authority of Willdenow; *Mâlus dioica* *Audub. Cat.*

Description, &c. Leaves oval, serrated, tomentose beneath. Flowers, in many instances, solitary. Sexes diceious, by defect. Calyx tomentose. Petals linear, the length of the sepals. Styles glabrous. (*Dec. Prod.*, ii. p. 635.) Cultivated occasionally in gardens on the Continent; but we have not seen it in Britain.

‡ 17. *P. (M.) ASTRACÁNICA* Dec. The Astrachan Apple Tree.

Identification. Dec. Prod., 2. p. 635.; Don's Mill., 2. p. 646.

Synonyme. *Malus astracánica* Dum. Cours., ed. 2. 5. p. 426.

Description, &c. Leaves oval-oblong, acute, partially doubly serrated, pale beneath, and the nerves there villose, above glabrous, except being slightly downy on the midrib. (*Dec. Prod.*, ii. p. 635.) A native of about Astrachan, on the testimony of gardeners.

Varieties of P. Malus cultivated for their Fruit. From the above forms, we think it may safely be presumed, that all the apples cultivated for the dessert or the kitchen have been obtained, either by selection from seedlings, or from cross-fecundation; and that no other wild sort has been used, unless, perhaps, we except *Pyrus coronaria*; which, however, we have never heard of as being employed in cross-fecundation. These garden, or cultivated, varieties, as will hereafter appear, are very numerous; but the following selection of sorts, which are handsome-growing trees, or have fruit of a particular character, has been made for us by Mr. Thompson, of the Horticultural Society's Garden, from the collection under his care:—

The Red Astrachan. The tree is middle-sized, with a branchy head; the fruit is of a bright red, with a fine bloom like that of a plum. This is one form of the sort which De Candolle has designated as *P. astracánica*: our No. 17.

The White Astrachan, or transparent Crab of Moscow. The tree resembles the preceding sort, but has the branches tending upwards when young, and afterwards becoming pendulous. The fruit is of a wax colour, with a fine bloom on it, and is almost transparent. This is another form of *P. (M.) astracánica*. It is known in English nurseries under the name of the transparent crab.

The Black Crab is a tree of the middle size, with very dark small fruit, of no value as such.

The Court pendu plat is a remarkably dwarf-growing tree, and so late in flowering, that the leaves are expanded before, or at the same time as, the flowers; and, consequently, the latter are seldom, if ever, injured by frost: for which reason, it is commonly called by gardeners the wise apple. Grafted on the French paradise stock, the tree may be kept of a size not larger than that of a gooseberry bush; in which state it will bear fruit in abundance and of good flavour.

The Lincolnshire Holland Pippin is remarkable for the large size of its blossoms. Its fruit keeps till February.

The Tulip Apple is a great bearer of fruit, which is of a very bright red.

The Violet Apple has fruit of a violet colour, covered with a bloom like that of the plum.

The Cherry Crab is a subvariety of *P. (M.) baccàta*. The tree is spreading, with drooping branches; and the fruit is numerous, and about the size and colour of a large cherry.

The Supreme Crab has fruit rather larger than the preceding sort. The tree is of robust growth, and the branches are somewhat erect.

Bigg's Everlasting Crab was raised in the Cambridge Botanic Garden, by Mr. Biggs, the curator, from seeds received from Siberia in 1814. It is a vigorous-growing tree, with pendulous branches and abundance of fruit, which, in form and character, are intermediate between *P. (M.) prunifolia* and *P. (M.) baccàta*, and which remain on the trees long after Christmas. In sheltered situations, and mild winters, this tree appears almost a sub-evergreen.

General Description. The apple tree, whether in a wild state or cultivated, is by no means so handsome in form as the pear tree, though its blossoms are

much more ornamental, and are, besides, fragrant. It seldom grows above half the height of the pear tree; the oldest apple trees known in Europe not being above 30 ft. or 35 ft. in height. The trunk is generally crooked, and the branches rambling horizontally when young, and when old becoming pendulous. The diameter of the head is also often greater than the height of the tree. The apple tree is much more liable to the canker, and other diseases, than the pear tree. Numerous as are the varieties of both apples and pears, the species to which these varieties belong may always be known in a moment, by inspecting the leaves. Those of the apple are more shortly mucronate, less evidently serrated, and somewhat more hairy underneath, than those of the pear. The leaves of the pear are elliptical, smooth, and shining above, and serrated, but not mucronate. The blossoms of the apple are tinged with red, and are fragrant; while those of the pear are of a pure white, and scentless. The fruit of the two trees is not less different than the leaves and the flowers. The apple is hollowed at the insertion of the peduncle, depressed at top, of a softer texture than the pear, and less astringent, but more acid. The apple has woody threads passing through it to the peduncle, ten of which are regularly disposed round the capsules, tending towards the calyx; and it is said that the fruit rots when these are broken. The pear also has these threads; but in that fruit they are not so distinct, on account of the gritty matter which prevails in many of the sorts, and especially in wild pears. "The cells are differently shaped in the two fruits: in the apple they are narrow, and pointed at both ends; in the pear they are obovate, broad exteriorly, and drawing to a point at the end next the centre of the fruit. The pear, however it may vary in shape, size, colour, taste, &c., by cultivation, is generally convex, and lengthened out at the base; whereas the apple is always concave there. Besides this, the leaves of the apple are commonly wider in proportion to their length, of a yellower green above, and whitish underneath; whereas in the pear they are dark green above, and quite smooth on both sides. Their vascular system is very different, being loose in the apple, and very close in the pear: hence the leaves of the latter are much stouter, and more permanent, than those of the former. Lastly, the growth of these trees is quite different; the pear being lofty and upright, the apple low and spreading." (*Martyn's Miller.*)

Geography. The apple grows spontaneously in every part of Europe, except the torrid zone. It is found throughout Western Asia, China, and Japan; but not in North America, unless we consider *P. coronaria* as a variety of *P. Malus*. In the north of Europe, it is found as far as West Finland, in lat. 62°; in Sweden, in lat. 58° or 59°; and in Central Russia, to 55° or 60°. The crab of Europe is wanting in Siberia, but there the Siberian forms of the species are, as Pallas assures us, found widely distributed over the country. The apple is stated, by Royle, to be cultivated in the southern parts of India, and also in the Himalayas, and in China and Japan; but it is not indigenous to the warmer parts of these countries. As an instance of the difficulties attendant on the introduction of European plants into the north of India, Mr. Royle mentions that "an apple tree from Liverpool, in consequence of being the only one which survived, cost upwards of 70*l.* before it was planted in the nursery at Mossuree." (*Illustr.*, p. 206.) In Britain, the apple is found in a wild state, in hedges, and on the margins of woods, as far north as Morayshire, and as high as the agricultural zone. In the Highlands of Scotland, the apple tree is the badge of the clan Lamont. It is found wild in Ireland, but it is rare there. Wherever the apple occurs in a truly wild state, the tree is, when young, generally more or less furnished with thorns; but these disappear as it advances in age; and, in fertile soils, the crab, like the common hawthorn in a wild state, may even be found altogether thornless. The crab never grows wild except on tolerably good soils, for which reason it is never found associated with the wild pear.

History. The apple tree is mentioned by Theophrastus, Herodotus, and in sacred history. Pliny informs us that the Greeks called the apple *Medica*,

from Media, the country from which apple trees were first brought into Greece; but Seckler thinks that the term Media was more probably applied by the Greeks to the peach, which is indigenous in Media. Pliny not only mentions apples of different kinds, but also crabs and wildings, which are small and sour and, for that reason, "have many a foul word and shrewd curse given them." The apple was extensively cultivated in the neighbourhood of Rome; and many of the sorts took their names from the first grafters. It must be confessed, however, that Pliny has stated so many particulars as facts, respecting the apple (such as turning the fruit red, by grafting it on the mulberry, &c.), which are well known to be physiologically impossible, that very little confidence is to be placed in statements by him of any kind. The apple was, in all probability, introduced into Britain by the Romans, as well as the pear; and, like that fruit, perhaps reintroduced by the heads of religious houses on their establishment, after the introduction of Christianity. According to Fuller, pippins were first introduced into England in the time of Henry VIII.; and they were planted at Plumstead in Sussex; but it is altogether unreasonable to suppose that there were not abundance of apple trees in the country long before that time. The golden pippin is said to have been originated at Parham Park in Sussex, as the Ribstone pippin was at Ribstone Park in Yorkshire. The best apples, in Gerard's time, were the queening, pearmain, the paradise, and some other kinds, amounting in all to seven; but, he says, there are a great many others; adding, that Kent "doth abound with apples of most sorts." He afterwards mentions that he has "seen in the pastures and hedgerows about the grounds of a worshipful gentleman's dwelling, two miles from Hereford, called Master Roger Bodnome, so many trees of all sorts, that the servants drink, for the most part, no other drinke but that which is made of apples." (*Herbal*, p. 1459.) Herefordshire appears to have been noted for its trees and its cider from a very early period; and some of the oldest apple trees in existence are believed to be in England, and in that county. Parkinson describes 57 varieties of apples; and the number seems to have been constantly increasing to the present time. A great many excellent sorts have been raised by T. A. Knight, Esq., P.H.S.; and many, also, on the continent of Europe and in North America; the whole of which have been collected in the garden of the London Horticultural Society, where there are now (1836) upwards of 1400 distinct sorts, exclusive of synonymes, to which number additional sorts are being added every year; and their comparative merits estimated.

Properties and Uses. The wood of the apple, in a wild state, is fine-grained, hard, and of a brownish colour; and that of the cultivated apple is said to be of a still finer and closer grain, which is a result of cultivation contrary to what is usual. The weight of the wood of the apple tree varies much according to the locality in which it is grown. In a green state, it weighs from 48 lb. to 66 lb. per cubic foot; and it loses from an eighth to a twelfth of its bulk in drying, and about a tenth of its weight. The wood of the cultivated tree weighs heavier than that of the wild tree, in the proportion of about 66 to 45. These particulars will be found given more in detail in the *Dictionnaire des Eaux et des Forêts*; in which it is also stated, that the wood of the pear is incomparably superior in every respect to that of the apple. In Britain, apple tree wood was formerly a good deal used in turnery, and as cogs for wheels, for which latter purpose it was found very durable. The tree, as an object in landscape scenery, cannot be recommended as harmonising well with other forms; but, as it has a character of its own, and as the fruit is of the greatest use to the poor, as well as to the rich, it deserves introduction into every hedgerow, and every orchard. For hedgerows, it is more especially desirable, as though, not so fastigiate as the pear, it does very little injury to the crops by its shade; and it may be added, that, in nurseries and market-gardens, the former more especially, young trees of almost every kind thrive under the shade both of the apple and the pear. This is strikingly exemplified in the Goldworth and Knaphill Nurseries, in Surrey, where

certain evergreens, such as the balm of Gilead and several other firs, the points of the leading shoots of which are liable to be destroyed by the frosts of April and May, are always sown under old apple and pear trees. The crab is used as a stock for the cultivated apple, and for all the other species and varieties of this division of the genus; but, as we have before observed, it will not serve as a stock for the pear, or any of the plants included in that, or the other divisions of *Pyrus*. In France, and also in some parts of Germany, the thorny wild apple, or crab, is formed into live hedges, the branches of which, according to Agricola, are inarched into each other, in order to give them more strength to resist cattle. The fruit of the crab, in the forests of France, is a great resource for the wild boar; and it is also given in that country to swine and cows. A drink of it, called *boisson*, is made in some parts of France, as well as in England; and verjuice is a well-known description of vinegar, produced from the most austere of the fruit. The bark affords a yellow dye; and the leaves are eaten by horses, cows, sheep, and goats. Pomatum, according to Gerard, was so called from its being anciently made of the pulp of apples beaten up with "swine's grease" (lard) and rose-water.

The uses of the apple as an eatable fruit are very numerous. Apples are equally good for the kitchen and the dessert; and they are not only used in various dishes by themselves, but enter into numerous combinations with other fruits. In confectionery, apple jelly forms a most beautiful medium for preserving Siberian crabs, and many other kinds of fruit; and dried apples (*beaufins*) are prepared in great numbers in Norfolk, by drying them slowly in bakers' ovens after the bread has been drawn, and occasionally taking them out and pressing them with the hand to flatten them, till they are perfectly soft, and of a rich deep brown, when they are considered fit for the London market. Medicinally, apples are reckoned particularly cooling, and excellent in all inflammatory disorders; and apple-water is a most refreshing drink in fevers. In France, a kind of jam, or rob, called *raisiné*, (see p. 898.) is prepared by boiling apples in new wine. A kind of wine is also made from apples, with water and sugar, in the same manner as other fruit wines are made in Britain. Apple wine, however, as Phillips observes, is by no means equal to the cider made from golden pippins, from which a spirit is extracted equal to brandy for preserving fruit, or mixing in made wines or liquors. (*Pom. Brit.*, p. 55.) A liquor is made by distillation from eider, in North America, which is called eider brandy; and a very strong spirit is obtained by allowing the eider to freeze, and then drawing off the part that remains in a fluid state, and which, of course, contains all the alcohol. The Americans also make a liquor, which they call *pomona wine*, by adding 1 gallon of brandy to 6 of new eider after it is racked off. "This, when 8 or 12 months' old, is a very good substitute for wine." (*Encyc. Amer.*, vol. i. p. 308.)

Cider. The most celebrated counties in England for making eider are, Herefordshire, Worcestershire, and Devonshire; and the eider of the two former counties is esteemed much the best. Worcestershire, we are told by Dr. Nash, as quoted in Pitt's *Survey of Worcestershire*, p. 149., was famous for its fruit trees even in the time of Henry III.; but Herefordshire, though it contains many very old apple and pear trees, and has some very old eider orchards planted in the reign of Henry VIII., was not generally considered as a fruit country till the time of Charles I., in the first part of whose reign "orcharding," as it was called, became general throughout the county. (*Herefordshire Report*, p. 79.) At this period, Evelyn tells us, "by the noble exertions of Lord Scudamore, of Hom-Lacey," and other gentlemen, Herefordshire became, in a manner, "one entire orchard." (*Pomona*, fol. London, 1679.) It is a remarkable feature in the Herefordshire and Worcestershire apple orchards, that the ground is always cropped under the trees; it being a maxim, in the former county, that an "orchard is generally raised with most success, and at least expense, in a hop yard; the ground under this culture being always well tilled and manured, as well as fenced against every kind of enemy." (*Herefordshire Report*, p. 83.)

Directions for making Cider. The colours of good cider fruits are red and yellow; and the colour to be avoided is green, as affording a liquor of the harshest, and generally of the poorest, quality. The pulp should be yellow, and the taste rich, and somewhat astringent. "Apples of a small size are always, if equal in quality, to be preferred to those of a larger size, in order that the rind and kernel may bear the greatest proportion to the pulp, which affords the weakest and most watery juice." (*Heref. Rep.*, p. 84.) To prove this, Dr. Symonds of Hereford, about the year 1800, made one hogshead of cider entirely from the rinds and cores of apples, and another from the pulp only, when the first was found of extraordinary strength and flavour; while the latter was sweet and insipid. (*Ibid.*)

In *Herefordshire* and *Worcestershire* the fruit is suffered to hang on the tree till it is ripe enough to fall of itself. When gathered, it is laid in heaps on the ground in the open air, fully exposed to the weather; unless a frost comes on, when the fruit should be carefully covered with straw. Each sort should be kept separate; or, if this cannot be done, the sorts ripe at the same time should be ground together. The object of this is, that the fruit may be reduced in the mill into a homogeneous mass; and this can only be done by choosing fruit of the same kind, or, at least, of the same degree of ripeness, to be put into the mill at the same time. When ground, the fruit should be mixed; as ciders made from mixed fruit are always considered the best. The cider-mill (see *Encyc. of Cot. Arch.*, fig. 1181.) consists of a circular stone, in the form of a solid broad wheel, about $3\frac{1}{2}$ feet in diameter and one foot wide, which is drawn, by a horse, in a circular trough of stone about 10 ft. in diameter and 8 in. deep. In this trough the apples are placed (great care having been taken, first, to pick out all that appear to be what is called black rotten); and the grinding proceeds slowly, a free access of air being allowed to the fruit till it is reduced to a homogeneous mass, in which the rinds and kernels are scarcely distinguishable from the pulp. The mass is then suffered to remain 24 hours in an open tub, fully exposed to the air; and it is afterwards put into hair cloths, and pressed; the juice being deposited in casks, which are not quite filled, and which are left in the open air. If left to itself, the cider would be subjected to three fermentations: 1st. the vinous, which is necessary to give it strength; 2dly, the acetous, which, if suffered to continue, would soon change it into vinegar; and, 3dly, the putrefactive, by which it would become insipid, and totally unfit for use. The cider-maker should watch the height of the first fermentation, which is indicated by some of the impurities contained in the liquor rising to the top. The cider should then be racked off, and the lees filtered through linen bags. The goodness of the cider depends in a great measure on this operation; and, if it be well timed, and well executed, the liquor will be perfectly clear and bright. The casks should still want 4 or 5 gallons of being full, and should stand in this state, exposed to the open air, a bung being lightly put over the hole, till the end of March, when the liquor should be racked off into clean casks, which should be completely filled, and the bung firmly fixed. The usual produce of an apple tree is from one to two hogsheads of fruit, which will, under the most favourable circumstances, yield one hogshead of cider; but, more commonly, it requires three trees to produce two hogsheads. Some of the drier kinds of apples, such as the Hagloe crab and the Stire apple (both celebrated as cider apples), will, in dry seasons, only yield a hogshead of cider from three hogsheads of fruit, or the produce of three trees. The best time for bottling cider is when it is two years old; and, if well made, and of sound quality, the Herefordshire and Worcestershire cider will keep 20 or 30 years. (For a more detailed account of the method of making cider in Herefordshire and Worcestershire, see *Encyclopædia of Cottage Architecture*, *Herefordshire Report*, and *Pott's Survey of Worcestershire*; and for figures of the mill, press, and other utensils necessary, see *Encyclopædia of Cottage Architecture*.)

In *Devonshire*, rollers are employed instead of mills; and the apples are only broken, or crushed, instead of being reduced to a homogeneous mass; and

the juice is strained through reed or straw mats, instead of hair cloths. Neither the apples, nor the pulp, are exposed to the open air; and, if any rain falls on the fruit while it is being gathered, it is considered unfit for use. The cider of Devonshire is sweet, but weak, and will not keep good many years. Another point of difference is, a clause generally inserted in the leases in Devonshire, that no crops shall be grown under the trees in the apple orchards. The liquor is not racked off so soon as in Herefordshire; and, should the acetous fermentation have been allowed to come on, it is stopped, by adding a bottle of French brandy, half a gallon of cider brandy, or a pailful of sound old cider, and exposing the cask to a cooler air. (See *Encyclopædia of Agriculture*, 2d edit., p. 4131.)

In Ireland, a mixture of every sort of apple, wild as well as cultivated, is thought to make the best cider. "Owing to a considerable admixture of crabs, the Irish cider is always more sour than the English; and this is a quality, when not too predominant, for which it is valued by the natives. (*Lardner's Cyclopædia*, Treatise on Domestic Economy.)

In Scotland, cider has not hitherto been made; but, as the climate, especially in all the low lands of the country, is drier and warmer than that of Ireland, and is consequently better adapted for ripening fruit, if apple trees were introduced into the hedgerows, in some places; and, where this could not be done, if large orchards were planted adjoining the farm-houses, cider might be as common a beverage there as in England.

In Normandy, cider was made before it was in England; and the art of making it is said to have been brought into that country from Spain; where, however, it is no longer practised. The Norman mode of making cider closely resembles that generally practised in Devonshire. The Normans gather their apples in dry weather, and keep them closely shut up in rooms, till ready for the press, in which they are crushed, or broken; and the juice is strained through a reed or bast mat. The Normans prefer sweet apples, or sweet and bitter apples mixed. The cider is sweet, like that of Devonshire; but, though heady, it has not much body. The strongest rarely keeps more than five or six years, and the inferior sorts are best drunk from the cask when quite new. Normandy is the only part of the Continent where cider is a staple article of commerce.

In America, cider is almost a universal beverage in New England, and in the middle, and some of the western states. The fruit is suffered to remain on the tree till it is thoroughly ripe, and it is then gathered by hand; or, if the trees are shaken, great care is taken to cover the ground with coarse cloths or Russian mats, to prevent the apples from being bruised. When gathered, the apples are laid in heaps in a room, and kept carefully from the rain or dew. In grinding, care is taken to reduce "the whole fruit, skin and seeds, to fine pulp, and to perform the operation in cool weather. The late Joseph Cooper of New Jersey has observed emphatically, that 'the longer a cheese [that is, the mass of apple pulp] lies after being ground, before pressing, the better for the cider, provided it escapes fermentation until the pressing is completed.'" (*Kenrick's American Orchardist*, p. 121.) In some cases, the pomace, or mass of pulp, is suffered to remain a week or ten days after it is ground, before it is submitted to the press (provided the weather be not too warm), stirring the mass every day. (*Ibid.*)

Mode of preparing the Sweetmeat known in France by the Name of Raisiné composé. This is a very favourite sweetmeat with the Parisians; and it is made by boiling any given quantity of must, or new wine, till it is diminished one half, skimming it continually as fresh scum arises, and afterwards straining the liquor: then take apples, pared and cut into quarters, and, putting them into the raisiné, let it simmer gently, stirring it continually with a long wooden spoon, till the apples become thoroughly amalgamated with the liquor, and the whole forms a species of marmalade, which is extremely agreeable to the taste. When prepared in the northern provinces, the raisiné, after the first boiling, skimming, and straining, should be set for 24 hours in a cool place, when a saline

liquor, like a scum, will appear on the surface: this must be removed, and the liquor strained, before it is mixed with apples, as before. This scum is the tartaric acid, which would spoil the raisiné, and prevent it from keeping, but which is not perceivable when the grapes have ripened in a southern climate. The raisiné, when properly prepared, is sweet, but with a slight flavour of acidity, like lemon mixed with honey. The best raisiné is that of Burgundy. In Normandy a similar marmalade is composed of cider and pears; but it is not so good as the other kind, being apt to ferment. In some cases, the pears are put into an earthen vessel without water, and placed in a baker's oven after the bread has been drawn, previously to mixing with the cider. The best raisiné is considered very wholesome, particularly for children, who eat it spread on bread, and for persons in delicate health, whose stomachs will not bear butter, and is in France what marmalade is in Britain, and more especially in Scotland. Raisiné is abundant and cheap in Paris; where, however, a composition is often substituted for it, made of honey and water, instead of wine; an imposition which may be detected by putting the raisiné in water, with which it will not unite if pure. In Italy, the raisiné is eaten with preparations either of Indian corn, or of maccheroni, to give a flavour to these dishes. (*Nouveau Cours Complet d'Agriculture*, tome xiii. p. 44.)

Poetical and legendary Allusions. The apple tree was formerly supposed to be the tree of knowledge, the fruit of which was eaten by Eve in Paradise; and it is a curious fact, that the apple tree is also distinguished by legends in the mythologies of the Greeks, the Scandinavians, and the Druids. The pagans believed that the golden fruit of the Hesperides, which it was one of the labours of Hercules to procure, in spite of the fierce dragon that guarded them and never slept, were apples; though modern writers have supposed them oranges. (See *Encyc. of Gard.*, edit. 1835, p. 4. and p. 5.) In the *Edda*, we are told that the goddess Iduna had the care of apples which had the power of conferring immortality; and which were, consequently, reserved for the gods, who ate of them when they began to feel themselves growing old. The evil spirit Loke took away Iduna and her apple tree, and hid them in a forest, where they could not be found by the gods. In consequence of this malicious theft, every thing went wrong in the world. The gods became old and infirm; and, enfeebled both in body and mind, no longer paid the same attention to the affairs of the earth; and men, having no one to look after them, fell into evil courses, and became the prey of the evil spirit. At length, the gods finding matters get worse and worse every day, roused their last remains of vigour, and, combining together, forced Loke to restore the tree. The druids paid particular reverence to the apple tree, because the mistletoe was supposed to grow only on it and the oak; and also on account of the great usefulness of the fruit. In consequence of this feeling, the apple was cultivated in Britain from the earliest ages of which we have any record; and Glastonbury was called the apple orchard, from the great quantity of apples grown there previously to the arrival of the Romans. (See p. 22.)

Hercules was worshipped by the Thebans, under the name of Melius; and apples were offered at his altars. The origin of this custom was the circumstance of the river Asopos having, on one occasion, overflowed its banks to such an extent as to render it impossible to bring a sheep across it which was to be sacrificed to Hercules; when some youths, recollecting that an apple bore the same name as a sheep in Greek (*mélon*), offered an apple, with four little sticks stuck in it, to resemble legs, as a substitute for the sheep; and, after that period, the pagans always considered the apple as especially devoted to Hercules. (See *Reid's Hist. and Lit. Bot.*, vol. i. p. 103.) In Britain, as we have already stated, the apple tree has been held in respect ever since the time of the druids. The ancient Welsh bards were rewarded for excelling in song by "the token of the apple spray;" and Gwaichmal thus sings:—"The point of the apple tree, supporting blossoms, proud covering of the woods, declares every one's desire tends to the place of his affections." (*Davies's Welsh Bards.*) "On Christmas Eve, the farmers and their men, in Devonshire, take a large

bowl of cider, with a toast in it; and, carrying it in state to the orchard, they salute the apple trees with much ceremony, in order to make them bear well the next season. This salutation consists in throwing some of the cider about the roots of the tree, placing bits of the toast on the branches; and then, forming themselves into a ring, they, like the bards of old, set up their voices, and sing a song, which may be found in Brand's *Popular Antiquities*." (*Mrs. Bray's Borders of the Tamer and the Tovy*, vol. i. p. 335.) In Hone's *Every Day Book*, this custom is mentioned, but with some slight variation. It is there stated, that the farmer and his men, after making their oblation of cider, encircle one of the best bearing trees in the orchard, and repeat three times the song, which is as follows:—

"Here's to thee, old apple tree,
Whence thou mayst bud, and whence thou mayst blow;
And whence thou mayst bear apples snow.
Hats full! caps full!
Bushel—bushel—sacks full!
And my pockets full too!
Huzza!!"

This is sometimes done on the Twelfth Night Eve, as well as on Christmas Eve; and, at the former-mentioned festival, when the song is finished, the whole party return to the house, the doors of which they find bolted against them by the females, who were left at home, and who refuse to open the door till some one of the party "has guessed what is on the spit, which is generally some nice little thing, difficult to be hit on, and is the reward of him who first names it." (*Every Day Book*, vol. i. p. 42.) In Brand's *Popular Antiquities*, the following is stated as another mode of performing this charm:—The farmer and his workmen go out into the orchard, after supper, on the eve of Twelfth Night, with a large milk-pan full of cider, having roasted apples pressed into it. "Out of this, each person in company takes what is called 'a clayen cup,' that is, an earthen cup full of liquor; and, standing under each of the most fruitful of the apple trees, and passing by those that are not good bearers, he addresses it in the following words:—

"Heath to thee, good apple tree,
Well to bear, pocketfuls, hatfuls,
Peckfuls, bushelbagfuls!"

And then, drinking part of the contents, he throws the rest, with the fragments of the roasted apples, at the tree. At each cup the company set up a shout." In Herefordshire, Brand tells us that, "at the approach of evening, on the vigil of the Twelfth Day, the farmers, with their friends and servants, meet together, and about 6 o'clock walk out to a field where wheat is growing. On the highest part of the ground, 12 small fires, and one large one, are lighted up. The attendants, headed by the master of the family, pledge the company in old cider, which circulates freely on these occasions. A circle is formed round the large fire, when a general shout and hallooing takes place, which you hear answered from all the adjacent villages and fields. Sometimes 50 or 60 of these fires may be all seen at once. This being finished, the company return home, where the good housewife and her maids are preparing a good supper. A large cake is always provided, with a hole in the middle. After supper, the company all attend the bailiff (or head of the oxen) to the wainhouse, where the following particulars are observed:—The master, at the head of his friends, fills the cup (generally of strong ale), and stands opposite the first or finest of the oxen. He then pledges him in a curious toast: the company follow his example with all the other oxen, addressing each by his name. This being finished, the large cake is produced, and, with much ceremony, put on the horn of the first ox, through the hole above mentioned. The ox is then tickled to make him toss his head. If he throw the cake behind, then it is the mistress's perquisite; if before (in what is termed the boosy), the bailiff himself claims the prize. The company then return to the house, the doors of which they find locked; nor will they be opened till some joyous songs are sung. On their gaining admittance, a scene of mirth and jollity ensues, and which lasts the greatest part of the night." Pennant, in his

Tour in Scotland, speaking incidentally of the English customs respecting cider, among others, which, he says, they derived from the Danes, mentions that, in some parts of the country, the servants, after the gathering of the apple harvests, anciently feasted on cakes made with caraway and other seeds in them, and soaked with cider. The wassail bowl, drunk on All-Hallow E'en, Twelfth Day Eve, Christmas Eve, and on other festivals with the church, was compounded of ale, sugar, nutmeg, and roasted apples, which every person partook of; each taking out an apple with the spoon, and then drinking out of the bowl. Sometimes the roasted apples were bruised and mixed with milk, or white wine, instead of ale; and, in some parts of the country, apples were roasted on a string, till they dropped off into a bowl of spiced ale beneath, which was called lamb's wool. The reason of this name, which is common to all the compounds of apples and ale, being given to the wassail bowl, is differently explained by different writers. Brand attributes it to the softness given to the liquor by the apples and the sugar; but Vallancey says it arose from the lamb's wool being drunk on the 31st of October, All-Hallow E'en; "the first day of November, being dedicated to the angel presiding over fruit, seeds, &c., and, therefore, named La Mas Ubhal, that is, the day of the apple fruit; and this, being pronounced lamosool, soon became corrupted by the English into lamb's wool. Shakspeare alludes to the custom of putting roasted apples in ale, in the *Midsommer Night's Dream*. When Puck is describing his feats, he says, —

"Sometimes I lurk in a gossip's bowl,
In very likeness of a roasted crab;
And, when she drinks, against her lips I bob,
And on her wither'd dewlap pour the ale."

(See *Every Day Book*, and the *Gentleman's Magazine* for 1789.) Apples were blessed by the priests on July 25.; and an especial form for this purpose is preserved in the manual of the church of Sarum. The custom of bobbing for apples on All-Hallow E'en, and on All Saints' Day, which was formerly common all over England, and is still practised in some parts of Ireland, has lately been rendered familiar to the public by M'Clise's masterly painting of the Sports of All-Hallow E'en. A kind of hanging beam, which was continually turning, was suspended from the roof of the room, and an apple placed at one end, and a lighted candle at the other. The parties having their hands tied behind them, and being to catch the apples with their mouths, of course frequently caught the candle instead. In Warwickshire, apples are tied to a string, and caught at in the same manner, but the lighted candle is omitted; and, in the same county, children roast apples on a string on Christmas Eve; the first that can snatch an apple, when it drops from the string, getting it. In Scotland, apples are put into a tub of water, and bobbed for with the mouth. Apples are used as part of the ingredients of mince pies, which, in some parts of the country, would be thought to lose their power of "producing a happy month for every one tasted in the 12 days of Christmas;" if this fruit were omitted. The custom of gipping, which may be called apple gleaning, is, or was formerly, practised in Herefordshire. It consists in leaving a few apples, which are called the gipples, on every tree, after the general gathering, for the boys, who go with climbing-poles and bags to collect them. The principal poets who have sung the apple are Phillips and Thomson. The former, in his poem entitled *Cider*, particularly mentions, —

"The pippin, burnish'd o'er with gold, the moyle
Of sweetest honied taste; the fair pearmain,
Temper'd, like comeliest nymph, with white and red."

And also his favourite, the redstreak, of which he sings, —

"Let every tree in every garden own
The red-streak as supreme, whose pulpos fruit
With gold irradiate, and vermilion shines.
Hail Herefordian plant! that dost disdain
All other fields."

Thomson, in his *Seasons*, speaking of the apple-gathering, says, —

“The fragrant stores, the wide projected heaps
Of apples, which the lusty-handed Year,
Innumerable o'er the blushing orchard shakes :
A various spirit, fresh, delicious, keen,
Dwells in their gelid pores ; and, active, points
The piercing cider for the thirsty tongue.”

Soil and Situation. The apple, as a fruit tree, will do no good except in a fertile soil, and a sheltered situation. All the best apple orchards of England, and more especially those of the cider districts, it has been observed by geologists, follow the track of red sandstone, which stretches across the island from Dorsetshire to Yorkshire. It has been observed in Ireland (see *Dublin Soc. Trans.*), that the best orchards there are on limestone gravel; and, in Scotland, that the few orchards which are to be found in that country are on soils more or less calcareous. On the Continent, the two districts most famous for apple trees are Normandy and the Vale of Stuttgard; and the subsoil, in both countries, is well known to be limestone. In short, every kind of fruit, to be brought to perfection, requires a soil more or less calcareous. In general, the observations made with reference to the pear tree will apply in the case of the apple tree; but the latter tree is more injurious to hedges, from its low spreading head; and less favourable to culinary crops in gardens, and to pasture in orchards, for the same reason; and the fruit, being larger, is more liable to be blown down by high winds.

The Propagation and Culture of the apple are the same as those of the pear tree. Wild crabs, like wild pears, are gathered when they are fully ripe, and either laid in a heap to rot, or passed between fluted rollers, and the crushed fruit pressed for the juice, which is made into an inferior kind of cider or perry, and the seeds are afterwards separated from the pomace by maceration in water and sifting. This is the mode practised in the Goldworth Nursery, where fruit tree stocks are raised on a more extensive scale than any where else in Britain. Where seedlings are to be raised from cultivated apples, pears, or other fruits, application is made to the manufacturers of cider or perry, or to the confectioners; and from these persons seeds of the different kinds of garden fruits are obtained. The mode of sowing these has nothing specific, and will be found detailed under the proper head (*Nursery Culture*) in Part VI. of this work. The apple, like the pear, may be grafted on the common thorn; but it does not form nearly so desirable a tree on that stock as the pear does, and, therefore, crab stocks are always to be preferred. As a fruit tree, where it is intended to be grown as a dwarf, the paradise stock effects for it what the quince does for the pear, and the *Cerasus Mahaleb* for the cherry. (See *Encyc. of Gard.*, edit. 1835.)

Accidents, Diseases, and Insects. The apple tree is more liable to the attacks of insects, and to diseases, than the pear tree. It is subject to canker; more especially when planted deep, or in soil which is annually dug round it to some depth, and cropped with vegetables. In some soils, also, especially those which contain much oxide of iron, the tree is liable to canker under any mode of culture; and the remedy, or palliative, in such soils, is, liming abundantly, to neutralise the oxide; planting on the surface, and not digging the ground, but only hoeing it, or keeping it entirely in pasture. The leaves, flowers, and fruit of the apple tree are liable to the attacks of many insects, against which there are few or no remedies; but, at all events, this branch of culture belongs more to horticulture than to arboriculture. The American blight, or woolly aphis, is one of the most common enemies of apple trees; and to destroy it the most simple modes appear to be, to brush it off with a mixture of salt and water, or with soot and salt, or alkali, or soap and water. It will, however, be treated on more in detail hereafter. In the spring, the caterpillars of different moths and sawflies attack the leaves and flowers (see *Gard. Mag.*, vol. ix. p. 341.); and, in orchards, it is sometimes found worth while to produce a dense smoke among the trees, by burning moist straw or weeds under them; the pyroligneous acid of the smoke poisoning

the insects. The trunk and branches are liable, in some soils, and in moist situations, to be infested with lichens and moss, which must be scraped off; and in others the mistletoe is apt to take root, which ought to be cut out.

The American Bug, American Blight, Cotton Insect, or Woolly Aphis (*A'phis lanígera* L., *Eriosòma mali* Leach), is one of the most common enemies of the apple tree, particularly in England. How it came to be named American blight is uncertain; the insect being found, in Britain, on crab trees, in plantations; and, consequently, being, in all probability, indigenous. Insects of the allied genera *A'phis* and *Eriosòma* attack various shrubs, and have been found on the leaves and roots of herbaceous plants. The *A'phis lanígera*, when closely examined, resembles the kind of aphid, or plant-louse, which infests the rose, and other shrubs and plants; but, unlike the common plant-lice, it is clothed, or muffled up with a substance resembling cotton wool, in such quantities, that no one, who was not aware of the fact, would suppose it contained an insect. In very hot weather, portions of this woolly matter separate from the mass, and float about in the air; and are driven along by the wind, till they are caught by the branch of some other tree; and in this manner the insect is propagated. The following observations by a writer in the *Entomological Magazine*, under the signature of Rusticus, quoted in the *Gardener's Magazine*, vol. ix. p. 335., describe the mode of propagation of this insect, and give, also, a method of destroying it:—"These blights wander wherever it pleases the wind to carry them; and, if bad luck should drive one of them against the branch of an apple tree, there it will stick, creep into a crack in the bark, bring forth its young, and found a colony: the white cotton soon appears in large bunches; branch after branch becomes infested; the tree grows cankered, pines, and dies. How this is effected no one knows, though the cause and effect are too evident to escape the notice of the commonest clown. In large orchards, it is vain to hope for a cure; but not so in gardens. Directly you see the least morsel of cotton, make up your mind to a little trouble, and you will get rid of it. In the first place, get a plasterer's whitewashing brush; then get a large pot of double size; make your man heat it, till it is quite liquid; then go with him into the garden, and see that he paints over every patch of white, though not bigger than a sixpence; the next morning have the size-pot heated again, and have another hunt; and keep on doing so every morning for a fortnight. Your man will tell you it's no use: tell him that 's your business, not his. Your neighbours will laugh at you for your pains: do it before they are up. I have tried it, and know it to be effectual. Spirit of tar has been used with partial effect; so, also, has resin. Whitewashing has been often tried, and, as it contains some size, is not entirely useless; and some horticulturists think it ornamental: I do not."

Other Remedies for the Woolly Aphis. This insect, a writer in the *Gardener's Magazine*, residing in Cornwall, observes, appears to be spreading continually into new districts, even where no new trees have been planted, more especially in the bottoms of valleys. The acclivities of hills it ascends very slowly; and orchards in these situations are generally less affected by the insect than such as are in plains. The writer alluded to (Mr. Jonathan Couch, a scientific naturalist) recommends diluted sulphuric acid as the agent of destruction. This is formed, he says, by "mixing slowly three quarters of an ounce of sulphuric acid with $7\frac{1}{2}$ oz. of water. In laying it on, care should be taken not to let it touch the clothes of the operator, in which it will make holes. It should be applied all over the bark by means of rags, the only parts exempted being the present year's shoots, which it would destroy. It clears the tree of moss and lichens, as well as insects; and, if applied in showery weather, will be washed into every crevice in which they can harbour. The insects which are touched with it immediately die; and those that have not been touched with it very soon cease to yield so large a secretion of cotton; by which means, if it be true that the young ones are conveyed by the winds, wrapped up in this mantle, their propagation must be curtailed. After the application of the acid, when the weather has been fair, I have seen them in

crevices, still busily at work ; but, on the occurrence of a rainy day, which, I suppose, has inundated them with the poisonous fluid, they have been found all dead. I have seen a small tree, that before seemed to languish, thrive remarkably in the second season following the application of the acid ; a proof, at least, that it is not injurious to vegetation. This fluid has the recommendation of being devoid of the offensive odour of some others that have been used for the purpose ; and, so far from being unsightly, as lime is, no one could discern that an application of it had been made.' (*G. M.*, vol. ix. p. 337.)

The following composition has been found effectually to destroy the woolly aphid on apple trees in Kent. Take two quarts of vegetable tar, half an ounce of corrosive sublimate, half an ounce of spirit of salt, and one gill of spirit of hartshorn. The sublimate must be pounded in a marble mortar, adding the spirit of salt by degrees, to dissolve the mercury ; next add the hartshorn, rubbing all together until completely mixed. Provide an earthen glazed pipkin, and put in the poisonous liquid ; add the tar by degrees, constantly stirring it to prevent its running over. Then take an old painter's brush, and cover all the diseased parts with the mixture ; which will adhere, and give way to nothing but the growing wood and bark. It is necessary to use unglazed earthenware, as the mercury will corrode metal or wood. Wherever this mixture is applied, it will infallibly destroy the aphid, or any other insect, and prevent emigrants from infested trees from lodging on the wounded parts, or feeding on the juices of the young growing bark. Notwithstanding its poisonous quality, no person need be afraid of any mischief to any domestic animal, as the noxious smell and taste of the tar prevents every danger. Before applying the mixture, scrape off, with a blunty instrument, all lichens, and loose or rotten bark, from the stems and branches ; then pare off the edges of the cankered holes, and other excrescences in which it is possible for the aphid, or any other insect, to be lodged ; and, with a woodman's racer, gouge, and chisel, scoop out all the cankered and rotten wood, until the clean live surface, at the bottom of each wounded part, is found. (*Gard. Mag.*, vol. ii. p. 166.) Tar, diluted with a little oil of turpentine, it is said, will have the same effect as the above mixture ; and will not, like it, run the risk of being injurious to vegetation.

The Sublimate of Tar, applied to the part affected with the woolly aphid, by a common painter's brush, is said to be an effectual mode of eradicating the insect. Train oil, applied in a similar manner, with a stiff-haired brush, has also been found effectual. What the hairs of the brush do not stab to death, the oil tends to kill by suffocation, rendering impervious to the admission of air those breathing-holes in the sides of insects by which their respiration is effected. In the same way, spirits of turpentine have been found completely effectual ; and also strong old urine. Oil and soot, well mixed together, form another somewhat similar remedy ; and lime-water, soot and salt, strong tobacco-water, soapsuds, and soft soap, have been recommended for the same purpose. (*Gard. Mag.*, vol. ii. p. 49, 50., and vol. ix. p. 337.) Much of the success attending the use of any composition, must necessarily depend on its being carefully and thoroughly applied, and on the repetition of the process wherever the insects reappear. (*Ibid.*) In some orchards and nurseries, no other application than brushing off the insect with common water, and a stiff painter's brush, is made use of ; and, by persevering in doing this all the summer, whenever the slightest indication of the insect appears, the trees may be kept quite clean.

The Woolly Aphid attacks the Roots of Trees, as well as their trunks and branches ; and it would seem more difficult to destroy them in the former situation than in the latter. Mr. Baron (*Gard. Mag.*, vol. ix. p. 398.), having some currant trees affected at the roots with the woolly aphid, opened the earth round the stem, so as to lay bare the uppermost roots ; washed the stem with strong soapsuds, and filled up the opening round it with the same mixture, stirring it with the broom, so as to form a pool of mud. This effectually destroyed the insect on the roots.

Wormeaten Fruit. Apples often fall off prematurely, from being wormeaten. The cause of this is a beautiful little moth, with wings studded with silvery shining specks, the economy of which has been satisfactorily pointed out by a writer in the *Entomological Magazine*. This insect leaves the chrysalis state about the middle of June, about which time the apples are well set. The moth now lays its eggs in the eye of the apple, one only in each, by introducing its long ovipositor between the leaves of the calyx, which form a tent above it, that effectually shields it from the inclemency of the weather, or any other casualty. "As soon as the egg hatches, the little grub gnaws a hole in the crown of the apple, and soon buries itself in its substance; and it is worthy of remark, that the rind of the apple, as if to afford every facility to the destroyer, is thinner here than in any other part, and, consequently, more easily pierced. The apple most commonly attacked is the codlin, a large early sort, which ripens in July and August.

"The grub, controlled by an unvarying instinct, eats into the apple obliquely downwards, and, by thus avoiding the core and pips, in no way hinders its growth: at first it makes but slow progress, being little bigger than a thread; but, after a fortnight, its size and its operations have much increased. It has now eaten half-way down the apple; and the position of the hole at the top, if the apple continue upright, or nearly so, is inconvenient for a purpose it has up to this time been used for, that is, as a pass to get rid of its little pellets of excrement, which are something like fine sawdust, or coarse sand. Another communication with the outer air is therefore required; and it must be so constructed as to allow the power of gravity to assist in keeping it clear. It is accordingly made directly downwards, towards that part of the apple which is lowest; and thus the trouble of thrusting the pellets upwards through the eye of the apple is saved, and a constant admission given to a supply of air without any labour. The hole now made is not, however, sufficiently open for an observer to gain by its means any knowledge of what is going on within; this is only to be obtained by cutting open a number of the apples, as they gradually advance towards ripeness; the hole is, however, very easily seen, from its always having adhering to it, on the outside, an accumulation of the little grains which have been thrust through. Having completed this work, the grub returns towards the centre of the apple, where he feeds at his ease. When within a few days of being full fed, he, for the first time, enters the core, through a round hole gnawed in the hard horny substance which always separates the pips from the pulp of the fruit; and the destroyer now finds himself in that spacious chamber, which codlins, in particular, always have in their centre. From this time he eats only the pips, never again tasting the more common pulp, which hitherto had satisfied his unsophisticated palate; now nothing less than the highly flavoured aromatic kernels will suit his tooth; and on these, for a few days, he feasts in luxury.

"Somehow or other, the pips of an apple are connected with its growth, as the heart of an animal with its life: injure the heart, an animal dies; injure the pips, an apple falls. Whether the fall of his house gives the tenant warning to quit, I cannot say, but quit he does, and that almost immediately. He leaves the core, crawls along his breathing and clearing-out gallery, the mouth of which, before nearly closed, he now gnaws into a smooth round hole, which will permit him free passage, without hurting his fat, soft, round body; then out he comes, and, for the first time in his life, finds himself in the open air. He now wanders about on the ground till he finds the stem of a tree: up this he climbs, and hides himself in some nice little crack in the bark. I should remark that the fall of the apple, the exit of the grub, and his wandering to this place of security, usually take place in the night-time. In this situation he remains without stirring for a day or two, as if to rest himself after the uncommon fatigue of a two yards' march; he then gnaws away the bark a little, in order to get further in out of the way of observation; and, having made a smooth chamber, big enough for his wants, he spins a beautiful

little milk-white silken case, in which, after a few weeks, he becomes a chrysalis, and in this state remains throughout the winter, and until the following June, unless some unlucky black-headed tit, running up the trunk, peeping into every cranny, and whistling out his merry see-saw, happens to spy him; in which case, he is plucked without ceremony from his retreat, and his last moments are spent in the bird's crop. But, supposing no such ill-fortune betide him, by the middle of June he is again on the wing, and hovering round the young apples on a midsummer evening, as before. By burning weeds in your garden, at this time of year, you will effectually drive away this little moth. If you have trees the crops of which you value, make a smoking (mind, not a blazing) fire under each. It will put you to some inconvenience if your garden be near your house; but the apples will repay you for that."

The little grey Moth (*Yponomeuta padella Lat., Tinea padella L.*) makes great havoc on hedges of the common hawthorn, on apple trees, and on many other trees and shrubs. Speaking of this insect, Mr. Main observes, "Wherever the caterpillars seat themselves, they appear to be congregated in vast numbers: every spray is covered. The leaves vanish before them; so that by midsummer, not only single trees, but whole orchards, and entire hedges, from end to end, are completely defoliated. Their depredations cease when they change into the pupa state; leaving the trees covered with the webs (or, rather, silky threads) by which the caterpillars had transported themselves from place to place, and every leaf shriveled, as if scorched by fire. These effects are familiarly known to many; but not so, or less so, have hitherto been the following points in the insect's economy: the time and place in which the mother moth deposits her eggs; the time at which the caterpillars are hatched from the eggs; and their course of feeding, from the time of being hatched, to the time at which the effects of their ravages command our observation of them. These points have been elucidated by the investigations of the late Mr. E. W. Lewis, and by his brother, Mr. R. H. Lewis. From a communication on this subject by the latter gentleman, published in the *Transactions of the Entomological Society of London*, we quote the following particulars:—'The mother moth deposits her eggs in the preceding year, generally on the small twigs, and chiefly on their under surface, in a circular patch about $1\frac{1}{2}$ line in diameter, which she covers over with a strong gluten, at first of a pale yellow, but which is afterwards, by the action of the atmosphere and rain, changed to a dark brown, very closely resembling the bark of the tree, and is then very difficult to be distinguished from it. The eggs hatch early in the autumn (the exact time I did not ascertain: I found them hatched in the beginning of October), and the larvæ remain in confinement during the whole winter, under the covering which is formed by the gluten and egg-shells. If we now raise up one of these excrescences, we shall find it hollow inside, and containing two dozen or more larvæ, of a pale yellow colour, with the head and a corneous plate on the first segment black, and about half or two thirds of a line long. In these receptacles they increase somewhat in size: the bark of the tree beneath is moist and green; but whether, or how, they derive nourishment from it, I am at a loss to say. About the time that the trees are coming into leaf, they make their escape; but they do not now commence spinning webs; they cannot yet eat the epidermis of the leaves, and they require some protection from the cold and rain, which their tender frames are not yet fitted to endure; to effect which they mine into the leaves, eating the parenchyma [cellular tissue] only, and leaving the epidermis untouched.

"Having acquired sufficient strength to withstand the vicissitudes of the atmosphere, and to devour the epidermis of the leaves, they make their way out; and the anxious gardener, who has hitherto only observed the brownness of the leaves, caused by the mining, but which is by him attributed to the withering blast of an easterly wind, is astounded when he perceives myriads of caterpillars swarming on the trees, and proceeding with alarming rapidity in their devastating course. The fact of their mining sufficiently

explains the reason of their sudden appearance: it shows how one day not a single caterpillar may be visible on the trees, and the next they may be swarming with larvæ of so large a size as to rebut the idea of their having been recently hatched. Besides, their latter habit of feeding on the leaves externally is so little like their former one of feeding on them internally, that any one who had not satisfied himself, by examination, that both habits are proper to the same caterpillars, would scarcely suppose this to be the case. While the caterpillars are within the leaves, they are of a yellowish colour, though they become darker at each change of skin. It is in this state that I would recommend their destruction, by gathering and burning every leaf which by its outward appearance betrays the internal ravages. Their nests are so difficult to discover, that searching for them seems entirely out of the question; and I am much afraid that, could any wash be conveniently applied to the small twigs, whatever might be sufficiently powerful to penetrate the glutinous covering would at the same time injure the tree.

“Having satiated themselves with the growing hopes of the gardener, who endeavours, but in vain, to stop their destructive career, they prepare for the pupa state by spinning white cocoons of an ellipsoidal form. In a short time they emerge from their pupæ, and may be seen in the evening, but more particularly in the early morning, flying by hundreds round those devoted trees which are, in the following year, to be the scene of similar ravages, unless circumstances for which we cannot account should prevent their multiplication.”

The Larvæ of various Moths feed on the leaves, and some even penetrate into the young shoots, of apple trees. One caterpillar, often found rolled up in an apple tree leaf, is of a chestnut-brown colour, with a black head; and another is green, with a few black hairs scattered over its body. The eggs of some of these moths are deposited in the preceding autumn, upon the branches, where they are fixed so firmly and are so little susceptible of injury from variation in temperature, that it is difficult to prescribe any application that would prevent caterpillars being hatched from them in the following spring.

There is also a moth which lays its eggs in the buds, the caterpillar of which eats its way through the bud into the soft wood, in the case of flower buds; and into the herbaceous shoot of the current year, in the case of leaf buds; occasioning the shoots and spurs soon afterwards to die. We are not aware that the economy of this insect has been studied and recorded, though it appears to belong to the family of *Ægèriæ*. These, according to Newman, “are produced from almost colourless maggots, which have the penultimate segment diminished, and without any horn; which have six corneous and pointed, and ten wart-like, and almost useless, feet; which feed in the interior of the trunks of trees, throughout the winter and spring; and then, spinning a cocoon among their food, change into remarkably rough and vivacious pupæ, which in ten or twelve days produce perfect insects.” (*Entom. Mag.*, vol. i. p. 71.) See *Encyc. of Gard.*, edit. 1835. art. Apple.

The common Cockchajer (*Melolontha vulgaris Fab.*), in its perfect state, attacks the leaves of all trees; and, though it has been found chiefly devouring those of the oak, (in treating of which tree the insect will be figured and described), yet it is also very injurious to those of the apple. Smoking them off, or shaking the branches of the tree till they drop to the ground, and then picking them up and destroying them, are the only means of alleviating the injuries done by insects already in their winged state; and they have the further advantage, with reference to the future, that they prevent the insects from laying their eggs. (See the article *Quercus*.)

Anómala (*Scarabæus*) *horticola*, a beetle called, in Norfolk, the chovy, is there deemed very injurious to apple trees, and to other trees and plants, as it feeds both on the leaves and flowers.

The Æcidium cancellatum (the fungus mentioned as growing on the leaves of the pear tree, and producing what is called mildew) is also not unfrequent

on the leaves of the apple tree; and there are other fungi which attack these leaves, for the names and figures of which we refer our readers to the *Encyclopædia of Plants*.

Statistics. In the environs of London, the largest apple trees which we have seen, in the oldest market-gardens, do not exceed 30 ft. in height. In the neighbourhood of Hereford, some are as high as 40 ft. In Worcestershire, and in Devonshire, the oldest apple trees are more frequently under 30 ft. than exceeding it. In Scotland, a tree 25 ft. high is considered of a large size. On the Continent, the apple tree is, in general, a small tree. In North America, it appears to attain a much larger size, and to be more productive, than in Europe. A pearmain, in New England, noticed in the *Gent. Mag.*, vol. xxxiii. p. 377., had a trunk 3 ft. $4\frac{1}{2}$ in. in diameter, at 1 ft. from the ground; and a mammoth apple tree, of which an account has lately been sent us by Dr. Mease of Philadelphia, is 45 ft. high, with a trunk 3 ft. $1\frac{1}{2}$ in. in diameter, and the diameter of the head 55 ft. In 1835, this tree produced 180 bushels of fruit fit to send to market; besides 4 or 5 bushels left under the tree as damaged, and several bushels which it was calculated had been gathered by passers by throughout the summer and autumn; so that the total produce is estimated by Dr. Mease as 200 bushels. The tree stands at Romney, in Virginia, where it grew spontaneously from seed; and, though estimated to be 40 years old, it still continues to increase in magnitude. The fruit is of a very large size. The produce of this tree far exceeds one mentioned by Speechey, as standing in an orchard at Burton Joyce, in Nottinghamshire, which, in 1792, produced upwards of 100 pecks of apples, which is the largest produce that we have heard of in England.

Commercial Statistics. The price of crab stocks, in the London nurseries, is from 20s. to 30s. per thousand; at Bollwyller, from 20 to 30 francs; and at New York, from 4 to 5 dollars. Grafted apple trees, in the London nurseries, are from 9d. to 1s. 6d. each for dwarfs, and from 1s. 6d. to 2s. 6d. for standards; and the price at Bollwyller and New York is according to the same ratio.

‡ 18. *P. CORONARIA* L. The garland-flowering Apple Tree.

Identification. Lin. Sp., 687.; Dec. Prod., 2. p. 625.; Don's Mill., 2. p. 647.

Synonymes. *Mâlus coronaria* Mill.; Crab Apple, the sweet-scented Crab, Amer.

Engravings. N. Du Ham., 6. pl. 44. f. 1.; Bot. Mag., t. 2009.; Michx. Arb., 2. t. 65.; and the plate in our Second Volume.

Spec. Char., &c. Leaves broadly ovate, rounded at the base, subangulate, serrated, smooth. Peduncles in corymbs, glabrous. Flowers odorous, white, becoming purple before they drop off. The fruit is flatly orbiculate, of a deep green when it falls from the tree, and becoming yellow after lying some time on the ground. (*Dec. Prod.*, adapted.) A native of North America, from Pennsylvania to Carolina, and more especially abundant in the back parts of Pennsylvania and Virginia. It generally forms a tree from 15 ft. to 18 ft. in height, with a trunk 5 in. or 6 in. in diameter; but Michaux has found it 25 ft. high. It appears very doubtful to us, whether this tree is specifically distinct from the wild apple of the Old World; though it differs from it in both the flowers and the fruit having the scent of violets, the former perfuming the air at the blossoming season. According to Michaux, some of the American farmers make cider of the fruit; and it is also preserved, and made into various sweetmeats. The fruit lies under the trees all winter, and seldom begins to rot till the spring. The leaves, when young, have a bitter and slightly aromatic taste; whence Michaux thinks that, with the addition of sugar, they would make an agreeable tea. This species was introduced into England in 1724, and is not unfrequent in collections. In some places, as at White Knights, and at Pepper Harrow near Godalming, it has become naturalised in the woods; and plants of all ages are found wild, which have sprung up from seeds disseminated by birds, and which preserve the distinctive features of the species, or race. The largest trees at Pepper Harrow are nearly 30 ft. in height; but they appear to have attained this size only in consequence of having been drawn up by other trees. In British gardens, the leaves and the fruit are retained much longer on the tree than is the case with the European crab; so much so, that in very mild seasons, and sheltered situations, it might be almost considered subevergreen. The deep green and flat round form of the fruit, and the lobed and veined character of the leaves, render this sort of *Mâlus* easily distinguished from every other; and this distinctiveness of character, and the fragrance of the blossoms, together with the lateness of their appearance (which is in the end of May), render it a most desirable tree, in every shrubbery, however small.

‡ 19. *P. (C.) ANGUSTIFOLIA* Ait. The narrow-leaved Apple Tree.

Identification. Ait. Hort. Kew., 2. p. 276; Pursh Fl. Amer. Sept., 1. 24; Dec. Prod., 2. p. 635; Don's Mill., 2. p. 647.

Synonymes. *P. coronaria* Wang. Amer., 61. t. 21. f. 47., upon the authority of Willdenow, and Wats. in *Dend. Brit.*; *Malus sempervirens* Desf. Arb., 2. p. 141.; *P. pumila* Hort.

Engravings. Wang. Amer., 61. t. 21. f. 47.; N. Du Ham., 6. t. 43. f. 1.; Wats. Dend., t. 132.; Bot. Reg., t. 1207.; and our plate in Vol. II.

Spec. Char., &c. Leaves glossy, lanceolate-oblong, dentately serrated, tapered and entire at the base. Flowers in corymbs. A native of the woods of Carolina. (*Dec. Prod.*, ii. p. 635.) Its flowers, which are produced late, as in the preceding sort, are sweet-scented; the corolla is of a very pale blush colour. This sort differs from the preceding one, in having the leaves narrower, and the fruit much smaller; also in being subevergreen, and in having lead-coloured speckled branches. Notwithstanding all these points of difference, however, it bears such a general resemblance to *P. coronaria*, that we cannot doubt its being only a variety of it. It is found wild in the low woods of Carolina; and it was introduced in 1750, by Christopher Grey. It grows to the height of 15 ft. or 20 ft.; and, on account of its fragrance and persistent leaves, it deserves a place in every collection. The fruit is green when ripe, and intensely acid, like that of *P. coronaria*; but it is much narrower and smaller.

‡ 20. *P. SPECTABILIS* Ait. The showy-flowering wild Apple Tree, or Chinese Crab Tree.

Identification. Ait. Hort. Kew., 2. p. 175.; Curt. Bot. Mag., t. 267.; Dec. Prod., 2. p. 635.; Don's Mill., 2. p. 646.

Synonymes. *Malus spectabilis* Desf. Arb., 2. p. 141.; N. Du Ham., 6. p. 141.; *Malus sinensis* Dum.

Conrs., ed. 2. 5. p. 429.

Engravings. Bot. Mag., t. 267.; N. Du Ham., 6. t. 42. f. 2.; and the plate of this species in Vol. II.

Spec. Char., &c. Leaves oval-oblong, serrated, smooth. Flowers in sessile umbels, many in an umbel; large, and very elegant; at first of an intense rose-colour, but afterwards of a pale one. Tube of calyx smooth. Petals ovate, clawed. Styles woolly at the base. (*Dec. Prod.*, ii. p. 635.) A native of China; cultivated in 1780, by Dr. Fothergill; growing to the height of 20 ft. or 30 ft.; and flowering in the end of April and beginning of May. This is by far the most showy of all the different species of *Pyrus*, both of this and of the other sections. The flowers are semidouble, and of a pale rose-colour; but before they are expanded, the flower buds, which are large, appear of a deep red. In this state the tree is extremely beautiful; particularly as the flowers appear early in the spring, when few other trees are in blossom. The stamens and pistils are much more numerous than in the other species; the former sometimes exceeding 40, and the latter 20. The fruit is small, irregularly round, angular, and about the size of a cherry: it is of a yellow colour when ripe, but is without flavour, and is only fit to eat when in a state of incipient decay; at which period it takes the colour and taste of the medlar. No garden, whether large or small, ought to be without this tree.

Statistics. In the environs of London, at Spring Grove, a tree, believed to be upwards of 50 years old, was, in 1834, 35 ft. high; at Kenwood, 38 years planted, it is 34 ft. high, the diameter of the trunk 1 ft. 7 in., and of the head 28 ft.; at Fulham Palace, 12 years old, and 20 ft. high; in Hampshire, at Eastwood, 20 years planted, and 16 ft. high; in Berkshire, at White Knights, 30 years planted, and 30 ft. high; in Cheshire, at Eaton Hall, 17 ft. high; in Oxfordshire, in the Oxford Botanic Garden, 30 years planted, and 25 ft. high, the diameter of the trunk 10 in., and of the head 20 ft.; in Shropshire, at Golden Grove, 40 years planted, and 25 ft. high; in Staffordshire, at Blythe-field, 25 years planted, and 28 ft. high; in Suffolk, at Great Livermere, 35 years planted, and 28 ft. high; in Worcestershire, at Croome, 25 years planted, and 25 ft. high. In Scotland, in Perthshire, in the Perth Nursery, 30 years planted, and 17 ft. high. In Ireland, at Dublin, in the Glasnevin Garden, 20 years planted, and 20 ft. high; at Terenure, 15 years planted, and 14 ft. high; in the Cullenswood Nursery, 20 years planted, and 35 feet high; in Fernagh, 20 years planted, and 25 ft. high; in Louth, at Oriel Temple, 25 years planted, and 19 ft. high. In France, at Paris, in the Jardin des Plantes, 30 years planted, and 35 ft. high.

App. i. *Additional Species of Pyrus belonging to the Section Malus*

P. quinquefida Hamill. (*Don's Mill.*, 2. p. 647.) has elliptic acute leaves, and is indigenous in Chithong. The flowers are supposed to be white. All that is known in Europe of this species has been derived from dried specimens in the Linnæan Society's herbarium.

P. Sievèrsii Led. *Fl. Atl.*, 2. p. 222., *Don's Mill.*, 2. p. 647.; *P. nov. sp. Sievers* in *Pall. Nord. Beitr.*, 7. p. 292., is a bush, with many stems rising from the same root; with ovate leaves rather tomentose, and umbellate flowers, succeeded by very acid fruit. It is a native of Siberia; and it is rather remarkable that it has never been introduced into England.

§ iii. *Aria* Dec.

Sect. Char., &c. Petals spreading, flat. Styles mostly 2—3. Pome globose. Flowers in racemose corymbs; the peduncles branched. Leaves simple, not glanded, whitely tomentose beneath. (*Dec. Prod.*, ii. p. 635.) Deciduous trees, natives of various parts of Europe, and of Asia; chiefly found on dry, calcareous, or clayey soils, and varying much in a state of culture. The species and varieties are in a state of great confusion.

‡ 21. *P. ARIA* Ehrh. The White Beam Tree.

Identification. Ehrh. *Beitr.*, 4. p. 20.; *Dec. Prod.*, 2. p. 636.; *Don's Mill.*, 2. p. 647.

Synonymes. *Cratægus Aria* var. *α* *Lin. Sp.*, 681.; *Mespilus Aria* *Scop.*; *Sörlus Aria* *Crantz Austr.*, 1. t. 2. f. 2.; *Bauh. Hist.*, 1. p. 65.; *Aria* *Theophrasti* *L'Obel.*; white wild Pear, white Leaf Tree, red Chess-Apple, Sea Ouler, Cumberland Hawthorn *Gerard.*; *Alsier* *Allouchier*, *Alsier blanc*, *Fr.*; *Mehlbeerbaum*, or *Mehlbaum*, *Ger.*; *Aria*, or *Sorba pilosa*, *Ital.*; *Mostaco*, *Span.*; *Axelbeer*, *Dan.*; *Oxilbeer*, *Swed.*

Derivation. *Aria*, the name given to this tree by Theophrastus, is probably from the name of that country in Asia. The White Beam Tree is a pleonasm, *beam* being the Saxon word for tree. The word *Allouchier* is from *alouchion*, the cog of a wheel, the wood of the tree being much used for that purpose in France. *Mehlbaum* is literally the meal tree, from the mealy appearance of the under side of the leaves.

Engravings. *Crantz Austr.*, 1. t. 2. f. 2.; *Eng. Bot.*, t. 1858.; *Fl. Dan.*, t. 302.

Spec. Char., &c. Leaves ovate, doubly serrated, tomentose beneath, with appressed white tomentum. Corymbs flat. (*Dec. Prod.*, ii. p. 636.)

Varieties.

‡ *P. A. 1 obtusifolia* *Dec. Prod.* ii. p. 636., and *Fl. Dan.*, t. 302.; *P. A. ovalis* *Hort.*—Leaves broadly ovate, and obtuse.

P. A. 2 acutifolia *Dec. Prod.*, l. c.; *Cratægus longifolia* *N. Du Ham.*, 4. t. 34.; ? *Pyrus alpina* *Willd. Enum.*, 527.; which has ovate-oblong acute leaves.

‡ *P. A. 3 undulata* *Lindl. Hort. Trans.*, vii. p. 234., and our plate in Vol. II., has the leaves flat, oval-lanceolate, broad, undulated, unequally and deeply serrated, acuminate, and cobwebbed above.

‡ *P. A. 4 angustifolia* *Lindl.*, l. c., has the leaves oval, obtuse, concave, somewhat simply serrated, woolly above.

‡ *P. A. 5 rugosa* *Lindl.*, l. c.—Leaves large, ovate-elliptic, doubly serrated, shining above and wrinkled, white beneath.

‡ *P. A. 6 cretica* *Lindl.*, l. c.; *P. A. rotundifolia* *Hort.*; *P. græca* *Hort.*—Leaves flat, orbicularly elliptic, crenately serrated, retuse, cuneated at the base; smooth above, and hoary beneath. Branches cobwebbed.

‡ *P. A. 7 bullata* *Lindl. Hort. Trans.*, vii. p. 234.; *P. A. acuminata* *Hort.*; has the leaves concave, elliptic, acuminate, blistered; closely serrated at the apex, but entire at the base.

Description, &c. This tree rises to the height of 30 ft. or 40 ft. in favourable situations, with a straight, erect, smooth trunk, and numerous branches, which for the most part tend upwards, and form a round or oval head. The young shoots have a brown bark, covered with a mealy down; the leaves are between 2 in. and 3 in. long, 1½ in. broad in the middle, light green above, and very white and downy beneath. The flowers are terminal, in large corymbs, 2 in. or more in diameter, and they are succeeded by scarlet fruit, which makes a very conspicuous appearance in the autumn, but of which the tree seldom bears two good crops in succession. The rate of growth, when the tree is young, and in a good soil, is from 18 in. to 2 ft. a year: after it has attained the height of 15 ft. or 20 ft. it grows much slower; and, at the age of twenty or thirty years, it grows very slowly; but is a tree of great duration. The roots descend very deep, and spread very wide; and the head of the tree is less affected by prevailing winds than almost any other. In the most exposed situations, on the Highland mountains, this tree is seldom seen

above 10 ft. or 15 ft. high ; but it is always stiff and erect. It is later in coming into leaf than any other indigenous tree, except the ash. It bears lopping, and permits the grass to grow under it.

Geography, History, &c. The white beam tree is a native of most parts of Europe, from Norway to the Mediterranean Sea ; and also of Siberia and Western Asia. Some species of the *γ Aria* are found in Nepal, which are probably only varieties of the European kinds ; but none have been yet discovered in North America. In Britain, the geologic sites in which it is found wild are almost always chalky soils, or limestone rocks ; but sometimes, also, calcareous clays. Withering says that it loves dry hills, and open exposures, and flourishes either on gravel or clay. It is to be met with in every part of the island, varying greatly in magnitude, according to soil and situation. It has been known to writers on plants since the days of Theophrastus ; and the circumstance of its bearing a distinct name in all the European languages shows that it has been long familiar to country people.

Properties and Uses. The wood is very hard, of a fine close grain, yellowish white, and susceptible of a high polish. In a green state, it has a strong smell, which it retains, in a slight degree, even after it is dried. It weighs, in that state, 55 lb. 6 oz. per cubic foot. It may be stained of any colour, and is much used in the smaller manufactures, such as making handles to knives and forks, wooden spoons, &c. ; and for musical instruments, and various turnery articles. Combs, it is said, have been made of it equally durable with those made from the box. It is also used for axletrees, naves, and felloes of wheels, carpenters' tools, and walking-sticks ; and it affords an excellent charcoal for making gunpowder. But the great use of the wood of this tree, throughout Europe, is for cogs to the wheels of machinery. It is universally employed for this purpose on the Continent ; and was so in Britain till cast iron became generally substituted for it in the wheels of machinery. The leaves are eaten both by goats and sheep. The fruit is acid and astringent ; but it is not disagreeable to eat, when it is in a state of incipient decay. Dried, and reduced to powder, it has been formed into a sort of bread, which has been eaten, both in France and Sweden, in years of great scarcity. Fermented, the fruit affords a beer ; or, by distillation, a powerful spirit : it is greedily eaten by small birds ; on which account the trees are ordered to be preserved in the French forests, that the number of birds may be increased, in order to keep down the insects. The fruit is also the food of squirrels ; and, when it drops, of the wild boar, the deer, the hedgehog, &c.

As an ornamental tree, the white beam has some valuable properties. It is of a moderate size, and of a definite shape ; and thus, bearing a character of art, it is adapted for particular situations near works of art, where the violent contrast exhibited by trees of picturesque forms would be inharmonious. In summer, when clothed with leaves, it forms a compact green mass, till it is ruffled by the wind, when it suddenly assumes a mealy whiteness. In the winter season, the tree is attractive from its smooth branches, and its large green buds ; which, from their size and colour, seem already prepared for spring, and remind us of the approach of that delightful season. When the tree is covered with its fruit, it is exceedingly ornamental. Among the different varieties enumerated, *P. A. crética* is by far the most distinct : but all of them are well deserving of cultivation.

Soil and Situation. A calcareous and dry soil is essential ; and the tree will not attain a timber size unless it is placed in an airy situation. The largest trees in Britain are at Blair, in Perthshire, where they stand in the margins of open woods, or in hedgerows. The situation may be exposed to the highest and coldest winds that prevail in this country, and yet the tree will never fail to grow erect, and produce a regular head ; and, for this reason, no tree is better adapted for sheltering houses and gardens in very exposed situations.

Propagation and Culture. The species may be raised from seed, and the varieties be grafted on stocks of the species of the pear, of the *Cratægus*, and even of the quince and medlar ; which trees, it is almost unnecessary to add,

may be reciprocally grafted on the white beam tree. When plants are to be raised from seed, the seeds should be sown as soon as the fruit is ripe; otherwise, if kept till spring, and then sown, they will not come up till the spring following. When it is inconvenient to sow them immediately that they are gathered, they may be mixed with soil, and treated like haws (see *Pyrus aucuparia*); and, if sown in the March following, they will come up the same season. The varieties may be propagated by cuttings, or by layering; but they root, by both modes, with great difficulty. Layers require to be made of the young wood, and to remain attached to the stool for two years.

Statistics. In the environs of London, the largest tree is at Syon, and is 40 ft. high, with a trunk 2 ft. in diameter, and the diameter of the head 12 ft.; one at Kew is 25 ft. high; in Oxfordshire, in the Oxford Botanic Garden, one, 30 years planted, is 25 ft. high, the diameter of the trunk 16 in., and of the head 17 ft.; in Yorkshire, at Hackness, 25 years planted, and 28 ft. high. In Scotland, in the environs of Edinburgh, at Hapetoun House, 18 years planted, and 20 ft. high; in Perthshire, in the Perth Nursery, 49 years planted, and 32 ft. high, the diameter of the trunk 17 in., and of the head 22 ft. In Ireland, in Dublin, at the Glasnevin Botanic Garden, 35 years planted, and 30 ft. high, the trunk 12 in. in diameter, and the head 19 ft. In Sweden, in the Botanic Garden at Lund, it is 46 ft. high.

‡ 22. *P. (A.) INTERMEDIA Ehrh.* The intermediate White Beam Tree.

Identification. Ehrh. Beitr., 4. p. 20.; Dec. Prod., 2. p. 636.; Don's Mill., 2. p. 647.

Synonyms. *Crataegus Aria* β Lin. Sp., 681.; *C. scandia Wahlb. Fl. Ups.*, 165.; *C. succica At. Hort. Kew.*, 167.; *Alsier de Fontainebleau, Fr.*; *Schwedischer Mehlbaum, Ger.*

Spec. Char., &c. Leaves ovate, incisely lobed, tomentose beneath, with white appressed tomentum. Corymbs flat. Fruit eatable. (*Dec. Prod.*, ii. p. 636.)

Varieties. De Candolle has described the two following forms of this species:—

‡ P. (A.) i. 1 *latifolia*; *Crataegus latifolia Poir. Dict.*, 4. p. 444., *Du Ham. Arb.*, t. 80., *N. Du Ham.*, 4. t. 35.; *Sorbus latifolia Pers.*; *Crataegus dentata Thuil. Fl. Par.*—Leaves broadly ovate. A native of the wood of Fontainebleau.

‡ P. (A.) i. 2 *angustifolia*; *P. edulis Willd. Enum.*, p. 527., *Wats. Dend. Brit.*, t. 52., and our fig. 640. Leaves oblong, wedge-shaped at the base.

Description, &c. These trees bear so close a resemblance to *P. Aria*, as to leave no doubt in our minds that they are only varieties and subvarieties of that species. They are found in a wild state in France, Germany, and Sweden; and perhaps also in the Highlands of Scotland, where, according to Sir W. J. Hooker, *P. Aria* varies in having the leaves more or less cut at the margin. They are all well deserving of culture.



‡ 23. *P. (A.) VESTITA Wall.* The clothed White Beam Tree.

Identification. Wall. Cat., 679.; Don's Mill., 2. p. 647.

Synonyms. *Pyrus nepalensis Hort.*; *Sorbus vestita Lodd. Cat.*, edit 1836.

Engraving. The plate in Vol. II.

Spec. Char., &c. Leaves, cymes, and young branches, clothed with white tomentum. Leaves elliptic, or obovate-elliptic, acuminate, serrated towards the apex. Corymbs branched and terminal. Flowers white. Fruit greenish brown. Habit of *P. Aria*. (*Don's Mill.*, ii. p. 647.) A tree from 20 ft. to 30 ft. high, a native of Nepal and Kamaon, introduced in 1820. This tree is remarkable for the rapidity of its growth, its long broad leaves, and their woolly whiteness; and also for being one of the very latest trees, whether foreign or indigenous, in coming into leaf; being later than either the mulberry or ash. The leaves are conspicuous, on their first expansion,

for their whiteness, particularly underneath; and in autumn, before they drop off, for their fine yellow colour. Judging from the leaves of this tree, we should say that it is the same as *P. crenata* D. Don (No. 10. in p. 890.); but, as the fruit (which we have never seen) of *P. crenata* ought, from the section in which it is placed, to be pear-shaped, and as the fruit of *P. nepalensis*, which is produced in abundance on a tree at Messrs. Loddiges, is round, they may be distinct. So striking a tree, and one of such free growth, ought not to be wanting in any collection. The two finest specimens we know of this tree, in the neighbourhood of London, are at Messrs. Loddiges.

App. i. *Additional Species of Pÿrus, belonging to the Section A`ria.*

P. kamaonensis Wall. Cat., No. 678., Don's Mill., 2. p. 647., is a tree growing to the height of 20 ft. or 30 ft., a native of Kamaon and Sirmore, with oblong pinnatifidly-lobed, and serrated leaves, clothed with white down beneath. The fruit is pear-shaped, red, and about the size of a common medlar.

P. lanata D. Don (*Prod. Fl. Nepal*, p. 237.; *Dec. Prod.*, ii. p. 634.; and *G. Don's Mill.*, ii. p. 622.) has broadly elliptic, doubly serrated leaves, woolly beneath; and is probably only a variety of *P. vestita*.

§ iv. *Torminària* Dec.

Sect. Char., &c. Petals spreading, flat, having short claws. Styles 2—5, connected, glabrous. Pome scarcely at all juicy, top-shaped at the base truncate at the tip; the sepals deciduous. Leaves angled with lobes; in the adult state glabrous. Flowers in corymbs. The peduncles branched. (*Dec. Prod.*, ii. p. 636.) Trees of the same general character, in regard to habit and constitution, as *P. A`ria*.

¶ 24. *P. TORMINA`LIS* Ehrh. The griping-fruited Service Tree.

Identification. Ehrh. Beitr., 6. p. 92.; *Dec. Prod.*, 2. p. 636.; Don's Mill., 2. p. 647.

Synonymes. *Crataegus torminalis* Lin. Sp., 681., *Smith Eng. Bot.*, t. 298., *Fl. Dan.*, t. 798., *Jacq. Fl. Austr.*, t. 443.; *Sorbus torminalis* Crantz *Austr.*, p. 85.; the Maple-leaved Service Tree; *Ah-sier des Bois*, Fr.; *Elzbear Baum*, Ger.

Engravings. *Jacq. Fl. Austr.*, t. 443.; and our plate in Vol. II.

Spec. Char. Leaves cordate-ovate, feather-nerved, pinnatifidly lobed; when young, slightly downy beneath; when adult, glabrous; the lobes acuminate and serrated, the lowest divaricate. Seeds cartilaginous. (*Dec. Prod.*, ii. p. 636.)

Description, &c. A tree, growing to the height of 40 ft. or 50 ft., with a large trunk, spreading at the top into many branches, and forming a large head. The young branches are covered with a purplish bark, marked with white spots. The leaves, which are on long footstalks, are cut into many acute angles, like those of some species of maple. They are nearly 4 in. long, and 3 in. broad in the middle, bright green above, and slightly woolly underneath. The flowers are produced in large bunches at the end of the branches; and they are succeeded by roundish compressed fruit, not unlike common haws, but larger, and of a brown colour when ripe. The tree is of slow growth, and in this respect, and most others, it resembles *P. A`ria*; but it is less hardy.

Geography, History, &c. The griping, or common wild, service tree is a native of various parts of Europe, from Germany to the Mediterranean, and of the south of Russia, and Western Asia. It is found in woods and hedges in the middle and south of England, but not in Scotland or in Ireland. It generally grows in strong clayey soils. Miller, in 1752, says that "it was formerly very abundant in Cane Wood, near Hampstead." The tree, it is believed, was known to the Greeks (see p. 17.), and is the one mentioned by Pliny as *Sorbus torminalis*; though this name may possibly have been applied by him to the true service (*Sorbus domestica*). It is figured by Gerard, who says very little of the tree, but mentions the fruit as cold and binding. One of the finest specimens in England is at Arley Hall, near Bewdley, for a drawing of which we are indebted to the Earl of Mount Norris, of which

fig. 641. is a copy reduced to a scale of 1 in. to 12 ft. This fine tree is 54 ft. 6 in. high; the diameter of the trunk, at a foot from the ground, is 3 ft. 6 in., and that of the head is 58 ft. 8 in.



Properties and Uses. The wood resembles that of *P. Aria*, but is without its peculiarly strong smell. It weighs, when newly cut, 65 lb. to the cubic foot, and when dried, 48 lb. 8 oz. It is employed for all the different purposes to which that of *P. Aria* is applicable, and is considered rather preferable as fuel, and for charcoal. For fuel, its value, when compared with that of the beech, is as 1.038 to 1.540; and for charcoal, as 1.062 to 1.600. The fruit is brought to market both in England and France; and, when in a state of incipient decay, it eats somewhat like that of the medlar. As an ornamental tree, its large green buds strongly recommend it in the winter time, as its fine large-lobed leaves do in the summer, and its large and numerous clusters of rich brown fruit do in autumn.

Soil and Situation. It will grow in a soil not poorer, but more tenacious and moist, than what is suitable for *P. Aria*; and it requires a sheltered situation. It seems more liable to the attacks of insects than that species, and does not thrive so well in the neighbourhood of London. It is propa-

gated exactly in the same manner as *P. Aria*. There being no varieties, it does not require to be continued by grafting.

Statistics. In the environs of London, at Syon, it is 30 ft. high; in the Fulham Nursery, 40 years planted, it is 30 ft. high; in Staffordshire, at Arley Hall, there is the fine specimen mentioned above, which is 54½ ft. high; in Wiltshire, at Longleat, 65 years planted, it is 35 ft. high. In France, at Laye, near Passay, 50 years planted, it is 50 ft. high; at Nantes, in the nursery of M. De Nerrières, and in the neighbouring woods, it is 50 ft. high. In Saxony, at Wörlitz, 44 years planted, it is 30 ft. high. In Austria, near Vienna, at Brück on the Leytha, 40 years planted, it is 30 ft. high.

App. i. *Other Species of Pyrus belonging to the Section Terminaria.*



P. rivularis Dougl. in Hook. Fl. Bor. Amer., 1. p. 203. t. 68., and our figs. 642. and 643, is a small tree, with ovate or, entire subtrilobate leaves, pubescent underneath; a native of Nootka Sound, and other parts of the north-west coast of North America. The wood is employed for making wedges; and the fruit is used as an article of food, under the name of pow-itch, by the Cheenook Indians. It flowers in April and May. It is much to be desired that this species of *Pyrus* were introduced into Britain; since it seems the only one of the section which is indigenous to the western hemisphere. Judging from the engravings in Dr. Hooper's work (from which our fig. 642. has been reduced to our usual scale of 2 in. to 1 ft., and fig. 643. has been copied of the natural size), it is a very handsome species.



§ v. *Eriolobus* Dec.

Sect. Char. Petals spreading, flat, with short claws, and with about 3 teeth at the tip. Styles 5, long at the base very hairy, and somewhat connected. Pome globose, glabrous, crowned with the lobes of the calyx, which are tomentose upon both surfaces. Leaves palmately lobed, glabrous. Flowers upon unbranched pedicels, disposed in corymbs. (*Dec. Prod.*, ii. p. 636.)

‡ 25. *P. TRILOBATA* Dec. The three-lobed-leaved Pear Tree.

Identification. Dec. Prod., 2. p. 636.; Don's Mill, 2. p. 648.
Synonymy. *Crataegus trilobata* Labill. Dec., 4. p. 15. t. 10., *Poir. Suppl.*, 1. p. 291.
Engraving. Labill. Dec., 4. t. 10.

Spec. Char., &c. Leaves glabrous, palmately lobed; the middle lobe 3-lobed; the side lobes, in many instances, 2-lobed; the secondary lobes serrated. (*Dec. Prod.*, ii. p. 636.) A tree, a native of Mount Lebanon; growing to the height of 20 ft.; said to have been introduced in 1810; but of which we have not seen a plant.

§ vi. *Sorbus* Dec.

Sect. Char., &c. Petals spreading, flat. Styles 2—5. Pome globose, or top-shaped. Leaves impari-pinnate, or pinnately cut. Flowers in branched corymbs. (*Dec. Prod.*, ii. p. 636.) Trees, growing to the height of from 20 ft. to 40 ft. or upwards. Natives of Europe, North America, or the Himalayas. In this, as in the preceding section, there is a very great confusion of names.

‡ 26. *P. AURICULATA* Dec. The auricled Service Tree.

Identifications. Dec. Prod., 2. p. 636.; Don's Mill, 2. p. 648.
Synonymy. *Sorbus auriculata* Pers. Syn., 2. p. 39.
Spec. Char., &c. Leaves of 3 pairs of leaflets, and an odd one, hirsute beneath; 2—4 of the lowest leaflets distinct, the rest connate with the odd one into an ovate one, which is crenate. Corymb compact. (*Dec. Prod.*, ii. p. 636.) A native of Egypt, and supposed by De Candolle to be only a variety of *P. pinnatifida*. It is said to have been introduced in 1800; but we have not seen the plant.

‡ 27. *P. PINNATIFIDA* Ehrh. The pinnatifid-leaved Service Tree.

Identification. Ehrh. Beitr., 6. p. 93.; Smith in Eng. Bot., t. 2331.; Dec. Prod., 2. p. 636.
Synonymy. *Sorbus hybrida* Lin. Dec., 6.; *Pyrus hybrida* Smith Fl. Brit., not of Willd.; the Bastard Service Tree.
Engravings. Eng. Bot., t. 2331.; and our plate in Vol. II.

Spec. Char., &c. Leaves pinnately cloven, or cut, or almost pinnate at the base. The petiole on the under side, and the peduncles, hoarily tomentose.

Pome globose, scarlet. (*Dec. Prod.*, ii. p. 636.) A native of mountainous woody places in Gothland, Thuringia, and Britain. A species, according to De Candolle, a hybrid between *P. internèdia* and *P. aucupària*; growing to the height of 20 ft. or 30 ft.; and of the same culture as *P. Aria*. The varieties enumerated below, as far as we have seen them, are hardly deserving of being kept distinct, unless we except *P. p. pèndula*.

Varieties.

- ♣ *P. p. 2 lanuginòsa* has the leaves more woolly than those of the species,
 ♣ *P. p. 3 pèndula*, *Sòrbus híbrida pèndula Lodd. Cat.*, has the head loose, and the branches somewhat pendulous. There is a tree in the south-west corner of the Horticultural Society's Garden, the fruit of which is red.
 ♣ *P. p. 4 arbúscula* *Dec., Poir. Suppl.*, 5. p. 144.—Dwarf. Leaflets glabrous in a measure, obtuse; the outermost usually connate. A native of Germany. Is it a variety of *P. aucupària*? (*Dec. Prod.*, ii. p. 636.)

Statistics. Plants of this kind in the Horticultural Society's Garden, and in the arboretum of the Messrs. Loddiges, are from 15 ft. to 20 ft. high, after being 10 or 12 years planted. In Worcestershire, at Croom, a tree, 50 years planted, is 45 ft. high, the diameter of the trunk 24 in., and that of the head 55 ft. In Scotland, in the Glasgow Botanic Garden, one, 15 years planted, is 16 ft. high.

♣ 28. *P. AUCUPÀRIA* *Gartn.* The Fowler's Service Tree, or Mountain Ash.

Identification. *Gartn. Fruct.*, 2. p. 45. t. 87; *Dec. Prod.*, 2. p. 637; *Don's Mill.*, 2. p. 648.

Synonymes. *Sòrbus aucupària Lin. Sp.*, 683; *Mèspilus aucupària All.*; Quicken Tree, Quick Beam, wild Ash, wild Service, Wichén Tree, Rowan Tree, Rowne Tree, Roan Tree, Roddan, Róutry, Mountain Service, Witchen, wild Sorb, Whichen, Whitten, Wiggen tree; Sorbier des Oiseleurs, or Sorbier des Oiseaux, *Fr.*; Vogel Beerbaum, *Ger.*; Sorbo salvatico, *Ital.*

Derivation. The Latin name, *P. aucupària* (the Fowler's Pyrus) the French names, Sorbier des Oiseleurs (the Bird-catcher's Service), and Sorbier des Oiseaux (the Bird Service); and the German name, Vogel Beerbaum (the Bird's Berry Tree); are all derived from the use made of the berries by bird-catchers, in all countries where the tree grows wild, and from time immemorial, to bait springs with. It is called the Mountain Ash, from its growing on mountains, and the pinnæ of its leaves bearing some resemblance to those of the common ash. Witchen, and all its derivatives, bear relation to supposed powers of the tree, as a protection against witches and evil spirits.

Engravings. *Gartn. Fruct.*, 2. t. 87; *Eng. Bot.*, t. 337; and the plate of this species in our Second Volume.

Spec. Char., &c. Buds softly tomentose. Leaflets serrated, slightly glabrous. Pomes globose. (*Dec. Prod.*, ii. p. 637.) A low tree, a native of almost every part of Europe; growing to the height of 20 ft. or 30 ft.; flowering in May, and ripening its fruit in September.

Varieties.

- ♣ *P. a. 2 fructu luteo* has yellow berries, and is continued by grafting.
 ♣ *P. a. 3 foliis variegatis* has variegated leaves.
 ♣ *P. a. 4 fastigiata* has the branches upright and rigid. There are plants of this kind in the Horticultural Society's Garden, which were received from Mr. Hodgkin of Dunganstown Nursery, in the county of Wicklow.

Description. The mountain ash forms an erect-stemmed tree, with an orbicular head. When fully grown, like every other description of *Pyrus*, it assumes a somewhat formal character; but in a young state, its branches are disposed in a more loose and graceful manner. The bark is smooth and grey, in the young and old wood; the leaves are impari-pinnate, and the leaflets are serrated, except at the base. They are smooth above, and nearly so beneath; in which last respect they differ from the leaves of *Pyrus Sòrbus*, which, in their young state, at least, are downy beneath as well as above. The tree grows rapidly for the first three or four years; attaining, in five years, the height of 8 ft. or 9 ft.; after which it begins to form a head, and, in ten years, will attain the height of 20 ft. This head will continue increasing slowly, though the tree seldom grows much higher, for the greater part of a century; after which, as it appears by the oldest trees that we have observed or heard of in Scotland, the extremities of the branches begin to decay. The tree will not bear lopping, but grass, and other plants, grow well under its shade.

Geography, History, &c. The mountain ash is a native of most parts of Europe, from Iceland and Greenland to the Mediterranean Sea. It is found, also, in the north-west of Asia, at Labrador, Nova Scotia, and in other regions of the most northern parts of North America. According to Pallas, it is frequent throughout the whole of Russia and Siberia, as far as the Eastern

Ocean; and from the cold mountainous woody regions of the north, to the alpine parts of Caucasus and Mount Libanus. In the former situation it is a low shrubby bush, and in the latter a handsome tree of the third rank. It is found in Japan, and probably, also, in other islands of the Indian Ocean. In Britain, it is common in woods and hedges, in mountainous, but rather moist situations, in every part of the island, and also in Ireland. In France, Germany, and Switzerland, it is wild in all the woods, as well as in the higher and colder regions of the mountains of Spain and Italy. The soil in which it thrives best, though moist, is not boggy, but rather loamy or light. The situation is generally more or less exposed; for, if crowded by other trees, its trunk, like that of other species of *Pyrus*, in similar situations, never attains a large size. The largest trees of this species in Britain are those in the Western Highlands, and on the west coast of Scotland; from which it may be inferred, that it prefers a moist climate to one that is dry. Withering justly observes that it will not attain a large size, unless it grows in a fertile soil. The tree was known to the Greeks and Romans; and Virgil was aware that it might be grafted on the pear. It is mentioned under the name of *Sorbus sylvéstris* by Matthioli, and other eminent writers on plants, down to the time of Gerard; who, like Pliny, considered it as a species of ash.

Properties and Uses. The wood, when dry, weighs 51 lb. 12 oz. per cubic foot. It is homogeneous, fine-grained, hard, capable of being stained any colour, and of taking a high polish; and it is applied to all the various uses of *P. Aria* and *P. torminális*, when it can be obtained of adequate dimensions. In Britain, the tree forms excellent coppice wood, the shoots being well adapted for poles, and for making excellent hoops; and the bark being in demand by tanners. As it will grow in the most exposed situations, and rapidly, when young, it forms an admirable nurse tree to the oak, and other slow-growing species; and, being a tree of absolute habits; that is, incapable of being drawn up above a certain height by culture, it has this great advantage, that, after having done its duty as a nurse, instead of growing up with the other trees, and choking them, it quietly submits to be over-topped, and destroyed by the shade and drip of those which it was planted to shelter and protect. It may be mentioned, as somewhat singular, that the alpine laburnum though naturally a much lower tree than the mountain ash, will, when drawn up in woods, attain twice the height of the latter tree. The fruit of the mountain ash is greedily devoured by birds; and, in various parts of the north of Europe, these berries are dried and ground into flour, and used as a substitute for the flour made of wheat, in times of great scarcity. In Livonia, Sweden, and Kamtschatka, the berries of the mountain ash are eaten, when ripe, as fruit; and a very good spirit is distilled from them. Evelyn says that "ale and beer brewed with these berries, being ripe, is an incomparable drink, familiar in Wales." They form, he says, a tempting bait for the thrushes; so that, "as long as they last in your woods, you will be sure of their company." "Besides the use of it for the husbandman's tools, goods, &c., the wheelwright commends it for being all heart; our fletchers (archers) commend it for bows, next to yew, which we ought not to pass over, for the glory of our once English ancestors. In a statute of Henry VIII. you have it mentioned; and there is no churchyard in Wales without a mountain ash tree planted in it, as the yew trees are in the churchyards in England. So, in a certain day in the year, every body in Wales religiously wears a cross made of the wood; and the tree is, by some authors called *Fraxinus cambro-britannica*." (*Hunter's Evelyn*, vol. i. p. 218.) In Germany, the fowlers bait springes, or nooses of hair, with the berries of this tree, which they hang in the woods to entice the redwings and fieldfares. Infused in water, the berries make an acid drink, somewhat resembling perry, which is much used in Wales by the poor, who call it diod-graviole, or ciavol drink. In the Isle of Java, the juice of these berries is used as an acid for punch. (See *Martyn's Miller*.) As an ornamental tree, the mountain ash is well adapted for small gardens; and it is also deserving of a place in

every plantation, where the harbouring of singing-birds is an object. In the Scottish Highlands, Gilpin observes, "it becomes a considerable tree. There, on some rocky mountains, covered with dark pines and waving birch, which cast a solemn gloom over the lake below, a few mountain ashes joining in a clump, and mixing with them, have a fine effect. In summer, the light green tint of their foliage, and, in autumn, the glowing berries which hang clustering upon them, contrast beautifully with the deeper green of the pines; and, if they are happily blended, and not in too large a proportion, they add some of the most picturesque furniture with which the sides of those rugged mountains are invested." (*Gilpin's Forest Scenery*, vol. i. p. 38.) In the grounds of suburban gardens in the neighbourhood of the metropolis, the mountain ash forms almost the only tree that makes a great display by means of its fruit; for, though many species of *Crataegus* would be equally effective in this respect, they have not yet become sufficiently well known to the planters of such gardens. One great advantage of the mountain ash, in all gardens, is, that it never requires pruning, and never grows out of shape.

Poetical and legendary Allusions. Ancient poets tell us that the Amazons of ancient mythology formed their spears of the wood of this tree; and Virgil mentions that its fruit was considered as sure to attract the thrush and blackbird to any grove where it grew. (*Sylva Florifera*, vol. i. p. 84. and p. 87.) In more modern times, it was considered a preservative against witchcraft; and Lightfoot, in his *Flora Scotica*, says, "It is probable that this tree was in high esteem with the druids; for it may to this day be observed to grow more frequently than any other in the neighbourhood of those druidical circles of stones, so often seen in the north of Britain; and the superstitious still continue to retain a great veneration for it, which was undoubtedly handed down to them from early antiquity. They believe that any small part of this tree, carried about them, will prove a sovereign charm against all the dire effects of enchantments and witchcraft. Their cattle, also, as well as themselves, are supposed to be preserved by it from evil; for the dairy-maid will not forget to drive them to the shealings, or summer pastures, with a rod of the rowan tree, which she carefully lays up over the door of the sheal-booth, or summer-house, and drives them home again with the same. In Strathspey they make, on the 1st of May, a hoop with the wood of this tree, and in the evening and morning cause the sheep and lambs to pass through it." "This superstitious belief," Dr. Johnson, in his *Flora of Berwick upon Tweed*, remarks, "prevailed also in Northumberland, but is probably now extinct." (vol. i. p. 110.) That a belief in the supernatural virtues of this tree still prevails in Yorkshire appears from the following extract from a communication, by the celebrated author of the *Wanderings*, to the *Mag. Nat. Hist.*:—"Whilst the fruit of the mountain ash affords a delicious autumnal repast to the storm cock, the branches which bear the berries are well known to be an effectual preservative against the devilish spells of witchcraft. In the village of Walton, I have two small tenants: the name of the one is James Simpson, and that of the other Sally Holloway; and Sally's house stands a little before the house of Simpson. Some three months ago, I overtook Simpson on the turnpike road, and I asked him if his cow was getting better, for his son had told me that she had fallen sick. 'She's coming on surprisingly, Sir,' quoth he; 'the last time the cow-doctor came to see her, "Jem," said he to me, looking earnestly at Old Sally's house; "Jem," said he, "mind and keep your cow-house door shut before the sun goes down, otherwise I wo'u't answer for what may happen to the cow." "Ay, ay, my lad," said I, "I understand your meaning; but I am up to the old slut, and I defy her to do me any harm now." "And what has Old Sally been doing to you, James?' said I. 'Why, Sir,' replied he, 'we all know too well what she can do. She has long owed me a grudge; and my cow, which was in very good health, fell sick immediately after Sally had been seen to look in at the door of the cow-house, just as night was coming on. The cow grew worse; and so I went and cut a bit of wiggin (mountain ash), and I nailed the

branches all up and down the cow-house; and, Sir, you may see them there, if you will take the trouble to step in. I am a match for Old Sally now, and she can't do me any more harm, so long as the wiggin branches hang in the place where I have nailed them. My poor cow will get better in spite of her' Alas! thought I to myself, as the deluded man was finishing his story, how much there is yet to be done in our part of the country by the schoolmaster of the nineteenth century."

Gilpin mentions, in his *Forest Scenery*, that often, in his time, a stump of the mountain ash was found in some old burying-place, or near the circle of a druid's temple, the rites of which were formerly performed under its shade. On this passage Sir Thomas Dick Lauder observes that "a branch of the roan tree is still considered good against evil influences in the Highlands of Scotland, and in Wales, where it is often hung up over doorways, and in stables and cow-houses, to neutralise the wicked spells of witches and warlocks." (*Lauder's Gilpin*, vol. i. p. 89.) We have already noticed the custom mentioned by Evelyn, of planting this tree in churchyards in Wales; and he adds that "it is reputed to be a preservative against fascination and evil spirits; whence, perhaps, we call it *witchen*, the boughs being stuck about the house, or used for walking-staffs." In the *Sylvan Sketches* of Miss Kent, the following remarks are quoted on this passage:—"In former times, this tree was supposed to be possessed of the property of driving away witches and evil spirits; and this property is recorded in one of the stanzas of a very ancient song, called *The Laidley Worm of Spindleston Heughs*:—

' Their spells were vain; the boys return'd
To the queen in sorrowful mood,
Crying that "witches have no power
Where there is roan-tree wood."

The last line of this stanza leads to the true reading of a line in Shakspeare's tragedy of *Macbeth*. The sailor's wife, on the witch's requesting some chestnuts, hastily answers, 'A rown tree, witch!' but all the editions have it 'Aroint thee, witch!' which is nonsense, and evidently a corruption." (p. 251.) This reading, however, is not new, as it has been given by several of the commentators on Shakspeare. "Hone, in his *Religious Mysteries*, gives a fac-simile of an old drawing, called the Descent into Hell, in which Our Saviour is represented with a roan tree cross in his left hand, while with the right he appears to draw a contrite spirit from the jaws of Hell." (*Ibid.*, p. 252.) It is remarkable, that nearly the same superstitions should exist also in India, as appears from the following passage from Bishop Heber's *Journal*, &c.:—Near Boitpoor, in Upper India, "I passed a fine tree of the *Mimosa*, with leaves, at a little distance, so much resembling those of the mountain ash, that I was for a moment deceived, and asked if it did not bring fruit? They answered no; but that it was a very noble tree, being called 'the imperial tree,' for its excellent properties: that it slept all night, and wakened, and was alive all day, withdrawing its leaves if any one attempted to touch them. Above all, however, it was useful as a preservative against magic; a sprig worn in the turban, or suspended over the bed, was a perfect security against all spells, the evil eye, &c., insomuch as the most formidable wizard would not, if he could help it, approach its shade. One, indeed, they said, who was very renowned for his power (like *Loorinite* in the *Kehama*) of killing plants, and drying up their sap with a look, had come to this very tree and gazed on it intently: 'but,' said the old man who told me this, with an air of triumph, 'look as he might, he could do the tree no harm;' a fact of which I make no question. I was amused and surprised to find the superstition, which in England and Scotland attaches to the rowan tree, here applied to a tree of similar form. Which nation has been, in this case, the imitator; or from what common centre are all these notions derived?"

Soil and Situation. The mountain ash will grow in any soil, and in the most exposed situations, as it is found on the sea shore, and on the tops of

mountains, in Forfarshire, as high as 2500 ft. Hence it is an excellent tree for plantations intended to resist the sea breeze, or to be placed in exposed situations; but, wherever it is wanted to attain a large size, it ought to be planted in free soil in a moist climate, or near water, and in a situation that is open and airy. Few trees suffer more from extreme heat and drought than the mountain ash.

Propagation and Culture. Plants are almost always raised from seed, which should be gathered as soon as it is ripe, to prevent its being eaten by birds, which are so fond of it as to attack it even before it is ripe. When gathered, the fruit should be macerated in water till the seeds are separated from the pulp, and they may be then sown immediately; but, as they will, in that case, remain 18 months in the ground before coming up, the common mode adopted by nurserymen is, to mix the berries with light sandy soil, and spread them out in a layer of 10 in. or 1 ft. in thickness, in the rotting ground; covering the layer with 2 in. or 3 in. of sand or ashes, and allowing them to remain in that state for a year. They are then separated from the soil by sifting, and sown in beds of light rich soil, being covered a quarter of an inch. The plants having large leaves, the seeds should not be dropped nearer together than 2 in., which will allow the plants to come up with sufficient strength. They may be sown any time from November to February, but not later: they will come up in the June following, and, by the end of the year, the strongest plants will be 18 in. high, and fit to separate from the others, and to plant out in nursery lines.

Statistics. In the environs of London, there are trees from 25 ft. to 30 ft. high, at Syon, Kenwood, and various other places; and many may be seen, of 25 ft. in height, and upwards, in the suburban gardens by the roadsides. In Surrey, at Bagshot Park, 22 years planted, the tree is 25 ft. high; in Durham, at South End, 18 years planted, it is 30 ft. high; in Hertfordshire, at Chesnut, 16 years planted, it is 17 ft. high; in Suffolk, at Finborough Hall, 70 years planted, it is 30 ft. high; in Warwickshire, at Coombe Abbey, 48 years planted, it is 28 ft. high. In Scotland, in Ayrshire, at Barganny, where the tree is indigenous, are many very large specimens; in the village of New Dailly, one has a trunk free from branches to the height of 20 ft., the diameter at the base being 2 ft. 3 in., and at the point where the branches originate 2 ft. 8 in. In Banffshire, at Gordon Castle, it is 30 ft. high, the diameter of the trunk 2 ft. 8 in., in strong loam, on clay in Cromarty, at Coul, 35 ft. high; in Forfarshire, at Old Montrose, 65 years planted, and 50 ft. high, the diameter of the trunk 2 ft. 10 in., and of the head 40 ft.; in Kireudbrightshire, at Cally, is a tree, 25 ft. high, with an orbiculate head 30 ft. in diameter, and branches drooping to the ground. In Ireland, at Dublin, in the Glasnevin Botanic Garden, 35 years planted, the tree is 30 ft. high; in Galway, at Coole, it is 20 ft. high. In Saxony, at Wörlitz, 34 years planted, it is 30 ft. high. In Bavaria, at Munich, in the Botanic Garden, 34 years planted, it is 30 ft. high.

‡ 29. *P. AMERICANA* Dec. The American Service.

Identification. Dec. Prod., 2. p. 637.; Hook. Fl. Bor. Amer., 1. p. 204.; Don's Mill., 2. p. 648.

Synonymes. *Sorbus americana* Ph. Fl. Bor. Amer., 1. p. 341.; Willd. Enum., 520.; *S. americana* var. β Michx. Fl. Amer., p. 230.

Engravings. Wats. Dend. Brit., t. 54.; and the plate of this species in our Second Volume.

Spec. Char., &c. Leaflets acute, almost equally serrated, glabrous, as is the petiole. Pomes globose, of a purplish tawny colour. (*Dec. Prod.*, ii. p. 637.) A tree, closely resembling the common mountain ash; a native of the woods of Canada and Newfoundland. Introduced in 1782, and growing to the height of 15 ft. or 20 ft. It is, apparently, a more robust-growing tree than the European mountain ash, with larger leaves, shining above, and smooth beneath; but it is, in reality, more tender. The young shoots are of a dark purplish colour; and it has small, dark, or purplish red, fruit. Sir W. J. Hooker says of this species, "In the leaves and flowers I can perceive no difference between this and the European *P. aucuparia*;" and Michaux considered it only a variety of that species. Pursh says that the berries are purple, and not scarlet, as in the European mountain ash. Torrey says that the berries are copper-coloured; which agrees better than the description of Pursh with the appearance of those produced by the trees in the Horticultural Society's Garden, and in other gardens in the neighbourhood of London. The tree appears much more tender than the common mountain ash; and, though it has been so many years in the country, we do not know of a large, old, handsome specimen of it any where. It is propagated by grafting on the

common mountain ash. On account of the brilliant colour of the fruit, and the large size of the bunches in which it is produced, this species, or race, well deserves a place in collections.

‡ 30. *P. MICROCARPA* Dec. The small-fruited Service.

Identification. Dec. Prod., 2. p. 636.; Don's Mill., 2. p. 648.

Synonymes. *Sorbus aucuparia* α Michx. *Fl. Bor. Amer.*, 2. p. 291.; *S. micrantha* Dum. *Cours.*, ed. 2. p. 464.; *S. microcarpa* Ph. *Fl. Amer. Sept.*, 1. p. 341.

Spec. Char., &c. Leaflets glabrous, acuminate, unequally incisedly serrated; the teeth tipped with a bristle-like mucro. Petiole glabrous. Pome globose, scarlet. (*Dec. Prod.*, ii. p. 637.) A native of mountains of North America, from Carolina to New Casarca, where it forms a low tree or large shrub, growing to the height of 10 ft. According to Pursh, this species is very distinct from *P. americana*; from which it is distinguished by the young branches being covered with a shining dark brown gloss, and by having small scarlet berries. We think that both this and the preceding sort will ultimately prove only varieties, or races, of *P. aucuparia*. *P. microcarpa* has not yet been introduced into Britain.

‡ 31. *P. SO'RBUS* Gartn. The True Service.

Identification. Gartn. *Fruct.*, 2. p. 45. t. 87.; Dec. Prod., 2. p. 637.

Synonymes. *Sorbus domestica* Lin. *Sp.*, 684.; *Pyrus domestica* Smith in *Eng. Bot.*, t. 350., Wallr. *Ann. Bot.*, 145., Don's Mill., 2. p. 648.; the Whitty Pear Tree, the Sorb Tree; Cormier, or Sorbier cultivé, Fr.; Speyerlingsbaum, or Sperberbaum, Ger.; Sorbo, Ital.

Engravings. Eng. Bot., t. 350.; Gartn. *Fruct.*, 2. t. 87.; our fig. 644.; and the plate in our Sixth Volume.

Spec. Char., &c. Buds glabrous, glutinous, acuminate. Leaflets serrated, villose beneath, but becoming naked when old. Pome obovate, pear-shaped. (*Dec. Prod.*, ii. p. 637.) A tree of the middle size, a native of Europe, chiefly of the middle region, and found also in some parts of Barbary, particularly in the neighbourhood of Algiers. The only plants of the species in its uncultivated state, which we know of in England, are in Wyre Forest and the arboretum at Milford.

Varieties. In *Du Hamel* and the *Dictionnaire des Eaux et Forêts*, eight varieties of the true service are described; but in British gardens only the two following sorts are cultivated:—

‡ P. S. 2 *maliformis* Lodd. Cat., la Corme-Pomme, Fr., has apple-shaped fruit. Of this variety there are trees which bear abundantly in the Horticultural Society's Garden, and in the Hackney Arboretum.

‡ P. S. 3 *pyriformis* Lodd. Cat., la Corme-Poire, Fr., has pear-shaped fruit; and of this also there are fruit-bearing trees in the places above referred to.

Description. A tree, in foliage and general appearance, closely resembling the mountain ash; but attaining a larger size, and bearing much larger fruit, of a greenish brown colour when ripe. In France this tree attains the height of 50 ft. or 60 ft.: it requires two centuries before it reaches its full size; and lives to so great an age, that some specimens of it are believed to be upwards of 1000 years old. It grows with an erect trunk, which terminates in a large pyramidal head. The bark of the trunk is smooth and grey, like that of the mountain ash, in young trees; and that of the smaller branches is slightly reddish; but the bark of the trunk, in old trees, is rough, scaly, and full of cracks, and its colour is a dark brown. This tree is readily known from the mountain ash, in winter, by its buds, which are smooth and green, instead of being downy and black; in the beginning of summer, by its leaflets being broader, downy above, and also beneath; and, in autumn, by its pear or apple shaped fruit, which is four or five times the size of that of *P. aucuparia*, and of a dull greenish brown colour. It is said to be 30 years before it comes into a bearing state when it is raised from the seed; but, when scions from fruit-bearing trees are grafted on seedling plants, or on the mountain ash, they come into bearing in a few years, as in the case of other fruit trees. (*See Gard. Mag.*, iv. p. 487.)

Geography, History, &c. The true service is not found in abundance in any part of the world. There are, perhaps, more trees of it in the middle region of France, and the Alps of Italy, than in all other countries put together; but it is also found in the south of Germany, in some parts of the north of Africa, and in Western Asia. It was formerly said to be a native of different parts of Britain; but in Smith's *English Flora* there is no positive

habitat given, except that of a solitary tree in Wyre Forest, near Bewdley, in Worcestershire. (See p. 23.) This tree (which stands on the property of William Lacon Childe, Esq., of Kinlet, and of which a drawing has been kindly sent to us by the Earl of Mount Norris), is of very great age, and is now in a state of decay. The whitty pear tree, as it is there called, is 45 ft. high; the diameter of its trunk, at 1 ft. from the ground, is 1 ft. 9 in., and that of the head 26 ft. Our engraving of the tree (*fig.* 644.) is to a scale of 1 in. to 12 ft., and the botanical specimen is to a scale of 1 in. to 2 ft. Miller, in 1731, says, "The matured service was formerly said to be growing wild in England; but this, I believe, was a mistake, for several curious persons have strictly searched those places where it was mentioned to grow, and could not find it; nor could they learn from the inhabitants of those countries that any such tree had ever grown there." Miller adds that, though abundant in Italy, where a great variety of sorts are cultivated, yet it is very scarce in

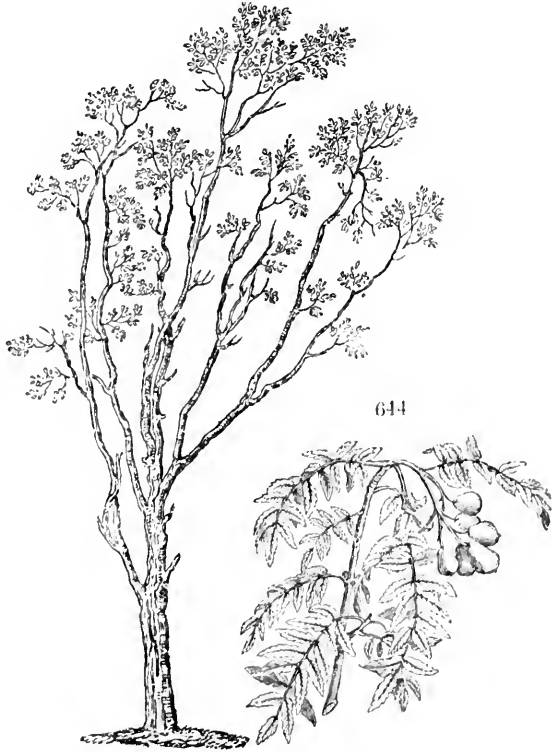

England, "for," he continues, "I have not seen more than one large tree, which was lately growing in the gardens formerly belonging to John Tradescant; which tree was near 40 ft. high, and did produce a great quantity of fruit annually." He afterwards mentions some smaller trees, growing in the garden of Henry Marsh, Esq., at Hammersmith, which produced fruit, from which several young trees have been raised in the London nurseries. In 1752, Miller observes, "There is a great number of large trees of the true service growing wild about Aubigné, in France; whence the late Duke of Richmond [who was also Duc d'Aubigné, and a great lover of plants] brought a great quantity of the fruit, and from the seeds raised a number of young plants at Goodwood, in Sussex." We have repeatedly examined the plantations at Goodwood, in search of *Pyrus Sôrbus*, but have never been able to find a single plant of that species. The tree is tender, when young, even in France; and it is exceedingly difficult to raise in the gardens there. There are but a few specimens of it in England, which are chiefly in the neighbourhood of London; and, for the last 30 years, scarcely any plants of it could be obtained in any of the London nurseries, except at Messrs. Loddiges's, and even there only since the year 1815. The tree appears to have been known to the Greeks and Romans. Pliny mentions four sorts: the pear-shaped, the apple-shaped, the egg-shaped, and a kind that was only used medicinally.

He gives directions for preserving the fruit in two different ways; and says that its medicinal qualities are the same as those of the medlar. Gerard evidently confounds the true service with *P. torminalis*; as does Phillips, in his *Pomarium Britannicum*, when he says that the tree is to be met with in the hedgerows of Kent and the Weald of Sussex, as also in other parts of England, and in Wales.

Properties and Uses. The wood of the true service is the hardest and the heaviest of all the indigenous woods of Europe. It weighs, when dry, no less than 72 lb. 2 oz. per cubic foot. It has a compact fine grain, a reddish tinge, and takes a very high polish; but it must not be employed until it is thoroughly seasoned, as otherwise it is apt to twist and split. It is much sought after, in France, by millwrights, for making cogs to wheels, rollers, cylinders, blocks and pulleys, spindles and axles; and for all those parts of machines which are subject to much friction, and require great strength and durability. In France, it is preferred to all other kinds of wood for making the screws to wine-presses. It is employed for a variety of other purposes in countries where it can be procured. In Britain, the wood is almost unknown; though, if it were to be imported, it might probably be used as a substitute for box. In France, the fruit, when beginning to decay, is brought to table; though it is not highly prized, and is more frequently eaten by the poor than the rich. That it is not much esteemed by the peasants, in the parts of France where the tree abounds, is evident from the expression of "Ils ne mangent que des cornes" being used to designate persons in the last state of destitution and misery. A very good cider, or rather perry, is made from the fruit of the true service, particularly in Brittany, which, however, has a most unpleasant smell. (See *Gard. Mag.*, vol. xi. p. 537.) Medicinally, the fruit is very astringent, and it is used in a state of powder, in wine, to stop fluxes of blood. In Britain, the tree is chiefly to be recommended as one of ornament and rarity; for, though its fruit is, perhaps, not much inferior in taste to that of the medlar, yet it is found to be much more difficult of digestion; hence the French writers say that it is only fit for the most robust stomachs.

Soil and Situation. A good, free, deep, dry soil, and a sheltered situation, are essential, wherever it is attempted to grow this tree in Britain. From the specimens in the neighbourhood of London, it does not appear to suffer from the climate after it has been five or six years planted; but it is rather difficult to establish young plants.

Propagation and Culture. Seeds may be procured in abundance from France; and from them stocks may be raised on which the best fruit-bearing varieties may be grafted. The true service may also be grafted on the pear, the mountain ash, the hawthorn, and other allied species. The graft should be made close to the ground, or even under it, on the root; and care should be taken to retard the scion previously to grafting it, in order that the stock may be somewhat in advance of it. On the whole, the operation requires to be performed with the greatest care; because this is one of the most difficult of all non-resinous trees to graft successfully. We have only seen stools of it in two or three British nurseries; and there the attempts made to raise it from layers, or by inarching, were attended with little or no success. The plants procurable at Messrs. Loddiges afford no exception to this statement, they being almost entirely imported from France. In raising the true service from seed, the French writers direct the plants to be kept in pots for one or two years, and to be put in frames during winter, and not to be planted in their final situation till they are three or four years old. If this is a necessary precaution in France, it must be still more so in England. When the seeds are sown in the autumn, they come up the following spring. The first year they do not grow above 3 in. in height; and at the end of four years they will not have attained a greater height than 1 ft.; but in eight or ten years they will, probably, if they have been carefully treated, be 8 ft. or 10 ft high.

Statistics. In the environs of London, the oldest tree appears to be in a field adjoining the Brompton Park Nursery, where it was probably planted in the time of London and Wise, the field forming at that time part of the nursery; it is about 40 ft. high, with a trunk 18 in. in diameter, and the diameter of the head 45 ft.: it bears abundantly most years, but not every year. At Syon, at Purser's Cross, and at Kew, there are trees from 20 ft. to 30 ft. high, which produce fruit most years; there are also several trees in the arboretum of Messrs. Loddiges, and in the Horticultural Society's Garden, from 15 ft. to 20 ft. high, and from 8 to 12 years planted, which fruit abundantly almost every year. In the Hammersmith Nursery, there is a tree 25 ft. high, which fruits every other year. In Dorsetshire, at Melbury Park, a tree, estimated to be 200 years old, is 82 ft. high; the diameter of the trunk is 3 ft. 4 in., and of the head 36 ft., in dry loam on sand, in a sheltered situation. In Surrey, at Claremont, it is 30 ft. high. In Wiltshire, at Longleat, 40 years planted, it is 32 ft. high; at Bowood, 40 years years planted, it is 37 ft. high, the diameter of the head 34 ft. In Oxfordshire, in the Oxford Botanic Garden, 40 years planted, it is 25 ft. high. In Pembrokehire, at Golden Grove, 30 years planted, it is 30 ft. high. In Radnorshire, at Maeslough Castle, 20 years planted, it is 27 ft. high. In Shropshire, at Kinlet, it is 45 ft. high. In Suffolk, at Ampton Hall, 12 years planted, it is 18 ft. high. In Warwickshire, at Coome Abbey, 60 years planted, and 42 ft. high, the diameter of the trunk 1 ft. 10 in., and of the head 41 ft. In Worcestershire, in Wyre Forest, one of the only indigenous trees of the species known to exist in England; it is of a very great age, in a state of decay, and is about 25 ft. high; at Hagley, 9 years planted, it is 18 ft. high; at Croome, 45 years planted, it is 80 ft. high, the diameter of the trunk 22 in., and of the head 40 ft. In Scotland, in Banffshire, at Gordon Castle, 36 ft. high. In Clackmannanshire, in the garden of the Dollar Institution, 12 years planted, and 18 ft. high. In Perthshire, at Taymouth, 60 years planted, and 37 ft. high, the diameter of the trunk 25 in., and of the head 24 ft.; in the Perth Nursery, 25 years planted, and 22 ft. high; at Kinfauns Castle, 8 years planted, and 12 ft. high. In Ross-shire, at Brahan Castle, 45 ft. high, the diameter of the trunk 2 ft., and of the head 6 ft. In Ireland, in the environs of Dublin, at Terenure, 15 years planted, and 18 ft. high. In Galway, at Coole, 27 ft. high, the diameter of the trunk 2 ft., and of the head 29 ft. In Louth, at Oriel Temple, 20 years planted, and 10 ft. high. In Sligo, at Mackree Castle, 32 ft. high.

P. Sorbus in Foreign Countries. In France, in Paris, in the Jardin des Plantes, 25 ft. high. In the native woods, in most parts of France, it forms a large-headed tree, attaining the height of 60 ft. and upwards. At Verrières, on the estate of Barres, the property of M. Vilmorin, and on some adjoining estates, are numerous trees of this species; one 16 years planted is 22 ft. high; one, which is supposed to be from 150 to 200 years old, is 40 ft. high, with a trunk 2 ft. 6 in. in diameter; another, from 300 to 400 years old, is 36 ft. high, with a trunk 3 ft. in diameter, and the diameter of the head 24 ft.; one, between 700 and 800 years old, is 45 ft. high, with a trunk 4 ft. 6 in. in diameter, at 6 ft. from the ground, and the diameter of the head 50 ft.; another, of the same age, is 40 ft. high, with a trunk 3 ft. 8 in. in diameter, at 6 ft. from the ground; the trunk of this last tree is completely hollow; but it has a regular head, and continues to live, though not to grow with great vigour. At Nantes, trees, 60 years planted, are 50 ft. high, in the gardens in the environs of that town. In Hanover, at Schwobber, it is 30 ft. high. In Saxony, at Wörlitz, 54 years planted, it is 30 ft. high. In Italy, at Monza, 29 years planted, it is 30 ft. high.

‡ 32. *P. LANUGINOSA* Dec. The woolly-leaved Service Tree.

Identification. Dec. Prod., 2. p. 637.; Don's Mill, 2. p. 646.

Synonymes. *P. hybrida lanuginosa Hort.*; *Sorbus lanuginosa Kit.* in Litt., and *Lodd. Cat.*

Engraving. The plate of this species in our Second Volume.

Spec. Char., &c. Buds woolly. Leaflets serrated, woolly beneath. Petiole woolly. Pome globose. A native of ?Hungary. A kind to be farther investigated. (*Dec. Prod.*, ii. p. 637.) The trees of this species in Loddiges's arboretum, and in the Garden of the Horticultural Society, are very distinct from any other sort, and appear to be hybrids between *P. pinnatifida* (p. 915.), and the common mountain ash. The general form of the tree is fastigiate, with numerous parallel upright shoots, as indicated in the plate. The flowers and fruit resemble those of the mountain ash, but are smaller, the flowers are frequently abortive, and the fruit, when it is produced, is generally without seeds. It is a robust, hardy, vigorous-growing tree, which comes early into leaf, and is well deserving of a place in collections. There is a variety of the mountain ash which is somewhat lanuginose in its foliage; but which does not differ sufficiently from the species to render it liable to be confounded with the sort before us. Plants of this variety are also in the Garden of the Horticultural Society.

‡ 33. *P. SPURIA* Dec. The spurious Service Tree.

Identification. Dec. Prod., 2. p. 637.; Don's Mill, 2. p. 649.

Synonymes. *P. hybrida Mœnch Weiss.*, t. 6., on the authority of *Willd. Sp.*, 2. p. 1022.; *Sorbus spuria Pers. Syn.*, 2. p. 39.; *Mespilus sorbifolia Poir. Suppl.*, 4. p. 72.; *P. sorbifolia Bosc.* and *Wats. Dend. Brit.*, t. 53., but not of Smith; ? *P. sambucifolia Cham.*, and *Don's Mill.*, 2. p. 648.

Engravings. *Mœnch Weiss.*, t. 6., on the authority of *Willd. Sp.*, 2. p. 1002.; *Wats. Dend. Brit.*, t. 53.; *Bot. Reg.*, t. 1196.; our *fig.* 645; and the plate in our Second Volume.

Spec. Char., &c. Leaflets ovate, crenate; 3 pairs, with an odd one, which is longer than the others: all are pinnate beneath. Petiole gland-bearing upon the upper side. Styles 5. Intermediate, and perhaps a hybrid, between *P. aucuparia* and *P. arbutifolia*. (*Dec. Prod.*, ii. p. 627.) The trees bearing this name in Messrs. Loddiges's arboretum, and in the Garden of the



Horticultural Society, have upright slender branches; glabrous green leaves, somewhat like those of the elder; and small black fruit, like those of *P. arbutifolia*. It is a very distinct kind, and well deserves a place in collections. It is probably the same as *P. sambucifolia* of Cham. in *Lim.*, ii. p. 36., and of *Don's Mill.*, ii. p. 648., which is stated to be a native of Kantschatka. There are fine specimens of this tree in the Horticultural Society's Garden, and one at Syon which is 12 ft. high. In the *Bot. Reg.*, t. 1196., it is stated that the figure of this species in *Watson* is by no means that of *P. sorbifolia*, but is that of *P. pinnatifida*; but this appears to us a mistake, since *P. pinnatifida* has red fruit, and the figure in *Dendrologia* has black fruit, with the leaves answering to the specific description given above, and to the plants under this name in the Horticultural Society's Garden, and at Messrs. Loddiges.

Variety.

‡ *P. s. 2 pèndula* Hort., *Sórbus híbrida pèndula* Lodd. *Cat.*, *P. spùria sambucifòlia* Hort. *Brit.*, and the plate of this sort in our Second Volume, has pendulous shoots, and is a very distinct and most interesting kind. There are fine low trees of it in the Horticultural Society's Garden; and, if grafted 10 ft. or 12 ft. high, instead of only 3 ft. or 4 ft., as it is there, it would form one of the most beautiful of pendulous trees. It is prolific in flowers, and dark purple fruit; and the leaves die off of an intensely dark purplish red.

App. i. *Additional Species of Pyrus belonging to the Section Sórbus.*

P. foliolosa Wall. *Cat.*, p. 677.; *Pl. Asiat. Rar.*, 2. p. 81., t. 189.; is a tree growing to the height of 20 ft., with pinnate leaves, and elliptic-lanceolate, mucronate, leaflets, pubescent beneath; with white flowers, succeeded by small roundish red fruit.

P. hircina Wall. *Cat.*, p. 675., and *Don's Mill.*, 2. p. 648., is a native of Nepal, with pinnate leaves, and numerous leaflets, rusty beneath; with red fruit, about the size of those of the common mountain ash.

Other Sorts. There are some other names in the nursery catalogues, which are probably synonyms to some of the preceding sorts; but, at all events, we can make no use of them here; the species and varieties of this section being, as we have already observed, in a state of great confusion.

§ vii. *Adenórachis* Dec.

Sect. Char. Petals spreading, each with a claw, and a concave limb. Styles 2—5. Pome globose. Leaves simple, the midrib bearing glands on its upper surface (which is the character expressed in the sectional name). Flowers in branched corymbs. Deciduous shrubs, natives of North America; growing to the height of 4 ft. or 5 ft., and prolific in flowers, followed by red, dark purple, or black, fruit. They are all readily propagated by division, by suckers, or by grafting on the common hawthorn. This section is so unlike the others in habit and general appearance, that it would be much more convenient to have it as a distinct genus; say *Arònia*, as it was before the change referred to in p. 879.

34. *P. ARBUTIFOLIA* L. *fl.* The Arbutus-leaved Aronia.

Identification. Lin. *fil. Suppl.*, 256.; Dec. *Prod.*, 2. p. 637.; *Don's Mill.*, 2. p. 649.

Synonymes. *Cratægus pyrifolia* Lam. *Dict.*, 1. p. 83.; *Arònia pyrifolia* Pers. *Syn.*, 2. p. 39. ? *Cratægus serrata* Poir. *Suppl.*, 1. p. 292.; *Mèspilus arbutifolia* Schmidt *Arb.*, t. 86., *Mill. Dict.*, t. 109.

Engravings. Schmidt *Arb.*, t. 86.; and our *fig.* 646.

Spec. Char., &c. Leaves obovate, lanceolate, acute, crenate, tomentose beneath, especially when young, the midrib in each glandulous above. Calyx

tomentose. Pome dark red or purple. (*Dec. Prod.*, ii. p. 637.) A deciduous shrub, a native of North America; introduced in 1700, and growing to the height of from 4 ft. to 6 ft. It is frequent in collections, and known in the nurseries under the name of *Méspilus arbutifolia*. It is prolific in flowers, which are produced in May, and which are followed by dark red or purple fruit, which, when not eaten by birds, will remain on the bushes till the following April or May, when the plant is again in flower. This species, whether as a bush, or grafted standard high on the common thorn, is highly ornamental in spring, when it is covered with its profusion of white flowers; in autumn, when its foliage assumes a deep red or purple; and in winter, after the leaves have dropped, when it is still enriched with its persistent fruit. It is propagated by layers, suckers, or seeds; but most frequently by suckers. There was, in 1835, a remarkably fine plant of this species, grafted standard high, in Knight's Exotic Nursery; its branches hung down gracefully to the ground, not in one mass, but in varied tufts; and their appearance in autumn, when they were of an intensely purple red, was beyond expression interesting and beautiful. Plants, in the London nurseries, are from 9d. to 1s. each; at Bollwyller, 1 franc; and at New York, 25 cents.



Varieties.

- ✳ P. a. 2 *intermedia* Lindl. (*Hort. Trans.*, vii. p. 229.; *Don's Mill.*, ii. p. 649.) has the fruit globose and brown.
- ✳ P. a. 3 *serotina* Lindl. (*Hort. Trans.*, l. c.; *Don's Mill.* l. c.) has the leaves shining above, and velvety beneath; and the fruit late, and party-coloured.

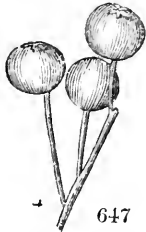

- ✳ P. a. 4 *pumila*, *Méspilus pumila* Lodd. *Cat.*, (*Krause*, t. 86., and our *figs.* 647. and 648.) appears to be different from the two preceding varieties. It is a low plant, seldom exceeding 1 ft. or 18 in. in height, and rooting at the joints. The fruit is intermediate in colour between *P. arbutifolia* and *P. melanocarpa*, being of a reddish black.



- ✳ 35. *P. (A.) MELANOCA'RPA* W. The black-fruited Aronia.

Identification. Willd. *Enum.*, 525.; *Dec. Prod.*, 2. p. 637.; *Don's Mill.*, 2. p. 649.

Synonymes. *P. arbutifolia* β *Willd. Sp.*, 2. p. 1013.; *Aronia arbutifolia* *Pers. Syn.*, 2. p. 39.

Engravings. Schmidt *Arb.* t. 86.; *Krause*, t. 79.; and our *fig.* 649.

Spec. Char., &c. Leaves obovate-oblong, acuminate, serrated, glabrous beneath; the midrib glandulous above. Corymb more crowded than in *P. arbutifolia*. Calyx glabrous. Pome black. (*Dec. Prod.*, ii. p. 637.) A native of North America, from Canada to Virginia, and in the mountains of Carolina; and, judging from the plants in the Horticultural Society's Garden, and in the arboretum of Messrs. Loddiges, nothing more than a variety of *P. arbutifolia*. This variety, like all the others, when grafted standard high on the common Hawthorn, forms a truly interesting pendulous, and at the same time picturesque, tree; and we can scarcely sufficiently recommend it for small shrubberies and suburban gardens. As its berries are not so greedily eaten by birds as those of most of the other Rosaceæ, in mild winters they remain on till the following summer, and mix beautifully with the flowers in June.

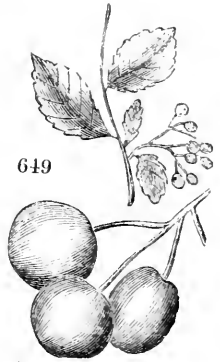

Variety.

- ❖ *P. (a.) m. 2 subpubescens* Lindl. (*Hort. Trans.*, vii. p. 232., *Don's Mill.*, ii. p. 649.) has the leaves, when young, tomentose beneath, but glabrous in the adult state.

- ❖ 36. *P. (A.) FLORIBUNDA* Lindl. The abundant-flowered Aronia.

Identification. Lindl. *Hort. Trans.*, 7. p. 230.; Lindl. *Bot. Reg.*, 1006.; *Don's Mill.*, 2. p. 649.
Engraving. Lindl. *Bot. Reg.*, t. 1006.

Spec. Char., &c. Branches cinereous, reclinate. Leaves oblong-lanceolate, acute, on long petioles, tomentose beneath, as well as the calyxes. Fruit spherical. Corymbs many-flowered, and longer than the leaves. (*Don's Mill.*, ii. p. 649.) Native of ? North America. Flowers white. Fruit black. A low hardy shrub, with pendulous branches; flowering in May and June; and prolific in dark purple fruit. The leaves die off of a purplish red; and the whole plant, from the time of its leafing till it becomes naked, is highly interesting and ornamental. Unless grafted standard high, it forms a drooping orbicular bush, of 3 ft. or 4 ft. in diameter.

- ❖ 37. *P. (A.) DEPRESSA* Lindl. The depressed Aronia.

Identification. Lindl. *Hort. Trans.*, 7. p. 230.; *Don's Mill.*, 2. p. 649.

Spec. Char., &c. Stems humble, reclinate. Leaves oblong, obtuse, tomentose beneath, as well as the calyxes. Fruit pear-shaped. Corymbs length of the leaves. (*Don's Mill.*, ii. p. 649.) Native of North America. Flowers white. Fruit dark purple. A shrub, growing from 1 ft. to 2 ft. in height, and flowering in May. It is evidently a variety, or modification, of the preceding sort; and, from its profusion of flowers and fruit, and the purple hue of its foliage, it is highly ornamental.

- ❖ 38. *P. PUBENS* Lindl. The downy-branched Aronia.

Identification. Lindl. *Hort. Trans.*, 7. p. 232.; *Don's Mill.*, 2. p. 649.

Spec. Char., &c. Stem erect. Branches pubescent. Leaves oblong or obovate, abruptly acuminate, smooth. Fruit spherical, and, as well as the calyxes, quite glabrous. Corymbs loose, and many-flowered. (*Don's Mill.*, ii. p. 649.) Native of North America. Flowers white. Fruit round, large, and dark purple. Both this and the following kind have the robust foliage and habit of *P. Chamæspilus*. A shrub, growing to the height of 4 ft. or 5 ft.; introduced in 1810, and well deserving a place in collections.

§ 39. *P. GRANDIFOLIA* Lindl. The large-leaved Aronia.

Identification. Lindl. Hort. Trans., 7. p. 232; Lindl. Bot. Reg., 1154; Don's Mill., 2. p. 649.
Engravings. Bot. Reg., t. 1154; and our fig. 650.

Spec. Char., &c. Stem erect, and, as well as the branches, smoothish. Leaves oblong, or obovate, acute, glabrous. Fruit spherical, and, as well as the calyxes, glabrous. Corymbs few-flowered, coarctate. Fruit with a villous disk. (*Don's Mill.*, ii. p. 649.) Native of North America; introduced in 1810, and flowering in May and June. Its flowers are white, its fruit dark purple. A shrub, growing from 4 ft. to 5 ft. high; bearing a profusion of flowers, and dark purple fruit; and, on that account, and also on account of the purple tinge of its leaves, highly ornamental. Dr. Lindley considers it as the most valuable species of this division of *Pyrus* that has hitherto been described.



650

§ viii. *Chamæspilus* Dec.

Sect. Char. Petals upright, conniving, concave. Styles 2. Pome ovate. Leaves simple, glandless. Flowers in a capitate corymb. (*Dec. Prod.*, ii. p. 637.)

§ 40. *P. CHAMÆSPILUS* Lindl. The dwarf Medlar.

Identification. Lindl. in Lin. Soc. Trans., 13. p. 98; Dec. Prod., 2. p. 637; Don's Mill., 2. p. 649.
Synonymes. *Crataegus Chamæspilus* Jacq. Austr., t. 231; *Mespilus Chamæspilus* Lin. Sp., 685; *Sorbus Chamæspilus* Crantz Austr., 83. t. 1. f. 3; the bastard Quince.
Engravings. Jacq. Austr., t. 231; Crantz Austr., 83. t. 1. f. 3; and our fig. 651.

Spec. Char., &c. Leaves ovate, serrated, glabrous, except bearing on the under surface, when young, down, which is deciduous. Flowers white, tinted with rose. (*Dec. Prod.*, ii. p. 637.) A shrub, a native of rough mountainous places in Europe; growing to the height of 5 ft. or 6 ft., and flowering in May and June. It was introduced in 1683, and is occasionally met with in collections. There are plants of it at Messrs. Loddiges, and in the Camberwell Nursery, at 1s. 6d. each; and as the plant forms a compact bush, and flowers and fruits in the greatest abundance, it merits to be much more extensively introduced into collections than it appears to have hitherto been. It grafts beautifully on the common hawthorn; and, indeed, whoever has a quickset hedge may have a collection of all the species of this genus.



651

App. i. *Species of Pyrus not sufficiently known.*

P. alnifolia Lindl. in Lin. Trans., 13. p. 98, is a native of North America, at Fort Mandon, with glabrous roundish leaves, feather-nerved, and rather glaucous beneath. The fruit black and sugary.

P. tomentosa Dec. Prod., 2. p. 637; *Malus tomentosa* Dum. Cours., ed. 2. 5. p. 438; is a native of Siberia, said to be allied to *P. baccata*; but the flowers, as well as fruit, are unknown.

P. rubicunda Hoffmans. (*Verz.*, 1824, p. 192; *Dec. Prod.*, 2. p. 637.) has the leaves oval-acuminate, with a fruit partly red and partly yellow, somewhat resembling the common apple, but covered with a glaucous bloom. Its native country is unknown.

GENUS XIX.

CYDO'NIA Tourn. THE QUINCE TREE. *Lin. Syst.* Icosándria
Di-Pentagýnia.

Identification. Tourn. Inst., 632. t. 405.; Pers. Syn., 2. p. 40.; Lindl. in Lin. Soc. Trans., 13. p. 97.; Dec. Prod., 2. p. 638.; Don's Mill., 2. p. 650.

Synonyme. Pýrus sp. *Lin.*

Derivation. From its native place, *Cydon*, in Candia.

Description, &c. Low deciduous trees or shrubs, natives of Europe and Asia; easily propagated by layers, or by grafting on the common thorn.

‡ 1. *C. VULGA'RIS Pers.* The common Quince Tree.

Identification. Pers. Syn., 2. p. 40.; Dec. Prod., 2. p. 638.; Don's Mill., 2. p. 650.

Synonymes. Pýrus Cydonia *Lin. Sp.*, 687., *Jacq. Austr.*, t. 342.; *C. europæa Sav. Alb. Tosc.*, 1. p. 90.

Engravings. *Jacq. Austr.*, t. 342.; *Sav. Alb. Tosc.*, 1. p. 90.; and our plate in Vol. II.

Spec. Char., &c. Leaves ovate, obtuse at the base, entire, tomentose beneath. Calyx tomentose; its lobes serrulated, and a little leafy. Stamens in one row. A native of rocky places and hedges in the south of Europe. (*Dec. Prod.*, ii. p. 638.)

Varieties. In nursery catalogues, and also in botanical works, there are generally five or six varieties designated and described; but Mr. Thompson has judiciously remarked that there are, in reality, only the three following:—

- ‡ *C. v. 1 pyriformis* Hort. has the fruit pear-shaped, and may be considered as the normal form of the species.
- ‡ *C. v. 2 maliformis* Hort. has the fruit apple-shaped, and requires to be continued by extension; because it is found that seedling plants from this variety and the preceding one are not quite true to their kinds; most frequently producing pear-shaped fruit.
- ‡ *C. v. 3 lusitânica* Du Ham. has broader leaves, and larger fruit, than the two preceding kinds; and, being of more vigorous growth, it is better adapted for being used as a stock for pears. It is not so good a bearer as either of the other two varieties; and the fruit is not of so deep an orange. See *Hort. Soc. Cat. of Fr.*, 2d edit., p. 155.

Description. The quince is a low tree, with a crooked stem, and tortuous rambling branches: the bark is smooth and brown, approaching to black; the leaves are roundish or ovate; dusky green above, and whitish underneath. The flowers are large, with the petals pale red or white, and the sepals of the same length as the petals. The flowers are succeeded by large fruit, globular, oblong, or pear-shaped, of a rich yellow or orange colour when ripe, and emitting a particularly strong, and to some a disagreeable, odour, somewhat of the nature of that of apples. According to Gerard, the fruit is hurtful to the head by reason of its strong smell; and it has, when eaten from the tree, "a kind of choking taste." The tree is of moderately rapid growth when young; attaining, in four or five years, the height of 6 ft. or 8 ft.; and, in ten or twelve years, the height of 15 ft.: after which it continues to increase in width of head only; being very seldom found higher than 15 ft. or 20 ft.

Geography, History, &c. The tree is supposed to have been originally a native of Cydon, a city in Crete, or Candia, as it is now called; but it is much more probable that it was only first brought into notice in that island. It is at present considered indigenous to the south of France, and to Germany, on the banks of the Danube. It is generally found in a moist soil, and in a situation that is somewhat shady. The quince was known to the Greeks and Romans, and by both nations was held in high estimation. Columella says, "Quinces not only yield pleasure, but health;" and Pliny mentions many

kinds, some as growing wild in Italy; and others, that were in cultivation, and so large, that they weighed the boughs on which they grew down to the ground: he also mentions that some were of a green, and others of a golden, colour. The only kind that was eaten raw, he says, "was the variety grafted on the small-fruited quince. . . . All kinds of this fruit," he continues, "are grown in boxes, and placed within the waiting-chambers of our great personages, in which men wait to salute these personages as they come forth every morning." It appears, from the same author, that quinces were used to decorate the images of the gods, which were placed, in sleeping-chambers, round the beds; whence it follows, that the Romans did not think that there was anything either injurious or unpleasant in the smell. Pliny gives directions for preserving the fruit, by excluding the air from them, or boiling them in honey; or, by plunging them into boiling honey; a practice in use with this and other fruits in Genoa at the present day. The date of the introduction of the quince into Britain is unknown. Gerard and Tusser mention it; the former, as growing in gardens and orchards, and as being "planted oftentimes in hedges and fences belonging to gardens and vineyards:" from which we may infer, that it was by no means rare in his time; and, indeed, in all probability, it has existed in this country from the time of the Romans. By some, the tree is considered as indigenous; and Phillips states that quinces grow in such abundance in some parts of the Wealds of Sussex, as to enable private families to make quince wine in quantities of from 100 to 200 gallons in a season. (*Pom. Brit.*, p. 327.) This wine, it is said, is greatly esteemed for asthmatic persons.

Properties and Uses. The wood of the quince is seldom found of such dimensions as to be applied to any purpose in the arts; and the tree is therefore cultivated entirely for its fruit, or as stocks on which to graft the pear. The fruit is seldom eaten by itself, and never raw; but is generally made into marmalade, or mixed with apples in tarts. Medicinally, it is considered astringent and stomachic. Quince wine is made with sugar and water, in the same manner as other fruit wines are in England; the quinces being first ground, or beaten into a pulp. The Portugal quince is considered the best variety for marmalade, as its pulp turns to a fine purple or crimson, when stewed or baked; and becomes much softer, and less austere, than that of the other varieties. This is also the best variety to cultivate for stocks, as its growth is less contracted than that of the common quince. Independently altogether of its value as a fruit tree, or of the young plants for stocks, the quince richly deserves a place in ornamental plantations, on account of the velvety surface of its leaves, its fine, large, pale pink flower, and, above all, its splendid golden fruit, which, when ripe on the tree, reminds us of the orange groves of Italy, and may very well justify the conjecture that the quince was the true golden apple of the Hesperides. For ornamental purposes, the common pear, and the apple-shaped varieties, are much to be preferred to the Portugal quince; because the latter is not such a good bearer, and its fruit is not of such a deep orange colour.

Poetical and mythological Allusions. The quince was considered by the ancients to be the emblem of love, happiness, and fruitfulness: it was dedicated to Venus, and the temples of that goddess at Cyprus and Paphos were decorated with it. The nuptial chambers of the Greeks and Romans were decorated with the fruit; and the bride and bridegroom also ate of it as soon as the marriage ceremony was performed. It has been supposed to be the golden fruit of the Hesperides; and a statue of Hercules, discovered at Rome, with three quinces in one of the hands has been referred to as a proof. The Farnese Hercules has, however, apples in his hand. It has also been alleged, that the golden fruit thrown by Hippomenes to Atalanta were quinces, and that the fruit of the forbidden tree, which the Jewish traditions expressly describe as golden, was a quince.

Soil and Situation. The quince prefers a moist but free soil, near water, and a situation open, but sheltered. In dry soil, neither the tree nor the fruit

attains any size; and, in situations exposed to high winds, the fruit will not remain on the tree till ripe. The finest specimens of quince trees in this country are to be found in old orchards, adjoining ponds; it being customary, formerly, to plant a quince tree in every apple orchard.

Propagation and Culture. Seeds are ripened as readily by the quince as by the apple and pear; but the quickest way of raising plants is by layers, which is that generally adopted in British nurseries. The quince will also grow by cuttings, put in in autumn, in moist sandy soil. The tree, when once planted out, requires very little attention, beyond that of removing the suckers from the root, and the side shoots from the main stem. To have the fruit of a large size, the head of the tree ought to be kept open by thinning out the shoots; and the fruit ought also to be thinned out, leaving no more on the tree than it can well mature.

Statistics. In the environs of London, there are trees from 15 ft. to 20 ft. high, in various market-gardens. An old tree, in the Garden of the Horticultural Society, is 12 ft. high. In Radnorshire, at Maeslough Castle, there is a tree 21 ft. high, the diameter of the trunk of which is 10 in., and of the head 22 ft. In Rutlandshire, at Belvoir Castle, 26 years planted, it is 15 ft. high. In Staffordshire, at Rolleston Hall, 50 years planted, it is 20 ft. high, in moist soil on marl. In Suffolk, at Fimborough Hall, 60 years planted, it is 16 ft. high, the diameter of the trunk 1 ft. 4 in., and of the head 20 ft. In Wiltshire, at Longford Castle, it is 15 ft. high, in light loam on moist gravel. In Worcestershire, at Hagley, 10 years planted, it is 11 ft. high.

‡ 2. *C. SINE'NSIS* Thoun. The China Quince Tree.

Identification. Thoun Ann. Mus., 19. p. 145. t. 8. and 9.; Dec. Prod., 2. p. 638.; Don's Mill., 2. p. 650.

Synonyme. *Pyrus sinénsis* Poir. *Suppl.*, 4. p. 452.

Engravings Ann. Mus., 19. t. 8. and 9.; and the plate of this tree in our Second Volume.

Spec. Char., &c. Leaves ovate, acuminate at both ends, acutely serrated when young, a little villose, and when adult, glabrous. Stipules oblong-linear, serrated, the teeth glanded. Flowers rosy, becoming red. Calyx glabrous, its lobes serrulated, and a little leafy. Stamens in one row. Fruit egg-shaped, large, hard, almost juiceless, and greenish. Seeds in each cell about 30, with many abortive. (*Dec. Prod.*, ii. p. 631.) A very handsome low tree, very distinct in appearance from the common quince, from the shining surface of its leaves, and the regular serratures of their margins. It is a native of China, where it grows to the height of 20 ft., flowering in May and June, and producing egg-shaped greenish fruit, which, as before stated, is hard, and nearly dry. There are plants in the Horticultural Society's Garden from 8 ft. to 10 ft. high; and it is propagated in the principal London nurseries.

‡ 3. *C. JAPÓ'NICA* Pers. The Japan Quince Tree.

Identification. Pers. Syn., 2. p. 40.; Dec. Prod., 2. p. 638.; Don's Mill., 2. p. 650.

Synonyms. ? *Pyrus japónica* Thunb. *Fl. Jap.*, 207., and *Bot. Mag.*, t. 692.; *Chænomèles japónica* Lindl. *Lin. Trans.* 13. p. 98.

Engravings. *Bot. Mag.*, t. 692.; Morris *Fl. Comp.*, t. 1.; and our *fig.* 652.

Spec. Char., &c. Leaves oval, somewhat cuneate, crenately serrated, glabrous upon both surfaces. Stipules kidney-shaped, and serrated. Flowers mostly 2—3 together, rarely solitary. Calyx glabrous; its lobes short, obtuse, entire. Stamens in two rows. (*Dec. Prod.*, ii. p. 638.) A shrub, a native of Japan and China; growing to the height of 5 ft. or 6 ft., and flowering the greater part of the year, more especially if supplied with water during the hottest months. It was introduced in 1815, and has spread rapidly throughout British gardens, in which it is generally known by the name of the *Pyrus japónica*. It is one of the most desirable deciduous shrubs in cultivation, whether as a bush in the open lawn, trained against a wall, or treated as an ornamental hedge plant. It has also been trained up with a single stem as a standard; and, in this character, its pendent branches



and numerous flowers, give it a rich and striking appearance, especially in early spring. It is difficult to unite with its congeners by grafting; but, if it could be grafted standard high on the pear, the hawthorn, or even on the common quince, it would form a most delightful little tree. It has ripened fruit both as a bush, and against a wall; but the fruit, even when ripe, is unfit to eat, though it has so fragrant a smell as to induce some persons to keep it among their clothes. The plant is readily propagated by layers or suckers, and it also grows by cuttings. In the *Romance of Nature*, a very elegant work on flowers, by Miss Twamley, the authoress, speaking of this shrub, calls its flowers "fairy fires,"

"That gleam and glow amid the wintry scene,
Lighting their ruddy beacons at the sun,
To melt away the snow. See how it falls
In drops of crystal from the glowing spray,
Wreathed in deep crimson buds—the fairy fires."

Varieties.

- ✱ *C. j.* 2 *flore albo* has cream-coloured, or very pale red, flowers, and forms a very distinct kind when in blossom.
- ✱ *C. j.* 3 *fl. semi-pleno* has red flowers, somewhat semidouble. There are plants of this kind in the Kensington Nursery.

Statistics. In the environs of London, trained against a wall, it is, in various places, from 12 ft. to 15 ft. high. In Worcestershire, at Croome, 20 years planted, it is 15 ft. high against a wall. In Scotland, it grows, and flowers freely, against a wall at Thainston, in Aberdeenshire; at Gordon Castle, in Banffshire; at Coul, in Ross and Cromarty; and at Dunrobin Castle, in Sutherlandshire. It grows well, and flowers freely, in every part of Ireland.

App. i. Other Species of *Cydônia*.

C. Sumbóshia *Hamilt.* in *D. Don Prod. Fl. Nep.*, p. 237., and *Don's Mill.*, 2. p. 650., is a native of Nepal, with cordate entire leaves, and fruit attenuated at the base, like that of the *Cydônia vulgaris*.

App. I. Half-hardy Species of *Rosàcea*, § *Pòmea*, not belonging to any of the Genera containing hardy Species.

Raphiòlepis (from *raphis*, a needle, and *lepis*, a scale; in reference to the narrow subulate bracteas, *Lindl.*) is a genus the species of which are evergreen trees or shrubs, natives of China, with crenulated, coriaceous, reticulated leaves, and terminal racemes of white flowers. Judging from the species already in the country, they are probably all tolerably hardy.

R. indica *Lindl.* in *Lin. Trans.*, 13. p. 105., Dec. Prod., ii. p. 630., and *Don's Mill.*, ii. p. 601.; *Cratægus indica* *L.*, *Bot. Mag.*, t. 1726., and our *fig.* 653.; is a native of India and China, introduced in 1806, which will stand in the open air, in warm sheltered situations, near London, as a bush; but which is safest when grown against a wall. In its native country it forms a low tree; but in British gardens it is an evergreen shrub, flowering from February to August. Dr. Sims considers it to bear considerable affinity in habit to *Amelánchier vulgaris* and *A. Botryàpium*. (*Bot. Mag.*, t. 1726.) There are plants of it in the Botanic Garden at Kew, which have stood out since 1823; and in the Horticultural Society's Garden, which were planted out in 1831.



R. salicifolia *Lindl. Bot. Reg.*, t. 651., and our *fig.* 654., is a native of China, with lanceolate leaves, which was introduced in 1824, and which has stood out in the Botanic Garden at Kew since 1823.

R. rubra *Lindl. Coll.*, No. 3. t. 3., *Don's Mill.*, 2. p. 602.; *Cratægus rubra* *Lour.*; *Méspilus sinénsis* *Poir.*; is a native of China and Cochín-China, with ovate-lanceolate leaves, and reddish flowers. It is said to be a tree growing to the height of 30 ft. It was introduced in 1820, and is probably as hardy as the other species. A plant in the Horticultural Society's Garden has stood out against a wall since 1831.

R. phaeostémon *Lindl. Coll.*, No. 3., and *Don's Mill.*, 2. p. 601.; *R. indica* *Bot. Reg.*, t. 468.; is a native of China, with lanceolate leaves, white petals, and brown filaments. It is said to have been introduced in 1820; but we have not seen the plant.

R. Loureiri Spreng., *Don's Mill.*, 2. p. 601; *Cratægus indica* Lour. *Coch.*, p. 319.; is a native of Cochinchina, where it grows to the height of 30 ft., and produces edible fruit.

R. spirâlis Don's Mill., 2. p. 602.; *Méspilus spirâlis* Blume *Bijdr.*, p. 1102.; is a tree, a native of China, with cuneate-oblong leaves.

Eriobótrya (from *erion*, wool, and *botrus*, a bunch of grapes; in reference to the fruit and flowers, which are in bunches, and woolly) Lindl.; *Dec. Prod.*, ii. p. 631.; *Don's Mill.*, ii. p. 602. This is a genus of Japan trees, evergreen in their foliage, which is large; and, independently of their flowers, strikingly picturesque and ornamental. The species are all readily propagated by grafting on the common hawthorn, or on the pear or quince.

E. japonica Lindl.; *Méspilus japonica* Thunb. *Jap.*, 206., *N. Du Ham.*, iv. p. 146. t. 39.; Lou-Koet, *Japan*. (corrupted to Loquat, the common English name of the plant); *Cratægus Bibas* (Bibasis, the Portuguese name) Lour. *Coch.*, p. 319., *Bot. Reg.*, t. 365., and our *figs.* 655., and 656.) has long, broad, wrinkled, elliptic, serrated leaves, tomentose beneath; and terminal panicles of white flowers, which are



654

succeeded by pear-shaped, yellow, downy fruit, about the size of large gooseberries. It is a native of China and Japan, where it is cultivated as a fruit tree, and also as being ornamental; and where it grows to the height of 20 ft. or 30 ft. It was introduced into Europe in 1784, according to the *Nouv. Du Hamel*; and it is found, more especially when grafted on the common thorn, to stand the winters both of Paris and London against a wall, with very little protection. It has also produced fruit

at different places in England, under glass, which, when well ripened in a stove, is not much inferior in taste and flavour to an ordinary plum. At Blithfield, in Staffordshire, the loquat was fruited in pots, which were removed from the stove to the open air, and kept there from July to the middle of October, in order to give them a period of repose equivalent to a winter in their native country. After this, the plants were replaced in the stove, where they began to show flower about the end of December, and ripened their fruit in March or April. (See *Hort. Trans.*, vol. 3. t. 11., and *E. of G.*, edit. 1835, p. 981.) When the loquat is to be grown for its fruit, it is suggested, in the *Nouv.*



656

Du Hamel, that the *Cydônia vulgâris* would form a better stock for it than the *Cratægus Oxyacantha*; because the nature of the wood of the former, and its rate of expansion, come nearer to those of the loquat than those of the latter do. If it were thought worth while to grow the plant for its fruit, the first step would be to procure a very superior variety either from China, or by raising and fruiting some hundreds of seedlings in the open air, in Italy or Spain, and selecting those plants which produced the largest and best-flavoured fruit. These could be perpetuated by grafting on the quince, or on seedlings of the species; and the plants might be trained against a wall or on a trellis under glass, or against a flued wall in the warmer parts of the south of England, and treated as the orange tree is there. To cultivate, for its fruit, any variety that may accidentally have fallen into the hands of the

cultivator, or that he may procure from any British garden or nursery, is not to do justice to the loquat, since many of the plants to be procured in nurseries have been raised from seed in this country; and these seedlings, as in the case of seedlings of every other tree, doubtless differ considerably in the size and quality of their fruit, as well as they do in their leaves. It should not be forgotten, that even the common white beam tree (*Pyrus Aria*), and the common mountain ash (*P. aucuparia*), in a wild state, differ exceedingly in the quality of their fruit; and that, while some trees produce such as are large, mild, mealy, or sweet, those produced by others are extremely harsh and austere. The same may be said of the fruit of all rosaceous plants, and, we believe, also of all others.

E. elliptica Lindl. Lin. Trans., 13. p. 102., Dec. Prod., 2. p. 631., Don's Mill., 2. p. 603.; *Mespilus Cida* Hamilt. MS. in D. Don Prod. Fl. Nep., p. 238.; is a native of Nepal, and has leaves flat and elliptic, and downy yellow fruit. It was introduced in 1823; but we have not seen the plant.
E. cordata Lindl., *E. obtusifolia* Dec., and *E. chinensis* G. Don., are species not yet introduced (See Don's Mill., 2. p. 603.)

Kagenéckia (in honour of *F. De Kageneck*, ambassador from Holland to Spain) Ruiz et Pav. Fl. Per. Prod., t. 37., Don's Mill., ii. p. 522., is a genus of South American trees or shrubs, of which only one species is as yet introduced.

K. cratægoides D. Don; *K. cratægifolia* Lindl. Bot. Reg., t. 1836., and our fig. 657.; is an evergreen shrub, with oval-lanceolate, smooth, glaucous green leaves, and cratægus-like flowers; the male and female flowers being produced separately on the same plant. The leaves are intensely bitter; and they are used by the inhabitants of Chili to cure intermittent fevers. The tree is said to grow to the height of 60 ft. in its native country, and to produce a valuable timber. A plant of this species, in the Horticultural Society's Garden, has stood against a wall since 1831; and its foliage has not been in the slightest degree injured by the late severe winter; and it is now (May 1. 1836) coming into flower. In all probability, this plant will soon be added to our hardy evergreen shrubs or trees. It strikes readily by cuttings, and it may probably be grafted on the common hawthorn.

K. oblonga Ruiz et Pav., and *K. lancolata* and *K. glutinosa* of the same authors, are species from the mountains of Chili and Peru, which have not yet been introduced. If they prove as hardy as *K. cratægoides* seems likely to do, they will be valuable additions in an ornamental point of view, and perhaps, also, as supplying a medicinal bitter.

App. II. Half-hardy Species of Rosaceæ, belonging to the Suborder Sanguisorbeæ.

Margyricarpus setosus Ruiz et Pav. Fl. Per., 1. p. 28. t. 8. f. d., Don's Mill., 2. p. 592.; *Empetrum pinnatum* Lam. Dict.; *Ancistrum barbatum* Lam. Ill.; is a native of Brazil, and other parts of South America, on arid hills, with white pearl-like fruit, resembling that of the mistletoe; but differing from it in having a grateful and acid taste. It is commonly kept in green-houses, and has ripened fruit in the Cambridge Botanic Garden. It might possibly pass the winter in the gardens in the neighbourhood of London, on conservative rockwork.

Cercocarpus jothergilloides H. B. et Kunth, Nov. Gen. Amer., 6. t. 559., Don's Mill., 2. p. 590.; *Bertolonia guicröldes* Moc. et Sesse, Fl. Mex. Icon. Ined.; is a tree, a native of Mexico, with elliptic, coriaceous, glabrous leaves, growing to the height of 12 ft. Flowers and fruit inconspicuous. It has not yet been introduced.

Acæna Vahl is a genus of which there are some species, natives of Mexico, which grow in situations at a low temperature; but, though they are technically considered ligneous, as they do not grow above half a foot or a foot in height, they do not appear to merit more than this general notice. (See Don's Mill., 2. p. 592.)

Potérion spinosum L. (*Moris. Oxon.*, sect. 8. t. 8. f. 5.) is a shrub introduced in 1595, and growing to the height of 3 ft. The leaves are small, the flowers greenish, the fruit baccate, and the species branched. It is a native of the islands in the Archipelago, about Constantinople; and, though an old in-



habitant of the green-house, is, doubtless, as hardy as many plants that are placed against the conservative wall.

P. caudatum Ait. (*Bot. Mag.*, t. 2341.; and our *fig.* 658.) is a shrub, a native of the Canary Islands; introduced in 1779, and growing to the height of from 3 ft. to 4 ft. In the green-house, it produces its flowers from January to April, and it is, doubtless, half-hardy.

Cliffortia iticifolia L. (*Hort. Elth.*, t. 31. f. 35.) is a shrub, a native of the Cape of Good Hope, which has been in our green-houses since 1714. It is interesting in its notched, stem-clasping, stiff, toothed leaves; and, with *C. obcordata* L., another Cape species, well deserves a trial against a conservative wall. Both grow to the height of 3 ft., and flower from May to July, or later.

CHAP. XLIII.

OF THE HARDY LIGNEOUS PLANTS OF THE ORDER CALYCANTHA'CEÆ.

ALL the kinds of plants of this order are ligneous: they are included in two genera, *Calycánthus* Lindl. and *Chimonánthus* Lindl. Those of the first genus are from North America, and quite hardy in England; those of the second are from Japan and China, and thrive best, in England (at least, north of London), when trained against a wall. "In the stems of all the plants belonging to this order, there is the usual deposit of concentric circles of wood around the pith, and, in addition, four very imperfect centres of deposition on the outside next the bark; a most singular structure, which may be called, without much inaccuracy, an instance of exogenous and endogenous growth combined in the same individual. A good figure of this interesting peculiarity has been given by Mirbel, in the *Annales des Sciences Naturelles*, vol. xiv. p. 367., who originally remarked it in one species, and I have since ascertained it to exist in all. It must also be added, that the woody tissue of this order exhibits disks extremely like those of *Coniferæ*." (*Dr. Lindley* in his *Nat. Syst. of Botany*, p. 160.) The characteristics of the order will be apparent in those of the genera, which are as follows:—

CALYCA'NTHUS Lindl. Calyx with a pitcher-shaped and rather fleshy tube, and a limb consisting of many lobes that are lanceolate, unequal, of a lurid purple colour, rather coriaceous, in many series, and imbricate. These are the sepals and petals, which are not distinguishable. Stamens many, inserted into a fleshy disk at the throat of the tube of the calyx, in many series: they are unequal, deciduous; the 12 outer ones fertile, and the inner ones sterile. Anthers adnate, outward in their position, of 2 cells, which open longitudinally and outwardly. Ovaries many, inserted upon the inner face of the wall of the tube of the calyx, and included within the tube; each containing 1—2 ovules, and terminated by a style, which extends beyond the tube of the calyx. Stigma simple. Carpel: integument somewhat horny; seed solitary from the abortion of one of the ovules, ascending, its hilum opposite the point of the attachment of the carpel to the calyx. Embryo without albumen, straight; its cotyledons convoluted, its radicle inferior. Shrubs, native of North America. Branches brachiate. Leaves opposite, feather-nerved, rough. Flowers axillary, terminal, lurid purple in colour, sweet-scented. Bark and leaves sweet-scented. (*Dec. Prod.*, iii. p. 1. and 2.; and *Lindl. Nat. Syst. of Bot.*, p. 160.)

CHIMONA'NTHUS Lindl. Calyx with oval, obtuse, imbricate lobes resembling bracteas, the inner resembling petals. Stamens nearly equal, persistent; the 5 outer ones fertile, in maturity being connate at the base, and covering over the throat of the tube of the calyx. Shrubs, native of Japan and China. Flowers appearing before the leaves, solitarily, from the places of axils of old leaves; extremely fragrant with a sweet odour; yellowish, with a purple interior. Bark and leaves scentless. (*Dec. Prod.*, iii. p. 2.; and *Lindl. Nat. Syst. of Bot.*, p. 160.)

GENUS I.



CALYCA'NTHUS *Lindl.* THE CALYCA'NTHUS, or AMERICAN ALLSPICE.
Linn. Syst. Icosándria Polygýnia.

Identification. Lindl. in Bot. Reg., t. 404; Nees Nov. Act. Nat. Cur. Bonn., 11. p. 107.; Dec. Prod., 3. p. 2.; Don's Mill., 2. p. 652.

Synonymes. Calycánthi sp. *Lin., Lam., Willd.*; Bütnèria Du Ham. Arb., 1. p. 114., not of Lin.; Beurrèria Ehret. Pict., t. 13.; Bastèria Adans. Fam., 2. p. 294.; Pompadouira Buchoz; Calycante, Fr.; Kelch Blume, Ger.

Derivation. From *kalur*, a calyx, and *anthos*, a flower; the calyx is coloured, and resembles a corolla. The name allspice was given to it by the inhabitants of Carolina, from the strong aromatic smell of the bark.

Description. Deciduous shrubs, natives of North America; propagated, in England, by layers. De Candolle states that the removal of the terminal leaf bud of a shoot causes the production of two new flower buds; and that by this practice a succession of flowers during the whole summer may be obtained. (*Dec. Prod.*, iii. p. 2.) The price of the common kinds, in the London nurseries, is 75s. per hundred, or 9d. each; at Bollwyller, 1½ franc; and at New York, from 37½ cents to half a dollar.

♣ 1. *C. FLO'RIDUS* L. The flowery Calycanthus, or Carolina Allspice.

Identification. Lin. Sp., 718.; Nutt. Gen. Amer., 1. p. 312.; Dec. Prod., 3. p. 2.; Don's Mill., 2. p. 652.

Synonymes. *C. stérilis* *Watt. Car.*, 151.; sweet-scented Shrub, in *Carolina*; common American Allspice.

Engravings. Bot. Mag., t. 503.; Du Ham. Arb., 1. t. 45.; Lam. Ill., t. 445. f. 1.; Guimp. Abb. Holz., t. 4.; and our fig. 659.

Spec. Char., &c. Wood of the trunk, and especially of the root, intensely camphor-scented. Branches spreading; branchlets tomentose. Leaves oval, tomentose beneath. Flowers mostly abortive. Fruit top-shaped. A native of the shaded banks of rivulets in Carolina. (*Dec. Prod.*, iii. p. 2.)

Varieties. De Candolle gives two forms of this species.

♣ *C. f. 1 oblongus*, leaves oblong (*Ait. Hort. Kew.*, ed. 2., 3. p. 282.); and

♣ *C. f. 2 ovatus*, leaves roundish ovate (*Ait. H. Kew.*, ed. 2., 3. p. 282.).

The following varieties are in Loddiges's *Catalogue* for 1836; and plants of most of them are in their arboretum, and in that of the Horticultural Society:—

♣ *C. f. 3 asplenifolius* has cut leaves.

♣ *C. f. 4 ferox* has fertile flowers.

♣ *C. f. 5 glaucus* has leaves somewhat glaucous.

♣ *C. f. 6 inodorus* has flowers nearly scentless.

♣ *C. f. 7 longifolius* has elongated leaves.

♣ *C. f. 8 variegatus* has variegated leaves.

Description, &c. A shrub, growing to the height of 6 ft. or 8 ft., and forming a dense orbiculate bush; the shoots covered with brown bark, and the leaves opposite on short footstalks. The flowers grow singly on short peduncles at the extremity of the branches; they have two series of narrow thick sepals, which spread open, and turn inward at the top, like those of the anemone or clematis. They are of a dusky purple colour, and have a powerful aromatic scent. The plant is a native of Carolina, and was introduced by Mark Catesby in 1726. It was not common in British gardens till about 1757; when, according to Miller, many plants were brought from Carolina, it having been greatly increased in the gardens about Charleston. It thrives best in a light, rich, sandy soil, kept



rather moist, and in a shady situation. It flowers freely from May to August but seldom produces fruit in England. The varieties differ very slightly from each other. The largest plants of this species in the neighbourhood of London are at Purser's Cross, and at Syon, where there are bushes from 6 ft. to 8 ft. high.

♯ 2. *C. (F.) GLAUCUS* Willd. The glaucous-leaved Calycanthus, or fertile-flowered American Allspice.

Identification. Willd. Enum., 559.; Pursh Fl. Sept. Amer., p. 357.; Dec. Prod., 3. p. 2.
Synonymes. *C. fertilis* Walt. Car., 151.; Lindl. Bot. Reg., t. 404., Guimp. Abb. Holz., t. 5.; Don's Mill., 2. p. 652.
Engravings. Bot. Reg., t. 404.; Guimp. Abb. Holz., t. 5.; and our fig. 660.



Spec. Char., &c. Branches spreading. Leaves ovate-lanceolate, acuminate, glaucous beneath, pubescent. Flowers less odorous than those of *C. floridus*. (*Dec. Prod.*, iii. p. 2.) A native of Carolina, on mountains. This species, or, as we believe, variety, which was introduced at the same time as *C. floridus*, closely resembles it in general appearance; and requires the same soil and culture. According to Pursh, the flowers are of a lurid purple, like those of *C. floridus*; but their scent is not so agreeable, and is more faint. Whether there is much difference between this sort and *C. f. 5 glaucus* we have not had an opportunity of ascertaining; the plant in Messrs. Loddiges's arboretum not having flowered. We have therefore retained the description of this kind as a species, in deference to Pursh, De Candolle, and G. Don, though we strongly suspect that they are identical.

Variety.

♯ *C. g. 2 oblongifolius* Nutt. Gen. Amer., i. p. 312., Dec. Prod., iii. p. 2.; *C. oblongifolius* Hort. Brit. — Leaves ovate-lanceolate, elongated. A native of North Carolina, on mountains. (*Dec. Prod.*, iii. p. 2.)

♯ 3. *C. LEVIGATUS* Willd. The glabrous-leaved Calycanthus, or American Allspice.

Identification. Willd. Enum., 559.; Willd. Hort. Berol., t. 80.; Pursh Fl. Sept. Amer., p. 358.; Nutt. Gen. Amer., 1. p. 312.; Guimp. Abb. Holz., t. 6.; Dec. Prod., 3. p. 2.; Don's Mill., 2. p. 652.
Synonymes. *C. ferox* Michx. Fl. Bor. Amer., 1. p. 305.; *C. pennsylvanicus* Lodd. Cat.
Engravings. Willd. Hort. Berol., t. 80.; Guimp. Abb. Holz., t. 6.; Bot. Reg., t. 481.; and our fig. 661.



Spec. Char., &c. Branches strictly upright. Leaves oblong or ovate, and gradually acuminate, slightly wrinkled; the upper surface rough to the touch, the under one glabrous and green. (*Dec. Prod.*, iii. p. 2.) A native of Pennsylvania, Virginia, and Carolina, on mountains; introduced into Britain in 1806, and resembling the two preceding sorts in appearance and culture, but with the leaves more pointed. Very probably the *C. f. 4 ferox* of the preceding page.

GENUS II.



CHIMONANTHUS Lindl. THE CHIMONANTHUS, or WINTER FLOWER.

Identification. Lindl. Bot. Reg., t. 404. and 451.; Dec. Prod., 3. p. 2.; Don's Mill., 2. p. 652.
Synonymes. *Meratia* Nees Act. Soc. Nat. Bonn., 11. p. 107.; *Calycanthi* sp. Linn.
Derivation. From *cheimōn*, winter, and *anthos*, a flower; in allusion to the season of its flowering.

Description, &c. A deciduous shrub, a native of Japan; remarkable for the fragrance of its flowers, which are produced from December till March, even

in the open garden, in the neighbourhood of London, and more especially if the plant is trained against a wall. The blossoms are produced singly, in the axils of the leaves, on the shoots of the preceding year, and also on spurs proceeding from the old wood. The soil, culture, &c., are the same as for *Calycánthus*.

✽ 1. *C. FRA'GRANS* Lindl. The fragrant-flowered *Chimonanthus*.

Identification. Lindl. Bot. Reg., t. 404. 451; Dec. Prod., 3. p. 2; Don's Mill., 2. p. 652.

Synonymes. *Calycánthus præcox* Lin. Sp., 1718.; *Ait. Hort. Kew.*, ed. 1. vol. 2. p. 220. t. 10., *Curt. Bot. Mag.*, t. 466., *Lam. Ill.*, t. 445. t. 2.; *Meratia fragrans* Nees *Act. Soc. Nat. Bonn.*, 11. p. 107.; O'bai, or Rôbai *Kämpf. Amoen.*, 879. ic.; the Winter Flower; *Calycante de Japon*, Fr.; *Japanische Kelch Blume*, Ger.

Engravings. Kämpf. Amoen. ic.; *Ait. Hort. Kew.*, ed. 1. vol. 2. t. 10.; *Bot. Mag.*, t. 466.; *Lam. Ill.*, t. 445. t. 2.; and our *fig.* 662.

Spec. Char., &c. Bark and leaves scentless. Flowers protruded before the leaves, solitary in the old axils of leaves, extremely odorous, yellowish, and purple within. Fruit flask-shaped, or thicker above the base, and in the upper part tapered into a cylindraceous neck. (*Dec. Prod.*, iii. p. 2.)

Varieties.

✽ *C. f. 2 grandiflorus* Lindl. Bot. Reg., t. 451.; and our *fig.* 663.—Flowers larger, and more spreading. Fruit oblong, tapered at the base. (*Dec. Prod.*, iii. p. 2.)

✽ *C. f. 3 luteus* Hort. has the flowers yellow both inside and outside.

Description., &c. Deciduous shrubs, growing to the height of 6 ft. or 8 ft., as bushes, in the open ground, in sheltered situations in the neighbourhood of



London, and much higher when trained against a wall. The bark is whitish, and the leaves of a smooth, shining, light green. The flowers, which are produced in the greatest abundance, from November till March (as the name, winter flower implies), and which are delightfully and refreshingly fragrant, scent the air to a



considerable distance round the tree. This species was introduced in 1776, and was generally treated as a conservatory shrub, till within the last 15 years; when it was found to be quite hardy, more especially when trained against a wall. It is now grown in most choice gardens for its flowers; a few of which are gathered daily, and placed in the drawingroom, or boudoir, in the same manner as violets. The plant is generally propagated by layers; but it frequently produces seeds, from which many plants have been raised. The variety *C. f. grandiflorus* has the flowers rather less fragrant than the species, but they are much more ornamental. This is so very desirable a shrub, on account of the fragrance of its flowers, and their being produced through the whole of the winter, that no garden whatever ought to be without it. In the small plots in the front of suburban street houses, it may be planted against the house, and trained up so as to form a border to one or more of the windows. In all gardens north of London, it deserves a wall as much as any fruit tree; at least judging from the measure of enjoyment which it is calculated to afford: and, south of London, it may also be planted as a standard bush on the open lawn, or in the shrubbery. There are remarkably fine specimens of the species and varieties in the garden of the London Horticultural Society, in the Botanic Garden at Twickenham, at Messrs. Loddiges's; and, as standards, in the nursery of Messrs. Rollisson, at Tooting. The price of plants of the species, in the London nurseries, was, till lately, from 5s. to 7s. each; at present, the species, and *C. f. luteus*, are 3s. 6d. each; and *C. f. grandiflorus* is 7s. 6d. At Bollwyller, the species is 5 francs; and at New York, 2 dollars, and the yellow-flowering variety 1 dollar.

CHAP. XLIV.

OF THE HARDY LIGNEOUS PLANTS OF THE ORDER GRANATA'CEÆ.

THE genus *Punica* was separated from *Myrtaceæ*, and formed into this order, by Professor Don, in the *Edin. Phil. Journ.* of July, 1826, p. 134. It contains only one genus, and the characteristics of the order will be found included in the generic character.

GENUS I.



PUNICA Tourn. THE POMEGRANATE TREE.

Identification. Tourn. Inst., t. 401.; Lin. Gen., No. 618.; Gærtn. Fruct., 1. t. 38.; Dec. Prod., 2. p. 3.; Don's Mill., 2. p. 653.

Synonymes. The Carthaginian Apple; Grenadier, *Fr.*; Granate, *Ger.*; Melograno, *Ital.*; Granados, *Span.*

Derivation. *Punica* is said, in the *Nouveau Du Hamel*, to be derived either from *punicus*, scarlet in allusion to the scarlet colour of the flowers; or from the same word, or *punicus*, both signifying "of Carthage;" near which city, Pliny tells us, it was first found.

Gen. Char. *Calyx* with its tube top-shaped; its limb with 5—7 lobes; their æstivation valvate. *Petals* 5—7. *Stamens* numerous, with distinct filaments, which bear the anthers on their inner side. *Style* 1. *Stigma* 1. *Fruit* spherical, crowned with the upper part of the calyx, whose lower part forms the fruit's rind. The fruit does not open, and is divided into two portions by a horizontal diaphragm. The upper portion consists of 5—9 cells; the lower one is smaller, and consists of 3 cells only: in both, the cells are separated by membranous partitions: in the upper, fleshy placentæ extend from the sides of the fruit to the centre; in the lower, irregular processes arise from the bottom. *Seeds* very numerous, surrounded by a transparent shining pulp. *Embryo* oblong; its radicle short, straight; its cotyledons leafy, spirally convolute.—Small trees, or shrubs, with branchlets imperfectly square, and becoming spiny. Leaves deciduous, opposite, more rarely whorled or alternate; in many instances in groups in the axils; oblong, entire. Flowers scarlet, 2—5 together, almost sessile, and almost terminal upon the branchlets. (*Dec. Prod.*, iii. p. 3.) The characters of the fruit and cotyledons, and the circumstance of the leaves being without the dots and the intramarginal vein, possessed by the leaves of the *Myrtaceæ*, have been deemed sufficient by Don, De Candolle, and Martius, to distinguish *Punica* as of an order distinct from *Myrtaceæ*. Lindley, in his *Introduction to the Natural System of Botany*, under *Myrtaceæ*, has argued that they are not so; and his arguments are interesting to the botanical student. We have, according to our general plan, followed Don's *Miller*.

Description, &c. Low deciduous trees, or shrubs, indigenous to Africa, and naturalised in the south of Europe.

‡ 1. *P. GRANA'TUM* L. The common Pomegranate Tree.

Identification. Lin. Sp., 676.; Dec. Prod., 3. p. 3.; Don's Mill., 2. p. 653.

Spec. Char., &c. Stem arboreous. Leaf lanceolate. (*Dec. Prod.*, iii. p. 3.) A native of Mauritania, whence it may have migrated into the south of Europe, where it is now perfectly indigenous.

Varieties.

‡ *P. G. 1 rubrum* Dec. (*Prod.*, iii. p. 3.; *Trew Florct.*, t. 71. f. 1.; *Peit. et Turp. Arbr. Fr.*, 22.; *Schkuhr Handb.*, t. 131. b.; *Sims Bot. Mag.*,

t. 1832.; and our *fig.* 664.) has the flowers red; pulp of fruit reddish. Wild in Mauritania and the south of Europe, and enduring even the coldest winters. (*Dec. Prod.*, iii. p. 3.)

- ❖ P. G. 2 *rubrum flore pleno* Trew Ehret., t. 71. f. 2., has double red flowers. It is common in gardens, and is a little more impatient of cold than the preceding variety. (*Dec. Prod.*, iii. p. 4.)
- ❖ P. G. 3 *albescens* Dec. Prod., iii. p. 4., Andr. Bot. Rep., t. 96.—Petals white. Calyx slightly yellowish. Pulp of the fruit of a pale red. It is cultivated in gardens, and is rather more tender than *P. G. rubrum*. (*Dec. Prod.*, iii. p. 4.)
- ❖ P. G. 4 *albescens flore pleno* Dec. has double flowers, which are nearly white. It is cultivated in gardens, and is the tenderest of all the forms of the species. (*Dec. Prod.*, iii. p. 4.)
- ❖ P. G. 5 *flavum* Hort. has the flowers yellow, but is rare in gardens.

Description, &c. A tree, in magnitude and ligneous character, bearing considerable resemblance to the common hawthorn. In the south of France, and

in Spain and Italy, it grows to the height of 18 ft. or 20 ft.; forming a very branchy twiggy tree, seldom found with a clear stem, unless it has been pruned up. In a wild state, about Marseilles, it forms a thorny bush; but, in the gardens about Nice and Genoa, it is a very handsome small tree, much admired both for its flowers and its fruit. It is a native of Barbary, Persia, Japan, and various parts of Asia; and it has been long introduced into the West Indies and South America. In the Himalayas, Mr. Royle informs us that the pomegranate grows wild; and, also, that it is planted near villages. It forms quite a wood in Mazanderan, whence the dried seeds are exported for medicinal use. The famous pomegranates without seeds are grown in the rich gardens, called Ballabagh, lying under the snowy hills near the Caubul river. They are described as delicious about Hadgiabad, and throughout Persia. "Though grown in most parts of India, large quantities, of a superior quality, are yearly brought down by the northern merchants from Caubul, Cashmere, and Boodnrwar." (*Illustr.*, p. 208.) At a very early period, the pomegranate appears to have attracted the attention of mankind. It is mentioned by Theophrastus under the name of Roa; the Phœnicians named it Sida; the Greeks, Cytinos; and the Romans, according to Pliny, *Malus Punica*. The Jews appear to have held the tree in great veneration. It is mentioned, in the Old Testament, as one of the fruits discovered in the Land of Promise; and, while the Israelites sojourned in the wilderness, it was selected as one of the ornaments to the robe of the ephod. The two large pillars of brass, made by Hiram for the porch of Solomon's Temple, were ornamented with carvings of the pomegranate; and, from other passages in Holy Writ, a wine appears to have been made from it. Pliny speaks of getting a colour from the flowers for dyeing cloth a light red. He mentions nine varieties; including the sweet, the sour, the temperate, the austere, and the wine-flavoured. The rind of the sour kind, he says, is the best for tanners and curriers to dress their leather with. The celebrated kingdom of Granada is supposed to have derived its name from the trees planted in it by the Moors; which is rendered highly probable by the arms of the city of Granada being a split pomegranate. The earliest mention of the pomegranate in England is in Turner's *Herbal*, in 1548; but it was probably introduced long before that time by the monks, and planted in the gardens of the religious houses. For a long period, it was kept exclusively in houses, along with orange trees; and we find, accordingly, that it fruited in the orangery of Charles I., as Parkinson informs us, under the care of Tradescant, when



664

he was that king's gardener. It seems to have been first tried in the open air by Miller, at Chelsea; and, at the suggestion of Bradley, in the garden of Cambden House, and in other gardens about Kensington; as the oldest specimens in the neighbourhood of London are at these places. At present, it is in most collections as an ornamental wall tree, and it ripens its fruit, or, at least, produces them of the full size, frequently, in the neighbourhood of London in fine seasons; but the varieties most generally cultivated are those with double flowers. The largest double-flowered pomegranate in England is supposed to be that trained against the walls of Fulham Palace, which is at least 40 ft. high, and 50 ft. broad.

Properties and Uses. In the south of Europe, the pomegranate is cultivated for its fruit; and, in some places, as a hedge plant. It is also grown as an ornamental tree; the stem being trained to the height of 6 ft. or 8 ft., and the head afterwards allowed to spread, and droop down on every side. In the conservatories in the neighbourhood of Paris, and in France generally, the double-flowered variety is planted in large boxes, and treated like the orange tree. For this purpose, young plants are grown in the orange nurseries about Nice and Genoa, and exported to different parts of the world. Both the single and the double-flowered varieties are very frequently trained against walls, both in France and Italy; and the more ingenious cultivators intermingle the branches of the one sort with those of the other, so as to make a display of both double flowers and fruit, apparently on the same tree. The pulp which encloses the seeds is sometimes acid, sometimes sweet; and, in other cases, vinous, astringent, and refreshing. A syrup is made from this pulp by the druggists, which is employed as an astringent and detergent; the dried flowers are likewise kept in shops, for making infusions for the same purpose. Lord Bacon recommends the juice of pomegranates as good for liver complaints; and Woodville says that it is preferable to that of oranges, in cases of fever. The rind of the fruit, on account of its astringent properties, has been used as a substitute for galls, in making ink; and is said to be still employed, in some parts of Germany, in dyeing leather red, in imitation of morocco. In the Himalayas, Mr. Royle informs us, the rind of the fruit, called naspal, "being very astringent, is used in medicine, as well as in dyeing. The employment, by the natives of India, of the bark of the root for the expulsion of the tape-worm, being now well known, since the subject was communicated by Drs. Hamilton and Fleming, is a remarkable instance of the oblivion into which even a valuable medicine may fall, as this property was well known to Dioscorides; i. c. 154." (*Illustr.*, p. 208.)

Poetical, mythological, and legendary Allusions. The pomegranate is mentioned by the earliest poets. Ovid tells us that, when Ceres discovered that Pluto had stolen her daughter Proserpine, she implored Jupiter so earnestly to restore her, that he consented, provided she had eaten nothing during her residence in the infernal regions. Unfortunately, while walking in the Elysian Fields, Proserpine had gathered a pomegranate, and eaten seven grains of it; and had been observed by Ascalaphus; who, informing Pluto of the fact, was turned by Ceres into an owl for his interference. (*Ovid. Met.*, v. l. 6.; *Fast.* iv. v. 417.) Nicholas Rapin, in his poem entitled *Les Plaisirs du Gentilhomme Champetre*, published in 1583, gives the following origin to the pomegranate:—A young girl of Scythia having consulted the diviners to know her fortune, was told by them that she was destined one day to wear a crown. This rendered her so proud and vain, that she was easily seduced by Bacchus, on his promising to give her a crown. He soon grew tired, and abandoned her; and, when she afterwards died of grief, he metamorphosed her into a pomegranate tree, on the fruit of which he affixed a crown (alluding to the shape of the calyx); thus tardily and ambiguously redeeming his promise. Many other poets have mentioned the pomegranate; among whom may be enumerated Chaucer, in his *Romance of the Rose*; Andrew Marvell; Thompson, in his *Seasons*; Moore; and Byron. This shrub is considered the emblem of democracy; probably from its fruit consisting of numerous seeds, which form

its valuable part, and a worthless crown. In allusion to the latter circumstance, Queen Anne of Austria had for a device a pomegranate, with the motto, "My worth is not in my crown" (*Reid's Hist. Bot.*, i. p. 150.); and Phillips says that the French, in the Island of St. Vincent, had a riddle on the pomegranate, which was "Quelle est la reine qui porte son royaume dans son sein?" alluding to the same properties. (*Pom. Brit.*, p. 318.)

Soil, Situation, Propagation, &c. The single wild pomegranate will grow in almost any soil; but the double-flowered varieties, and the species when it is intended to bear fruit, require a rich free soil. The double-flowering pomegranate trees, grown in boxes by the French gardeners, are planted in the very richest soil that can be composed; and a portion of this soil is renewed every year, when the roots are severally pruned. The head, also, is thinned out, and so cut as to multiply, as much as possible, short slender shoots; on the points of which alone the flowers are produced. In training the pomegranate against a wall, in England, it is necessary to keep this constantly in view; for, if these slender shoots are cut off, no flowers will ever be produced. The plant is easily propagated by cuttings of the shoots or of the roots, by layers, or by grafting one sort on another. It also rises freely from seeds; but these ought to be sown immediately on being removed from the fruit; because they very soon lose their vital powers. Price of plants, in the London nurseries, is 1s. each; at Bollwyller, where the pomegranate is a green-house plant, plants of the species are 2 francs each, and of the varieties from 3 to 6 francs; at New York, plants are from 75 cents to 1½ dollars each. The double sort, grafted on the single, may be purchased, at Genoa, at 1 franc each.

✻ 2. *P. (G.) NANA L.* The dwarf Pomegranate.

Identification. Lin. Sp., 676.; Sims Bot. Mag., t. 634.; Dec. Prod., 3. p. 4.; Don's Mill., 2. p. 653.

Synonymes. *P. americana nana Tourn.*; *P. Granatum nanum Pers.*

Engravings. Bot. Mag., t. 634.; Trew Ehret., t. 71. f. 3.; and our fig. 665.

Spec. Char., &c. Stem shrubby. Leaf linear. Flower red.

Native of the Caribbee Islands, and of South America, about Demerara, &c. (*Dec. Prod.*, iii. p. 4.) Persoon considers it a variety of *P. Granatum*, in which opinion we concur. *P. nana* is said to have been brought to France from Guiana and the Antilles, where it is used for garden hedges. It was introduced into England in 1723; grows to the height of 5 ft. or 6 ft., and flowers from June to September. In the West Indies, it continues flowering all the year; which may have weakened the plant to such a degree as, in time, to have given it its dwarf habit. It is much smaller in all its parts than the species, and considerably more delicate.



CHAP. XLV.

OF THE HALF-HARDY LIGNEOUS PLANTS OF THE TRIBE FUCHSIEÆ, BELONGING TO THE ORDER ONAGRA'CEÆ.

THE genus *Fuchsia* is well known to British gardeners, as containing some of the most beautiful of the half-hardy ligneous plants in cultivation. All the species and varieties hitherto introduced or originated, when planted in a dry soil, and a sheltered situation, in the neighbourhood of London, though they may be killed down to the ground by the frost, may have their stools preserved alive through the winter, by covering them with litter, haulm, or leaves, in such a way as to throw off the wet; and, this covering being removed in spring, the plants will shoot up vigorously, and flower freely during the whole summer. They are, thus, admirably adapted for planting in dug beds and

borders, in the same way as has been recommended for the different varieties of *Rôsa indica* (p. 782.), and for pelargoniums (p. 483.). Some of the species are low shrubs, such as *F. cónica*, *F. virgata*, *F. macrostemon*, *F. rôsea*, *F. parviflora*, *F. híbrida*, *F. excorticata*, *F. globosa*, &c. Others are shrubs growing to the height of 6 ft. or 8 ft.; such as *F. coccinea*, *F. grácilis*, *F. tenella*, &c.; and *F. arborescens* and *F. apétala* grow to the height of from 12 ft. to 16 ft. The higher-growing sorts, when trained to single stems, may be planted out, in the beginning of summer, in borders, or on lawns, as temporary single trees; and in the autumn, on the first appearance of frost, all the side shoots may be cut in close to the trunk, and the plant taken up, and placed among dry sand, in a cellar, during the winter. About the middle of the following May, these plants will have begun to push, along the whole length of their stem; when they may be replaced in the border or lawn; not omitting, however, to let them be planted in a large mass of entirely fresh soil, light, and enriched with rotten leaves, or very old, rotten, hot-bed dung. Some of the finest ornaments to the gardens in the neighbourhood of London are produced in this way, with comparatively little trouble and expense.

All the species are remarkably easily propagated by cuttings; which may be put in either of the old or new wood. One of the most expeditious modes is, to put a plant into heat in January, and take off the shoots, for cuttings, as soon as they are three inches long, as recommended to be done with the tea-scented rose. (p. 801.) Abundance of plants may be thus raised every spring, for turning out into the open garden in May; and these plants, in cold situations, or in moist soils, may either be taken up, and preserved in a cellar during winter; or left to perish, and their places supplied by others, raised in the manner mentioned. In dry soils, they may be cut down to the ground after the first frosts, and the stool, or stock, covered with litter, or leaves, or a hillock of earth. In low situations near the sea, and in others which are equally favourable in point of climate, the plants may be cut down, and left unprotected.

In this genus, as in most others containing numerous sorts, and from which many seedlings have been raised in gardens, there is reason to believe that many of the kinds named and described as species are only varieties or hybrids. Mr. D. Beaton, an experienced cultivator, and an intelligent writer in the *Gardener's Magazine*, observes that "The botanical difference, if any, of all the Chilian fuchsias is very trifling." Dr. Lindley remarks that there are some "who consider the greater part of the Chilian fuchsias as mere varieties of *F. macrostemon*," to which Mr. Beaton replies that "whoever considers this considers the reverse of what is the fact. Their origin is still more singular. *F. macrostemon*, in all likelihood, is as much a variety as any of them. *F. cónica*, *F. grácilis*, *F. tenella*, *F. virgata*, and many more varieties, or perhaps species, may be originated by fertilising the stigmas of *F. coccinea* with the pollen of *F. arborescens*: this I have proved three times over; and I have every reason to believe, though I have never proved it, that *F. macrostemon* may be produced from *F. cónica*, fertilised by the pollen of *F. arborescens*. All the Chilian fuchsias will intermix freely with the pollen of *F. arborescens*; and, what is very singular, *F. arborescens* will not intermix with their pollen; at least, I have failed in several attempts to effect this. *F. excorticata*, a New Zealand species, impregnated with the pollen of either *F. cónica* or *F. globosa*, will produce fac-similes of *F. discolor*, or the Port Famine fuchsia; and the seedlings so produced will not flower till the second or third year, which is the case with *F. discolor*." (*Gard. Mag.*, vol. xi. p. 581.)

These circumstances, Mr. Beaton thinks, go far to prove that plants can be originated artificially, which will be found capable of reproducing themselves from seeds, *ad infinitum*, with as little variation as is to be found in any natural species; and we believe this is in conformity with the experience of gardeners in the culture of Cape heaths, pelargoniums, &c. "Botanists," Mr. Beaton adds, "say that species so produced revert to either of their parents in the third or fourth generation, or become sterile altogether. This," he continues, "is

plausible enough in theory, in the closet, but will not do at the potting bench. The pollen of fuchsias, and, perhaps, of most plants, is capable of maintaining its fertilising properties for an indefinite space of time; and, if well preserved, will be as fit for use when five years old as when newly gathered: the only conditions necessary for the preservation of its fertilising powers are, an absolute exemption from moisture, and to be kept in an atmosphere above the freezing point. It is supposed, by some, that the presence of the petals of the flower are essential to the delicate process of nourishing the embryo seeds; but this is a mistake: the service of the petals is entirely at an end the moment the stigma is ready for the pollen." (*Ibid.*)

The fuchsia and the pelargonium are two of the finest genera from the Old World that can be introduced to ornament the gardens of Australia, and more particularly those of Van Diemen's Land.

In the following enumeration, we have chiefly adopted the names given in our *Hortus Britannicus*, and included the additions that have been recorded in recent volumes of the *Gardener's Magazine*.

F. microphylla H. B. et Kunth (*Bot. Reg.*, t. 1269; and our fig. 666.) is a native of Mexico, with small, elliptic, oblong leaves, and small short flowers. It was introduced in 1828; grows from 4 ft. to 6 ft. high, and produces its pinkish red flowers from June to September. It is a very hardy species.

F. thymifolia H. B. et Kunth (*Bot. Reg.*, t. 1284.) is a native of Mexico, with small leaves, and small red flowers, which are produced from May to October. It was introduced in 1827, and grows to the height of 6 ft.

F. rosea Ruiz et Pav.; *F. lycioides* *Bot. Reg.*, t. 120, *Bot. Mag.*, t. 1024; is a native of Chili, with small purplish pink flowers. It was introduced in 1796, and, in favourable situations, will grow to the height of 12 ft.

F. parviflora Lindl. *Bot. Reg.*, t. 1048; *F. ovata* *Moc. et Sesse*; closely resembles the preceding sort. It is a native of Mexico, and was introduced in 1824. It grows to the height of 6 ft., and flowers from May to October.

F. arborescens Sims *Bot. Mag.*, t. 2620; *F. amœna* Hort.; *F. hamelioides* *Moc. et Sesse*; *F. racemosa* *Id.*, *Bot. Reg.*, t. 943; has broad leaves, and small red flowers. It is a native of Mexico; was introduced in 1824; grows 15 ft. or 16 ft. high; and flowers in September and October.

F. gracilis Lindl. *Bot. Reg.*, t. 849; *F. decussata* *Graham, Bot. Mag.*, t. 2507; has pubescent branches, and flowers with purple petals and bright scarlet calyx. It is a native of Mexico, and was introduced in 1823: it grows to the height of 8 ft. or 10 ft., and flowers from May to October.

F. g. 2 multiflora Lindl. *Bot. Reg.*, t. 1052, has glaucous leaves, smaller than those of the species.

F. macrostemon Ruiz et Pav. (*Lodd. Bot. Cab.*, t. 1062.) has the petals blue and spreading, not convolute; and the calyx scarlet. It is a native of Chili, in marshes; and was introduced in 1823. It grows to the height of 12 ft., and flowers from July to October.

F. m. 2 tenella Dec.; *F. gracilis* var. *tenella* Lindl. *Bot. Reg.*, t. 1052; has opposite leaves, which are smaller than those of the species.

F. cónica Lindl. *Bot. Reg.*, t. 1062, is a native of Chili, with the corolla purple, and calyx scarlet; the leaves in whorls; and the tube of the corolla conical, which gives a conical shape to the calyx. This, which is one of the handsomest sorts of *Fuchsia*, was introduced in 1824.

F. virgata Swt. has flowers somewhat resembling those of the preceding sort. It is a native of Mexico, whence it was introduced into Britain in 1825, and is considered one of the hardiest species of the genus.

F. coccinea Ait.; *F. pendula* *Salisb.*; *F. magellanica* *Lam., N. Du Ham.*, t. 1. 13.; *Nahsia coccinea* *Schneevoigt*; *Skinnera coccinea* *Munck*; (*Bot. Mag.*, t. 91; and our fig. 667.) is a well-known species, with opposite or whorled leaves, and axillary drooping flowers. The calyx is scarlet, and the petals violaceous. It is a native of Chili, in marshes, as far south as the Straits of Magellan. It was introduced into Kew Gardens by Captain Firth, in 1788, and was greatly admired, being the first species of the genus seen in a living state in England. Soon afterwards, Mr. Lee, one of the founders of the Hammer smith Nursery, obtained a plant of it; and, having soon discovered with what ease it may be multiplied, he raised, as we have been informed, many hundred plants, which, by showing only two or three at a time, he was enabled to sell at one guinea each.

F. apétala Ruiz et Pav. grows to the height of from 10 ft. to 12 ft., and produces drooping flowers, $1\frac{1}{2}$ in. long, with red calyx. It is a native of Chili, and was introduced in 1825. It flowers in September and October.

F. discolor Lindl. *Bot. Reg.*, t. 1805, is a native of the Falkland Islands, at Port Famine; whence it was introduced in 1830. Dr. Lindley observes, that "it is difficult to distinguish it from *F. gracilis*, and *F. tenella*; yet it is decidedly different. It is remarkable for its compact bushy manner of growth, its deep purple branches, its small very undulated leaves, and also for being apparently more hardy than any other fuchsia yet in the gardens." For the latter reason, Dr. Lindley attaches "especial importance to it; for, by a judicious intermixture of its pollen with such beautiful plants as *F. cónica*, *F. globosa*, and its other more tender relatives, the race produced may probably be rendered capable of bearing the climate of Great Britain." (*Bot. Reg.*, t. 1805.)

666



667



F. bacillaris Lindl. Bot. Reg., t. 1480, is a native of Mexico, introduced in 1829, which grows to the height of 5 ft., and produces its rose-coloured flowers all the summer.

F. hybrida Swt. is a hybrid of uncertain origin, raised in 1825, and producing its scarlet flowers from May to October. It grows 3 ft. or 4 ft. high.

F. globosa Hort. is supposed to be a hybrid originated between *F. macrostemon* and *F. cónica*, about 1830. It is remarkable for the globular shape of the calyx before it bursts, when it looks like the drop of a coral ear-ring. It is tolerably hardy, and, when killed down to the ground, will shoot up again in spring.

F. g. 2 longiflora Hort. A plant bearing this name was exhibited at the Horticultural Society's Garden, May 14. 1836. It closely resembled the species, only differing in the flower being much larger and longer.

F. longiflora Hort., *F. longipedunculata* Beaton, has been much vaunted; but it is chiefly remarkable for its long peduncles.

F. speciosa Hort., *F. grandiflora* Hort., *F. præcox* Hort., and *F. Thompsonii* Hort., are names current in gardens for sorts originated in this country, of various degrees of beauty.

F. excorticata Lin. fil., *Skinnra excorticata* Forst., (*Bot. Reg.*, 857; and our fig. 668.) has smooth branches, and ovate-lanceolate leaves, with the sepals green and purple, and the petals violaceous. The stem and branches, after a few years' growth, throw off the bark in the manner of *Arbutus Andrachne*, by which this species is readily distinguished from all others. It is a native of New Zealand, where it was discovered by Forster, during one of Captain Cook's voyages, but was not introduced in a living state until 1824. It grows to the height of 5 ft. or 6 ft., and flowers from June to October.

Other Varieties are continually being obtained from seed by different cultivators. Mr. Dennis, of the Grosvenor Row Nursery, Chelsea, has raised a great number of these, particularly in 1834; one of which seems to have a pendulous habit, with flowers like those of *F. globosa*, but smaller. (*Gard. Mag.*, xi. p. 582.)



668

CHAP. XLVI.

OF THE HALF-HARDY LIGNEOUS PLANTS OF THE ORDER LYTHRACEÆ.

Hemia salicifolia Link et Otto (*Swt. Brit. Fl.-Gard.*, t. 281; and our fig. 669.), *Nesæa salicifolia* H. B. et Kunth, *Lýthrum flavum Spreng.*, is a shrub, growing to the height of 5 ft. or 6 ft.; with willow-like leaves, and lythrum-like yellow flowers, which are produced from June to September. It was introduced in 1821, and requires very little protection.

H. myrtifolia Hort. Berol., *Lýthrum apetalum Spreng.*, has smaller leaves than the preceding sort; but in other respects closely resembles it, and is, in all probability, only a variety. It is a native of Brazil; was introduced in 1826, and flowers in August and September.

H. linearifolia Hort. is obviously a variety of *H. salicifolia*. It was introduced in 1826; and, with the two preceding sorts, was, in 1834, in abundance in the open garden in the Epsom Nursery.

H. syphilitica Dec. is a native of Mexico, said to possess powerful medical properties; but it is not yet introduced. It grows, like the others, from 4 ft. to 6 ft. high.

All these plants are easily propagated by cuttings; and they will grow in any light sandy soil, with a little protection during winter.

Lagerstrœmia indica L. (*Bot. Mag.*, t. 405., and our fig. 670.), the Pride of India of the Americans, is a splendid shrub, a native of China, Cochin-China, and Japan; but not of India, notwithstanding its name. It has roundish, ovate, glabrous leaves; many-flowered terminal panicles, and the petals curled at the edges, with long claws, somewhat in the manner of *Clarkia pulchella*, by which alone its flowers may be easily distinguished from those of most other woody plants. The petals are flesh-coloured, and the bark and the veins of the leaves of a somewhat reddish brown. It was introduced in 1759, and has stood out, with very little protection during winter, in the Fulham Nursery, and in other gardens about London, for upwards of 10 years; but it seldom flowers, except in a stove. It is, however, worth cultivating against a conservative wall, for the sake of its foliage.

L. parvifolia Roxb. is a native of the Circar Mountains, in the East Indies; and it was introduced in 1818. We are not aware of its having been tried against a conservative wall; but it is probably as hardy as the preceding and following species, both of which have been tried successfully.

L. regina Roxb. is a native of the Circars and of Java, where it grows to be a tree 20 ft. high. It was introduced in 1792, and appears as hardy as *L. indica*. The flowers are nearly two thirds of an inch in diameter; of a beautiful rose colour in the morning, growing deeper through the day, until they become purple in the evening. The angles of the branches in this, as in all the species, are winged. They are all of the easiest culture, and, being decidedly deciduous, if their wood is ripened in time, they may be covered with a mat, or with straw, during the whole of the winter. In the warmest parts of Devonshire and Cornwall, this and the two preceding species may be treated as wall shrubs.



669

670

CHAP. XLVII.

OF THE HARDY LIGNEOUS PLANTS OF THE ORDER TAMARICACEÆ.

THIS order consists of two genera; and the most of its characteristics are included in the generic characters which are given below.

TAMARIX *Desv.* Calyx persistent, parted into 4—5 lobes that are subimbricately æstivated. Petals 4—5, inserted into the base of the calyx, alternate with its lobes, imbricate in æstivation, withering. Stamens 4—5, alternate with the petals; the filaments almost wholly distinct from one another. Ovary free of the calyx, ovate-pyramidate, triangular, with a long taper termination. Stigmas 3, long, divaricate, glandulose at the tip, oblique. Capsule with 3 angles, 3 valves, 1 cell, and many seeds. Seeds inserted into the very base of the valves, or nearly into the centre of the capsule, erect, each bearing at its tip a coma of many simple hairs. There is not any albumen. Embryo straight; its radicle small, inferior; its cotyledons flat-convex, oblong. Flowers small, in spikes: these, in many instances, are disposed in panicles. (*Dec. Prod.*, iii. p. 95.)

MYRICARIA *Desv.* Calyx parted into 5 lobes. Petals 5. Stamens 10; every alternate one shorter; the filaments of all connate from the base to about the middle of their length. There is not any style. Stigmas connate into a little head. Seeds inserted along a line in the middle of each valve of the capsule, ascending, ending in a plumy thread. Flowers in terminal, simplish spikes. (*Dec. Prod.*, iii. p. 97.)

These genera were originally included under one genus, *Tamarix*; the separation being made on account of the above technical distinctions. “The plants of the genus *Tamarix*,” Royle observes, “are distributed over a wide extent of territory in the Old World; from 10° to 50° and 55° of N. lat. in Europe and Siberia; and from the Canaries and Senegambia on the west, to China on the east. They differ as much in their localities as in their latitudes; being found on the shores of the ocean, or the banks of rivers (as the Ganges and the Nile), as well in the arid and sandy parts of Northern India and the Punjab, as in the cold and elevated climates of Tibet and Siberia: but in these the soil is saline. The genus *Myricaria*, existing in Europe, Siberia, and Dahuria, is found also in Kunawur, and in the country crossed by Mr. Moorcroft in his journey to Manasarowur.” (*Illustrations, &c.*, p. 213.) There are two species of *Tamarix* common in India; viz. *T. indica* and *T. dioica*. “The former, found on the banks of the Ganges, and other rivers, as well as on the coast of Coromandel, has been referred, by some authors, to *T. gallica*, with which it is closely allied; and, if identical, the circumstance will afford an additional instance of the great extent over which a species may spread, when growing in the vicinity of water. *T. Furas* Hamilt. is the *T. orientalis* of *Forskahl*, and is common in the drier parts of the Doab, and at Delhi; and also in Arabia and Egypt. *Myricaria*, the other genus of this order, includes *Tamarix germanica*, which extends from Europe to the Caucasus: other species, or perhaps varieties, are found in Siberia and Dahuria, and two in the Himalayas.” (*Ibid.*) *Tamarix gallica* and *Myricaria germanica* are almost the only plants of this order found in British gardens. The former is interesting, from its ascending spreading stems, numerous slender branches, abundant minute foliage, and its plentiful panicles of racemes, of pale rosy flowers; *M. germanica* is interesting from its close upright habit of growth, glaucous hue, and evergreen foliage.

The Properties of the Tamaricaceæ are considered to be bitterness and astringency; and hence “the occasional employment of the European species as a tonic, and as a substitute for hops, in making beer, in Denmark. In India, also, the twigs of *T. indica* and *T. dioica* are considered astringent; but the plants are more valued on account of the galls that are found on them, and

other species; and which, being highly astringent, are used in medicine and dyeing. The ashes of *T. gállica* and *T. africàna*, when growing near the sea, contain a large proportion of sulphate of soda; so that they may be profitably burnt to obtain this salt: its abundance explains the utility of some of these plants as diuretics. *T. gállica* grows on Mount Sinai; and, by the puncture of *Cóccus mamíparus*, a species of manna is produced, which is known by the name of Arabian, to distinguish it from the Persian manna, which is the produce of *Alhàgi Mauròrum*. (p. 646.) The tamarisk was a celebrated medicinal plant with the ancient Arabians, from whom the Latins seem to have borrowed the high encomiums they bestowed on its virtues. Dr. Grindall, who brought it from Germany after he was made Archbishop of Canterbury (see p. 39.), cultivated it chiefly for its medicinal virtues; and Master Richard Hakluyt, in 1599, tells us that "many people have received great health by this plant." (*Voy.*, ii. p. 161.) The tamarisk is mentioned by nearly all the ancient poets. Homer states that it was the tree against which Achilles laid his spear before he plunged into the *Ceanthus* to pursue the flying Trojans; and Theocritus, in his Pastorals, Virgil, in his Eclogues, and Ovid, in several of his poems, all refer to this plant. Some of the older British poets have also celebrated it. Davy says,—

— "On yon rough crag,
Where the wild tamarisk whistles to the blast;"

and Browne,—

"Among the rest, the tamarisk there stood,
For huswives' becomes onely knowne most good."

Evelyn speaks of it as having been anciently considered as a tree accursed; and says that the Romans wove wreaths of it, with which they crowned their criminals.

GENUS I.



TA'MARIX *Desv.* THE TAMARISK. *Lin. Syst.* Pentándria Trigýnia.

Identification. *Desv. Ann. Sc. Nat.*, 4. p. 348.; *Dec. Prod.*, 3. p. 95.; *Don's Mill.*, 2. p. 725.

Synonymes. The species of *Tamarix* of authors that have 4 stamens and 5 stamens; *Tamaris*, *Fr.*; *Tamarisken*, *Ger.*

Derivation. So called, according to some, from the plants growing on the banks of the river *Tamaras* now *Tambra*, on the borders of the Pyrenees; or, according to others, from the Hebrew word *tamaris*, cleansing, on account of their branches being used for brooms.

Description, &c. Tall shrubs, natives of Europe, the north of Africa, and the west of Asia; subevergreen in British gardens; and highly valuable, as standing the sea breeze in situations where few other ligneous plants, and no other flowering shrubs, will grow.

♣ 1. *T. GA'LLICA L.* The French Tamarisk.

Identification. *Lin. Sp.*, 386.; *Mill. Ic.*; *Dec. Prod.*, 3. p. 96.; *Don's Mill.*, 2. p. 726.

Synonymes. *T. narbonénsis Lob. Ic.*, 2. t. 218.; *Tamariscus gállicus All.*; *Tamariscus pentándrus Lam. Fl. Fr.*, not of *Pall.*

Engravings. *Mill. Ic.*, t. 262. f. 1.; *Blackw. Herb.*, t. 331.; *Lob. Ic.*, 2. t. 218.; *N. Du Ham.*, vol. vii. t. 59.; and our *fig.* 671.

Spec. Char., &c. Glabrous, glaucous. Leaves minute, clasping the stem or branch, adpressed, acute. Spikes of flowers lateral, somewhat paniced, slender, 5 times longer than broad. (*Dec. Prod.*, iii. p. 96.) Frequent in sandy places in France, on the shores of the Mediterranean Sea and of the Atlantic Ocean, as far as Poitiers; also found upon the banks of rivers in the south of Europe, north of Africa, and west of Asia: flowering from May to October. It is likewise a native of Tartary, Barbary, the Himalayas, and Japan; and it has been found wild in Cornwall, Hampshire, Sussex, and Suffolk, in England. It



671

was known to the Greeks by the name of *Myrica*, and to the Latins as *Tamarix*; and it is mentioned by Dioscorides as being effective in various diseases. Sir J. E. Smith says, "Commonly planted in English gardens and shrubberies, long before Archbishop Grindall imported this species or *T. germanica* (it is not clear which), to cure indurations of the spleen." (See Camden's *Life of Queen Elizabeth*, as quoted in *English Flora*, vol. ii. p. 112.) In favourable situations, in France, and in the south of Europe, it grows to the height of 15 ft. or 20 ft.; but there are instances, both in Britain and on the Continent, of its attaining the height of 30 ft. It prefers a deep, free, sandy soil; and will only attain a large size when it is in such a soil, and supplied by moisture from the proximity of some river, or other source of water. It is very abundant in the south of Russia and in Tartary, where a decoction of the young twigs is used by the Tartars in cases of rheumatism and bruises; and the handles of whips are made of the wood. In France and Italy, it is greedily eaten by sheep, on account, as it is supposed, of its saltish taste. In British gardens, its sole use is as an ornamental shrub, in which respect it is valuable as thriving on the sea shore, where few other shrubs will grow; as being nearly subevergreen; and as flowering late in the season, and for several months together. It is abundant in the gardens at Brighton; and at Aldborough, and Landguard Fort, in Suffolk. Planted singly, on a lawn, it grows with great rapidity, and forms a splendid heath-like bush, 10 ft. or 12 ft. high, in 4 or 5 years. It is readily propagated by cuttings, planted in autumn, in a sandy soil, with a northern exposure. The largest plants within ten miles of London are at Syon and Purser's Cross, where they are 15 ft. high, though not fine specimens, having been drawn up among other shrubs: but there is one in Lady Tankerville's garden, at Walton on Thames, which is 30 ft. high. Price of plants, in the London nurseries, 1s. 6d. each; at Bollwyller, 80 cents; at New York, 50 cents.

Varieties. In the *Linnaea*, 2. p. 267., 6 varieties of *T. gallica* are described. They are as follows:—

- ✱ *T. g. 1 subtilis* Ehrenberg in *Schlecht. Linnaea*, 2. p. 267., has branches subtile, effuse. Leaves glabrous, pale green, a little spreading. This may be considered the form of the species.
- ✱ *T. g. 2 narbonensis* Ehr., l. c.—Branches stiff, spreading. Leaves glabrous, obscure green, densely imbricated, margined with white; spikes of flowers short, rather lateral.
- ✱ *T. g. 3 nitida* Ehr., l. c., p. 269.—Branches effuse, rather loose. Leaves short, glaucous, spreading. Spikes elongated. Gland surrounding the ovary, hypogynous, with 10 equally distant teeth.
- ✱ *T. g. 4 arborea* Sieb. ex Ehrenberg, l. c.—Branches effuse, thickened, stiffish, nearly terete. Leaves glabrous, densely adpressed to the stem. Teeth of hypogynous gland usually approximate by pairs.
- ✱ *T. g. 5 mannifera* Ehr., l. c., p. 270.—Branches stiffish. Leaves short, glaucous, covered with white powder, spreading. Hypogynous gland with teeth at equal distances. The manna of Mount Sinai (noticed p. 947.) is the produce of this species. Of this there are two subvarieties.
- ✱ *T. g. 6 heterophylla* Ehr., l. c., p. 270.—Branches very slender. Leaves light green, glabrous, short, acute; the upper ones densely imbricated, the middle ones elongated and bluntish; lower rameal ones broad-ovate, flat. Spikes much elongated, all very slender.
- ✱ *T. g. 7 libanotica* Lodd. Cat. *The Rosemary-like Tamarisk*—There are plants of this variety in the Horticultural Society's Garden, and in the arboretum of Messrs. Loddiges, from which it appears to be tolerably distinct.

App. i. Other hardy Species or Varieties of *Tamarix*.

In De Candolle's *Prodromus*, and in Don's *Miller*, several hardy sorts of *Tamarix* are described, in addition to *T. gallica*, most of which are found in Siberia, Tartary, or Caucasus; and there are some tender species natives of the Canary Islands and Japan. Most of the hardy sorts described as species are, probably, only varieties of *T. gallica*; which, according to Pallas, assumes a great variety of forms, according to the soil, situation, and climate, to which it may be indigenous. The hardy sorts enumerated in Don's *Miller* are as follows; and none of them have yet been introduced:—

- T. tetrandra* Pal. Don's *Mill.*, 2. p. 723; *T. gallica* *Habl. ined. Taur.*, 6. p. 105.; is a native of Tauria, about Astracan.
- T. laxa* Willd. is a native of Siberia, in the valleys of Astracan, and about salt lakes.
- T. elongata* Led. is also a native of Siberia, in the Desert of Soongaria, in saltish places.
- T. gracilis* Willd. is found in Siberia, in salt marshes near the river Irtysh.
- T. hispida* Willd., *T. pentandra* var. *Pall.*, *T. gallica*, var. β *Willd.*, *T. tomentosa* *Smith*, *T. canescens* *Desv.*, is a native of the sandy deserts about the Caspian Sea.
- T. ramosissima* Led., *T. gallica* *Sievers*, is found at Lake Noor-Laisan, in Siberia.
- T. Pallasi* *Desv.*, *T. pentandra* *Pall.*, *T. gallica* *Bieb.*, *T. paniculata* *Stev.*, is a native of Cape Caucasus, and found in deserts about the Caspian Sea.
- T. cupressiformis* Led. is a native of Siberia, in the Desert of Soongaria, near salt lakes.
- T. parviflora* Dec. is cultivated about Constantinople; but its native country is unknown.
- T. tetrágyra* *Ehrenb.* is a native of the south of Europe.

T. effusa Ehrenb. is a native of the north of Africa.

Remark. The native localities of the above sorts, and their synonyms; the circumstance of *T. gállica* being found not only in Europe, but in Africa and Asia; together with the nature of the plant, which is extremely liable to vary with soil and situation; seem to us to render it highly probable that all the above sorts are only varieties of one and the same species. Whether or not they are worth keeping distinct as varieties, it is impossible to say from the description, without having seen the plants.

App. ii. Half-hardy Sorts of *Támarix*.

T. africána Poir. Don's Mill, 2. p. 726.; *T. gállica* var. γ Willd.; has the bark browner, and the flowers a little larger than in *T. gállica*. It is found on the shores of the Mediterranean, in Egypt, and in various parts of the Levant. It is considered as requiring the protection of a frame in England; which may, probably, be the case, till it has become inured to the climate, even if it should be only a variety of *T. gállica*.

T. canariénsis Willd. is a native of the Grand Canary Island and of Teneriffe, where it grows to the height of 5 ft. or 6 ft.

T. pycnocárpa Dec. is a native of the Levant, on the road side between Bagdad and Kermancha. *T. passerinóides* Del. Fl. Egypt. is a native of Arabia and Egypt, in arid places. Ehrenberg, in the *Linnaea*, as before quoted, has described three forms of this alleged species: *T. p. 1* divaricáta, a native of the Oasis of Jupiter Ammon; *T. p. 2* Hammónis, also a native of the Oasis; and *T. p. 3* macrocárpa, found in various parts of Arabia and Egypt.

Other species or sorts are enumerated in *Dec. Prod.* and *Don's Mill.*, which, being natives of India and Senegal, are considered as requiring the stove in Britain, and they are, consequently, omitted here; though, if they properly belong to the genus, they will, probably, be found half-hardy.

GENUS II.



MYRICA'RIA Desv. THE MYRICARIA. *Lin. Syst.* Monadélphia Decándria.

Identification. Desv. Ann. Sc. Nat., 4. p. 349.; Dec. Prod., 3. p. 97.; Don's Mill., 2. p. 727.

Synonymes. The species of *Támarix* of authors that have monadelphous stamens.

Derivation. From *miriké*, the Greek name of the tamarisk, derived from *mirō*, to flow; the species being generally found on the banks of running streams; or from the flowing of the sap as manna.

Description, &c. Subevergreen shrubs, not growing to half the height of *Támarix gállica*, and readily distinguished from it by their longer and thicker leaves, placed at a greater distance from one another on the stem; and by their larger flowers, which have 10 stamens. The propagation and culture are the same as those of the preceding genus.

* 1. M. GERMA'NICA Desv. The German Myricaria, or German Tamarisk.

Identification. Desv. Ann. Sc. Nat., 4. p. 349.; Dec. Prod., 3. p. 97.; Don's Mill., 2. p. 727.

Synonymes. *Támarix germánica* *Lin. Sp.*, 386., *Schkuhr Handb.*, t. 35.; *Tamariscus decándrus*

Lam. Fl. Fr.; *Támarix decándra* *Mench*; *Tamariscus germánicus* *Lob. Ic.*, 2. t. 218.; *Tamaris* d'Allemagne, *Fr.*; *Deutschen Tamarisken*, *Ger.*

Engravings. *Mill. Ic.*, t. 262. f. 2.; *Schkuhr Handb.*, t. 35.; *Lob. Ic.*, 2. t. 218.; and our *fig.* 672.

Spec. Char., &c. Fruticlose, glabrous. Leaves linear-lanceolate, sessile. Spikes of flowers terminal, solitary. Bractees longer than the pedicels. Capsules ascending. (*Dec. Prod.*, iii. p. 97.) A native of inundated sandy places, and the banks of rivers, throughout all Europe; and, in Asia, found on Caucasus, and the Himalayas. It was introduced into Britain in 1582, and, it is supposed, by Archbishop Grindall. It grows to the height of 6 ft. or 8 ft., and flowers from June to September.



* 2. M. DAHU'RICA Dec. The Dahurian Myricaria.

Identification. Dec. Prod., 3. p. 98.; Don's Mill., 3. p. 728.

Synonyme. *Támarix dahúrica* *Willd. Act. Berol.*, No. 16.

Spec. Char., &c. Shrubby, glabrous. Leaves linear, almost oblong, sessile, slightly spreading. Spikes of flowers lateral, ovate-cylindrical, thick, blunt, with scales at the base. Bractees extending as far as the flowers. (*Dec. Prod.*, iii. p. 98.) A native of Siberia, beyond the Baikal, and of Dahuria. Introduced in 1816, and growing to the height of 6 ft. or 8 ft.

App. i. Other Sorts of *Myricaria* not yet introduced.

M. squamosa Desv., Ann. Sc. Nat., 4. p. 350., Don's Mill., 2. p. 728., is probably only a variety of *M. dahurica*.

M. longifolia Dec., Don's Mill., 2. p. 728.; *Tamarix germanica* Pall.; *T. decandra* Pall.; *T. longifolia* Willd.; *M. linearifolia* (Desv.) is a native of Siberia, at the Baikal, in saltish places. There are two forms of it described by Ehrenberg, in the *Linnaea*. It grows to the height of 5 ft. or 6 ft.

M. herbacea Desv., *Tamarix germanica subherbacea* Pall., appears to be a variety of *M. germanica*, as are, probably, all the other sorts above mentioned. The leaves and young shoots of this sort are used by the Mongolians as tea, and are administered by the priests of Tibet as medicine.

M. bracteata Royle Illust., p. 214. t. 44., is found in the vicinity of Cashmere.

M. elegans Royle, l. c., is found at Lipra and Kunawar, where the climate resembles that of Tartary, and the soil is saline.

Both these Nepal species will probably prove hardy in Britain, when introduced.

CHAP. XLVIII.

OF THE HARDY LIGNEOUS PLANTS OF THE ORDER PHILADELPHACEÆ.

THE hardy ligneous genera of this order are only two, and their characteristics may be taken together, as representing those of the order.

PHILADELPHUS L. Calyx with an obovate top-shaped tube that adheres to the ovary: the limb is in 4—5 parts. Petals 4—5, in æstivation convolutedly imbricate. Stamens 20—40, inserted into the throat of the calyx, in 1—2 series, shorter than the petals; the filaments distinct. Styles 4—5, in some instances connate, in others more or less distinct. Stigmas 4—5, oblong or linear, in most instances distinct, in a few connate. Capsule half adnate to the calyx, of 4—5 cells, and enclosing many seeds. Seeds resembling sawdust; individually awl-shaped, smooth, and included in an oblong, lax, membranous aril, that in some instances is fringed: they are grouped upon an angular placenta, in the angles of the cells. Albumen fleshy. Embryo inverted, almost as long as the albumen. Cotyledons oval-obtuse, flattish. Radicle rather taper, longer than the cotyledons, straight, obtuse. Shrubs or undershrubs, from the temperate regions of the northern hemisphere, and some of them from Western Asia. Leaves opposite, nerved, dentate or almost entire. Flowers white, pedicled upon axillary or terminal peduncles, that are branched in a trichotomously cymose, or in a somewhat panicled, manner, bracteated. (*Dec. Prod.*, iii. p. 205.)

DECUMARIA L. Calyx with its tube bell-shaped; its limb with 7—10 teeth. Petals as many as the teeth of the calyx, alternate with them, oblong. Stamens thrice as many as the petals, 2 in front of every petal, 1 between every 2 petals, all in 1 whorl. Style 1, very thick, expanded at the tip into a disk that bears 7—10 radiating stigmas. Capsule of egg-like figure, terminated by the style and stigma, and connate with the calyx to higher than the middle. The calyx has 7—10 nerves, and is toothless. The capsule has 7—10 cells, is valveless, and opens irregularly near the rather prominent nerves of the calyx. Seeds numerous, oblong, each enclosed in a membranous aril, and obliquely affixed to the centre. A sarmentose shrub. Leaves opposite, glabrous, entire, or dentate at the tip. Leaf buds hairy with short reddish hairs. Flowers white, sweet-scented, terminal, disposed subcorymbosely. The sexes are sometimes diœcious in gardens. (*Dec. Prod.* iii. p. 206.)

DEUTZIA Thunb. is a genus closely allied to *Philadelphus*; and it is highly probable that some of the species will ultimately be found to be as hardy as those of that genus; but, as this has not yet been proved to be the case, we have treated it as only half-hardy.

GENUS I.



PHILADELPHUS L. THE PHILADELPHUS, or MOCK ORANGE.
Lin. Syst. Icosándria Monogýnia.

Identification. Lin. Gen., No. 614.; Gærtn. Fruct., 1. p. 173. t. 35.; Dec. Prod., 3. p. 205.; Don's Mill., 2. p. 806.

Synonymes. *Syringa* Tourn. Inst., t. 389, not of Lin.; *Philadelphus*, *Fr.*; Pfeifenstrauch (Pipe Shrub), *Ger.*; Pipe Privet, *Gerard*; the *Syringa* of the gardens.

Derivation. *Philadelphus* is a name used by Athenæus for a tree which cannot now be identified: Bauhin applied it to this genus. (*Encyclopædia of Plants*, p. 415.) Instead of the common trivial name *Syringa*, applied to this genus in gardens, as its English name, we have substituted its generic name, *Philadelphus*; *Syringa* being the generic name of the lilac.

Description. Deciduous shrubs, natives of Europe, North America, and Asia; cultivated for their very showy white flowers; most of which have a strong scent, resembling, at a distance, that of orange flowers, but, when near, disagreeably powerful. All the species are of the easiest culture in any tolerably dry soil; and they are all propagated by layers, or by suckers or cuttings. The only sorts in the Horticultural Society's Garden, which are truly distinct, either as species or varieties, are *P. coronarius*, *P. (c.) inodorus*, *P. verrucosus*, *P. laxus*, *P. (l.) grandiflorus*, *P. hirsutus*, and *P. tomentosus*. The price of plants, in British nurseries, varies from 9d. to 1s. 6d. each; at Bollwyller, from 50 cents to 2 francs; and at New York, from 25 cents to half a dollar.

§ i. *Stems stiff and straight. Flowers in Racemes.*

✻ 1. *P. CORONARIUS* L. The garland *Philadelphus*, or *Mock Orange*.

Identification. Lin. Sp., 671.; Schrad. Diss.; Dec. Prod., 3. p. 205.; Don's Mill., 2. p. 807.

Synonyme. *Syringa suavæolens* *Manch Meth.*, 678.

Engravings. Bot. Mag., t. 591.; Schkuhr Handb., t. 121.; Lam. Ill., t. 420.; and our fig. 673.

Spec. Char., &c. Leaves ovate, acuminate, serrately denticulate, 3-nerved, rather glabrous, but hairy upon the veins beneath; inflorescence racemose. Flowers sweet-scented. Lobes of the calyx acuminate. Styles distinct almost from the base, not exceeding the stamens in height. A native of the south of Europe, but not common there. (*Dec. Prod.*, iii. p. 205.)

Varieties. This species varies in having its leaves sometimes perfectly glabrous beneath, and sometimes slightly pubescent along the nerves; and, besides, as follows:—

✻ *P. c. 1 vulgâris* Schkuhr Handb., t. 121., Lam. Ill., t. 420., Dec. Prod., iii. p. 205.—A shrub of about the height of a man. Leaves ovate-oblong, large, and rather distant.

✻ *P. c. 2 nanus* Mill. Dict., 2.—A shrub, 2 ft. high; its branches and leaves crowded, and its flower-bearing branches incurved. It very seldom flowers, and it is not known of what country it is a native.

✻ *P. c. 3 flore pleno* Lodd. Cat. is a dwarf plant, like the above, but with double flowers.

✻ *P. c. 4 variegatus* Lodd. Cat. has the leaves variegated with white or yellow, and is one of the few varieties of deciduous shrubs, which preserve, through the summer, a tolerably healthy appearance with their variegation.

Description, &c. The common syringa, or mock orange, is a shrub of 10 ft. or 12 ft. in height, crowded with slender upright shoots, which are produced from the base, and along the sides of the stem. These shoots are clothed with a white bark, and interiorly they have a very large pith. The leaves are rough, and of a deep green above, though they are pale beneath. The flowers come out from the sides and ends of the branches, in loose bunches, during the



months of May and June, before any of the other species of the genus. The flowers smell like those of the orange, and the leaves taste like the fruit of the cucumber. Very little is known as to the native country of this species. In the *Nouveau Du Hamel* it is considered as indigenous to Switzerland; and Pallas is said to have found it in beech forests on Caucasus. In the time of Miller, it was unknown of what country it was a native. Clusius, who, in the sixteenth century, observed plants of it in Spain, Austria, and Hungary, says that he never found it any where in a wild state; and that it was introduced into these countries from Belgium, where it was first cultivated in Europe. It was known to the ancients, and cultivated by the Parthians in the same country where Pallas found it in a wild state. (See *Apollodorus*, book iv., as quoted in the *Nouveau Du Hamel*, i. p. 71.) It was first brought into notice, in modern times, by Bauhin; and it is now, owing to the extreme hardness of the plant, to be found in almost every garden from Lisbon to Naples, and from the Mediterranean to Stockholm and Petersburg. It is one of the few shrubs that can be used to decorate the gardens of the latter cities; though not without some protection during winter. In British gardens, it has been known since the time of Gerard, who had plants of it growing in his garden, "in the suburb of Holborne, in verie great plentie." The flowers are used to give their perfume to pomatum. It will grow in almost any situation, whether open or shady; and it is easily propagated by division of the root, and by suckers, layers, or cuttings. The general mode of propagation, in British nurseries, is by taking up the plants, and dividing them.

♣ 2. *P. (C) INODORUS* L. The scentless-flowered Philadelphus, or Mock Orange.

Identification. Lin. Sp., 671.; Catesb. Car., 2. t. 84.; Pursh Flor. Amer. Sept., 1. p. 329.; Sims Bot. Mag., t. 1478.; Dec. Prod., 3. p. 206.; Don's Mill., 2. p. 808.; Lodd. Cat., ed. 1836.

Synonymes. *Syringa inodora* March; *P. laxis* in various English gardens

Engravings. Catesb. Car., 2. t. 84.; Bot. Mag., t. 1478.; and our fig. 674.

Spec. Char., &c. Leaves broad-ovate, acuminate, perfectly entire, 3-nerved, usually feather-nerved. Flowers singly, or in threes. Style, at the very tip divided into 4 oblong stigmas. A native of South Carolina, upon the banks of rivers: very rare. Recent botanists do not find it in Carolina. (*Dec. Prod.*, iii. p. 206.) Introduced into British gardens in 1738, and to be found in various collections. It is a somewhat rambling shrub, not quite so high, nor altogether so hardy, as *P. coronarius*; though it appears to be only a variety of that species. There are plants in the arboretum of Messrs. Loddiges, and in the Vauxhall Nursery, and they are easily recognised from every other sort, by having the leaves perfectly entire.



674

♣ 3. *P. (C) ZEYHERI* Schrad. Zeyher's Philadelphus, or Mock Orange.

Identification. Schrad. Diss. Philad.; Dec. Prod., 3. p. 205.; Don's Mill., 2. p. 807.

Engraving. Schrad. Diss. Philad., ic.

Spec. Char., &c. Not so tall as *P. c. vulgaris*. Leaves ovate, acuminate, serrately denticulate, rounded at the base, 3-nerved, hairy upon the veins beneath. Inflorescence somewhat racemose. Flowers fewer and larger than in *P. c. vulgaris*, and scentless. Lobes of the calyx long, acuminate. Style deeply 4-cleft. A native of North America. It differs from *P. c. vulgaris*, chiefly in its leaves being rounded at the base, and in its flowers being fewer, larger, and scentless. (*Dec. Prod.*, iii. p. 205.) There is a plant in the Horticultural Society's garden.

♣ 4. *P. VERRUOSUS* Schrad. The warted Philadelphus, or Mock Orange.

Identification. Schrad. Diss. Philad.; Dec. Prod., 3. p. 205.; Don's Mill., 2. p. 807.

Synonyme. *P. grandiflorus* Lindl. Bot. Reg., t. 570., Lodd. Cat. ed. 1836.

Engravings. Bot. Reg., t. 570.; and our fig. 675.

Spec. Char., &c. Leaves elliptic-ovate, acuminate, denticulate, pubescent with hairs beneath, and bearing beneath, upon the midrib and primary veins, warts

at the base of the hairs. Similar warts are, also, on the peduncles, pedicels, and calyxes. Inflorescence racemose. Lobes of the calyx acuminate. Style, at the very tip, 4-cleft. (*Dec. Prod.*, iii. p. 206.) A native of North America. Introduced in 1800, or before; and forming a vigorous-growing shrub, 8 ft. or 10 ft. high, or more, with young shoots twice the thickness of those of *P. coronarius*, and having a somewhat more fastigiate habit. *P. speciosus* Schrad. appears to be only a variety of this species. When in flower, this sort and the two following make a splendid appearance; the plants, in fine seasons, being so entirely covered with bloom as scarcely to show the leaves. To give them a gardenesque character, they ought to stand singly, with abundance of room, and have all their suckers removed as they are produced, so as to leave each bush with only a single stem.



675

♣ 5. *P.* (v.) *LATIFOLIUS* Schrad. The broad-leaved Philadelphus, or *Mock Orange*.

Identification. Schrad. Diss. Philad.; Dec. Prod., 3. p. 206.; Don's Mill., 2. p. 807.; Lodd. Cat., edit. 1836.

Synonymy. *P. pubescens* Cels Hort., Loes. Herb. Amat., t. 208.

Engravings. Loes. Herb. Amat., t. 208.; and our fig. 676.

Spec. Char., &c. Bark whitish. Leaves broad-ovate, acuminate, toothed, nerved with about 5 nerves, and pubescent with hairs beneath. Flowers in racemes. Lobes of the calyx acuminate. Style 4-cleft at the very tip. A native of North America. It is distinguishable by its bark being whitish; and by its leaves, especially those of the younger branches, being more broadly ovate; and by the hairs they bear not being based by warts. (*Dec. Prod.*, iii. p. 206.) There are plants in the Garden of the London Horticultural Society, and in the arboretum of Messrs. Lodiges; and they appear to us to be nothing more than a variety of *P. verrucosus*. As a tolerably distinct variety, however, and as a splendid plant when in flower, it is well deserving of cultivation.



678

♣ 6. *P.* (v.) *FLORIBUNDUS* Schrad. The abundant-flowered Philadelphus, or *Mock Orange*.

Identification. Schrad. Diss. Philad.; Dec. Prod., 3. p. 205.; Don's Mill., 2. p. 807.

Engraving. Schrad. Diss. Philad., ic.

Spec. Char., &c. Leaves ovate-oval, and with a long acuminate tip, serrately toothed, 3-nerved, pubescent, with hairs beneath. Inflorescence subracemose. Flowers 5—7, showy, slightly scented. Lobes of the calyx long and acuminate. Style 4-cleft at the very tip. (*Dec. Prod.*, iii. p. 205.) A native of North America, which has been some years in British gardens,

where it grows to the height of 6 ft. or 8 ft., flowering in May and June. The plant with this name in the Horticultural Society's Garden appears to be only a variety of *P. verrucosus*.

§ ii. *Stems more slender, rambling, twiggy, and loose. Flowers solitary, or 2 or 3 together.*

7. *P. LA'XUS* Schrad. The loose-growing Philadelphus, or Mock Orange.

Identification. Hortul.; Schrad. Diss. Philad.; Dec. Prod., 3. p. 206.; Don's Mill., 2. p. 807.

Synonymes. *P. humilis* Hortul.; *P. pubescens* Lodd. Cat., edit. 1836.

Engravings. Schrad. Diss. Philad., ic.; and our fig. 677.

Spec. Char., &c. Leaves oval-ovate and with a long acuminate tip, toothed, pubescent with hairs beneath. Flowers solitary, 2 or 3 together. Lobes of the calyx very long, acuminate. Style 4-cleft. Stigmas about level with the stamens. (*Dec. Prod.*, iii. p. 206.) A native of North America. Introduced about 1830; and, according to the specimens in the Horticultural Society's Garden, and at Messrs. Loddiges, a rambling sarmentose shrub, growing to the height of 3 ft. or 4 ft., with somewhat pubescent leaves, and brown shoots; apparently, the tenderest of the genus.



677

8. *P. (L.) GRANDIFLO'RUS* Willd. The large-flowered Philadelphus, or Mock Orange.

Identification. Willd. Enum., 1. p. 511.; Guimp. Abb. Holz., t. 44.; Schrad. Diss. Philad.; Dec. Prod., 3. p. 206.; Don's Mill., 2. p. 807.

Synonymes. *P. inodorus* Hortul.; *P. laxus* Lodd. Cat., edit. 1836.

Engravings. Guimp. Abb. Holz., t. 44.; Schrad. Diss. Philad., ic.; and our fig. 676.

Spec. Char., &c. A shrub, 10 ft. or 12 ft. high. Epidermis of the branches of a reddish brown colour. Leaves ovate, with a long acuminate tip, denticulate, 3-nerved, hairy upon the veins, and with groups of hairs in the axils of the veins. Flowers about 3 together, or solitary; scentless. Lobes of the calyx long, acuminate. Styles, concrete into one which extends beyond the stamens. Stigmas 4, linear. (*Dec. Prod.*, iii. p. 206.) A native of North America; introduced into British gardens in 1811. A loose, rambling shrub, seldom exceeding 4 ft. or 5 ft. in height, and differing in *P. laxus* chiefly in having more pubescence on the leaves, and considerably larger flowers.

9. *P. HIRSU'TUS* Nutt. The hairy-leaved Philadelphus, or Mock Orange.

Identification. Nutt. Gen. Am., 1. p. 301.; Dec. Prod., 3. p. 206.; Don's Mill., 2. p. 808.

Synonymes. *P. villosus* Lodd. Cat.; *P. gracilis* Lodd. Cat.

Engravings. Wats. Dend. Brit., t. 47.; and our figs. 678, 678 a.

Spec. Char., &c. Leaves oblong-ovate, acute, dentate, 5-nerved, hairy on both surfaces, whitish on the under one. Flowers singly, or by threes. Styles concrete to the tip. Stigmas undivided. Frequent in rocks of



678

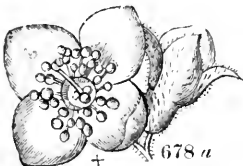

678 a

North America, in Tennessee, by the river French. (*Dec. Prod.*, iii. p. 206.) Introduced into British gardens in 1820, where it grows to the height of 3 ft., flowering in June. This is a hairy sarmentose shrub, distinct from all the other sorts; and which would, probably, grow to the height of 20 ft. or

30 ft., if trained against a wall, or drawn up among trees, and other shrubs. A plant, which we received from Colonel Carr, of Bartram's Botanic Garden, near Philadelphia, in 1830, produced, in our garden at Bayswater, trailing shoots from 6 ft. to 8 ft. long, in one season.

* 10. *P. TOMENTOSUS* Wall. The woolly-leaved Philadelphus, or *Mock Orange*.

Identification. Wall. Cat., 3658.; Don's Mill., 2. p. 807.

Synonymes. *P. nepalensis* Lodd. Cat. edit. 1836; ? *P. triflorus* Royle.

Engraving. Royle Illust., t. 46. f. 1.

Spec. Char., &c. Leaves ovate, acuminate, denticulate, tomentose beneath. Racemes terminal. Pedicels opposite. Lobes of calyx ovate, acute. (*Don's Mill.*, ii. p. 807.) A native of Nepal and Kamaon. Introduced in 1822; and growing to the height of 5 ft. or 6 ft. *P. triflorus*, Royle observes, is, probably, only *P. tomentosus* in a less advanced state. There are plants of this very distinct species in the arboretum of Messrs. Loddiges, and in the Hammersmith Nursery, but they have not yet flowered.

GENUS II.



DECUMARIA L. THE DECUMARIA. *Lin. Syst.* Dodecándria Monogýnia.

Identification. *Lin. Gen.*, No. 597.; *Lam. Ill.*, t. 403.; *Don's Mill.*, 2. p. 808.

Synonyme. *Forsythia* Walt., not of Vahl.

Derivation. From *decuma*, a tenth; in reference to the prevailing number, in some of the parts of fructification, being ten. In De Candolle's description of the genus, it is stated that the teeth and nerves of the calyx, the petals, the stigmas, and the cells of the capsule, are each usually ten.

Description. A deciduous trailing and rooting shrub. A native of Lower Carolina, in shady places. Introduced in 1785; but, being of little beauty, and somewhat tender, not frequent in collections. It will grow in any dry soil, and is readily propagated by cuttings.

* 1. *D. BARBARA* L. The barbarous Decumaria.

Identification. *Lin. Sp.*, No. 1668.; *Dec. Prod.*, 3. p. 206.; *Don's Mill.*, 2. p. 808.

Synonymes. *D. radicans* *Manch Meth.*, 17.; *D. Forsythia* *Michx. Fl. Bor. Amer.*, 1. p. 282.; *D. prostrata* *Lodd. Cat.*

Engravings. *N. Du Ham.*, 6. t. 20.; and our *figs.* 679, 680.

Spec. Char., &c. A sarmentose shrub. Leaves ovate-oblong, acute at both ends, glabrous, entire or toothed at the tip. Buds hairy with short rufous hairs. (*Dec. Prod.*, iii. p. 206.) The flowers, which appear in July and August, are sweet-scented; but they are only produced in favourable situations; and the plant seldom rises above 4½ ft. or 5 ft., in the open air, in the climate of London. The only place in which we have seen a vigorous growing plant of: *Decumaria* is in the garden of the Rev Thomas Garnier, at Bishop Stoke, in Hampshire, where, in 1834, it had attained the height of 12 ft., trained against a wall. To what the specific name applies we do not know.

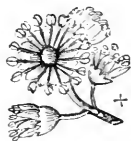

679



680

Variety.

* *D. b. 2 sarmentosa* *Dec. Prod.*, iii. p. 206.; *D. sarmentosa* *Bosc Act. Soc. Hist. Nat. Par.*, i. p. 76. t. 13., *Hort. Brit.*; *Forsythia scandens* *Walt. Car.*, 154.—Lower leaves rounded; upper leaves ovate-lan-

ceolate. (*Dec. Prod.*, iii. p. 206.) A native of moist shaded places in Virginia and Carolina. Judging from the plant in the Horticultural Society's Garden, it only differs from the species in being a little more vigorous.

App. I. *Half-hardy ligneous Plants of the Order Philadelphææ.*

Deutzia scabra Thunb. (*Don's Mill.*, 2. p. 808. ; *Bot. Reg.*, t. 1718. ; and our *fig.* 681.) is a climbing or an ascending shrub, with ovate, acuminate, serrated leaves; scabrous stellate hairs; and with white flowers, in compound panicles. It is a native of Japan, where the leaves are used by joiners in smoothing and polishing. It was introduced in 1822; grows to the height of 6 ft. or 7 ft., flowering in May or June; and appears to be as hardy as *Caprifolium japonicum*. It is a very showy free-flowering plant, and deserves a place in every collection. It is readily propagated by cuttings or layers, and thrives in any light soil, trained to a wall, and slightly protected during severe frosts. Plants, in the London nurseries, are 5s. each.

D. corymbosa R. Br., *Don's Mill.*, 2. p. 808., *Royle Illust.*, t. 46. f. 2.; *Philadelphus corymbosus* *Wall.*; has glabrous leaves, and white flowers. It is a native of Kamaon; grows to the height of 3 ft. or 4 ft., and probably is as hardy as the preceding sort. (See p. 173.) There are plants in the London Horticultural Society's Garden.

D. staminea R. Br., *Philadelphus stamineus* *Wall.*, has entire, scabrous, lanceolate leaves, and white sweet-scented flowers. It is a native of Nepal, on high mountains; but it is not yet introduced.

D. Brundia *Wall.*, *Leptospermum scabrum* *Wall.*, has ovate leaves, and axillary white flowers. It is a native of Kamaon, but has not yet been introduced. The last three sorts are probably only varieties of one form.



CHAP. XLIX.

OF THE HALF-HARDY LIGNEOUS PLANTS OF THE ORDER MYRTACEÆ.

THIS is one of the most natural groups of woody plants; and, in general, may be easily recognised by its opposite entire leaves, full of transparent dots; which indicate the presence of an oil which is fragrant, aromatic, pungent, volatile: hence the grateful perfume of the leaves, flowers, and fruit of the greater number of plants belonging to this order. Like most highly aromatic woody plants, the species are chiefly inhabitants of warm climates. The common myrtle is a native of Europe; but all the other genera belong to North or South America, Africa, Asia, or Australia. A great many of the species are very suitable for a conservative wall, from their being evergreen, and from the beauty of their foliage and flowers; and many of them, in the neighbourhood of London, require little more protection than the common myrtle. All the species may be readily propagated by cuttings. The half-hardy, or greenhouse, species, cultivated in British gardens, will be found arranged in the four following groups:—I. *Melaleucæ*; II. *Euleptospermæ*; III. *Myrtæ*; and IV. *Chamælaucicæ*.

Sect. I. MELALEUCÆ. *Stamens polyadelphous. Fruit dry.*

Tristania nerifolia R. Br.; *Melaleuca nerifolia* *Sims Bot. Mag.*, t. 1058. ; *M. salicifolia* *Bot. Rep.*, t. 485. ; and our *fig.* 682. ; is a native of New South Wales, introduced in 1804, and flowering from

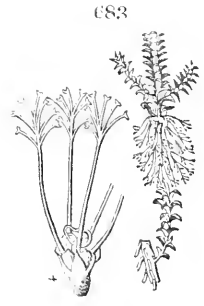

June to September. In its native country, it is a tree growing to the height of from 20 ft. to 30 ft. There has been a stool of this species in the American ground of the Kensington Nursery, for upwards of 30 years, which, though protected by mats during winter, shows the species to be tolerably hardy. There are several other species described, but very few of them have yet been introduced. (See *Don's Mill.*, ii. p. 813.)

Beaufortia decussata R. Br. (*Bot. Reg.*, t. 18.; *Bot. Mag.*, t. 1733.; and our fig. 683.) is a native of New Holland, introduced in 1800, and producing its scarlet flowers from May to July. It attains, in green-houses, the height of 8 ft. or 10 ft., growing freely, and flowering abundantly every year; and, doubtless, would be very suitable for a conservative wall. It, and all the species of the preceding genus, and following genera, are of the easiest propagation and culture in sand and peat.

Calothamnus villosa R. Br. (*Bot. Reg.*, t. 1099.; and our fig. 684.) is a native of New Holland, introduced in 1823, growing to the height of 4 ft. or 5 ft., and producing its splendid scarlet flowers from July to September. *C. gracilis* R. Br., *C. quadrifida* R. Br. *Bot. Mag.*, t. 1506, and *C. clavata* Cunningham., from New Holland, are also in British gardens. The first is the most common.

Melaleuca squamea Labill. (*Bot. Reg.*, t. 477.) is a native of Van Diemen's Land, where it forms a middle-sized tree, with lanceolate leaves, and lilac flowers. Introduced in 1805, and flowering in June and July.

M. linearifolia Smith *Exot. Bot.*, t. 56.; *Metrosideros hyssopifolia* Cav.; the Tea Tree of New Holland; and our fig. 685., representing a full-grown tree in the neighbourhood of Sydney, upwards of 30 ft. high; is a native of New South Wales, and has green-coloured flowers, which are produced in July and August. It has been in the country since 1793.



M. pulchella R. Br., *Bot. Cab.*, t. 200., is a native of New Holland, on the south coast, with reddish flowers, which are produced from June to September. It was introduced in 1803, and grows to the height of 3 ft.

M. hypericifolia Smith (*Bot. Reg.*, t. 200.; and our fig. 687.) is a native of New South Wales, introduced in 1792. Its flowers are of a splendid scarlet, and they are produced from June to August.

M. squarrosa Smith *Bot. Mag.*, t. 1935., has yellowish flowers. It is a native of Van Diemen's Land, where it grows to the height of 40 ft.; and was introduced in 1794.

There are above a dozen other species in British gardens, all well deserving a place against a conservative wall. In Italy, some species of this genus have attained the height of 30 ft. or 40 ft., in a very few years. (See p. 168.)

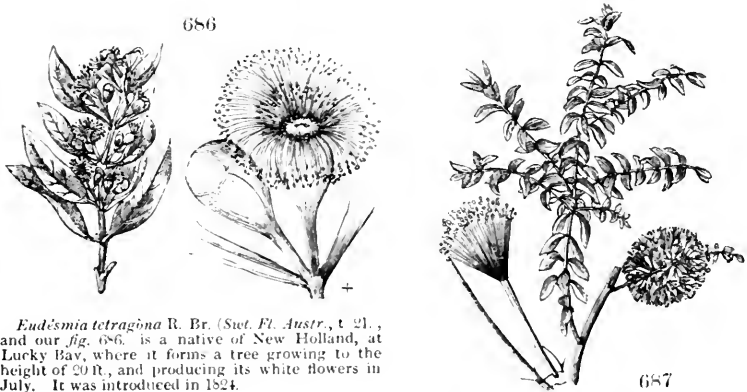

Eudœmia tetragōna R. Br. (*Swt. Fl. Austr.*, t. 21., and our fig. 686. is a native of New Holland, at Lucky Bay, where it forms a tree growing to the height of 20 ft., and producing its white flowers in July. It was introduced in 1824.

SECT. II. EULEPTOSPE'RMEÆ. *Stamens free. Fruit dry.*

The genus *Eucalyptus* is a very remarkable one. The name is derived from *eu*, well, and *kalyptō*, to cover as with a lid; in reference to the limb of the calyx covering the flower before expansion, and afterwards falling off in one piece, in the shape of a lid or cover. The calyx is cup-shaped. Petals wanting. Stamens numerous and free. Capsule 4-celled, and many-seeded. The leaves quite entire, and coriaceous. Peduncles axillary, and bearing an umbel of 3—15 flowers, which are white. The genus consists of above 100 species, or varieties, all timber trees, growing to a great height, and natives of New Holland and Van Diemen's Land. Those belonging to the latter country appear to be decidedly half-hardy in the neighbourhood of London; some of them, as *E. robūsta* and *E. pulverulēnta*, are almost quite hardy; and, in the south of England, probably most of the species, if planted so as to form one entire wood, would protect one another; and, if they did not attain the size of timber trees, would, at least, form a dense Australian copse. The chief reason why these trees do not appear hardier in England is, that our summers are not sufficiently hot thoroughly to ripen their wood; for it appears that, in the mountains of Van Diemen's Land, they are subject to be frequently covered with snow. In Italy, as we have seen in p. 168., several of the species of this genus have attained the height of 100 ft. in a very few years; and in their native country, as it appears from the information communicated in p. 186., the height of 200 ft. is by no means unknown. We have had a number of portraits of full-grown trees of this and other genera made for us in the neighbourhood of Sydney, by our friend Mr. Thompson, an eminent artist, resident there; and engravings from some of these drawings will be found under their respective species. The wood of this genus is very durable. Dr. Laing states that a stump of the blue gum tree (*E. piperita*) remained in the ground, quite sound, for 35 years after the tree had been cut down. (*Hist. and Stat.*, &c.) The terms red, blue, and white gum trees, as applied to different species of this genus, have reference to the colour of the bark. The bark contains a great proportion of tannin, and is said to be twice as powerful in its operation as that obtained from the oak.

Eucalyptus resinifera Smith (*Bot. Rep.*, t. 400.; and our figs. 688, 689, 691: fig. 688. represents the different parts of the flower, and fig. 691 is the portrait of a tree 200 ft. high), the *Iron Bark Tree*, is a native of New Holland, where it produces a resin, which, for all medical purposes, is considered equal to kino. It was introduced into Britain in 1788, and flowers from April to July. In its native country, it is from 150 ft. to 200 ft. high. A tree at Saxmundham in Suffolk, sown by the widow of Sir J. E. Smith, is upwards of 20 ft. high, with two stems, each of which is as thick as a man's leg. About London, it requires very little protection, when planted against a wall.

E. robusta Smith, the *Stringy Bark Tree*, (see our plate of a young tree in Vol. II.) is a native of New Holland, growing to the height of upwards of 100 ft., which stands the open air, in mild winters, in the neighbourhood of London. The leaves are large, and the entire plant has a magnificent appearance. There are plants in the Horticultural Society's Garden, at W. Bromley's, Esq., Stamford Hill, and at some other places in the neighbourhood of London.



E. viminàlis Labill. Nov. Holl. ii. p. 12. t. 151. and our figs. 692. and 693., is a tree, a native of Van Diemen's Land, with the leaves linear-lanceolate and flowers sessile, three on the top of each peduncle. It was introduced in 1810.

E. amygdolina Labill. Nov. Holl. ii. p. 14. t. 154.; *E. globularis* Hort.; and our figs. 694 and 695.; has linear-lanceolate leaves, attenuated at



the base, and acuminately mucronate at the apex. Peduncles axillary and lateral; and umbels 6—8. flowered, nearly capitate. It is a native of Van Diemen's Land. Introduced in 1820.

E. piperita Smith, and our figs. 696. and 690. (the latter of a tree 50 ft. high, in the neighbourhood of Sydney), the *Blue Gum Tree*, has leaves from 4 in. to 7 in. long, and 1 in. broad, shining on both surfaces. It is a native of New Holland, where it forms a lofty tree; and, in this country, it is almost as hardy as *E. robusta*.

E. cordata Labill. Nov. Holl. ii. p. 13. t. 152., and our fig. 698., has the lid of the capsule depressed, and shorter than the cup, which is obovate. Flowers 3—4 in each head. There is a tree at W. Bromley's, Esq., Stamford Hill, which appears tolerably hardy.

E. pulverulenta Sims Bot. Mag., t. 208.; *E. cordata* Hort. Berol.; and our fig. 697.; is a native of a lofty tree in its native country, and seems tolerably hardy in the neighbourhood of London. There are trees of this species in the Horticultural Society's Garden; in the arboretum at Kew; and one 20 ft. high in the garden of William Bromley, Esq., at Stamford Hill, all of which flower freely every year. The latter had been 10 years planted in 1825, without receiving any protection whatever.

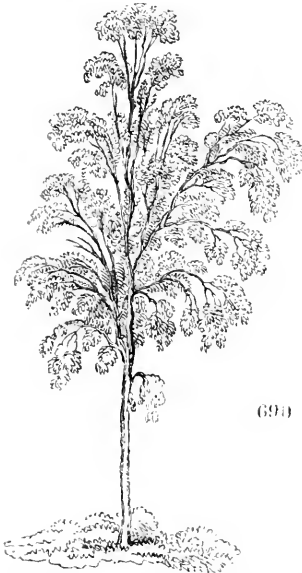

(691)

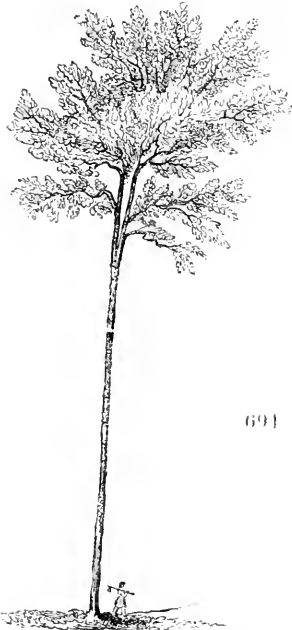

(692)

E. diversifolia Bonpl., *E. comata* Dim. Cours., *E. piperita* Hort. Berol., *E. heterophylla* Swt., *E. angustifolia* Hort., is a native of New Holland, with lanceolate, acuminated leaves, where it forms a lofty tree. Plants in the Horticultural Society's Garden have stood out three years, but are not found so hardy as *E. pulverulenta*, *E. robusta*, *E. resinifera*, and *E. piperita*.

Several other species of *Eucalyptus* are in British gardens; and there is probably no very great difference in their degree of hardiness. It is much to be wished that proprietors in the South of England would encourage their gardeners to plant out these, and other Australian trees, in dry sheltered places in their shrubberies and woods. The plants cost little; and seeds are very frequently imported, and might be sent home in the greatest abundance if there were a demand for them.

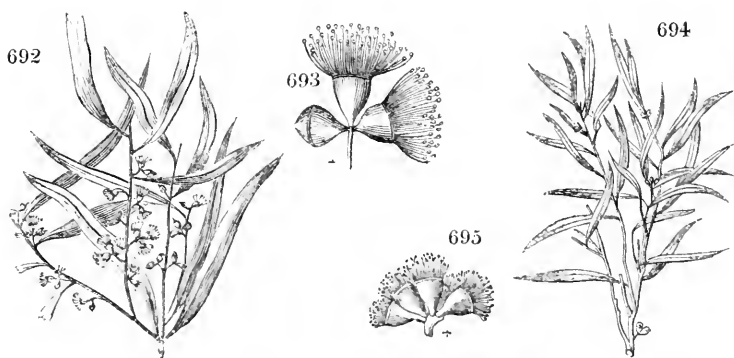

Angophora cordifolia Cav., *Metrosideros hispida* Smith, (*Bot. Mag.*, t. 1960.; and our fig. 699.) is a native of New Holland, with yellowish flowers, rather large, which are produced from May to August. In British green-houses, it is a shrub, seldom growing to the height of more than from 8 ft. to 10 ft. It was introduced in 1789.

A. lanceolata Cav., the *Apple Tree* of New Holland, *Metrosideros splendens* Gert., (see our fig. 702., which is a portrait of a tree, in the neighbourhood of Sydney, 60 ft. high,) is a native of Port Jackson,

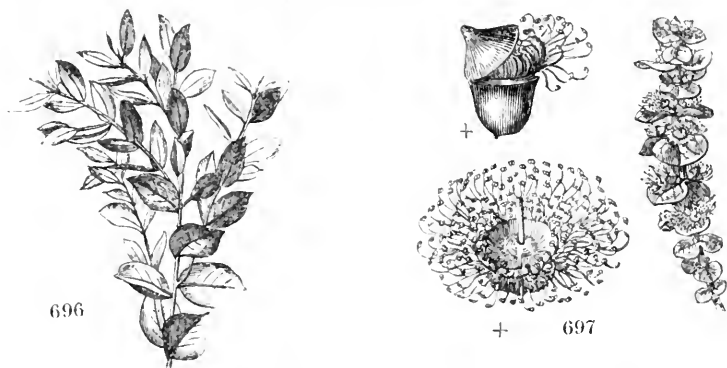

the leaves of which vary in their position from opposite to alternate. It was introduced in 1816; and in British green-houses, where it is not more than 4 ft. or 6 ft. high, when grown in pots, it flowers from May to August.

Callistemon salignus Dec., *Metrosideros salignus* Smith, is a native of New Holland, with lance-



olate leaves, and pale yellow flowers. In British green-houses, it grows to the height of 10 ft., and flowers from May to July. There are several other species in British gardens.

C. lanceolatus Dec.; *Metrosideros lanceolatus* Smith; *M. citrina* *Bot. Mag.*, t. 260.; and our fig. 700.; is a native of New Holland, with scarlet flowers, which are produced from June to November.

It was introduced in 1788; and in Buchanan's arboretum, at Camberwell, it has stood three years, without the slightest protection. The genus may be considered nearly as hardy as that of Eucalyptus.

Metrosideros corifolia Vent.; *Leptospermum ambiguum* Smith *Exot. Bot.*, t. 59; and our fig. 705; the *Coris-leaved Iron-wood*; is a native of New Holland; which, in British green-houses, forms a shrub from 4 ft. to 6 ft. high. There are many other species described, and two or three more introduced.

Leptospermum grandifolium Smith (*Bot. Mag.*, t. 1810.; *Bot. Cab.*, t. 701.; and our fig. 701.) is a New Holland shrub, with large white flowers, produced in June and July. It was introduced in 1803; and, in British gardens, grows to the height of 6 ft. or 7 ft.

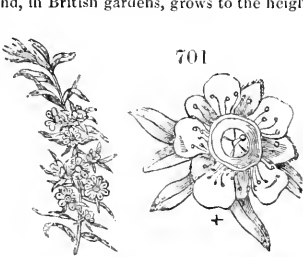

L. lanigerum Ait., *Bot. Cab.*, t. 1192.; *Philadelphus lanigerus* Ait.; is a Van Diemen's Land shrub, introduced in 1774; and so hardy, that it frequently stands the open air for two or three years together, in the open ground, in the London nurseries, without the slightest protection. There are numerous species described, and above a dozen of them introduced.

Billotia marginata R. Br.; *Leptospermum marginatum* Labill. *Nov. Holl.*, 2. p. 10. t. 148.; is a shrub with the habit of *Leptospermum*, introduced in 1820, and flowering in June and July. There are two other species of this genus, one of which, *B. flexuosa* D. Don, has been introduced.

Fabricia myrtifolia Gærtn. (*Bot. Mag.*, t. 1304.; and our fig. 703.) is a shrub from New South Wales, growing to the height of 10 ft., and producing its white flowers in May and June. It was introduced in 1788.

F. stricta Lodd. (*Bot. Cab.*, t. 1219.) was introduced in 1827, and flowers from April to July; but neither this nor the preceding species blossoms till it is 5 or 6 years old.



Bæchia virgata Andr. *Bot. Rep.*, t. 598., *Bot. Cab.*, t. 341., and our fig. 704.; *Leptospermum virgatum* Forsk.; *Melaleuca virgata* Lin. fil.; is a native of New Caledonia, where it grows to the height of 3 ft. or 4 ft., and produces its white flowers from August to October. There are 19 species described in Don's *Mitler*, ii. p. 827., about half a dozen of which have been introduced.

Sect. III. MYRTEÆ. Stamens free. Fruit fleshy.

Psidium Cattleyanum Sabine, *Bot. Reg.*, t. 622., and our fig. 706.; *P. coriaceum* Morsh. *Herb.*; *P. chinense* Lodd.; *Cattley's Guava*; is a native of China, where it grows to the height of 20 ft. It was introduced in 1818, and is generally kept in stoves along with the other species of *Psidium*; but, as it has been known to ripen its fruit in a green-house, we have introduced it here, as there can be no doubt that the plant might be preserved against a conservative wall.

Myrtus communis L., the common *Myrtle*, is a well-known evergreen shrub, a native of the south of Europe, which is found wild in France, about Marseilles, and from that city, along the coast, to Genoa (growing in thickets, even within reach of the spray of the sea), and throughout Italy. It was a great favourite among the ancients, by whom it was held sacred to Venus. The name is said to be taken from that of Myrsine, an Athenian maiden, a favourite

of Minerva, who, suffering love to overpower her wisdom, was changed into a myrtle by her offended mistress, and taken pity on by Venus. Others say that Venus, when she first sprang from the bosom of the sea, had a wreath of myrtle on her head. The temples of this goddess were always surrounded by groves of myrtle; and in Greece she was adored under the name of Myrtilla. Pliny says that the Romans and Sabines, when they were reconciled, laid down their arms under a myrtle tree, and purified themselves with its boughs. Wreaths of myrtle were the symbols of authority worn by the Athenian magistrates. The weapons of war were also formed of this tree; and sprigs of myrtle were entwined with the laurel wreaths worn by those conquerors, during their triumphs, who had gained a victory without bloodshed. The victors in the Olympic and other games were also adorned with myrtle. In Rome, two myrtles were placed before the temple of Romulus Quirinus, to represent the plebeian and patrician orders, which were predicted to be in the ascendancy according to the state of the trees. The Roman ladies put the leaves of the myrtle into their baths, persuaded that the plant of Venus must be favourable to beauty. The branches and berries were steeped in wine to give it a flavour; and the fruit was used in cookery, as the entire plant was in medicine. The ancient poets made it their favourite theme; and Virgil represents Æneas discovering it to be the metamorphosed Polydorus. (*Æneid*, book iii.) The myrtle has been known in England since 1597; and has been frequently noticed by British poets. Spencer says,—

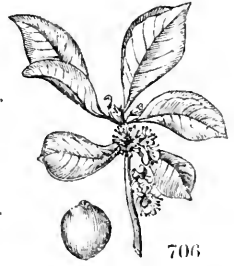

“ Right in the midst of that Paradise,
There stood a stately mount, on whose round top
A gloomy grove of myrtle trees did rise,
Whose shady boughs sharp steel did never lop,
Nor wicked beasts their tender boughs did crop;
But, like a girland compassed the height,
And from their fruitful sides fresh gum did drop,
That all the ground with precious dew bedight,
Threw forth most dainty odours, and most sweet delight.” *Færic Queen.*

Milton places the myrtle in the bower of Eve; and Thomson, in those beautiful lines, beginning, “The lovely young Lavinia once had friends,” compares Lavinia to a myrtle which

—“ Rises far from human eye,
And breathes its balmy fragancee o’er the wild.” *Seasons.* Autumn.

Though the myrtle is now common as underwood in Italy, Pliny tells us that it was not a native of that country; and that the first myrtle seen in Europe was planted near the tomb of one of the companions of Ulysses at Circeii; and he adds that it still retained its Greek name of murtos. It is remarkable, that this name is still preserved in all the European languages; the myrtle being called myrtus in Latin; myrto, in Italian and Spanish; murte, in German; myrter, in Danish; myrten, in Swedish; mirte, in French; and myrta, or murta, in Portuguese. Pliny mentions eleven sorts of myrtles, and says that the most odoriferous grew in Egypt. Cato only speaks of three kinds.

The first cultivation of the myrtle in England is assigned, in the *Hortus Kewensis*, to the year 1629; when Parkinson informs us that he had three sorts in his garden; viz. the broad-leaved, and two varieties of the box-leaved. Gerard, however, in 1597, says that “myrtles never bear any fruit in England;” which, surely, implies the cultivation of it in this country before that period. Bradley states that myrtles were introduced by Sir Francis Carew and Sir Walter Raleigh, in 1585. When they returned to England, after a residence in Spain, just before the invasion of the Spanish armada, one of these myrtles was planted by Sir F. Carew at Bedlington. Evelyn, in 1678, says, “I know of one (a myrtle) near 80 years old, which has been continually exposed, unless it be that, in some exceeding sharp seasons, a little dry straw has been thrown upon it;” and it is supposed that he alluded

to the tree at Beddington, which was of the Spanish broad-leaved, or orange-leaved, variety, and which Miller and Bradley report, in 1724, to have been above 18 ft. high, and to have spread about 45 ft. This tree, however, must have been of more than the age assigned to it by Evelyn; and is supposed to have been killed by the severe frost of 1739–40, when it was 160 years old. Johnson, in his edition of Gerard, states that the broad-leaved and narrow-leaved varieties were, in 1633, “nourished in the garden of Mistress Tuggie, in Westminster.” (*Mart. Mill.*)

Varieties. The following forms, or varieties, of myrtle, the first of which may be considered as the species, are given in Don's *Miller*, ii. p. 834. :—

§ i. *Melanocárpa* Dec., with black Fruit.

The varieties comprised in this group are all frequent in the south of Europe, where there are subvarieties belonging to this division with double flowers and variegated leaves.

■ *M. c. 1 romana* Dec. Prodr., 3. p. 239.; the common broad-leaved, or *Roman*, *Myrtle*, with ovate leaves, and long pedicels. This kind is sometimes called the flowering myrtle, because it flowers more freely in England than any other variety.

■ *M. c. 2 tarentina* Mill. Icon., t. 184. f. 1.; the *Tarentum*, or *Box-leaved Myrtle*.—Leaves small and ovate. Flowers small, and opening late in the autumn. Berries round.

■ *M. c. 3 itálica* Mill. Dict., the *Italian*, or upright, *Myrtle*, has the leaves ovate-lanceolate and the branches erect.

■ *M. c. 4 bætica* Mill. Dict., Blackw., t. 114.; the *Andalusian*, or *Orange-leaved Myrtle*, has the leaves lanceolate and acuminate.

■ *M. c. 5 lusitánica* Lin. Sp.; *M. acuta* Mill. Dict., *Clus. Hist.*, 1. p. 66. fig. 1.; the *Portugal Myrtle*. The *Nutmeg Myrtle* appears to be only a subvariety of this.

■ *M. c. 6 bégica* Mill. Dict., the broad-leaved *Dutch Myrtle*, has the leaves lanceolate, acuminate, crowded together, and of a dark green. The *double-flowered Myrtle* appears to be a subvariety.

■ *M. c. 7 mucronáta* L.; *M. mínima* Mill.; the *Rosemary*, or *Thyme-leaved Myrtle*; has the leaves linear-lanceolate, acuminate.

§ ii. *Leucocárpa* Dec. Fruit white.

■ *M. c. 8 leucocárpa* Dec., the *white-berried Myrtle*.—This variety is a native of Greece and the Balearic Islands. The fruit is rather large, and edible, with a grateful taste and smell.

§ iii. *Garden Varieties.*

The above varieties are constant; but there are many varieties in gardens which are more variable: the following are the names of most of these :—

1. Gold-striped broad-leaved Myrtle.
2. Broad-leaved Jews' Myrtle. This variety has its leaves frequently in threes, on which account it is said to be in esteem among the Jews in their religious ceremonies.
3. Gold-striped Orange-leaved Myrtle.
4. Silver-striped Italian Myrtle.
5. Striped-leaved Myrtle.
6. Silver-striped Rosemary-leaved Myrtle.
7. Silver-striped Nutmeg Myrtle.
8. Cock's-comb, or Bird's-nest Myrtle.
9. Spotted-leaved Myrtle.

Propagation, Culture, &c. All the varieties are readily propagated by cuttings; and those which ripen their fruit, such as the common broad-leaved myrtle, come up in abundance from seeds. Cuttings may either be made of the ripe wood, or of that which is in a growing state; the latter root soonest, but they require most care, and success will be most certain when they are planted in sand, and covered with a bell-glass. The finer varieties of myrtle might be grafted on the common and hardier sorts; and perhaps something might be gained in rendering the Australian *Myrtacææ* more hardy, by grafting them on the common myrtle. Perhaps, also, something might be done in the way of cross-fecundation between *Myrtus*, *Psidium*, *Melaleuca*, &c.

Statistics. In the environs of London, the broad and narrow-leaved myrtles stand out, in dry warm situations, as bushes; sometimes having the extremities of the shoots killed down by frost; but more frequently by the direct influence of the sun after a frosty night, accompanied with snow and sleet. After such nights, the plants should either be watered overhead with water, to thaw the frost; or covered with a mat, to prevent them from thawing suddenly by the sun's rays. The safest mode in such weather is, to cover the plant with mats at night; because, though frost will not kill it, yet it always injures the foliage. Both double and single varieties of the common myrtle cover large spaces of a wall in the Horticulturist Society's Garden; and there are many houses and gardens in the neighbourhood of London that can exhibit trained plants from 10 ft. to 20 ft. high, and nearly as wide. At Cobham Hall, in Kent, there are several trees against the house 50 ft. high. On the Sussex coast, about Worthing, there are some very fine plants against houses. In the Isle of Wight, and in Devonshire, the myrtle forms hedges to gardens, and, in shrubberies, grows as large as the arbutus does about London. At the Willows, near Swansea, in Glamorganshire, there were, in 1828, two myrtles 15 ft. high, as standards in the open ground, the branches of the largest of which covered a space 90 ft. in circumference. (*See Gard. Mag.*, xi. p. 360.) In Scotland, in East Lothian, more especially at Biel, the myrtle grows against a wall with very little protection. In Ireland, in the Trinity College Botanic Garden, Dublin, all the varieties, except the orange-leaved, stood out against a wall with a southern aspect; and at Youghall, near Cork, there is a plant in the open garden 20 ft. high, which has never had any protection. The myrtle will not stand out against a wall, in the neighbourhood of Paris, without a good deal more protection than it requires about London; but, about Toulon and Nice, it grows wild in abundance; and in gardens it not only forms hedges, but is sometimes trained as a tree with a clear stem. This, however, is no improvement to it; for, as the head is thickly crowded with small branches, which only bear leaves at their extremities, it presents, when the eye is beneath it, a miserable appearance, looking, as is observed in the *Nouveau Du Hamel*, more like a magpie's nest, or a dead bush placed on a pole, than a living tree.

M. tomentosa Ait., *M. canescens* Lour., (*Bot. Mag.*, t. 250.; and our fig. 707.) is a native of China, Cochin-China, and the Neelgherry Mountains, in the East Indies, with rose-coloured flowers, which appear in June and July. It was introduced in 1776, and grows to the height of 5 ft. or 6 ft. This very handsome plant is not unfrequent in collections, though it has been seldom tried against a wall, except in the south of England; where, in Pontey's Nursery at Plymouth, and in other places, it has been found quite hardy. In the neighbourhood of London, it might be grafted on the common myrtle; and surely some interesting hybrids might be originated between this and the common species. There is a variety of *M. tomentosa* in some nurseries, with leaves less downy than the species, which is known as *M. affinis*.

M. tenuifolia Smith in *Lin. Trans.*, ii. p. 380., Don's *Miller*, ii. p. 836., is a native of New Holland, with leaves an inch long and one line broad; and with white flowers one half smaller than those of *M. communitis*. It was introduced in 1824; but, as its fruit and seeds have not been examined by botanists, it may probably belong to some other genus. Some other greenhouse species of *Myrtus* are described in Don's *Miller*, and particularly *M. nummularia*, a creeping species from the Straits of Magellan, and *M. myrsinoides* from the colder parts of Peru; but both of which will probably prove half-hardy, and neither of which have yet been introduced.



Sect. IV. CHAMELAIUCIÆ. *Stamens free, or somewhat polyadelphous. Fruit dry, with 1 cell. Ovules erect.*

Chamelaiucium ciliatum Desf. *Mém. Mus.*, v. p. 40. t. 3. f. B., is a native of New Holland, at King George's Sound, a very singular shrub, with opposite, crowded, linear, triquetrous leaves, and axillary white flowers on short pedicels. The flower is girdled by two concave bractes before evolution, each terminating in a dorsal mucro, which afterwards separates transversely. This very singular shrub is not yet introduced.

Cilythria glabra R. Br. (*Bot. Cab.*, t. 587.; and our fig. 708.) is a shrub, a native of New Holland, with small cylindrical leaves, and pale-reddish flowers, which are produced from April to June. It was introduced in 1818, and grows to the height of 3 ft. or 4 ft.

C. ericoides Cunningham, Don's *Mill.*, ii. p. 812., is a handsome heath-like shrub, a native of New Holland, in pine ridges at Bathurst, where it grows to the height of from 4 ft. to 6 ft. It was introduced in 1824, and there are plants of it in the Kew Garden.

Darwinia fascicularis Rudge in *Lin. Trans.*, xi. p. 299. t. 22., is a decumbent shrub, a native of New Holland, with red flowers. Introduced in 1820, but not very common in collections.



CHAP. L.

OF THE HALF-HARDY LIGNEOUS PLANTS OF THE ORDER PASSIFLORACEÆ.

THE common passion flower (*Passiflora cærulea*) is so hardy in the neighbourhood of London, as to flower freely against a wall, in most years, without any protection whatever during winter. In very dry sheltered situations, it will even endure the open air as a trailing bush; but as, in this state, it is liable to be killed by winters of unusual severity, unless protected, we have decided on treating the genus as only half-hardy. It is propagated by cuttings or layers, and grows freely in common garden soil.

Passiflora cærulea L. (*Bot. Mag.*, t. 28.; and our fig. 709.) is a well-known climbing greenhouse plant, which will also grow and flower freely on garden walls, and on the sides of houses with a southern exposure. It is a native of Brazil and Peru, and has been in cultivation since 1699. The prevailing colour of the flower is blue; and that of the fruit, which is egg-shaped, and about the size of a Mogul plum, is yellow. In fine summers, the fruit ripens in the open air, in the neighbourhood of London, both against a wall, and when the plant is treated as a bush, and allowed to trail along the surface of the ground. It ripened fruit in the last state, in the Goldworth Nursery, in 1835.



P. c. 2 angustifolia Hort. has the lobes of the leaves narrow, and flowers rather later than the species.

P. c. 3 glaucophylla Hort. has the leaves glaucous beneath.

P. c. 4 Colvillii Swt. *Fl.-Gard.*, t. 126., has the lobes of the leaves oblong-lanceolate, and the flowers whitish, tinged with blue and purple. It is a hybrid, which was raised in Colvill's Nursery; and it is considered as hardy as the species.

P. c. 5 racemosa Hort. *Trans.*, 4. t. 9., is a hybrid between *P. cærùlea* and the stove species, *P. racemosa*, originated in 1820. It has purplish flowers; and is not so hardy as *P. cærùlea*.

P. incarnata L. (*Bot. Reg.*, t. 332.; and our *fig.* 710.), the *flesh-coloured Granadilla*, or *May Apple*, is a native of South America and Virginia, with flesh-coloured flowers, and fruit about the size of a small apple, orange-coloured, with a sweetish yellow pulp. It may almost be considered as herbaceous, as the shoots die down nearly to the ground every year; on which account the roots, or stool, may, with the greater ease, be preserved against a conservative wall.

P. tiliaefolia L., the *Lime-tree-leaved Passion Flower*, is a native of Peru, with cordate entire leaves, red flowers, and fruit globose and variegated with red and yellow. It was introduced in 1823, and is considered nearly as hardy as *P. cærùlea*.

Other species or varieties, to be found in British catalogues and gardens, may, perhaps, be as hardy as some of those above mentioned; and, as they are all eminently beautiful, we recommend them to be tried against a conservative wall as extensively as possible.

Disëmma adiantifolia Dec.; *Passiflora adiantifolia* *Bot. Reg.*, t. 233.; and our *fig.* 711.; is a splendid climber, a native of Norfolk Island, introduced in 1792; and, though not very common, it is highly probable that it would thrive against a conservative wall. The leaves are lobed, and the flowers yellow at first, becoming at length of an orange colour, with the inner crown green, and longer than the purple rays that surround it. (*Don's Mill.*, 3. p. 56.)

Tacsônia pinnatistipula Juss., Swt. *Fl.-Gard.*, new series, 2. t. 156.; *Passiflora pinnatistipula* Cav.; is a climbing shrub, a native of Chili, introduced in 1828.

The leaves are white from velvety down on their under surface; the stipules are pinnate; and the flowers rose-coloured, or purplish, with the crown a deep blue. The plant, which is exceedingly beautiful, has flowered magnificently, and ripened its round yellow fruit, in the conservatory of Mrs. Marryat, at Wimbledon; and it has flowered on the open wall of the garden of Englefield House, near Reading. There are several other species of this genus, but they have not yet been introduced. Hybrids will, no doubt, be raised between this genus and *Passiflora*; and perhaps something might be gained in hardiness by grafting *T. pinnatistipula* on *Passiflora cærùlea*. The flexible shoots of all the plants noticed in this chapter admit so readily of protection, by tying them in bundles, and enveloping them in straw and matting, that no conservative wall ought to be without them.



710



711

CHAP. LI.

OF THE HARDY AND HALF-HARDY SPECIES OF THE ORDER CRASSULA'CEÆ.

SE'DUM populifolium L. (*Willd. Sp. Pl.*, ii. p. 762., *Bot. Mag.*, t. 211.); the *Poplar-leaved Sedum*, or *Stonecrop*; *Anacampseros populifolia* *Haworth Syn. Plant. Suc.*, p. 113.; is a hardy miniature shrub, a native of Siberia, which was introduced in 1780, and flowers in July and August. It is remarkable as being truly ligneous in a genus the other species of which are nearly all herbaceous. The flowers are white, and are particularly grateful to bees, whence this shrub is well adapted for planting near an apiary.

Sempervívum arboreum L., the *Tree Houseleek*, (*Bot. Reg.*, t. 29.; and our *fig.* 712.) is a native of Portugal, Barbary, and Candia, where it grows to the height of 5 ft. or 6 ft.; producing its yellow flowers from March to December. It is an old inhabitant of our green-houses, and, with the proper protection, would stand against a conservative wall. There are two varieties: one with variegated leaves, and one with leaves which take a rich brown in summer or autumn.



712

CHAP. LII.

OF THE HALF-HARDY LIGNEOUS PLANTS OF THE ORDER FICOIDA'CEÆ,
OR MESEMBRYA'CEÆ.

Meembryanthemum L. There are a great many species and varieties of this genus described by botanists, no fewer than 339 being enumerated in Don's *Miller*. Most of them are natives of dry sandy soils at the Cape of Good Hope, and in other parts of Africa; and many sorts will live through the winter on rockwork, in the neighbourhood of London, if protected with dry litter. When they can be preserved through the winter, they make a splendid appearance in the summer, with their brilliant flowers of scarlet, yellow, purple, or white. Several species have stood through the winter, without any protection, on the rockwork in the Chelsea Botanic Garden; and a number of sorts were, till lately, preserved in a cold-pit in the garden of the London Horticultural Society.

CHAP. LIII.

OF THE HARDY LIGNEOUS PLANTS OF THE ORDER NITRARIA'CEÆ.

THIS order includes only one genus, so that the following generic characters will portray the chief of the characteristics of the order:—

NITRARIA L. Calyx inferior, in 5 deep divisions. Petals 5, arising from the calyx, their æstivation inflexed and valvular. Stamens 15, perigynous. Ovary with 3 or more cells, with a continuous fleshy style, at whose tip are as many stigmatic lines as there are cells. Fruit drupaceous, opening by 3 or 6 valves. Seeds solitary, pendulous by a long funiculus. Embryo straight, dicotyledonous. — Shrubs, with deciduous, succulent, alternate leaves, which, in some instances, are in fascicles; and with flowers in cymes, or solitary. Properties, slightly saline. (*Lindl. Introd. to N. S.*)

GENUS I.

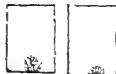

NITRARIA L. THE NITRARIA. *Lin. Syst.* Dodecándria Monogýnia.

Identification. *Lin. Gen.*, No. 692.; *Lam. Ill.*, t. 403.; *Gartn. Fruct.*, 1. t. 58.; *Dec. Prod.*, 3. p. 456.; *Don's Mill.*, 3. p. 155.

Derivation. So named by Schober, from one of the species being discovered in certain nitre-works in Siberia, along with other saline plants.

Description, &c. Shrubs, seldom rising more than 4 ft. in height; and, in British gardens, thriving best in a dry soil, composed partly of lime rubbish, which should be, about once a year, strewed with a thin coat of salt. Propagated by cuttings.

1. **N. SCHOBERI** L. Schober's Nitraria.

Identification. *Lin. Sp.*, 638.; *Dec. Prod.*, 3. p. 456.; *Don's Mill.*, 3. p. 155.

Spec. Char., &c. Leaves oblong, perfectly entire. Drupes ovate. It varies, with branches spiny, and not so. A native of the neighbourhood of salt lakes in Russia. (*Dec. Prod.*, iii. p. 456.) Introduced in 1788.

Varieties.

✻ *N. S.* 1 *sibirica*; N.

sibirica *Pall. Fl. Ross.*, t. 50. f. A., *Gmel. Sib.*, 2. t. 98., *Lam. Ill.*, t. 403. f. 1.; and our *fig.*

713. — Fruit of a blackish blue colour. A native of Siberia.



- ✱ *N. S. 2 cáspica*; *N. cáspica* *Pall. Fl. Ross.*, t. 50. f. B.; and our fig. 714. — Fruit red. Leaves longer. Native by the Caspian Sea. By Steven's written observations in Willdenow's *Herbarium*, it differs from *N. S. 1 sibirica* in its young branches being pubescent, and in its fruit being larger, and much more acute. The flowers of this variety, and also those of the species, are white, and produced freely. The berries black, rather larger than peas, and they render the bush very ornamental.

✱ 2. *N. TRIDENTA`TA* *Desf.* The 3-toothed-leaved *Nitraria*.

Identification. *Desf. Fl. Atl.*, 1. p. 372.; *Dec. Prod.*, 3. p. 456.; *Don's Mill.*, 3. p. 155.

Synonymic. *Péganum retusum Forsk.*, according to *Défil.* in his *Ill. Fl. Égypt.*

Spec. Char., &c. Branches spiny. Leaves wedge-shaped, retuse, toothed with about 3 teeth. Fruit ovate. (*Dec. Prod.*, iii. p. 456.) A native of sandy fields of Barbary and Egypt; growing to the height of from 1 ft. to 2 ft. Introduced in 1820; but not frequent in collections.

CHAP. LIV.

OF THE HALF-HARDY LIGNEOUS PLANTS OF THE ORDER CACTA`CEÆ.

Opúntia vulgáris *Mill.*; *Cactus Opúntia L., Mill. Icon.*, t. 191.; the common *Indian Fig*, or *Prickly Pear*; is a native of North America, in the southern states, and is found abundantly in gardens in the neighbourhood of New York. It is also very common in Italy, and various parts of the south of Europe. In Virginia, it is valued for its refreshing fruit; and it has been cultivated for the same purpose on dry rockwork, in the neighbourhood of London. (See *Encyc. of Gard.*, edit. 1835, p. 979.) It will live many years, with little or no protection, at the bottom of a dry warm wall; and, though usually prostrate, yet, if the shoots are nailed to the wall, it will grow to the height of several feet. It deserves a place in a collection of half-hardy ligneous succulent plants, for the sake of its singular appearance; and various other genera and species belonging to the same order are, probably, nearly as hardy.

CHAP. LV.

OF THE HARDY LIGNEOUS PLANTS OF THE ORDER GROSSULA`CEÆ.

This order consists of the genus *Ribes* only; and the following characteristics of that genus are the chief of those of the order:—

RIBES *L.* Calyx superior, having 4—5 coloured lobes; and bearing from its throat 5, 4, or ? 0, small petals; and 5, very rarely 6, stamens. The lobes of the calyx, the petals, and the stamens, are, in most instances, 5 each; and, in such, are alternate with one another. The two sexes are present, in most kinds, in the same flower; in a few dioecious, at least in result. Ovary with 1 cell, and 2 parietal placentas. The ovules numerous. Style 1. Fruit a subglobose berry, tipped with the remains of the part of the flower that is distinct from the ovary. The seeds many, oblong, subcompressed; each suspended in the pulp by a long, slender, funiculus; and having an aril, horny albumen, and an embryo that is minute, dicotyledonous, and situate at the smaller end of the seed, contiguous to the hilum, but with the radicle pointing to one side. — Shrubs, unarmed or prickly. Leaves alternate, lobed or cut, plaited when folded in the bud, deciduous. A bractea is at the base of every pedicel, and two smaller are upon it below the ovary. Flowers greenish, whitish, yellow, or red. (*Dec. Prod.*, iii. p. 477., and *Lindl. Introd. to N. S.*) *M. Spach*, in the *Annales des Sciences Naturelles* for 1835, has subdivided the genus *Ribes* into the genera authenticated as his among our synonymes.

GENUS I.

*RIBES* L. THE RIBES. *Lin. Syst.* Pentándria Monogýnia.

Identification. *Lin. Gen.*, 281.; *Dec. Prod.*, 3. p. 477.; *Don's Mill.*, 3. p. 177.

Synonymes. *Grossularia Tourn.*, *Gærtn.*; *Chrysobótريا*, *Calobótريا*, *Coreósma*, and *Rèbes* Spach; *Groseiller*, *Fr.*; *Johannisbeere*, *Ger.*; *Kruisbes*, *Dutch*; *Uva Spina*, *Ital.*; *Grossella*, *Span.*

Derivation. The word is from the name of an acid plant mentioned by the Arabian physicians, which has been discovered to be the *Rhèum Ribes*; *Grossularia* is from the Latin *grossulus*, a little unripe fig.

Description, &c. This genus consists of low deciduous shrubs, two of which (the common currant and gooseberry) are well known in British gardens, for their valuable fruits. We shall here consider all the species of the genus entirely in the light of ornamental shrubs, taking little notice of the varieties cultivated in gardens for their fruit. Many of the sorts here set down as species are, we have no doubt, only varieties; but, as we are not able to refer these to their aboriginal forms, we have followed the usual authorities, and more especially the nomenclature adopted in the Horticultural Society's Garden; a synopsis of the sorts in which, by Mr. Gordon, will be found at the end of this article. All the species of *Ribes* strike root readily from cuttings; and grow freely in any soil that is tolerably dry; but, as they are only ligneous in a subordinate degree, and are but of a temporary duration under any circumstances, they require to be grown in dry beds or borders, and are, therefore, more fitted for scientific collections or flower-borders, than for general shrubberies, undug arboretums, or lawns. The most showy species are *Ribes sanguineum* and *aureum*, and their varieties. *R. speciosum*, has a singular fuchsia-like appearance when in blossom; and *R. multiflorum*, though the flowers are greenish, is remarkably elegant, on account of the long many-flowered racemes in which they are disposed. The price, in the London nurseries, varies from 1s. to 2s. each; at Bollwyller, from 50 cents to 1 franc; and at New York, from 25 cents to half a dollar. The varieties cultivated as fruit trees are much cheaper; and *R. speciosum*, which is rather difficult to propagate, and some of the other species, which are new, and as yet rare, are dearer.

§ i. *Grossularia* Ach. Rich. Gooseberries.

Synonymes. *Groseiller à Maquereau*, *Fr.*; *Stachelbeere* Strauch, *Ger.*; *Kruisbes*, *Dutch*; *Uva Spina*, *Ital.*; and *Grosella*, *Span.*

Sect. Char., &c. Stems, in most instances, prickly. Leaves plaited. Flowers in racemes, 1, 2, or 3, in a raceme. Calyx more or less bell-shaped. (*Dec. Prod.*, iii. p. 478.) Shrubs with prickles; and with the leaves and fruit more or less resembling those of the common gooseberry.

A. Flowers greenish white.

❖ 1. *R. OXYACANTHODES* L. The Hawthorn-leaved Gooseberry.

Identification. Pursh *Fl. Amer. Sept.*, 2. p. 165.; *Berlandier* in *Mém. Soc. Phys. Gen.*, 3. pars 2. p. 43. t. 1. f. 1., not of Michaux.

Engravings. *Mém. Soc. Phys. Gen.*, 3. pars 2. t. 1. f. 1.; *Dill. Elth.*, t. 139. p. 166.; and our *fig.* 715.

Spec. Char., &c. Infra-axillary prickles larger, and mostly solitary; smaller prickles scattered here and there. Leaves glabrous, their lobes dentate, their petioles villous, and a little hispid. Peduncles short, bearing 1—2 flowers. Berry globose, glabrous, purplish blue. A native of rocks of Canada. (*Dec. Prod.*, iii. p. 478.) This shrub varies much in the number and colour of its prickles, and its more or less dense ramification and pubescence. The fruit resembles that of the common gooseberry, and is sometimes red, and

at other times green, or purplish blue; and, when ripe, it is agreeable to the taste. This species was introduced in 1705; but it is not common in British gardens, the *R. oxyacanthoides* of Michaux (*R. lacustris* Poir.) being different from it. Perhaps it is only one of the wild states of the common gooseberry; indeed it would not surprise us, if future experiments should prove that most of the sorts described in this section were neither more nor less than different states of this valuable fruit shrub. As it varies so very much when in a state of culture, it is reasonable to suppose that it will vary much also in a wild state, in different soils, situations, and climates.

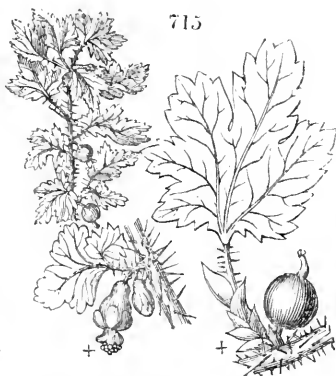

2. *R. SETOSUM* Lindl. The bristly Gooseberry.

Identification. Lindl. Bot. Reg.; Hook. Fl. Amer., 1. p. 230.

Don's Mill., 3. p. 177.; Lodd. Cat., ed. 1836.

Engravings. Lindl. Bot. Reg., t. 1237.; and our fig. 716.

Spec. Char., &c. Branches beset with dense bristles.

Prickles unequal, subulate. Leaves roundish, cordate at the base, pubescent, 3—5-lobed, deeply crenated. Peduncles 2-flowered, sometimes bracteate. Calyx tubularly campanulate, with the segments linear, obtuse, and spreading, twice the length of the petals, which are entire. Berries hispid. (*Don's Mill.*, iii. p. 177.) Native of North America, on the banks of the Saskatchewan. A shrub, growing 4 ft. or 5 ft. high; flowering in April and May. Introduced in 1810.



3. *R. TRIFLORUM* W. The 3-flowered Gooseberry.

Identification. Willd. Enum., 1. p. 51.; Berlandier in Mém.

Soc. Phys. Gen., 3. pars 2.; Dec. Prod., 3. p. 479.; Don's

Mill., 3. p. 177.; Lodd. Cat., ed. 1836.

Synonymy. *R. stamineum* Horn. Enum. Hort. Hafn.,

p. 257.

Engravings. Mém. Soc. Phys. Gen., 3. pars 2. t. 1. f. 4.; and

our fig. 717.

Spec. Char., &c. Infra-axillary prickles solitary.

Leaves glabrous, 3—5-lobed, incisely dentate. Peduncles bearing 1—3 flowers. Pedicels long. Bracteas membranaceous, sheathing. Calyxes tubularly bell-shaped. Petals spatulately obovate. Berries reddish, glabrous. (*Dec. Prod.*, iii. p. 479.) A native of North America. Introduced in 1812; and easily distinguished from *R. Cynosbati* by its smooth fruit, narrow flowers, and exserted stamens. In British gardens, it grows to the height of 3 ft. or 4 ft., and produces its whitish flowers in April and May.

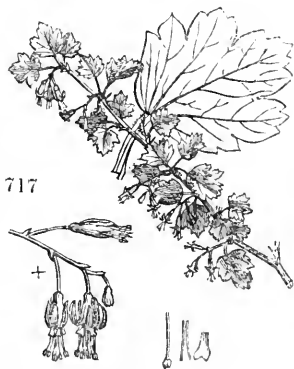

4. *R. (T.) NIVEUM* Lindl. The snowy-flowered Currant-like Gooseberry.

Identification. Lindl. in Bot. Reg., t. 1692.

Engravings. Bot. Reg. t. 1692.; and our fig. 718.

Spec. Char., &c. Branches prickly, the prickles solitary, or in pairs, or in threes. Leaves glabrous, roundish, entire at the base, having in the outward part 3 blunt lobes that are crenately cut. Flowers about 2

together, on peduncles. Sepals reflexed. Stamens very prominent, conniving, hairy, longer than the style. (Lindley in *Bot. Reg.*, t. 1692.) A shrub, growing to the height of 4 ft. or 5 ft.; a native of the north-west coast of North America; whence seeds were sent to the London Horticultural Society, by Mr. Douglas, in 1826. The bush bears some similarity to *R. triflorum*; but the berry of *R. niveum* is about the size of that of the black currant, and of the same

deep rich purple. It resembles a small smooth gooseberry; "but its flavour is very different: it is entirely destitute of the flatness which is more or less perceptible in even the best gooseberries; in lieu of which it has a rich sub-acid, vinous, rather perfumed, flavour, which is extremely agreeable. The fruit is rather too acid to be eaten raw; but, when ripe, it makes delicious tarts, and would, probably, afford an excellent means of improving the common gooseberry by hybridising." (Lindl. in *Bot. Reg.*, Aug. 1834.) *R. niveum*, apart from these considerations (which, however, will probably lead to its culture in the kitchen-garden), is, from its white pendulous flowers, a valuable addition to our ornamental hardy shrubs.

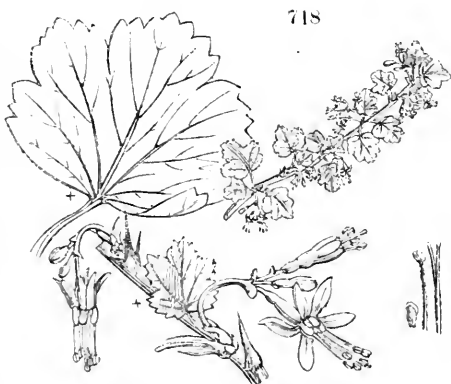

§ 5. *R. (T.) CYNOSBATI* L. The Dog-Bramble Gooseberry.

Identification. Lin. Sp., 292; Mill. Dict., No. 5; Berlandier in *Mém. Soc. Phys. Gen.*, 3. pars 2. t. 1. f. 3.; Dec. Prod., 3. p. 479; Don's Mill., 3. p. 178.

Synonymy. *R. ? triflorum* var.

Engravings. *Mém. Soc. Phys. Gen.*, 3. pars 2. t. 1. f. 3.; and our fig. 719.

Spec. Char., &c. Infra-axillary prickles

1—2. Leaves 3—4-lobed, softly pubescent. Peduncles bearing 2—3 flowers. Calyxes campanulately cylindrical. Petals small, much shorter than the stigmas and stamens. Style simple, toward the middle hairy, rarely glabrous. Berry prickly. A native of mountains in Canada, on the authority of Pursh; and of Japan, on the authority of Thunberg. (*Dec. Prod.*, iii. p. 479.) It hardly differs from *R. divaricatum*, except in the broader tube of the corolla, and the shorter stamens. (*Don's Mill.*, iii. p. 178.) It was introduced in 1759. Grows to the height of 3 ft. or 4 ft., and produces its flowers in April. There are two varieties: one with whitish flowers, and smooth fruit; and the other with prickly branches and fruit, and flowers pubescent and purplish. The former is a native of Hudson's Bay; and the latter, about Lake Huron.

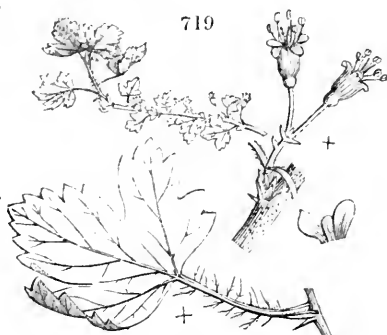

1—2. Leaves 3—4-lobed, softly pubescent. Peduncles bearing 2—3 flowers. Calyxes campanulately cylindrical. Petals small, much shorter than the stigmas and stamens. Style simple, toward the middle hairy, rarely glabrous. Berry prickly. A native of mountains in Canada, on the authority of Pursh; and of Japan, on the authority of Thunberg. (*Dec. Prod.*, iii. p. 479.) It hardly differs from *R. divaricatum*, except in the broader tube of the corolla, and the shorter stamens. (*Don's Mill.*, iii. p. 178.) It was introduced in 1759. Grows to the height of 3 ft. or 4 ft., and produces its flowers in April. There are two varieties: one with whitish flowers, and smooth fruit; and the other with prickly branches and fruit, and flowers pubescent and purplish. The former is a native of Hudson's Bay; and the latter, about Lake Huron.

§ 6. *R. (T.) DIVARICATUM* Dougl. The spreading-branched Gooseberry.

Identification. Dougl. in *Bot. Reg.*, t. 1359; Don's Mill., 3. p. 178.; Lodd. Cat., ed. 1836.

Synonymy. *R. ? triflorum* var.; *R. ? Grossularia* var. *Triflora* subvar.

Engravings. *Bot. Reg.* t. 1359.; and our fig. 720.

Spec. Char., &c. Branches divaricate, bristly, at length naked. Spines 1—3 together, axillary, deflexed, large. Leaves roundish, 3-lobed, deeply toothed, nerved, glabrous. Peduncles 3-flowered, drooping. Calyx funnel-shaped; with the segments at length spreading, and twice the length of the tube. Style and stamens exserted. Berries glabrous, black, smooth, and spherical; pleasant to the taste. Petals white. (*Don's Mill.*, iii. p. 178.) A common bush, on the banks of streams, near Indian villages, on the north-east coast of North America; where it forms a shrub, growing from 5 ft. to 7 ft. high; flowering in April. Introduced in 1826. It is nearly allied to *R. triflorum*, of which, like *R. Cynósbati* and some of the following sorts, it is, probably, only a variety.



720

♣ 7. *R. (T.) IRRIGUUM* Dougl. The well-watered Goosecherry.

Identification. Dougl. in Hort. Trans., 7. p. 516.; Hook. Fl. Bor. Amer., 1. p. 231.; *Don's Mill.*, 3. p. 178.; *Lodd. Cat.*, ed. 1836.

Synonymy. *R. ? triflorum* var.

Engraving. Our fig. 721.

Spec. Char., &c. Prickles axillary, ternary. Leaves cordate, somewhat 5-lobed, toothed, ciliated, pilose on both surfaces, nerved. Peduncles 3-flowered, beset with glandular hairs. Calyx campanulate. Segments linear, about equal in length to the tube. Berries glabrous, spherical, half an inch in diameter, smooth, juicy, and well-flavoured. Apparently closely allied to *R. triflorum*. (*Don's Mill.*, iii. p. 178.)

Found on the north-west coast of America, on moist mountain rocks, near springs and streams; on the Blue Mountains; and on the banks of the Spokane river. A shrub, growing to the height of 3 ft. or 4 ft. Introduced in 1820.



721

♣ 8. *R. HIRTELLUM* Michx. The slightly hairy-branched Gooseberry.

Identification. Michx. Fl. Bor. Amer., 1. p. 111.; *Dec. Prod.*, 3. p. 479.; *Don's Mill.*, 3. p. 178.

Spec. Char., &c. Spines infra-axillary. Branches sparingly hispid, with short hairs. Leaves small, cleft half-way down into 3 dentate lobes. Peduncles 1-flowered. Berries glabrous, red. (*Dec. Prod.*, iii. p. 479.) A native of rocky mountains in Canada and Virginia. It was introduced in 1812. Grows to the height of 3 ft. or 4 ft.; produces its greenish white flowers in April and May; and ripens its red fruit in August.

♣ 9. *R. GRACILE* Michx. The slender-branched Gooseberry.

Identification. Michx. Fl. Bor. Amer., 1. p. 111.; *Pursh Fl. Amer. Sept.*; *Dec. Prod.*, 3. p. 479.

Spec. Char., &c. Infra-axillary spine very short. Petioles of leaves slender. Disks cut into acute lobes. Peduncles slender, upright, bearing about 2 flowers. Calyx glabrous, tubularly bell-shaped. Berries glabrous, purple, or blue; of exquisite flavour. (*Dec. Prod.*, iii. p. 479.) Wild in the mountains of Tennessee, and in mountainous meadows from New York to Virginia. Introduced in 1812. Growing to the height of 3 ft. or 4 ft.; and flowering in April and May.

♣ 10. *R. ACICULARRE* Smith. The acicular-spined Gooseberry.

Identification. Smith in Rees's Cycl.; *Don's Mill.*, 3. p. 178.

Synonymy. *R. Uva-crispa Sievers* in *Pall. Nord. Beytr.*, 7. p. 274., ? *Pall. Fl. Ross.*, 2. p. 57.

Engraving. Led. Fl. Ross. Alt. III., t. 230.

Spec. Char., &c. Very prickly. Prickles stipular, 3—5-parted. Leaves rather pubescent, nearly orbicular, 3—5-lobed. Lobes bluntish, deeply serrated. Peduncles usually 1-flowered, bracteolate in the middle. Calyx campanulate, smoothish. Berries bractless, and, as well as the styles, quite glabrous. Stem erect, or procumbent. Petals white. Berries glabrous, yellowish, or purplish; sweet, with a grateful taste. (*Don's Mill.*, iii. p. 178.) A native of Siberia, on stony, rocky, mountainous places. Plants bearing this name are in the Horticultural Society's Garden.

❖ 11. *R. GROSSULARIA L.* The common Gooseberry.

Identification. *Lin. Sp.*, p. 291.; *Smith's Engl. Bot.*, t. 1292.; *Don's Mill.*, 3. p. 179.; *Lodd. Cat.*, ed. 1836. *Synonymes.* *R. Uva-crispa* (*Ed. Fl. Dan.*, 546.; *Grossularia hirsuta Mill. Dict.*, No. 2.; *R. Uva-crispa* var. 5 sativa *Dec. Fl. Fr.*, 4. p. 408., *Plenck Icon.*, 148.; *Feaberry, Cheshire and the north of England*; *Feabes, Norfolk*; *Grozet in Scotland*; *Groseiller à Maquereau, Fr.*; *Griselle in Piedmont*; *gemeine Stachelbeere, Ger.*; *Uva Spina, Ital.*

Derivation. *Uva-crispa* signifies the rough grape. *Feaberry* is a corruption of fever-berry, from the fruit being formerly, according to Gerard, considered a specific against fevers; *feabes*, or *feapes*, is an abbreviation of feaberry. *Grozet* is evidently taken from the French name. *Groseiller à Maquereau* is from the Latin name *Grossularia*, and the use made of the fruit as a sauce for mackerel. *Stachelbeere* signifies prickly berry; and *Uva Spina*, the prickly grape. *Gooseberry* is from gorse berry, from the prickliness of the bush resembling that of the gorse, or furze; or, more probably, from the use made of the fruit as a sauce to young, or green, geese.

Engraving. *Engl. Bot.*, t. 1292.

Spec. Char., &c. Prickles 2 or 3 under each bud. Branches otherwise smooth, and spreading or erect. Pedicels 1—2-flowered. Leaves 3—5-lobed, rather villous. Bracteas close together. Calyx campanulate, with reflexed segments, which are shorter than the tube. Petals rounded at the apex, glabrous, but bearded in the throat. Style always beset with long down. (*Don's Mill.*, iii. p. 179.) A native of Europe and Nepal, in woods and hedges.

Varieties.

❖ *R. G. 2 Uva-crispa* *Smith Engl. Fl.*, ii. p. 333.; *R. Uva-crispa Lin. Sp.*, 292., *Smith Engl. Bot.*, t. 2057.; *Uva crispa Fuch. Hist.*, t. 187.; *Uva spina Math. Valgr.*, l. t. 151. f. 1., *Blackw. Herb.*, 277.; *R. Uva-crispa* var. 1 sylvêstris *Berlandier*; has the berries smooth.

❖ *R. G. 3 spinosissima* *Berl. MSS.* has the branches thickly beset with spines.

❖ *R. G. 4 reclinata* *Berl. MSS.*; *R. reclinatum Lin. Sp.*, 291.; *Grossularia reclinata Mill. Dict.*, No. 1.; has the branches rather prickly, and reclinate.

❖ *R. G. 5 Besseriâna Berl. MSS.*; *R. hybridum Besser Prim. Fl. Gall. Austr.*, p. 186.; has the branches prickly, and the fruit pubescent, intermixed with glandular bristles. Native of Cracow, in hedges.

❖ *R. G. 6 subinermis* *Berl. MSS.* — Plant nearly glabrous. Bark smooth, brown. Prickles axillary. Flowers and leaves small. Native about Geneva. Perhaps a subvariety of *R. G. reclinata*.

❖ *R. G. 7 macrocarpa* *Dec. Prod.*, iii. p. 478. — Stigmas often longer than the petals. Flowers and berries large.

❖ *R. G. 8 bracteata* *Berl. MSS.* — Berries clothed with 2—4—5 straight, coloured, nearly opposite, bracteas and bristles, resembling sepals, which fall off before the berry arrives at maturity. (*Don's Mill.*, iii. p. 179.)

Other Varieties. We have little doubt that the greater number of the sorts described in this division of the section *Grossulariæ* are only wild varieties of the common gooseberry. Till lately, botanists made even the rough and the smooth-fruited kinds of the cultivated gooseberry two distinct species, as may be seen by the synonymes to *R. Uva-crispa* above; though it was recorded by Withering, that seeds from the same fruit would produce both rough and smooth-fruited plants. If varieties were to be sought for among the sorts in cultivation, they would be found almost without number. The following selection of garden varieties has been made solely with reference to the habit of growth of the plants: —

The *Red Champagne*, or Ironmonger, has the branches erect and fastigiate, and will form a handsome bush, 6 ft. or 7 ft. high.

Horseman's Green Gage is a most vigorous-growing plant, with a spreading head, and will form a bush 10 ft. high.

The *Red Rose* is a vigorous-growing bush, with a pendulous head, but seldom rising higher than 3 ft., unless trained to a stake to some height before it is allowed to branch out.

Description, Geography, &c. The gooseberry, in a wild state, is a low shrub, varying much in habit and magnitude, according to the soil and situation in which it is found. Villars, in his *Histoire des Plantes du Dauphiné*, mentions that the gooseberry is common every where in that country; that in hedges it grows to the height of 5 ft. or 6 ft., with large villous leaves; but that on mountains it is seldom found so high as 2 ft., and with very rough branches, wholly covered with yellowish stiff prickles. In England, the gooseberry is found on old walls, in woods, and in hedges; and, in Scotland, occasionally in the neighbourhood of villages; and, though undoubtedly naturalised in both countries, it appears to us very doubtful whether it is aboriginal in either. It is, however, truly wild in France, Germany, and Switzerland, more particularly in the Valais and in Piedmont, where it is called *griselle*, and where it is found in copse-woods, producing a small, green, hairy fruit. The common gooseberry, or a species nearly allied to it, Royle observes, is found in the Himalayas, on mountains near the almost inaccessible sources of the Ganges. There can be little doubt of its being indigenous in North America, where it is known by botanists under various names. Among other localities, we may cite as one the rocks about the Falls of Niagara, whence branches and ripe fruit have been sent to us. When the bush is of any considerable size, it is always found in a tolerably dry and loose free soil, and in a situation rather shady than otherwise; unless we except the instances in which the seeds have been carried by birds to the tops of walls, the summits of ruins, and the hollow trunks and partially decayed branches of old trees. In the famous lime tree at Neustadt, in Wurtemberg, gooseberries are grown in the hollow branches, and the fruit sold to strangers, as mentioned in detail in p. 372.

History. The gooseberry does not appear to have been known to the ancients; and it is uncertain at what period in modern times it began to be cultivated in gardens. The earliest notice of it appears to be in the *Commentaries* of Matthioli, who states that it is a wild fruit, which may be used medicinally. Among British authors, it is first mentioned by Turner, in 1573, and afterwards by Parkinson and Gerard; the last noticing it not only for its medicinal properties, but for its use in cookery. In the first edition of *Du Hamel*, the gooseberry does not appear to have been cultivated about Paris; but he says it was to be found in abundance in hedges and thickets, whence it might be transplanted into cultivated grounds, the bark having the advantage of not being liable to be eaten by the rabbits, on account of its prickles. The Dutch appear to have been the first who brought the fruit to any considerable size. In *Les Agrémens de la Campagne*, published in 1750, "les groseilles" are said to be no where so good as in Holland; and directions are given for propagating, training, and pruning the plants, so as to bring the fruit to a large size, which vary very little from the most approved practice of the best Lancashire growers of the present day; and accordingly, in the *Nouveau Du Hamel*, it is stated that M. Delaunay had seen, in Holland, gooseberries as large as plums. Allioni, in his *Auctuarium ad Floram Pedemontanam*, published in 1789, says that the fruit of the gooseberry is eatable, though it is somewhat astringent; but that it is neglected in Piedmont. In Britain, the earliest notice of the culture of the gooseberry is in Ray, who mentions the pearl gooseberry as in cultivation. The fruit appears to have been in little esteem in England, even so late as in Miller's time, though the currant was then in some repute; and in the same work it is stated, that

so little was known of it in Paris, that the Parisians had not even an appropriate name for it. In Britain, it has certainly been brought to its present highly improved state by the Lancashire weavers, about the end of the last and the beginning of the present century; and it might, probably, be traced in company with the weavers, from Lancashire to Norwich, and from Norwich back to the Low Countries, which, as we have already seen, were famous for its culture. At present, the gooseberry is universally cultivated in Britain, as one of our most valuable table and culinary fruits; and the improved British varieties are finding their way throughout the continent of Europe, and that of North America.

Properties and Uses. The unripe fruit was formerly employed, in France, in culinary preparations, for the same purposes as verjuice, to which Du Hamel says that it is inferior, from its peculiarly herbaceous taste. Gerard recommends the unripe fruit to be used in broths, instead of verjuice; and says that the ripe berries, if eaten by themselves, "ingender raw and colde bloode." The tender leaves, he says, if put into a salad, are good for curing the gravel. The gooseberry, in its present improved state, is used in British kitchens, before it is ripe, for tarts, puddings, sauces, creams, &c., and for preserving whole, from the beginning of May till the middle of July, when it becomes ripe. It is also used for making British champagne, or green gooseberry wine. When ripe, it is brought to the dessert till the end of August; and, by shading the bushes of particular kinds, a supply may be kept on them till October and November, and, in dry autumns, till Christmas. In a ripe state, its principal culinary uses are for making jam and wine; but it is also employed for tarts and puddings, which are by some preferred to those made of green gooseberries. Directions for making gooseberry wine (together with a detail of the crushing-press, utensils, &c., requisite for making the British champagne) will be found in the *Gardener's Magazine*, vol. viii. p. 180. and p. 551.; and in the same volume are also directions for making gooseberry brandy. In the General Index to the first ten volumes of the *Gardener's Magazine*, a great many references will be found to articles on the culture of the gooseberry, and on the different purposes to which its fruit is applied by British housewives; and the essence of the whole information on the subject, contained in that work, will be given in our *Suburban Gardener*. As we are here treating of the gooseberry solely as an ornamental shrub, we consider it unnecessary to enter into any details respecting the soil, situation, and culture of a shrub so easily managed.

a. *Sorts of Gooseberries belonging to Division A, with greenish white Flowers, which are not yet introduced.*

R. saxosum Hook.; *R. saxatile* Dougl. MS.; *R. triflorum* Bigel. *Fl. Bost.*, edit. 2. p. 90.; has the stems rarely prickly, and the fruit resembling a common gooseberry. It is found wild about Lake Huron, and may, we think, be considered as a variety of *R. triflorum*.

R. rotundifolium Michx. *Fl. Bor. Amer.*, 1. p. 110., has the spines nearly axillary, the leaves nearly orbicular, and the berries smooth. It is a native of the high mountains of Carolina.

R. caucasicum Adams (*Don's Mill.*, iii. p. 178.) has stipular prickles, and 5-lobed leaves. It is a native of Caucasus, and "perhaps only a subvariety of *R. G. Uva-crispa*."

R. cuneifolium Ruiz et Pav., and *R. cuneatum* Hook. et Arn., are described, in Don's *Miller*, as natives of South America, with the habit of *R. G. Uva-crispa*.

B. *Flowers red.*

❖ 12. *R. SPECIOSUM* Pursh. The showy-flowered Gooseberry.

Identification. Pursh *Fl. Amer. Sept.*, 2. p. 731.; *Dec. Prod.*, 3. p. 478.; Don's *Mill.*, 3. p. 185.

Synonymes. *R. stamineum* Smith in *Rees's Cycl.*, *Dec. Prod.*, 3. p. 477. ? *R. fuchsiioides* Fl. Mex., ic. ined., Berlandier *Mém. Soc. Phys. Gen.*, 3. pars 2. p. 43. t. 3.; *R. triacanthum* Menzies.

Engravings. ? Fl. Mex., an unpublished figure; *Mém. Soc. Phys. Gen.*, 3. pars 2. t. 3.; Sw. *Fl. Gard.*, 2d ser., t. 149.; and our fig. 722.

Spec. Char., &c. Shrub prickly. Prickles infra-axillary, triple. Branches hispid. Leaves with petiole short, and disk wedge-shaped at the base, rounded at the outer end, indistinctly 3-lobed, incisely crenate, glabrous, and nerved. Peduncles longer than the leaves, and bearing 1—3 flowers. Pedicels and germen hairy with glanded hairs. Bractees rounded or very

obtuse. Flowers of a deep red. Calyx cylindrical, 4-parted; the lobes oblong, obtuse. Petals of the length of the lobes of the calyx. Stamens 4; in length double that of the calyx. Filaments red. Style as long as the stamens, simple, red. (*Dec. Prod.*, iii. p. 477., under *R. stamineum*; and p. 478., under *R. speciosum*.) A native of America, on the western coast, and of California, on the authority of Mr. Menzies, who first discovered it there. Introduced by A. B. Lambert, Esq., in 1829, and now to be met with nearly in all good collections. The shining leaves and large crimson glittering blossoms (resembling those of the fuchsia) of this species render it a most desirable acquisition to the flower-garden and shrubbery. The leaves, in favourable situations, are frequently retained during great part of the winter; so that it may almost be considered as an evergreen. It will grow by cuttings of the old or young wood, but not so readily as most other species; and, therefore, it is generally propagated by pegging down the shoots quite flat, and covering them with an inch of soil, as recommended for the propagation of the common plum for stocks. (p. 690.) When plants are wanted expeditiously, this ought to be done in a pit, or bed of earth covered with a frame, to which heat can be applied by linings. Plants of this species do not grow so rapidly as most others of the gooseberry sections; and their branches arch over and droop in such a manner, as not to display the flowers to advantage, unless the branches are raised at least to the level of the eye. For this reason, the plant ought either to be grown on elevated rockwork, or trained to an espalier or wall; and, in the latter case, after it has attained a certain height, the lateral shoots may be allowed to protrude from the espalier or wall, when they will display their flowers to very great advantage. Judging from the plants in the Horticultural Society's Garden, we should not think that this species, as a detached bush, will attain a greater height than 3 ft. or 4 ft. Price of plants, in the London nurseries, 2s. 6d. each.



a. *Sorts of Gooseberries not yet introduced belonging to the Subsection having red Flowers.*

R. Menziesii Pursh, *R. ferox* Smith, is a native of California, at Port Trinidad, which appears to differ little, if at all, from *R. speciosum*.

R. microphyllum H. B. et Kunth is a native of the mountains of Mexico, at an elevation of 4300 ft., with the leaves small and nearly reniform, and the peduncles very short and 2-flowered. It grows to the height of from 4 ft. to 6 ft.

§ ii. *Botrycædripum* Dec.

Sect. Char. Fruit disposed in racemes; the plants having the prickles of the preceding section (*Grossularia*), and the racemose flowers of the following section (*Ribesia*). (*Don's Mill.*, iii. p. 185.) Plants intermediate between gooseberries and currants.

✽ 13. *R. ORIENTALE* Poir. The Eastern *Currant-like* Gooseberry.

Identification. Poir. Encycl. Suppl., 2. p. 856.; Desf. Arb., 2. p. 88.; Don's Mill., 3. p. 185.

Spec. Char., &c. Plant rather prickly. Leaves 3—5-lobed, somewhat reniformly orbicular, cut, hairy; lobes rather deep, obtuse. Petioles hairy. Racemes erectish, few-flowered. Bractæas longer than the flowers. Style bifid at the apex. Flowers greenish yellow. Fruit like those of the cur-

rant. (*Don's Mill.*, iii. p. 185.) A native of Syria. A shrub, growing from 4 ft. to 6 ft. high; flowering in April and May; introduced in 1824.

✽ 14. *R. SAXA'TILE* Pall. The rock *Currant-like* Gooseberry.

Identification. Pall. Nov. Act. Petr., 10. p. 726.; *Don's Mill.*, 3. p. 185.

Synonymy. ? *R. alpinum* Sievers in *Pall. Nord. Beytr.*, 7. p. 345.

Engraving. Led. Fl. Ross. Alt. III., t. 239.

Spec. Char., &c. Prickles scattered. Leaves roundish-cuneiform, bluntly 3-lobed. Racemes erect. Bractees linear, shorter than the pedicels. Calyx flat, scabrous. Sepals small, of a livid green colour. Petals small, greenish purple. Berries smooth, globose, bractless, dark purple when mature, full of edible pulp, rarely so large as common currants, but like them. (*Don's Mill.*, iii. p. 185.) A native of Siberia. A shrub, growing to the height of 4 ft. or 5 ft.; flowering in April and May. Introduced in 1819.

✽ 15. *R. DIACA'NTHA* L. fl. The twin-prickled *Currant-like* Gooseberry.

Identification. Lin. fil. Suppl., p. 157.; Berlandier in *Mém.*

Soc. Phys. Gen., 3 pars 2. t. 2. f. 8.; *Dec. Prod.*, 3. p. 479.;

Lodd. Cat., ed. 1836.

Engravings. *Mém. Soc. Phys. Gen.*, 3. pars 2. t. 2. f. 8.;

Schmidt Baum., t. 97.; and our fig. 723.

Spec. Char., &c. Stipular prickles twin. Leaves with a disk shorter than the petiole, and wedge-shaped, perfectly glabrous, and parted into 3 lobes which are dentate. Flowers upon long pedicels in long upright racemes. Bractees the length of the flowers. Sepals rounded, yellowish. Petals small, roundish. Berry ovate or globose, red. (*Dec. Prod.*, iii. p. 479.) A native of rocky places in Dahuria and Siberia. Introduced in 1781; growing to the height of 4 ft. or 5 ft., and flowering in May and June. This is a very distinct sort, easily known by its cuneated leaves and yellowish flowers. In Messrs. Loddiges's collection there is a fastigate-growing variety.

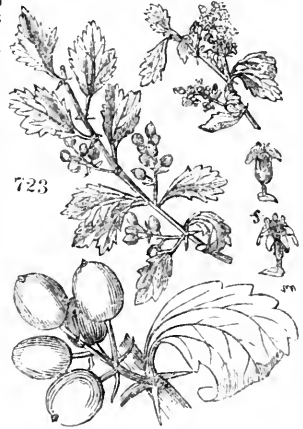

✽ 16. *R. LACU'STRE* Poir. The lake-side *Currant-like* Gooseberry.

Identification. Poir. Encycl. Suppl., 2. p. 856.; *Dec. Prod.*, 3. p. 478.; *Don's Mill.*, 3. p. 178.

Synonymy. ? *R. oxyacanthoides* Michx. *Flor. Bor. Amer.*, 1. p. 111.; *R. echinatum* Douglas MS.

Engraving. Our fig. 724.

Spec. Char., &c. Infra-axillary prickles manifold; the stem hispid with minute prickles. Leaves lobed beyond the middle; glabrous beneath, rather pilose above. Petioles villous. Peduncles ? upright, ? reflexed, bearing 2—3 flowers upon hispid pedicels. Flowers small, yellowish green. Germen hispid. (*Dec. Prod.*, iii. p. 478.) A native of moist places in Canada and Virginia. The flowers are those of the currant, and the prickly stems those of the gooseberry. The fruit is about the size of black currants, in pendulous racemes, purplish black, shining, clothed with hairs, and unpleasant to the taste. Introduced in 1812; growing to the height of 4 ft. or 5 ft., and flowering in April and May. (*Hook. Fl. Bor. Amer.*) Sir W. J. Hooker adds that "the *R. echinatum* of Mr. Douglas does not differ in any particular from *R. lacustre*."



§ iii. Ribèsia Dec. Currants.

Synonymes. Ribes sp. Lin. and others; Calobótrya, Coreósmá, and Rêbis Spach; Groseilles en Grappes, or Grosseiller commun, Fr.; Johannisbeere, Ger.; Bessenboom, Dutch.

Sect. Char. Shrubs unarmed. Racemes, for the most part, many-flowered. Leaves plicate. Calyx campanulate or cylindrical. (*Don's Mill.*, iii. p. 185.) Shrubs, the branches of which are without prickles, and the leaves and fruit of which resemble those of the currant more than those of the gooseberry.

A. Flowers greenish, or greenish yellow, or reddish; and Fruit, in a wild State, red.

☞ 17. *R. RUBRUM* L. The common red Currant.

Identification. Lin. Sp., 290.; Dec. Prod., 3. p. 481.; Don's Mill., 3. p. 187.; Lodd. Cat. ed. 1836.

Synonymes. *R. vulgare* N. Du Ham.; Grosseiller commun, Fr.; gemeine Johannisbeere, Ger.;

Roode Aallessen Boom, Dutch.

Engravings. Woodv. Med. Bot., t. 74.; Fl. Dan., 967.; Blackw. Herb., t. 285.; Smith Engl. Bot.,

t. 1289.; Krauss, t. 48.

Spec. Char., &c. Leaves cordate, bluntly 3—5-lobed, pubescent beneath, when young, usually rather tomentose, glabrous above. Racemes drooping. Bracteas ovate, shorter than the pedicels. Calyx flatly campanulate, spreading. Sepals obtuse. Petals obcordate. Fruit quite glabrous. Flowers yellowish. (*Don's Mill.*, iii. p. 187.) Native of Europe and Siberia, in woods; and throughout Canada to the mouth of the Mackenzie; found in mountainous woods, especially in the north of England and in Scotland, about the banks of rivers; undoubtedly wild on the banks of the Tees; in the Isle of Isla, and in Culross woods, Scotland. A shrub, growing from 4 ft. to 6 ft. high, and flowering in April and May.

Varieties. De Candolle gives the following forms of this species:—

☞ *R. r. 1 sylvestre* Dec. Fl. Fr., iv. p. 406.— Leaves and berries small. Lobes of leaves short.

☞ *R. r. 2 hortense* Dec., l. c.; *R. rubrum* Lois. *Nouv. Dict.*, iii. — Leaves large, sometimes variegated. Berries sweeter and larger than in var. 1. Cultivated in gardens.

☞ *R. r. 3 carneum* Berl. MSS. ex Dec. Prod., iii. p. 481.; *R. rubrum domesticum* 2 báccis carneis Wallr. *Sched.*, p. 106. — Leaves rather tomentose beneath. Sepals red. Cells of anthers distant. Berries pale red.

☞ *R. r. 4 variegatum* Dec. Prod., iii. p. 481., Wallr., l. c., has the berries beautifully variegated; or, rather, distinctly striped with white and red. In cultivation in Austria, and well deserving of a place in every collection, from the beauty and singularity of its fruit.

☞ *R. r. 5 album* Desf. Cat. Bot., p. 164., Ait. Hort. Kew., ii. p. 40., Wallr. *Sched.*, p. 106., Berl., l. c., t. 2. f. 15. — Berries white.

☞ *R. r. 6 foliis luteo variegatis* Du Ham. has the leaves variegated with yellow, and the fruit red.

☞ *R. r. 7 foliis albo variegatis* Du Ham. has the leaves variegated with white, and the fruit white.

Description. The common red currant, in a wild state, like all plants the seeds of which are of easy dissemination by birds, varies exceedingly in habit and magnitude, according to the soil, elevation, and latitude in which it happens to spring up. On mountains, among rocks, it is scarcely a foot high, with finely cut leaves; and is known by botanists under the name of *R. alpinum pumilum*. (See *fig. 726*, p. 979.) In more favourable situations, it forms a ligneous fastigate bush 5 ft. or 6 ft. high, under the form of *R. spicatum* (see *fig. 728*, in p. 980.); and, cultivated in gardens, it becomes a spreading bush, with vigorous shoots, and leaves twice the size of those it produces in a wild state. The common red currant is commonly treated by botanists as a distinct species; but we have no doubt whatever that *R. petraeum*, *R. spicatum*, *R. alpinum*,

R. prostratum, and several other botanical species, indicated, in the following pages, by an R in parentheses, between the generic and specific names, are essentially one and the same thing. We have arrived at this conclusion, from a study of the plants in the very excellent collections of this genus which are in the Garden of the Horticultural Society, and in the arboretum of Messrs. Loddiges.

Geography. The red currant, including those forms, or botanical species, which we have mentioned above as likely to be only varieties of it, is a native of many parts of Europe, of the north and west of Asia, and of North America. In Britain, *R. rubrum*, *R. alpinum*, and *R. petraeum* are found in woods or hedges, in various situations, where, in all probability, the seeds have been carried by birds. In Ireland, the red currant is also found wild in various places, as it is in Sweden. In North America, it is found as far north as the arctic circle; and it is frequent in Greece, Caucasus, Siberia, and Tartary; and, according to Royle, a species nearly allied to *R. petraeum* (which we consider to be one of the forms of the red currant) is found in situations from 5000 ft. to 10,000 ft. above the level of the sea.

History. There is no positive evidence that the ancients were acquainted with the red currant, any more than that they were with the gooseberry; it is difficult to believe that the currant which must have been conspicuous when ripe, and the grateful acid taste of which must have been found refreshing in a warm climate, could escape the notice of the inhabitants of the countries in which it was produced. The probability is, that the ancients knew this fruit, though modern botanists have not been able to identify it among the plants mentioned by Greek and Roman authors. In France, the red currant seems to have attracted notice long before the gooseberry, and, till a very late period, to have been much more valued than that fruit. Both seem to have been first improved by cultivation in Holland; whence the principal varieties in Europe have been procured. In England, the currant is mentioned by Gerard, who distinguishes three sorts, the red, the white, and the black, and gives their French and German names. None of them, he says, grow wild with us; but they are to be found growing plentifully in many gardens, especially the red and the white. Till lately, there were scarcely any varieties of the red or the white currant to be found in gardens; but, since the commencement of the present century, a great many new sorts have been raised from seed; and there are now ten excellent kinds in British gardens; the best of which are, Wilnot's red, the Dutch white, and the large champagne.

Properties and Uses. The medicinal properties of the currant consist in its allaying thirst, and lessening an increased secretion of the bile; and, in consequence of the first of these properties, it is frequently given in fevers. The juice makes a pleasant acid in punch; and, mixed with water, forms a common and very agreeable beverage, under the name of *can de grosseilles*, in Paris. *Sirope de grosseilles* is another well-known French preparation of this fruit; and, in England, currant jelly is equally well known. Currants are employed for culinary purposes in tarts and puddings; but they are usually mixed with other fruits, and are seldom, if ever, used in an unripe state. When ripe, they make an excellent wine, which is a great favourite in farm-houses, and with most persons who reside in the country, and like sweet home-made wines. The best varieties are brought to the dessert, and are much esteemed by some. The season when the fruit ripe is about the end of June, or the beginning of July; and, by having plants trained on the north face of a wall, or by covering the trees or espaliers growing as bushes in the open garden with matting, they may be kept fit for the table till Christmas.

The Propagation, Culture, &c., of the currant, for its fruit, will be found given at length in our *Encyclopædia of Gardening*, and in our *Suburban Gardener*. As an ornamental shrub, the common routine of culture prescribed for the genus may be followed.

❖ 18. *R. (r.) ALPINUM* L. The alpine red Currant.

Identification. Lin. Sp., 291.; Berlandier in Mém. Soc. Phys. Gen., 3. pars 2.; Dec. Prod., 3, p. 480.; Don's Mill., 3. p. 186.

Engravings. Mém. Soc. Phys. Gen., 3. pars 2. t. 2. f. 9.; Jacq. Austr., 1. t. 47.; Schmidt Baum., t. 96.; and our fig. 725.

Spec. Char., &c. Leaves with 3—5 lobes, obtuse, hairy above, shining beneath. Racemes grouped. Bractees lanceolate, inflated, sparingly glandulose, mostly larger than the flowers. Petals minute, as if in abortion. Anthers more or less sessile. Styles connate. Berries red. (*Dec. Prod.*, iii. p. 480.) A native of the alps of Europe and Siberia; and found, in Britain, in woods, both in England and Scotland.



Varieties. Berlandier has described two forms of the species, and Dr. Lindley has added a proper variety.

❖ *R. (r.) a. 1 stérile* Wallr. Sched., p. 108., Dec. Prod., iii. p. 480.; *R. dioicum* Maench *Meth.* — Flowers many in a raceme, and densely disposed, flat, destitute of a germen, soon falling off. Anthers almost sessile, acute, bearing pollen. (*Dec. Prod.*, iii. p. 480.)

❖ *R. (r.) a. 2 bacciferum* Wallr. Sched., p. 108., Dec. Prod., iii. p. 480. — Flowers few in a raceme, rather salver-shaped. Anthers upon obvious filaments, ? imperfect. Style bifid to a small extent. Germen obvious. (*Dec. Prod.*, iii. p. 480.)

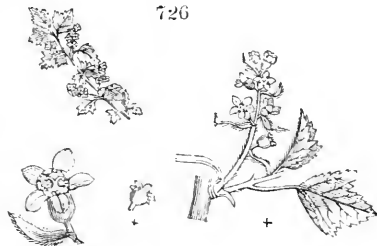

❖ *R. (r.) a. 3 pumilum* Lindl. in Hort. Trans., vii. p. 244.; and our fig. 726. — In every respect the same as the species, but not one third of the size, never exceeding 2 ft. in height, even when cultivated in gardens. The leaves are deeply cut, the flowers small, and the fruit seldom produced.

❖ *R. (r.) a. 4 foliis variegatis* Hort. has variegated leaves. There is a plant of it in the Horticultural Society's Garden.

❖ 19. *R. (r.) PETRÆUM* Wulf. The rock red Currant.

Identification. Wulf. in Jacq. Misc., 2. p. 36.; Don's Mill., 3. p. 187.

Synonymes. *R. alpinum* Delarb. *Auvergn.*, p. 166.; the woolly-leaved Currant, the red Marsh-mallow-leaved Currant.

Engravings. Engl. Bot., t. 705.; Berl., l. c., t. 2. f. 14.; Jacq. Icon., 1. t. 49.; and our fig. 727.

Spec. Char., &c. Leaves acuminate, 3—5-lobed, rather cordate, deeply serrated, on long petioles, pilose above. Racemes erect, crowded, rather pubescent. Bractees shorter than the pedicel. Sepals obtuse. Petals obovate, small, white. Berries large, deep red, with an acid taste. Fruiting racemes pendulous. (*Don's Mill.*, iii. 187.) Native of the alps of Carinthia, Savoy, and on almost all the mountains of the continent of Europe. In England, it is found near Eggleston and Concliffe, in the county of Durham; and in Scotswood



Dean, Northumberland. A shrub, growing 3 ft. or 4 ft. high, and flowering in May.

20. *R. (R.) SPICATUM* Robs. The spiked-flowered red, or Tree, Currant.

Identification. Robs. in Lin. Trans., 3. p. 240. t. 21.; Smith Engl. Bot., t. 1290.; Berl., l. c., t. 2. f. 16.; Don's Mill., 3. p. 187.

Synonymy. The Tree Currant.

Engravings. Lin. Trans., 3. p. 240. t. 21.; Engl. Bot., t. 1290.; Berl., l. c., t. 2. f. 16.; and our fig. 728.

Spec. Char., &c. Leaves roundish-cordate, 3—5-lobed, covered with soft hairs above, and with tomentum beneath. Racemes erect. Flowers more or less pedicellate. Bracteas obtuse, tomentose, much shorter than the pedicels, Sepals roundish-cuneated. Petals oblong. Styles bifid. Berries glabrous, globose, and in colour and taste resembling those of *R. rubrum*. The tree currant affords a fruit rather smaller, and more acrid, than the common red currant; but by crossing and cultivation it might, no doubt, be greatly improved; and, from its comparatively tree-like habits, might be a more convenient fruit shrub in respect to the crops around it. (*Don's Mill.*, iii. p. 187.) Native of the north of England, in woods near Richmond in Yorkshire, and between Piersbridge and Gainford in Durham. A shrub, varying from 4 ft. to 6 ft. in height, and flowering in April and May.

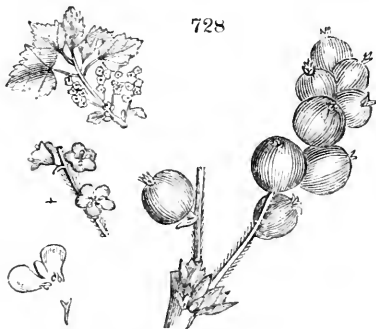

21. *R. (R.) CARPATHICUM* Kit. The Carpathian red Currant.

Identification. Kit. in Schultes *Estr. Fl.*, 2. ed. l. p. 432.; et Rœm. et Schultes Syst., 5. p. 493.; Don's Mill., 3. p. 187.

Synonymy. *R. acerrimum* Rochel ex Rœm. et Schultes, l. c.

Spec. Char., &c. Stem erect. Leaves 5-lobed, cordate. Racemes pendulous, and, as well as the calyxes, pubescent. Petals flattish, smaller than the calyx. (*Don's Mill.*, iii. p. 187.) Perhaps only a variety of *R. rubrum*. Native of the Carpathian Mountains. A shrub, growing 4 ft. high.

22. *R. (R.) MULTIFLORUM* Kit. The many-flowered red Currant.

Identification. Kit. in Rœm. et Schultes Sy., 5. p. 493., but not of H. B. et Kunth; Sims Bot Mag., 2368.; Berl., l. c., t. 2. f. 11.; Don's Mill., 3. p. 187.

Synonymy. *R. spicatum* Schultes (*Estr. Fl.*, ed. l. p. 433.

Engravings. Bot. Mag., t. 2368.; Berl., l. c., t. 2. f. 11.; and our fig. 729.

Spec. Char., &c. Leaves 5-lobed, cordate, tomentose beneath. Racemes very long, pendulous, drooping. Bracteas shorter than the flowers. Petioles length of leaves. Petals wedge-shaped. Styles bifid, and sometimes distinctly trifid. (*Don's Mill.*, iii. p. 187.) Native of Croatia. Introduced in 1822. A shrub, growing to the height of from 4 ft. to 6 ft.; flowering in April and May. The long racemes of flowers, the vigorous growth of the shoots, the large leaves, and the luxuriant habit of the plant, altogether render

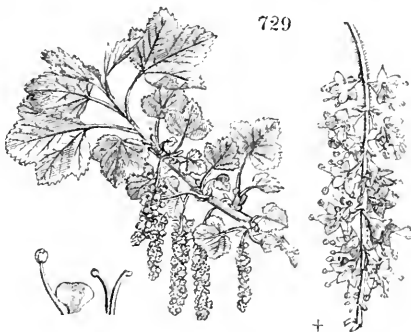

this a very ornamental sort. From the luxuriance of the flowers and leaves, and of the plant generally, fruit is seldom produced; and, when it appears, it is generally of small size. On account of the gracefulness of the long drooping racemes of flowers, it well deserves a place in collections.

✱ 23. *R. (R.) PROCUMBENS* Pall. The procumbent red Currant.

Identification. Pall. Fl. Ross., 2. p. 35. t. 65; Ait. Hort. Kew., 2. p. 41; Don's Mill., 3. p. 186.

Synonymy. *R. polycarpon* Gmel. *Syst. Veg.*, p. 419.

Engravings. Pall. Fl. Ross., 2. p. 35. t. 65; and our fig. 730.

Spec. Char., &c. Leaves bluntly lobed; lobes serrated, lateral ones a little cut. Racemes erect. Peduncles long, setaceous. Segments of the limb of the flower pubescent, acute, of a purplish colour. Anthers hardly rising from the calyx. Flowers flattish. Berries very grateful to the taste, rufescent when ripe. (*Don's Mill.*, iii. p. 186.) A native of Siberia, in moist shady places. A procumbent shrub, flowering in May and June. Introduced in 1804. The plant to which this name is attached in the collection of Messrs. Loddiges is the *R. prostratum* described below, which induces us to think that the two alleged species may possibly be the same thing.



730

✱ 24. *R. (R.) PROSTRATUM* Lin. The prostrate red Currant.

Identification. L'Hérit. Stirp., 1. p. 3. t. 2; Don's Mill., 3. p. 186.

Synonymy. *R. glandulosum* Ait. Hort. Kew., ed. 1. p. 279; Richards in *Frankl. First Journ.*, ed. 2. p. 9; Schmidt Baum., 1. 95.

Engravings. L'Hérit. Stirp., 1. p. 3. t. 2; Berl., l. c., t. 2. f. 12; Schmidt, Baum., t. 95; and our fig. 731.

Spec. Char., &c. Leaves deeply cordate, 5—7-lobed, glabrous. Lobes acutely cut, doubly serrate, naked on both surfaces. Racemes erect, loose, slender. Bracteas small, obtuse, much shorter than the pedicels, which are beset with glandular bristles. Calyx rotate. Germens and berries beset with glandular bristles. Berries large and reddish. (*Don's Mill.*, iii. p. 186.) This is a very distinct sort; a native of Newfoundland, throughout Canada, and in the woods on the Rocky Mountains. A prostrate shrub, flowering in April and May. Introduced in 1812.



731

Variety.

✱ *R. (r.) p. 2 laxiflorum*; *R. affine* Dougl. MSS.; *R. laxiflorum* Pursh *Fl. Amer. Sept.*, ii. p. 731. — Racemes pubescent. Pedicels divaricate. A native of the north-west coast of America.

✱ 25. *R. (R.) RESINOSUM* Pursh. The resinous red Currant.

Identification. Pursh Fl. Amer. Sept., 1. p. 163; Don's Mill., 3. p. 186.

Engravings. Bot. Mag., t. 1583; Berl., l. c., t. 2. f. 10; and our fig. 731.

Spec. Char., &c. All herbaceous parts of the shrub bear hairs tipped with resinous glands. Leaves 3—5-lobed, roundish. Racemes erect. Calyx flattish. Petals bluntly rhomboid. Bracteas linear, longer than the pedicels. Flowers greenish yellow. ? Berry hairy and red. Perhaps the flowers are diœcious. Very like *R. alpinum*. (*Don's Mill.*, iii. p. 186.) A native of North America, on the mountains. A shrub, growing to the height of from 3 ft. to 5 ft.; flowering in April and May. Introduced in 1800.

732



✱ 26. *R. (R.) TRIFIDUM* Michx. The trifold red Currant.

Identification. Michx. Fl. Bor. Amer., 1. p. 110; Don's Mill., 3. p. 186.

Spec. Char., &c. Leaves smooth, moderately lobed. Racemes loosely many-flowered, pubescent. Flowers small. Calycine segments rather trifid. Berries hairy, red. Lobes of leaves acutish. Racemes weak, nearly like those of *R. rubrum*, but the flowers smaller. Petals purplish, spatulate, rounded at the apex. (*Don's Mill.*, iii. p. 186.) Perhaps this is the same as *R. prostratum*. A native of North America, near Quebec, and at Hudson's Bay. A prostrate shrub; flowering in April and May. Introduced in 1823.

❖ 27. *R. (R.) ALBINE'RVUM Michx.* The white-nerved-*leaved* red Currant.

Identification. Michx. Fl. Bor. Amer. 1. p. 110. Don's Mill., 3. p. 187.

Spec. Char., &c. Leaves short, petiolate, deeply and acutely lobed, smoothish, with whitish nerves. Racemes recurved. Flowers small. Berries red, glabrous. (*Don's Mill.*, iii. p. 187.) Native of Canada and the Catskill Mountains, in the State of New York. A shrub, 4 ft. high, flowering in April and May.

❖ 28. *R. RI'GENS Michx.* The stiff-*racemed* red Currant.

Identification. Michx. Fl. Bor. Amer., 1. p. 110.; Pursh Fl. Amer. Sept., 1. p. 136.; Don's Mill., 3. p. 187.

Spec. Char., &c. Branches erect. Leaves glabrous above, pubescent beneath, wrinkled reticulately; lobes and teeth acute. Racemes rather loose, many-flowered; when bearing the fruit, stiffish and erect. Berries red, hispid. (*Don's Mill.*, iii. p. 187.) Native of Canada and the mountains of Pennsylvania. A shrub, growing from 4 ft. to 6 ft. high, and flowering in April and May. Introduced in 1812.

❖ 29. *R. PUNCTA'TUM Ruiz et Pav.* The dotted-*leaved* red Currant.

Identification. Ruiz et Pav. Fl. Per., 2. p. 12. t. 233. f. a.; Don's Mill., 3. p. 187.

Engravings. Berl. in Mém. Soc. Phys. Gen., 3. pl. 2. t. 2. f. 19.; Lindl. Bot. Reg., t. 1278.; and our fig. 733.

Spec. Char., &c. Leaves 3-lobed, serrated, beset with resinous glands beneath, as are also the bracteas. Racemes longer than the leaves, either drooping or erect. Bracteas cuneate-oblong, obtuse, at length reflexed. Calyx campanulate, yellowish. Berries oblong, hairy, red, and dotted. Petals small, yellow. (*Don's Mill.*, iii. p. 187.) Native of Chili, on hills. Introduced in 1826.

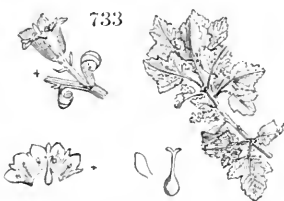

A shrub, growing 3 ft. or 4 ft. high, flowering in April and May. The leaves are shining, and of a yellowish green; and its short bunches of yellow flowers are produced in the axils of the leaves. The plant throws up suckers from the roots; a circumstance which distinguishes it from almost every other species of the genus in British gardens. There is a plant in the Garden of the Horticultural Society, against a south wall, which blossoms freely every year, and appears quite hardy, but has not yet ripened fruit. The leaves, when rubbed, have an agreeable odour.

❖ 30 *R. (P.) GLANDULO'SUM Ruiz et Pav.* The glandular-*calyxed* red Currant.

Identification. Ruiz et Pav. Fl. Per., t. 233., but not of Ait.; Don's Mill., 3. p. 189.

Engravings. Ruiz et Pav. Fl. Per., t. 233. f. 6.; Berl. in Mém. Phys. Gen., 3. pl. 2. t. 2. f. 20.

Spec. Char., &c. Leaves cordate, bluntly 3-lobed, doubly serrated, rugged. Racemes short. Calyx glandular, pubescent. A native of Chili, on wooded hills. (*Don's Mill.*, iii. p. 189.) A shrub, growing from 4 ft. to 6 ft. high; introduced in 1820, and flowering in April and May. Evidently a variety of the preceding species.

a. *Species or Varieties of Ribes belonging to the Subdivision A of the Section Ribesia, which are not yet introduced.*

R. frâgrans Pall. (*Nov. Act. Pet.*, 5. p. 377. t. 9.) has the leaves glabrous, on long petioles; and the flowers campanulate, white, and sweet-scented. The berries are red, and of a very sweet taste; and from the under surface of the leaves exudes, in numerous little yellow drops, a very fragrant balsamic resin, having a strong smell of the black currant.

R. heterotrichum Meyer in Led. Fl. Ross. Alt. III., t. 235., Fl. Alt., 1. p. 270., has the stem erectish, the leaves pubescent, nearly orbicular, 3-lobed; and the racemes and flowers erect. The calyx is of a livid purple colour, the petals purple, and the fruit like those of *R. rubrum*, but orange-coloured. It is a native of Altaia, on rocks at the foot of the mountains towards the river Kurtschum.

R. bracteosum Dougl. (*Don's Mill.*, 3. p. 186.) has the leaves on long petioles, and nearly as large as those of the *Acer Pseudo-Platanus*. The flowers are of a purplish yellow, and the fruit about the size of that of *R. rubrum*. It is a native of the north-west coast of America, at the confluence of the Columbia with the ocean, whence specimens were sent home by Mr. Douglas, from which a description is given in Hooker's *Flora Borealis Americana*.

R. tubiflorum Meyer is a native of California, with cordate leaves, and spicate, terminal, drooping racemes; the flowers having tubular calyces, exceeding the bracteas.

R. tubulosum Eschscholtz is a native of North California, with hoary, rigid, dark purple branches, cordate 3-lobed leaves, and pale brown petals. It is considered as nearly allied to *R. albinervium*, and also to *R. sanguineum*.

R. macrobotrys Ruiz et Pav. Fl. Per., 3. p. 12. t. 202., Berl. in Mém. Phys. Gen., 3. pl. 2. t. 2. f. 17., has cordate leaves, and very long pendulous racemes, rufescent calyces, and greenish hairy berries. It is a native of Peru, on the Andes, in groves.

R. albiflorum Ruiz et Pav. Fl. Per., 3. p. 12. t. 182. f. 6., Berl., 1. c., t. 2. f. 18., is a native of Peru, and nearly allied to the preceding species.

R. citiânum Willd., *R. jorullense* H. B. et Kunth, has 5-lobed leaves, deeply cordate, and is also nearly allied to *R. macrobotrys*. It is a native of Mexico, on the burning Mount Jorullo, at an elevation of 1500 feet.

R. hirtum Thunb. et Bonpl., *R. frigidum* H. B. et Kunth, Berl., 1. c., t. 2. f. 13., has ovate-cordate 3-lobed leaves, flesh-coloured flowers, and hispid berries. It is a native of South America, in cold places, on Mount Antisana, at an elevation of 300 ft.

R. campanulatum Thunb. et Bonpl., *R. affine* H. B. et Kunth, has 5-lobed, crenated, cordate leaves, and campanulate white flowers. It is a native of Mexico, near Moran, at an elevation of 3900 ft.

R. Kunthii Berl.; *B. multiflorum* H. B. et Kunth, but not of Kit.; is a native of Mexico; and is generally found with *R. campanulatum*, which it closely resembles.

R. Takâre D. Don *Prod. Fl. Nep.*, p. 208., has cordate, 3-lobed, acuminate leaves, as large as those of the common sycamore; but the flowers have not been observed.

R. acuminatum Wall., Royle *Illustr.*, p. 225., has glabrous branches, leaves 3—5-lobed, and berries about the size of red currants. It is a native of Nepal on Sirmore and Emodi, at elevations of from 8000 ft. to 10,000 ft., where it grows to the height of 5 ft. or 6 ft.

R. villosum Wall. has pubescent branches, and nearly orbicular leaves, with erect few-flowered racemes. It is a native of the Himalayas, in Sirinegur.

B. *Flowers greenish yellow, sometimes with the Tips of the Sepals and Petals red. Fruit black.*

♣ 31. *R. NI'GRUM* L. The black Currant.

Identification. Lin. Sp. 291.; Don's Mill., 3. p. 190.

Synonymes. *R. glidum* *Mench Meth.*, 683.; *Capis* and *Poivrier*, Fr.; *schwartzte Johannisbeere*, Ger. *Engravings.* Berl., 1. c., t. 2. f. 21.; Woodv. *Med. Bot.*, t. 75.; Fl. Dau., 556.; Blackw. Herb., 285.; Engl. Bot., t. 1291.; and our fig. 734.

Spec. Char., &c. Leaves dotted from glands beneath, 3—5-lobed. Racemes loose. Bracteas minute, subulate or obtuse, much shorter than the pedicels. Petals oblong. Calyx campanulate, with reflexed segments. Flowers whitish, or yellowish green. Calyx often of a rich brownish red colour,

734



or pink. Stamens sometimes more than 5, in which case there are fewer petals; so that when there are 10 stamens there are no petals. This change of petals into stamens is just the reverse of the process by which single flowers become double; and it is the only fact of the kind which has

hitherto been observed. Stigmas bifid. Berries globose, black, glandular. The black currant is a shrub with smoothish branches, strong-smelling leaves, with a solitary 1-flowered pedicel at the base of each raceme. The flowers appear in April, and the fruit ripens in June and July; and, when ripe, changes from a green to black or a rich dark purple. (*Don's Mill.*, adapted, iii. p. 190.) A native of most parts of Europe; growing to the height of from 4 ft. to 6 ft., and flowering in April.

Varieties. In a wild state, there are scarcely any varieties of what by botanists is considered to be *R. nigrum*; but the botanical species, *R. triste* *Pall.*, *R. altaicum* *Pall.*, and some others, we consider to be nothing more than seminal varieties of the black currant in a wild state. The black currant is indigenous in the woods of Russia, as far north as St. Petersburg; and we are informed by a correspondent there, on whom we can rely, that it is not uncommon to meet with plants having the fruit, when ripe, green or yellow, and sometimes even white. We are inclined to think that the alleged hybrid with yellow fruit, mentioned below, of which we have possessed a plant since 1827, may be nothing more than one of these varieties.

✻ *R. n. 2 báccá flávidá* *Gard. Mag.*, vol. 10. p. 171., is supposed to be a hybrid between the black and white currants, and to have been originated in the neighbourhood of Bath, previously to 1827. The fruit is of a dingy greenish yellow; but the plant has the habit and general appearance of *R. nigrum*.

✻ *R. n. 3 báccá víridá* *Hort.* has the fruit green when ripe. This variety is common in Russia in a wild state; and plants of it are in the Horticultural Society's Garden.

✻ *R. n. 4 fóliis variegátis* *Vilmorin* has the leaves variegated with streaks of yellow. There is a plant of it in Dennis's Nursery, King's Road, Chelsea.

Garden Varieties. Six of these are enumerated in the Horticultural Society's *Fruit Catalogue* of 1831, the best of which are the black Naples and the large black. The fruit of the former variety is very large and handsome, more especially when the plant is grown in deep rich soil, and in a situation rather shady and moist.

Description. The black currant, in a wild state, forms a lower and more divergent bush than the red currant. The wood is smooth and soft, and the buds large; the leaves are large, soft, glandular, and, as well as the branches and buds, have a strong savin-like scent when rubbed. The flowers are green or yellowish, often with the tips of the sepals red; and the fruit, in a wild state, is much larger than that of the red currant. It is a vigorous free-growing shrub, but not of long duration.

Geography, History, &c. The black currant appears to have the same geographical range as the red; but it is much more abundant than that species in the north of Europe, and less so in the south. In Britain, it is not unfrequent in woods and hedges, in some districts; but it is probably not truly indigenous any where. It is particularly abundant in the north of Russia, where its fruit is much sought after by bears. It is found in Siberia, and on Caucasus, and is abundant in Sweden. There appear to be species of *Ribes* with black fruit in India and South America, which are probably varieties of *R. nigrum*, and may be considered as the black currant of those countries. When the black currant was first cultivated in gardens is uncertain; and there is no evidence of its having been known to the ancients, which it probably was not, on account of the plant being comparatively uncommon in the south and east of Europe. It is mentioned by Gerard, who speaks of it as having flowers of a purplish green colour, succeeded by fruit as big again as the ordinary red currant, but "of a stinking and somewhat loathing savour." The black currant is not mentioned by the earliest French horticultural writers; but in Du Hamel's *Arbres Fruitiérs* it is enumerated among other fruit shrubs, though it is described more as a medicinal plant than as a table fruit. Its fruit, Du Hamel says, passes for being stomachic,

diuretic, cordial, and tonic; and a ratafia is made from it that promotes digestion. The flavour and taste of the fruit being disagreeable to many, it is still but partially cultivated in British gardens, more especially in England. In Scotland it is held in more esteem, on account of the jelly that is made from it being considered a sovereign remedy for sore throats.

Properties and Uses. The leaves, the fruit, and the entire plant, especially in a wild state, are considered powerfully diuretic; in Siberia the leaves form a principal ingredient in the drink known as quass; and the berries being fermented with honey, a powerful spirit is distilled from them. The leaves, when young, are put into spirits, so as to give the liquor a brownish tinge like that of brandy. An infusion of the young roots is given to cattle, in Russia, as a febrifuge. The leaves, in a dried state, smell like green tea; and a very small portion of them will communicate that flavour so effectually to black tea, as completely to deceive the taste. In the north of Russia, the berries of both the black and the green varieties are gathered from the woods in large quantities, dried in ovens, or in the sun, and laid up for being used in winter, either medicinally for the quinsy, and other diseases of the throat, or for making tarts. The fruit, whether fresh or dried, is also used in Sweden, and other parts of the north of Europe, as a remedy for sore throats. In England, the principal use of the fruit is for making a jam, or rob, which, like the jelly made in Scotland, is considered excellent for sore throats; but the fruit is seldom used either in tarts or puddings, or for making wine. In Scotland, the jelly is considered to add an excellent flavour to whisky and water. The treatment of the black currant, as a fruit tree, will be found in the *Encyclopædia of Gardening*, and in the *Suburban Gardener*.

♣ 32. *R. (N.) TRI'STE* Pall. The sad-coloured, or dark-blossomed, black Currant.

Identification. Pall Nov. Act. Pet., 10. p. 378.; Don's Mill., 3. p. 189.

Synonymy. *R. altâicum* Lodd. Cat.

Spec. Char., &c. Leaves 5-lobed. Branches simple, twiggy, bearing leaves and racemes of flowers at the apex. Racemes pendulous, both when in flower and in fruit. Corollas flattish, of a dull brownish-red on the outside, and yellowish inside. Petals revolute. Berries small, black, insipid. Root creeping. (*Don's Mill.*, iii. p. 189.) A native of Siberia, on the Mongol Mountains; growing 2 ft. or 3 ft. high, and flowering in April and May. Introduced in 1820; and obviously only a variety of the common black currant.

♣ 33. *R. (N.) FLO'RIDUM* L'Hérit. The flowery black Currant.

Identification. L'Hérit. Stirp., 1. p. 4.; Don's Mill., 3. p. 190.

Synonymy. *R. nigrum*, 2. *Lin. Sp.*, 291.; *R. pennsylvanicum* *Lam. Dict.*, 3. p. 49.; *R. recurvatum* Michx. *Fl. Ber. Amer.*, 1. p. 109., according to Torrey; *Ribesium nigrum*, &c., *Dill. Elth.*, 2 t. 244. f. 315.

Engravings. Dill. Elth., 2. t. 244. f. 315.; Berl., l. c., t. 2. f. 22.; Schmidt Baum., t. 92.; and our fig. 735.

Spec. Char., &c. Leaves full of resinous glands, 3 or 5-lobed, cordate, doubly serrated. Racemes pendulous, pubescent. Bractæas linear, longer than the pedicels. Calyx tubularly campanulate, glabrous: with the segments obtuse, and at length reflexed. Germens and black berries oval-globose, glabrous. This is in many respects nearly allied to *R. nigrum*; but its more copious and denser flowers, and especially their long bractæas, and more tubular calyxes, will always distinguish it: the solitary pedicel, too, at the base of the flowers, is wanting in this species. Petals oblong, rather crose at the apex; greenish yellow. (*Don's Mill.*, iii. p. 190.) A shrub, growing from 4 ft. to 6 ft. high, and flowering in April and May. Introduced in 1729. We admit the distinct-



ness of this sort ; but, judging from the plants in the Horticultural Society's Garden, and in the arboretum of Messrs. Loddiges, as well as from a very beautiful figure in Schmidt's *Baumzucht*, we cannot but consider it as a variety, or race, of the black currant ; but in this, as in similar cases, we have treated it as a species, in order to leave the reader free to form his own judgment on the subject. We have only indicated our opinion by putting the letter *n* in parentheses, between the generic and specific names.

Varieties.

- ☞ *R. (n.) f. 2 grandiflorum* Hort. has the flowers and racemes larger than those of the species.
- ☞ *R. (n.) f. 3 parviflorum* Hort. has the flowers smaller, and the racemes shorter.

☞ 34. *R. (N.) INE'BRIANS* Lindl. The intoxicating black Currant.

Identification. Lindl. in Bot. Reg., t. 1471 ; Don's Mill., 3. p. 190.
Engravings. Bot. Reg., t. 1471 ; and our fig. 736.

Spec. Char., &c. Leaves roundish, deeply 3—5-lobed, and deeply toothed, truncate at the base, glandular on both surfaces. Petioles pubescent. Peduncles 3—5-flowered, pendulous. Flowers aggregate. Calyx tubular, glandular, with the segments recurved. Calyx greenish white, with the tube 4 lines long. Leaves smelling like those of *R. floridum*. The species was received from Mr. Floy of New York, under the name of the intoxicating currant, but without any other account of its properties. The berries probably possess some narcotic quality. (*Don's Mill.*, iii. p. 190.) A native of North America, growing to the height of 3 ft. or 4 ft., and flowering in April. Introduced in 1827.



☞ 35. *R. CEREUM* Dougl. The waxy-leaved black Currant.

Identification. Dougl. in Hort. Trans., 7. p. 512 ; Bot. Reg., 1263 ; Hook. Fl. Bor. Amer., 1. p. 234 ; Don's Mill., 3. p. 190.
Engravings. Bot. Reg., t. 1263 ; and our fig. 737.

Spec. Char., &c. Leaves small, cordate, lobed, serrated, clothed with glandular pubescence, glabrous, glaucous, full of white glands above. Racemes pendulous, rather capitate. Bractees ovate, adpressed to the germen, which are glabrous. Flowers nearly sessile, cylindrical, rather angular. Calycine segments small, reflexed. (*Don's Mill.*, iii. p. 190.) In its small foliage, and few-flowered racemes, this species resembles the gooseberry tribe ; but it has not thorns. The flowers are rather large and white, with a slight tinge of green, and are rather downy. White waxy dots like scales cover the upper surface of the leaf ; whence the specific name. A native of North-west America, on the banks of the Columbia, and its southern tributary streams, from the Great Falls to the



Rocky Mountains, in gravelly or sandy soils. A shrub, growing 2 ft. or 3 ft. high, and flowering in April. Introduced in 1827.

♁ 36. *R. VISCOSISSIMUM* Pursh. The very clammy black Currant.

Identification. Pursh Fl. Amer. Sept., 1. p. 153; Dougl. in Trans. Hort. Soc., 7. p. 511; Don's Mill., 3. p. 191.

Synonyme. *Coreösmia viscosissima* Spach Ann. des Scienc. Nat., 1855.

Engraving. Hook. Fl. Bor. Amer., 1. p. 234. t. 74.

Spec. Char., &c. Leaves cordate, obtuse, 3—5-lobed, deeply crenated. Viscid and glandular pubescence. Glands on both surfaces. Racemes erect, corymbose. Bracteas linear-obovate, rather shorter than the pedicels, which are clothed with glandular hairs. Calyx tubularly campanulate, with erectly spreading obtuse segments. Germens and fruit ovate-oblong, clothed with viscid hairs. Berries oblong-ovate, black. Flowers large and white. (*Don's Mill.*, iii. p. 191.) A native of North America, on the Rocky Mountains, and in dry plains, in partially shaded places towards the sources of the Columbia; also on the summits of the hills near the Spokan and Kettle Falls, at an elevation of 8000 ft. above the sea. (*Dougl. in Hook. Fl. Bor. Amer.*) A shrub, attaining the height of from 4 ft. to 8 ft.; producing its flowers in April and May. Introduced in 1826. "A very fine and remarkable species." (*Hook.*) It is somewhat difficult to keep: the only plants we know of it, in the neighbourhood of London, are in the nursery of Mr. Cree, the author of *Hortus Adlestouensis*, at Adlestone, near Chertsey, in Surrey.



738

♁ 37. *R. HUDSONIANUM* Richardson. The Hudson's Bay black Currant.

Identification. Richards in Frankl. First Journ., ed. 2. append. p. 6; Don's Mill., 3. p. 190.

Synonyme. *R. petiolare* Dougl. Hort. Trans., 7. p. 514.

Spec. Char., &c. Branches erect. Leaves 3-lobed, quite glabrous above, full of resinous dots beneath, and, as well as the petioles, villous. Germens dotted. Berries globose, glabrous, black. Racemes erect, pubescent. Bracteas short. Segments of the calyx, which is campanulate, spreading. Flowers small. Petals white. The fruit, and peculiar odour of the plants, are those of *R. nigrum*. (*Don's Mill.*, iii. p. 190.) It is a native of North America, from Hudson's Bay to the Rocky Mountains, in the west, and as far north as lat. 57°, including the mountains of Columbia, about the Kettle Falls. A shrub growing to the height of 3 ft. or 4 ft. Plants of this sort are in the Horticultural Society's Garden.

♁ 38. *R. GLACIALE* Wall. The icy black Currant.

Identification. Wall. Cat., No. 6833; Don's Mill., 3. p. 189.

Spec. Char., &c. Bracteas smooth. Leaves glabrous above, but with few scattered bristly hairs beneath, cordate at the base, 3—5-lobed at the apex; lobes acute, serrated. Petioles long, serrated at the base. Racemes drooping. Calyx campanulate. Petals longer than the calyx. Flowers white. Berries black. (*Don's Mill.*, iii. p. 189.) A native of Nepal, on Emodi and Gosainthan; growing from 4 ft. to 6 ft. high, and flowering in April and May. Introduced in 1823. There is a plant of it against a wall, in the Horticultural Society's Garden.

a. *Species or Varieties of Ribes belonging to the Division B of the Section Ribèsia, which have not yet been introduced.*

R. Biebersteinii Berl. in Dec. Prod., 3. p. 482; *R. caucasicum* Bieb.; has cordate, sharply serrated leaves, having a strong scent, like those of *R. nigrum*; nodding racemes, minute petals, and black berries. It is a native of Caucasus, and is, probably, only a variety of *R. nigrum*.

R. viscosum Ruiz et Pav. has cordate, 5-lobed, rough, clammy, 5-nerved leaves, and yellow flowers, with small pale purple berries. It is a native of Peru, on rocks.

C. *Flowers deep red. Fruit black.*

- ☞ 39. *R. SANGUI'NEUM* Pursh. The bloody, or red, flowered, Currant.

Identification. Pursh Fl. Amer. Sept., 1. p. 164.; Don's Mill., 3. p. 191.

Synonymes. *R. malvaceum* Smith in Rees's Cycl.; *Calobótrya sanguinea* Spach.

Engravings. Hort. Trans., 7. t. 13.; Bot. Reg., t. 1349.; Swt. Fl.-Gard., n. s., t. 109.; and our fig. 739.

Spec. Char., &c. Leaves cordate, somewhat 5-lobed, serrated, veiny, smoothish above, but clothed with villous tomentum beneath. Racemes drooping, pubescent, twice the length of the leaves. Calyx tubularly campanulate, with oblong, obtuse, spreading segments, exceeding the petals, which are red, and quite entire. Bractees obovate-spathulate. Berries turbinate, hairy. This is, perhaps, the most ornamental species of the genus, bearing a profusion of large racemes of deep rose-coloured flowers, and is, therefore, well adapted for ornamenting shrubberies and pleasure-grounds. The berries are of a bluish black, and insipid; resembling a bilberry more than either a currant or a gooseberry. (*Don's Mill.*, iii. p. 191.) A native of the north-west coast of America, in abundance, from lat. 38° to 52° N.; usually growing in rocky situations, by the sides of streams. A shrub, 4 ft. to 8 ft. high, flowering in April. Introduced in 1826, and forming by far the most ornamental species of the genus. It is easily propagated, and as hardy as the common black currant. It flowers profusely; and, coming into bloom early in the season, forms the most splendid bush to be seen in British shrubberies, from the middle of April to the middle of May. A great many seeds were sent over by Mr. Douglas, a number of which were distributed by the Horticultural Society; and the plants produced from them have varied in the colour of their flowers, from pale pink to deep red. The plants, also, seed freely in this country; and hence a number of varieties have been originated by nurserymen, independently of *R. (s.) malvaceum* and *R. (s.) glutinosum*, which differ from the species, not only in the shades of colour of their flowers, but also in their leaves. The variety which has the darkest-coloured flowers is *R. s. atro-rubens*.

*Varieties.*

- ☞ *R. (s.) 2 glutinosum* Benth. Hort. Trans., 2d ser. 1. part 6.; *R. augustum* Dougl. MS. and our fig. 740., has the foliage destitute of down, and slightly viscous. The racemes are rather larger than in the species, and of a very pale rose-colour.

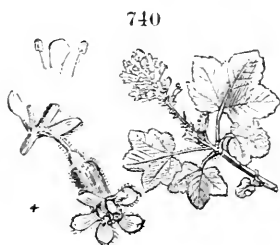

- ☞ *R. (s.) 3 malvaceum* Benth., l. c., and our fig. 741., has the leaves rough and hispid on the upper side, and clothed underneath with a whitish cottony down. The racemes of flowers are shorter and closer; and each flower is almost sessile on the common stalk. In colour, the flowers are rather darker than those of *R. (s.) glutinosum*, and have more of a lilac tinge.

☞ *R. s. 4 atro-rubens* Hort. has the flowers and racemes rather smaller, and of a much deeper and darker red, than those of the species. Plants of this variety, in the Horticultural Society's Garden, when in flower, are strikingly distinct.

a. *Species or Varieties of Ribes belonging to the Division C of the Section Ribesia, which have not yet been introduced.*

☞ 40. *R. A'TRO-PURPU'REUM* Meyer. The dark-purple-flowered Currant.

Identification. Meyer in Led. Fl. Ross. Alt. III., t. 231.; Fl. Alt., 1. p. 268.; Don's Mill., 3. p. 191. *Engraving.* Led. Fl. Ross. Alt. III., t. 231.

Spec. Char., &c. Stem erect. Leaves pubescent, nearly orbicular, cordate, 3—5-lobed; lobes acute, serrated. Racemes drooping. Pedicels exceeding the bracteas. Calyxes campanulate, ciliated. Berries glabrous, and bractless; dark purple, and the size of those of the common currant. (*Don's Mill.*, iii. p. 191.) A native of Altaia, on mountains and subalpine places on the river Ural; and also at the river Tscharysch. A shrub, growing from 4 ft. to 6 ft. high, and producing its flowers in April and May.

Varieties.

- ☞ *R. a. 1.* — Flowers deep purple. Leaves rather pubescent beneath, but smooth and glabrous above, as well as the branches.
- ☞ *R. a. 2.* — Leaves rather pubescent beneath, but hispid from bristles above, as well as the petioles and stems. Found near the river Volschoi Ulegumen.
- ☞ *R. a. 3.* — Flowers paler. Leaves pubescent above, but most so below. Branches smooth.

§ iv. *Symphócalyx* Dec.

Derivation. From *symphuō*, to grow together, and *kalux*; in reference to the sepals of the calyx of the species belonging to this section.

Sect. Char. The calyxes tubular, and yellow. The racemes many-flowered. Leaves compassing the bud. Unarmed shrubs. (*Dec. Prod.*, iii. p. 483.)

☞ 41. *R. AU'REUM* Pursh. The golden-flowered Currant.

Identification. Pursh Fl. Amer. Sept., 1. p. 164.; Don's Mill., 3. p. 191. *Synonymes.* *R. palmata* Desf. *Cat. Hort., Paris.*; *Chrysobótrya revoluta* Spach.

Engravings. Berl., l. c., t. 2. f. 23.; Bot. Reg., t. 125.; and our fig. 762.

Spec. Char., &c. Quite glabrous. Leaves three-lobed, lobes divaricate, with a few deep teeth, shorter than the petioles, which are ciliated at the base. Calyxes tubular, longer than the pedicels. Tube slender. Segments oblong, obtuse. Petals linear, much shorter than the calycine segments. Bracteas linear, length of the pedicels. Style entire. Berries glabrous. Flowers golden yellow. Fruit yellow, seldom black, and of an exquisite flavour. (*Don's Mill.*, iii. p. 191.) A native of North-west America, in light gravelly soils, from the Great Falls of the Columbia River, to the mountains, and on the southern branches. A shrub, growing 6 ft. or 8 ft. high; flowering in April and May. Introduced in 1812.

Varieties.

☞ *R. a. 1 præcox* Lindl. in Hort. Trans., vii. p. 242. — Flowers earlier. Leaves cuneated at the base, pubescent beneath; lobes deeply serrated. Berries copious, earlier, turbinate. Racemes bracteate. A native of North America.

☞ *R. a. 2 villösium* Dec. *Prod.*, iii. p. 483.; *R. longiflorum* *Fraser's Cat.*, 1813. — Leaves rather villous.

☞ *R. a. 3 serótinum* Lindl., l. c.; and our fig. 743. — Flowers late. Leaves of various forms, smoothish beneath; lobes deeply serrated. Berries few, late, round. Racemes naked. A native of North America.



This, and the preceding varieties, are highly ornamental, from their fine, large, bright yellow flowers, which are produced in abundance; and their smooth, glossy, yellowish green leaves. The plants are, also, most truly ligneous, and of greater duration, than those of most other species of *Ribes*. Next to *R. sanguineum*, and its varieties, they merit a place in every collection.

✻ 42. *R. (A.) TENUIFLORUM* Lindl. The slender-flowered Currant.

Identification. Lindl. in Hort. Trans., 7. p. 242; Bot. Reg., 1274; Don's Mill., 3. p. 191.
Synonymes. *R. aureum* Colla Hort. Rip. Append., 3. t. 1. f. A.; *R. flavum* Bert. in Dec. Prod., 3. p. 483; *R. missouriensis* Hort.; *Chrysobötrya* Lindleyana Spach.
Engravings. Bot. Reg., t. 1274; and our fig. 744.

Spec. Char., &c. Unarmed, quite glabrous. Leaves roundish, 3-lobed, mealy; lobes bluntly toothed at the apex. Racemes pendulous, many-flowered.

Calyx tubular, glabrous, longer than the pedicels, coloured. Petals quite entire, linear, one half shorter than the segments of the calyx, which are oblong and obtuse. Bracteas linear, length of the pedicels. Berries glabrous. In habit, this species is more erect than *R. aureum*, and has the young wood more thinly clothed with leaves; its whole appearance is also paler, during the early part of the season. The flowers are not more than half the size of *R. aureum*; and have entire, not notched, petals. The fruit is about the size of the red currant, of an agreeable flavour but possessing little acidity. (*Don's Mill.*, iii. p. 191.) A native of North America; common on the rocky tracts of the Columbia, near the head waters of the Missouri. A shrub, attaining the height of 6 ft. or 8 ft.; and producing its flowers in April and May. Introduced in 1812.

744



Varieties.

- ✻ *R. (a.) t. 1 fructu nigro.*—Berries changing from yellow to red, and finally acquiring a deep blackish purple colour.
- ✻ *R. (a.) t. 2 fructu luteo.*—Fruit yellow; always retaining the same colour.

✻ 43. *R. (A.) FLAVUM* Coll. The yellow-flowered Currant.

Identification. Coll. Hort. Ripul. Append., 3. p. 4. t. 1. f. β.; Don's Mill., 3. p. 191.
Synonymes. *R. aureum* 3 sanguineum Lindl. in Hort. Trans., 7. p. 242; *R. palmatum* Desf. Hort. Par.; *R. aureum* Ker Bot. Reg., t. 125., but not of Pursh; *Chrysobötrya intermedia* Spach.
Engraving. Coll. Hort. Ripul. Append., 3. p. 4. t. 1. f. 2.

Spec. Char., &c. Unarmed, quite glabrous. Young leaves 3-lobed; adult ones usually 5-lobed, deeply toothed, about equal in length to the ciliated petioles. Racemes short, 4—5-flowered. Calyx tubular, much longer than the pedicels. Tube slender. Segments rather spatulate, reflexed. Petals one half shorter than the calycine segments. Bracteas elliptic. Berries oblong, glabrous. Flowers yellow. (*Don's Mill.*, iii. p. 191.) A native of North America. A shrub, growing 6 ft. or 8 ft. high; flowering in April and May. Introduced in 1812.

App. i. *A Classification of the Species and Varieties of Ribes in the Horticultural Society's Garden in 1836, made by Mr. Gordon, Foreman of the Arboretum there.*

In the following synopsis, the authorities put immediately after the names of the plants are those of the nurserymen, or others, who sent the plants with these names to the Horticultural Society's Garden; the authorities in parenthesis are references to books; and the references to figures are those

in our own pages. In short, we have here followed the plan which we adopted under *Crataegus*, in giving Mr. Gordon's arrangement of that genus; and for the same reasons as those there given. (See p. 816.)

§ i. NI'GRA (or those like the common Black or Red Currant).

Leaves large, and strongly scented. *Flowers* in bunches.

1. *R. alpinum* (*Lin. Spec.*, 296; *fig.* 725. in p. 979.)
syn. dioicum *Masters*, nurseryman, Canterbury. (*Manch Meth.*, p. 683.)
2. *R. alpinum pumilum* *Miller*, Bristol Nursery. (*Lindl.*, *fig.* 726. in p. 979.)
3. *R. resinosum* *Loddiges*; (*Pursh Fl. Amer. Sept.*, 1. p. 163; *fig.* 732. in p. 981.)
syn. orientale *Catros*, nurseryman, Bourdeaux.
reclinatum of some collections.
4. *R. nigrum* *Thompson*, Mile End Nursery. (*Lin. Spec.*, 291; and *fig.* 734. in p. 983.)
syn. alidum of some French collections. (*Manch.*)
5. *R. nigrum variegatum* *Vilmorin*, Paris.
6. *R. triste* *Loddiges*. (*Pall. Nov. Act. Petr.*, 10. p. 278.) Only differing from the common black currant in the dull brown colour of the flowers.
7. *R. petiolare* *Douglas*.
8. *R. prostratum* *Falla*, nurseryman, Gateshead. (*L'Her. Stirp.*, 1. p. 3. t. 2.)
syn. canadense *Loddiges*.
glandulosum *Ait.* (*Hort. Kew.*, 1. p. 279, not of Ruiz et Pavon.)
9. *R. viscosissimum* *Douglas*. (*Pursh Flor. Bor. Amer.*, 1. p. 163; *fig.* 738. in p. 987.)
10. *R. floridum parviflorum* *Cels*, nurseryman, Paris. (*L'Her. Stirp.*, 1. p. 4.)
syn. americanum *Miller*.
pennsylvanicum *Cels*. (*Lam. Diet.*, 3. p. 49.)
campanulatum of some foreign collections.
11. *R. floridum grandiflorum* *Sabine*. (*fig.* 735. in p. 985.)
syn. rigens *Miehr.* (*Flor. Bor. Amer.*, 1. p. 110.)
12. *R. malvaceum* *Douglas*. (*Smith in Rees's Cycl.*; and *fig.* 741. in p. 988.)
13. *R. glutinosum* *Bentham*. (*Hort. Trans.*; and *fig.* 740. in p. 988.)
syn. augustum *Douglas*.
14. *R. sanguineum* *Douglas*. (*Pursh Fl. Amer. Sept.*, 1. p. 164; and *fig.* 739. in p. 988.)
15. *R. sanguineum* var. atro-rubens *Douglas*.
16. *R. rubrum* *Thompson*. (*Lin. Spec.*, 290.)
17. *R. rubrum sibiricum* *Oldaker*, gardener at Stoke Farm.
syn. Russian Currant.
18. *R. rubrum fructu albo* *Thompson*.
syn. White Currant.
19. *R. rubrum variegatum*.
20. *R. spicatum* *Loddiges*. (*Robt. Lindl. Trans.*, 3. p. 240. t. 21; and *fig.* 738. in p. 980.)
21. *R. multiflorum* *Whitley*, Fulham Nursery. (*Kitabel in Rœm. et Schult. System.*, 5. p. 493; *Bot. Mag.*, 2368; and *fig.* 729. in p. 980.)
22. *R. petraeum* *Lec.*, Hammersmith Nursery. (*Wulf. in Jacq. Misc.*, 2. p. 56; *Eng. Bot.*, t. 705; and our *fig.* 727. in p. 979.)
23. *R. glaciæ* *Royle*, 1835. (*Wall.*)
24. *R. punctatum* *Lindl.* (*Bot. Reg.*, t. 1658; and our *fig.* 733. in p. 981.)
syn. prostratum *Ruiz et Pav.* (*Fl. Peruv.*, 3. 12. t. 233. f. a.)

§ ii. AU'REA (or those like the Missouri Yellow Currant).

Leaves small and shining. *Flowers* large, not in bunches, 3 or 4 together.

25. *R. aureum præcox* *Godfrey*. (*Pursh Fl. Amer. Sept.*, 1. p. 164; and our *fig.* 742. in p. 989.)
26. *R. aureum serotinum* *Douglas*. (*Pursh*; and our *fig.* 743. in p. 989.)
syn. missouriense *Loddiges*.
Missouri Currant.
27. *R. aureum serotinum fructu læteo* ? *Floy*, Nurseryman in New York.
28. *R. aureum sanguineum* *Floy*. (*Lindl. Bot. Reg.*, t. 125.)
syn. flavum *Hort.*
29. *R. tenuiflorum* (? *Lindl.*) fructu aureo *Prince*. (*Bot. Reg.*, t. 1574; and *fig.* 744. in p. 990.)
30. *R. tenuiflorum fructu nigro* *Floy*.

§ iii. CE'REA (or those small Gooseberry-leaved, and few-flowered, Gooseberry-like Currants which resemble *R. cereum*).

Leaves small and powdered. *Flowers* 3 or 4 together. *Fruit* shining and smooth.

31. *R. cereum* *Douglas*. The flowers of a light rosy pink, and fruit of a beautiful amber colour. (*Bot. Reg.*, t. 1263; *Gard. Mag.*, 5. p. 522; and *fig.* 757. in p. 986.)
32. *R. inebrians* *Floy*. (*Lindl. Bot. Reg.*, t. 1471; *Gard. Mag.*, 8. p. 225; and *fig.* 756. in p. 986.)
syn. Intoxicating Red Currant.

§ iv. GROSSULA'RIÆ (or those resembling the common Gooseberry).

Leaves small and shining. *Flowers* yellowish green, white, or crimson, and not more than 3 or 4 together. *Spines* few and large.

33. *R. niveum* *Douglas*. (*Bot. Reg.*, t. 1692; and *fig.* 718. in p. 970.)
Habit very upright. Flowers white.
34. *R. speciosum* *Douglas*. (*Pursh Fl. Amer. Sept.*, 2. p. 731; *Swt. Brit. Fl. Gard.*, 2d ser., t. 149; *Bot. Reg.*, t. 182; *Gard. Mag.*, 8. p. 455; and *fig.* 722. in p. 975.)
syn. stamineum *Lambert*. (*Smith in Rees's Cycl.*)
35. *R. irriguum* *Douglas*. (*Hook. Fl. Bor. Amer.*, 1. p. 231; *fig.* 721. in p. 971.)
36. *R. setosum* *Falla*. (*Bot. Reg.*, t. 1237; and *fig.* 716. in p. 969.)
syn. Missouri Gooseberry *Lodd.*
37. *R. Grossularia* *Lodd.* (*Lin. Spec.*, 291.)
38. *R. divaricatum* *Douglas*. (*Bot. Reg.*, t. 1359; and *fig.* 720. in p. 971.)
39. *R. triflorum* *Mackie*. (*Willd. Enum.*, 1. p. 51; and our *fig.* 717. in p. 969.)
syn. stamineum of some French collections.
40. *R. Uva crista* *Mackie*. (*Lin. Spec.*, 291.)
syn. *Diacantha* *Loddiges*.

♂ v. **ECHINATA** (or those with numerous bristle-like Spines, and Flowers in bunches).

Leaves small and shining. *Flowers* in small bunches, and of a dull brown colour. *Spines* small and numerous, and like small bristles clothing the young shoots.

41. *R. echinatum* Douglas.

syn. *armatum*.

Habit trailing. (See p. 976.)

42. *R. Cynobati* Whitley. (*Lin. Spec.*, 292; and our fig. 719. in p. 970.)

43. *R. aciculare*. Ledebour. (*Smith in Rees's Cycl.*)

44. *R. lacustre* Pursh. (*Poir. Encyc. Suppl.*, 2. p. 856; and our fig. 724. in p. 976)

syn. *oxycanthoides* Michx. (*Fl. Bor. Amer.*,

I. p. 111; and our fig. 715. in p. 969.)

hirtellum in the French collections. *grossularioides* Biggs.

CHAP. LVI.

OF THE HARDY OR HALF-HARDY LIGNEOUS PLANTS OF THE ORDER ESCALLONIA^A CÆE.

THERE is only one perfectly hardy genus belonging to this order; viz. *Itea*; and the principal genus, which is half-hardy, is *Escallonia*. Both are highly ornamental shrubs; the former indigenous to North America, and the latter to Chili, and other parts of South America.

GENUS I.



*I*TEA L. THE ITEA. *Lin. Syst.* Pentandria Monogynia.

Identification. *Lin. Sp.*, 275; *Dec. Prod.*, 4. p. 6; *Don's Mill.*, 3. p. 396.

Synonymes. *Cedrèla* Lour.; *Diconangia* Michx.

Derivation. *Itea* is the Greek name of the willow, which is given to this genus on account of the quick growth of the *Itea virginica*.

Gen. Char. *Calyx* bell-shaped, with 5 teeth, persistent. *Petals* 5, their æstivation valvate. *Stamens* 5, shorter than the petals. Both petals and stamens inserted upon the tube of the calyx. Teeth of calyx, petals, and stamens, alternate with one another. *Ovary* not connate with the calyx. *Style*, at first, seemingly one; afterwards it parts into two portions: hence, there are rather 2 styles connate. *Stigmas* capitate, mostly divided by a furrow. *Carpels* two, connate into a capsule of 2 cells, that has 2 furrows, and parts from bottom to top. *Seeds* in two rows along the introflexed margins of the carpels. (*Dec. Prod.*, iv. p. 6.)—A shrub, with simple alternate leaves, and flowers in racemes.

♣ 1. *I. VIRGINICA* L. The Virginian Itea.

Identification. *Lin. Sp.*, 289; *N. Du Ham.*, 6; *Dec. Prod.*, 4. p. 6; *Don's Mill.*, 3. p. 196.

Engravings. *Lam. Ill.*, I. t. 147; *N. Du Ham.* 6. t. 9; *Bot. Mag.* t. 24/9; and our fig. 745.

Spec. Char., &c. *Leaves* lanceolate, acutely toothed.

Racemes simple, terminal. (*Don's Mill.*, iii. p. 196.)

A deciduous shrub, growing to the height of 6 ft. or 7 ft. A native of North America, from Pennsylvania to Carolina; introduced in 1744; and producing its white flowers, in terminal racemes, from June to August. It may be propagated by cuttings, but more readily by layers, suckers, or seeds; and it thrives best in a sandy or peaty soil, kept moist.

The plant, to be kept in vigour, should have the old wood frequently cut down to the ground. When grown in a situation that is rather moist, its flowers

make a fine appearance, at a season when there are few other shrubs in blossom. It is most frequently propagated by seeds, which are annually received from America. The price of plants, in the London nurseries, is



Is. each, and of seeds, 6d. a packet; at Bollwyller, plants are 2 francs each; and at New York, 25 cents.

GENUS II.



ESCALLO^NIA Mutis. THE ESCALLONIA. *Lin. Syst.* Pentándria
Monogýnia.

Identification. Mutis in *Lin. fil. Supp.*, t. 21.; *Dec. Prod.*, 4. p. 2.; *Don's Mill.*, 8. p. 192.

Synonyme. *Stereóxylon Ruiz et Pav. Fl. Per. Prod.*, p. 38.

Derivation. From *Escallon*, the pupil and companion of Mutis, during his travels in New Spain.

Gen. Char., &c. Tube of the *calyx* semiglobose, adnate to the ovarium; limb 5-toothed or 5-lobed. *Petals* 5, arising from the calyx. *Stamens* 5; anthers ovate-oblong. *Stigma* peltate. *Style* filiform, permanent. *Capsule* baccate. *Seeds* numerous. (*Don's Mill.*, iii. p. 192.)—Subevergreen half-hardy shrubs, natives of South America, and more especially of Chili, with the leaves full of resinous glands. Propagated with the greatest ease by cuttings; and growing freely in common garden soil.

* *E. rubra* Pers. (*Hook. Bot. Mag.*, t. 2890., and our *fig. 746.*), *Stereóxylon rubrum Ruiz et Pav.*, is a smoothish evergreen shrub, with numerous, twiggy, rounded branches, which, when young, are clothed with glandular hairs. The leaves are obovate-oblong, acuminate, serrated, and, in their native country, full of resinous dots beneath. A tuft of young leaves springs from the axil of each of the older ones, indicative of numerous branches. The peduncles are 2—7-flowered. Lobes of the calyx denticulated. Petals spathulate, red, conniving, but spreading a little at the apex. A native of Chili, on the mountains of Colocolo, in the fissures of rocks, and about Valparaiso. It was introduced in 1827. When trained against a wall, it grows to the height of 6 ft. or 8 ft.; flowering from July to September. It is readily propagated by cuttings, planted in sandy soil, under a hand-glass; and the plants, when placed against a wall, require no protection whatever during winter. In the *Bot. Misc.*, iii. p. 252., three forms of this species are recorded:—

E. r. 1 glabriuscula Hook. et Arn., with glandular branches, leaves highly pubescent, and red flowers, which may be considered as the species.

E. r. 2 albiflora Hook. et Arn.; *E. glandulosa Bot. Cab.*, t. 291.; with white flowers.

E. r. 3 pubescens Hook. et Arn., with pubescent branches, and red flowers.

There are plants of these varieties at Kew, the Horticultural Society's Garden, Messrs. Loddiges's, in the Goldworth Arboretum, and in the Addlestone Nursery, which have stood out as bushes in the open garden, for several years, without the slightest protection during winter.

* *E. montevidénsis* Dec. Prod., iv. p. 4.; *E. floribunda* var. β *montevidénsis* Schlecht.; *E. bifida Link et Otto Abbild.*, t. 23., *Bot. Reg.*, t. 1467.; and our *fig. 747.*; is a smooth shrub, with white flowers, very like those of the hawthorn, which are produced in great abundance from July to September. It is a native of Brazil, on sandy banks and pastures; and was introduced in 1827. It forms a remarkably vigorous-growing bush, with long, flexible, rope-like shoots, and is very prolific in flowers. It is so hardy as to have stood through several winters, as a bush, in the open ground of the Kensington Nursery; so that we might almost have been justified in placing it among the hardy shrubs.



■ *E. floribunda* H. B. et Kunth is a native of New Granada, on the Andes, with white flowers, and shining leaves, which are clammy when young. The plant of this name, in the British gardens, appears to be only a variety of the preceding species.

■ *E. resinosa* Pers., *Stereóxylon resinósum Ruiz et Pav.*, is a glabrous shrub, a native of Peru, on the cold parts of hills. A plant of this species has stood against a south wall, in the Kew Gardens, since 1832.

■ *E. pulverulenta* Pers., *Stereóxylon pulveruléntum Ruiz et Pav.*, is a shrub, hairy in every part, with white flowers; growing to the height of 8 ft. or 10 ft. It is a native of Chili; and plants of it have been in the Horticultural Society's Garden since 1831.

Twenty other species are described in Don's *Miller.*, iii. p. 193. to p. 195., all natives of South America, and probably as hardy as those above mentioned; but it does not appear that any of them have been introduced.

CHAP. LVII.

OF THE HARDY AND HALF-HARDY LIGNEOUS PLANTS OF THE ORDER SAXIFRAGÆÆ, TRIBE HYDRANGEÆ.

THE only woody plants contained in this order are included in the tribe Hydrangeæ, which contains the well-known green-house, or rather cold-frame, plant, *Hydrangea Horténsia*, that may be considered as half-hardy; and some species, natives of North America, which are quite hardy. There are also some half-hardy species, natives of Asia. They are all easily propagated by cuttings, and will grow freely in any soil that is rather moist.

GENUS I.



HYDRANGEA L. THE HYDRANGEA. *Lin. Syst.* Decándria Di-Trigýnia.

Identification. *Lin. Gen.*, 557.; *Dec. Prod.*, 4. p. 13.; *Don's Mill.*, 3. p. 232.

Synonyms. Hydrangea, and Horténsia Juss.

Derivation. From *hudor*, water, and *aggos*, a vessel; with reference to some of the species which grow in water; or, as some suppose, from the capsule resembling a cup.

Gen. Char. *Flowers* generally deformed; but some of them hermaphrodite and fertile. Tube of *calyx* hemispherical, 10-ribbed, rather truncate, adnate to the ovarium; limb permanent, 5-toothed. *Petals* 5, regular. *Stamens* 10. *Styles* 2, distinct. *Capsule* 2-celled, with introflexed valves, crowned by the teeth of the calyx and styles, flattish at the top, opening by a hole between the styles. *Seeds* numerous, reticulated. (*Don's Mill.*, iii. p. 232.)—Shrubs, with opposite leaves. Flowers corymbose, pink, or yellowish white; the marginal ones sterile, and large, in consequence of the teeth of the calyx being dilated into broad, petal-like-coloured segments; the rest of the sterile flower having the other parts partially abortive.

A. *Species Natives of North America.*

■ 1. H. ARBORESCENS L. The arborescent Hydrangea.

Identification. *Lin. Sp.*, p. 568.; *Don's Mill.*, 3. p. 232.; *Lodd. Cat.*, ed. 1836.

Engraving. *Our fig.* 748.

Spec. Char., &c. Leaves ovate, rather cordate; superior ones lanceolate, coarsely toothed, pale and puberulous beneath. Corymbs flattish. Flowers

nearly all fertile. Flower buds obtuse. Flowers white, small, having an agreeable odour. (*Don's Mill.*, iii. p. 232.) This species is found wild from Pennsylvania to Virginia, where it forms a shrub, growing from 4 ft. to 6 ft. high. It was introduced in 1736, and produces its flowers in July and August. It prefers a moist soil, and is readily propagated by division of the root. Plants, in the London nurseries, are 1s. 6d. each; at Bollwyller, 80 cents; and in New York, 27 cents.



748

Varieties.

- ☞ *H. a. 1 vulgaris* Ser. in Dec. Prod., iv. p. 14.; *H. vulgaris Michx. Fl. Bor. Amer.*, i. p. 268., and probably of Pursh; *H. arborescens Curt. Bot. Mag.*, t. 437., *Lam. Ill.*, t. 370. f. 1., *Schkuhr Handb.*, t. 119., *Mill. Icon.*, p. 251.; *H. frutescens Muench Meth.*, i. p. 106., *Du Ham. Arb.*, i. t. 118.—The nerves of the leaves puberulous.
- ☞ *H. a. 2 discolor* Ser., l. c.—Leaves almost white beneath from tomentum.

☞ 2. *H. (A.) cordata Pursh.* The cordate-leaved Hydrangea.

Identification. Pursh *Fl. Amer. Sept.*, 1. p. 309., exclusive of the synonyme of Michx.; *Don's Mill.* 3. p. 232.

Engravings. Wats. *Dendr. Brit.*, t. 42.; and our fig. 749.

Spec. Char., &c. Leaves broadly ovate, acuminate, rather cordate at the base, coarsely toothed, glabrous beneath. Flowers all fertile. Flowers small, white, sweet-scented. (*Don's Mill.*, iii. p. 232.) We agree with Torrey, in thinking this merely a variety of *H. arborescens*. It is a native of Carolina, on the mountains, and on the banks of the Missouri, above St. Louis; where it forms a shrub, growing from 6 ft. to 8 ft. high. It was introduced in 1806, and flowers in July and August. *H. georgica* Lodd. *Cat.*, ed. 1836, only differs from it in flowering a little later, and in being rather more robust.



749

☞ 3. *H. nivea Michx.* The snowy-leaved Hydrangea.

Identification. Michx. *Fl. Bor. Amer.*, 1. p. 268.; *Don's Mill.*, 3. p. 232.

Synonymes. *H. radiata Wal. Fl. Car.*, 251., ex *Michx.*, but not of Smith.

Engravings. Wats. *Dendr. Brit.*, t. 43.; *Lam. Ill.*, t. 307. f. 2.; and our fig. 750.

Spec. Char., &c. Leaves cordate, oval, acuminate, sharply toothed, clothed with white tomentum, or pubescence, beneath. Corymbs flattish. Sepals of sterile flowers entire. Flower buds depressed. Flowers white, rather large. (*Don's Mill.*, iii. p. 232.) It is found wild near the Savannah river, where it forms a shrub, growing from 4 ft. to 6 ft. high. It was introduced in 1786, and flowers in July and August. Its propagation and culture are the same as those of the preceding species.



750

Variety.

- ☞ *H. n. 2 glabella* Ser. in Dec. Prod., 4. p. 14.—Leaves nearly glabrous beneath. Flowers all fertile. This variety has, probably, originated in culture.

☞ 4. *H. quercifolia Bartram.* The Oak-leaved Hydrangea.

Identification. Bartram *Trav.*, ed. Germ., p. 336. t. 7., ex Willd. *Sp.*, 2. t. 634.; *Don's Mill.*, 3. p. 233.

Synonyme. *H. radiata Smith Icon. Pict.*, 12., but not of Walt.

Engravings. Bot. Mag., t. 975.; and our fig. 751.

Spec. Char., &c. Leaves large, ovate, serrately lobed, and toothed, pilose beneath. Corymbs rather panicled, flattish. Sepals of sterile flowers entire. Flower buds depressed. Flowers white. Sterile, or outer, ones of the

corymbs large. (*Don's Mill.*, iii. p. 233.) A native of Florida, growing from 4 ft. to 6 ft. high. It was introduced in 1803, and flowers from June to September. This is by far the most interesting of the North American hydrangeas, from its large, deeply lobed, and sinuated leaves; and its fine, large, nearly white corymbs of flowers, which are sterile, and appear from June till they are destroyed by frost. Culture as in the preceding species; but it is essential that the situation be sheltered, and the soil kept somewhat moist, otherwise the leaves are not perfectly developed, and the branches are apt to be broken off by high winds. Price of plants in the London nurseries, 2s. 6d. each.

751



B. *Species Natives of Asia.*

5. *H. HETEROMALLA* D. Don. The diverse-haired-leaved Hydrangea.

Identification. D. Don *Prod. Fl. Nep.*, p. 211.; *Don's Mill.*, 3. p. 233.

Spec. Char., &c. Leaves oval, acuminate, sharply serrated, tomentose beneath, 5 in. long, and nearly 3 in. broad. Corymbs supra-decompound, diffuse, pilose. Sepals of sterile flowers roundish-oval, quite entire. Flowers white. (*Don's Mill.*, iii. p. 233.) A native of Nepal, at Gosainthan; where it forms a shrub, growing from 4 ft. to 6 ft. high. Introduced in 1821.

App. i. *Half-hardy Species of Hydrangea.*

5. *H. Horténsia* Sieb., *H. horténsia* Smith, *Horténsia opuloides* Lam., *H. speciosa* Pers., *Primula mutabilis* Lour., *Fiburnum serratum* and *F. tomentosum* Thunb., the Chinese Guelder Rose (*Bot. Mag.*, t. 438.; and our fig. 752. is well known by its ample corymbs of snow-ball-like flowers, which are of a whitish green when they first appear, but which afterwards become of a fine rose-colour, and finally die off with a purplish tinge. It is called *Temerihona* (that is, the globe flower) by the Japanese, and *Fun-Dan-Kwa* by the Chinese. In Europe, it was named, by the celebrated Commerson, in honour of Madame Hortense Lapeaute, the wife of his most particular friend M. Lapeaute, a watchmaker. Commerson first named it *Lapeautéia*; but, in order that the compliment paid to Madame Lapeaute might be the more direct, he changed the name to that of *Horténsia*, from her Christian name, Hortense. The plant was afterwards discovered to be a species of *Hydrangea*, a genus previously established by Gronovius; but the name of *Horténsia* was retained as its specific appellation; and it is still the common name by which the plant is known in French gardens. In Britain, it is so hardy, that, in the neighbourhood of London, and in all mild situations not far distant from, and not much above the level of, the sea, it will stand as a bush in the open ground, dying down to the roots in severe winters, but springing up again with great luxuriance the following year; and, if the soil be rich, and kept moist, flowering freely during great part of the summer.

The hydrangea is said, in the *Nouveau Du Hamel*, to have been cultivated in the Isle of France, in 1789 or before; and it was brought to the Kew Garden, from China, in 1790, by Sir Joseph Banks. It soon became popular throughout England, and eminently so about Paris.

The *Culture of this kind of Hydrangea* is remarkably easy; and the plant is particularly suitable for persons who have little else to do than attend to their garden, or their green-house; because it cannot receive too much water, and droops immediately if water has been withheld; reviving rapidly, when apparently almost dead, very soon after water has been given to it. Cuttings may be put in at any season; and, if this be done when the plant is in a growing state, they will root in a fortnight; and, if transplanted into rich moist soil, they will flower in a month. Few shrubby plants make a more magnificent appearance on a lawn; particularly when planted in peat or boggy soil, in a moist situation, partially shaded. To keep the plant in a vigorous state, none of the wood should ever be more than three years old; and there should, therefore, be a succession of two years' old shoots kept up, to supply the place of those which are cut out annually.

Blue Hydrangeas. A remarkable circumstance in the culture of the hydrangea is, that, when it is placed in certain soils, the flowers, instead of being of the usual pink colour, become of a fine blue. This we have already noticed (p. 216.) as affording an example of what De Candolle calls a variation in plants, as contradistinguished from a variety; the latter being capable of being continued by propagation, but not the former. Various conjectures have been made as to the cause of this blue colour. The most general seem to be, that it is owing either to the presence of alum, or that of oxide of iron; but, nevertheless, watering the plant with alum, or chalybeate water, will not produce it in every soil, though it appears to do so in some. The flowers are sometimes blue in

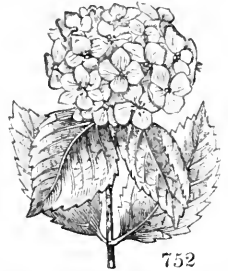

752

plants growing in loamy soil, and sometimes in those growing in peaty or boggy soil. In order to produce this colour, some have recommended steeping sheep's dung in the water given to the plant, and others mixing the soil in which it is grown with peat ashes, wood ashes, oxide of iron, nitre, alkali, or a little common salt. Neither science nor experience has hitherto, however, been able to determine positively the cause of this change of colour; and, of course, nothing but experiment in every particular case will decide what soil will produce it. About London, the most effectual are the loams of Hampstead and Stanmore Heaths, and the peat of Wimbledon Common. About Edinburgh, the soil found in the surrounding bogs; and about Berlin and Petersburg, also, bog earth has been found to produce this colour in the hydrangea.

Statistics. There are various instances of large hydrangeas growing in the open air recorded in the *Gardener's Magazine*. One at Sydenham, in Devonshire, has had 1000 heads of flowers expanded on it at one time. One at Redruth, in Cornwall, is described as being as big as a large haycock. In Pembrokeshire, at Amroth Castle, a plant, 33 ft. in circumference, and 6 ft. high, has had 832 heads of flowers expanded on it at once. In Sussex, at Ashburnham Place, a plant, 30 ft. in circumference, and 5 ft. high, produced 1072 heads of flowers in one season. In Scotland, in Argyllshire, at Lochiel House, a large plant furnished from 600 to 700 flowers, all fully expanded at the same time. At St. Mary's Isle, in the Stewartry of Kirkcubright, a plant, 32 ft. in circumference, produced 525 heads of flowers; and one in Fifeshire, at Dysart House, 40 ft. in circumference, and 6 ft. high, produced 605 flowers. Plants, in the London nurseries, are from 6d. to 1s. each; at Bollwyller, 2 francs, and the blue from 3 to 6 francs; at New York, 50 cents.

Several other Species of Hydrangea, natives of Japan and Nepal, are described in Don's *Miller*, iii. p. 233; but none of them, as far as we know, have been introduced. *H. vestita* Wall., a native of the mountains of Nepal, with large white flowers, and leaves downy beneath, would be a desirable introduction; and is, probably, the garden hydrangea of China in a wild state. *H. altissima* Wall., according to Mr. Royle, climbs lofty trees: but this circumstance, in our opinion, ought to separate it from this genus, however much it may resemble it in its flowers.

CHAP. LVIII.

OF THE HARDY AND HALF-HARDY LIGNEOUS PLANTS OF THE ORDER UMBELLA'CEÆ.

THERE are very few plants belonging to this order that are truly ligneous, and of these the only hardy species which it contains are comprised in the genus *Bupleurum*.

GENUS I.



BUPLEU'RUM Tourn. THE BUPLEURUM, or HARE'S EAR. *Lin. Syst.* Pentándria Digýnia.

Identification. Tourn. Inst., 309. t. 163.; *Lin. Gen.*, 328.; *Dec. Prod.*, 4. p. 127.; Don's *Mill.*, 3. p. 296.

Synonymes. *Tendria* and *Buprëstis Spreng. Syst.*, 1. p. 880.; *Bupliore*, or *Oreille de Lièvre Fr.*; *Hasenöhlein, Ger.*

Derivation. From *bous*, an ox, and *pleuron*, a side; from the supposed quality of swelling cattle that feed on some of the species of the genus. The name of Hare's Ear, which is preserved in the French and German, has reference to the shape of the leaves.

Gen. Char. Margin of the *calyx* obsolete. *Petals* roundish, entire, strictly involute, with a broad retuse point. *Fruit* compressed from the sides. *Seed* teretely convex, flattish in front. (*Don's Mill.*, iii. p. 296.)—Smooth shrubs, evergreen, or subevergreen. Natives of Europe and Africa, and some of Asia; but none of them growing higher than 5 ft. or 6 ft. Only one hardy species is in cultivation in British gardens.

■ 1. *B. FRUTICO'SUM L.* The shrubby *Bupleurum*, or *Hare's Ear*.

Identification. *Lin. Sp.*, 343.; Don's *Mill.*, 3. p. 301.; *Lodd. Cat.*, ed. 1836

Synonymes. *Tendria fruticosa Spreng. in Schultes Syst.*, 6. p. 376.; *Buprëstis fruticosa Spreng.*

Mag.; *Séseli athiopicum Bauh. Pin.*, 161.; *Séseli frutex Mor. Umb.*, 16.

Engravings. *Sibth. Fl. Græc.*, t. 263.; *Wats. Dendr. Brit.*, t. 14.; *Du Ham. Arb.*, 1. t. 43.; *Jaune Pl. Tr.*, 1. t. 65.; *Mill. Icon.*, t. 74.; and our *fig.* 753.

Spec. Char., &c. Shrubby, erect, branched. Leaves oblong, attenuated at the base, coriaceous, 1-nerved, quite entire, sessile. Leaves of involucre

oblong. Ribs of fruit elevated, acute. Vittæ broad. Bark of branches purplish. Leaves of a sea-green colour. (*Don's Mill.*, iii. p. 301.) A native of Portugal, Spain, the south of France, about Nice, Corsica, Sicily, Mauritania, and Thesaly. It is a shrub, growing 3 ft. or 4 ft. high in a wild state, and sometimes to the height of 6 ft. in British gardens. Introduced in 1596, and flowering in July and August. It is readily propagated by cuttings, and is of free growth in any dry calcareous soil. The blue glaucous hue of its smooth shining foliage renders it a desirable addition to every collection. If planted in an open airy situation, in a deep soil, not moist, and allowed to extend itself on every side, it would soon form a large hemispherical bush, highly ornamental during winter from its evergreen foliage, and during July and August from its bright yellow flowers. Plants, in the London nurseries, are 1s. 6d. each.



753

App. i. *Half-hardy Species of the Genus Bupleurum.*

■ *B. gibraltárica* Lam., *B. coriáceum* L'Hérit., *B. obliquum* Vahl, *B. arboréscens* Jacq., *Tenoria coriácea* Spreng, *B. verticále* Ort., is a smooth evergreen shrub, with coriaceous glaucous leaves, fragrant when bruised. It is a native of Gibraltar, on rocks; was introduced in 1784, and grows to the height of 3 ft., flowering from June to August. It is nearly as hardy as the common species.

■ *B. plantagíncum* Desf., *Tenoria plantagínea* Spreng., is a native of Mount Atlas, with mucronate, stiff, coriaceous, sessile leaves. It was introduced in 1810, and grows to the height of 2 ft. or 3 ft., flowering in August.

■ *B. canéscens* Schoub. is a native of Mogador, with oblong membranous leaves. It was introduced in 1809, and grows to the height of 2 ft. or 3 ft., flowering in August or September.

■ *B. fruticéscens* L. is a native of Spain and the north of Africa; but, it is hardly worth cultivation as a shrub. It was introduced into British gardens in 1752, but is rarely to be met with.

CHAP. LIX.

OF THE HARDY AND HALF-HARDY LIGNEOUS PLANTS OF THE ORDER ARALIA'CEÆ.

THE genera belonging to this order, which contain ligneous plants, are *Aràlia* and *Hédera*; and their characteristics will be found stated shortly below.

ARALIA L. Margin of the calyx very short, entire, or toothed. Petals 5, free, and expanded at the apex. Stamens 5. Styles 5, expanded, spreading divaricately. Berry 5-celled, usually torose. (*Don's Mill.*, iii. p. 388., adapted.) — The only species not herbaceous is a fruticose deciduous-leaved plant, assuming the character of a tree.

HÉDERA Swartz. Margin of the calyx elevated or toothed. Petals 5—10, not cohering at the apex. Stamens 5—10. Styles 5—10, conniving, or joined in one. Berry 5—10-celled. (*Don's Mill.*, iii. p. 391.) — The only hardy species is a climbing evergreen shrub.

GENUS I.



ARALIA L. THE ARALIA, or ANGELICA TREE. *Lin. Syst.* Pentándria Pentagýnia.

Identification. D, Don Prod. Fl. Nep., p. 185., in a note; Dec. Prod., 4. p. 257.; Don's Mill., 3. p. 388.
Synonyms. *Aràlia* sp. *Lin.*; *Aràliæ vèræ Blum.*

Derivation. According to some, from *ara*, annoyance, the spines being very troublesome, in its native country, to travellers; but, according to others, a name of unknown meaning, under which one species was sent to Fagon, at Paris, from Quebec, in 1764, by one Sarrazin, a French physician.

Description. A shrub, with a single stem, having the habit of a tree; and bearing large compositely divided leaves, peculiar in character among shrubs, and very interesting.

♣ 1. *A. SPINOSA* L. The spiny Aralia, or *Angelica Tree*.

Identification. Lin. Sp., p. 392.; Don's Mill., 3. p. 389.; Lodd. Cat., ed. 1836.

Synonyms. Aralie, Fr. and Ger.; Spikenard, N. Amer.

Engravings. Schmidt Arb., t. 102. and t. 103.; Wats. Dend. Brit., t. 116.; and our fig. 754.

Spec. Char., &c. Stem arboreous and prickly. Leaves doubly and trebly pinnate. Leaflets ovate, acuminate, and deeply serrated. Panicle much branched, beset with velvety stellate down. Umbels numerous. Involucre small, of few leaves. Petals white and reflexed. Styles 5, divaricate, arched. Fruit 5-ribbed. (*Don's Mill.*, iii. p. 389.) A tree, growing to the height of 10 ft. or 12 ft., with a single erect stem; a native of Carolina and Virginia, in low, fertile, moist woods.

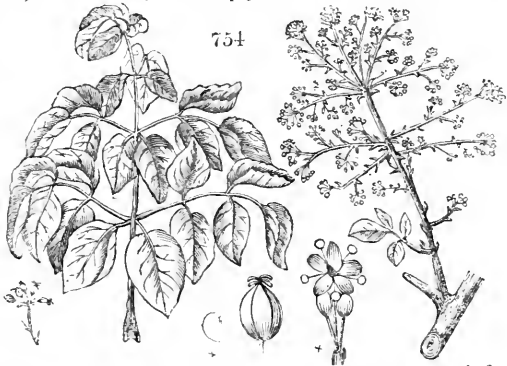

Introduced in 1688; and flowering in August and September. An infusion of the fruit, in wine or spirits, is considered an effectual cure for the rheumatism. In British gardens, this species is propagated by cuttings of the roots; and, from its large doubly and trebly pinnate leaves, it forms a singularly ornamental plant, with a spreading, umbrella-like head, when standing singly on a lawn. After the plant flowers, the stem commonly dies down to the ground, like that of the raspberry, and like it, is succeeded by suckers. Pursh "mentions a variety in which the petioles of the leaves are without prickles." It is found in South Carolina, near Charleston.

There are some other suffruticose species of Aralia, hardy or half-hardy, natives of North or South America, such as *A. hispida*, Bot. Cab. t. 1306., which are barely shrubby; and some shrubby species, natives of Japan, Cochinchina, or New Zealand, which are not yet sufficiently known, and have not been introduced.

GENUS II.

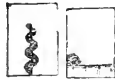

HE'DERA Swartz. THE IVY. Lin. Syst. Pent-Decándria, and Pent-Decagýnia.

Identification. Swartz Fl. Ind. Occ., p. 581.; D. Don Prod. Nep., p. 186.; Dec. Prod., 4. p. 261.; Don's Mill., 3. p. 391.

Synonyms. Aralia, sect. Gymnopterum Blum. Bijdr., p. 871.; Hédera, and Aralia sp. Lin.; Lierre, Fr.; Ephen, Ger.

Derivation. Various etymologies have been proposed for the word *Hédera*; but the most probable supposition appears to be, that it is derived from the Celtic word *hedira*, a cord. The English word Ivy is derived from the Celtic word, *iw*, green.

Description. The hardy sorts are evergreen shrubs, climbing by the clasping roots produced by their stems; but there are a number of species considered at present to be of this genus, natives of warm climates, growing to the height of from 15 ft. to 20 ft. without support.

Æ 1. *H. HÆLIX L.* The common Ivy.

Identification Lin. Sp., 292; Dec. Prod., 4. p. 261.; Don's Mill., 3. p. 391.; Baxter's Brit. Fl. Pl., p. 32.; Lodd. Cat., ed. 1836.

Derivation. *Hælix* is derived from *cilæo*, to encompass, or turn round; in reference to the clasping stems, which, however, are not twining.

Spec. Char., &c. Stems climbing, throwing out roots from their sides to any object next which they may be placed. Leaves coriaceous, glabrous, shining, with 5 angular lobes; those on the old upright and rectangular branches, which form the tops of the plants, ovate, acute, quite entire. Umbels simple, pubescent. (*Don's Mill.*, iii. p. 391.) A native of Europe.

Varieties. De Candolle has enumerated three forms of this species, which are independent of the varieties cultivated in British gardens:—

- Æ H. H. 1 *vulgâris* Dec. (*Eng. Bot.*, t. 1267.; and our *fig. 755.*) has the pedicels clothed with stellate down, and the fruit black. This is the commonest form of the ivy, throughout Europe, in a wild state; and there are varieties of it with white and yellow variegated leaves, in gardens.

- Æ H. H. 2 *canariensis* Dec.; *H. canariensis* Willd. *Berol. Mag.*, ii. p. 170. t. 5. f. 1.; the Irish Ivy, or Giant Ivy, of British gardens; has the pedicels scaly with pubescence. Floral leaves subcordate; those of the creeping branches 5-lobed and larger than those of the common ivy. Fruit ? red, or black. A native of the Canary Islands; but the year of its introduction into Britain is uncertain.



755

- Æ H. H. 3 *chrysocârpa* Dec., *H. poëtica* C. Bauh., *H. chrysocârpos* Dalech., *H. Dionýsias* J. Bauh., *H. Hælix* Wall., is a native of the north of India, with yellow fruit. It differs from the common ivy in its yellow fruit, and in being of more gigantic growth; in the leaves being more cuneated at the base; and in the pedicels being scaly. There is a plant in the Horticultural Society's Garden.

The varieties in British gardens, additional to the above, are:—

- Æ H. H. 4 *foliis argenteis* Lodd. Cat. *The Silver-striped Ivy.*
 Æ H. H. 5 *foliis aureis* Lodd. Cat. *The Golden-striped Ivy.*
 Æ H. H. 6 *digitata* Lodd. Cat. *The palmate, or hand-shaped, Ivy*
 Æ H. H. 7 *arborescens* Lodd. Cat. *The arborescent, or Tree, Ivy.*—This variation is merely an extension of the flowering shoots, which are entire-leaved, and take an arborescent character; and, when a portion of them is cut off, and has rooted as a separate plant, it will sometimes produce an upright bush, which will retain its arborescent form for many years. Sooner or later, however, it resumes its native habit, and throws out rambling, or creeping, shoots, with 5-lobed leaves, like the common ivy.

Description. The common ivy is a rooting climber: but, when these roots are opposed by a hard substance which they cannot penetrate, they dilate, and attach themselves to it, by close pressure on the rough particles of its surface. The dilatation of the fibril is sometimes so considerable as to form a disk above a quarter of an inch in diameter; and this dilatation is greater or less, in proportion to the roughness or smoothness of the surface which it presses against: because, when the surface is nearly smooth, the projecting points, to which alone the disk of the fibril can attach itself, must necessarily be small, and not such as to afford a firm hold; and hence a greater number of them are required to be included under each disk, to sustain the weight of the plant. On very smooth surfaces, such as that of a house or a wall that has

been stuccoed, or smoothly plastered, no dilatation of the fibril is sufficient to cause the ivy to adhere; and hence, in such situations, it always falls down, either when rendered somewhat heavier by rain or snow, or when acted on by wind. Against such walls, therefore, trelliswork ought to be fixed; or the main shoots of the ivy may be nailed, like those of any other wall tree. To common brick or stonework, or the rough bark of trees, the fibrils adhere readily. In the crevices of rocks, and on the surface of the ground, they become roots; but it is only when this is the case that they can afford any nourishment to the plant; a fact easily proved, by cutting through the stem of a plant of ivy at the foot of a wall or a tree, to which it may be attached; when, it will be found, the ivy speedily dies. When ivy trails on the ground, it roots into it, and grows vigorously, but rarely flowers; and in this state it has acquired the name of the barren, or creeping, ivy. When it climbs up trees, or is in any situation where it is much shaded, it seldom, if ever, flowers, until it has grown so high as to be subject to the direct influence of the sun. Hence, on branchy-headed trees, it is seldom seen in a flowering state, until it has reached their uppermost branches, and partially destroyed them. Ivy flowers soonest when grown against a wall, and fully exposed to the light. Whatever support it may have, when it has reached the summit the branches shorten, and become woody, forming themselves into large, shrubby, bushy heads; and the leaves become entire, taking more of an oval shape, and no longer being lobed like the lower ones. In this state, the plant will flower freely, and will continue growing like a shrub for many years, producing no leaves but such as are nearly oval, and showing no inclination to creep, or to throw out roots. Hence, we often see the appearance of an ivy hedge 5 ft. or 6 ft. in height on the top of an old ivied wall. The flowers of the ivy are of a yellowish or greenish white: they appear in the end of September, and continue expanded through the months of October and November: they are odoriferous, and contain a good deal of honey; on which account they are much frequented by bees and other insects, to which they afford a valuable support, as they are in perfection at a time when there are few other flowers. The berries increase in size during the winter, are full formed in February, and ripe in April, furnishing food for wild pigeons, blackbirds, thrushes, &c., in the spring. When the berry is ripe, it is succulent with a purple juice; but afterwards it becomes coriaceous, dry, and shrivels into a somewhat five-angled figure; thus beautifully harmonising with the lower leaves. The common ivy will grow to the tops of trees nearly 100 ft. in height: but it is doubtful whether the Irish ivy will attain the same elevation, though it grows with much greater vigour than the common sort when young. Both varieties continue growing during winter; and, in shady situations, throughout the year. Hence, rooted plants of Irish ivy, placed in good soil, at the base of a wall 10 ft. high, will reach its top in three years; and those of the common ivy in five years; but after it has attained 15 ft. or 20 ft., its growth is comparatively slow, unless it be against the warm walls of a dwelling-house; when it will cover a gable-end, having chimney flues in it, in 5 or 6 years; a circumstance which may be turned to the greatest advantage in towns. The duration of the ivy is very great: judging from some of the plants against ruined castles and abbeys, we should suppose them to be two or three centuries old. The stems sometimes are found, in such situations, 10 in. or 12 in. in diameter at 1 ft. from the ground. The seeds of ivy resemble swollen grains of wheat, and, as they pass through birds of the thrush family unaltered in shape, they are frequently found scattered on the ground. Ray, in his *Catalogus Plantarum rariorum Angliæ et Insularum adjacentium*, says that hence have arisen the stories of wheat having been rained down. The chewed seeds have an acrimonious taste. The golden-leaved variety, when it thrives, is a splendid plant, appearing in spring, after it has made its new leaves, like an immense mass of yellow flowers. There is a plant of this variety on the back of one of the hot-houses in the Hammer-smith Nursery, which has reached the top of the wall, and covered a stack of

chimneys some feet higher, forming a striking object in May and June from the public road. On a ruin, or on a dark pine tree, this variety, mixed with the common sort, would have a fine effect, by the brilliant contrast which it would produce.

Geography. The ivy is a native of Europe, from the south of Sweden to the Mediterranean Sea, and from Ireland to Siberia; but only in woods, and under the shelter of trees and bushes, in either the colder or the hotter districts of this extensive region. It is found in the north of Africa, the west of Asia, the mountainous regions of India, and also in Japan and China, but not in North or South America, or in Australia. The variety with yellow berries, Royle informs us, "is the most common in the Himalayas, and may be seen clinging to the rock, and clasping the oak; affording, from its pleasing associations, glad recognition to the European traveller." (*Illustr.*, p. 233.) In Britain, the ivy is always found growing in a substantial soil, where it can be amply supplied with nourishment, and where its roots can penetrate to such a depth as to be able to obtain abundant moisture for the leaves, when the plant has attained its greatest height, and is in a flowering state.

History. The ivy was well known to the Greeks and Romans, and there are many mythological and traditional allusions to it in the writings of Greek and Roman authors. Its Greek names were *Kissos* and *Kittos*, from *Kissos*, or *Cissus*, the name of a boy whom *Bacchus* is said to have changed into it. By the Romans it was called *Hedera*; which name has been adopted by modern botanists. In old French its name is *Hierre*. It is mentioned by Gerard, as growing in a wild state, and on the sides of houses; but it was probably not propagated as a garden plant till some time afterwards, when towns extended into the country, and it became a mark of refinement to create allusions to the latter in the former, by planting such evergreens as would withstand the close air and smoke of cities. The plant is now in general demand throughout all those parts of Europe where it will grow freely against a wall; but more than any where in the neighbourhood of London. In North America, in the time of Kalm, he found only one plant, which was trained against a house, during the whole of his travels in that country; but the principal varieties are now propagated in all the American nurseries.

Properties and Uses. The whole plant is aromatic; and a very fragrant resin exudes from the old stems when bruised, from which is obtained the chemical principle *hederine*. Ivy was formerly included in the British *Materia medica*, as it was in that of the Greeks, and still is in that of India. The berries are emetic and purgative; and the substance called *hederine*, which is now in use in India, is said to be aperient, resolutive, and balsamic. The berries, as already observed, are greedily eaten by several birds. Sheep and deer are fond of the leaves and small branches, which, before the introduction of green crops, afforded a useful resource when the ground was covered with snow. Cato directs that, in a scarcity of hay, or the dried shoots of trees, cattle should be foddered with the green branches of ivy. The wood is soft and porous; and, in Switzerland, and in other parts of the south of Europe, it is used by the turner; and, in thin slices, to filter liquids. The roots are employed by leather-cutters to whet their knives on. Cato and Pliny attribute a singular property to the wood of the ivy; and say that, by its filtrating powers, it can separate wine from water. According to these authors, if a cup of ivy wood be filled with wine that has been adulterated with water, the wine will find its way through the pores of the wood, and the water alone will remain in the cup. In the *Nouveau Du Hamel*, it is mentioned that this experiment was tried by a person worthy of confidence, and that he found the very reverse take place; the water filtering through, and the wine remaining in the cup. It is possible that something of the kind may take place, which may be accounted for on Du Trochet's principles of *Endosmose* and *Exosmose* (see *Gard Mag.*, vol. iii. p. 78.); but it is more probable that the liquor merely exudes through the pores of the wood, without any separa-

tion of its component parts; some of it remaining in the cup when the pores were choked up, and the portion exuded having the appearance of water, from its colouring matter having been absorbed by the wood. The ivy, for trying this experiment, or for using in any way as a filter, must be newly cut, as it loses its filtering properties when quite dry. A decoction of the leaves dyes hair black; and it is said to form a principal ingredient in the compositions sold to prevent hair from turning grey. The leaves of mulberry trees that have had ivy round them are said to destroy the silkworms that feed on them; and the juice of the plant, applied to the nostrils, is supposed to cure headaches. Many other properties were attributed to this plant by the ancients; but, for medicinal purposes, it appears at present to have fallen into disuse. The great use of the ivy, in modern times, is as an ornamental shrub. When the geometrical style of gardening prevailed, it was much employed to train over frames of wire or lattice-work, formed by the wire-worker or joiner into architectural or sculptural shapes; arbours, colonnades, and the figures of men and animals, being much more rapidly produced in this manner, than by the slow growth of the yew or the box. At present, forms of this kind are no longer in use; but a plant of ivy trained to a pole, and allowed to branch out at its summit, forms a very striking object in small gardens. For covering naked walls, rocks, or ruins, or communicating an evergreen rural appearance to any part of a town or suburban garden, no plant whatever equals the ivy; though, in situations subject to the smoke of coal, it is apt to get naked below, and requires to be partially cut down, or to have young plants planted at the root of the old ones, to fill up the naked places, every four or five years. A very singular effect produced by ivy occurs in the approach road to Warwick Castle. The road is cut through a solid bed of sandstone rock; and its sides are, in some places, upwards of 12 ft. high, if we recollect rightly, and quite perpendicular and smooth. Ivy has been planted on the upper surface of the ground, which forms the summit of these perpendicular walls of rock, in order, as it would appear, that it might creep down and cover their face. Instead of creeping, however, the ivy has grown over, without attaching itself; and its long, pendulous, matted shoots, which, in 1831, not only reached the approach road, but actually trailed on it, waving to and fro with the wind, might be compared to an immense sheet of water falling over a perpendicular rock. Over chalk cliffs, ivy sometimes hangs down in perpendicular shoots from the surface; but, from the numerous interstices in the chalk, it is generally able occasionally to attach itself; and hence it appears in varied tufts and festoons, which, in old chalk-pits, as, for example, at Ingress Park, near Greenlithie, have an effect that is at once strikingly beautiful and picturesque. In close shrubberies, in small gardens, or even in large ones, where neither grass nor any other green plant will grow on the surface, the ivy forms a clothing of perpetual verdure. Trained against espaliers, latticework, iron hurdles, or wire frames, it forms, in a very short time, most beautiful evergreen walls, or hedges, for the shelter or separation of flower-gardens. In short, there is no evergreen shrub capable of being applied to so many important uses as the common ivy; and no garden (in a climate where it will stand the open air), whether large or small, can dispense with it. About London, it is raised in immense quantities in pots, and trained to the height of from 6 ft. to 12 ft. on stakes; so that, at any season of the year, a hedge may be formed of it, or a naked space covered with it, at an incredibly short notice. In the streets of London, a house may be built from the foundations in the course of three or four weeks; and, by placing pots of ivy in the balconies of the different windows, the whole front, in one day, may be covered with evergreen leaves as effectually as if it were an old building, in a secluded rural situation. One valuable use to which the ivy may be applied in street houses in towns is, to form external framings to the windows instead of architraves. In the interminable lines of naked windows in the monotonous brick houses built about 50 years ago, which form the majority of the London streets at the west end of the town, the ivy affords a resource which any

householder of taste may turn to a very good account. He has only to form projecting architraves of wire to his windows, and to place a pot of ivy in his window sills, or in a small balcony at the base of each jamb; taking care to fix the pots securely, and to make a provision for supplying them regularly with water. In rooms, the ivy, when planted in boxes, and properly treated, forms a rustic screen, either for excluding the light of the sun during the day, or of a lamp or chandelier at night; and, in very large drawingrooms, plants in boxes or vases, trained on wire parasols or espaliers, such as those recommended for roses (see *figs.* 534. and 535.), will form a rustic canopy for small groups of parties, who may seat themselves under its shade, in the same manner as parties sit under orange trees in the public rooms of Berlin, and of other cities of the Continent. Where the view from the window of a town house is contracted or disagreeable, it may always be improved by plants of ivy, planted in boxes, and trained on espaliers, being placed within the room, at a sufficient distance from the window to prevent them from excluding the light, and yet sufficiently near to serve as a screen; or, by so disposing of plants on the outside as to conceal or disguise the disagreeable objects, and create an allusion to the country. One great advantage of the ivy, in small and suburban gardens, is, that by its berries it attracts the birds in early spring; and by its dense foliage it forms excellent situations for nests. A number of birds build in it, from the blackbird and thrush to the blackcap and the sparrow, and even to the tomtit and wren. This plant is generally considered as highly injurious to trees, where it has climbed up and covered their stems. "The ivy," Gilpin observes, "has a root of his own, and draws nourishment from the ground; but his character is misrepresented, if his little feelers have not other purposes than that of merely showing an attachment to his potent neighbour. Shakspeare roundly asserts that he makes a property of him:—

————— " ' He was
The ivy, which had hid my princely trunk,
And suck'd my verdure out.' "

GILPIN, *For. Scen.*, i. p. 15.

The injurious effect of the ivy on trees has, however, been denied by various persons, and, among others, by Mr. Repton, who, in a paper on the subject in the *Lin. Trans.*, contends that it is useful, by keeping their trunks warm. There can be no doubt but that, under certain circumstances, the warmth produced by a covering of ivy may be favourable to vegetation; and, when its stems ascend the trunk of a tree in parallel lines, without creeping or winding round it, so as to form a kind of network over the bark, it may remain there for a number of years without doing the tree any material injury. After a certain period, however, a network never fails to be formed; and, as the trunk of the tree continues expanding, while this network remains stationary, the tree cannot fail to receive injury by being compressed by the stems of the ivy. Wherever this network is found on the smaller branches at the top of the tree, the tree is certain of being killed in a short time. In this case, as in most others, the opinions of the ancients and of modern foresters, both of which are unfavourable to the ivy, will be found to be correct. We have already mentioned that ivy on the trunks of trees may easily be killed, by cutting through its stems close to the ground; in addition to which, its stems ought to be pulled off, or loosened from the trunk and branches of the tree; but, in deciding on this operation, Evelyn's caution must not be forgotten, "that trees long invested with it should not have it all at once removed, lest they should die from exposure to unaccustomed cold."

A variety of opinions prevail as to the use or injury of ivy on habitable buildings. Where the walls are well built, and do not contain such crevices as to admit of the fibrils becoming roots, and, of course, increasing in size, and tending to rupture the masonry, the ivy must be a protection to the wall from the weather; and to the interior of the house, from the cold of winter and the heat of summer. On ruins it must also be a protection, except in cases where

roots are formed in the wall, or where shoots can find their way through cracks or crevices. In either case, it must tend to fracture, and ultimately to destroy, the wall; but so slowly, that we can hardly conceive a case where more injury than good would not be done by removing the ivy. Even if the parts of the wall were separated from each other by the introduction of the roots or shoots, the parts partially separated, would be held together by the ivy. Our opinion, therefore, is, that, unless the object is to show the architecture of an ivied ruin, its destruction will be accelerated, rather than retarded, by the removal of ivy.

Ivy has been recommended for covering cottages; and not only their walls, but even their roofs. We have no doubt it will protect both, wherever it cannot insinuate its roots or shoots through the wall or roof: but the roof must be steep, otherwise the ivy, when it comes into a flowering, and consequently shrubby, state, must be clipped, in order to present such an imbricated surface of large leaves as shall effectually throw off the rain. In covering cottages with ivy, it must be recollected that it has a tendency, to a certain extent, to encourage insects; but, as very few of these live on the ivy, it is not nearly so injurious in this respect as deciduous-leaved climbers, or other plants or trees trained against a wall. Pliny says that the ivy will break sepulchres of stone, and undermine city walls; but this, as we have already shown, can only be the case where the walls are in a state of incipient decay, and contain crevices sufficient to admit the roots or stems of the plant.

Poetical, mythological, and legendary Allusions. The ivy was dedicated by the ancients to Bacchus, whose statues are generally found crowned with a wreath of its leaves; and, as the favourite plant of the god of wine, its praises have been sung by almost all poets, whether ancient or modern. Many reasons are given for the consecration to Bacchus of this plant. Some poets say that it was because the ivy has the effect of dissipating the fumes of wine; others, because it was once his favourite youth Cissus; and others, because it is said that the ivy, if planted in vineyards, will destroy the vines; and that it was thus doing an acceptable service to that plant to tear it up, and wreath it into chaplets and garlands. The most probable, however, seems to be, that the vine is found at Nyssa, the reputed birthplace of Bacchus, and in no other part of India. It is related that, when Alexander's army, after their conquest of Babylon, arrived at this mountain, and found it covered with laurel and ivy, they were so transported with joy (especially when they recognised the latter plant, which is a native of Thebes), that they tore the ivy up by the roots, and, twining it round their heads, burst forth into hymns to Bacchus, and prayers for their native country.

Not only Bacchus, who, Pliny tells us, was the first who wore a crown, but Silenus, was crowned with ivy; and the golden-berried kind, before the transformation of Daphne into a laurel, was worn by Apollo, and after him by poets. Pope, however, does not seem to allow this; and he gives the plant expressly to critics:—

“ Immortal Vida, on whose honour'd brow
The poet's bays and critic's ivy grow.”

The priests of the Greeks presented a wreath of ivy to newly married persons, as a symbol of the closeness of the tie which ought to bind them together; and Ptolemy Philopater, king of Egypt, ordered all the Jews who had abjured their religion to be branded with an ivy leaf. Numerous allusions to this plant occur in Homer, Virgil, Horace, Ovid, and nearly all the ancient and modern poets; but few have given a more just description of it than Spenser, in the following lines:—

“ Amongst the rest, the clamb'ring yvie grew,
Knitting his wanton arms with grasping hold,
Lest that the poplar happily should rewe
Her brother's strokes, whose boughs she doth enfold
With her lythe twigs, till they the top surweave,
And paint with pallid green her buds of gold.”

The ivy is considered symbolical of friendship, from the closeness of its adherence to the tree on which it has once fixed itself. "Nothing," says St. Pierre, in his *Studies of Nature*, "can separate it from the tree which it has once embraced: it clothes it with its own leaves in that inclement season when its dark boughs are covered with hoarfrost. The faithful companion of its destiny, it falls when the tree is cut down: death itself does not relax its grasp; and it continues to adorn with its verdure the dry trunk that once supported it." The constancy of the ivy has rendered it a favourite device for seals; some of the best of which are, a sprig of ivy, with the motto, "I die where I attach myself;" and a fallen tree, still covered with ivy, with the words, "Even ruin cannot separate us." Ivy is the badge of the clan Gordon.

Soil, Situation, Propagation, &c. We have already observed that the ivy, to attain a large size, requires a good soil; and, also, that it grows naturally in the shade, and in a northern rather than in a southern exposure. Smoke, there can be no doubt, is injurious to the ivy; but still it endures it better than most evergreens, particularly when it is kept moist at the root. Ivy is propagated by cuttings, planted, in autumn, in a sandy soil, and a shady border; but these must be well rooted before they are put out in the situation where they are finally to remain, or disappointment to the planter will ensue. It is very natural to suppose, that, with a plant rooting so readily as the ivy, it would be quite sufficient to put in a cutting where a plant was wanted; but, nevertheless, it is a fact, that, unless the soil be kept in a uniform state of moisture, and shaded, like most other evergreens, it will not root readily. The largest plants of ivy which we have heard of in England are at Brockley Hall, in Somersetshire, attached to old trees: one of these plants has the stem $10\frac{2}{3}$ in., and the other $11\frac{1}{4}$ in. in diameter, at 1 ft. from the ground. In the town of Morpeth, in Northumberland, the front of a cottage is covered with ivy, which proceeds from a single stem, that comes out of a crevice in the rough stone wall by the cottage, at about a foot from the ground. The stem where it comes out is about $\frac{1}{2}$ in. in diameter, but it gradually increases till at the height of 5 ft. it is $6\frac{2}{3}$ in. in diameter; and at the height of 9 ft., at the point from which the branches proceed, it is no less than $19\frac{1}{3}$ in. in diameter! About 40 years ago, this cottage was occupied as a public house, and called the Ivy Tree, so that the plant is, doubtless, above half a century old. A view of the cottage, the ivy plant, and the remarkable weeping ash trees, which stand on a bank overhanging it, has been kindly forwarded to us by M. J. F. Sidney, Esq., of Cowpen. (See the article *Fraxinus*, in a future page.) Plants, in the London nurseries, cost from 6d. to 2s. 6d. each, according to their size; at Bollwyller, from 50 cents to 1½ franc; and at New York, from 37½ cents to 1 dollar each. Plants of the varieties, and especially of the yellow-fruited, are somewhat dearer.

Fifty other species of the ivy are described in Don's *Miller*; but they are chiefly tropical plants, and almost all of them are trees; which, probably, when they come to be farther examined, will be referred to *Aràlia*, or other genera.

CHAP. LX.

OF THE HARDY LIGNEOUS PLANTS OF THE ORDER *HAMAMELIDA'CEÆ.*

THE characteristics of this order, as far as the hardy species in British gardens are concerned, will be found in the following distinctive characters of the only two hardy genera.

HAMAMELIS L. Calyx 4-lobed, furnished with 3—4 scales on the outside. Ovarium ending in 2—3 styles at the apex. Capsule coriaceous, 2-celled; 1-seeded, opening by 2 elastic valves above. Seed oblong, shining, with a

superior hilum. Albumen fleshy. Embryo with a superior radicle, and flat cotyledons. Leaves alternate, ovate, or cuneated, feather-nerved, nearly entire. Flowers nearly sessile, disposed in clusters in the axils of the leaves; girded by a 3-leaved involucre. Petals yellow. (*Don's Mill.*, iii. p. 396., adapted.) — Deciduous shrubs, natives of North America and Asia.

FOTHERGILLA L. Calyx campanulate, 5—7-toothed. Anthers in the form of a horseshoe. Styles 2. Capsule 2-lobed, 2-celled; cells 2-valved at the apex, 1-seeded. Seed bony, pendulous, with a superior hilum. Leaves alternate, obovate, feather-nerved, bistipulate, clothed with soft starry down. Flowers sessile, in terminal ovate spikes, having a solitary bractea under each; those at the base of the spike trifid, and those at its apex nearly entire. Petals white, sweet-scented, sessile. Anthers yellow. (*Don's Mill.*, adapted.) — A low deciduous shrub, a native of North America.

GENUS I.



HAMAMELIS L. THE HAMAMELIS, or WYCH HAZEL. *Lin. Syst.*
Tetrándria Digýnia.

Identification. *Lin. Gen.*, 169.; *Dec. Prod.*, 4. p. 268.; *Don's Mill.*, 3. p. 396.; *Lindl. Nat. Syst.*, p. 333.

Synonymy. *Trilopus Mith. Act. Acad. Nat. Cur.*, 8 *App.*

Derivation. *Hamamélis* is a name by which *Athenæus* speaks of a tree which blossomed at the same time as the apple tree, the word being derived from *hama*, together with, and *mélis*, an apple tree. The modern application seems to be from the *Hamamélis* having its blossoms accompanying its fruits (*méla*); both being on the tree at the same time.

♂ ♀ 1. **H. VIRGINICA** L. THE VIRGINIAN HAMAMELIS, or *Wych Hazel*.

Identification. *Dec. Prod.*, 4. p. 268.; *Don's Mill.*, 3. p. 396.; *Lodd. Cat.*, ed. 1836.

Synonymy. *Hamamelie de Virginie, Fr.*; *Virginische Zaubernuss, Ger.*

Engravings. *Mill. Ill.*, t. 10.; *N. Du Ham.*, 7. t. 60.; *Bot. Cab.*, t. 598.; and our *figs.* 756, 757.

Spec. Char., &c. Leaves obovate, acutely toothed, with a small cordate recess at the base. (*Don's Mill.*, iii. p. 396.) A deciduous shrub, a native of North America, from Canada to Florida; found in dry and stony situations, but frequently also near water, and growing to the height of 20 ft. or 30 ft., with a trunk 6 in. or more in diameter. It was introduced in 1736, and flowers from the beginning of October to the end of February. In British gardens, it has been but little cultivated, notwithstanding the singularity of its appearance in autumn and winter; when it is profusely covered with its fine rich yellow flowers, which begin to expand before the leaves of the previous summer drop off, and continue on the bush throughout the winter. After the petals drop off in spring, the persistent calyxes remain on till the leaves reappear in April or May. The flowers are either polygamous, diœcious, monœcious, or androgynous; and hence the names in some American catalogues, of *H. dioica*, *H. monoica*, and *H. androgyna*. The American Indians esteem this tree for its medical properties: the bark is sedative and discutient; and it is applied by them to painful tumours and external inflammations. They also apply a poultice of the inner rind to remove inflammations of the eyes. In the neighbourhood of London, it is rarely found above 5 ft. or 6 ft. high; but there is a plant of it in the grounds of Ham House upwards of 15 ft. high, growing in deep sandy soil, not far distant from water, of which *fig.* 757. is a portrait taken in November, 1835, to a scale of 1 in. to 12 ft. Owing to its flowering during the winter season, it deserves a place in every collection where there is room. It will grow in any light free soil, kept rather moist; and it is propagated by layers and by seeds; which last, though rarely produced in Bri-



tain, are frequently sent to this country from America. They ought to be sown immediately on being received, as they are often two years before they come up. Plants, in London, are 1s. 6d. each, and seeds 1s. a packet; at Bollwyller, plants are 2 francs each; and at New York, 25 cents.

Varieties.

✻ *H. v. 2 parvifolia* Nutt. is a native of the mountains of Pennsylvania, with smaller oblong-ovate leaves, and a more stunted habit than the species.

✻ *H. v. 3 macrophylla*, *H. macrophylla* Pursh, has the leaves nearly orbicular, cordate, coarsely and bluntly toothed, and scabrous from dots beneath. It is a native of the western part of Georgia, and of North Carolina, on the Katawba Mountains. It was introduced in 1812, and flowers from May to November. Pursh considers it to be a species; but it appears to us to be only a variety.

App. i. *Other Species, not yet introduced.*

H. persica Dec. is a native of Persia, of which very little is known; and *H. chinensis* R. Br. has quite entire, ovate leaves, and is a native of China, near Nankin.

GENUS II.



FOTHERGILLA L. THE FOTHERGILLA. *Lin. Syst. Icosándria Digýnia.*

Identification. Lin. fil. Suppl., p. 42; Dec. Prod., 4. p. 269; Don's Mill., 3. p. 397.

Derivation. In memory of *John Fothergill*, M.D., an eminent physician and patron of botany, who introduced many new plants, and cultivated an excellent collection in his grounds, at Ham House, at Stratford-le-bow, in Essex.

Description. Deciduous shrubs, of which there is only one species, but several varieties. Natives of North America.

✻ 1. *F. ALNIFOLIA* L. The Alder-leaved Fothergilla.

Identification. Lin. fil. Suppl., 257; Dec. Prod., 4. p. 269; Don's Mill., 3. p. 397.

Synonymes. *F. Gárdeni* Michx. Fl. Bor. Amer., 1. p. 313; *Hamamélis monoica* Lin. ex Smith in *Rees's Cycl.* vol. xvii.

Spec. Char., &c. See the generic character. The flowers, which are white and sweet-scented, appear before the leaves; the latter resembling those of the wych hazel. The following four very distinct forms of this species are in the Hackney arboretum:—

Varieties.

✻ *F. a. 1 obtusa* Sims Bot. Mag., t. 1341.; *F. mājor* Lodd. Bot. Cab., t. 1520.; *F. alnifolia* Lin. fil. Suppl., 257.; and our fig. 759.; has obovate leaves, downy beneath.

✻ *F. a. 2 acuta* Sims; *F. Gárdeni* Jacq. Icon. Rar., t. 100.; has narrow leaves, nearly entire, white from down beneath.

✻ *F. a. 3 mājor* Sims Bot. Mag., t. 1342, and our fig. 758., has leaves ovate-oblong, somewhat cordate at the base, very black and serrated at the apex; when young, tomentose beneath.

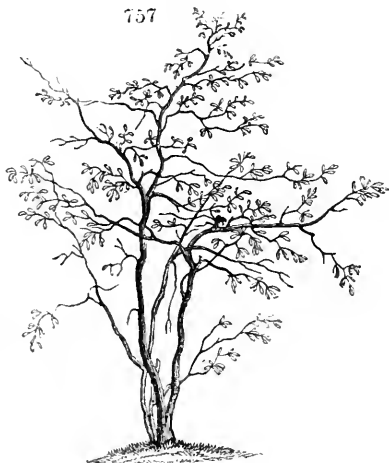

758



* *F. a. 4 serotina* Sims Bot. Mag., t. 1342., has the leaves oblong, acute, crenately toothed at the top, and green beneath.

Description, &c. The *Fothergilla* is a native of North America, from Virginia to Carolina, in shady woods, on the sides of hills, generally growing in soft moist soil. It was introduced in 1765, grows to the height of 4 ft. or 5 ft., and flowers in April or May. In British gardens, it thrives best in moist sandy peat. The species is propagated by seeds, which are sometimes ripened in this country, but are generally received from America; and the varieties by layers. Plants, in the London nurseries, are 1s. each, and seeds 1s. a packet; at Bollwyller, 2 francs a plant; and at New York, 30 cents a plant, and seeds 30 cents per quart.



759



ceived from America; and the varieties by layers. Plants, in the London nurseries, are 1s. each, and seeds 1s. a packet; at Bollwyller, 2 francs a plant; and at New York, 30 cents a plant, and seeds 30 cents per quart.

CHAP. LXI.

OF THE HARDY AND HALF-HARDY LIGNEOUS PLANTS OF THE ORDER CORNA'CEÆ.

This order includes only two genera of hardy woody plants, the characters of which are as follows:—

CO'RNUM L. Tube of the calyx adhering to the ovarium. Limb small, 4-toothed. Petals 4, oblong, sessile; valvate in æstivation. Stamens 4. Style 1. Pome baccate, marked by the vestiges of the calyx, containing a 2-celled, rarely 3-celled, nut. Seed solitary, pendulous. Albumen fleshy. Radicle of embryo shorter than the cotyledons. (*Don's Mill.*, iii. p. 398.)—Deciduous trees and shrubs, all with opposite leaves, except the first species; entire, feather-nerved. Flowers sometimes capitate and umbellate, involucreted; sometimes corymbose and paniced, without an involucre. Petals white, rarely yellow.

BENTHA'MIA Lindl. Flowers disposed in heads, each head attended by an involucre, that consists of 4 petal-like parts, and resembles a corolla. Calyx with a minute 4-toothed limb. Petals 4, fleshy, wedge-shaped. Stamens 4. Style 1. Fruit constituted of many pomes grown together; endocarp in each pome with 2 cells. Seeds solitary and pendulous in each cell.—Trees or shrubs, with leaves opposite. (*Lindley in Bot. Reg.*, t. 1579.) Natives of the Himalayas. Dr. Lindley observes, when giving his reasons for separating this genus from *Cornus*, "We do not understand upon what principle this very distinct genus has been combined with *Cornus*, from which it differs essentially, both in flowers and fruit. Whether or not *C. florida*, which agrees with it in habit, is also a species of *Benthamia*, our means do not enable us to determine." (*Bot. Reg.*, vol. xix. t. 1579.)

GENUS I.



CO'RNUM L. THE DOGWOOD. *Lin. Syst.* Tetrándria Monogýnia.

Identification. Tourn. Inst., 641. t. 410.; *Lin. Gen.*, No. 149.; *Dec. Prod.*, 4. p. 271.; *Don's Mill.*, 3. p. 398.

Synonymes. Cornouiller, *Fr.*; Hartriegel, *Ger.*

Derivation. From *cornu*, a horn; the wood being thought to be as hard and as durable as horn. Hartriegel signifies hard rail, or hard wood. The name of Dogwood is applied to this genus, because, as Parkinson says, in his *Paradisus*, the fruit of most of the species is not fit even for dogs; but it is more likely to have been given to it from the astringent properties of the bark and leaves, a decoction of which was formerly used as a wash for curing the mange, &c., in dogs.

Description. Deciduous trees and shrubs, natives of Europe and North America; in general very hardy, and of easy propagation and culture in British gardens. Most of the species ripen their fruit in England; but they are usually propagated by suckers, or by layers or cuttings. The fruit is commonly called a berry, but must be botanically a pome, according to Lindley's definitions of kinds of fruit, in his *Introd. to Bot.*, 2d ed., p. 197—204. Price, in the London nurseries, from 1s. to 1s. 6d. per plant; at Bollwyller, from 1 franc to 1½ franc; and at New York, from 25 to 50 cents.

§ i. *Nudiflora* Dec.

Derivation. From *nudus*, naked, and *flos*, a flower; the inflorescence being without an involucre.

Sect. Char. Flowers corymbose or paniced, without an involucre. (*Dec. Prod.*, iv. p. 271.)

A. *Leaves alternate.*

§ 1. *C. ALTERNIFOLIA* L. The alternate-leaved Dogwood.

Identification. Lin. fil. *Suppl.*, p. 125.; L'Hérit. *Cern.*, No. 11.; Don's *Mill.*, 3. p. 398.; Lodd. *Cat.*, edit. 1836.

Synonymes. *C. alternata* Marsh.

Engravings. Guimp. *Abb. Holz.*, t. 43.; Schmidt *Baum.*, 2. t. 70.; and our *fig.* 760.

Spec. Char., &c. Leaves alternate, ovate, acute, hoary beneath. Corymbs depressed, spreading. Branches warted. Pomes purple, globose, about the size of a grain of pepper. Leaves on long petioles. Branches green or reddish brown. (*Don's Mill.*, iii. p. 398.) A native of North America, from Canada to Carolina, in shady woods on river banks; where it forms a tree, growing 15 ft. or 20 ft. high, and flowering from May to July. It was introduced in 1760; is very hardy, and is not unfrequent in British collections. At Syon, and in the arboretum at Kew, it is from 12 ft. to 15 ft. high. This species is easily known from every other, even at a distance, by the horizontal umbelliferous character assumed by the branches, which are also dichotomous, with clusters of leaves at the joints; and the general colour is that of a lively green. The leaves are generally alternate, but not unfrequently opposite.



B. *Leaves opposite.*

§ 2. *C. SANGUINEA* L. The blood-red-leaved, or common, Dogwood.

Identification. Lin. *Sp.*, p. 171.; Don's *Mill.*, 3. p. 399.; Lodd. *Cat.*, edit. 1836.

Synonymes. *C. cœmina* Rai: *Syn.*, 470., *Ger. Emac.*, 1467., with a figure; *Virga sanguinea* Math. *Vatgr.*, 1. p. 236., with a figure, *Cam. Epit.*, 159., with a figure; Female Cornel, Dogberry Tree, Hound Tree, Hound's-berry Tree, Prickwood, Gaten or Gatten Tree, Gater or Gatten Tree, Cateridge Tree, wild Cornel; Cornouiller sauvage, sanguin, or femelle, Puine, or Bois punais, *Fr.*; rother Hartriegel, *Ger.*; Sanguinello, *Ital.*

Derivation. This species is called *cœmina*, and Female Cornel, because it bears fruit when very young; whereas *Cornus mas*; reduces male blossoms only till the tree is 15 or 20 years old. *Virga sanguinea* is literally the bloody twig, alluding to the colour of the shoots, though they are not nearly so red as those of *Cornus alba*. The names of Dogberry Tree, Hound Tree, &c., arise from the same source as Dogwood. (See above.) Prickwood alludes to the use of the wood for skewers; Gaten Tree is a corruption of *Gatr treou*, the Saxon name for this species; or, as some suppose, it is derived from *gayta*, the Spanish word for a pipe, the wood of this tree being more hollow, or full of pith, than that of *C. mas*. Catteridge, and all the other somewhat similar names, are derived from Gaten. Chaucer calls the fruit Gaitres berries, evidently from the same origin. The French names of Puine, and Bois punais, bug wood, are from the strong and unpleasant smell of the bark and leaves; and also because a decoction of them forms a wash to destroy bugs. Rother Hartriegel signifies red hard rail, or red hard wood.

Engravings. Eng. *Bot.*, t. 249.; Fl. *Dan.*, t. 481.; N. Du Ham. 2. t. 44.; and our *fig.* 761.

Spec. Char., &c. Bractees straight. Leaves ovate, acute, smooth and green on both surfaces. Corymbs flat. Branches of a dark red when full grown. Leaves 2 to 3 in. long. Flowers greenish white, unpleasantly scented. Petals revolute at the sides. Fruit dark purple, and very bitter. (*Don's*

Mill., iii. p. 399.) This species is a native of Europe and the north of Africa, in hedges and thickets, especially on a chalk and limestone soil. It is plentiful in Britain, in like situations. It is also said to grow in North America, near the lakes of Canada and near New York : but has, probably, been introduced there. It grows to the height of from 4 ft. to 15 ft., according to soil and situation ; flowering in June, and ripening its dark purple fruit in August and September. It is one of the commonest shrubs in old shrubberies : and is easily known from all the other kinds of *Cornus* by the abundance of its dark purple fruit, and the intensely dark red of its leaves before they drop off in autumn. It is from this last circumstance, we suppose, that the specific name of *sanguinea* has been given to it, though it is much more obviously applicable to *C. alba*, on account of the redness of its shoots. *C. purpurea* would be a much better name as contrasted with *C. alba*, both names applying to the fruit.

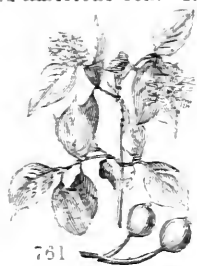

Varieties.

- *C. s. Purshii* Don's *Mill.*, 3. p. 206. *C. sanguinea Purshii*, *Schmidt*, *Bonn.*, t. 2. 66. has the flowers with yellow anthers, and the berries a dark brown. It is a native of North America, near the lakes of Canada, and near New York ; and only differs from the *C. sanguinea* of Europe in having the leaves pubescent, and in being of larger stature. It has not yet been introduced.
- *C. s. l. Vitis variegata* Lodd. *Cat.* has the leaves variegated with white and yellow, and occasional streaks of red. A plant lately received into Messrs. Loddiges's collection, named *C. candidissima* fol. var., appears, from the leaves, to be identical with this variety. *C. candidissima*, in the same collection, from its leaves, appears to be nothing more than *C. sanguinea*.

Properties and Uses. The common British dogwood, being frequent in woods and old hedges, in almost every part of the island, and being also very common on the Continent, and especially in the northern parts of Europe, has long been applied to various useful purposes. The wood, which is hard, though not nearly so much so as that of *Cornus mas*, was formerly used for mill-cogs, and for various purposes in rustic carpentry ; and it still makes excellent skewers for butchers, toothpicks, and similar articles. In the days when bows and arrows were used as muskets are now, arrows were formed of the young wood. In France, the young wood is formed into ramrods : and in various parts of the Continent, particularly in Germany and Russia, it is bored and used as tubes to pipes. It makes excellent fuel, and the very best charcoal for gunpowder. The fruit, which, like the bark and leaves, is bitter and styptic, when treated like that of the olive, yields an oil, at the rate of 34 lb. of oil to 100 lb. of fruit ; which is used, in France, in the manufacture of soap, and for lamps. Miller states that, in his time, the berries were often brought to market, and sold for those of the buckthorn. The bark tastes like apples.

■ *C. ALBA* L. The white-fruited Dogwood.

Identification. *Lin. Mant.*, p. 411 ; *Don's Mill.*, 3. p. 206 ; *Lodd. Cat.*, edit. 1856.
Synonymes. *C. stolonifera* Michx. *Fl. Bor. Amer.*, 1. p. 189 ; *C. tartarica* Mill. *Icon.*, t. 141. *Amm. Trav.*, t. 32.
Engestrings. *Pall. Fl. Ross.*, 1. t. 34 ; *Mill. Icon.*, t. 204 ; and our fig. 762.

Spec. Char., &c. Branchlets recurved. Branchlets glabrous. Leaves ovate, acute, pubescent, hoary beneath. Corymbs depressed. Branches of a fine red colour. Fruit white, or bluish white. (*Don's Mill.*, iii. p. 399.) It is a native of Siberia, at the rivers Oby and Irtysh, among bushes, &c. ; of North America, from Virginia to Canada, on the banks of rivers and lakes ; and also of North California. A shrub, growing from 4 ft. to 10 ft. high, and flowering from May to July. It was introduced in 1741, and is common in shrubberies, where it is interesting in summer from

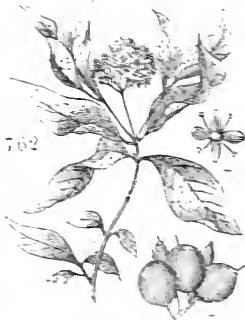

its fine large leaves, and white flowers; in autumn, from its white fruit, which are about the size and colour of those of the mistletoe; and in the winter and spring, from the fine red of its young shoots. Sir W. J. Hooker says of this species of *Córnus*, that it is the only one of the group to which it belongs that he received from British North America; and that it appears to him that *C. stricta*, *C. paniculata*, and *C. sericea*, and also some states of *C. circinata*, are too nearly allied to be made separate species. (*Fl. Bor. Amer.*, i. p. 276.)

Varieties.

✧ *C. a. 2 circinata* Don's Mill., iii. p. 399.; *C. circinata* Cham. et Schlecht. in *Linnaea*, iii. p. 139.; has the berries of a lead colour, according to Dr. Richardson; who further says they are named by the Cree Indians *musquamcna*, because the bears fatten upon them; and *meethquan-pcemecnattick* and *meeisan*, red-stick berry; and that pigeons are fond of them: they are also considered a good stomachic. A native throughout Canada, and from Lake Huron to lat. 69° N., Newfoundland, and the north-west coast of America; but not yet introduced.

✧ *C. a. 3 sibirica* Lodd. Cat., ed. 1836, has the shoots of a fine orange red, covered with a delicate bloom. It makes a splendid appearance in the winter season.

✧ 4. *C. (A.) STRICTA* Lam. The straight-branched Dogwood.

Identification. Lam. Dict., 3. p. 116.; Don's Mill., 3. p. 399.

Synonymes. *C. fastigiata* Michx. *Fl. Bor. Amer.*, 1. p. 92, and *Lodd. Cat.*, edit. 1836; *C. sanguinea* Walt., but not of Lin.; *C. cyanocarpos* Gmel. *Syst. Veg.*, 1. p. 257.; *C. canadensis* Hort. Par.; *C. cærulea* Meerb. *Icon.*, 3., but not of Lam.

Engravings. L'Hérit. *Corn.*, No. 9. t. 4.; Schmidt Baum., 2. t. 67.; and our figs. 763, 764.



763

Spec. Char., &c. Branches straight, fastigiata. Leaves ovate, acuminate, glabrous, green on both surfaces; when young, hardly pubescent beneath. Corymbs convex, somewhat panicled. Branches reddish brown. Anthers blue. Pomes globose, soft, blue on the outside, but white inside. (*Don's Mill.*, iii. p. 399.) A native



764

of North America, from Carolina to Canada, frequent on the banks of rivers; also of Mexico, between Tampico and Real del Monte. A shrub, growing from 6 ft. to 10 ft. or even 20 ft. high, according to soil and situation, and flowering in June and July. Introduced in 1758. The plant in the arboretum at Kew is 15 ft. high.

Varieties.

✧ *C. (a.) s. 2 asperifolia* Lodd. Cat., ed. 1836, if not identical with the species, differs from it but very slightly.

✧ *C. (a.) s. 3 sempervirens* Lodd. Cat., ed. 1836, closely resembles the species, but differs from it in retaining its leaves throughout a part of the winter. There are plants of both these varieties in the arboretum of the Messrs. Loddiges.

✧ 5. *C. (A.) PANICULATA* L'Hérit. The panicled-flowering Dogwood.

Identification. L'Hérit. *Corn.*, No. 10. t. 5.; Don's Mill., 3. p. 398.; Lodd. Cat., ed. 1836.

Synonymes. *C. racemosa* Lam. Dict., 2. p. 116.; *C. foemina* Mill. Dict., No. 4.; *C. citrifolia* Hort. Par.

Engravings. L'Hérit. *Corn.*, No. 10. t. 5.; Schmidt Baum., 2. t. 68.; and our fig. 765.

Spec. Char., &c. Branches erect. Leaves ovate, acuminate, glabrous, hoary beneath. Corymb thyrsoid. Ovarium silky. Branches pale purplish. Pomes roundish, depressed, watery, white, 3 lines in diameter. The dots on the under side of the leaves, which are only seen through a lens, bear bicuspidate,

short, adpressed hairs. Tube of calyx pubescent. (*Don's Mill.*, iii. p. 398.) A native of North America, from Canada to Carolina, rare; in swamps and near rivulets, among other bushes; where it forms a shrub, growing 4 ft. or 6 ft. high, flowering in July and August. In a cultivated state, it forms a low tree, 20 ft. or 25 ft. high. Introduced in 1758, and common in collections. There is a plant of this sort at Kew, which is 10 ft. high; one at Ham House is 25 ft. high, the diameter of the trunk 8 in., and of the head 21 ft. In Scotland, in Fifeshire, in Danibristle Park, it is 12 ft. high; and in Perthshire, at Taymouth, 20 ft. high, and the diameter of the head 25 ft.

Varieties.

- ✻ *C. p.* 2 *albida* Ehrh. *Beitr.*, iv. p. 16.—Leaves elliptic-lanceolate.
- ✻ *C. p.* 3 *radiata* Pursh *Fl. Amer. Sept.*, i. p. 109.—Corymbs sterile, foliiferous.



765

✻ 6. *C. (a.) SERICEA L'Hérit.* The silky Dogwood.

Identification. L'Hérit. *Corn.*, No. 6. t. 2.; *Don's Mill.*, 3. p. 399.; *Lodd. Cat.*, edit. 1836.
Synonymes. *C. lanuginosa Michx. Fl. Bor. Amer.*, 1. p. 92.; *C. alba Walt. Fl. Car.*, 88., but not of Lin.; *C. caerulea Lam. Dict.*, 2. p. 116.; *C. Amomum Du Roi Harbk.*, 1. p. 165.; *C. rubiginosa Ehrh. Beitr.*, 4. p. 15.; *C. ferruginea Hort. Par.*; *C. candidissima Mill.*; *C. cyanocarpus Menck.* but not of Gmel.

Engravings. Schmidt *Baum.*, 2. t. 64.; and our *fig.* 766.

Spec. Char., &c. Branches spreading.

Branchlets woolly. Leaves ovate, acuminate, clothed with rusty pubescence beneath. Corymbs depressed, woolly. Pomes bright blue. Nut compressed. (*Don's Mill.*, iii. p. 399.) A native of North America, from Canada to Carolina, in swampy woods and on river banks. It is a shrub, growing from 5 ft. to 8 ft. high, flowering in June and July. Introduced in 1683. The plant in the arboretum at Kew is 8 ft. high. This sort is very distinct from the two preceding ones, and comes nearer, in general appearance, to *C. alba* than they do; but it is a weaker plant, and smaller in all its parts than that species.



766

The two preceding sorts, *C. (a.) stricta* and *C. (a.) paniculata*, have much narrower leaves, and a more compact fastigiata habit of growth, than any other species or variety of the genus. *C. (a.) paniculata* is the handsomest of the three sorts for a small garden, as it is easily kept of a small size, and in a neat shape, and it flowers profusely.

Varieties.

- ✻ *C. (a.) s.* 2 *oblongifolia* Dec. *Prod.*, iv. p. 272.; *C. oblongifolia Rafn. in Litt.*; has leaves oblong and glabrous above.
- ✻ *C. (a.) s.* 3 *asperifolia* Dec. *Prod.*, iv. p. 272., *Lodd. Cat.*, ed. 1836; *C. asperifolia Michx. Fl. Bor. Amer.*, i. p. 93.—Leaves oval, acuminate, rough above from minute stiff pubescence, and rather tomentose beneath. It is a native of Lower Carolina, in shady woods. This variety is, in all probability, identical with *C. (a.) stricta asperifolia Lodd. Cat.*, noticed p. 1012; but, as the plants in the Hackney arboretum, with this name appended to them, are not rough above, we have thought it worth while to retain the description of Michaux's variety in this place.

‡ 7. *C. (A.) CIRCINATA* L'Hérit. The rounded-leaved Dogwood.

Identification. L'Hérit. *Corn.*, p. 7. No. 8. t. 3.; Hook. *Fl. Bor. Amer.*, 1. p. 276.; Don's *Mill.*, 3. p. 399.; Lodd. *Cat.*, edit. 1835.

Synonymes. *C. tomentosa* Michx. *Fl. Bor. Amer.*, 1. p. 91.; *C. rugosa* Lam. *Dict.*, 2. p. 115.; *C. virginiana* Hort. *Par.*

Engravings. Schmidt *Baum.*, 2. t. 69.; and our fig. 767.

Spec. Char., &c. Branches warted. Leaves broadly oval, acuminate, clothed with hoary tomentum beneath. Corymbs depressed, spreading. Branches slightly tinged with red. Leaves broad, waved on their edges. Flowers white, as in most of the species. Pomes globose, at first blue, but at length becoming white. (Don's *Mill.*, iii. p. 399.) A native of North America, from Canada to Virginia, on the banks of rivers; and probably of California. A shrub, growing from 5 ft. to 10 ft. high, flowering in June and July. Introduced in 1784, and not unfrequent in collections.



There are plants in the Horticultural Society's Garden, and in the collection of Messrs. Loddiges, which are readily distinguished from those of all the other sorts, by their broader leaves, and their rough warted branches.

‡ 8. *C. OBLONGA* Wall. The oblong-leaved Dogwood.

Identification. Wall. in Roxb. *Fl. Ind.*, 1. p. 432.; Don's *Mill.*, 3. p. 398.

Synonymes. *C. paniculata* Hamilt. ex D. Don *Prod. Fl. Nep.*, p. 140.

Spec. Char., &c. Leaves oblong, acuminate, acute at the base, glaucous, and rather scabrous beneath, with many excavated glands along the axils of the ribs and nerves. Corymbs spreading, paniced. Young shoots clothed with short adpressed hair. Leaves 4—6 in. long, and 1 to 1½ in. broad. Petioles about an inch long. Flowers white or pale purplish, fragrant. Calyx clothed with adpressed silvery hairs, as well as the pedicels and petals. Ovarium 3-celled. Pome ovate-oblong. (Don's *Mill.*, iii. p. 398.) A native of Nepal, about Narainhetty, Katmandu, and the Valley of Dhoon; where it forms a tree, growing from 10 ft. to 15 ft. in height. It is said to have been introduced in 1818; but we have never seen it.

♣ *C. macrophylla* Wall. has broad, ovate, acuminate leaves, and small pomes, about the size of black pepper. It is a native of the Himalaya Mountains, but it is not yet introduced.

♣ *C. cretisa* H. B. et Kunth (Don's *Mill.*, 3. p. 399.) is a native of the environs of Mexico, and is closely allied to *C. sanguinea*; but only dried specimens of it have yet been seen in Britain.

§ ii. *Involucrata* Dec.

Derivation. From *involucrum*, an involucre, with which the heads of flowers are severally surrounded.

Seet. Char. Flowers disposed in heads or umbels, surrounded by coloured involucres, which are usually composed of 4 leaves. (Dec. *Prod.*, iv. p. 273.)

A. *Trees with white capitate Flowers.*

‡ *C. disciflora* Moc. et Sesse (Dec. *Prod.*, 4. p. 273.; *C. grandis* Cham. et Schlecht.) has smooth branches, with lanceolate leaves, and ovate fruit. It is a native of Mexico, near Jalapa, but has not yet been introduced.

‡ *C. japonica* Thunb., *Fiburnum japonicum* Spreng., is a native of Japan, with ovate-acuminate leaves, and fruit crowned by a very short permanent style, red, smooth, and rather acid. Not yet introduced.

B. *Trees with yellow, unbelled, Flowers.*

‡ 9. *C. MÅS* L. The male Dogwood, the Cornel, or Cornelian Cherry Tree.

Identification. Lin. Sp., 171.; Don's *Mill.*, 3. p. 400.; Lodd. *Cat.*, ed. 1826.

Synonymes. *C. mascula* L'Hérit. *Corn.*, No. 4., *Guimp. Abb.*, t. 2., *Hayne Term. Bot.*, t. 35., *Fl. Græc.*, t. 151., Schmidt *Baum.*, 2. t. 63., *Lam. Ill.*, t. 73. f. 1., *Kaiph. Cent.*, 1. t. 18.; Long Cherry Tree; Cornelia; Cornouiller mâle, Cornes, Corneilles, Fr.; Kornel Kirsche Hartriegel, Ger.

Derivation. The name of *mås* has been applied to this species since the days of Theophrastus; in all probability, because young plants are barren for many years after they show flowers; these flowers being furnished with stamens only. For an opposite reason, the name of *Cornus femina* was given to *C. sanguinea*. (See p. 1010.) The name of Cornelian Cherry relates to the beautiful colour of the fruit, which resembles that of a cornelian.

Engravings. Black., t. 121.; Plenck. *Icon.*, t. 35.; and our fig. 768.; and the plate in Vol. 11.

Spec. Char., &c. Branches smoothish. Leaves oval, acuminate, rather pubescent on both surfaces. Flowers protruded before the leaves. Umbels about equal in length to the 4-leaved involucre. Flowers yellow. Fruit

elliptic, of a bright shining scarlet colour, the size and form of a small olive or acorn, very styptic in its immature state. (*Don's Mill.*, iii. p. 400.) It is a native throughout Europe, Britain excepted, and in the north of Asia, in hedges and among bushes; and in France, Russia, Germany, Switzerland, Austria, Carniola, Piedmont, &c. A shrub or low tree, growing from 12 ft. to 20 ft. high; introduced in 1596; and flowering from February to April.



Varieties.

‡ *C. m. 2 fructu cææ colòris* N. Du Ham., ii. p. 162., has the fruit of a wax colour. This variety is not common in British gardens.

‡ *C. m. 3 variegatus* has the leaves edged with white or yellow.

Description. The cornel tree, or cornelian cherry, in a wild state, is seldom found above 10 ft. or 12 ft. high; but it attains twice that height in a state of culture. It has ash-coloured pubescent shoots, ovate-lanceolate leaves, and yellow flowers, which, in mild winters, come out in January or February; and the greater part of which, in trees not exceeding twelve or fifteen years of age, have only stamens, and drop off without producing fruit. The fruit ripens in September or October, but is not frequently seen in England. It is about the size of a small acorn, and of a fine, rich, transparent scarlet: it remains a long time on the tree after it is ripe, and is very ornamental. The growth of the tree is remarkably slow after the first ten or twelve years; and its duration is so great, that it is said to live for centuries. It is an irregular-headed tree, furnished with numerous branches; and when it has attained a sufficient age to bear fruit, it is generally about the size of an ordinary apple tree. When it begins to bear, the fruit is produced in tolerable abundance.

Geography and History. The cornel tree is a native of the middle and south of Europe, of Siberia, and the west of Asia, in woods and hedges, generally on soils more or less calcareous. It was known to the ancients, being mentioned by Homer as one of the trees that bear the coarsest fruit, in his *Odyssey* (book x. ver. 242.); where he represents Circe as throwing it, with acorns and beech mast, to the companions of Ulysses, after she had transformed them into swine. Virgil calls it the "meagre food," and couples it with other "savage berries of the wood." Pliny speaks of it as a tree indigenous in Italy, the wood of which was nearly equal to iron in its hardness and fitness for making wedges and wooden pins. The Romans also used it, he says, for making spokes to their wheels. The first notice of its being in England is in Turner's *Herbal*. Tusser mentions the fruit under the name of cornel plums; and Lord Bacon, as cornelians. Gerard, in 1597, says, "There be sundry trees of the cornel in the gardens of such as love rare and dainty plants, whereof I have a tree or two in my garden." Miller, in 1752, says, "The tree is common in English gardens, where it is propagated for its fruit, which is made into tarts, and used in medicine as an astringent and cooler." In a subsequent edition of his *Dictionary*, he mentions the cornel as being chiefly cultivated as an ornamental shrub, which is the principal purpose for which it is at present propagated throughout Europe.

Properties and Uses. The wood has been, in all ages, celebrated for its hardness and durability; and it is at the same time tough and flexible. In a dry state, it weighs 69 lb. 5 oz. to the cubic foot. The heart-wood is of a brownish tint; and the soft wood white, with a slight tint of red. In ancient times, it was much in repute as shafts for javelins; and both Homer and Virgil mention its use for these weapons. In France, when it can be procured of sufficient size, it is used in mill-work, especially as cogs for wheels, and for all the various purposes to which the wood of *Sorbus domestica* is applied. The small branches are said to make the most durable spokes for ladders, wooden forks for turning the grain on barn floors, and for making

hay ; hoops, props for vines, butchers' skewers, and toothpicks. The wooden forks are made by selecting branches which divide into three near the extremity ; and, after cutting the branch to a proper length, which is commonly about 5 ft. or 6 ft., the bark is taken off, and the three branches which are to form the prongs are bent so as to form a triangle, like the wooden corn forks of England. In this state they are put into a hot oven, where they are kept till they are hardened, so as to retain the shape given to them. Similar hay and straw forks are made of the nettle tree in France, and of the willow in various parts of England, by the same procedure. The wood of the cornel, like that of all the species of the genus, makes excellent fuel and charcoal ; and the young shoots form a good substitute for those of the willow, in making baskets and tying up packages of various kinds. In France and Germany, brooms are made of the spray ; but only in those parts of the country where neither the birch nor the *Cytisus scoparius* is to be found. The fruit, when thoroughly ripe, is somewhat sweet, and not disagreeable to eat ; and, on the Continent, it is frequently used in confectionery, and for making marmalades, robs, and liqueurs. It is mixed with apples and pears for making cider ; and, gathered in a green state, and treated like green olives, it is preserved in salt and water, as a substitute for that pickle. In a ripe state, treated like ripe olives, it yields an oil, which may be used for various purposes, but not for the table. A conserve, called rob de cornis, was formerly sold in most druggists' shops in Europe ; but it is now rarely to be met with, even in Germany, where the tree is most plentiful. As an ornamental tree, the cornel is valuable, not only on account of its early flowering, and the fine display made by its ripe fruit, but because it is a low tree, and one which, after it has attained the height of 10 ft. or 12 ft., is of slow growth, and of very great duration. For these last reasons, it is particularly suitable for small suburban gardens, in which it will form a fit associate for small trees of *Crataegus*, *Berberis*, *Rhâmnus*, *Euonymus*, *Hamamelis*, &c.

Poetical Allusions, &c. The cornel tree was dedicated to Apollo ; and Pausanias mentions that there was a festival celebrated in honour of Apollo at Lacedæmonia, called Cornus, which was instituted by the Greeks, to appease the anger of the god at their cutting down a grove of cornel trees consecrated to him on Mount Ida. The Palatine Hill was also formerly a place exclusively devoted to Apollo ; and, when Romulus had fixed on that spot for his infant city, he threw his javelin, made of cornel wood, against the hill, when it had no sooner entered the ground than it sent forth leaves and branches, and became a tree : an omen of the strength and durability of the Roman empire Virgil says that, when Polydore was murdered, the lances and javelins which had pierced his body, and which had all been formed of myrtle and cornel wood, also sprang up into trees. When Æneas and his followers landed in Thrace, they found this grove ; and Æneas attempted to pull up one of these trees ; but, he says, —

“ The rooted fibres rose, and from the wound
Black bloody drops distill'd upon the ground.
Mute and appall'd, my hair with terror stood,
Fear shrank my sinews, and congeal'd my blood.
A groan, as of a troubled ghost, renew'd
My fright ; and then these dreadful words ensued :—
' Spare to pollute thy pious hands with blood,
The tears distil not from this wounded wood ;
But every drop this living tree contains
Is kindred blood, and ran in Trojan veins.
Oh ! fly from this inhospitable shore,
Warn'd by my fate— for I am Polydore ! ”

It is rather curious that the last two fables, which turn on pieces of dry wood suddenly taking root and becoming trees, should be told of plants of such remarkably slow growth as the myrtle and the cornel. But perhaps they have been chosen partly on this account, to make the wonder seem greater.

Propagation, Culture, &c. In British nurseries, plants are generally raised from seed ; for which reason, they are very long before they come into flower. The seed remains two years in the ground before it comes up, and should

therefore be kept a year in the rotting ground, as directed for haws, and holly berries. (See p. 513.) Plants are also raised from layers and suckers. If a variety, with the fruit of superior quality, could be discovered in the woods of France, or in the ancient gardens of convents and châteaux, which still exist in some places in Germany, it would be desirable to continue such a variety by grafting; and this mode is also applicable to the varieties with wax-coloured fruit, with white fruit, with fleshy round fruit, and with variegated leaves, mentioned by Du Hamel. The situation for the cornel tree should be open, but sheltered rather than exposed; and the soil ought to be good, and more or less calcareous.

Statistics. In the environs of London, there are plants in the arboretum at Kew 15 ft. high; and others, of similar dimensions, at Purser's Cross, Ham House, and some other places: but, all these trees being crowded among others, they seldom produce fruit. Between Hampstead and Hendon, in the garden of a villa occupied by Lord Henley, there is a tree which produces fruit annually. The only return which we have had of this tree, from any part of England, is from Grimston, in Yorkshire, where a tree, 14 years planted, is 20 ft. high, the diameter of the trunk 7 in., and of the head 14 ft. Phillips, in his *Syl. Flor.*, p. 186., mentions two trees at Cowfold in Sussex, of the size of moderate cherry or apple trees, which had been abundant bearers for upwards of 30 years. On the Continent, and especially in the south of Germany, most old gardens contain one or two specimens of this tree. On October 23, 1828, when we were on a journey from Donaueschingen to Bavaria, we stopped to look at the gardens of the ancient Château of Maskirch; and, in a small enclosure close to the château, we found a labyrinth, the hedge of which consisted entirely of *Cornus más*, with standard trees of the same species at regular distances, which were at that time bearing ripe fruit, which we tasted, and found of very good flavour. Later in the same year, we were shown, in the grounds of the Castle of Heidelberg, the famous cornelian cherry trees which were planted there in 1650, already mentioned, p. 147.

‡ 10. *C. FLORIDA* L. The Florida Dogwood.

Identification. Lin. Sp., 1661.; L'Hérit. Corn., No. 3.; Don's Mill., 3. p. 400.; Lodd. Cat., ed. 1836. *Synonymy.* Virginian Dogwood.

Engravings. Bot. Mag., t. 526.; Catesb. Car., t. 27.; Bigel. Med. Bot., 2. t. 28.; Guimp. Abb. Holz., t. 19.; Rafin. Med. Bot., t. 28.; Schmidt Baum., 2. t. 52.; Wang. Beytr., 1. t. 17. f. 41.; and our fig. 769.

Spec. Char., &c. Branches shining. Leaves ovate, acuminate, pale beneath, beset with adpressed hairs on both surfaces. Flowers umbellate, protruded after the leaves. Leaves of involucre large, roundish, retuse, or nearly obovate. Pomes ovate. Leaves of involucre white. Flowers greenish yellow, and very large. Pomes scarlet, about half the size of those of *C. más*; ripe in August. (*Don's Mill.*, iii. p. 400.) It is a native of North America, from Carolina to Canada, in woods, common; and on the banks of the Columbia, near its confluence with the sea. A tree, growing to the height of 20 ft. or 30 ft. It was introduced in 1731, and flowers in April and May.

Description. *Cornus florida* is universally allowed to be the handsomest species of the genus. In its native country, it forms a tree reaching, in the most favourable situations, 30 ft. or 35 ft. in height, with a trunk 9 in. or 10 in. in diameter; but, in general, it does not exceed the height of 18 ft. or 20 ft., with a trunk of 4 in. or 5 in. in diameter. Michaux describes the trunk as "strong, and covered with a blackish bark, chapped into many small portions, which are often in the shape of squares more or less exact. The branches are proportionally less numerous than on other trees, and are regularly disposed, nearly in the form of crosses. The young twigs are observed to incline upwards in a semicircular direction. The leaves are opposite, about 3 in. in length, oval, of a dark green above, and whitish beneath; the upper surface is very distinctly sulcated. Towards the close of summer, they are often marked with black spots; and at the approach of winter they change to a dull red. In New York and New Jersey, the flowers are fully expanded about the 10th or 15th of May, when the leaves are only beginning to unfold themselves. The flowers are small, yellowish, and connected in bunches, which are surrounded with a very large involucre, composed of 4 white floral leaves, sometimes inclining to violet. This fine involucre constitutes all the beauty of the flowers,



which are very numerous, and which, in their season, robe the tree in white, like a full-blown apple tree, and render it one of the fairest ornaments of the American forests." Catesby, who first described this tree, says that the blossoms break forth in the beginning of March, being at first not so wide as a sixpence, but increasing gradually to the breadth of a man's hand; being not of their full bigness till about six weeks after they begin to open. The fruits, which are of a vivid glossy red, and of an oval shape, are always united: they remain upon the trees till the first frosts; when, notwithstanding their bitterness, they are devoured by the red-breasted thrush (*Turdus migratorius L.*), which, about this period, arrives from the northern regions, and the mocking-bird (*T. polyglottus, L.*), during the whole winter. In England, this tree does not thrive nearly so well as in its native country, seldom being found, in the neighbourhood of London, higher than 7 ft. or 8 ft., and not often flowering; though at White Knights it attains a larger size, and flowers freely every year.

Geography. In America, the *Cornus florida* is first found on the Columbia river, near its confluence with the sea. In the United States, it appears in Massachusetts, between *n. lat.* 42° and 43°. "In proceeding southward, it is met with uninterruptedly throughout the eastern and western states, and the two Floridas, to the banks of the Mississippi. Over this vast extent of country it is one of the most common trees; and it abounds particularly in New Jersey, Pennsylvania, Maryland, and Virginia, wherever the soil is moist, gravelly, and somewhat uneven: farther south, in the Carolinas, Georgia, and the Floridas, it is found only on the borders of swamps, and never in the pine barrens, where the soil is too dry and sandy to sustain its vegetation. In the most fertile districts of Kentucky and West Tennessee, it does not appear in the forest, except where the soil is gravelly, and of a middling quality. (*Michx.*) Mr. William Bartram, in his *Travels in Georgia and Florida*, gives the following account of the appearance of this tree near the banks of the Alabama river:—"We now entered a remarkable grove of dogwood trees (*Cornus florida*), which continued nine or ten miles unaltered, except here and there by a towering *Magnolia grandiflora*. The land on which they stand is an exact level; the surface a shallow, loose, black mould, on a stratum of stiff yellowish clay. These trees were about 12 ft. high, spreading horizontally; and their limbs meeting, and interlocking with each other, formed one vast, shady, cool grove, so dense and humid as to exclude the sunbeams, and prevent the intrusion of almost every other vegetable; affording us a most desirable shelter from the fervid sunbeams at noonday. This admirable grove, by way of eminence, has acquired the name of the Dog Woods. During a progress of nearly seventy miles through this high forest, there was constantly presented to view, on one hand or the other, spacious groves of this fine flowering tree, which must, in the spring season, when covered with blossoms, exhibit a most pleasing scene; when, at the same time, a variety of other sweet shrubs display their beauty, adorned in their gay apparel; as the *Halæsia*, *Stewartia*, *Æsculus*, *Pavia*, *Azalea*, &c., entangled with garlands of *Tecoma crucigera*, *T. radicans*, *Gelsemium sempervirens*, *Wistaria frutescens*, *Caprifolium sempervirens*, &c.; and, at the same time, the superb *Magnolia grandiflora*, standing in front of the dark groves, towering far above the common level." (*Bartram's Travels*, p. 400.)

History. This fine tree was first discovered in Virginia, by Banister; and afterwards, by Catesby, in the forests of Carolina. It was cultivated in Britain by Fairchild, before 1731; and by Miller, in 1739; and has since been propagated, and introduced into our principal collections. As already observed, however, it does not thrive in the neighbourhood of London. The only instances, of which we have heard, of its flowering near the metropolis are, at South Lodge, on Enfield Chase, where Collinson informs us he went to see it when it flowered for the first time; at Syon Hill; and at Syon House. Miller, in 1752, says that the tree is common in English gardens, under the name of Virginian dogwood, that it is as hardy as any of the other species; and that, though it produces abundance of large leaves, it is not plentiful of flowers

nor has he yet seen any plants which have produced fruit in England. There is a fine specimen at Syon Hill, upwards of 20 ft. high; and another at Syon House, 17 ft. high, both of which have flowered. There are many plants, from 6 ft. to 12 ft. high, in the grounds at White Knights, which flower freely every year.

Properties and Uses. The wood is hard, compact, heavy, and fine-grained; and it is susceptible of a brilliant polish. The sap-wood is perfectly white, and the heart-wood is of a chocolate colour. In the United States, it is used for the handles of hammers and light tools, such as mallets, &c. In the country, some farmers use it for harrow teeth, for the hames of horses' collars, and also for lining the runners of sledges; but, to whatever purpose it is applied, being liable to split, it should never be wrought till it is perfectly seasoned. The shoots, when three or four years old, are found suitable for the light hoops of small portable casks; and, in the middle states, the cogs of mill-wheels are made of them, and the forked branches are taken for the yokes which are put upon the necks of swine, to prevent their breaking into cultivated enclosures. The inner bark is extremely bitter, and proves an excellent remedy in intermitting fevers. It has been known, and successfully used, by the country people in the United States, as a specific in these maladies, for more than fifty years. (Bigelow's *Amer. Bot.*, ii. 74.) Half an ounce of dog-wood bark, 2 scruples of sulphate of iron, and 2 scruples of gum arabic, infused in 16 ounces of rain-water, make an excellent ink. (*Michx.*) From the bark of the more fibrous roots the Indians obtain a good scarlet colour; and Bartram informs us (vol. i. p. 51.) that the young branches, stripped of their bark, and rubbed with their ends against the teeth, render them extremely white. In England, the sole use of this species is as an ornamental shrub; and, wherever it will thrive, few better deserve a place in collections.

Soil, Situation, Propagation, &c. This species thrives best in a peat soil which must be kept moist; and the situation should be sheltered, though the foliage of the plants must be fully exposed to the influence of the sun, otherwise they will not flower. They are propagated by cuttings or layers, both of which readily strike root. Plants, in the Fulham Nursery, cost 1s. 6d. each; at Bollwyller, 1 franc and 50 cents; and at New York, 37½ cents.

GENUS II.



BENTHA`MIA Lindl. THE BENTHAMIA. *Lin. Syst.* Tetrándria Monogýnia.

Identification. Lindl. in *Bot. Reg.*, t. 1579.

Synonyme. *Córnus* sp. *Walt., Dec.*, and *G. Don.*

Derivation. Named in honour of *George Bentham*, Esq., F.L.S., Secretary to the Horticultural Society; and nephew of the celebrated moralist and jurist, *Jeremy Bentham*.

‡ I. B. FRAGÍ`FERA Lindl., The Strawberry-bearing Benthamia,

Córnus capitata *Wall. in Roxb. Fl. Ind.* i. p. 434., *D. Don Fl. Prod. Nepal.*, 141., and *G. Don's Mill.*, iii. p. 399., *Bot. Reg.*, t. 1579., and our fig. 770., has the branches spreading, and the leaves smooth, lanceolate, and acuminate at both ends, coriaceous, 2 in. long, glaucous and pale beneath, sometimes with pink-coloured nerves. The flowers are terminal, congregated into globular heads, surrounded by an involucre 2 in. across when expanded, and composed of 4 yellowish-coloured parts, resembling petals: the flowers themselves are greenish, small, and inconspicuous. The fruit, when ripe, is of a reddish colour, a good deal resembling that of the mulberry, but exceeding it considerably in size. The flesh is yellowish white, rather insipid, but not unpleasant, although a little

bitter to the taste; and, as Mr. Royle informs us, it is eaten by the inhabitants of the hills in the Himalayas. It is a native of Nepal, where it grows to a small tree, approaching, in the general appearance and character of its leaves and flowers, to *C. florida*, but differing from that species in its fruit. The plant was first found by Dr. Wallich, on the top of a mountain in Nepal; and specimens were subsequently sent to him from other mountains in that country, where the tree is described to be about the size of an apple tree; flowering in June, and ripening its fruit in October. Seeds were obtained by Sir Anthony Buller, during his residence in the East Indies, and sent by him to his



relation, J. H. Tremayne, Esq., in whose garden, at Heligan, in Cornwall, plants were first raised in England, in 1825. In December, 1833, specimens of this plant, bearing ripe fruit, leaves, and flower buds, were sent to the *Gardener's Magazine*, by Mr. Roberts, the gardener at Heligan; who described the plant as an evergreen, and as being then 16 ft. in height, and covered with fruit. It had stood out in the open ground for 8 years, without any protection whatever, not even that of a mat. It is planted in stiff clay, and at a great elevation. It produces a profusion of flowers during summer, and of fruit in autumn. The plant is readily propagated either from seeds or cuttings, and will, no doubt, soon be frequent in collections. Judging from the plants in the Horticultural Society's Garden, it seems to prefer a situation rather shaded and moist, than dry and sandy; which corresponds with the experience of Mr. Roberts in Cornwall; and it will probably be found somewhat tender for a few years after planting. There can be no doubt, however, of its ultimately proving perfectly hardy; at least as much so as *Cornus florida*; for Mr. Royle mentions that he found it in several situations in the Himalayas, at elevations of from 6500 ft. to 8000 ft., in conjunction with species of *Sorbus*, *Cotoneaster*, and *Crataegus*. (*Hort. Trans.*, new ser., vol. i. p. 458.) Perhaps it might be rendered hardier by grafting it on *Cornus sanguinea*. Plants of this species, in the London nurseries, are 2s. 6d. each.

CHAP. LXII.

OF THE HARDY LIGNEOUS PLANTS OF THE ORDER LORANTHACEÆ.

THE hardy ligneous plants belonging to this order are included in the genera *Viscum* and *Aucuba*.

VISCUM L. Flowers diœcious, or monœcious. Margin of the calyx obsolete, in the male flowers almost wanting. Petals usually 4, connected at the base in the male flowers, but free in the female. Stamens 4. Stigma obtuse, sessile. Berry globular, smooth, juicy, viscid, of 1 cell. Seed solitary, heart-shaped, compressed, sometimes with 2—4 embryos. (*Dec. Prod.* and *Don's Mill.*, adapted.)—Parasitical on trees, shrubby, branched, smooth, and pale green. Leaves entire, mostly opposite.

AUCUBA Thunb. Flowers diœcious. Calyx 5-toothed. Petals 4, ovate-lanceolate. Stamens 4, alternating with the petals. Stigma concrete. Fruit fleshy, 1-seeded.—A small evergreen tree or shrub, with dichotomous or verticillate branches, and entire, opposite leaves, in the manner of *Viscum*. Botanists are not quite agreed as to what order this genus should be placed under; but, as this is a matter of no great consequence in a work like the present, we have followed G. Don, in including it in Loranthacæ.

GENUS I.



VISCUM L. THE MISTLETOE. *Lin. Syst. Monœcia, or Diœcia, Tetrândria.*

Identification. Tourn. Inst., p. 609; Lin. Gen., No. 1105; Dec. Prod., 4. p. 277; Don's Mill., 2. p. 402.

Synonymes. Misseldine, Gui, or Guy, *Fr.*; Mistl, or Missel, *Ger.*; Visco, or Vischio, *Ital.*; Legamodoga, *Span.*

Derivation. *Viscus*, or *viscum*, is the Latin for birdlime, which is made from the berries; and Mistletoe is by some supposed to be derived from *mist*, the German word for dung, or slimy dirt, and by others from *mistelta*, the Saxon name for the plant.

Description. Parasitical shrubs, found on the trunks and branches of trees, of which 76 species are described in Don's *Miller*; but only one is a native of Europe, and this has its sexes diœcious.

£ 1. *V. ALBUM* L. The white-fruited, or common, Mistletoe.

Identification. Lin. Sp., 1451.; Dec. Prod., 4. p. 277.; Don's Mill., 3. p. 403.

Engravings. N. Du Ham., t. 115.; Eng. Bot., t. 1470.; Baxt. Brit. Pl., t. 40.; and our *fig.* 771., which exhibits a portion of a male plant, marked *m*, and of a female plant in fruit, marked *f*.

Spec. Char., &c. Stem much branched, forked; with sessile intermediate heads, of about 5 flowers. Branches terete. Leaves obovate-lanceolate, obtuse, nerveless. (*Don's Miller*, iii. p. 403.) Parasitical both on deciduous and evergreen trees and shrubs.

Description. The mistletoe forms an evergreen bush, pendent from the trunks and branches of trees, composed of dichotomous shoots, opposite leaves, and yellow flowers, which are succeeded by fruit, which is almost always white, but of which there is said to be a variety with red fruit. The plant is seldom more than 3 ft. or 4 ft. in diameter; it is thickly crowded with branches and leaves. Their growth is slow, seldom more than 2 in. or 3 in. of the shoot, and two or three pairs of leaves, being produced in a season. The leaves vary considerably in different plants, as may be seen in *fig.* 772., which contains engravings of three different specimens, sent to us by our esteemed friend, Mr. Baxter, curator of the Botanic Garden, Oxford; all reduced to the same scale of 2 in. to a foot. The durability of the plant is proportionably great; for, when once established on a tree, it is seldom known to cease growing while the tree is in life; but, when it dies, or the branch on which it is rooted decays, or becomes diseased, the death of the mistletoe immediately follows.

Geography. The mistletoe is found throughout Europe, and in the colder regions of Asia; and probably, also, of Africa and South America, though the species found in these countries have other names. It is found in various parts of England; and it has also been discovered in one situation in Scotland (Meikleour); though it cannot be considered as truly indigenous there. The trees on which the mistletoe grows belong to various natural orders; and, indeed, it would be difficult to say on what dicotyledonous trees it will not grow. In England, it is found on *Tiliacæ*, *Aceracæ*, *Rosacæ*, *Cupuliferæ*, *Salicacæ*, *Oleacæ*, and, we believe, also on *Coniferæ*. At any rate, in the neighbourhood of Magdeburg, it is growing in immense quantities on *Pinus sylvestris*. In France, it grows on trees of all the natural orders mentioned, but least frequently on the oak. It does not grow on the olive in France, though it abounds on the almond. In Spain, it grows on the olive; as it does in the neighbourhood of Jerusalem; and, in the latter locality, is found the variety with red fruit, which is perhaps a *Loranthus*. In England, it is most abundant on the apple tree, in the cider counties; but, in artificial plantations, it is to be found on most of the trees of which they consist. It is abundant



on the common lime tree, at Shardeloes, in Buckinghamshire; and on the black poplar, at Sutton Place, in Surrey.

History. The mistletoe was known to the Greeks and Romans. In speaking of that which grows on the oak, we must not forget that Pliny says that "the Gauls held this plant in the greatest veneration; and that their magicians, whom they call druids, consider nothing more sacred." The Greeks and Romans appear to have valued it chiefly for its medicinal qualities; and more especially as an antidote to poisons. The Persian magi gathered the mistletoe with great care, and used it in their religious ceremonies. According to Gerard, the mistletoe, in his time, was valued for several properties; but he says nothing respecting its propagation or culture. The first botanist who appears to have attempted this was the celebrated Du Hamel; and, since his time, its propagation has been attended with success, both in this country and on the Continent.

Properties and Uses. The berries have, from a very early period, been used as birdlime; which, Gerard says, is greatly to be preferred to birdlime made from the holly. The contrary of this, however, is asserted by Du Hamel. As a medicine, the mistletoe was frequently employed, in England, as a cure for epilepsy; but it no longer holds a place in the British materia medica. The berries are eaten by the blackbird, the fieldfare, and thrush; especially by the large, or missel, thrush. It was formerly believed that birdlime was only the excrements of the thrush, which feeds chiefly on the berries of this tree, and that the bird was often caught by what it had itself voided. Hence the Latin proverb, "Turdus malum sibi cacat." The principal use made of the entire plant is, to hang up in kitchens of farm-houses, &c., at Christmas. In Herefordshire, where the berries are very abundant, a birdlime is sometimes made from them, by boiling them in water till they burst, and afterwards beating them up in water, and washing them, till all the husks are separated from the pulp. The Italians add oil to their mistletoe birdlime, after it has been thus prepared.

Mythological, poetical, and legendary Allusions. The mistletoe, particularly that which grows on the oak, was held in great veneration by the ancient Britons. At the beginning of their year, the druids went in solemn procession into the forests, and raised a grass altar at the foot of the finest oak, on which they inscribed the names of those gods which were considered as the most powerful. After this, the principal druid, clad in a white garment, ascended the tree, and cropped the mistletoe with a consecrated golden pruning-hook, the other druids receiving it in a piece of pure white cloth, which they held beneath the tree. The mistletoe was then dipped in water by the chief druid, and distributed among the people, as a preservative against witchcraft and diseases. If any part of the plant touched the ground, it was considered to be the omen of some dreadful misfortune, which was about to fall upon the land. The ceremony was always performed when the moon was 6 days old, and two white bulls were sacrificed when it was concluded. The following fable respecting the mistletoe is abridged from the *Edda*:—Friga, the Scandinavian Venus, having discovered, through her skill in divination, that some evil threatened her son Balder (Apollo), exacted an oath from fire, earth, air, and water, and every thing that sprang from them, not to injure him. Loke, the evil spirit, finding, at a kind of tournament held soon after by the Scandinavian gods (who, it must be remembered, were very warlike deities), that none of the lances, &c., ever touched Balder, but glanced away, as though afraid of approaching him, suspected that they were under the influence of some charm, and determined, if possible, to discover what it was. For this purpose, he disguised himself as an old woman, and, introducing himself to Friga, contrived to insinuate himself into her confidence; when Friga told him that every thing that grew on the earth, flew in the air, swam in the sea, &c., had taken an oath not to hurt her son. Loke pointed to the mistletoe, which neither grew in earth, nor water, and asked her if it was included in the charm. Friga owned that it was not; but added, that so

feeble and insignificant a plant was not likely to injure Balder. Loke no sooner left Friga, than he formed of the branches of the mistletoe a sharp arrow, with which he instructed Heder (the blind god of fate) how to kill Balder. All nature mourned the loss of the god of the sun; and Hela (the goddess of death), moved by the universal grief, agreed to restore him, if it could be proved that every living thing had shed tears. Every creature wept; and even the trees drooped their branches to the earth, dripping like rain. Loke alone remained with dry eyes; till the gods, enraged at his apathy, rushed upon him *en masse*, and chained him in the bottomless pit; where he soon shed tears enough to release Balder; but where he is still left, and occasionally, by his struggles to get free, causes earthquakes. The magical properties of the mistletoe are mentioned both by Virgil and Ovid; and Apuleius has preserved some verses of the poet Lelius, in which he mentions the mistletoe as one of the things necessary to make a man a magician. In the dark ages, a similar belief prevailed; and, even to the present day, the peasants of Holstein, and some other countries, call the mistletoe the "spectre's wand;" from a supposition that holding a branch of mistletoe in the hand will not only enable a man to see ghosts, but to force them to speak to him. Forster mentions that a writer in the *Gentleman's Magazine* for 1791 states that the guidel, or mistletoe, is supposed by some to have been the forbidden tree in the Garden of Eden; and adds that hence, probably, arose the custom of kissing under it at Christmas; though this appears to be a *non sequitur*. It is more probable that the custom has been handed down to us from our Saxon ancestors, who, on the restoration of Balder, dedicated the plant to their Venus, Friga, to place it entirely under her control, and prevent it from being again used against her as an instrument of mischief. In the feudal ages, it was gathered with great solemnity on Christmas Eve, and hung up in the great hall, with loud shouts and rejoicing.

"On Christmas Eve the bells were rung;
On Christmas Eve the mass was sung:
That only night in all the year
Saw the stole'd priest the chalice rear.
The damsel donned her kirtle sheen;
The hall was dressed with holly green:
Forth to the woods did merry men go,
To gather in the misseltoe.
Then opened wide the Baron's hall
To vassal, tenant, serf, and all."

In France, New Year's gifts are still called, in some of the provinces, *guy an neuf*. This is said by Forster, in his *Perennial Calendar*, p. 2., to have arisen from a practice of the druids; who, "with great ceremonies, used to scrape off from the outside of the oak the mistleden, which they consecrated to their great Teutates," on the first day of the New Year; and then distributed it to the Gauls, "on account of the extraordinary virtues they attributed to it."

Propagation. In a state of nature, the mistletoe is propagated by the berries being, by some means or other, made to adhere to the bark of a living tree. The common agency by which this is effected is supposed to be that of birds; and more especially of the missel thrush, which, after having satisfied itself by eating the berries, wipes off such of them as may adhere to the outer part of its beak, by rubbing it against the branch of the tree on which it has alighted; and some of the seeds are thus left sticking to the bark. If the bark should be smooth, and not much indurated, the seeds will germinate, and root into it the following spring; that is, supposing them to have been properly fecundated by the proximity of a male plant to the female one which produced them. Aristotle and Pliny, among the ancients, and Dr. Walker among the moderns, considered that the mistletoe was propagated by the excrements of the birds, which had fed on the berries; supposing that the heat of the stomach, and the process of digestion, were necessary to prepare the seeds for vegetation. Ray first suggested the idea of trying by experiment whether the seed would vegetate without passing

through the body of a bird; and, at his suggestion, Mr. Doody, an apothecary of London, inserted a seed of the mistletoe into the bark of a white poplar tree, which grew in his garden, with complete success. This, Professor Martin observes, has been since done by many persons, both by rubbing the berries on the smooth bark of various trees, and by inserting them in a cleft, or in a small hole bored on purpose, which was the mode adopted by Doody. Mr. Baxter of the Oxford Botanic Garden, in the spring of 1833, rubbed nine mistletoe seeds on the smooth bark of an apple tree, all of which germinated: two produced only one radicle each, six produced two radicles each, and one produced three; from which it follows, that two radicles are more common than one in the seeds of this plant. There are as many embryos as radicles.

The celebrated Du Hamel, arguing that the seeds of the mistletoe, like the seeds of other plants, would germinate anywhere, provided they had a suitable degree of humidity, made them sprout not only on the barks of different kinds of living trees, but on dead branches, on bricks, tiles, stones, the ground, &c. But, though they germinated in such situations, they did not live any time, except on the bark of living trees. M. Du Trochet made seeds of the mistletoe germinate on the two sides of the frame of a window, and in both cases the radicles directed themselves towards the interior of the room, as if in quest of darkness. (See *Richard's Elements of Botany*; and *Baxter's Brit. Flowering Plants*, art. *Viscum*.)

The first indication of germination is the appearance of one or more radicles, like the sucker of a house fly, but larger; as at *h i*, in *fig. 772*, which are front views, and at *k l* in the same figure, which are side views, taken from mistletoe berries, which were stuck on the upright trunk of a cherry tree in our garden at Bayswater, in March, 1836, and germinated there, as they appeared on the 20th of May of the same year. When the white, viscous, pulpy matter of the mistletoe berry is removed, the kernel, or seed, appears of a greenish colour, and flat; sometimes oval,

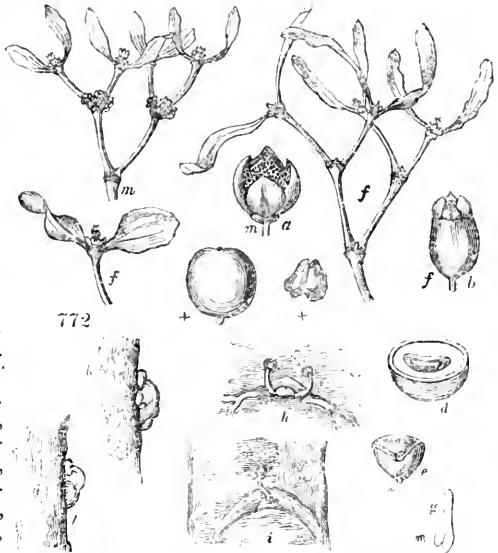

and at other times of various forms. In *fig. 772*, *a* is the male blossom magnified; *b*, the female blossom magnified; *d*, a berry cut through, transversely; *e*, a seed divided vertically, showing the two embryos; *g*, the embryo magnified; *h*, the two embryos, with the two radicles germinating; *i*, a single radicle; *k*, a side view, or section, of the two radicles; and *l*, a side view, or section, of the single radicle.

It is remarked by Du Hamel, that, when the form of the seed is oval, generally one radicle only is protruded; but, when it is triangular or irregular, 2, 3, or more, appear. It is singular, that, while the radicle of almost all other plants descends, this is not the case with the mistletoe; the young root of which at first rises up, and then bends over till it reaches the body of the substance to which the seed has been attached, as at *k* and *l*, *fig. 772*. Having

reached that substance, the point of the radicle swells out like the extremity of the sucker of a house-fly, or, according to the comparison of Du Hamel, like the mouth-piece of a hunting-horn. The extremity of the radicle having fixed itself to the bark, if more than one have proceeded from a single seed, the embryos all separate from it; and each, putting out leaves at its upper extremity, becomes a separate plant. In the case of the seeds which germinated on the bark of trees in our garden at Bayswater, the embryos had not separated from the seed on Aug. 15th, the day on which we correct this proof. When the mistletoe germinates on the upper side of a branch, the shoots bend upwards; but, if they are placed on the under side, they descend: when they are placed on the side of a perpendicular trunk they proceed horizontally, spreading, of course, with the growth of the plant, so as ultimately to form a hemispherical bush. The roots of the mistletoe, which penetrate the bark, extend themselves between the inner bark and the soft wood, where the sap is most abundant, sometimes sending up suckers at a distance from the point where the root entered; and hence Professor Henslow concludes that the mistletoe is propagated in the bark or young wood of the trees in which it is parasitically established, in the same manner as those terrestrial plants which, like the potato, possess rhizomata or underground stems, or suckers, from the surface of which young plants are developed at intervals. The roots of the mistletoe, as the tree on which it grows advances in growth, become embedded in the solid wood; and hence has arisen the opinion of some, formed from sections of a branch on which the mistletoe had grown for many years, that it not only roots into the bark, but into the wood. This, however, would be contrary to the wise economy of nature, since it could serve no useful purpose to the plant. The effect of the mistletoe upon the tree on which it grows is injurious to the particular branch to which it is attached; and more particularly to the part of it which extends beyond the point from which the mistletoe protrudes. This is easily accounted for, from both the ascending and returning sap being in a great part absorbed by the roots of the parasite, and prevented from circulating properly. As it does not appear that any part of the sap returned by the leaves of the mistletoe enters into the general circulation of the tree, it is easy to conceive that a certain number of plants growing on any branch would, after they had so far injured that branch as to prevent it from putting out leaves at its extremities, occasion its death, as well as their own speedy destruction. Hence, in orchards, the mistletoe is always removed as soon as it appears. The injury which it does is much greater than that effected by other plants which grow on the bark of trees; such as lichens, mosses, ferns, &c.; which, though commonly called parasites, are, in botanical language, epiphytes; that is, inhabiting trees but not living on their substance. The nutriment which supports epiphytes is derived from the decay of the outer bark, or from the atmosphere. Two experiments remain to be made with the mistletoe: the first is, whether it may be propagated by inserting cuttings in the live bark, in the manner of buds or grafts; and the second, whether a plant of mistletoe would keep alive the tree on which it grows, after that tree was prevented from producing either leaves or shoots.

The propagation of the mistletoe in British nurseries has scarcely been attempted: but nothing could be easier on thorns or crab apples, planted in pots for the conveniency of removal. Perhaps, if it were propagated on shoots of the poplar or willow, truncheons of these trees with young plants of mistletoe on them might be taken off, and planted as cuttings, without injuring the parasite.

App. i. *Other Species of Viscum.*

As already observed, many species of *Viscum* are described by botanists. Several species, Royle observes, are found in Bengal and Silhet, in mountainous situations; and *V. verticilliflorum* Royle, at Mussoree, on the oak. *V. clongatum* Dec. is found in the Peninsula, and on the hills of the central range of the Himalayas.

GENUS II.

*AUCUBA* Thunb. THE AUCUBA. *Lin. Syst. Diœ'cia Tetrândria.*

Identification. Thunb. Fl. Jap., p. 4; Dec. Prod., 4, p. 274; Don's Mill., 3, p. 433.

Synonymes. *Aukuba* Kämpf. Amœn., 5, p. 775; *Eubasis Salsib Prod.*, p. 68.

Description, &c. An evergreen shrub or tree; a native of Japan. Branches dichotomous or verticillate, in the manner of those of *Loránthus* and *Viscum*. The male blossom unknown. Only the female state of this plant is in British gardens.

■ 1. *A. JAPÓNICA* Thunb. The Japan Aucuba.

Identification. Thunb. Fl. Jap., p. 64; Dec. Prod., 4, p. 274; Don's Mill., 3, 433.

Synonymes. *Eubasis dichótonus Salsib. Prod.*, p. 68; spotted-leaved Laurel, Japan Laurel.

Engraving. Banks; Icon. Kämpf., t. 6; Thunb. Icon. Fl. Jap., t. 12. and 13; Bot. Mag., t. 1197.

Spec. Char., &c. Native of Japan, where it is common both in a wild and cultivated state, producing its red berries in March. The aucuba, in British gardens, is a well-known laurel-like evergreen shrub, having the leaves mottled with yellow; but in Japan the leaves are said, by Thunberg, to be sometimes green. According to Kämpfer, it forms, in its native country, a tree, with the fruit a red oblong drupe, like a laurel berry, with a white sweetish pulp; and a kernel with a bitter taste. It was introduced in 1783, and, at first, treated like a stove plant, as was customary, in those days, with plants from Japan and China; it was afterwards found to stand in the green-house, and, in a short time, in the open air. It is now considered as hardy as, or harder than, the common laurel; and, what is a very valuable property in England, it will endure coal smoke better than almost any other evergreen. It is readily propagated by cuttings; and grows freely in any soil tolerably dry, advancing steadily by shoots of from 9 in. to 1 ft. long every season.

App. I. *Loranthœcœ* not introduced.

L. europæus. (*Lin. Sp.*, 1672; *Jacq. Fl. Austr.*, t. 30; *Dec. Prod.*, 4, p. 671; *Don's Mill.*, 3, p. 409; *Schkuhr Handb.*, t. 94; *Plenck Icon.*, t. 248.) *The European Loranthus.* Plant glabrous, much branched. Branches terete. Leaves opposite, petiolate, oval-oblong, obtuse, somewhat attenuated at the base. Racemes terminal, simple. Flowers dioecious, of 6 petals. Anthers adnate in the male flowers. (*Don's Mill.*, iii, p. 409.) A parasitical shrub, with the habit of *Viscum album*, and, like it, having greenish flowers, and yellowish berries. It is a native of Austria, Hungary, Italy, and Upper Siberia, where it grows on the oak, the sweet chestnut, and other trees, as the mistletoe does in England. It has not yet been introduced into Britain, though it might easily be so, by procuring a box of the berries from Vienna, and treating them as directed for those of the mistletoe, p. 1023.

L. odorátus Wall. is a native of Nepal, with leaves from 4—6 in. long, and many-flowered spikes, of small, white, very sweet-scented flowers.

L. Lambertianus Schultes is a native of Nepal, with the habit of *L. europæus*; and is, probably, the same species.

Various other species are described by botanists as natives of different parts of Asia. Royle remarks that the genus *Loránthus* "is found in considerable numbers on trees, in every part of the plains of India; not less than 90 being found in that country, in the Malayan peninsula; though *L. bicolor* is the most common species. Some few ascend the mountains; and several occur in Nepal. Of these, *L. pulcherréntus* and *L. vestitus* are found as high as Mussourie; and *L. vigístrinus* and *L. cordifolius* lower down on the mountain side." (*Royle Illust.*, p. 235)

CHAP. LXIII.

OF THE HARDY LIGNEOUS PLANTS OF THE ORDER CAPRIFOLIA'CEÆ.

THIS order includes several genera of hardy ligneous plants, chiefly shrubs. They are commonly arranged in two sections, *Sambúccæ* and *Lonicœcœ*; and the following distinctive characters of the section and genera, taken from Don's *Miller*, will give an idea of the characteristics of the order:—

Sect. I. SAMBU`CEÆ Humb. et Kth.

Sect. Char. Corolla monopetalous, regular, rotate, with 5 segments only connected a little at the base; rarely tubular. Style wanting. Stigmas 3, sessile.

SAMBU`CUS Tourn. Limb of calyx 5-cleft. Corolla rotate, urceolate. Berry roundish, pulpy, 1-celled, 3—4-seeded, hardly crowned.

VIBU`RNUM L. Limb of calyx 5-cleft, permanent. Corolla rotate, subcampanulate, and tubular. Berry ovate or globose, 1-seeded from abortion; crowned by the calycine teeth.

Sect. II. LONICE`REÆ Brown.

Sect. Char. Corolla monopetalous, more or less tubular, usually irregular. Style filiform, crowned by three distinct, or concrete, stigmas.

DIERVILLA Tourn. Calyx bibracteate at the base, with an oblong tube, and a 5-parted limb. Corolla funnel-shaped, 3-cleft. Stigma capitate. Capsule oblong, not crowned, 1-celled, many-seeded. Seeds minute.

LONICE`RA Desf. Tube of calyx 5-toothed. Corolla tubular, funnel-shaped, or campanulate, with a 5-parted, usually irregular, limb. Stigma capitate. Berry 3-celled. Cells few-seeded.

LEYCESTERIA Wall. Calyx with an ovate tube, and a 5-parted irregular limb, ciliated with glands. Corolla funnel-shaped, with the tube gibbous at the base, and the limb 5-parted and campanulate. Stigma capitate. Berry roundish, 5-celled, crowned by the calyx. Cells many-seeded.

SYMPHORICARPOS G. Don. (*Symphoria Pers.*) Calyx with a globose tube, and a small 4—5-toothed limb. Corolla funnel-shaped, with an almost regular 4—5-lobed limb. Stigma semiglobose. Berry crowned by the calyx, 4-celled, two of them empty, and the other two containing 1 seed each. (*Don's Mill.*, iii. p. 436.)

Sect. I. SAMBU`CEÆ.

GENUS I.



SAMBU`CUS Tourn. THE ELDER. *Lin. Syst.* Pentándria Trigýnia.

Identification. Tourn. Inst., 376.; *Lin. Gen.*, No. 572.; *Gartn. Fruct.*, t. 27.; *Lam. Ill.*, t. 211.; *Schkuhr Handb.*, t. 83.; *Dec. Prod.*, 4. p. 321.; *Don's Mill.*, 3. p. 436.

Synonymy. *Phyteuma Lour. Coch.*, p. 138., but not of *Lin.*

Derivation. From *sambukē*, which the Latins have changed to *sambuca*, a musical instrument, which is believed to have been made of elder wood.

Gen. Char., &c. *Calyx* small, divided into 5 deep segments, permanent. *Corolla* rotate, urceolar, 5-lobed. *Lobes* obtuse. *Stamens* 5, about the length of the corolla. *Filaments* awl-shaped. *Anthers* roundish, heart-shaped. *Style* none. *Stigmas* 3, obtuse. Berry globular, pulpy, of 1 cell, containing 3—5 seeds, which are convex on the outside, and angular inside. (*Don's Mill.*, iii. p. 436.) — Low deciduous trees, natives of Europe and North America; ornamental for their compound leaves, and large terminal cymes of flowers; which are succeeded by purplish, red, white, or green berries, having cathartic properties, and from which a wine is made. All the species are of easy culture, in good soil, rather moist and loamy; and they are all readily propagated by cuttings.

A. Leaves pinnate. Flowers cymose or corymbose.

‡ 1. *S. NI`GRA* L. The common, or black-fruited, Elder.

Identification. *Lin. Sp.*, 285.; *Don's Mill.*, 3. p. 437., *Lodd. Cat.*, ed. 1836.

Synonymy. Bourtry, or Bour Tree, Arntree, *Scotch*; *Sureau, Fr.*; *Hollander, Ger.*; *Sambuco, Ital.*; *Sauco*, and *Sabuco, Span.*; *Flaeder, Swed.*; *Hylde, Dan.*

Engravings. N. Du Ham., 1. t. 55.; *Heyne Term. Bot.*, t. 32. f. 2.; *Engl. Bot.*, t. 476.; *Woodv. Med. Bot.*, t. 78.; *Fl. Dan.*, t. 545.; our *fig. 773.* and the plate of this species in Vol. 11.

Spec. Char., &c. Arboreous. Leaves pinnate.

Leaflets usually 5, smooth, deep green, ovate or oblong-oval, acuminate; the lower leaves sometimes trifoliate. Cymes with 5 main branches. Branches, after a year's growth, clothed with smooth grey bark, and filled with a light spongy pith. Flowers cream-coloured, with a sweet but faint smell. Berries globular, purplish black. Stalks reddish. (*Dou's Mill.*, iii. p. 437.) A low tree, in a wild state, growing from 20 ft. to 30 ft. high, and flowering in June. A native of Europe, and part of Asia, in hedges, coppices, and woods; and plentiful in Britain, in like situations, but probably not truly indigenous. The varieties are rare, except in gardens.



Varieties.

- ♣ *S. n. 2 virescens* Dec. Prod., iv. p. 322.; *S. virescens* Desf. *Arbr. Fr. i.* p. 348. — Fruit yellowish green.
- ♣ *S. n. 3 leucocarpa*. — Fruit white.
- ♣ *S. n. 4 laciniata*; *S. laciniata* Mill. *Dict.*, No. 2.; (*Lob. Icon.*, 2. t. 164. f. 2.; and our fig. 774.) the Parsley-leaved Elder; has the leaflets cut into fine segments.
- ♣ *S. n. 5 rotundifolia*. — Leaves trifoliate. Leaflets petiolate, roundish, serrated. Corymbs few-flowered. Cultivated in the Chelsea Garden.



- ♣ *S. n. 6 monströsa*, *S. monströsa Hort.*, has the branches striped. Flowers of from 5—15 parts; and with from 5—15 stamens. Stigmas 5—12. Berries irregular.
- ♣ *S. n. 7 foliis argenteis* (fig. 775.) has the leaves variegated with white, and forms a striking and lively-looking plant in a shrubbery.
- ♣ *S. n. 8 foliis luteis*, has the leaves slightly variegated with yellow.

Description, Geography, &c. The common elder forms a small tree, remarkable for its vigorous growth when young, and its stationary character after it has attained 20 or 30 years' growth, and as many feet high. Its ample cymes of cream-coloured flowers make a fine show in June, and its purplish black berries in September. It is observed by Sir J. E. Smith, that "our uncertain summer is established by the time the elder is in full flower; and entirely gone when its berries are ripe." It is a native of Europe, the north of Africa, and the colder parts of Asia, but not of America; and it is chiefly near human habitations. Dr. Walker, in 1780, thinks it is not indigenous in Scotland, and even that it had not been long introduced there; because he knew no instances of very old trees. It is common in all parts of England, in the neighbourhood of houses and gardens; and also in the woods of the temperate and southern parts of Russia. It is frequent in Greece,

and was formerly much employed in medicine there, as the space it occupies in the works of Theophrastus bears ample testimony. It has been known in England from the earliest period of our medicinal history, and has formed here, till lately, a rich source for medicaments to apothecaries and rustic practitioners. It still holds a conspicuous place in the European *materia medica*.

Properties and Uses. Medicinally, the berries make a useful and agreeable rob, of a slightly purgative quality, and very good for catarrhs, sore throats, &c. The inner bark is more actively cathartic, and is thought beneficial, in rustic ointments and cataplasms, for burns. The dried flowers serve for fomentations, and make a fragrant but debilitating tea, useful in acute inflammations, from the copious perspiration that it is sure to excite, but not to be taken habitually. An infusion of the leaves proves fatal to the various insects which thrive on blighted or delicate plants; although there is a species of aphid that feeds on the elder. Cattle will not eat these leaves; and the mole is driven away by their scent. It was formerly supposed that if turnips, cabbages, fruit trees, or corn, were whipped with branches of the elder tree, no insect would touch them. The flowers are considered, in many country places, injurious to turkeys, and the berries to poultry in general. The smell is said to be injurious to human beings, and Evelyn mentions a tradition, "that a certain house in Spain, being seated among elder trees, diseased and killed almost all the inhabitants, which, when at last they were grubbed up, became a wholesome place." The varieties with black berries are best for medical use. A wine is made of them, with spices and sugar, which is generally taken warm; and they are said frequently to enter into the composition of a less innocent beverage—artificial, or adulterated, port. (*Eng. Flor.*, ii. p. 110.) Elder rob is composed of the ripe fruit boiled with sugar, and is considered an excellent aperient for children; but an infusion of the leaves and young leaf buds is too strong a cathartic to be given, except in cases of great emergency. Besides the wine, or rather syrup, which is made from the juice of the ripe fruit, boiled with sugar and different kinds of spices, a wine is made from the flowers, which strongly resembles, in scent and flavour, that made of the Frontignan grapes. Elder flower water is used to give a flavour to some articles of confectionery, and is also considered excellent as a cooling lotion for the skin. The ancients used the fruit of the elder, in common with that of the mulberry, to paint the statue of Jupiter red, on the celebration of the fête of that god. They also employed the berries to dye the hair of their heads black; and Pliny says that the leaves, when boiled, are as wholesome to be eaten as those of other potherbs. The wood of the elder, when it becomes old, is very hard and adhesive, of a fine yellow, and susceptible of a high polish. In a dry state, it weighs 42 lb. 3 oz. to the cubic foot. It is employed by tanners, mathematical instrument makers, and comb-makers; and, generally, as a substitute for the box and the dogwood. The shoots, being large, and chiefly occupied by pith, are much employed by children in making tubes to serve as popguns, miniature muskets, and cannons; and for flutes, pipes, &c., a use to which they have been applied from time immemorial; "more shrill pipes and louder trumpets," Pliny informs us, being made of the shoots of the elder, than of those of any other tree. The pith, being very light, Miss Kent tells us, is formed into balls for electrical experiments. (*Syl. Sketches*, p. 125.) The bark is used in some parts of Scotland for dyeing tartans. Butchers' skewers and shoemakers' pegs are made of the wood, which splits readily longitudinally when fresh cut. The young shoots, when of three or four years' growth, are much employed in France, as props for vines and other plants, and are found to be of very considerable duration. The plant, both in Britain and on the Continent, is sometimes used for forming hedges, and also as a nurse plant for plantations exposed to the sea breeze. In the latter capacity, it has the great advantage of growing rapidly the first five or six years, and afterwards of being easily choked by the trees it has nursed up.

In the neighbourhood of London, the elder tree is much encouraged in the hedges of market-gardens, and in places that could not be profitably occupied by other fruit trees. There are also fields or orchards planted with the elder in different parts of Kent, entirely for the sake of its fruit, which is brought regularly to market, and sold in immense quantities for making wine. The price of these berries is from 4s. to 6s. a bushel; and the wine made from them is much drunk in cold weather, in London, by artisans, &c., mulled, as a cordial. It is also frequently brought to table hot, with strips of toasted bread, in farm-houses, after supper, during the winter.

The poetical allusions to this tree nearly all relate to mournful subjects, as it was considered by the ancients to be emblematical of death and sorrow; probably, because it was said to produce a narcotic stupor in those who slept beneath its shade, and sometimes to occasion death. It was also once supposed to be the tree Judas hanged himself on. (See p. 658.)

Soil, Situation, &c. The elder will not thrive except in a good soil, kept somewhat moist; and it will not flower and fruit abundantly, unless the situation be open, and fully exposed to the light and air. The plant roots so readily from cuttings and truncheons, that, where the soil is tolerably moist, a plantation may be made at once, by the use of the latter, instead of employing rooted plants.

Statistics. In the environs of London, there are some old elder trees in the orchards of farm-houses, and in the hedges of market-gardens; but we do not recollect to have seen any above 25 ft. high. In Kensington Gardens, and also at Purser's Cross, are trees upwards of 30 ft. high. In the Horticultural Society's Garden, there are plants which, in 10 years, have reached the height of 30 ft. In Pembrokeshire, at Golden Grove, a tree, 30 years planted, is 25 ft. high. In Rutlandshire, at Belvoir Castle, one, 25 years planted, is 24 ft. high. In Scotland, in Haddingtonshire, at Tynningham, a tree, 100 years planted, is 18 ft. high, the diameter of the trunk 10 in., and of the head 27 ft. In Fifeshire, in Danbristle Park, 12 years planted, it is 12 ft., and the diameter of the trunk 6 in. In Ireland, in Fermanagh, at Florence Court, 40 years planted, it is 50 ft. high, the diameter of the trunk 2 ft. 4 in., and of the head 30 ft. In Galway, at Cool, there is a tree 25 ft. high, the diameter of the trunk 1 ft., and of the head 22 ft.

2. *S. CANADENSIS* L. The Canadian Elder.

Identification. Lin. Sp., 385.; Don's Mill., 3. p. 436.; Lodd. Cat., ed. 1826.

Engravings. Schmidt Baum., 2. t. 142.; and our fig. 776.

Spec. Char., &c. Frutescent. Leaves pinnate or sub-pinnate. Leaflets about 4 pairs, and an odd one; oblong, oval, stiffish, acuminate, more or less pubescent beneath, sometimes appendiculated at the base. Cymes of 5 main branches. Flowers said to be almost scentless. Berries deep bluish black. (*Don's Mill.*, iii. p. 436.) A native of North America, from Canada to Carolina, in swamps and near hedges; and throughout Canada, as far as the Saskatchewan; where it forms a shrub, growing from 4 ft. to 6 ft. high. It was introduced in 1761, and flowers from July till August. It is not uncommon in collections; where it forms a bush, in foliage resembling the common elder, but it is less hardy, and never assumes any thing of a tree character. From the suffruticose character of the branches, and the comparative tenderness of the plant, it is only fit for dug shrubberies in favourable situations.



a. *Species of Sambucus belonging to this Subdivision, not yet introduced.*

S. palmensis Link (*Don's Mill.*, 3. p. 437.) is a native of the Island of Palma, in the Canaries, and a species of which very little is known.

S. mexicana Presl, *S. subalpina* Cham. et Schlecht., is a native of Mexico, with a suffruticose stem, and leaves rather hairy beneath.

S. peruviana H. B. et Kunth, *S. suaveolens* Willd., has an arboreous stem, with white flowers and black berries, like those of the common elder, of which it may possibly be only a variety. It is a native of Peru, on the Andes, in cultivated places, at the elevation of 4000 ft., where it grows from 12 ft. to 20 ft. high.

B. *Leaves pinnate. Flowers paniced.*

☞ 3. *S. RACEMOSA* L. The racemose-flowered Elder.

Identification. Lin. Sp., 386; Don's Mill., 3. p. 438; Lodd. Cat., ed. 1836.
Synonymes. *S. montana* Cam. Epit., 976; *S. cervini* Tabern., 1029; Lob. Icon., t. 163.
Engravings. Jacq. Icon. Rar., 1. p. 59; N. Du Ham., 1. t. 56; and our fig. 777.

Spec. Char., &c. Shrubby. Leaves pinnate.

Leaflets 5, membranous, oblong, acuminate, serrated, unequal at the base. Petioles glabrous. Panicle ovate. Leaves pale green, pretty smooth. Flowers of a whitish green colour. Fruit red or scarlet when ripe. (*Don's Mill.*, iii. p. 438.) A native of the middle and south of Europe and Siberia, on the mountains; where it forms a large shrub, or low tree, growing from 10 ft. to 12 ft. high. It was introduced in 1596, and flowers in April and May. This tree has a splendid appearance when covered with its panicles of fine, large, scarlet fruit. Captain S. E. Cook, who found it in abundance in Spain, informs us that the panicles of fruit resemble miniature bunches of grapes of the most brilliant scarlet; and that, when in perfection, he thinks it the most beautiful wild fruit he has ever seen. Its large leaves, with their deeply serrated pinnæ, are also very ornamental. It grows as freely as the common elder, and deserves a place in every collection; though it is very seldom found, in British gardens, of such a size as to display its beauty. We should think it would succeed if budded on the common elder; and, as that species is abundant in many places, plants might be trained to a single stem, and budded with *S. racemosa*, standard high. Price of plants, in the London nurseries, 1s. 6d. each; and at Bollwyller, 50 cents.



Variety.

☞ *S. r. 2 laciniata* Koch in Dec. Fl. Fr. Supp., p. 3000. — Leaflets jagged. A native of the Palatinate of the Rhine.

☞ 4. *S. (R.) PUBENS* Michx. The downy Elder.

Identification. Michx. Fl. Bor. Amer., 1. p. 181; Don's Mill., 3. p. 438.
Synonymes. *S. racemosa* Hook. Fl. Bor. Amer., 1. p. 279, but not of Lin.; *S. pubescens* Lodd. Cat.

Spec. Char., &c. Shrubby. Leaves pinnate. Leaflets 5, membranous, ovate-lanceolate or oblong, acuminate, serrated, pubescent, but chiefly on the under side. Panicle thyrsoid. Berries red. Flowers whitish. Closely resembling *S. racemosa*, of which it is probably a variety. (*Don's Mill.*, iii. p. 438.) It is a native from Carolina to Canada, on the highest mountains, as far as the Saskatchewan. There are plants in the Horticultural Society's Garden, and in the arboretum of the Messrs. Loddiges.

Variety.

☞ *S. (r.) p. 2 heptaphylla*. — Leaves larger than those of the species. Leaflets 7. Sir W. J. Hooker received specimens from the Rocky Mountains, and more especially from the Pacific, remarkable for the great size and length of their leaflets; and for there being almost constantly seven upon each rachis: but he says, "I do not find that these, or the eastern state of the plant, can in any way be distinguished from the European *S. racemosa*." (*Fl. Bor. Amer.*, i. p. 579) It is a native of North America, on the east side of the Rocky Mountains, and on the shores of the Columbia, near Fort Vancouver, and at its confluence with the sea.

C. *Leaves bipinnate.*

S. ebuloides Desf., Don's Mill., 3. p. 438; *Phyteuma bipinnata* Lour.; is a native of China, with suffruticose stems, white flowers, and perforated 3-celled fruit. Neither it, nor the following species, have yet been introduced.

S. phytumoides Dec. Prod., 4. p. 323; *Phyteuma cochinchinensis* Lour.; has suffruticose stems, and leaflets serrated and wrinkled, with small 1-seeded berries.

Three other species are described in Don's *Miller*, as natives of China and Japan, but requiring to be examined into, as it is not certain that they belong to the genus.

GENUS II.

**VIBURNUM L. THE VIBURNUM.** *Lin. Syst. Pentándria Trigýnia.*

Identification. *Lin. Gen.*, p. 370.; *Gært. Fruct.*, 1. t. 27.; *Adans. Fam.*, 2. p. 501.; *Schkuhr. Handb.*, t. 81.; *Dec. Prod.*, 4. p. 323.; *Don's Mill.*, 3. p. 438.

Synonymes. *O'pulus*, *Fibúrnum*, and *Tinus*, *Tourn. Inst.*, p. 607. t. 376. and 377.; *Fibúrnum* and *O'pulus*, *Mench Meth.*, p. 505.

Derivation. According to Vaillant, the word *Fibúrnum* is derived from the Latin word *vico*, to tie; on account of the pliability of the branches of some species. *Viburna*, in the plural, appears to have been applied by the ancients to any shrubs that were used for binding or tying.

Description, &c. Shrubs. Leaves opposite, petiolate. Corymbs of flowers terminal. Flowers usually white, but sometimes verging to rose colour. Natives of Europe, and of part of Asia; of easy culture and propagation in British gardens. *V. Lantana*, *V. O'pulus*, and *V. Tinus* are supposed to have been known to the Greeks and Romans. Virgil mentions the viburnum, and contrasts it with the tall cypress; but it is uncertain to what species he alludes. The genus was divided by Tournefort into three genera: *Fibúrnum*, *Tinus*, and *O'pulus*, which form our three sections.

§ i. *Tinus* Tourn.

Synonymes. *Lentágo* *Dec. Prod.*, 4. p. 324.; *Fibúrnum* *Mench Meth.*, p. 505.

Sect. Char., &c. Leaves quite entire, or toothed, style almost wanting; stigmas 3 sessile.

■ 1. *V. TINUS L. The Laurustinus.*

Identification. *Lin. Sp.*, 383.; *Dec. Prod.*, 4. p. 324.; *Don's Mill.*, 3. p. 438.; *Lodd. Cat.* ed. 1836.

Synonymes. *V. lauriforme* *Lam. Fl. Fr.*, 3. p. 363.; *Tinus* *Tourn. Inst.*, p. 607. t. 377.; *Tinus laurifolia* *Borkh. in Racm. Arch.*, 1. pt. 2. p. 20.; the Laurestine, wild Baie Tree, *Gerard*; *Viorne*, *Laurier*, *Tin*, *Fr.*; Lorbeerartiger Schneeball, or Schwalkenstrauch, *Ger.*

Derivation. *Laurustinus* is from *laurus*, a laurel, and *tinus*, the Latin name of the plant; the word *laurus* being added by old authors, from the supposition that this shrub belonged to the same family as the *Laúrus nobilis*, or sweet bay. *Lorbeerartiger* is laurel-like.

Engravings. *N. Du Ham.*, 2. t. 37.; *Bot. Mag.*, t. 38.; and our fig. 778.

Spec. Char., &c. Leaves ovate-oblong, quite entire, permanent; having the ramifications of the veins beneath, as well as the branchlets, furnished with glandular hairs. Corymbs flat. Flowers white, but rose-coloured before expansion, and sometimes afterwards for a little time. Berries dark blue. (*Don's Mill.*, iii. p. 438.) A native of the south of Europe, and north of Africa; where it is a shrub, growing from 8 ft. to 10 ft. high. It was introduced in 1596; and, in the neighbourhood of London, continues flowering from December till March.



778

Varieties.

■ *V. T. 2 hirta* Ait. *Hort. Kew.*, ii. p. 166.; *V. Tinus* *Mill. Dict.*, No. 4., *Clus. Hist.*, i. p. 49. No. 1.; *V. lucidum* *Mill.*, *Pers.*, and *Schultes, Clus. Hist.*, i. p. 49. No. ii. — Leaves oval-oblong, hairy beneath and on the margins. The flowers of this variety appear in autumn, and continue on the shrub all the winter. A native of Portugal and Spain, and the vicinity of Nice. This is very distinct, from the comparative roundness of its leaves, and the hairiness both of the leaves and branches.

■ *V. T. 3 lucida* Ait., l. c. — Leaves ovate-oblong, glabrous on both surfaces, shining. The cymes, as well as the flowers and leaves, are larger than those of the common sort, and seldom appear till the spring. When the winters are sharp, the flowers are killed, and

never open unless they are sheltered. This is quite a distinct variety, with fewer and more spreading branches than the common kind, and much larger leaves, which are shining. There is a subvariety of it with leaves more or less variegated with white. It is a native about Algiers, and on Mount Atlas. A plant of this variety, at Balruddery, the seat of the Earl of Meath, near Bray, was, in 1825, 10 ft. high, and 120 ft. in circumference. (*Dub. Phil. Journ.*, i. p. 438.)

- V. T. 4 *virgata* Ait., l. c., *Clus. Hist.*, No. iii., with a fig.—Leaves oblong-lanceolate, pilose on the margins, as well as on the under surface. It is a native of Italy, about Rome and Tivoli, &c.
- V. T. 5 *stricta* Hort. has a somewhat erect and fastigate habit. There is a handsome plant of this variety in the Horticultural Society's Garden, which, in 1835, was 6 ft. high. There is also a variegated subvariety.

Description, &c. The laurustinus, in its different varieties, forms tufted truly evergreen shrubs, prolific in flowers; and in airy situations on dry soils, where they have room to attain a large size, they become the most conspicuous ornaments of British gardens during winter and early spring. They do not thrive well in the smoke of cities; nevertheless they are to be seen nowhere finer than in the front gardens of small villas, from 5 to 20 miles from the metropolis; where they are in flower from November till April, and sometimes also during April, May, and June. Its blossoms are white, and so abundant as to give a gay appearance to the plants even in midwinter, an effect which is greatly heightened by the lively shining green of the foliage, and by the varied and picturesque forms of the compact tufting of the branches. These plants are admirably adapted for forming flower-garden hedges, and for varying the low iron palisades, pales, or brick walls, which separate the front gardens of street and suburban houses. The leaves, however, in these cases, should be removed as soon as they fall; as, when they dry, they have a remarkably fetid odour. In its native country, the laurustinus is invariably found in dry soils of some depth and substance; and it does not appear that it delights in the shade of other trees, like the common laurel, the holly, and the box. In British nurseries, it is frequently, for expedition's sake, increased by layers; but all the varieties are readily propagated by cuttings, taken off in autumn, and planted in a sandy soil, on a northern border. In two years, these cuttings will form saleable plants of the smallest size. The variety *V. T. lucida*, being somewhat more difficult to strike than the others, is generally increased by layers. Price of plants, in the London nurseries, from 6d. to 1s. each; at Bollwyller, from 50 cents to 2 francs.

A. Half-hardy Species of *Viburnum* belonging to the Section *Tinus*.

V. rugosum Pers., *V. Tinus* var. *stricta* Ait., *V. strictum* Link., *V. rigidum* Fcat., (*Bot. Reg.*, t. 376.; *Bot. Cab.*, t. 859. and our fig. 779.) is a frame shrub very like *V. Tinus*, but differing in the leaves, which are longer and hairy all over. It is a native of the Canaries; and was introduced in 1795; flowering from December to March. Trained against a wall, it grows to the height of 6 ft., and requires little or no protection.



§ ii. *Viburnum* Tourn.

Synonymes. Lentago *Dec. Prod.*, 4. p. 424.; *Viburnum Mench Meth.*, p. 505.

Sect. Char., &c. Leaves deciduous. All the flowers fertile, and equal in shape and size, except in *V. lantanoides*. Corolla rotate. Fruit oval.

№ 2. *V. LENTA'GO* L. The Lentago, or pliant-branched, *Viburnum*.

Identification. Lin. Sp., p. 384.; *Dec. Prod.*, 4. p. 325.; *Don's Mill.*, 3. p. 440.; *Lodd. Cat.*, ed. 1836. *Synonymes.* Tree *Viburnum*, Canada *Viburnum*; *Vierne à Rameaux pendans*, *Vierne luisante*, *Fr.*; *Birn Blätteriger Schneeball*, *Ger.*; *Canadische Schwalkenbeer Strauch*, *Schwalken Strauch*, *Hayne Engravings*. *Wats. Dend. Brit.*, t. 21.; *Schmidt Baum.*, 3. t. 176., ex *Rom. et Schultes Syst.*, 6. p. 637.; our fig. 780.; and the plate in Vol. II.

Spec. Char., &c. Leaves broad-ovate, acuminate, sharply serrated, glabrous. Petioles with narrow curled margins. Corymbs terminal, sessile. Flowers white. Fruit black. Serratures of leaves hooked a little, and somewhat cartilaginous. (*Don's Mill.*, iii. p. 440.) A native of North America, from New England to Carolina, among hedges and on the borders of woods; and found throughout Canada to the Saskatchewan; forming a shrub from 6 ft. to 10 ft. high. It was introduced in 1761, and flowers in July. In British gardens, it forms a robust shrub, or a handsome small tree, flowering freely, and producing abundance of fruit, which is greedily eaten by birds; and, from the smallness of its size, and other properties, this species is a very desirable one for the pleasure-grounds of small suburban gardens. It is propagated by layers, or by seeds; and the two following sorts appear to us to be nothing more than varieties of it. Price of plants, in the London nurseries, 1s. 6d. each; at Bollwyller, 1 franc; and at New York, 25 cents.



§ 3. *V. (L.) PRUNIFOLIUM L.* The Plum-tree-leaved Viburnum.

Identification. Lin. Sp., 383; Dec. Prod., 4. p. 325; Don's Mill., 3. p. 440; Lodd. Cat., ed. 1836.

Synonymy. *V. Lentago Du Roi.*

Engravings. Wats. Dend. Brit., t. 23; Pluk. Alm., t. 46. f. 2; N. Du Ham., 2. t. 38; and the plate of this species in Vol. II.

Spec. Char., &c. Leaves roundish-obovate and oval, glabrous, rather membranous, crenately serrated, ending in a short acumen. Petioles marginate, glabrous. Cymes sessile. Berries ovate or roundish. Flowers white, as in the rest of the species. Berries dark blue. (*Don's Mill.*, iii. p. 440.) It is a native of North America, from New England to Carolina, in hedges and fields; and also of Canada, about Lake Huron; where it forms a shrub, growing to the height of 8 ft. or 10 ft. It was introduced in 1731, and produces its flowers in May and June. In British gardens, it is generally a large shrub, or, when trained to a single stem, a very handsome small tree, of considerable durability. Price of plants as in *V. Lentago*; and imported American seeds are 1s. per packet.

§ 4. *V. (L.) PYRIFOLIUM Poir.* The Pear-tree-leaved Viburnum.

Identification. Poir. Diet., 5. p. 678; Dec. Prod., 4. p. 325; Don's Mill., 3. p. 440; Lod. Cat., 1836.

Engravings. Dend. Brit., t. 22; and our figs. 781. and 782.

Spec. Char., &c. Leaves ovate, aentish, glabrous, subserrated. Petioles smooth. Corymbs somewhat pedunculate. Flowers white. Berries ovate-oblong and black.



Resembles the preceding species, but is not so straggling in its growth. (*Don's Mill.*, iii. p. 440.) A shrub, growing to the height of from 5 ft. to 8 ft.; a native of Pennsylvania, New Jersey, &c., on the banks of rivers; and flowering in May and June. Introduced in 1812, and frequent in collections.



§ 5. *V. (L.) NU'DUM L.* The naked-corymbed Viburnum.

Identification. Lin. Sp., 383; Dec. Prod., 4. p. 325; Don's Mill., 3. p. 440; Lodd. Cat., ed. 1836.

Synonymy. *V. pyrifolium Poir.*

Engravings. Wats. Dend. Brit., t. 20; Mill. Icon., 274; and our fig. 783.

Spec. Char., &c. Leaves oval-oblong, angular at the base, bluntish, with revolute obsolete crenulated margins, quite glabrous. Petioles beset with scale-like scurf or down. Corymbs pedunculate, not involucrate. Flowers whitish. Berries globose, black, or dark blue. (*Don's Mill.*, iii. p. 440.)

A native of North America, from Canada to Georgia, in swamps, particularly on a sandy soil; found about Quebec, and on the banks of the Saskatchewan, and of Newfoundland; and forming a shrub, growing from 6 ft. to 10 ft. high, and producing its flowers in May and June. Introduced in 1752. Sir W. J. Hooker says of this species, that he cannot satisfy himself of permanently distinguishing characters between it and *V. Lentago* and *V. prunifolium*.



783

Variety.

♣ *V. (L.) n. 2 squamatum*; *V. squamatum* Willd. *Enum.*, *Wats. Dend. Brit.*, t. 24.; and our fig. 784.; has the surface, midribs, and petioles of the leaves scaly (whence its name), and their margins crenate, subdentate. The peduncles and pedicels are also covered with minute ferruginous scales; and the leaves are smaller, and of a bluer green than those of *V. nudum*.



784



♣ 6. *V. CASSINOIDES* L. The Cassine-like Viburnum.

Identification. Lin. Sp., p. 384.; Dec. Prod., 4. p. 326.; Don's Mill., 3. p. 440.; Lodd. Cat., ed. 1836.
Synonymy. *V. punctatum* Rafin.

Spec. Char., &c. Leaves ovate-lanceolate, acute at both ends, crenate, glabrous above, with subrevolute edges. Under side of leaves, as well as the petioles, which are keeled, and branches, which are tetragonal, covered with scurfy dots. Corymbs sessile. Flowers white. Berries ovate, and bluish black. (*Don's Mill.*, iii. p. 440.) A native of North America, from New York to Carolina, in swamps; where it forms a shrub growing to the height of from 3 ft. to 5 ft. high, and flowering in June and July. It was introduced in 1761; and, in British gardens, attains the height of 10 ft. or 12 ft.; forming a handsome durable shrub, which increases slowly in size after it is 5 ft. or 6 ft. high. There are plants in the Horticultural Society's Garden, and at Messrs. Loddiges.

♣ 7. *V. (C.) LEVIGATUM* Willd. The smooth Viburnum.

Identification. Willd. Sp., 1. p. 1491.; Dec. Prod., 4. p. 326.; Don's Mill., 3. p. 440.
Synonymy. *V. cassinoides* Du Roi *Harbk.*, 2. p. 486.; *V. lanceolatum* Hill, *Hort. Kew.*, t. 19.; *Cassine paragua* Lin. *Mant.*, 220.; *Cassine corymbosa* Mill. *Icon.*, t. 83. f. 1.
Engraving. Mill. *Icon.*, t. 83. f. 1.

Spec. Char., &c. Leaves lanceolate, or oblong-lanceolate, smooth, remotely or unequally serrated, cuneate at the base, and quite entire, glabrous. Branches tetragonally 2-edged, and also glabrous. Corymbs sessile. Flowers white. Berries black. (*Don's Mill.*, iii. p. 440.) A native of Virginia and Carolina, near the sea coast; where it forms a shrub, growing to the height of from 10 ft. to 14 ft., and flowering in June and July. It was introduced in 1724; and, in British gardens, is commonly left to take the form of a robust bulky shrub; but it may readily be trained into a handsome small tree. Culture the same as that of the preceding species.

♣ 8. *V. LANTANA* L. The Wayfaring Tree.

Identification. Lin. Sp., p. 384.; Dec. Prod., 4. p. 326.; Don's Mill., 3. p. 440.
Synonymy. *V. tomentosum* Lam. *Fl. Fr.*, 3. p. 363.; wild Guelder Rose, plant-branched Mealy Tree; Viorne cotoneuse, Camara, Viorne commune, Coudre-moinsinne, Mucienne, *Fr.*; Schlingstrauch, wolliger Schneeball, or Schwalkenstrauch, *Ger.*; Lentaggine, *Ital.*
Engravings. Smith *Eng. Bot.*, t. 331.; Jacq. *Austr.*, t. 341.; Cam. *Epit.*, 122.; Du Ham. *Arb.*, 2. t. 103.; Lob. *Icon.*, 2. t. 106.; and our fig. 785.

Spec. Char., &c. Leaves cordate, rounded, finely serrated, veiny, clothed beneath, but more sparingly on the upper side, with starry mealy pubescence, like that on the branches, petioles, and peduncles. Cymes pedunculate, broad, flat, of numerous crowded white flowers. Bractees several, small, acute. A low tree with copious, opposite, round, pliant, mealy branches. Under side of leaves and branches white from mealy down. Berries compressed in an early state, red on the outer side, yellow, and finally black, with a little mealy astringent pulp. (*Don's Mill.*, iii. p. 441.)



Varieties.

- ♁ ♀ *V. L. 2 grandifolia* Ait., *V. L. latifolia* Lodd. *Cat.*, has leaves larger than those of the species, and, according to some, ought to constitute a separate species itself. (See No. 10.)
- ♁ ♀ *V. L. 3 foliis variegatis* Lodd. *Cat.* has leaves variegated with white and yellow.

Description, &c. A shrub, or low tree; a native of Europe and the West of Asia, in low woods and hedges, and chiefly on calcareous soils. In a state of culture, in good free soil, it forms a handsome, durable, small tree, 18 ft. or 20 ft. in height; with large broad leaves, and ample heads of white flowers, which are succeeded by fruit, at first green, afterwards red, and finally black. The fruit is greedily eaten by birds, is not unpleasant to the taste, and is considered by some as refreshing and astringent. The leaves, in autumn, die off of a fine deep red colour. Dr. Withering says that the bark of the root is used to make birdlime. The tree grows rapidly when young, often producing shoots 5 ft. or 6 ft. long, from stools in coppice woods; but becoming stationary when it has attained the height of 12 ft. or 15 ft., which it does in 5 or 6 years. In Germany, the shoots of one year are employed in basket-making, and for tying faggots and other packages; and those of two or three years old are used for tubes to tobacco-pipes. The wood is white and hard, and may be employed for various purposes in turning and cabinet-making. In Switzerland, the fruit is used for making ink. The following beautiful lines on this tree are by William Howitt.

“ Wayfaring tree! what ancient claim
Hast thou to that right pleasant name?
Was it that some faint pilgrim came
Unhopedly to thee,
In the brown desert's weary way,
Mid toil and thirst's consuming sway,
And there, as 'neath thy shade he lay,
Blest the wayfaring tree.”

“ Or is it that thou lovest to show
Thy coronets of fragrant snow,
Like life's spontaneous joys that flow
In paths by thousands beat?
Whate'er it be, I love it well;
A name, methinks, that surely fell
From poet, in some evening dell,
Wandering with fancies sweet.”

Book of the Seasons, p. 115.

Plants may be raised from seed, which may be procured in abundance from coppices and hedges, and, to save room, should be laid up in a heap in the rotting-ground, like haws; for, if sown immediately after being gathered, they will not come up for 18 or 20 months.

♁ ♀ 9. *V. (L.) LANTANÖIDES Michx.* The Lantana-like Viburnum, or *American Wayfaring Tree.*

Identification. Michx. *Fl. Bor. Amer.*, 1. p. 179.; Dec. *Prod.*, 4. p. 326.; Hook. *Fl. Bor. Amer.*, 1. p. 280.; Lodd. *Bot. Cab.*, t. 1070.; Don's *Mill.*, 3. p. 441.
Synonymes. ? *V. Lantana* β *grandifolia* Ait. *Hort. Kew.*, ed. I., vol. 1. p. 392.; *V. grandifolium* Smith in Rees's *Cycl.*, No. 14.; *V. Lantana* β *canadensis* Pers. *Ench.*, 1. p. 327.; Hobble Bush, Amer.

Engravings. Bot. *Cab.*, t. 1070.; and our *fig.* 786.

Spec. Char., &c. Leaves roundish-cordate, abruptly acuminate, unequally serrated; serraturesawnless. Branches, petioles, and nerves of leaves clothed with powdery tomentum. Corymbs terminal, almost sessile. Fruit ovate. (*Don's Mill.*, iii. p. 441.) The outer flowers of the corymbs are abortive and radiant; a circumstance, as Sir W. J. Hooker observes, noticed by few botanists. The berries are at first red, but at length become black. In North America, it is known by the name of *hobble bush*. It is very like *V. Lantana*, but is of more humble growth, and the leaves are larger, and tomentose. A shrub, a native of North America, from Canada to Carolina, principally in the forests called Beech Woods, about Quebec and Lake Huron; and flowering in June and July. In general appearance, it so closely resembles *V. Lantana*, as to leave little doubt in our minds of its being only a variety of it. There are plants in the Horticultural Society's Garden, and in Messrs. Loddiges's arboretum.

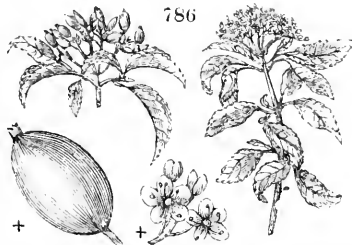

☞ 10. *V. (L.) DAHURICUM* Pall. The Dahurian Viburnum.

Identification. Pall. Fl. Ross., p. 52; Dec. Prod., 4. p. 328.; Don's Mill., 3. p. 442.; Lodd. Cat., ed. 1836, *Synonymes.* *Lonicera mongolica* Pall. Fl. Ross., 1. t. 38. f. t. 58. f. F. G., Gmel. Sib., 3. t. 25.; *Cotinus diarica* Lam. *Engravings.* Pall. Fl. Ross., t. 33., and t. 58. f. F. G.; Gmel. Sib., 3. t. 25.

Spec. Char., &c. Leaves ovate, somewhat cordate at the base, crenately serrated, beset with stellate down, as well as the branchlets. Corymbs dichotomous, few-flowered. Corollas tubular, somewhat funnel-shaped, bluntly 5-toothed. Berry 5-seeded (ex *Pall.*, ed. 1.); 1-seeded, at first red, but at length becoming black and sweet (ex *Pall.*, ed. 2.). Allied to *V. Lantana*. Flowers yellowish white. (*Don's Mill.*, iii. p. 443.) A shrub, growing to the height of from 6 ft. to 8 ft.; a native of Dahuria, and introduced in 1785. There are plants in the Horticultural Society's Garden, and in the arboretum of Messrs. Loddiges.

☞ 11. *V. (?L.) COTINIFOLIUM* D. Don. The Cotinus-leaved Viburnum.

Identification. D. Don Prod. Fl. Nep., 1. p. 141.; Dec. Prod., 4. p. 327.; Don's Mill., 3. p. 441. *Engravings.* Bot. Reg., t. 1650.; and our fig. 787. from the plant in the Horticultural Society's Garden, and fig. 788. from the Bot. Reg.

Spec. Char., &c. Leaves roundish oval, quite entire, clothed with stellate tomentum on both surfaces, grey beneath, as well as the branches. Corymbs terminal, woolly. Flowers white. (*Don's Mill.*, iii. p. 441.) A shrub, a native of Nepal, at Sirinagur, which is common in the Himalayas, at the height of from 5000 ft. to 7000 ft., 30° N. lat. Introduced into British gardens in 1832, or before; and flowering in the Horticultural Society's Garden in April and May. In general appearance it closely resembles *V. Lantana*; but the flowers are much larger, and more

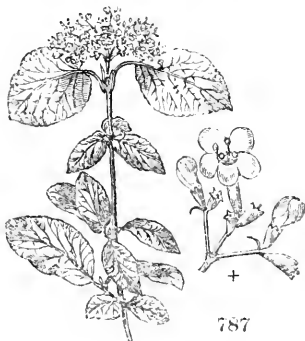

tinted with pink; and neither flat nor bell-shaped, but of a distinct obconical figure. (*Bot. Reg.*, t. 1650.) Notwithstanding these points of difference, we still think it only a variety of *V. Lantana*.

❖ 12. *V. DENTATUM* Lin. The toothed-leaved Viburnum.

Identification. Lin. Sp., p. 384; Dec. Prod., 4. p. 326; Don's Mill., 3. p. 441; Lodd. Cat., ed. 1836. *Synonymes.* *V. dentatum lucidum* Ait. Hort. Kew., 1. p. 372; *V. dentatum glabellum* Michx. Fl. Bor. Amer., 1. p. 179; Arrow-wood; Viorne dentée, Fr.

Engravings. Jacq. Hort. Vind., 1. t. 36; Wats. Dend. Brit., t. 85; and our figs. 789. and 790.

Spec. Char., &c. Partly glabrous. Leaves ovate, and nearly orbicular, plicate, coarsely and dentately serrated, with the nerves thick and feathered, glabrous on both surfaces. Cymes or corymbs pedunculate. Berries small, and nearly globose, of a dark blue colour, and crowned by the calyx. In North America, the tree is known by the name of arrow-wood. (*Don's Mill.*, iii. p. 441.) A shrub, a native of North



789

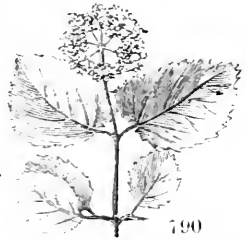

790

America, found from New York to Carolina, in mountain woods; and also in Mexico, where it attains the height of 4 ft. or 6 ft., and flowers in June and July. It was introduced in 1763; and, though it flowers in British gardens, it does not very frequently ripen fruit there.

Varieties. In the arboretum of Messrs. Loddiges, are plants named *V. d. pubescens*, *V. d. foliis variegatis*, *V. acuminatum*, *V. longifolium*, and *V. montanum*, which are either varieties of, or identical with, this species.

❖ 13. *V. (D.) PUBESCENS* Pursh. The downy Viburnum.

Identification. Pursh. Fl. Amer. Sept., 1. p. 272; Dec. Prod., 2. p. 323; Don's Mill., 3. p. 441. *Synonymes.* *V. dentatum 2 pubescens* Ait. Hort. Kew., 1. p. 178; *V. dentatum semi-tomentosum* Michx. Fl. Bor. Amer., 1. p. 179; *V. tomentosum Rafin. Med. Rep.*, 2. p. 399; *V. villosum Rafin. in Desc. Journ.*, 1. p. 228; *V. Rabine-quanum* Schultes Syst., 6. p. 650.

Spec. Char., &c. Pubescent. Leaves ovate, acuminate, on short petioles, coarsely serrate-toothed, villous beneath, with the nerves feathered and prominent. Corymbs pedunculate. Fruit small, ovate. Flowers white. This shrub is smaller in every part than *V. dentatum*. (*Don's Mill.*, iii. p. 441.) A shrub, 3 ft. high; a native of Virginia and Carolina. Introduced in 1736, and flowering in June and July.

❖ 14. *V. (D.) NITIDUM* Ait. The shining-leaved Viburnum.

Identification. Ait. Hort. Kew., 1. p. 271; Pursh. Fl. Amer. Sept., 1. p. 292; Dec. Prod., 4. p. 326; Don's Mill., 3. p. 440.

Spec. Char., &c. Quite glabrous. Leaves linear-lanceolate, shining above, obsolete serrated or entire. Branches tetragonal. A low shrub, with small leaves. Flowers white. (*Don's Mill.*, iii. p. 440.) It is a native of Carolina and Georgia, in sandy barren woods; where it forms a shrub, growing from 2 ft. to 4 ft. high; flowering in May and June. Introduced in 1758.

A. *Hardy Species of Viburnum belonging to the Section Viburnum, not yet introduced.*

V. punctatum Hamilt. in D. Don. Prod. Fl. Nep., p. 142., is a native of Nepal, with oval-oblong leaves.

V. acuminatum Wall. Dec. Prod., 4. p. 327. is a native of the Neelgherry Mountains, with elliptic leaves, closely resembling those of the preceding species.

V. ellipticum Hook. Fl. Bor. Amer., 1. p. 280., is a native of North America, on the banks of the Columbia, growing to the height of 4 ft., with elliptic leaves, about 2 inches long.

V. neriosum D. Don. Prod. Fl. Nep., p. 141., is a native of Nepal, closely resembling *V. Lantana*.

V. cordifolium Wall. Dec. Prod., 4. p. 327., is a native of Nepal, with heart-shaped acuminate leaves, 4 in. long, and 2 in. broad.

V. Mullaha Ham. in D. Don. Prod. Fl. Nep., p. 141., is a native of Nepal, with ovate-acuminate leaves.

V. stellatum Wall. Dec. Prod., 4. p. 327., is a native of Nepal, with ovate-cordate leaves, and scarlet berries. It grows to the height of 20 ft.

V. involucratum Wall. Dec. Prod., 4. p. 327. has ovate-acuminate leaves, and is also a native of Nepal, where it grows to the height of from 4 ft. to 6 ft.

V. opusum Thunb. Fl. Jap., p. 14., has broad ovate-acuminate leaves; and, in Japan, is a shrub from 4 ft. to 6 ft. high.

B. Half-hardy Species of *Viburnum*: belonging to the Section *Viburnum*.

V. odoratissimum Ker, *F. sinense* Zeyh., *Coffea* monosperma Hook. et Arn. Bot. Bez., t. 466; and our fig. 791. The leaves are evergreen, glabrous, and coriaceous; and the flowers white, with the scent of those of *Olea fragrans*. The berries are red when they begin to ripen, but at length they become blackish and shining; they are 1-seeded, and crowned by the lobes of the calyx which are erect. It is a native of China, whence it was introduced in 1813, and flowers in February. It thrives against a wall, where the soil is dry, and sufficient protection is given during winter. Plants have stood out in Colvill's Nursery, King's Road, at Kew, at Syon, and in the Horticultural Society's Garden, for several years; and, though their branches are frequently injured by the frost, they never fail to spring up vigorously with the return of summer.

V. edulis Swartz., Don's Mill., iii. p. 441, has the leaves ovate, acuminate, quite entire. It is a shrub, growing to the height of 5 ft. or 6 ft., a native of the south of Jamaica, on the mountains; and introduced in 1824. This species agrees with *V. Tinus* in the leaves being entire, and in the tomentum with *V. Lantana*.

V. monogynum Blum., Don's Mill., iii. p. 442, has the leaves elliptic-oblong, attenuated at both ends, glandularly denticulate above the base, paler beneath. Corymbs divaricate, terminal, downy. Flowers monogynous. A shrub, a native of Java, in woods on the mountains, said to be nearly allied to *V. erleum*.

791



iii. *Opulus* Tourn.

Identification. Tourn. Inst., t. 373; Dec. Prod., 4 p. 328; Mönch Meth. p. 67

Sect. Char. Outer flowers of the corymbs radiant and sterile, much larger than the rest, which are fertile. Seed obcordate. (Don's Mill., iii. p. 442.) Leaves mostly 3-lobed, and deciduous.

15. *V. OPULUS* L. The Guelder Rose.

Identification. Lin. Sp., 384; Dec. Prod., 4 p. 328; Don's Mill., 3 p. 442; Lodd. Cat., ed. 1806.

Synonymes. *V. lobatum* Lam. Fl. Fr., 3 p. 163; *Opulus glandulosa* Marckh. Mem., p. 305; *Opulus Rast* Syn., 460; Du Ham. Arb., 2. t. 16; *Sambucus aquatica* Broth. Pin., 466. *Trag. Hist.*, 1092. *Mat. Vulg.*, 3. p. 67; Marsh. Eder, Rose Eder, Water Eder; *Viorne-Obier*, l'Obier d'Europe, Fr.; *Schwalkenbeer Strauch*, *Wasserholder*, *Schneeball*, Ger.

Derivation. Altered from *Pepulus*, the poplar, from some supposed resemblance between the leaves of the plants, and those of the poplar.

Encroachment. Engl. Bot., t. 322; Hayn. Term., t. 32. l. 4; Du Ham. Arb., 2. t. 16; N. Du Ham., 2. t. 32; and our fig. 792.

Sect. Char., &c. Quite glabrous in every part. Leaves broad, 3-lobed, acuminate, unequally serrated, veiny. Petioles beset with glands towards the top, and several oblong leafy appendages lower down. Cymes pedunculate, white, with linear bracteas; with several of the marginal flowers dilated, flat, radiant, and without stamens or pistils. Berries elliptical, bright red, very juicy, but bitter and nauseous. Seed compressed. Branches smooth, green. Leaves bright green in summer, but in autumn assuming a beautiful pink or crimson hue, like other European species of genera that are principally American; such as *Cornus*, *Rhus*, *Quercus*, &c.; and of which the American species have the same quality.

Flowers white. Berry crowned by the limb of the calyx. (Don's Mill., iii. p. 442.) A shrub, or low tree, growing to the height of from 6 ft. to 12 ft., in a wild state, and higher in gardens. It is found throughout Europe, and part of Asia, in moist hedges and swampy thickets; flowering in May and June. It is frequent in Britain, and also in Sweden, as far north as lat. 61°.

Varieties.

1. *V. O. 2 sterilis* Dec. Prod., iv. p. 328; Don's Mill., iii. p. 442; *V. O.*

792

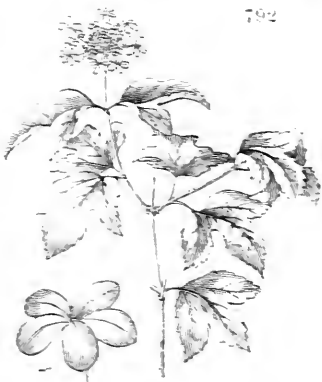

roëum *Rœm. et Schult. Syst.*, vi. p. 635., and *Lodd. Cat.*, ed. 1836. *Knor. Del.*, ii. t. 5. and 6. The Snow-ball Tree, or Guelder Rose; Rose de Gueldres, Pellotte de Neige, Boule de Neige, Poire molle, *Fr.*; Schneeballe, *Ger.*—The specific name *roëum* is applied on account of the form of the flowers, and not because of their colour. ♁ *V. O. 3 foliis variegatis* *Lodd. Cat.*, ed. 1836, has the leaves variegated with white and yellow.

Description, &c. The Guelder rose, in a wild state, is not remarkable for the beauty of its flowers; but its bright red berries, which ripen in September, and which, towards the middle of October, assume a beautiful pink, almost compensate for the inferiority of the species to the variety in point of flowers. The leaves of both die off of a fine red on the first approach of frost. The snow-ball tree, or the Guelder rose (*V. O. 2 stérilis*), is supposed to have originated in the Low Countries, in Guelderland, whence its name; though Gerard, speaking of it, says, "It groweth in gardens, and the flowers are there doubled by art, as it is thought." Whatever may be the origin of this variety, it certainly forms one of the most ornamental shrubs, or low trees, that can be planted in a pleasure-ground: "le plus éclatant qu'on connoisse," as it is said in the *Nouveau Du Hamel*. In a shrubbery, as Cowper beautifully describes it, the Guelder rose has a striking appearance, rising

— " tall,
And throwing up into the darkest gloom
Of neighbouring cypress, or more sable yew,
Her silver globes, light as the foamy surf
That the wind severs from the broken wave."

On the lawns of small gardens, and trained up with a single stem, it forms one of the most splendid of small trees; coming into flower soon after the scarlet hawthorn, the Scotch laburnum, and the purple lilac. The fruit of the species is eaten in Sweden; where, and in Russia, the young shoots are made into tubes for tobacco-pipes, and handles for whips. Pallas informs us that, in Siberia, the berries are fermented with flour, and a spirit distilled from them; or made into a paste with honey and flour, and eaten as food, though the pulp and juice of the berry have a very fetid odour. In British gardens, the species is propagated by seed, and the variety by layers. The price of plants is the same as for *V. Lantana*.

♁ 16. *V. (O.) ACERIFOLIUM* L. The Maple-leaved Guelder Rose.

Identification. *Linn. Sp.*, 383; *Pursh Fl. Sept. Amer.*, 1. p. 503.; *Dec. Prod.*, 4. p. 327.; *Hook. Fl. Bor. Amer.*, 1. p. 280.; *Don's Mill.*, 3. p. 442.

Engravings. *Vent. Hort. Cels.*, t. 72.; *Wats. Dend. Brit.*, t. 118.; and our fig. 793.

Spec. Char., &c. Branchlets and petioles pilose. Leaves ovate-cordate, usually 3-lobed, acuminate, sharply and loosely serrated, downy beneath. Petioles glandless, and, when young, stipulaceous at the base, and rather tomentose. Corymbs terminal, pedunculate, not radiant. Flowers white. Berries black, oval, and compressed. (*Don's Mill.*, iii. p. 442.) A native of North America, from New England to Carolina, in rocky mountainous situations; where it forms a shrub from 4ft. to 6 ft. high, flowering in May and June. It was introduced in 1736; and, judging from the plants in the Horticultural Society's Garden, and at Messrs. Loddiges's, it appears to be only a variety of *V. Opulus*.



♁ 17. *V. (O.) ORIENTALE* Pall. The Eastern Guelder Rose.

Identification. *Pall. Ross.*, t. 58. f. H.; *Dec. Prod.*, 4. p. 323.; *Bieb. Fl. Taur.*, 1. p. 245.; *Don's Mill.*, 3. p. 442.

Synonymy. *Opulus orientalis folio amplissimo tridentato Tourn. Cor.*, p. 42.

Engraving. *Pall. Fl. Ross.*, t. 58. f. H.

Spec. Char., &c. Leaves 3-lobed, acuminate, coarsely and bluntly toothed. Petioles glandless, glabrous. Corymbs terminal, not radiant. Fruit oblong, compressed. Flowers white. Seed oval, furnished with two channels on both sides, as in *V. Lantana*. Very like the preceding species.

(*Don's Mill.*, iii. p. 442.) A native of Georgia, in Asia Minor, in woods, on the mountains, &c.; where it forms a shrub growing to the height of from 6 ft. to 10 ft., flowering in July. It was introduced in 1827; but we have not seen a plant.

♣ 18. *V. (O.) Oxycoccus Pursh.* The Cranberry-fruited Guelder Rose.

Identification. Pursh. *Fl. Amer. Sept.*, 1. p. 203.; *Dec. Prod.*, 4. p. 328.; *Don's Mill.*, 3. p. 442.

Synonymes. *V. opuloides Mühl. Cat.*, 32.; *V. trilobum Marsh. Arb.*, p. 162.; *V. Opulus americana Ait. Hort. Kew.*, 1. p. 373.

Spec. Char., &c. Leaves 3-lobed, acute behind, 3-nerved. Lobes divaricate, acuminate, coarsely and distantly serrated. Petioles glandular. Cymes radiant. Flowers white. Berries subglobose, red, of an agreeable acid, resembling that of cranberries, for which they are a very good substitute. Very like the *V. Opulus* of Europe. (*Don's Mill.*, iii. p. 442.) A native of North America, on the mountains of New York and New Jersey, and throughout Canada, to the arctic circle; from Hudson's Bay to the Rocky Mountains, in swamps and shady woods; where it grows to the height of from 6 ft. to 12 ft., and flowers in July. In British gardens this species is commonly seen as a bush; and at Syon and Kew, and other places in the neighbourhood of London, there are plants of it 12 ft. high and upwards; but, if it were planted by itself on a lawn, or in an arboretum, and trained to a single stem, it would form a very handsome small tree, conspicuous in July from the abundance of its white flowers, and in September from its large bunches of red fruit.

Variety.

♣ *V. (O.) O. 2 subintegrifolius Hook.* *Fl. Bor. Amer.*, i. p. 281., *Don's Mill.*, iii. p. 442. — Leaves but little cut, very pubescent beneath. A native of the banks of the Columbia.

♣ 19. *V. (O.) EDULE Pursh.* The edible-fruited Guelder Rose.

Identification. Pursh. *Fl. Bor. Amer.*, 1. p. 203.; *Dec. Prod.*, 4. p. 328.; *Don's Mill.*, 3. p. 442.

Synonyme. *V. Opulus edulis Michx. Fl. Bor. Amer.*, 1. p. 180.

Spec. Char., &c. Leaves 3-lobed, bluntish behind, and 3-nerved. Lobes very short, denticulately serrated; serratures acuminate. Petioles glandular. Outer flowers of corymb radiant. A smaller and more upright shrub than the preceding species. The berries of the same colour and size; but, when completely ripe, more agreeable to eat, and frequently employed as a substitute for cranberries. It does not seem to differ much from *V. Oxycoccus*, except in the broader base of the leaf. (*Don's Mill.*, iii. p. 442.) A native of North America, from Canada to New York, on the banks of rivers; where it forms a shrub from 5 ft. to 10 ft. in height, flowering in July. It was introduced in 1812.

♣ 20. *V. (O.) MO'LLÉ Michx.* The soft-leaved Guelder Rose.

Identification. Michx. *Fl. Bor. Amer.*, 1. p. 180.; *Dec. Prod.*, 4. p. 328.; *Don's Mill.*, 3. p. 442.

Synonyme. *V. alnifolium Marsh. Arb.*, p. 162.

Spec. Char., &c. Leaves nearly orbicular, cordate, plicate, toothed, rather tomentose beneath from very soft down. Petioles rather glandular, corymbs radiant. Fruit oblong-ovate. Flowers white. Berries red. Bark deciduous. Very like *V. Oxycoccus*, and, perhaps, only a variety of it. (*Don's Mill.*, iii. p. 442.) A native of North America, in Kentucky, near Danville, Tennessee, and Upper Carolina, in hedges; where it forms a shrub growing to the height of from 6 ft. to 12 ft., and flowering in June and July. It is said to have been introduced in 1812; but we have never seen a plant of it.

A. *Species of Viburnum belonging to the Section Opulus, not yet introduced.*

V. microcarpum Cham. et Schlecht. in Linnæa, 5. p. 170., is a native of South Mexico, with leaves like those of a filbert, and black fruit.

V. polycarpum Wall. (*Don's Mill.*, 3. p. 433.) is a native of Nepal, with cordate leaves, 4—5 in. long, and 3 in. broad, growing to the height of 6 ft. to 8 ft.

V. cylindricum Ham. in D. Don *Prod. Fl. Nep.*, p. 142., is a native of Nepal, with the habit of *V. nudum*, and the flowers of *V. dahuricum*.

V. grandiflorum Wall. (*Dec. Prod.*, 4. p. 329.) is a native of Nepal, with elliptic, acuminate leaves, in terminal bracteate corymbs.

V. erubescens Wall. (*Dec. Prod.*, 4. p. 329.) is a native of Nepal, very nearly allied to the preceding species.

V. coriaceum Blum. Bijdr., p. 656., *Don's Mill.*, 3. p. 443., has ovate, acuminate, denticulate leaves, and terminal fistigiate corymbs. It is a native of Java, in woods on the higher mountains.

Several other species are enumerated in *Don's Miller*, p. 443., as being natives of Japan, but not sufficiently known.

Sect. II. LONICERÆ.

GENUS III.



DIERVILLA Tourn. THE DIERVILLA. *Lin. Syst.* Pentándria Monogýnia.

Identification. Tourn. Act. Ac. Par., 1706, t. 7. f. 1.; *Lin. Hort. Cliff.*, p. 63. t. 7.; *Juss. Gen.*, 211.; *Dec. Prod.*, 4. p. 330.

Synonymes. *Lonicera* sp. *Lin. Gen.*; *Weigela* Thunb. *Fl. Jap.*, p. 6.; *Weigelia* Pers. *Ench.*, 1. p. 176., ex R. Br. in *Wall. Pl. Asiat.*, 1. p. 15.

Derivation. Named by Tournefort, in compliment to *M. Dierville*, a French surgeon, who was the first to introduce *D. canadensis* into Europe.

Description, &c. Erect deciduous shrubs, of easy culture.

♣ 1. *D. CANADENSIS* Willd. The Canadian Diervilla.

Identification. Willd. *Enum.*, 1. p. 222.; *Dec. Prod.*, 4. p. 330.; *Don's Mill.*, 3. p. 444.

Synonymes. *Lonicera* Diervilla *Lin. Mat. Med.*, p. 62., *Sims Bot. Mag.*, 1796.; *D. Tournefortii* Miehx. *Fl. Bor. Amer.*, 1. p. 107.; *D. humilis* Pers. *Ench.*, 1. p. 214., and *Lodd. Cat.*, ed. 1836.; *D. lutea* Pursh *Fl. Amer. Sept.*, 1. p. 162.; *D. trifida* Mench. *Meth.*, 492.; *D. arcadiensis* Du Ham. *Arb.*, 1. t. 87.

Engravings. *Bot. Mag.*, t. 1796.; *Du Ham. Arb.*, 1. t. 87.; *Schmidt Baum.*, t. 116.; and our *figs.* 794, 795.

Spec. Char., &c. Leaves on short petioles, ovate, acuminate, serrated, and, as well as the petioles, glabrous. Flowers yellow. Fruit a dry brown capsule.

There are a number of varieties of this plant, differing in respect to the size of the flowers and of the leaves. Root creeping, throwing up suckers. (*Don's Mill.*, iii. p. 444.) A native of Carolina, New England, and Newfoundland, on rocks and the highest mountains; where



it forms a shrub growing to the height of 3 ft. or 4 ft. It was introduced in 1739, and flowers in June and July. In British gardens, it is of the easiest culture in almost any soil; and it multiplies abundantly by suckers.

App. i. *Species of Diervilla not yet introduced.*

D. japonica *Dec. Prod.*, 4. p. 330.; *Weigela japonica* Thunb.; is a native of Japan, with ovate acuminate leaves, and the corolla purple.

D. coracensis *Dec. Prod.*, 4. p. 330.; *Weigela coracensis* Thunb.; *Weigelia coracensis* Pers.; is a native of Japan, closely allied to the preceding sort.

GENUS IV.



LONICERA Desf. THE LONICERA, or HONEYSUCKLE. *Lin. Syst.* Pentándria Monogýnia.

Identification. Desf. *Fl. Atl.*, 1. p. 183.; *Lam. Ill.*, t. 150.; *Dec. Prod.*, 4. p. 330.; *Don's Mill.*, 3. p. 444.

Synonymes. *Lonicera* sp. *Lin.*, and many authors; *Caprifolium* and *Xylósteum*, *Juss. Gen.*, p. 212.;

Xylósteum, *Caprifólium*, *Chamæcérasus*, *Periclymenum*, *Tourn. Inst.*, t. 378. and 379.; *Caprifólium* and *Lonicera*, *Rœm. et Schult. Syst.*; *Lonicera* and *Xylósteum*, *Torrey Fl. Un. St.*; *Chèvre-feuille*, *Fr.*; *Geissblätt*, *Honeigblume*, and *Lonicere*, *Ger.*

Derivation. Named after *Adam Lonicer*, a German, who was born in 1528, and died in 1556. There was another *Lonicer*, John, who wrote comments on *Dioscorides*.

Description, &c. Twining or erect shrubs, natives of Europe, the north of Africa, Asia, and America. The greater number of the species and varieties are of easy culture in British gardens, in common garden soil; and they are all propagated by cuttings, or some of them more readily by layers. The flowers of some of the species are highly fragrant and ornamental; and that of the common European honeysuckle is supposed to have given rise to one of the most beautiful ornaments of Grecian architecture (*fig.* 796.) Price of plants, in the London nurseries, from 6*d.* to 2*s.* 6*d.* each; at *Bollwyller*, from 50 cents to 2 francs; and at *New York*, from 25 cents to half a dollar.

796



The genus *Lonicera* of *Linnaeus* was separated by *Rœmer* and *Schultes* into the genera *Lonicera* and *Caprifólium*; but they were reunited by *De Candolle*, whose arrangement has been followed by *Sir W. J. Hooker* and *G. Don*, and is adopted by us on the present occasion. The distinctive characters of the sections are as follows:—

Caprifólium. Plants twining. Flowers in capitate whorls.

Xylósteum. Plants twining or erect. Flowers axillary.

§ i. *Caprifólium* Dec.

Identification. *Dec. Fl. Fr.*, 4. p. 270.; *Prod.*, 4. p. 331.

Synonymes. *Caprifólium Juss. Gen.*, 212., *Rœm. et Schult. Syst.*, 5. p. 19.; *Lonicera* *Torr. Fl. Un. St.*, 1. p. 242., but not of *Schult.*

Derivation. From *caper*, a goat, and *folium*, a leaf; in reference to the climbing habit of the species; or, as appears much more probable, because goats are fond of browsing on its leaves.

Sect. Char. Berries solitary, while young 3-celled, but when mature usually 1-celled, crowned by the tube of the calyx, which is permanent. Flowers disposed in capitate whorls. Twining shrubs; natives of Europe, the north of Africa, China, Nepal, and North America; all of easy culture, and tolerably hardy, but none of them of long duration.

A. *Flowers ringent.*—*Caprifólium* *Tourn. Inst.*, p. 608.

Æ 1. L. PERICLYMENUM L. The Woodbine, or common Honeysuckle.

Identification. *Lin. Sp.*, p. 247.; *Dec. Prod.*, 4. p. 331.; *Don's Mill.*, 3. p. 445.

Synonymes. *Periclymenum Ger. Emac.* p. 891.; *Periclymenum germanicum Riv. Mon. Irr.*, t. 122.; *P. hortense Gesn. Icon. Pict.*, fasc. 1. 58. t. 7. f. 49.; *Caprifólium Periclymenum Rœm. et Schult.*, 5. p. 262.; *Caprifólium sylvaticum Lam. Fl. Fr.*, 3. p. 365.; *Caprifólium Raii Syn.*, p. 458., *Engl. Gard. Cat.*, t. 5.; *Woodbind*; *Chèvrefeuille des Bois, Fr.*; wildes gemeines *Geissblätt, Ger.*; *gewoone Kamperfoelie, Dutch*; *Lego Bosco, Ital.*; *Madre Selva, Span.*

Derivation. *Periclymenum*, from *peri*, round about, and *kulio*, to roll. *Woodbine* is a corruption of *Woodbind*, and both allude to the habit of the common sort, of winding itself round every tree and shrub within its reach, and binding them together. As *Mason* observes, this plant

“Loves to hang on barren boughs remote
Her wreaths of flowery perfume.”

In the time of *Chaucer*, the woodbine was considered as the emblem of true love, from this property. The name of honeysuckle has reference to the fondness of children for this plant, who amuse themselves with drawing the trumpet-shaped corollas from the calyx, to suck the honey from the nectary. *Chèvrefeuille* and *Geissblätt* both signify, literally, goat's leaf; and *Lego Bosco* is bind-wood. The Spanish and Dutch names, *Madre Selva*, wood mother, and *Kamperfoelie*, the champion mace, seem to have little relation to the plant.

Engravings. *Smith Engl. Bot.*, t. 800.; *Curt. Fl. Lond.*, fasc. 1. t. 15.; *Ced. Fl. Dan.*, t. 908.; *Schmidt Arb.*, t. 107.; *Svensk. Bot.*, t. 140.; *Engl. Gard. Cat.*, t. 5.; *Ger. Emac.*, p. 891., with a fig.; *Riv. Mon. Irr.*, t. 122.; *Gesn. Icon. Pict.*, fasc. 1. 38. t. 7. f. 49.;

Spec. Char., &c. Branches twining. Leaves all separate, deciduous, sometimes downy, glaucous beneath, ovate, obtuse, attenuated at the base; upper ones the smallest. Heads of flowers all terminal, ovate, imbricated. Flowers ringent. There are varieties of this species with either smooth, pubescent, or variegated leaves; and, when the plant grows by the sea side, they are occasionally more glaucous and rather succulent. Corollas externally deep red; or, in the earlier-flowering varieties, all over buff-coloured; in

the maritime plant, smaller and greenish. Berries nearly globular, red, deep, bitter and nauseous, accompanied by permanent bracteas. (*Don's Mill.*, iii. p. 445.) A twining shrub, which always turns from east to west; native of Europe, common in hedges, groves, and thickets; plentiful in Britain. Flowering in June and July; and, in moist summers, also in August, and sometimes in September. In gardens, by pruning and watering, the plants may be kept flowering all the summer.

Varieties.

‡ *L. P. 2 serotinum* Ait.

Hort. Kew., i. p. 378., Hort. Angl., 14. No. 4. t. 7., Mill. Icon., t. 79., Riv. Mon. Irr., t. 122.; *Periclymenum germanicum* Mill. Dict., No. 4., Schmidt Baum., t. 108.; and our

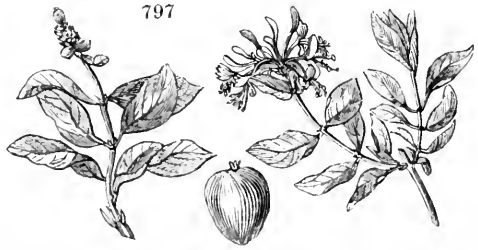

fig. 797. — Branches glabrous. Flowers late, reddish. (*Don's Mill.*, ii. p. 445.) This, the late red honeysuckle, produces a greater number of flowers together than either the Italian or Dutch honeysuckle, so that it makes a finer appearance than either of them during its period of flowering. It has not been so long an inhabitant of our gardens as the Dutch honeysuckle; for, about the year 1715, it was considered a great curiosity; when it was called the Flemish honeysuckle, and was, probably, brought over by the Flemish florists, who, about that time, came to England annually with flowers and plants for sale. (*Martyn's Mill.*)

‡ *L. P. 3 belgicum*; *Periclymenum germanicum* Mill. Dict., No. 4., Hort.

Angl., 15. No. 5. t. 6. — Branches smooth, purplish. Leaves oblong-oval, of a lucid green above, but pale beneath, on long petioles. Flowers in terminal verticillate heads; each flower arising out of a scaly cover, reddish on the outside, and yellowish within; of a very agreeable odour. This, which is commonly called the Dutch honeysuckle, may be trained with stems, and formed into heads; which the wild sort cannot, the branches being too weak and trailing for the purpose. (*Don's Mill.*, ii. p. 445.)

‡ *L. P. 4 quercifolium* Ait. Hort. Kew. has the leaves sinuated like those of an oak. This variety is to be found in England, in a wood near Kimberly, Norfolk; and near Oxford. There is a subvariety of this, with the leaves slightly marked near the margin with yellow. The flowers are like those of the species. It is called the oak-leaved honeysuckle.

History, Culture, Uses, &c. The earlier writers attribute virtues to this shrub which are now entirely given up: but the beauty and exquisite fragrance of the flowers make it a favourite plant in gardens and shrubberies. "This," Sir J. E. Smith observes, "is the true woodbine of poets, though it is likewise the twisted eglantine of Milton, in the well-known lines, —

"Through the sweet briar, or the vine,
Or the twisted eglantine;"

Shakspeare is, however, guiltless of this blunder. He says, —

"So doth the woodbine, the sweet honeysuckle,
Gently entwist the maple;"

and, in *Much ado about Nothing*, uses both names indiscriminately for the bower in which Beatrice lies concealed, —

— "Couch'd in the woodbine coverture;"

and which he had before described as

— “The pleached bower,
Where honeysuckles, ripen'd by the sun,
Forbid the sun to enter.”

“Gentle as are the first embraces of the honeysuckle, and of other twining shrubs,” Mr. Denson observes (*Mag. Nat. Hist.*, vi. p. 330.), “while their stem is yet tender, and through that tenderness, powerless; yet they become with the age, size, strength, hardness, and consequent incapacity for dilatation of the stem or branch, effective agents of an obviously injurious constriction; for the coils of woody-stemmed twining plants are scarcely in any, perhaps in no, species enlarged in capacity so fast as is the diameter of the trunk, stem, or branch, which these coils encircle; that is, presuming the supporting tree or shrub to be in a healthy and freely growing condition.” Cowper, alluding to the constrictive powers of the honeysuckle, has the following beautifully descriptive lines in his poem, *Retirement*.

“As woodbine weds the plant within her reach,
Rough elm, or smooth-grain'd ash, or glossy beech,
In spiral rings ascends the trunk, and lays
Her golden tassels on the leafy sprays;
But does a mischief while she lends a grace,
Straitening its growth by such a strict embrace.”

All the varieties of the common honeysuckle are beautiful and fragrant; and, either trained against a wall, twining round a pole and over a parasol top, or climbing and rambling among bushes, form great ornaments to gardens, particularly when planted against other trees; which, however, if not strong enough to resist their pressure, are seriously injured by it, their trunks and branches sometimes becoming indented like a screw. (See *Mag. Nat. Hist.*, vi. p. 331.) In a state of art and culture, where the gardenesque is the prevailing expression, honeysuckles, or other climbing or twining plants, should never be planted against trees or bushes, but always by themselves, against walls, rods, stakes, or other artificial supports. The reason is, that it is only when they are planted apart from other plants that they can be properly cultivated, and, consequently, display the expression of the gardenesque. Where the object is merely picturesque beauty, the honeysuckle may be planted close to the root of a tree; and, being trained up its trunk, and allowed to twine among its branches, it may be considered as displaying the elegant picturesque. Planted among bushes, and allowed to grow up among them without any training whatever, the expression will be that of the common, or rural, picturesque; or, if the shrubs are chiefly of foreign kinds, and are arranged in a dug shrubbery, the expression may be designated the shrubbery picturesque. These terms are of very little consequence in themselves; but they are introduced here to show that very different kinds of beauty are produced in plantations, according to the manner of planting, and the kinds of plants chosen. The different varieties of common honeysuckle may be propagated by cuttings; but so large a proportion of these do not succeed, owing, as is supposed, to the large space in the centre of the shoot admitting the wet during winter, and rotting the upper part of the cutting, that the more common mode of propagation is by layers. Both layers and cuttings are made in the autumn, as soon as the leaves have dropped; and they become sufficiently rooted in one year. It has been recommended, in order to prevent the water from entering the hollow part of the shoot, and rotting the cuttings, to make the latter of double the usual length, and insert both ends in the ground, so that the cutting should present the appearance of a bow; but this mode, which, it is supposed, would produce two plants from each cutting, can scarcely be said to have been properly tried. (See *Encyc. of Gard.*, edit. 1835, § 2882.)

‡ 2. *L. CAPRIFOLIUM L.* The Goat's-leaf, or *pale perfoliate*, Honeysuckle.

Identification. Lin. Sp., p. 246.; Dec. Prod., 4. p. 331.; Don's Mill., 3. p. 44.

Synonymy. *Periclymenum perfoliatum Ger. Emac.*, p. 891.

Engravings. Engl. Bot., t. 799.; Jacq. Austr., t. 357.; Engl. Gard. Cat., 14. t. 5., Dodon. Pempt.,

411., with a fig.; Matth. Volgr., vol. 2. p. 321., with a fig.; Cam. Epit., 713., with a fig.; Riv. Irr., t. 123.; Krauss, t. 6.; and our fig. 798.

Spec. Char., &c. Branches twining. Leaves deciduous, obovate, acutish, glaucous; uppermost ones broader and connate. Flowers ringent, terminal, disposed in capitate whorls. Stems twining from left to right. Buds acute, glaucous. The lower leaves are distinct, and somewhat stalked; two or three of the upper pairs united; the uppermost of all forming a concave cup. Flowers in one or more axillary whorls, the uppermost whorl terminal; with a central bud, 6 in each whorl, highly fragrant, 2 in. long, with a blush-coloured tube. Berries elliptical, of a tawny orange colour, each crowned by an almost entire calyx. (*Don's Mill.*, iii. p. 444.) Native of the middle and south of Europe, even to the river Tereck in Siberia, and on Mount Caucasus, in woods, hedges, and thickets. In England, it has been occasionally found in similar situations, in an apparently wild state: but it is rare; and we think it may fairly be doubted whether it has any claim to be considered truly indigenous. As it very frequently seeds abundantly in gardens, and as the fruit is greedily eaten by birds, the seeds carried away by them may very probably have sprung up in various situations. Culture, uses, &c., as in the preceding species.



798

3. *L. (C.) ETRUSCA Santi.* The Etruscan Honeysuckle.

Identification. Santi Viagg., 1. p. 113. t. 1.; Savi Fl. Pis., 8. p. 236.; Dec. Prod., 4. p. 331.; Fl Fr. Suppl., 500.; Don's Mill., 3. p. 444.

Synonymes. *L. etrusca Hort. Fl. Austr.*, 1. p. 298.; *Caprifolium etruscum Ram. et Schult. Syst.*, 5. p. 261.; *Periclymenum Gouan Hort.*, p. 101.; *Caprifolium italicum perfoliatum præcox Tourn Inst.*, p. 608.

Engravings. Santi Viagg., 1. p. 113. t. 1.; and our fig. 799.

Spec. Char., &c. Branches twining. Leaves deciduous, obovate, obtuse, pubescent, lower ones on short petioles, upper ones connately perfoliate, acute, glabrous. Flowers disposed in verticillate heads, with usually about three heads on the top of each branch. Flowers glabrous, sweet-scented, purplish on the outside, and yellow inside. (*Don's Mill.*, iii. p. 444.) Native of the south of France, Sicily, Vallais, Carniola, and Dalmatia, on hills, where it forms a twining shrub, flowering in May and June. Judging from the plants in British gardens, we should consider it only a variety of *L. Caprifolium*.



799

4. *L. IMPLEXA Ait.* The interwoven, or *Minorca*, Honeysuckle.

Identification. Ait. Hort. Kew., 1. p. 231.; Dec. Prod., 4. p. 331.; Viv. Fl. Cors., p. 4. exclusive of the synonymes; Camb. Bat., p. 84.; Guss. Sic., 1. p. 257.; Don's Mill., 3. p. 444.

Synonyme. *Caprifolium implexum Ram. et Schult. Syst.*, 5. p. 261.

Engravings. Bot. Mag., t. 640.; and our fig. 800.

Spec. Char., &c. Quite glabrous. Branches twining. Leaves permanent, evergreen, glaucescent; lower ones oblong, distinct; middle ones perfoliate; uppermost ones connate, forming a hollow roundish cup. Flowers disposed in capitate whorls, ringent; purplish before they open, but becoming paler on the outside as they expand, white on the inside; but finally changing to yellow, as in the common woodbine. (*Don's Mill.*, iii. p. 445.) Native of the Balearic



800

Islands, and of Sicily; where it forms a twining evergreen shrub, flowering from June to September. It was introduced in 1772, and is not unfrequent in British gardens; but, in situations north of London, it requires the protection of a wall.

Variety.

♁ *L. i.* 2 *baleárica* Viv., Camb., et Guss., l. c.; *Caprifólium baleáricum* Dum. Cours. Bot. Cult., ed. 2. vol iv. p. 358., *Ræm. et Schult. Syst.*, 5. p. 261.; *L. baleárica* Dce. *Fl. Fr. Suppl.*, 499.; *L. Caprifólium* Desf. *Fl. Atl.*, i. p. 183. — Lower leaves somewhat cordate; upper ones connate, obovate, glaucous beneath. Evergreen. Bark of branches violaceous, clothed with glaucous bloom. Flowers 4—6 in a head, large, cream-coloured, 15—18 in. long. (*Don's Mill.*, iii. p. 444.)

♂ 5. *L. FLA'VA* Sims. The yellow-flowered Honeysuckle.

Identification. Sims Bot. Mag., t. 1318.; Dec. Prod., 4. p. 332.; Torrey Fl. Un. St., 1. p. 243.; Don's Mill., 3. p. 445.

Synonymes. *Caprifólium flavum* Ell. *Sketch.*, 1. p. 271.; *Caprifólium Fraseri* Pursh Fl. Amer. Sept., 1. p. 271.

Engravings. Bot. Mag., t. 1318.; and our fig. 801.

Spec. Char., &c. Quite glabrous. Branches twining a little. Leaves ovate, sometimes glaucous beneath, with cartilaginous margins; upper leaves connately perfoliate. Flowers in terminal verticillate heads. Corollas rather ringent; with oblong, obtuse lobes. Flowers bright yellow, but, as they fade, becoming orange-coloured; very fragrant. (*Don's Mill.*, iii. p. 445.) A twining shrub; a native of the Paris Mountains, in South Carolina; and of the Catskill Mountains, New York. It was introduced in 1810, and flowers in June and July. It is a very desirable species, from the large size, rich yellow colour, and grateful fragrance of its flowers; but it is somewhat tender, and, even in the neighbourhood of London, requires the protection of a wall.



801

♂ 6. *L. (F.) PUBESCENS* Sweet. The pubescent Honeysuckle.

Identification. Sweet Hort. Brit., p. 194.; Dec. Prod., 4. p. 332.; Don's Mill., 3. p. 445.

Synonymes. *Caprifólium pubescens* Goldie in *Edin. Phil. Journ.*, 1822, April, p. 323.; *Hook. Exot. Fl.*, t. 27.; *L. hirsuta* Eaton *Man. Bot. Ed.*, 3. p. 341., ex *Torrey Fl. Un. St.*, 1. p. 242., *Hook. Fl. Bor. Amer.*, 1. p. 282.; *L. Goldii* Spreng. *Syst.*, 1. p. 758.

Engravings. *Hook. Exot. Fl.*, t. 27.; *Bot. Mag.* t. 3103.; and our fig. 802.

Spec. Char., &c. Branches twining. Leaves broad-ovate-elliptic, on short petioles, pubescent and ciliated, glaucous beneath; upper ones connately perfoliate. Spikes or racemes composed of verticillate heads of flowers. Corollas beset with glandular pubescence. Flowers yellow. (*Don's Mill.*, iii. p. 445.) This appears to hold the place in the more northern parts which *L. flava* does in the south; of which, indeed, Dr. Torrey suspects it to be a variety. (*Hook. Fl. Bor. Amer.*, p. 282.) A twining shrub, a native of North America, in Massachusetts, Vermont, New York, and Canada, in many places. Introduced in 1822, by Mr. Goldie of Monkswood, near Ayr; and flowering in June and July. It appears hardier than the preceding sort. In 1831, in Ayrshire, we saw several plants of it against garden walls, growing as vigorously as the common honeysuckle.



802

‡ 7. *L. PARVIFLORA* Lam. The small-flowered Honeysuckle.

Identification. Lam. Diet., 1. p. 728.; Dec. Prod., 4. p. 332.; Don's Mill., 3. p. 445.

Synonymes. *Caprifolium parviflorum* Pursh *Fl. Amer. Sept.*, 1. p. 161.; *Loniceera dioica* Lin. *Syst. Veg.*, ed. 13. p. 181.; *L. media* Murr. *Nov. Comm. Gött.*, 1776, p. 28. t. 3.; *Caprifolium bracteosum* Michx. *Fl. Bor. Amer.*, 1. p. 105.; *Caprifolium dioicum* Roem. et Schult. *Syst.*, 5. p. 260.; *Caprifolium glaucum* Mench.; glaucous Honeysuckle; Chèvrefeuille dioique, Fr.; Meergrünes Geissblätt, Ger.; Middelboore Kamperfoelie, Dutch.

Engravings. Murr. *Nov. Comm. Gött.*, 1776, p. 28. t. 3.; and our figs. 803, 804.

803



Spec. Char., &c. Quite glabrous. Branches twining. Leaves elliptic, sessile; lower ones somewhat connate; upper ones connately perfoliate, very glaucous beneath. Flowers disposed in verticillate heads. Corollas glabrous, with tubes gibbous at the base on one side. Filaments rather hairy. Flowers yellow, and smaller than in any of the foregoing species, but varying exceedingly in their colour; for there is a

variety mentioned by Michaux in which they are purple. (*Don's Mill.*, iii. p. 445.) A twining shrub, native of North America, from New England to Carolina, in rocky shady situations; frequent in Canada, as far north as the Saskatchewan; and from Hudson's Bay to the Rocky Mountains. It was introduced in 1776, and flowers in June and July.

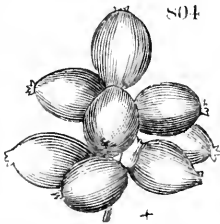

804

‡ 8. *L. (P.) DOUGLASII* Dec. Douglas's Honeysuckle.

Identification. Dec. Prod., 4. p. 332.; Hook. *Fl. Bor. Amer.*, 1. p. 282.; Don's Mill., 3. p. 445.

Synonymes. *Caprifolium Douglasii* Lindl. *Hort. Trans.*, 7. p. 244.

Spec. Char., &c. Branches twining. Leaves oval, acute at both ends, petiolate, glabrous, ciliated, tomentose on the outside; upper ones connate. Flowers disposed in capitate whorls. Stigma exserted. Stamens enclosed. Corollas pubescent, bilabiate, deep orange red. Leaves 4 in. to 6 in. long, deep green. (*Don's Mill.*, iii. p. 446.) Hooker, in his *Fl. Bor. Amer.*, 1. p. 282., considers this nothing but a variety of *L. parviflora*. It is a twining shrub, native of the western coast of North America, on the banks of the Saskatchewan. Introduced in 1824, and flowering in July and September. We have never seen the plant.

‡ 9. *L. GRATA* Ait. The pleasant, or evergreen, Honeysuckle.

Identification. Ait. *Hort. Kew.*, 1. p. 231.; Dec. Prod., 4. p. 332.; Don's Mill., 3. p. 446.

Synonymes. *Caprifolium gratum* Pursh *Fl. Amer. Sept.*, 1. p. 161.; *Roem. et Schult. Syst.*, 5. p. 262.; *L. virginiana* Marsh *Arb.*, 136.; ? *Periclymenum americanum* Mill. *Diet.*, No. 7.

Engravings. Hort. Angl., p. 15. No. 10. t. 8. and our fig. 805.

Spec. Char., &c. Branches twining. Leaves permanent, obovate, rather mucronate, glaucous beneath, and reticulately veined, glabrous; upper ones connately perfoliate. Spikes composed of approximate whorls of flowers. Corollas ringent. Branches reddish brown. Flowers inclining to scarlet on the outside, according to Pursh. Corolla ringent, reddish on the outside, and yellow inside. Berries red. (*Don's Mill.*, iii. p. 446.) A twining shrub, a native of North America, from Carolina to New York, on the mountains, rambling among rocks, in shady moist situations, but rare. Introduced in 1730, and flowering from June or July to September, and sometimes till the commencement of frost. The plant is of vigorous growth, with woody stems, and will live longer than most of the other species. A plant against our veranda at Bayswater has stood since 1825, and is now in full vigour; having outlived *L. Caprifolium*, *L. flavum*, *L. pubescens*, *L. sempervirens*, some varieties of *L.*



805

Periclymenum, and *L. impléxa*. It is inferior in vigour only to *L. japónica*. Plants, in the London nurseries, are 1s. each; at Bollwyller, 1 franc; and at New York, 37½ cents.

L. microphýlla Hook. Fl. Bor. Amer., 1. p. 283, is a provisional name, given to some dried specimens received from the north-west coast of America, by Sir W. J. Hooker, but which had neither flowers nor fruit, and may, possibly, therefore, belong to some other genus. The leaves are scarcely more than 6 lines long, uniform, exactly cordate, and very villous.

B. *Limb of Corolla nearly equal.* — *Periclymenum* Tourn.

‡ 10. *L. SEMPERVIRENS* Ait. The evergreen *Trumpet Honeysuckle*.

Identification. Ait. Hort. Kew., 1. p. 230.; Dec. Prod., 4. p. 332.; Don's Mill., 3. p. 446.

Synonymes. *Caprifolium sempervirens* Michx. Fl. Bor. Amer., 1. p. 105.; *Periclymenum sempervirens* Mill. Dict., No. 1.; *Alaternus empervirens* Kachl. ex Steud.; *Periclymenum virginiacum* Riv. Mon., 116.

Engravings. Hort. Angl., t. 7.; Knorr Del., 1. t. 53.; Krauss, t. 1.; and our fig. 806.

Spec. Char., &c. Quite glabrous. Leaves persistent, sub-evergreen, obovate or ovate, glaucous beneath; upper ones connately perfoliate. Spikes nearly naked, composed of whorls of flowers; tube of corolla ventricose on the upper side; limb nearly regular, with 5 roundish lobes. Branches brown. Leaves deep green above, 2 in. long and 1 in. broad. Whorls of flowers usually 3, at the top of each branch. Flowers of a beautiful scarlet outside, and yellow inside, about 1 in. long, inodorous. There are several varieties of this species, particularly one with an almost upright stem. (*Don's Mill.*, iii. p. 446.) A twining shrub, native of North America, from New York to Carolina, in dry stony woods. Introduced in 1656, and flowering from May till August. The fine scarlet flowers of this species, and the length of time during which they are produced, render it a very desirable one; but it is somewhat tender, and rather capricious in regard to situation. It will not thrive in clayey or wet soil; neither in the smoke of cities, nor in a confined situation. It grows well in sand, but still better in sandy peat. It succeeds but indifferently in the London nurseries; and the metropolitan trade is generally supplied from the Goldworth Nursery, where it grows luxuriantly, and is propagated by layers to a great extent. Price of plants, in London, 1s. 6d. each.; at Bollwyller, 1 franc and 50 cents; and at New York, 37½ cents.

Varieties.

‡ *L. s. 2 major* Ait., Curt. Bot. Mag., 1781., Schmidt Baum., t. 104. *The large Trumpet Honeysuckle.* — Leaves roundish, and flowers very large, and of a brilliant scarlet.

‡ *L. s. 3 minor* Ait., Sims. Bot. Mag., 1753.; Ker Bot. Reg., t. 556.; *L. connata* Meerb. Icon., t. 11? *The small Trumpet Honeysuckle.* — Leaves oblong, acute at both ends; upper ones obtuse, perfoliate; with small flowers, which are scarlet both outside and inside. This is an elegant climbing shrub, but it can only be recommended for open airy situations in the country; and the soil in which it is planted ought to be occasionally stirred and manured.

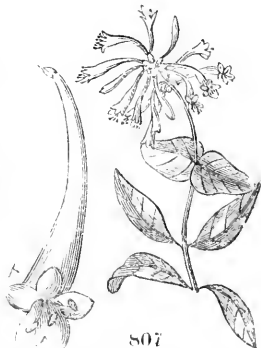

‡ 11. *L. CILIO'SA* Poir. The ciliated-leaved Honeysuckle.

Identification. Poir. Suppl., 5. p. 612.; Dec. Prod., 4. p. 332.; Don's Mill., 3. p. 446.

Synonymes. *Caprifolium ciliosum Pursh Fl. Amer. Sept.*, 1. p. 160.; *L. ciliata Dietr. Lcx. Suppl.*, 4. p. 263.

Spec. Char., &c. Plant twining; upper part of the branches hairy on one side.

Leaves coriaceous, reticulated, ovate, on short petioles, glaucous beneath, and ciliated on the margins: upper ones connately perfoliate. Spikes composed of approximate verticillate heads of nearly sessile flowers; tube of corolla hairy, ventricose in the middle; limb nearly equal. Flowers deep yellow. Peduncles beset with glandular hairs. (*Don's Mill.*, iii. p. 446.) A twining shrub; a native of North America, on the banks of the Kooskoosky. Introduced in 1825, and flowering in July. There are plants of this species in the arboretum of Messrs. Loddiges.

‡ 12. *L. OCCIDENTALIS* Hook. The Western Honeysuckle.

Identification. Hook. Fl. Bor. Amer., 1. p. 252.; Don's Mill., 3. p. 446.

Synonymes. *Caprifolium occidentale Lindl. Bot. Reg.*, t. 1457.; *Caprifolium ciliosum Douglas MSS. Engraving.* Bot. Reg., t. 1457.

Spec. Char., &c. Twining. Leaves oval, almost sessile, glabrous, ciliated, glaucous beneath; upper ones connately perfoliate. Flowers disposed in verticillate heads. Corolla glabrous, with an elongated tube, which is gibbous above the base; the limb nearly equal. Stamens almost inclosed. (*Don's Mill.*, iii. p. 446.) The flowers are larger than in any other British North American species, and of a full orange red. Branches and peduncles glabrous. A twining shrub, a native about Fort Vancouver, on the Columbia. Introduced in 1824, and flowering in June and July. A great acquisition to our gardens; and quite different from *L. pubescens*, *L. parviflora*, and *L. Douglasii*; and, if the presence or absence of hairs in the corolla are to be depended on, it is also different from *L. ciliosa*, which inhabits nearly the same country.

L. pilosa Willd. Dec. Prod., 4. p. 233.; *Caprifolium villösium H. B. et Kunth Nov. Gen. Amer.*, 3. p. 427. t. 298.; is a native of New Spain, in cold places, with purple flowers, not yet introduced.

§ ii. *Xylösteum* Dec.

Identification. Dec. Prod., 4. p. 333.; Don's Mill., 3. p. 446.

Synonymes. *Xylösteum Juss. Gen.*, 212.; *Lonicera* Rein. et Schult. Syst., 5. p. 19.; *Xylösteon* and *Chamaecerasus*, *Tourn. Inst.*, p. 601.; *Xylösteum* and *Isika*, *Adans. Fam.*, 2. p. 501.; *Cobœa* Neck. Elem., No. 219.; the Fly Honeysuckle; *Hackenkirsehe*, *Ger.*; *Hondsbeziën* or *Honds-karsen*, *Dutch Derivation.* From *xylon*, wood, and *osteon*, a bone; the wood of *L. Xylösteum* being as hard as bone.

Sect. Char., &c. Pedicels axillary, 2-flowered, bibracteate at the apex. Berries, twin, distinct, or joined together more or less; 3-celled in the young state; rarely 2-celled in the adult state. The limb of the calyx is generally deciduous, therefore the fruit is usually not crowned. (*Don's Mill.*, iii. p. 446.) Climbing or erect shrubs, with leaves never connate. In British gardens, they are of the easiest culture, and extremely hardy.

A. *Ovaries and Berries altogether distinct. Stems scandent. Flowers irregular.* — *Nintooa* Dec. Prod., iv. p. 33.

Derivation. *Nintoo*, or *Sintoo*, is the name of *L. japonica* in China.

‡ 13. *L. CONFUSA* Dec. The confused Honeysuckle.

Identification. Dec. Prod., 4. p. 333.; Don's Mill., 3. p. 446.

Synonymes. *Nintooa confusa* *Sut. Hort. Brit.*, ed. 2.; *Lonicera japonica* *Andr. Bot. Rep.*, t. 583.; *Ker Bot. Reg.*, t. 70., *Delaun. Herb. Amat.*, t. 132., but not of Thunb.; *Nintoo*, *Sintoo*, *Kampf. Amœn.*, 5. p. 785.; *Caprifolium japonicum* *Loud. Hort. Brit.*

Engravings. *Andr. Bot. Rep.*, t. 583.; *Bot. Reg.*, t. 70.; *Delaun. Herb. Amat.*, t. 132.; and our fig. 808.

Spec. Char., &c. Branches twining, pubescent. Leaves ovate, acute, rounded at the base, downy on both surfaces, as well as the peduncles. Peduncles axillary, longer than the petioles, 2-flowered, opposite, disposed in something like a thyrasis at the tops of the branches. Calycine segments ovate, and, as well as the corollas, pubescent. The flowers are snow-white at

first, but gradually change to a golden yellow colour; hence it is called Suikadsara and Kinginqua, that is gold and silver flowers, by the Japanese. Corolla about an inch long, bilabiate. (*Don's Mill.*, iii. p. 447.) A twining shrub, native of Japan, China, and the Himalayas. Introduced in 1805, and flowering in July. It is somewhat tender; nevertheless, it will grow and flower freely against an open wall in the neighbourhood of London; and the extraordinary fragrance of its flowers, which are produced in the greatest abundance, well entitles it to a place in every collection. A plant has stood against a wall in the Horticultural Society's Garden since 1828.



♣ 14. *L. LONGIFLORA* *Dcc.* The long-flowered Honeysuckle.

Identification. *Dcc. Prod.*, 4. p. 333.; *Don's Mill.*, 3. p. 447.

Synonyms. *Caprifolium longiflorum Sabine ex Lindl. Bot. Reg.*, 1232.; *Nintōa longiflora Swt. Hort. Brit.*, ed. 2.; *Caprifolium japonicum D. Don Prod. Fl. Nep.*, 140.; *Caprifolium nepalense G. Don in Loud. Hort. Brit.*, 79.

Engraving. *Bot. Reg.*, t. 1232.

Spec. Char., &c. Glabrous in every part. Branches twining. Leaves petiolate, oblong-lanceolate, shining above, and pale beneath. Peduncles short, 2-flowered, about the length of the petioles. Tube of corolla very long and filiform; limb bilabiate. Flowers several inches long, at first snow-white, but finally changing to a golden yellow colour. (*Don's Mill.*, iii. p. 447.) A twining shrub, a native of China and Nepal. Introduced in 1826, and flowering from July to September.

♣ 15. *L. JAPONICA* *Thunb.* The Japan Honeysuckle.

Identification. *Thunb. Fl. Jap.*, p. 89.; *Don's Mill.*, 3. p. 447.

Synonyms. *Nintōa japonica Swt. Hort. Brit.*, ed. 2.; *L. chinensis Hort. Kew.*, *Wats. Dend. Brit.*, t. 117., and *Dcc. Prod.*, 4. p. 333.; *L. flexuosa Lodd. Bot. Cab.*, 1037., *Ker. Bot. Reg.*, 712., but not of *Thunb.*; *L. glabrata Roxb.*; *Caprifolium chinense Loud. Hort. Brit.*; *C. flexuosum Hort. Engravings.* *Dend. Brit.*, t. 117.; *Bot. Cab.*, t. 1037.; *Bot. Reg.*, t. 712.; and our figs. 809, 810.

Spec. Char., &c. Stems twining, flexuous, hairy. Branchlets opposite, very hairy, bearing 2 leaves and 2 sessile flowers at the base of each. Leaves about an inch long, petiolate, ovate, acutish, villous, pale beneath; uppermost ones the smallest. Corolla tubular, irregular, about an inch long, red, and villous on the outside, and white inside, sweet-scented, equal in length to the stamens. (*Don's Mill.*, iii. p. 447.) A twining shrub. A native of China, Japan, and the Himalayas. Introduced in 1806, and flowering in July and September. This is, perhaps, the most valuable species of the genus, next to the indigenous one. It is evergreen, apparently as hardy as



the common woodbine, and of far more robust habit of growth; and, probably, a much longer-lived plant. Its flowers, which are produced for several months together, are exceedingly fragrant; and, by pruning and watering, it may be kept in flower in the open garden from April to November, and in a conservatory throughout the year. No garden whatever, whether large or small, should be without this species. Plants, in the London nurseries, are 1s. each; at Bollwyller, 3 francs; and at New York, 1 dollar. Plants in pots are much to be preferred, though they are one half dearer; because, if they are turned out into a large mass of prepared light rich soil, and placed against a wall, the ball being broken, and

the roots spread carefully out in every direction, the shoots will cover several square yards of wall the first summer, and flower abundantly.

a. *Hardy Species of Lonícera belonging to the Division Nintooa of the Section Xylósteum, not yet introduced.*

L. cochinchinénsis Don's Mill., iii. p. 447.; *L. Xylósteum Lour.*; is a twining shrub, with a much-branched stem, and ovate leaves, a native of Cochinchina, among bushes and hedges.

L. Telfáirü Hook et Arn., Don's Mill., iii. p. 447.; *L. Periclýmenum Lour.*; is a native of China, closely allied, on the one hand, to *L. confusum Dec.*, from which it differs in the leaves being smooth above, and in the shorter peduncles; and, on the other, to *L. Lechenaúltü Wall.*, which, however, is said to have ovate-subcordate ciliated leaves, and villous branches.

L. Lechenaúltü Wall., Don's Mill., iii. p. 447., has twining stems, axillary flowers, and is found on the Neelgherry Mountains.

L. glabrata Wall., Don's Mill., iii. p. 447.; *L. nigra Thunb.*; is a native of Nepal, with twining branches and ovate leaves, glaucous beneath.

L. acuminata Wall., Don's Mill., iii. p. 447., is a native of the Himalayas, with twining stems, and flowers like those of *L. Xylósteum*.

L. diversifolia Wall., Don's Mill., iii. p. 448., is a native of the East Indies, on Mount Gurval, with twining branches, and flowers resembling those of *L. Xylósteum*, both in size and colour. The leaves are ovate and cuspidate, and about 3 in. long, pubescent above, and villous beneath.

L. ligustrina Wall., Don's Mill., iii. p. 448.; *Xylósteum ligustrinum D. Don.*; *X. Naisoca Hamilt.*; is a native of Nepal, on the mountains and in the woods, with the branches slender, twining, and covered with ash grey, shining, smooth bark, and leaves like those of the privet.

L. lanceolata Wall., Don's Mill., iii. p. 448., is an erect, bushy shrub, with berries about the size and colour of black currants; a native of Nepal, at Gosainthan.

L. canescens Schousb., Don's Mill., iii. p. 448.; *L. biflora Desf.*; is a native of hedges about Mogador, on Mount Trara in Mauritania, and of Sicily, near Palermo, with twining branches, which, with the leaves, are canescent from down. The flowers are in peduncles, which are longer than the petioles, and the corolla is velvety on the outside.

L. bracteata Royle Illust., p. 237., has the leaves ovate-lanceolate, the peduncles axillary and 2-flowered, with broad foliaceous bracteas, which, before the expansion of the flowers, half conceal the flower buds. Mr. Royle remarks that this is a singular species, so closely allied to *Leycestèria*, that it might almost be referred to that genus.

The names of several other species of *Lonícera* are given in Royle's *Illustrations*, as found in the Himalayas; but none of them, except those already mentioned, are described in published works, or introduced into British gardens.

B. *Berries distinct, or usually connate together at the Base, and diverging at the Tip. Corolla hardly gibbous at the Base, or equal. — Chamaccérasí Dec.*

Derivation. The name signifies a kind of false cherry: the fruit of some of the species resemble cherries. (*Dec. Prod.*, iv. p. 335.)

❖ 16. *L. TATA'RICA Lin.* The Tartarian Honeysuckle.

Identification. *Lin. Sp.*, 1. p. 247.; *Dec. Prod.*, 4. p. 335.; *Don's Mill.*, 3. p. 448.

Synonymes. *Xylósteum cordatum Munch Mch.*, p. 502.; *X. tataricum Dum. Cours.*

Engraving. *Pall. Fl. Ross.*, t. 36.; *Jacq. Icon. Rar.*, t. 37.; *Bot. Reg.*, t. 31.; *Guimp. Abb. Holz.*, t. 87.; and our figs. 811, 812.

Spec. Char., &c. Quite glabrous, erect. Leaves cordate-ovate, hardly acute. Peduncles shorter than the leaves. Berries distinct when young, and nearly globose, but at length connate at the base. Flowers rose-coloured, short, somewhat gibbous at the base. Fruit black, with one of the berries usually abortive. Bracteas 2, linear-setaceous. Peduncles 2-flowered.



811

(*Don's Mill.*, p. 448.) A shrub, a native of Tartary, and growing to the height of from 4 ft. to 6 ft. It was introduced in 1752, and flowers in April and May.

Varieties.

✻ *L. t. 2 albiflora* Dec. Prod., iii. p. 335.; *L. pyrenæica Willd. Baumz.*, p. 181. — Flowers and fruit white.

✻ *L. t. 3 rubriflora* Dec., l. c.; *L. grandiflorum Lodd. Cat.*; *L. sibirica Hortul. ex Pers. Ench.* — Flowers and fruit red.

✻ *L. t. 4 lutea* Lodd. Cat. has yellowish flowers and yellow fruit.

✻ *L. t. 5 latifolia* Lodd. Cat. has broad leaves.



812

Culture, &c. This is one of the most hardy of European shrubs, and one of the few which grow in the open gardens of Petersburg and Stockholm, without protection during winter. It flowers about Petersburg in June, and about London in April, having begun to put out its leaves in January. In Siberia, Pallas informs us, the berries, though bitter, nauseous, and purgative, are eaten by the common people. The wood, which, when deprived of its bark, is beautifully veined, is used for walking-sticks; and the plant being frequented by the *Méloe vesicatorius L.* (*Cántharis vesicatoria Geoff.*), that insect is collected from it for the apothecaries. In British gardens, the plant is very common, and it is valued for its early leafing and flowering. It will grow in any soil, and almost in any situation. It is readily propagated by cuttings.

✻ 17. *L. (T.) NIGRA L.* The black-fruited Honeysuckle.

Identification. Lin. Sp., 247.; Dec. Prod., 4. p. 335.; Don's Mill., 3. p. 449.

Synonymys. *Caprifolium rōseum Lam. Fl. Fr.*, 3. p. 368.; *Chamæcerasus nigra Dclarb. Fl. Au.*, ed. 2. p. 130.

Engravings. Jacq. Aust., t. 314.; Schmidt. Baum., t. 110.; Gesn., fasc. 37. t. 8. f. 48.

Spec. Char., &c. Erect. Leaves oval-oblong, or elliptic, on short petioles, rather villous when young, but nearly glabrous in the adult state. Peduncles 2-flowered, elongated, shorter than the leaves. Corolla reddish, and pubescent on the outside, but whitish on the inside. Bracteas 4, under the ovaries; the two outer ones lanceolate, and the inner quadrifid. Berries black, globose, joined together at the side. (*Don's Mill.*, iii. p. 449.) A shrub, from 3 ft. to 4 ft. high; a native of middle Europe, in subalpine woods, as in France, Switzerland, Austria, Silesia, Piedmont, &c. It was introduced in 1597, and flowers from March to May. It is of the easiest culture and propagation in any common soil. The plant in the Horticultural



813



814

Society's Garden was, in 1835, after being seven years planted, 5 ft. high.

Variety.

✻ *L. ? (t.) n. 2 campaniflora*; *Xylósteum campaniflorum Lodd. Cab.*, t. 1361.; and our figs. 813, 814.; has the flowers bell-shaped.

18. *L. (T.) CILIA'TA Mühl.* The ciliated-leaved Honeysuckle.

Identification. Mühl. Cat., p. 22.; Dec. Prod., 4. p. 335.; Don's Mill., 3. p. 448.

Synonymys. *Xylósteum ciliatum Pursh Fl. Amer. Sept.*, l. p. 161.; *L. tatárica Michx. Fl. Amer.*, 1. p. 166., but not of Lin.; *L. canadensis Ravn. et Schult. Syst.*, 5. p. 260.

Spec. Char., &c. Erect. Leaves ovate or oblong, cordate, thin, ciliated, villous beneath in the young state. Peduncles elongated. Bracteas 2, ovate, three times shorter than the ovaries, which are distinct. Corolla

bluntly spurred at the base; with short, nearly equal, lobes. Berries distinct, red, divaricate. Flowers white, with a tinge of red or yellow; tube ventricose above; limb with short acute segments; style protruded. (*Don's Mill.*, iii. p. 448.) A shrub, from 4 ft. to 6 ft. high, a native of North America, on mountains among rocks, in rich soils; from Canada to Virginia, and throughout Canada to the Saskatchewan. It was introduced in 1824, and, in British gardens, flowers in June and July. It is of the easiest culture in any soil, and is readily propagated by cuttings. The white-flowered variety mentioned by Pursh, is said to be *Vaccinium album*.

§ 19. *L. PYRENAÏCA* L. The Pyrenean Honeysuckle.

Identification. Lin. Sp., p. 248.; Dec. Prod., 4. p. 335.; Don's Mill., 3. p. 448.

Synonymes. *Caprifolium pyrenæicum Lam. Fl. Fr.*, 3. p. 366.; *Xylôsteum pyrenæicum Tourn. Inst.*, 609.

Spec. Char., &c. Glabrous, erect. Leaves obovate-lanceolate, acute, glaucous beneath. Peduncles 2-flowered, shorter than the leaves. Bractæas oblong-linear, foliaceous. Flowers almost regular. Berries globose, distinct. Corolla white, twice the size of that of *L. Xylôsteum*, funnel-shaped. Limb 5-cleft, flat; with equal, ovate, obtuse segments. (*Don's Mill.*, iii. p. 448.) A shrub, growing to the height of from 4 ft. to 5 ft., a native of the Pyrenees, on calcareous rocks, in exposed situations. Introduced in 1739, and flowering in May. A very hardy shrub, of easy culture, and frequent in collections.

§ 20. *L. PUNICEA* Sims. The crimson-flowered Honeysuckle.

Identification. Sims Bot. Mag., t. 2469.; Dec. Prod., 4. p. 335.; Don's Mill., 3. p. 448.

Synonyme. *Symphoricarpos puniceus Swt.*

Engravings. Bot. Mag., t. 2469.; and our fig. 815.

Spec. Char., &c. Erect. Leaves ovate, subcordate at the base, of the same colour on both surfaces. Peduncles axillary, and almost terminal, 2-flowered, shorter than the leaves. Tube of corolla rather gibbous at the base; segments of corolla nearly equal, irregularly arranged, 3 one way and 2 another. Berries distinct? Flowers deep red, or crimson. Leaves sometimes three in a whorl on the young shoots. (*Don's Mill.*, iii. p. 448.) A shrub, growing to the height of from 2 ft. to 4 ft. Introduced in 1822, and flowering in April and May.



§ 21. *L. XYLO'STEUM* L. The bony-wooded, or upright, Fly Honeysuckle.

Identification. Lin. Sp., 248.; Dec. Prod., 4. p. 335.; Don's Mill., 3. p. 448.

Synonymes. *Caprifolium dumetorum Lam. Fl. Fr.*, 3. p. 367.; *Xylôsteum dumetorum Mærch Mth.*, p. 502.

Engravings. Eng. Bot., t. 916.; Fl. Græc., t. 223.; Cæd. Fl. Dan., t. 808.; Du Ham. Arb., 1. p. 153. t. 59.; Riv. Mon. Irr., t. 120.; Mill. Icon., 167. f. 1. and our fig. 816.

Spec. Char., &c. Erect, downy. Leaves ovate, acute, petiolate, soft. Peduncles 2 flowered, shorter than the leaves. Bractæas hairy, double; the two outer ones lanceolate, spreading; inner a small concave scale under each germ. Berries oval, distinct, 1-celled, 6-seeded. Flowers small, cream-coloured, downy. Calyx of 5 obtuse lobes. Berries scarlet. (*Don's Mill.*, iii. p. 449.) A shrub, growing to the height of from 8 ft. to 10 ft., flowering in July; and, according to Sir J. E. Smith, of "little beauty, and no known utility, though common in plantations." It is a native throughout nearly the whole of Europe, even to Caucasus, in thickets, hedges and rocky places, and by the sides of woods. It has been found in a few situations in Britain, but is a very doubtful native. Linnæus says that it makes excellent hedges in a dry soil; that the clear parts between the joints of the shoots are used, in Sweden, for tobacco-pipes; and that the

wood, being extremely hard, makes teeth for rakes, &c. Gmelin informs us that the Russians make an empyreumatic oil from the wood, which they recommend for cold tumours and chronic pains. Animals seldom touch the leaves. In hard weather birds eat the berries, which are reputed to be purgative and emetic. (*Martyn's Mill.*) According to Pallas, an empyreumatic oil is prepared from the branches when young; and the wood, which is extremely hard, and yields only in beauty to *L. tatárica*, is used for walking-sticks. It is one of the oldest and hardiest inhabitants of British shrubberies, having been in the Edinburgh Botanic Garden since 1683; but, certainly, it cannot be recommended for its beauty, in a country possessing such an extensive ligneous flora as we have in Britain. In the colder parts of Europe, about Stockholm and Petersburg, for example, it is valuable, because it endures the severest winters. In the English garden, or rather park, at Munich, it is planted in masses and groups, along with other masses and groups of *Cornus álba*, *Salix vitellina*, and *Viburnum Opulus*; and, in the winter time, the whitish-grey bark of its shoots contrasts finely with the red, yellow, or brown, bark of the other species.

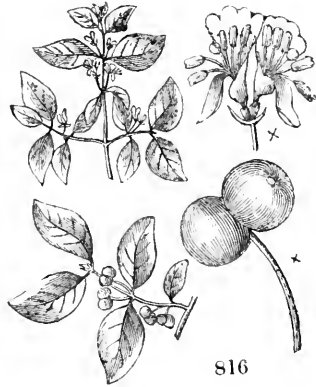

Varieties.

- ☞ *L. X. 2 leucocárpa* Dec. Prod., iv. p. 335., N. Du Ham., i. p. 52., has white berries.
- ☞ *L. X. 3 xanthocárpa* Dec., l. c., N. Du Ham., l. c., has the berries yellow.
- ☞ *L. X. 4 melanocárpa* Dec., l. c., Bauh. Pin., p. 451., has black berries.

☞ 22. *L. FLEXUOSA* Thunb. The flexible-stemmed Honeysuckle.

Identification. Thunb. in Lin. Trans., 2. p. 530, but not of Lodd., nor Ker; Don's Mill., 3. p. 449. *Synonyms.* *L. nigra* Thunb. *Fl. Jap.*, p. 89, but not of Lin.; *L. brachypoda* Dec. Prod., 4. p. 335.

Spec. Char., &c. Erect, branched. Branches very villous at the apex. Leaves ovate-oblong, acute, on short petioles, glabrous; petioles villous; nerves of leaves puberulous. Flowers axillary, few, almost sessile. Berries globose, glabrous. Stems flexuous. Leaves about an inch long; upper ones the smallest. Peduncles hardly a line long. Berries distinct, ovate, acuminate, black. (*Don's Mill.*, iii. p. 449.) A shrub, growing to the height of from 4 ft. to 5 ft., a native of Japan; which was introduced in 1806, and flowers in June and July.

a. *Hardy Species of Lonicera, belonging to the Division Chamacérasi of the Section Xylósteum, not yet introduced.*

L. hispida Pall., Led. Fl. Ross. Alt. III., t. 212., is a native of Siberia, growing to the height of 2 ft. or 3 ft. with hispid branches, and pendulous greenish white flowers, which are succeeded by dark purple berries.

C. *Berries either distinct or joined together. Corolla very gibbous at the Base. Erect bushy Shrubs. — Cuphánthæ* Dec.

Derivation. From *kuphos*, gibbous, and *anthos*, a flower; in reference to the flower being gibbous on one side at the base.

☞ 23. *L. INVOLUCRATA* Banks. The involucreted Honeysuckle.

Identification. Banks Herb. ex Spreng. Syst., 1. p. 759.; Dec. Prod., 4. p. 336.; Don's Mill., 3. p. 449.

Synonymy. *Xylósteum involucretum* Richards. in Frank. First Journ., ed. 1., append. p. 6. *Engravings.* Our figs. 817, 818, 819.

Spec. Char., &c. Erect. Branches acutely tetragonal. Leaves ovate or oval, petiolate, membranous, beset with appressed hairs beneath. Peduncles axillary, 2—3-flowered. Bractæas 4; two outer ovate, two inner broad, obcordate, at length widening, clothed with glandular pubescence. Corolla pubescent, gibbous at the base on the outside; yellowish, tinged with red. Style exerted. (*Don's Mill.*, iii. p. 449.) A shrub, 2 ft. to 3 ft.



high, native of North-west America, between lat. 54° and 64° (but probably confined to the vicinity of the Saskatchewan); thence to the Rocky Mountains. It was introduced in 1824, and flowers in May.

a. *Hardy Species of Lonicera belonging to the Division Cuphánthæ of the Section Xylósteum, which are not yet introduced.*

L. gibbosa Willd., *Xylósteum mexicanum* H. B. et Kunth, is a native of Mexico, in woods, with the corolla scarlet.

L. Mociniána Dec., *L. gibbosa* Moc. et Sesse, is a native of Mexico, very nearly allied to the preceding species, but differs in the corolla being yellowish, and, when decaying, of a blood colour, permanent, and jagged, with the bractæes spreading. The berries are globose, and of a dark purple.

L. Ledebourii Eschsch., *Don's Mill.*, 3. p. 449. A native of California, so nearly allied to *L. involu-crata*, as hardly to be distinguishable from it.

D. *Berries two on each Peduncle, joined together in one, which is bi-umbilicate at the Apex. Erect branching Shrubs.—Isikæ Adans.*

Derivation. A name, the origin of which is unknown, employed by Adanson to designate this division of the genus.

❖ 24. *L. ALPI'GENA* H. The alpine Honeysuckle.

Identification. Lin. Sp., 248.; Dec. Prod., 4. p. 336.; Don's Mill., 3. p. 449.

Synonymes. *Caprifolium alpinum* Lam. *Fl. Fr.*; *Caprifolium alpinum* *Gartn. Fruct.*, 1. p. 136.; *Isika alpigena* Bórck.; *Isica lucida* Mærch.; *Xylósteum alpinum* Lodd. *Cat.*; *Chamæcerasus alpigena* DeCarr.; *Cherry Woodbine*; *Heckenkirsche*, *Ger.*

Engravings. Jacq. *Fl. Aust.*, t. 274.; N. Du Ham., 1. t. 16.; Mill. *Icon.*, t. 167. f. 2.; Lob. *Icon.*, t. 173.; and our figs. 820, 821.

Spec. Char., &c. Erect. Leaves oval-lanceolate, or elliptic; acute, glabrous, or pubescent, on very short petioles, rather ciliated. Peduncles 2-flowered, shorter than the leaves. Corolla gibbous at the base, and greenish yellow tinged with red or purple. Berries red, and of the size and appearance of those of a cherry; whence it is called cherry woodbine by Johnson. Leaves large. (*Don's Mill.*, iii. p. 449.) A shrub, from 3 ft. to 5 ft. high, a native of the middle and south of Europe, in subalpine places and mountains. Introduced in 1596, and flowering in April and May. One of the oldest and hardest of our shrubs, and of the easiest propagation and culture.

Variety.

- ❖ *L. a. 2 sibirica* Dec. Prod., iv. p. 336.; *L. sibirica* *Vest in Ræm. et Schult. Syst.*, 5. p. 259.—Lower leaves rather cordate. Peduncles thickened a little under the flowers. A native of Siberia; and, like most other varieties of trees and shrubs, natives of the west of Europe, indigenous to Siberia, coming into leaf and flower, a week, or more, earlier than the species.



❖ 25. *L. (A.) MICROPHY`LLA Willd.* The small-leaved Honeysuckle.

Identification. Dec. Prod., 4. p. 336; Willd. Rel. in Rœm. et Schult. Syst., 5. p. 258; Don's Mill., 3. p. 450.

Synonymy. *L. alpigena Sievers.*

Engraving. Led. Fl. Ross. Alt. III., t. 213.

Spec. Char., &c. Leaves elliptic, acute at both ends, glaucous beneath, rather villous on both surfaces, and sometimes rounded at the base. Peduncles 2-flowered, and shorter than the leaves. Corollas greenish yellow. Berries joined, of a reddish orange colour. The epidermis falls from the branches. (*Don's Mill.*, iii. p. 450.) A shrub, 3 ft. or 4 ft. high; a native of Eastern Siberia, and introduced in 1818. Obviously a variety of the preceding species.

❖ 26. *L. OBLONGIFO`LIA Hook.* The oblong-leaved Honeysuckle.

Identification. Hook. Fl. Bor. Amer., 1. p. 284. t. 100.; Don's Mill., 3. p. 450.

Synonymy. *Xylósteum oblongifólium Goldie* in *Edin. Phil. Journ.*, 6. p. 232.

Engravings. Hook. Fl. Bor. Amer., 1. t. 100.; and our fig. 822.

Spec. Char., &c. Erect, Leaves oblong, or oval, clothed with velvety pubescence beneath. Peduncles elongated, erect. Bractees obsolete. Tube of corolla hairy, gibbous at the base on one side. Limb unequal, deeply 2-lipped; the upper lip 4-toothed, and the lower one nearly entire. Berries joined in one, which is bi-umbilicate at the top, bluish black in the dried state, and about the size of a pea. (*Don's Mill.*, iii. p. 450.) A shrub, growing to the height of 4 ft. or more, native of North America, in the Island of Montreal, in the St. Lawrence, about Montreal, Lake Winnipeg, and of the western parts of the state of New York. It was introduced in 1823, and flowers in April and May. There are plants in the Horticultural Society's Garden.



❖ 27. *L. CERU`LEA L.* The blue-berried Honeysuckle.

Identification. Lin. Sp., 349; Dec. Prod., 4. p. 337; Don's Mill., 3. p. 450.

Synonymy. *L. villosa Mühl. Cat.*, p. 92., *Hook. et Arn. in Beech. Voy. Pl. Bot.*, 1. p. 115; *Xylósteon villosum Michx. Fl. Bor. Amer.*, 1. p. 106.; *Richards. in Frankl. First Journ.*, ed. 2., append. p. 6.; *X. Solmsi Eaton Man. Bot.*, p. 518.; *L. velutina Dec. Prod.*, 4. p. 337.; *L. altaica Pall. Fl. Ross.*, t. 37.; *Xylósteum ceruleum canadense Lam. Dict.*, 1. p. 731.; *X. canadense DuRoi. Arb.*, 2. p. 373.; *Caprifólium ceruleum Lam. Fl. Fr.*, and *Lodd. Cat.*, ed. 1836; *Chamaecerasus cerulea Delarb. Fl. Au.*; *L. pyrenaica Pall. Fl. Ross.*, p. 58.; *L. Pallasi Led. Fl. Ross. Alt. III.*, t. 131.

Engravings. Jacq. Fl. Aust. Append., 5. t. 17.; Sims Bot. Mag., t. 1975.; Pall. Fl. Ross., t. 37.; Led. Fl. Ross. Alt. III., t. 131.; and our figs. 823, 824.

Spec. Char., &c. Erect. Leaves oval-oblong, ciliated, stiffish, densely clothed with pubescence while young. Peduncles short, 2-flowered, reflexed in the fructiferous state. Bractees 2, subulate, longer than the ovaria. Tube of corolla glabrous, short, gibbous on one side at the base; lobes of limb short, nearly equal. Berries closely joined in one, which is bi-umbilicate at the apex. Flowers greenish yellow, tubular. Berries elliptic or globose, dark blue, and covered with a kind of bloom. Bark of young shoots purplish. There is no difference between the



American and European plants of this species. (*Don's Mill.*, 3. p. 450.) A shrub, growing to the height of from 3 ft. to 5 ft.; native of Europe, in France, Switzerland, Austria, &c., on the mountains; throughout the woody country of British North America, and as far as lat. 66° to the mountains in the west, Labrador, Newfoundland, and Hudson's Bay; in the states of New York, Massachusetts, New Hampshire; and of Siberia

and Kamtschatka. It was introduced in 1629, and flowers in March and April.

28. *L. (C.) ORIENTALIS Lam.* The Oriental Honeysuckle.

Identification. Lam. Dict., 1. p. 731.; Dec. Prod., 4. p. 337.; Bieb. Fl. Taur. et Suppl., No. 306.; Don's Mill., 3. p. 450.

Synonymes. *L. caucásica Pall. Fl. Ross.*, 1. p. 57.; *L. cærúlea Güld. Itin.*, 1. p. 423., *ex Pall.*; *Chamaecerasus orientális faurifolia Tourn. Cor.*, p. 42.

Spec. Char., &c. Erect. Leaves on very short petioles, ovate-lanceolate, acute, quite entire, smoothish, peduncles 2-flowered, shorter than the leaves. Bracteas 2, setaceous. Berries joined in one, didymous and bi-umbilicate at the apex, 10-seeded. Berries black (*Lam.*, *Bieb.*), dark blue (*Pall.*). Leaves stiffish, veiny, larger than in *L. cærúlea*. Flowers greenish yellow. (*Don's Mill.*, iii. p. 450.) A shrub, growing to the height of from 3 ft. to 5 ft.; native of Iberia and Asia Minor, in woods. It was introduced in 1825, and flowers from April to June. Judging from the plants in the Hackney arboretum, it appears to be a variety of the preceding sort.

29. *L. IBERICA Bieb.* The Georgian Honeysuckle.

Identification. Bieb. Fl. Taur., and Suppl., 395.; Stev. Mém. Soc. Mosc., 3. p. 257.; Dec. Prod., 4. p. 337.; Don's Mill., 3. p. 450.

Synonymie. *Xylósteum ibéricum Bieb. Cent. Pl. Rar.*, 1. t. 13., *ex Suppl.*, and *Lodd. Cat.*, ed. 1836.

Engraving. Bieb. Cent. Pl. Rar., 1. t. 13., *ex Suppl.*

Spec. Char., &c. Erect. Leaves petiolate, cordate, roundish, tomentose, or pubescent. Peduncles 2-flowered, shorter than the leaves. Bracteas oblong, ciliated. Berries joined together to the middle, globose. Corollas lucid, of the form of those of *L. alpígena*. Ovarium tomentose. Berries blood-coloured. Leaves like those of *Cotoneáster vulgàris*. (*Don's Mill.*, iii. p. 450.) A shrub, growing to the height of from 3 ft. to 4 ft.; native of Georgia, about Teflis. It was introduced in 1824, and flowers in April and May.

a. *Hardy Species of the Genus Lonícera belonging to the Division Isikæ of the Section Xylósteum, not yet introduced.*

L. Webbiana Wall. (*Dec. Prod.*, 4. p. 336.; *Royle Illust.*, p. 236.) is a native of the East Indies, in Sirinagur, with the habit of *L. alpígena*.

L. Govaniana Wall. (*Dec. Prod.*, p. 337.) is a native of Sirmore, in the East Indies, and is nearly allied to *L. alpígena*.

L. angustifolia Wall. (*Dec. Prod.*, 4. p. 337.) is a native of Nepal, with the branches smooth, and the leaves 15 lines long, and 4 lines broad. Corolla pale.

Some other species, not sufficiently known, but presumed to be hardy, natives of the East Indies and of Chili, are enumerated in Don's Miller and Royle's Illustrations, to which we refer the curious collector.

GENUS V.



SYMPHORICARPOS *Dill.* THE ST. PETER'S WORT. *Lin. Syst.*
Pentándria Monogýnia.

Identification. Dill. Elth., p. 571.; Juss. Gen., p. 211.; Mæneh Meth., p. 502.; Dec. Prod., 4. p. 338.; Don's Mill., 3. p. 451.

Synonymes. *Symphoricárpos Neck. Elem.*, p. 220.; *Symphória Pers. Ench.*, 1. p. 214.; *Anisánthus Willd. Rel.*; *Lonicera sp. Lin.*

Derivation. From *sumphoréō* to accumulate, and *karpos*, fruit; species bearing the fruit in groups. How it obtained the name of St. Peter's Wort we have not been able to ascertain.

Description, &c. Bushy deciduous shrubs, of the easiest culture in common garden soil, and readily increased by suckers, which they throw up in abundance. Price of plants, in London, from 6d. to 1s. each; at Bollwyller, 50 cents; and at New York, 37½ cents.

1. *S. VULGARIS Michx.* The common St. Peter's Wort.

Identification. Michx. Fl. Bor. Amer., 1. p. 100.; Dec. Prod., 4. p. 339.; Don's Mill., 3. p. 451.

Synonymes. *Lonicera Symphoricárpos Lin. Sp.*, 249.; *S. parviflora Desf. Cat.*; *Symphória conglomerata Pers. Ench.*, 1. p. 214.; *Symphória glomerata Pursh Fl. Amcr. Sept.*, p. 162.

Engravings. Schmidt Baum., t. 115.; Dill. Elth., t. 278. f. 360.; Hort. Angl., t. 20.; and our fig. 825

Spec. Char., &c. Flowers disposed in axillary capitate clusters, composed of nearly sessile racemules. Corolla white. Berries red, size of hempseed; but, in America, according to Pursh, the flowers are small, red and yellow, and the berries purple. Branches brown, smooth. Leaves elliptic ovate, obtuse, glaucous, and pubescent beneath. The berries are numerous, and ripen in winter. (*Don's Mill.*, iii. p. 451.) A shrub, growing to the height of from 3 ft. to 6 ft.; native of Virginia, Carolina, and Pennsylvania, in sandy dry fields. It was introduced in 1730, and flowers in August and September.

Variety.

- ♣ *S. v. 2 fôliis variegâtis*, *S. glomerâta fôliis variegâtis* *Lodd. Cat.*, has the leaves finely variegated with green and yellow.



♣ 2. *S. RACEMOSUS Michx.* The racemose-flowered St. Peter's Wort, or Snowberry.

Identification. *Michx. Fl. Bor. Amer.*, i. p. 107.; *Dec. Prod.*, 4. p. 339.; *Don's Mill.*, 3. p. 451.

Synonyms. *Symphoricarpos racemosa Pursh Fl. Amer. Sept.*, i. p. 162.; *S. leucocarpa Hort.*

Engravings. *Bot. Mag.*, t. 221.; *Lodd. Bot. Cab.*, t. 230.; and our fig. 826.

Spec. Char., &c. Flowers disposed in nearly terminal, loose, interrupted racemes, which are often leafy. Corolla densely bearded inside. Style and stamens enclosed. Leaves glaucous beneath. Corolla rose-coloured. Berries large, white. This is a fine shrub, very common in our gardens, easily known by its large white berries, and small red flowers. The *S. elongata* and *S. heterophylla Presl* in *Herb. Hænke*, which were collected about Nootka Sound, do not differ from this species, in which the lower leaves are sometimes deeply sinuated. (*Don's Mill.*, iii. p. 451.) A shrub, growing to the height of from 4 ft. to 8 ft.; native of North America, on mountains near Lake Mistassins, and on the banks of the Missouri; in Upper Canada it is abundant about the Saskatchewan, on the banks of the Columbia, and at Puget's Sound and Nootka Sound, north-west coast. It was introduced in 1817, and flowers from July to September. The flowers are succeeded by white fruit, about the size of a large black currant, but elliptical in form, which remain on the bush even after the leaves have dropped, and make a very fine appearance. In small gardens, this shrub is rather troublesome, from the numerous suckers it throws up from the roots; but, as its flowers are much sought after by bees, and its berries are excellent food for game (See *Gard. Mag.*, ix. p. 699., and x. p. 432.), that habit, when it is planted for these purposes, is found rather advantageous than otherwise. For gardens, it might be desirable to graft it on *Lonicera Xylôsteum*, or some allied species of suitable habit. So grafted, standard high, it would form a very elegant small tree.



App. i. *Hardy Species of Symphoricarpos not yet introduced.*

S. occidentalis Richards. (*Hook. Fl. Bor. Amer.*, i. 285.) is a native of British North America, in the woody country between lat. 54° and 64°, and known under the name of wolfberry. Dr. Richardson remarks of this plant, that it approaches very near to *S. racemosus*; and Sir W. J. Hooker says, "Among the numerous specimens in the herbarium, are some which appear almost as much allied to one species as the other: but the majority of the individuals of the two species are readily enough distinguished; those belonging to the *S. occidentalis*, by their larger, less glaucous, more rigid, and denser foliage (some of the leaves being 2½ in. long); by the flowers arranged in dense drooping spikes, larger than in *S. racemosus*; and by the prominent style and stamens." (*Hook. Fl. Bor. Amer.*, i. p. 285.) We have given this quotation to show the very uncertain grounds on which what are called species are established; and, perhaps, it cannot be otherwise, so long as botanists are obliged to form their opinions from dried specimens. There is scarcely any tree or shrub that, by culture in different soils and situations, could not be made to vary in magnitude, and other particulars, as much as, or more than, is stated to be the case with these dried specimens of *Symphoricarpos*. We are very much inclined to think that, if the species of all the genera of *Caprifoliaceæ* were cultivated for some years in the same garden, they would be reduced to less than half their present number.

GENUS VI.



LEYCESTERIA Wall. THE LEYCESTERIA. *Lin. Syst.* Pentándria
Monogýnia.

Identification. Wall. in Roxb. Fl. Ind., 2. p. 181. ; Plant. Rar. Asiat., 2. p. 21. t. 120. ; Dec. Prod., 4. p. 338. ; Don's Mill., 3. p. 451.

Derivation. Named by Dr. Wallich after his friend *William Leycester*, formerly chief judge of the principal native court under the Bengal Presidency ; " who, during a long series of years, and in various parts of Hindoostan, has pursued every branch of horticulture with a munificence, zeal, and success, which abundantly entitle him to that distinction."

Description, &c. This genus appears to be intermediate between *Caprifoliaceæ*, and *Rubiaceæ*; but from the last it is distinguished by the want of stipules. (*Don's Mill.*, iii. p. 451.) The only species known is a shrub, a native of the Himalayas.

♁ 1. L. FORMOSA Wall. The beautiful Leycesteria.

Identification. Wall. in Roxb. Fl. Ind., 2. p. 182. ; Dec. Prod., 4. p. 338. ; Don's Mill., 3. p. 451.

Synonymic. *Hamèlia connata Puccari MSS.*

Engravings. Plant. As. Rar., 2. t. 120. ; and our fig. 827.

Description, &c. A large, rambling, deciduous shrub, a native of the highest mountains which surround the valley of Nepal; and of much more northerly situations, towards Gossainthan, at elevations of between 6000 ft. and 7000 ft., and even as high as 8000 ft., among forests of pine and oak. It is a most beautiful shrub when in a flowering state, from the contrast of the deep green hue of its stem and leaves, with the purple colour of its large bracteas and its berries. It was introduced into British gardens in 1824, and it flowered soon afterwards in the nursery of Messrs. Allen and Rogers, at Battersea, whence specimens were sent to the late Mr. Sweet, and to Mr. G. Don. It is a rambling shrub, with the general appearance of a honeysuckle; and it will probably prove somewhat tender in this country; but, as it is easily propagated by cuttings, or by seeds, which it produces in abundance, a stock of plants might easily be kept in readiness to provide for accidental losses. Trained against a conservative wall, it would have a splendid effect in autumn. There are young plants, raised in 1836, from Nepal seeds, in the Horticultural Society's Garden.



CHAP. LXIV.

OF THE HARDY LIGNEOUS PLANTS OF THE ORDER RUBIA'CEÆ.

This order includes a great number of genera; but there is only one of these that contains any ligneous species truly hardy in British gardens.

GENUS I.



CEPHALA'NTHUS L. THE BUTTON-WOOD. *Lin. Syst. Tetrándria Monogýnia.*

Identification. *Lin. Gen.*, No. 113.; *Gærtn. Fruct.*, 2. t. 86.; *Lam. Ill.*, t. 59.; *Juss. Mém. Mus.*, 6. p. 402.; *Rich. Diss.*, with a fig.; *Dec. Prod.*, 4. p. 538.; *Don's Mill.*, 3. p. 610.; *Lodd. Cat.*, ed. 1836.

Derivation. From *cephale*, a head, and *anthos*, a flower; in allusion to the flowers being disposed in globular heads.

Gen. Char., &c. *Calyx* with an obversely pyramidal tube, and an angular 5-toothed limb. *Corolla* with a slender tube, and a 4-cleft limb; lobes erectish. *Stamens* 4, short, inserted in the upper part of the tube, hardly exserted. *Style* much exserted. *Stigma* capitate. *Fruit* inversely pyramidal, crowned by the limb of the calyx, 2—4-celled, and separating into 2—4 parts; cells, or parts, 1-seeded, indehiscent, and sometimes empty by abortion. *Seeds* oblong, terminating in a little callous bladder. *Albumen* somewhat cartilaginous. *Embryo* inverted in the albumen, with a superior radicle. (*Don's Mill.*, iii. p. 610.)—Shrubs, with terete branches. Leaves opposite, or 3 in a whorl.

♣ I. C. OCCIDENTA' LIS L. The Western Button-wood.

Identification. *Lin. Sp.*, 138.; *Dec. Prod.*, 4. p. 538.; *Don's Mill.*, 3. p. 610.; *Lod. Cat.*, ed. 1836.

Synonymes. *C. oppositifolius* *Manch Meth.*, p. 487.; *Swamp Globe Flower*, *Amer.*

Engravings. *Du Ham. Arb.*, 1. t. 54.; *Schkuhr Handb.*, t. 21., and t. 5. b. fruit.; *Lois. Herb. Amat.*, t. 272.; *Pluk. Alm.*, 336. t. 77. f. 4.; and our *figs.* 828, 829.

Spec. Char., &c. Leaves opposite, or 3 in a whorl, ovate or oval, acuminate. Peduncles much longer than the heads, usually by threes at the tops of the branches. Petioles reddish next the branches. Heads of

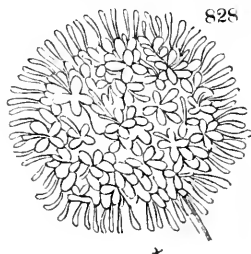

828

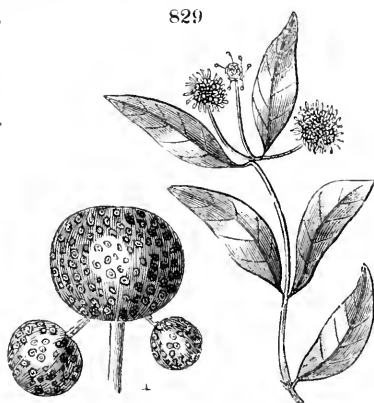

829

flowers globular, size of a marble. Flowers whitish yellow. There are varieties of this species having the branchlets and young leaves either glabrous or downy. (*Don's Mill.*, iii. p. 610.) A shrub, growing to the height of from 6 ft. to 8 ft.; a native of North America, from Canada to Florida, in marshy places. It was introduced in 1735, and flowers in July and August. It will grow in common garden soil, but prefers peat kept moist; and is propagated chiefly by seeds, but will also grow by cuttings and layers. It is an inter-

esting shrub, from its curious round heads of flowers, and from the lateness of the season at which these appear. Price of plants, in the London nurseries, 1s. 6d.; at Bollwyller, 1 franc; and at New York, 25 cents.

Variety.

- *C. o. 2 brachypodus*. Dec. Prod., iv. p. 539.—Leaves elliptic-oblong, 3 in a whorl, or short petioles; petioles 3—4 lines long. There are varieties of this, with either glabrous or downy branches. A native of the north of Mexico, near Rio de la Trinidad and Bejar, where it was collected by Berlandier. (*Don's Mill.*, iii. p. 610.)

Some other species of Cephalanthus are described in De Candolle's Prodrromus and Don's Miller; but they are natives of South America, the East Indies, or China, and are considered as requiring the green-house or the stove.

App. I. *Half-hardy ligneous Plants belonging to the Order Rubiæcæ.*

Pinckneya pubens Michx. (*North Amer. Syl.*, 1. p. 260. t. 49) and our fig. 830.), *Pinckneya pubescens* Pers., *Cinchona caroliniana* Poir., is a tree growing to the height of 20 ft., in Georgia, South Carolina, and other parts of North America. The branches and leaves are tomentose, and the flowers rather large, pubescent, and white, tinged with red. The tree divides into numerous branches, and is covered with large light green leaves, which are downy beneath, but it is not particularly ornamental. In America it is called Georgia bark, and was originally supposed to belong to the same genus as the cinchona, which it strongly resembles. It is interesting for the properties of its bark; which partakes of the same bitter qualities as that of the cinchona; and which is employed successfully in the alleviation of the intermittent fevers which prevail in the country where it is a native. The wood is soft, and unfit for use in the arts. In England, the plant is generally kept in green-houses or cold-pits; but it will thrive much better if planted in the free ground, and trained against a wall with a southern exposure. It requires a shady situation, and is said to thrive best in a mixture of sand and peat.

Serissa foetida Comm. in Juss. Gen. (*Don's Mill.*, 3. p. 633); *Lycium japonicum* Thunb. (*Bot. Mag.*, t. 361., and our fig. 831.); *Lycium foetidum* Lin. fil.; *Lycium indicum* Retz.; *Dysoda fasciculata* Lour. *Coch.*, p. 146; *Buchizzia coprosmodes* L'Hérit. *Diss.*, with a fig.; *Dysoda foetida* Salisb. *Prod.*, p. 60.; *Spermacoce fruticosa* Desf. *Hort. Par.*; is a native of China, Japan, and other parts of the East, where it forms a bushy shrub, growing to the height of 2 ft. or 3 ft., with small, dark green, shining leaves, a little deflexed; and flowers which are white within, and reddish without, and often single and double on the same plant. In Japan, it is frequently planted for hedges. It was introduced in 1787, and grows freely in our green-houses, in a mixture of loam, peat, and sand, flowering during the most part of the summer.

Plúcama pendula Ait.; *Barthingia scoparia* Rehb. *Icon. Exot.*, t. 11.; is a small, glabrous, much branched shrub, with the branches round, slender, and pendulous, and the leaves linear, filiform, and opposite. It is a native of the Canary Islands, where it grows to the height of 2 ft.; and was introduced in 1779, but has not yet flowered.

Phyllis Nòbla L. (*Dill. Elth.*, p. 405. t. 299. f. 386.) has been an inhabitant of our green-houses since 1699. It is a glabrous shrub, with round branches, and small greenish white flowers, which are produced in June and July.

Anthospermum æthiopicum L.; *Ambrària Heisteri* Walth. *Hort.*, t. 9., *Hort. Cliff.*, t. 27., *Pluk. Alm.*, t. 193. f. 1.; is a branched shrub, with small linear leaves, shining above, and whitish beneath. The male and female flowers are produced on different plants, the former being brownish, and the latter green. This is an evergreen Cape shrub, an old inhabitant of our green-houses, where it forms a dense fastigate bush, sometimes as high as 4 ft., and flowering in June and July. It well deserves a place against the conservative wall.

Rùbia fruticosa Ait., *Don's Mill.*, 3. p. 643., *Jacq. Icon. Rar.*, t. 25.; *R. fruticosa canadensis* Poir.; is a native of the Canary Islands, where it grows to the height of 4 ft. or 5 ft., and produces its small yellowish flowers in September. It is chiefly remarkable for its leaves, which are from 2 to 6 in a whorl; and, as it is somewhat shrubby, it deserves a place against a conservative wall, or on dry rockwork.

Bouvardia Jacquinii H. B. et Kunth *Don's Mill.*, 3. p. 486.; *B. triphylla* Hort.; *Houstonia cocinea* *Bot. Rep.*, t. 106.; is a native of Spain, growing to the height of 2 ft. or 3 ft., with scarlet tubular flowers, with a tube about 9 lines long, which appear from April to November. It is a most desirable shrub, for turning out into beds and borders during the summer season, or for training against a low conservative wall. There are two forms of it in British collections, one with leaves much more pubescent than those of the other.

Maníttia giàbra Cham. et Schlecht., *Swt. Fl. Gard.*, 2d ser., t. 334.; *M. cordifolia* Mart., *Hook. Bot. Mag.*, t. 3202., *Gard. Mag.*, ix. p. 107., and x. 238.; is an exceedingly elegant little twiner, with scarlet tubular corollas, and broad deep green leaves. It is a native of Buenos Ayres; and, Professor D. Don observes, will doubtless succeed well in the open border during summer.



830

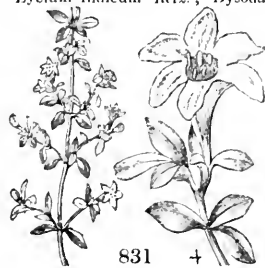

831

CHAP. LXV.

OF THE HALF-HARDY LIGNEOUS SPECIES OF THE ORDER
LOBELIACEÆ.

TUPA *G. Don* is a genus that contains some tall-growing herbaceous plants, natives of Chili, which might technically be considered as suffruticose; because, in frames and green-houses, they retain their leaves, and do not die down during winter. Among these are *T. salicifolia* *G. Don*; *Lobelia Tupa* *Ait.*; *L. gigantea* *Sims Bot. Mag.*, t. 1785; and *L. salicifolia* *Sut.*, which grows to the height of 16 ft., and makes a fine appearance in the open garden during the summer season.

Lobelia arborea *Forst.* and *L. superba* *Cham.* are natives of the Society Islands, superb plants which grow to the height of 12 ft. or 15 ft.; but neither of them have been yet introduced. A shrubby species of *Lobelia* from Valparaiso, in Knight's Exotic Nursery, which has not yet received a name, appears as if it would grow 8 ft. or 10 ft. high; and, from its blue flowers, and deep green leaves, it would make a fine appearance against a wall.

CHAP. LXVI.

HALF-HARDY PLANTS BELONGING TO THE ORDER CAMPANULACEÆ.

Misschia aurea *Dumort.*; *Campánula aurea* *L., N. Du Ham.*, 3. p. 169. *Bot. Reg.*, t. 57.; is an evergreen suffruticose plant, growing to the height of 2 ft. or more, in Madeira and Teneriffe, among rocks. It is an interesting shrub, which may be compared to a miniature tree. The stem is simple, rather fleshy, marked by the scars left by the falling of the leaves, but furnished with a crown of leaves at top, and annual floriferous branches, which are disposed in a leafy pyramidal panicle. Leaves 3—6 in. long, pale green, shining. Peduncles 1—3-flowered. Flowers erect. (*Don's Mill.*, iii. p. 772.) From the habit of this plant, it is better adapted for conservative rockwork, than for being trained to a wall; but it may be tried in both manners; for, as it ripens seeds freely, the loss of plants can easily be supplied.

CHAP. LXVII.

OF THE HARDY LIGNEOUS PLANTS OF THE ORDER COMPO'SITÆ.

GENERAL Characteristics. Flowers grouped in heads; those in each head so disposed, and so environed by an involucre composed of bracteas, that corresponds to a calyx, as to seem to constitute but one flower. The leading characteristics of the separate flowers are the following:—Ovary inferior, bearing on its top, in many, pappus of some kind. Corolla of 1 petal. Stamens 5, their anthers connate into a tube. Style encircled by the tube; its top bifid, the portions of it extended above the tube. Ovary with 1 cell and 1 erect ovule. (*Lindley's Introd. to N. S.*, and *Lessing's Synopsis Generum Compositarum*, 1832.) The genera of this order that include hardy ligneous species are but few. The following characteristics of them are derived chiefly from *Lessing's Synops. Gen. Comp.* The species are mostly natives of Europe and North America, and are all of the easiest propagation and culture in any common garden soil.

STÆHELINA *Lessing.* Flowers bisexual. Pappus with its segments branched, feathery, and in a single row. Rachis (receptacle) with chaffy projections. Involucre of many rows of bracteas. Heads purplish violet. Small shrubs, of the south of Europe. Leaves silkily tomentose beneath, entire.

BA'CCHARIS *R. Br.* Sexes diœcious, or mostly so; with the pappus, in the male flowers, with its segments in a single row, in the female ones, with its segments in several rows; the corolla filiform. Where the sexes are not diœcious, the flowers of several rows in the exterior of the head are female: the rest *Lessing* has not characterised; but it would appear, from

the *Hort. Kew.*, that they are bisexual. Rachis naked. Bracteas of the involucre imbricate. Heads whitish, solitary, or aggregate. Shrubs or trees of North America; the young branchlets, in many, viscous. Leaves alternate, entire, in most coriaceous.

IVA L. A single row of flowers in the outline of the head, female; the rest male. Not any pappus. Rachis bearing bracteoles. Involucre of a single row of bracteas, and these few. Heads in a terminal, linear, spike. Herbs or shrubs of North America, with leaves alternate or opposite, with 3 ribs.

SANTOLINA L. A single row of female flowers in the outline of the head; the corolla of each of these with a ligula that is much shorter than the tube, and spreads rayedly. The rest of the flowers bisexual; the corolla tubular, without a ligula. Not any pappus. Involucre bell-shaped. Bracteas imbricate. Heads borne solitarily at the tips of peduncles, including many flowers. Small shrubs, of the Mediterranean region, more or less tomentose; their leaves alternate, cut in a bipinnate manner.

ARTEMISIA Cass. Flowers in the head either all bisexual, or those of a single row in the outline, females; the rest bisexual. Not any pappus. Rachis naked or villose. Bracteas of the involucre dry, filmy in the margin, imbricate. Heads small, each of few flowers; the heads disposed in spikes, racemes, or pyramidal panicles. Chiefly herbs, but also a few shrubs, natives of most parts of the world. The kinds to be described in this work have their flowers partly female and partly bisexual, as described above, and their rachis naked.

HELICHRYSUM Lessing. Flowers in the head either all bisexual, or with the external row of them female. Pappus with a single row of segments. Rachis without bracteoles. Bracteas of the involucre of various colours; the inner ones spreading more or less, and rayedly, about the head. Heads solitary or aggregate, each of many flowers. Herbs or shrubs, most of which are found in the southern extremity of Africa.

CINERARIA Lessing. External flowers of the head female; with ligulate corollas, spread rayedly. The rest bisexual, and their corollas tubular. Pappus with its segments in several rows. Bracteas of the involucre filmy in the margin, in one row. Rachis flat, without bracteas. Heads in corymbs. Flowers yellow. Herbs or small shrubs, of the Cape of Good Hope. The one species that we have to describe is a native of the south of Europe. Leaves alternate, entire, or variously cut in a pinnate manner.

GENUS I.



STÆHELINA Lessing. THE STÆHELINA. *Lin. Syst.* Syngenèsia
Æqualis.

Identification. Lessing Synops. Gen. Compos., p. 5.; Ait. Hort. Kew., ed. 2. vol. 4. p. 512.

Synonymic. Stæhelina, Fr. and Ger.

Derivation. So named in honour of *John Henry Stæhelin*, and his son *Benedict*, Swiss botanists and physicians.

✱ *I. S. DU'BIA* L. The doubtful, or *Rosemary-leaved*, Stæhelina.

Identification. *Lin. Sp.* 1176.; *Less. Syn. Gen. Compos.*, p. 5.; *Willd. Sp. Pl.*, 3. p. 1783.; *Ger. Prov.*, 190. t. 6.; *Ait. Hort. Kew.*, ed. 2. v. 4. p. 512.

Synonymic. *S. rosmarinifolia* Cass., according to *Less. Syn. Gen. Compos.*, p. 5.

Engravings. *Ger. Prov.*, p. 190. t. 6.; *Lam. Ill.*, 666. f. 4.; and our *fig.* 832.

Spec. Char., &c. Leaves sessile, linear, finely toothed, tomentose beneath. Inner bracteas of the involucre lanceolate, elongate. (*Willd. Sp. Pl.*) A native of the south of Europe. In England, a hardy shrub, with fragrant flowers, which appear in June and July. It is readily propagated by cut-

tings, and will grow in any light sandy soil; attaining the height of 2 ft. or 3 ft. in three or four years. It was cultivated by Parkinson in 1640.

App. i. *Half-hardy Species of Stæhelinæ.*

Stæhelinæ L. There are two green-house species, *S. arboræscens* and *S. Chamæpūce*, both considered pretty plants; the first growing to the height of 6 ft., and the other to that of 2 ft.; which, being natives of Candia, and thriving quite well in a frame, are doubtless fit for a conservative wall or conservative rockwork.

Remark. We may observe here that such plants as the different species of *Stæhelinæ*, hardy and half-hardy, are rarely, if ever, to be found in the public nurseries. Their culture is in general confined to the collections of curious individuals; or some of our public botanic gardens. Hence the great value of such gardens, in a scientific point of view; since, by means of them, many plants are preserved alive in the country, that would otherwise be known to botanists only through books or herbariums; and which would never be seen by the general observer at all. Botanic gardens, therefore, exist, more or less, in every civilised country, as a part of the national institutions; and in some countries, as in France, they are very properly supported at the expense of the local, or general, government.

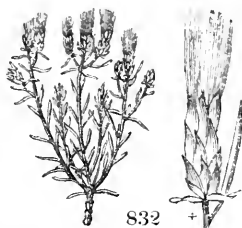

GENUS II.



BA'CCHARIS R. Br. THE BACCHARIS, or PLOUGHMAN'S SPIKENARD.
Lin. Syst. Syngenesia Supérflua.

Identification. Less. Syn. Gen. Compos., p. 204.; Ait. Hort. Kew., ed. 2. vol. 5. p. 25.

Synonymes. Bacchante, Fr.; Baccharis, Ger.

Derivation. From *Bacchus*, wine; because of the vinous odour of its root. Pliny says the root smells of cinnamon: but, as the ancients sometimes boiled down their wines, and mixed them with spices, these wines may have had an odour similar to that of the root of the baccharis.

1. *B. HALIMIFOLIA L.* The Sea-Purslane-leaved Baccharis, or the Groundsel Tree.

Identification. Lin. Sp., 1204.; Willd. Sp. Pl., 3. p. 1915.; Schmidt Baum., t. 82.; Ait. Hort. Kew., ed. 2. vol. 5. p. 26.

Synonyme. *Senecio arboræscens Hort. Kew.*

Engravings. Schmidt Baum., t. 82.; Du Ham. Arb., t. 35.; and our fig. 833.

Spec. Char., &c. Leaves obovate, crenately notched on the terminal portion. (*Willd. Sp. Pl.*, iii. p. 1915.) Flowers white, with a tint of purple, and resembling those of the groundsel, but larger. A native of North America, on the sea coast, from Maryland to Florida. It has been in cultivation in British gardens since 1683; it grows to the height of 8 ft. or 10 ft., and flowers from September to November. It is chiefly remarkable for the glaucous hue of its leaves, in consequence of the whole plant being covered with a whitish powder. Its general appearance accords with that of the genus *Atriplex*, and the shrubs of both families are, accordingly, well calculated for being grouped together. *Baccharis halimifolia* will grow in any common soil which is tolerably dry, attaining the height of 6 ft. or 8 ft., in 3 or 4 years, and forming a large, loose-headed, robust-looking bush, of from 10 ft. to 12 ft. in height, and 12 ft. or 15 ft. in diameter, in 10 years. It is readily propagated by cuttings. Price of plants, in the London nurseries, 1s. each.



2. *B. ANGUSTIFOLIA Pursh.* The narrow-leaved Baccharis, or Ploughman's Spikenard.

Identification. Pursh Fl. Amer. Sept., 2. p. 523.

Spec. Char., &c. Leaves narrow, linear, entire. Panicle compound, many-flowered. Involucre small. (*Encyc. of Plants*, p. 703.) A subevergreen

shrub, of less vigorous growth, and somewhat more tender, than the preceding species. It is a native of North America, on the sea coast, from Carolina to Florida, and on the banks of the Mississippi; flowering from July to September. It was introduced into British gardens in 1812, and grows to the height of 3 ft. or 4 ft., retaining its leaves, in mild seasons, through the greater part of the winter. There were plants in the Twickenham Botanic Garden, Cambridge Botanic Garden, and in that of Bury St. Edmunds, a few years ago.

B. glomeratiflora Michx. Fl. Amer., 2. p. 125., Pursh Fl. Amer. Sept., 2. p. 523., is described as having the leaves smooth, cuneately obovate, toothed towards the point; the heads of flowers axillary, sessile, remote; and the scales of the calyx brown above. It is a native of Virginia and Carolina, in woods on the sea coast, flowering from August to October; but it has not yet been introduced.

B. Dioscòridis W., Rauw. Itin., t. 51., is a native of the Levant, and is generally kept in the greenhouse or cold-pit; though there can be no doubt that, if it were thought worthy of cultivation, it would stand against a conservative wall.

GENUS III.



IVA L. THE IVA. *Lin. Syst. Syngnèsia Necessària.*

Identification. Lin. Gen. Pl., 1429.; Ait. Hort. Kew., ed. 2. vol. 5. p. 181.

Derivation. Uncertain. Perhaps from *Iva*, a name used by the elder botanists.

♣ 1. *I. FRUTESCENS* L. The shrubby Iva.

Identification. Lin. Amæn. Ac., 3. p. 25.; Willd. Sp. Pl., 3. p. 2387.; Ait. Hort. Kew., ed. 2. vol. 5. p. 181.; Pursh Fl. Amer. Sept., 2. p. 580.

Synonymy. *Agérato affinis peruviana frutescens* Pluk. *Alm.*, 12. t. 27. f. 1.; Bastard Jesuits' Bark Tree.

Engravings. Pluk. *Alm.*, 12. t. 27. f. 1.; Encyc. of Plants, p. 744. f. 12762.; and our fig. 834.

Spec. Char., &c. Leaves lanceolate, deeply serrated, rough with dots. (*Willd. Spec. Plant.*) A native of North America, from New England to Florida, on the sea coast; flowering in August and September. Cultivated in Britain in 1711. It grows to the height of 3 ft. or 4 ft., and, in sheltered dry situations, is tolerably hardy; but, when freely exposed in moist soil, it is apt to be killed to the ground in severe winters. It is readily propagated by cuttings; but, not being a plant of much beauty, it is seldom met with in collections.—*I. imbricata* Willd. is described by Pursh as a smooth shrub, with linear lanceolate entire leaves, found on the sea coast, from Carolina to Georgia. It has not yet been introduced.



834

GENUS IV.



SANTOLINA L. THE SANTOLINA, or LAVENDER COTTON. *Lin. Syst. Syngnèsia Æquàlis.*

Identification. Lin. Gen. Pl., 1278.; Less. *Syn. Gen. Compos.*, p. 259.; Ait. Hort. Kew., ed. 2. vol. 4. p. 517.

Synonymy. Santoline, *Fr.*; Heiligenpflanze, *Ger.*

Derivation. From *sanctus*, holy, and *linum*, flax; so called from its supposed medical qualities.

Description. Diminutive evergreen undershrubs, natives of the south of Europe; of easy culture and propagation, by cuttings, in any poor sandy soil.

1. S. CHAMÆCYPARI'SSUS L. The Dwarf Cypress Santolina, or common Lavender Cotton.

Identification. Lin. Sp., 1179; Willd. Sp. Pl., 3. p. 1797.; Ait. Hort. Kew., ed. 2. vol. 4. p. 517.
Engravings. Lam. Ill., 671. t. 3.; and our fig. 835.

Spec. Char., &c. Branches tomentose. Leaves hoary, toothed; the teeth obtuse, and in four rows. Each peduncle bearing a single head of flowers, which has a downy involucre. (*Willd. Sp. Pl.*, iii. p. 1797.) A native of the south of France, which has been cultivated in Britain since 1573. It grows to the height of 2 ft. or 3 ft., and produces its yellow flowers in July. It was common in gardens in Gerard's time, who says it is acrid, bitter, and aromatic, and has much the same qualities as southernwood. It was formerly employed as a vermifuge, but is now disused.



835

2. S. (C.) SQUARRO'SA W. The squarrose (?-leaved) Santolina, or Lavender Cotton.

Identification. Willd. Sp. Pl., 3. p. 1798.; Ait. Hort. Kew., ed. 2. vol. 4. p. 517.
Synonymy. *Abrotanum foemina foliis Ericæ* Moris. *Hist.*, 3. p. 12. s. 6. t. 3. f. 17.
Engraving. Moris. *Hist.*, 3. t. 3. f. 17.

Spec. Char., &c. Branches tomentose. Leaves hoary, toothed; teeth awl-shaped, spreading in 4 rows. Peduncles bearing severally at the tip a single head of flowers, the involucre of which is glabrous. (*Willd. Sp. Pl.*, iii. p. 798.) A native of the south of Europe; cultivated in Britain since 1770; growing to the height of 1½ ft. or 2 ft., and producing its yellow flowers in July and August.

3. S. VIRIDIS W. The green Santolina, or Lavender Cotton.

Identification. Willd. Sp. Pl., 3. p. 1798.; Ait. Hort. Kew., ed. 2. vol. 4. p. 518.

Spec. Char., &c. Branches glabrous. Leaves glabrous, toothed; teeth awl-shaped, straight, in 4 rows. Heads of flowers solitary on the tips of peduncles. Involucre glabrous. (*Willd. Sp. Pl.*, iii. p. 1793.) A native of the south of Europe, and cultivated in Britain in 1727; growing 2 ft. or 3 ft. high, and flowering in July. This sort is very distinct from the common species, in its growing shoots, foliage, and peduncles being of a fresh green colour, and thus affording an obvious contrast to the hoary aspect of the common sort. Its leaves have, also, their segments more divaricate; and its heads of flowers, which are of a very pale yellow, are of greater diameter. It is an eligible kind of shrub for planting upon dry rockwork, in a sunny and sheltered situation, and, thus placed, will produce an abundance of flowers. Like most of the other sorts of this genus, it is rarely to be met with except in botanic gardens. It is, doubtless, one of the three kinds of *S. Chamæcyparissus* which were cultivated by Miller, and considered by him as species. (See Martyn's *Miller*.) There are plants in the collection of the Messrs. Loddiges, which, from their deep green foliage, appear distinct; but whether specifically so or not, we have not presumed to decide.



836

4. S. ROSMARINIFOLIA L. The Rosemary-leaved Santolina, or Lavender Cotton.

Identification. Lin. Sp., 1180.; Willd. Sp. Pl., 3. p. 1798.; Smith Exot. Bot., 2. p. 5. t. 62.; Ait. Hort. Kew., ed. 2. vol. 4. p. 18.
Engravings. Exot. Bot., 2. t. 62.; Encyc. of Plants, p. 695. f. 11655.; and our fig. 836.

Spec. Char., &c. Branches glabrous. Leaves linear; lower ones rather downy, tubercled on the margin; upper ones glabrous, flat, entire. Heads of flowers solitary at the tips of peduncles. Involucre glabrous. (*Willd. Sp. Pl.*, iii. p. 1798.) A native of Spain, cultivated in Britain since 1683, and producing its yellow flowers from July to September.

GENUS V.

**ARTEMISIA** Cass. THE ARTEMISIA. *Lin. Syst. Syngenesia Superflua.*

Identification. Cassini, according to Lessing in his *Synop. Gen. Compos.*, p. 264.; *Ait. Hort. Kew.*, ed. 2. v. 5. p. 2.

Derivation. From *Artemis*, one of the names of Diana; or, as some suppose, from *Artemisia*, the wife of Mausolus: there is a cypress-like and drooping character in some of the species, that may be associated with the latter etymology.

Description. Woody or suffrutescent evergreen plants, natives of Europe and Asia; all of them highly fragrant and aromatic, and all of them of the easiest culture in any dry soil.

■ 1. *A. ABROTANUM* L. The Abrotanum Artemisia, or Southernwood.

Identification. *Lin. Sp.*, 1185.; *Willd. Sp. Pl.*, 3. p. 1818.; *Ait. Hort. Kew.*, ed. 2. vol. 5. p. 3.

Synonyms. *Abrotanum mas Dod. Pempt.*, 21.; Old Man; Armoise Aurone, Aurone des Jardins, la Citronelle, la Garderobe, Fr.; Eberraute, Wermuth, Stabwurtz, Gartenwurtz, Ger.; Abrotano, Ital., Span., and Port.

Derivation. The Greek name for this plant is Abrotonon, which is variously derived, from *abroton*, incorruptible; from *abroton*, unfit for food; from the soft delicacy (*abrotés*) of its appearance; or from *abros*, soft, and *tonos*, extension, because it is extended, or grows, in a very soft manner. Why Linnaeus and others write it Abrotanum, is not known. The name of Old Man, doubtless, has reference to its grey and powdery appearance. It is called Garderobe in French, from its being used to prevent moths from getting into clothes, dresses, and wardrobes. Eberraute is boar's rue; and Wermuth, wormwood; Stabwurtz means staff root; and Gartenwurtz garden root.

Engravings. Blackw., t. 55.; *Woodv.*, 356. t. 119.; and our fig. 837.

Spec. Char., &c. Stem straight. Lower leaves bipinnate, upper ones pinnate, with the segments hair-like. Calyxes pubescent, hemispherical. (*Willd. Sp. Pl.*) A native of Italy, Spain, the south of France, Silesia, and Carniola, in Europe; and of Siberia, Syria, Galatia, Cappadocia, China, and Cochinchina, in Asia. In a wild state, it is seldom found above 3 ft. or 4 ft. high; and, in mountainous situations, not above half that height, with the branches recumbent. In British gardens it sometimes attains the height of 5 ft. in deep dry soil. Its flowers, which are yellowish, and of little show, appear from August to October. This plant was known to the Greeks, by whom it was called abrotonon; and it is mentioned in Turner as being cultivated in almost every English garden in his time. Gerard recommends it as aromatic; and, according to Allioni, the branches dye wool a deep yellow. In modern times, it is almost confined to the gardens of farmers and cottagers, where it ranks with thyme, rosemary, and mint, for its fragrance; but it is a very useful plant for suburban gardens, as it will bear the smoke and want of free air of cities without the slightest injury. The leaves, when held against a strong light, will be found full of transparent dots; in which it is probable the odorous matter contained in the plant will be found.

*Varieties.*

■ *A. A. 2 humile* Hort. is a low-growing spreading shrub, found on mountains in the south of Europe, and retaining its dwarf habit for some years in British gardens.

■ *A. A. 3 tobolskiannum* Hort., *A. tobolskianna* Lodd. *Cat.*, was introduced from Siberia in 1820, or before, and is a much more vigorous-growing variety, and larger in all its parts, than the species. There are plants in the arboreturns at Hackney and Goldworth. This plant has elegant foliage, consisting of finely divided leaves.

■ 2. *A. SANTONICA* L. The Santonica Artemisia, Tartarian Southernwood, or Worm-seed.

Identification. *Lin. Sp.*, 1185.; *Woodv.*, 335.; *Willd. Sp. Pl.*, 3. p. 1826.; *Ait. Hort. Kew.*, ed. 2. vol. 5. p. 5.

Synonyme. *Artemisia fruticosa*, &c, *Gmel. Sib.*, 2. p. 115. t. 51.

Engravings. *Gmel. Sib.*, 2. t. 51.; *Woodv.*, 335. t. 123.; *Encyc. of Plants*, p. 11697. f. 1698.; and our fig. 838.

Spec. Char., &c. Stem somewhat branched. Leaves compoundly divided; those of the stem pinnate, linear, glabrous. Flowers about 5 in a head. Heads almost sessile, disposed unilaterally and reflexedly in spikes, which are in panicles. (*Willd. Sp. Pl.*) A native of Siberia, Tartary, and Persia. It has been cultivated since 1596 in British gardens, where it grows to the height of 1 ft., forming a low spreading bush, and producing abundance of whitish green flowers from September to November. The leaves are very small, linear, and undivided. The seeds of this species were formerly imported from the Levant, under the name of *semen santonicum*, or worm-seed; but the plant is now little used in medicine. It is, however, tonic, and stomachic; and, like many other plants now neglected, may be found useful to practitioners who depend for drugs on their own resources.



■ 3. *A. ARBORESCENS* L. The arborescent *Artemisia*, or *Tree Wormwood*.

Identification. *Lin. Sp.*, 1188.; *Willd. Sp. Pl.*, 3. p. 1820.; *Ait. Hort. Kew.*, ed. 2. vol. 5. p. 3.

Synonyms. *Absinthium arborescens* *Lob. Ic.*, 1. p. 753.; *Abisynthe*, or *Armoise en Arbre*, *Fr.*

Engravings. ? *Park. Theatr.*, 93. f. 3.; *Lob. Icon.*, t. 753.

Spec. Char., &c. Leaves tripinnatifid, silky, grey; segments linear. Flowers in globose heads, that are borne on simple branchlets. (*Willd. Sp. Pl.*) A native of the Levant, Portugal, and the south of France, principally on the sea shore, where it grows to the height of 6 ft. or 8 ft., and produces its yellowish green flowers from June to August. The whole plant so much resembles the common wormwood, that Linnæus considered it only a variety of that species. It was cultivated in British gardens in 1640; Gerard calls it the greater, or female, southernwood, and says that, "by careful manuring, it doth oftentimes grow up in manner of a shrub, and cometh to be as high as a man, bringing forth stalks an inch thick, or more, out of which spring very many sprigs, or branches, set about with leaves, diversely jagged, and finely indented, somewhat white, and of a certain strong smell." This species makes a fine strong plant, and a fit associate for the strong-growing variety of the common southernwood. There are plants of this species in the Horticultural Society's Garden, in the Chelsea Botanic Garden, and in the arboretum of Messrs. Loddiges; and it well deserves a place, with *A. Abrotanum* and *A. procera*, in collections. Plants are 1s. 6d. each.

App. i. Other hardy Species of *Artemisia*.

In our *Hortus Britannicus*, several species will be found indicated as ligneous and hardy; but, in general, they are of such humble growth, and so imperfectly ligneous, that, for all practical purposes, they may be more fitly considered as herbaceous plants; unless we except *A. procera*, which is said to grow 8 ft. high, but which appears to us to be nothing more than *A. arborescens*.

App. ii. Half-hardy Species of *Artemisia*.

The same remarks that we have applied to the hardy ligneous species in the preceding Appendix will apply to those which are half-hardy. Though there are a dozen or more of them enumerated in our *Hortus Britannicus*, they are almost all too low to be considered otherwise than as herbaceous plants. The most interesting of these is *A. argentea* *Ait. Hort. Kew.*, 3. p. 170., *L' Hérit. Serl. Angl.*, t. 28., *N. Du Ham.*, 6. t. 36., and our fig. 839. This species has bipinnated silky white leaves, with lanceolate linear leaflets. The flower heads are globose, and the flower-bearing branches wand-like. The whole plant is of a silvery colour. It is a native of Madeira, whence it was introduced in 1777; and, in British green-houses, it grows to the height of 4 ft. or 5 ft., producing its yellowish green flowers in June and July. This is by far the handsomest species of the genus, and it used formerly to be very common in green-houses. If placed, under favourable circumstances, against a conservative wall, it would make a fine appearance, associated with such shrubs as *Anthyllis Barba Jovis*.



GENUS VI.



HELICHRYSUM Lessing. THE HELICHRYSUM, or EVERLASTING FLOWER.
Lin. Syst. Syngenesia Superflua.

Identification. Less. Synops. Gen. Compos., p. 274.

Synonymy. Part of *Gnaphalium* *Lin. Gen. Pl.*, 1752, as adopted in *Ait. Hort. Kew.*, ed. 2. vol. 5. p. 10.

Derivation. From *hēlios*, the sun, and *chrysos*, gold; in reference to the blossoms.

1. *H. STÆCHAS* D. Don. THE *Stæchas Helichrysum*, or common shrubby
 Everlasting Flower.

Identification. D. Don; Loud. Hort. Brit.

Synonymy. *Gnaphalium Stæchas* *Lin.*, *Willd. Sp. Pl.*, 3. p. 1803., *Ait. Hort. Kew.*, ed. 2. vol. 5. p. 12.; *Stæchas citrina* *Dod. Pempt.*, 268.

Engravings. Barrel. Icon., t. 410.; Blackw., t. 438.; Encyc. of Plants, p. 1699. f. 11756.

Spec. Char., &c. Branches twiggly. Leaves linear. Heads of flowers in a compound corymb. (*Willd. Sp. Pl.*, as *Gnaphalium Stæchas*.) A native of Germany, France, and Spain. It was cultivated in Britain in 1629, where it grows to 2 ft. or 3 ft. high, and produces its yellow flowers from June to October. It is a low evergreen shrub, with long, slender, irregular branches, the lower ones having blunt leaves, $2\frac{1}{2}$ in. long, and an eighth of an inch broad at the end; those on the flower stalks are very narrow, and end in acute points; and the whole plant is very woolly. The flowers terminate in a compound corymb; the calyxes are at first silvery, but afterwards turn to a yellow sulphur colour. If the flowers are gathered before they are much opened, the heads will continue in beauty many years if kept from air and dust. The plant is of easy culture in dry calcareous soils; but it requires to be placed in a warm sheltered situation; and, north of London, it will, in many places require a conservative wall. This species is now scarcely to be procured in any of the London nurseries, though some years ago there were plants of it in the Hammersmith collection.

App. i. *Half-hardy Species of the Helichrysum.*

H. fruticans D. Don; *Astelma fruticans* *Bot. Reg.*, t. 726.; *Gnaphalium fruticans* *L.*; *G. grandiflorum* *Bot. Rep.*; and our fig. 840.; is a native of the Cape of Good Hope, growing to the height of 3 ft., and producing its yellow flowers from June to August.

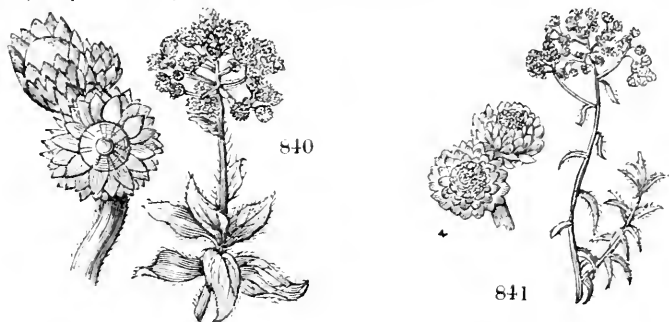

H. congestum D. Don; *Gnaphalium congestum* *Lam.*, *Bot. Reg.*, t. 253.; and our fig. 841.; is a native of the Cape of Good Hope, growing 3 ft. high, and producing its purplish flower heads in May and June. Various other species of this genus, and of closely allied genera, are suitable for the base of a conservative wall, or for conservative rockwork. *H. apiculatum*, *H. crassifolium*, *H. diversifolium*, *H. ericoides*, and some other species, are in the collection of Messrs. Loddiges.

GENUS VII.



CINERÀRIA *Lessing.* THE CINERARIA. *Lin. Syst. Syngenesia Supérflua.*

Identification. Less. Synops. Gen. Compos., p. 389.

Synonymes. Cinceraire, *Fr.*; Aschenpflanze, *Ger.*

Derivation. From *cineres*, ashes; the surface of the leaves being covered with down.

2. 1. C. MARI'TIMA L. The Sea-side-inhabiting Cineraria, or the Sea Ragwort.

Identification. Lin. Sp., 1244.; Willd. Sp. Pl., 3. p. 75.; Ait. Hort. Kew., ed. 2. vol. 5. p. 75.

Synonymes. Cinerària *Dod. Pempt.*, 642.; *Jacobæa maritima Bonp.*; Sicilian Ragwort.

Engravings. Flor. Græc., t. 871.; Park., 689. f. 7.; Lob. Icon., 2272.; Ger. Emac., 280. f. 4.

Spec. Char., &c. Leaves pinnatifid, tomentose beneath; the lobes obtuse, and each consisting of about 3 obtuse lobelets. Flowers in panicles. Involucre tomentose. (*Willd. Sp. Pl.*) A native of the south of Europe, on the sea coast and on rocks. It grows about Vaucluse, in the cliffs of the perpendicular rock, above the spring. It was cultivated in Britain in the time of Gerard and Parkinson, and was by these authors, and by Miller, erroneously considered as indigenous. It is a suffruticose plant, with rambling branches, growing, in dry soil and a warm situation, 3 ft. or 4 ft. high, and producing its yellow ragwort-like flowers from June to August. Unless planted in very dry soil, it is liable to be killed to the ground in severe winters; but such is the beauty of its whitish, large, and deeply sinuated foliage, at every season of the year, that it well deserves a place against a conservatory wall, where it may be placed near *Solanum marginatum*, and any other ligneous whitish-leaved species of that genus.



842

App. i. Half-hardy Species of Cinerària.

There are numerous species of Cinerària, which are somewhat ligneous, and are frame or green-house plants, of low growth, flowering in April or May; and, where there is a rockwork susceptible of being protected during the winter season, these may be tried upon it. *C. cruenta* (fig. 842.), perhaps rather herbaceous than suffruticose, though so marked in our *Hort. Brit.*, *C. bictæa*, *C. canescens*, *C. hybrida*, *C. populifolia*, *C. bicolor*, *C. lanata* (fig. 843.), *C. gcifolia* (fig. 844.), and *C. amelloides* L., *Agathæa cœlestis* Cas. (figs. 845, 846.), may be mentioned as examples. All these species seed freely, and also mule together; so that abundance of plants may be easily raised, which may be preserved in a frame through the winter, and turned out in the spring.



843

844

845



846

App. I. *Half-hardy Genera belonging to the Order Compositæ.*

Though there are few plants belonging to the order Compositæ, whether hardy or half-hardy, which are truly ligneous, yet there are a number which are suffruticose; and which, though usually kept in the frame, green-house, or even stove, may be tried, with every prospect of success, at the base of a conservative wall, or on rockwork which is capable of being protected during winter. We shall notice the genera to which these belong in the order in which they are given in Lessing's *Synopsis*, and chiefly refer for the species to our *Hortus Britannicus*.

Carlowizia salicifolia Mœnch, *Onobroma salicifolia* Link, is a native of Madeira, growing to the height of 2 ft. It is an erect shrub, with hoary leaves, resembling those of a willow.

Arctotis L. This is a very interesting family consisting of undershrubs, all natives of the Cape of Good Hope, and very splendid when in flower. The colour of the rays is yellow, orange, purple, or white. Several, or perhaps all, of them might partly be preserved at the base of a conservative wall.

A. aspera L. (*Bot. Reg.*, t. 34.) has yellow rays, and grows to the height of 3 ft., flowering from June to September.

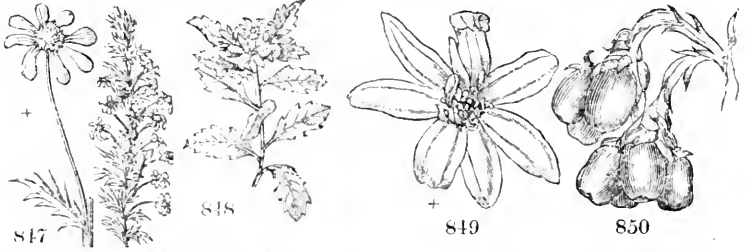

Didelta canosum and *D. spinosum* H. K. are Cape shrubs, growing to the height of 3 ft., and flowering in June and July.

Berckheya Ehrh. is a Cape genus, of which there are 7 suffruticose species introduced, which grow to the height of 3 ft., and produce their yellow flowers from June to August. *B. grandiflora* W. (*Bot. Mag.*, t. 1844.) is often in collections.

Cullinia R. Br. is a Cape genus of evergreen undershrubs, of which 3 species have been introduced, which grow to the height of 2 ft., and produce their bright yellow flowers from May to August.

Otkõna is a Cape genus, of which there are numerous low undershrubs, evergreen, some of them rising as high as 3 ft. *O. flabellifolia* Bot. Cab., t. 728. *O. virginica* L. and our fig. 847.; *O. pinnata* Bot. Mag., t. 768.; *O. pectinata* Bot. Mag., t. 366.; and *O. coronopifolia*; are species frequent in collections.

Ostospermum is a Cape genus of low evergreen shrubs, growing to the height of 8 ft. or 10 ft., and producing their yellow flowers from April to August. Several of them are figured in our *Encyclopædia of Plants*; and *O. pistiferum* L. (*Bot. Cab.*, t. 470.; and our figs. 848, 849, and 850.) will give a some idea of the general appearance of the genus.

Calendula is a genus of which several species are natives of the Cape, and are evergreens, rising as high as 2 ft. or 3 ft., producing yellow flowers from April to August. All the species are beautiful. *C. chrysanthemifolia* Ven. (*Bot. Reg.*, t. 40.; and our fig. 851.), may serve to exemplify the genus.

Mutisia Car. This is an exceedingly interesting genus of shrubby climbers, with leaves terminating in tendrils, by the prehension of which the stems are supported.

The species are natives of South America, and only three of them, as far as we know, have yet been introduced. *M. latifolia* D. Don in *Brit. Fl.-Gard.*, 2d ser., t. 288., and our fig. 852., is a native of Valparaiso, which has flowered in a frame at Kilmington Rectory, Wilts. The flowers are pale pink and yellow, and the leaves cordate-oblong, ending in a scollop, or notch, the midrib of the leaf being extended up the blade of the leaf, through the centre of the notch, and being continued into a tendril 3 in. long. *M. arachnoidea* Mart. (*Bot. Mag.*, t. 2705.) is a native of Brazil, with red flowers, produced in July and August. A plant, apparently of the former species has stood out three winters in the Clapton Nursery, without the slightest protection, and appears perfectly hardy. *Mutisia latifolia* represents a family of climbers so very different from every other hitherto propagated in British



gardens, that we cannot but strongly recommend it for trial against every conservative wall.

Dahlia Cav. There is an arborescent species of this genus, which, in Mexico, is said to grow as high as 40 ft. A plant of it was introduced into the Liverpool Botanic Garden in 1835, and it was seen in the August of that year by Dr. Neill of Canonmills Cottage, who describes it as "a cutting, resembling a middle-sized trunk or small stem of an elder bush, as thick as a man's leg, and fully as woody as the elder. It was throwing out leaves very like those of our herbaceous species." (*Gard. Mag.*, vol. xi. p. 680.) On applying to Mr. Shepherd for information respecting this plant, he says nothing of the plant alluded to by Dr. Neill, but informs us that he has "a very fine plant, on a south wall, where it does better than in a green-house." He also informs us that, in the Walton Nursery, there are a fine old plant, and several young ones for sale; and that, in the green-house of C. Taylure, Esq., there is a plant from 11 ft. to 14 ft. high. We also learn from Messrs. Lodiges, that they received the tree dahlia, a few years ago, from Mexico, but afterwards lost it. Mr. McNab informs us that there are plants of it in the Edinburgh Botanic Garden; and Mr. Campbell, that there is one in the Botanical and Horticultural Garden at Manchester.

Atalánthus pinnátus D. Don (*Prenánthes pinnata* Lin.) is a native of Teneriffe, growing to the height of 3 ft., and producing its yellow flowers in June and July.

Sonchus fruticosus Jacq. Icon., t. 1. p. 161., and our fig. 853., is an evergreen suffruticose plant, a native of Madeira, which grows to the height of 4 ft., and produces its yellow flowers from April to July. It is a very handsome plant during the summer season, both on account of its large leaves and its showy flowers. A few years ago, there were plants in the conservatory of the Cambridge Botanic Garden.



Vernonia acutifolia Hook. (*Bot. Mag.*, t. 3062.) is an evergreen shrub, a native of South America, growing to the height of 4 ft., and producing its pale purple flowers in December.

Aster L. Of this genus there are upwards of 20 species introduced, which are technically considered as subligneous, suffruticose, or somewhat woody. Of these the most remarkable is *A. argophyllum* Lab. (*Bot. Mag.*, t. 1563.; and our fig. 854.), a native of Van Diemen's Land, which grows to the height of 10 ft., and produces its white flowers from May to July. It is very hardy, and sometimes stands out in the open border, in the neighbourhood of London, for five or six years, without any protection whatever. The whole plant has a white aspect, and smells strongly of musk. This is the *Haxtonia argophylla* of Caley. (See *First Addit. Supp. to Hort. Brit.*)

A. angustifolius Jacq. Sch., 3. t. 370., is a native of the Cape of Good Hope, which grows to the height of 6 ft., and produces its pale blue flowers from May to July. *A. aculeatus* Lab. (*Bot. Cab.*, t. 830.; and our fig. 855.) is a native of New Holland, which grows to the height of 2 ft. or 3 ft., and produces its white flowers from March to July.

Chrysocoma Comakrea L. (*Bot. Mag.*, t. 1972.; and our fig. 856.) is a native of the Cape, where it grows to the height of 6 ft. It is an old inhabitant of our green-houses, and produces its yellow flowers from June to August. There are five or six other shrubby species, natives of the Cape, of still humbler growth.

Brachylaena nereifolia Swt. (*Baccharis nereifolia* Lin.) is a Cape evergreen undershrub, growing to the height of 4 ft., and producing its white flowers from August to November.

Conyza carolinensis Jacq. Icon., t. 585., is an evergreen shrub, a native of Carolina, growing to the height of 5 ft., and producing its purple flowers from July to October. There are several other frame and green-house suffruticose species; but few of them exceed a foot in height.

Podánthus Mitiqui Lindl., and our fig. 857., is a low evergreen shrub, a native of Chili, which grows to the height of 8 ft. or 10 ft., and produces its yellow flowers from August to November. It was introduced in 1824;



and plants have stood against the wall in the Horticultural Society's Garden for 6 years, and been found perfectly hardy.

Culcitium salicinum Spr., *Cacalia salicina* Lab., (*Bot. Rep.*, t. 923; and our fig. 862.) is a New Holland' shrub, with succulent leaves; evergreen; growing to the height of 6 ft.; and producing its yellow flowers in June and July.



857



858



Cacalia L. is a genus of which there are several suffruticose species, with succulent leaves, varying in height from 1 ft. to 6 ft., all of which might be tried on conservative rockwork.

Franzeria artemisioides W., and *F. ambrosioides* Cav. *Icon.*, 2. t. 200., are natives of Peru and Mexico, growing to the height of from 4 ft. to 6 ft., and producing their greenish flowers from July to September.

Edera proliфера Thunb. (*Bot. Mag.*, t. 1637.) is an evergreen undershrub, a native of the Cape, growing to the height of 3 ft., and producing its yellow flowers in May and June.

Pyrithrum Sm. is a genus of which several species, natives of the Canadas and Teneriffe, are suffruticose, grow to the height of 3 ft., and produce their white flowers all the year. *P. feniculaceum* W. *En. (Bot. Reg.)*, t. 272; and our fig. 863.) will give an idea of the species. In a late number of Sweet's *Brit. Fl. Gard.*, under the head of *Ismilia maderense*, it is remarked, that all the shrubby Teneriffe and Canary plants, hitherto considered as included in the genus *Pyrithrum*, will, probably, be found to belong to that of *Ismilia*.

Athanasia L. is a genus of evergreen undershrubs, natives of the Cape, of which *A. pubescens* L. (*Com. Hort.*, 2. 47.; *Encyc. of Plants*, p. 696. f. 11662.) is deserving of a place against a conservative wall. This plant grows to the height of 6 ft., and produces its yellow flowers from June to August.

Balsamita ageratifolia Desf. (*Alp. Ex.*, t. 326.) is a native of Candia, growing to the height of 2 ft., and producing its yellow flowers from June to October. It deserves a place against a conservative wall or rock.

Picntza flabelliformis W., *Tanacetum flabelliforme* L'Herit., (*Bot. Mag.* t. 212.) is an evergreen undershrub, a native of the Cape, which grows to the height of 4 ft., and produces its yellow flowers from May to August. It is interesting for its silvery fan-shaped leaves.

Eriocéphalus africanus L. (*Bot. Mag.*, t. 895.) is an evergreen Cape shrub, which grows to the height of 8 ft., and though not remarkable in its flowers, which are yellow, has yet very interesting leaves, which have a whitish hue, and are divided into narrow filaments, so as to somewhat resemble those of the southernwood; they are also odorous when slightly rubbed.

Senecio L. is a genus of which there are several Cape and South American species that are suffruticose and evergreen; and which, if planted in dry soil, against a wall, or on rockwork in a very warm situation, might probably admit of being protected during winter. In the warmest parts of Cornwall and Devonshire, some of the species are treated as border flowers, and found to be hardier than pelargoniums. *S. elegans plèna rubra* Bot. Mag., t. 238., has been so treated. *S. lilacinus* Link grows to the height of 6 ft., and flowers in June and July. It would form a most ornamental plant if trained to a wall.

Tarhonanthus camphoratus Lam. III., 671., is not rare in old botanical collections. It has whitish, somewhat ovate, leaves, with an odour more or less camphor-like. Planted out under a wall for the summer, it grows freely.

Eriocoma fragrans D. Don is a native of Mexico, beautiful in its panicles of white-rayed heads of fragrant flowers; and it has large leaves.

Various other genera of *Compositæ* afford half-hardy suffruticose species; but some of these are of such humble growth, that they are better adapted for being considered as half-hardy herbaceous plants than shrubs. Those, however, who wish to pursue the subject as far as it will go, may turn to the following genera in our *Hortus Britannicus* and *Gardener's Magazine*: — *Centaurea*, *Kentrophylum* (K. arbor. seeds is 6 ft. high), *Stobæa* (S. pinnata is 4 ft. high), *Baccharis*, *Cichorium*, *Rotandra*, *Nocca*, *Piqueria*, *Enpatariuin*, *Mikania*, *Amellus*, *Grimdèlia*, *Diplolappus*, *Nèja*, *Erigeron*, *Pleroma*, *Bhupthidmum*, *Diomida*, *Zerzemia*, *Montana*, *Lidbèekia*, *Achillèa*, *Tanacetum*, *Hippia*, *Cassinia* (C. leptophylla is very shrubby), *Erodia*, *Ozothamnus*, *Leucostemma*, *Aphelèris*, *Synærrha*, *Metalasia*, *Stacbe*, *Phænocoma*, *Leucra*, *Relhània*, *Osmites*, *Traxis*.



859

CHAP. LXVIII.

OF THE HALF-HARDY LIGNEOUS PLANTS BELONGING TO THE ORDER EPACRIDA'CEÆ.

STYPHĒLIA R. Br. is a genus of Australian shrubs, of an erect, stiff, and compact habit of growth; with leaves mucronate, on short petioles; and showy, crimson, pink, or green flowers. There are several species in our green-houses, as will be seen by our *Hortus Britannicus*. In height they vary from 3 ft. to 6 ft. or 8 ft.; and, like other hair-rooted plants, they thrive best in sandy loam mixed with sandy peat. Young cuttings, treated like those of *Erica*, root readily.

Stenanthëra piniifolia R. Br., Bot. Reg., t. 218.; *Styphëlia piniifolia* Spreng.; is an erect shrub, with acroese leaves, crowded together; and with axillary flowers, having a scarlet tube, and a greenish yellow limb. It is a native of New South Wales, growing to the height of from 4 ft. to 6 ft., and flowering from May to July. Like *Styphëlia*, from which it has been separated, it is a beautiful shrub when in flower, and well deserves a place against a conservative wall.

Cyathodes glauca Labil., *Trochocarpa glauca* Spreng., is a tree, a native of Van Diemen's Land, where it grows to the height of 25 ft. The leaves and appearance of the flowers resemble those of *Styphëlia*. *C. Oxycedrus* R. Br. and *C. acerosa* R. Br. are both natives of Van Diemen's Land, where they grow to the height of 5 ft. or 6 ft.; and they are occasionally to be met with in our green-houses.

Lissinthe sávida R. Br., Bot. Mag., t. 3147., is a low evergreen shrub, with oblong-linear mucronate leaves, and small white flowers, tipped with green, which appear in May. These are succeeded by berries, which are red and acid, and are made into tarts in New South Wales, under the name of cranberries. This species was introduced in 1823, and deserves a place on a conservative rockwork, as being one of the few plants of Australia which produce edible fruit. *L. subulata*, *L. strigosa*, *L. daphnoides*, and *L. ciliata* are also in British gardens.

Leucopogon lanceolátus R. Br.; *Styphëlia lanceolata* Smith; *S. parviflora* Andr. Bot. Rep., t. 287., *Suet. Fl. Austr.*, t. 47.; is an evergreen shrub, a native of New South Wales, on mountains, where it grows to the height of 12 ft., producing its white flowers from May to August. It has been in British green-houses since 1790, and is, doubtless, well adapted for a conservative wall.

L. Richei R. Br. (*L. polystachyus* Lodd. Bot. Cab., t. 1436.; *L. apiculátus* Smith; *L. parviflorus* Lindl. Bot. Reg., t. 1516.; and our fig. 860.); and *L. interruptus* R. Br., Bot. Cab., t. 1431.; with several others; are also in British collections, but do not grow to half the height of *L. lanceolátus*.

Monotoca R. Br. is a genus of Australian shrubs, of which *M. elliptica* R. Br., *M. albens*, *M. lineata*, and *M. scoparia* are in collections.

Trochocarpa laurina R. Br.; *Styphëlia cornifolia* Rudge, Hook. Bot. Mag., t. 3324., *Lin. Trans.*, s. t. 9., and our fig. 861.; is a tree, a native of New South Wales, with glabrous leaves, somewhat like those of *Laurus*; and small white flowers, in slender terminal or axillary spikes.

Epacris Smith is a genus of Australian shrubs, of great beauty, flowering in British green-houses throughout the winter, and some of them from January till July. They require to be grown in peat, and kept moist, and to be protected during severe weather. *E. grandiflora* Smith; *E. longiflora* Cav., Bot. Cab., t. 21., and our fig. 862.; is the tallest-growing species hitherto introduced of this genus. It grows to the height of 6 ft., and produces its scarlet and white flowers from January to June.

Lysinchæma R. Br. is a genus nearly allied to *Epacris*, of which there are 3 or 4 species introduced, and well deserving a trial against a conservative wall.

Andersônia R. Br. This is a genus of elegant New Holland shrubs, named by Mr. Brown, in memory of William Anderson, a surgeon of the royal navy, who accompanied Captain Cook; he paid great attention to botany. Descriptions of the genera of Van Diemen's Land plants, written by him, are still in the Banksian library. The genus is also intended to commemorate the late Alexander Anderson, formerly director of the Botanical Garden at St. Vincent; and William Anderson, the present curator of the Apothecaries' Botanical Garden at Chelsea.

A. sprengeliioides R. Br., Bot. Mag., t. 1645., Bot. Cab., t. 263., and our fig. 863., grows to the height of 3 ft., and produces its pink flowers from May to July. Like all the Epacridææ, it requires to be grown in sandy peat.

Sprengelia incarnata Bot. Cab., t. 262., is a shrub, resembling *Andersônia*, which grows to the height of 2 ft., and produces its flesh-coloured flowers from April to June. It is a native of Van Diemen's Land, and would probably succeed well on a conservative wall, or on conservative rockwork.

Sphenotoma gracilis Swt. Fl. Austr., t. 44.; *Dracophyllum grácile* R. Br.; is a native of New Holland, on the south coast; and, as it thrives perfectly well in a cold-pit, it would probably succeed on conservative rockwork.

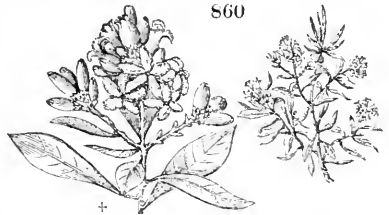

860



861



862



863

CHAP. LXIX.

OF THE HARDY LIGNEOUS PLANTS OF THE ORDER ERICACEÆ.

DISTINCTIVE Characteristics. Calyx and corolla each with 4—5 segments. Stamens 4—5—8—10, inserted variously, but alternately with the segments of the corolla where not more numerous than they. Anthers, in most, with 2 cells. Ovary with its cells, in most, agreeing in number with the segments of the calyx or corolla. Style and stigma undivided. Seeds many. Albumen fleshy. Embryo erect, slender. Shrubs (in *Rhododéndron arbóreum*, a timber tree); various in habit, inhabiting most parts of the world. (*Don's Mill.* and *Lindley's Introd. to N. S.*) This order contains many of the finest and most ornamental shrubs of the temperate regions of the world: all the species which compose it have hair-like roots, and require a peat soil, or a soil of a close cohesive nature, but which is yet susceptible of being readily penetrated by the finest fibrils which belong to any kind of plants. Peat, thoroughly rotted, leaf-mould, or very fine loamy sand, are soils of this description, and are accordingly required, more or less, for all the plants of this order. The hair-like roots of the Ericacæ soon suffer, either from a deficiency or a superfluity of moisture; and hence an important part of their culture in gardens consists in keeping the soil in which they grow equally moist. In transplanting hair-rooted plants, they are very apt to suffer from their slender fibrils coming in contact with the air: but, fortunately, these fibrils are so numerous, and so interlaced with each other, as to form a kind of network, which encloses and supports a portion of the soil in which they grow, and the plants are, consequently, almost always sent from the nurseries with small balls of earth attached to them. This practice, by continually diminishing the quantity of peat earth in a nursery, occasions a demand for a continual supply of this expensive soil, and, consequently, tends to increase the price charged for plants of the Ericacæ. On the other hand, the adhesion of the soil to the roots answers an economical purpose, as it does not require the plants to be grown in pots for the convenience of sending them out; since many of them may be taken up and carried to a distance, at any season, and even, if it were necessary, when in full flower, without sustaining much injury. All the species are readily propagated by seeds, layers, or cuttings.

The following characteristics of the genera, and of the groups which they form, are deduced from *Don's Miller*, in which the whole order has been remodeled by Professor Don.

Sect. I. ERICÆÆ.

Sect. Char. Calyx not connate with the ovary, except in *Gaulthéria*. Disk nectariferous, hypogynous. Fruit, in most, a capsule. Inflorescence, in the bud state, naked.

§ i. ERICÆÆ NORMALES. *Calyx and Corolla each with 4 Segments. Corolla permanent. Stamens 8. Fruit with 4 Cells.*

ERICA D. Don. Corolla globose, or pitcher-shaped. Filaments capillary. Anthers not protruded beyond the corolla, bifid; the cells short, opening by an oblong hole, awned or crested at the base, or, in a few, without any appendage. Stigma peltate. Leaves needle-shaped, scattered, or in whorls.

GYPSOCALLIS Sal. Corolla bell-shaped, or shortly tubular. Filaments flat. Anthers protruded beyond the corolla, 2-parted; the cells without any appendage at the base, distinct, each on a short stalk, and opening by an oblique hole. Stigma simple. Leaves needle-shaped, in whorls.

CALLUNA Sal. Corolla shorter than the calyx, bell-shaped. Filaments dilated. Anthers not protruded beyond the corolla, with two small appen-

dages at the base : their cells end in a point, and open lengthwise. Stigma capitate. "Capsule concealed by the inflexed, permanent calyx, orbicular, a little depressed, with 4 furrows, 4 simple valves, and 4 cells; the partitions simple, flat, alternate, and unconnected with the valves, fixed vertically to a large, ovate, pitted, permanent, central column." (*Smith, Eng. Flora*, ii. p. 224.) Leaves arrow-shaped at the base, obtuse at the tip; in transverse section triangular, imbricate in 4 rows.

§ ii. ANDROME`DEÆ. *Corolla deciduous. Stamens, in most, not protruded beyond the Corolla.*

A. *The following 7 Genera have all been instituted out of the Genus Andromeda; and all have 10 Stamens, 1 Pistil, and Fruit that has a loculicidal Dehiscence.*

ANDRO`MEDA L. Calyx with 5 acute segments. Corolla globose, with a contracted, 5-toothed mouth. Filaments bearded. Anthers with short, 1-awned cells. Stigma truncate. Leaves linear-lanceolate. Flowers in terminal, umbel-like groups.

CASSI`OPE D. Don. Calyx with 5 leafy segments, imbricate at the base. Corolla bell-shaped, 5-cleft. Filaments glabrous. Anthers with short, tumid, 1-awned cells. Style dilated at the base. Stigma obtuse. Capsule with its valves bifid at the tip. Small heath-like shrubs. Leaves imbricate. Flowers solitary.

CASSA`NDRA D. Don. Calyx with 2 bracteas at its base; its segments 5, leafy, imbricate at the base. Corolla oblong, with a contracted 5-toothed mouth. Filaments glabrous. Anthers with cells elongated at the tip, and tubular there. Stigma annulated. Leaves with short petioles, and elliptic oblong disks, that have peltate scales on both surfaces. Flowers axillary, disposed as if in racemes along the terminal parts of the branches.

ZENO`BLA D. Don. Calyx 5-toothed. Corolla bell-shaped, with a revolute 5-lobed limb. Filaments glabrous. Anthers with cells clongate, tubular, and 2-awned at the tip. Stigma truncate. Leaves dilated, with the margins usually toothed. Flowers in racemes.

LYO`NIA Nutt. Calyx 5-parted. Corolla ovate or tubular, with a contracted, 5-toothed mouth. Filaments short, flat, downy. Anthers with membranous cells that open lengthwise. Style 5-cornered. Stigma obtuse. Capsule 5-cornered. Flowers for the most part terminal, disposed in racemose panicles.

LEUCO`THÖE D. Don. Calyx with 5 leafy segments, imbricate at the base. Corolla tubular, toothed. Filaments flat, downy. Anthers with short truncate cells. Stigma large, capitate. Flowers white: in racemes.

PI`ERIS D. Don. Calyx 5-parted. Corolla tubular or ovate, with a contracted, 5-toothed, revolute mouth. Filaments dilated, furnished with 2 bristles at the tip. Anthers with short incumbent cells that open lengthwise. Style 5-cornered. Stigma truncate. Leaves coriaceous. Flowers drooping, terminal, racemose.

B. *Capsule with the Dehiscence septicidal.*

PHYLLO`DOCE Sal. Calyx with 5 segments. Corolla globose, with a contracted, 5-toothed mouth. Stamens 10, not protruded out of the corolla. Filaments slender, glabrous. Anthers with short, truncate cells. Stigma peltate with 5 tubercles.

DABÆ`CLA D. Don. Calyx with 4 segments. Corolla oval, inflated; its mouth 4-toothed. Stamens 8, enclosed. Filaments dilated, glabrous. Anthers linear, sagittate at the base, their cells parallel, loosened at the apex, opening lengthwise. Stigma truncate. Capsule 4-celled.

C. *Calyx and Corolla each with 5 Segments. Stamens 10, not protruded beyond the Corolla.*

AR`BUTUS Camer. Corolla globose or ovate, with a small reflexed border. Anthers compressed at the sides, opening at the tip by 2 pores, fixed by the

- back beneath the tip, and there furnished with 2 reflexed awns. Ovary with 5 cells, ovules in each cell many. Berry externally granulate.
- ARCTOSTA'PHYLOS** *Gal. Adans.* All as in *Arbutus*, except that the fruit is not externally granulate, and that the cells, 5 in number, include each but 1 seed.
- PERNETTYA** *Gaudichaud.* Corolla globose, with a revolute limb. Anthers with the 2 cells 2-lobed at the tip, the lobes bifid. Hypogynous scales 10, 3-lobed, surrounding the ovary. Berry with 5 cells, and many seeds.
- GAULTHERIA** *L.* Corolla ovate, inflated. Anthers bifid at the tip, each lobe with 2 awns. Ovary half-inferior. Hypogynous (? perigynous) scales 10, usually united at the base. Capsule with 5 cells, the dehiscence loculicidal.
- EPIGE'VA** *L.* Corolla salver-shaped. Capsule with 5 cells.
- CLETHRA** *L.* Corolla so deeply 5-parted as to seem 5-petaled. Filaments membranous. Anthers, after a time, inflexedly pendulous, obverse and cordate at the base, and mucronate at the tip. Capsule with 3 cells, many seeds, and a loculicidal dehiscence.

D. *The Characteristics as under.*

- PHALEROCA'RPUS** *D. Don.* Calyx 4-cleft, with 2 bracteas at its base. Corolla short, campanulate, 4-cleft. Stamens 8. Filaments ? hairy. Anthers semibifid. Hypogynous disk 8-lobed or 8-toothed.

Sect. II. *RHODO'REE.*

- Sect. Char.* Calyx not connate with the ovary. Disk nectariferous, hypogynous. Buds of inflorescence resembling strobiles in form, and in being scaly. Leaves flat, callous at the extremity of the midrib.
- RHODODE'NDRON** *D. Don.* Calyx 5-parted. Corolla somewhat funnel-shaped, 5-cleft. Stamens 5—10. Anthers opening by terminal pores. Capsule 5-celled, 5-valved, opening at the tip.
- KA'LMIA** *L.* Corolla of the shape of a wide-spread bell, and with 10 cavities on the inside, in which the anthers of 10 stamens repose before shedding their pollen. Capsule 5-celled. Dissepiments marginal.
- MENZIE'SIA** *D. Don.* Calyx 4-cleft. Corolla globose, 4-cleft. Stamens 8. Capsule 4-celled, 4-valved, having the dissepiments formed from the inflexed margins of the valves.
- AZA'LEA** *D. Don.* Calyx 5-parted. Corolla bell-shaped, 5-cleft. Stamens 5. Cells of anthers opening lengthwise. Capsule 5-celled, 5-valved, opening at top.
- LEIOPHY'LLUM** *Pers.* Calyx and corolla deeply 5-parted. Stamens 10, exerted. Anthers lateral, opening lengthwise on the inside. Capsule 5-celled, 5-valved, opening at the tip.
- LE'DUM** *L.* Calyx minute, 4-toothed. Corolla in 5 segments, so deep as to seem petals. Stamens 5—10, exerted. Anthers opening by pores at the tip. Capsule 5-celled, 5-valved, opening at the base. Seeds terminating in a wing at each end.
- Sect. III. *VACCINIE'E.*
- Sect. Char.* Calyx connate with the ovary. Disk nectariferous, perigynous. Fruit a berry.
- VACCI'NIUM** *L.* Calyx 4—5-toothed. Corolla pitcher-shaped or bell-shaped, 4—5-cleft. Stamens 8—10. Anthers 2-horned, opening at the tip, and in some furnished at the back with spreading spurs or bristles. Berry globose, 4—5-celled, many-seeded.
- OXYCO'CCUS** *Pers.* Calyx 4-cleft. Corolla 4-parted, with the segments somewhat linear and revolute. Stamens 8. Filaments conniving. Anthers tubular, tripartite. Berry 4-celled, many seeded.

GENUS I.



ERICA D. Don. THE HEATH. *Lin. Syst.* Octándria Monogýnia.

Identification. D. Don in Edinb. New Phil. Journ., 17. p. 152.; Don's Mill., 3. p. 790.

Synonymy. *Erica* sp. of Linnæus and other authors.

Derivation. The *erica* of Pliny is altered from the *ereikō* of Theophrastus, which is derived from *ereikō*, to break; from the supposed quality of some of the species, of breaking the stone in the bladder.

Description. Evergreen shrubs, with needle-like leaves, and hair-like roots; natives of Europe and Africa; varying in height from 6 in. to 2 ft. or 3 ft.; a number of them growing as high as 6 ft., and some few of them, as *E. austràlis* and *E. arborea*, attaining the height of 12 ft. or 15 ft. In British gardens, they are propagated by cuttings taken from the points of the growing shoots, and planted in pure sand, and covered with a hand-glass or a bell-glass. Many of the species of this genus are propagated more readily by seeds, than by layers or by division of the plant. They are all, without exception, eminently beautiful; and almost all are absolute in their choice of soil, which is that of sandy peat or heath mould; and of the situation in which they will grow, which should be elevated and airy, yet not arid. The price of plants, in British nurseries, varies from 6d. to 2s. 6d. each; at Bollwyller, the only hardy species is *E. cinèrea*, which is 1 frane and 50 cents; and none appear to be cultivated as hardy in the nurseries of New York.

1. *E. TETRALIX* L. The four-leaved Heath.

Identification. *Lin. Sp.*, ed. 2. p. 507.; *Curt. Fl. Lond.*, f. 1. t. 21.; *Smith in Engl. Bot.*, t. 1314.; *Fl. Dan.*, t. 81.; *Don's Mill.*, 3 p. 792.; *Lodd. Cat.*, ed. 1836.

Synonymy. *E. botuliformis* *Sat.* in *Lin. Soc. Trans.*, 4. p. 369.; *E. barbárica* *Raii Syn.*, 471.; *E. pàmila* *Park. Theatr.*, 1483. No. 5.; *E. Tétralix rubra* *Hort. Eric. Woburn.*, p. 25.; the cross-leaved Heath.

Engravings. *Curt. Fl. Lond.*, fasc. 1. t. 21.; *Eng. Bot.*, t. 1314.; and our *fig.* 864.

Spec. Char., &c. Plant of a greyish hue. Leaves ciliated, 4 in a whorl. Flowers in terminal heads. Corolla ovate-globose, about 3 lines long, downy at the tip outside. Spurs of anthers lanceolate. (*Don's Mill.*, iii. p. 792.) Native of the north of Europe, in boggy or moory ground; plentiful in Britain. It is the badge of the clan Macdonald.

Varieties.

1. *E. T. 1 rubra* *Hort. Eric. Woburn.*, p. 25. — Corolla pale red. (*Don's Mill.*, iii. p. 792.)

2. *E. T. 2 carnea* *Loudon's H. B.* — Corolla of a flesh colour.

3. *E. T. 3 álba* *Hort. Eric. Woburn.*, p. 25.; *Ait. Hort. Kew.*, ii. p. 393. — Corolla white.

4. *E. T. 4 Mackaiàna*, *E. Mackaiàna* *Bab.*, *Fl. Hiber.*, p. 181., *Mag. Nat. Hist.*, ix. p. 127., *Comp. Bot. Mag.*, i. p. 225., is a native of Ireland. It has the leaves and calyx of *E. ciliàris*, and the flowers of *E. Tétralix*.



864

2. *E. CINE'REA* L. The grey Heath.

Identification. *Lin. Sp.*, ed. 2. p. 501.; *Ait. Hort. Kew.*, 2. p. 392.; *Fl. Dan.*, 38.; *Don's Mill.*, 3. p. 795.; *Lodd. Cat.*, ed. 1836.

Synonymy. *E. mutábilis* *Salish.* in *Lin. Trans.*, 4. p. 369.; *E. hùmilis* *Neck. Gall.*, 182.; *E. tenuifolia* *Ger.*, 1198., *Emac.*, 1382.; *E. cinèrea rubra* *Edf. Hort. Eric. Woburn.*, p. 5.

Engravings. *Curt. Fl. Lond.*, fasc. 1. t. 25.; *Loefl. Res.*, p. 137.; *Smith Engl. Bot.*, t. 1015.; and our *fig.* 865.

Spec. Char., &c. Leaves 3 in a whorl. Corolla ovate-urceolate. Flowers verticillate, on the naked stems. Crests of anthers ear-formed. Corolla 3 lines long, purple, changing to blue as it fades. This is easily distin-

gushed from *E. Tétralix* by the glaucous deep green hne, and deep purple, or sometimes white, flowers. (*Don's Mill.*, iii. p. 795.) A shrub, growing from 6 in. to 1 ft. in height; a native of Europe, but not in the south, nor in the extreme north; beautiful in Britain. It is the badge of the clan Macalister.

Varieties.

- *E. c.* 2 *atropurpurea* Lodd. Bot. Cab., 1409. — Plant dwarf. Flowers deeper purple.
- *E. c.* 3 *álba* Lodd. Cat. — Flowers white.
- *E. c.* 4 *pállida* Lodd. Bot. Cab., 1507. — Flowers pale purple.
- *E. c.* 5 *carnescens* Lodd. Cat. — Flowers flesh-coloured.
- *E. c.* 6 *prolifera* Lodd. Cat. — Flowers proliferous.
- *E. c.* 7 *stricta* Lodd. Cat. — Branches erect.



■ 3. *E. ARBO'REA* L. The Tree Heath.

Identification. Lin. Sp., ed. 2. p. 502; Ait. Hort. Kew., p. 402; Smith et Sibth. Fl. Græc., t. 351; Don's Mill., 3. p. 794.

Synonymes. *E. scopária* Thunb. Diss., No. 80, Pl., Lin. Sp. ed. 2. p. 353, exclusive of the synonymes; *E. cæfra* Lin. Diss., No. 22, with a figure; *E. triflora* Berg. Pl. Cap., p. 118; *E. procæra* Sal. in Lin. Soc. Trans., 328.

Engravings. Fl. Græc., t. 351; Lin. Diss., No. 22.

Spec. Char., &c. A tree-like shrub, with tomentose branches. Leaves 3—4 in a whorl, linear, glabrous. Flowers axillary, racemose, glabrous. Bractæas remote from the calyx. Corolla bell-shaped, 2 lines long, white. Anthers crested. Style prominent. (*Don's Mill.*, iii. p. 794.) A native of the south of Europe. Introduced in 1658, and growing to the height of from 10 ft. to 20 ft. in the Pyrenees. In Britain, this species is generally considered somewhat tender; nevertheless, in sheltered situations, it endures the open air, as a standard, in the climate of London, and is only killed down to within a short distance of the ground, in the most severe winters; and this, we believe, is more owing to the moisture of the atmosphere in autumn, and the sudden changes from frost to sunshine in spring, than to lowness of temperature. In the Pyrenees this shrub is found growing among pine woods along with the arbutus, the myrtle, &c., and we have no doubt whatever, that it would thrive perfectly well in the pine woods in England; for example, those in the neighbourhood of Esher, on the Claremont estate, and those at Woburn Abbey. There are plants at Syon 12 ft. high; one in the Edinburgh Botanic Garden, as a standard, 5 ft. high, and against a wall, 16 ft. high.

Varieties.

- *E. a.* 2 *stylòsa*. — Style very long. (*Don's Mill.*)
- *E. a.* 3 *squarrosa* Hort. — Leaves squarrose. (*Don's Mill.*)
- *E. a.* 4 *minima* Hort. — Plant small. (*Don's Mill.*)

The succeeding sort might be added as another variety; but we have followed Don's *Miller* in giving it in the form of a species.

■ 4. *E. (A.) POLYTRICHIFOLIA* Sal. The Polytrichum-leaved Heath.

Identification. Sal. in Lin. Soc. Trans., 6. p. 329; Don's Mill., 3. p. 794.

Synonyme. Perhaps only a variety of *E. arborea* (*Don's Mill.*, 3. p. 794.) Dr. Lindley has incidentally expressed, in *Bot. Reg.*, t. 1698, as his opinion, that the *E. arborea stylòsa* of English gardens is the *E. polytrichifolia* of Salisbury.

Spec. Char., &c. Stem tomentose. Leaves 3—5 in a whorl. Flowers terminal. Bractæas remote from the calyx. Calyxes gradually narrowed at the base. Corolla 1—2 lines long. Spurs of anthers cuneated. Fruit pear-shaped. (*Don's Mill.*, iii. p. 794.) A native of Portugal, about Lisbon, and rather more tender than the species. It is to be found in some collections; but when it was introduced is uncertain.

■ 5. *E. (A.) CODONODES* Lindl. The bell-shaped-flowered Heath.

Identification. Lindl. in Bot. Reg., t. 1698.

Engravings. Bot. Reg., t. 1698; and our fig. 866.

Spec. Char., &c. The general appearance of this sort, Dr.

Lindley observes, is that of *E. arborea*; but it seems essentially distinct from that species, in its longer flowers, more slender leaves, less hardy branches, and truly bell-shaped corolla, which has by no means the globular form of that of *E. arborea*; its stigma is, moreover, very small, and not at all dilated or lobed, either when dried or recent. It was cultivated in 1834, in the Maresfield Nursery, in Sussex, where it is quite hardy, and forms a bush from 10 ft. to 12 ft. in height. It begins to blossom in February, and continues till the end of May, disregarding both frost and snow, being often covered with flowers from top to bottom, and forming a most beautiful object. In the warmest parts of Devonshire, and in the south of Ireland, it would form a very ornamental undergrowth to fine woods.



■ 6. *E. AUSTRALIS* L. The southern Heath.

Identification. Lin. Mant., p. 231.; Andr. Heaths, 3. t. 21.; Ait. Hort. Kew., 2 p. 366.; Lodd. Bot. Cab., t. 1472.; Wendl. Eric., 9. p. 13., with a figure; Don's Mill., 3. p. 795.; Lodd. Cat., ed. 1836.
Synonyme. *E. pistillaris* Sal. in *Lin. Soc. Trans.*, 6. p. 368.
Engravings. Andr. Heaths, 3. t. 21.; Bot. Cab., t. 1472.; Wendl. Eric., 3. p. 13., with a figure; and our fig. 867.

Spec. Char., &c. A shrub, 3 ft. to 6 ft. high. Leaves 4 in a whorl, scabrous, spreading, mucronate. Flowers terminal, small. Corolla purplish red, 3 lines long, with a curved funnel-shaped tube, and a recurved limb. Pedicels beset with gemmaceous bracteas. Anthers crested. (*Don's Mill.*, iii. p. 795.) A native of Spain and Portugal; introduced in 1769, and, in the neighbourhood of London, forming a handsome pyramidal shrub, of which there are specimens at Syon 7 ft. high, and in the Edinburgh Botanic Garden 10 ft. high. One of the most showy of all the arboreous heaths, producing in great profusion its fine red flowers from April to August.

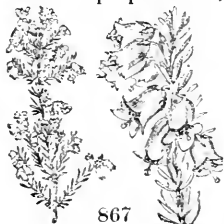

■ 7. *E. STRICTA* Donn. The upright Heath.

Identification. Donn Hort. Cantab., ed. 3. p. 69.; Willd. Sp., 2. p. 366.; Andr. Heaths, 2. t. 22.; Ait. Hort. Kew., 2. p. 393.; Don's Mill., 3. p. 796.; Lodd. Cat., ed. 1836.
Synonyms. *E. multicaulis* Sal. in *Lin. Soc. Trans.*, 6. p. 369.; *E. corsica* Dec. Fl. Fr.; *E. ramulosa* Viv.
Engravings. Andr. Heaths, 2. t. 22.; and our fig. 868.

Spec. Char., &c. Stem diffuse, 2 ft. to 3 ft. high. Leaves 4 in a whorl, obtuse, glabrous, having 2 furrows beneath. Flowers terminal, in umbel-like groups. Bracteas approximate to the calyx, sessile. Calyx spreading. Corolla purplish red, 3 lines long, with an ovate pitcher-shaped tube, and reflexed segments. Anthers crested. Style a little prominent. (*Don's Mill.*, iii. p. 796.) A native of Corsica and Italy. Introduced in 1765, and frequent in gardens, forming a fastigiate bush, in some instances, as at Purser's Cross, as high as 12 ft.



■ 8. *E. CILIARIS* L. The ciliate-leaved Heath.

Identification. Lin. Sp., ed. 1. p. 354.; Læff. Res., p. 138.; Lin. Diss., No. 39., with a figure of the flower; Wendl. Eric., 7. p. 3.; Curt. Bot. Mag., t. 484.; Ait. Hort. Kew., 2. p. 394.; Lodd. Bot. Cab., t. 1808.; Don's Mill., p. 798.; Hook. Brit. Flora, p. 176.; Lodd. Cat., ed. 1836.
Engravings. Lin. Diss., No. 39., with a figure of the flower; Bot. Mag., t. 484.; Bot. Cab., t. 1805.; Eng. Bot. Suppl., t. 2618.; and our fig. 869.

Spec. Char., &c. Leaves 3 in a whorl, ovate, glandularly ciliate, spreading, rather remote. Flowers terminal, subracemose, directed to one side. Bracteas sessile, approximate to the calyx. Segments of calyx spatulate, ciliate. Corolla smooth, ovate, more ventricose on the upper side, 4 lines

long, pale red. Style prominent. (*Don's Mill.*, iii. p. 799.) A native of Portugal, and of England, in Cornwall. This comparatively rare species, Sir W. J. Hooker observes, is always found in boggy places, and never on dry ground. "It is unquestionably the most interesting and beautiful addition that has been made to our British flora for many years. The flowers are as large as those of *Menziesia cærulea* Wall., *Phyllodoce taxifolia* Sal., and more highly coloured; while the leaves are elegantly fringed with hairs, and each hair is tipped with a gland." (*Brit. Flor.*, p. 177.) The usual height is about a foot. A hybrid between this species and *E. Tétralix* is noticed in p. 1079.

869



■ 9. *E. SICULA* Schonberg. The Sicilian Heath.

Identification. Schonberg in Linnæa, 2. p. 614.; *Don's Mill.*, 3. p. 799.

Spec. Char., &c. A shrub, 2 ft. to 3 ft. high. Leaves 4 in a whorl, linear, nearly cylindrical, canescent. Flowers erect, canescent, on long pedicels, in terminal umbel-like groups. Bracteas and segments of calyx membranous, coloured, about as long as the corolla. Corolla ovate, oblong, downy, red. (*Don's Mill.*, iii. p. 799.) A native of Sicily. Introduced in 1819; but we have not seen the plant.

GENUS II.



GYPSOCALLIS Sal. THE GYPSOCALLIS, or MOOR HEATH. *Lin. Syst.* Octándria Monogýnia.

Identification. Salisbury's MSS.; D. Don in Edinb. New Phil. Journ., 17. p. 153.; *Don's Mill.*, 3. p. 800.

Synonymic. *Erica* sp. of other authors.

Derivation. "From *gypsos*, lime, and *kallistos*, most beautiful; the plants [kinds] are very elegant, and generally inhabit calcareous districts." (*Don's Mill.*)

Description, &c. The species are mostly undershrubs, not exceeding 1 ft. in height; but *G. mediterranea* (*E. mediterranea* L.) grows to the height of 10 ft. or 12 ft., or upwards.

■ 1. *G. VAGANS* Sal. The wandering Gypsocallis, or Cornish Moor Heath.

Identification. Sal. MSS.; D. Don in Edin. New Phil. Journ., 17. p. 153.; *Don's Mill.*, 3. p. 800.

Synonymes. *E. vágans* *Lin. Mant.*, 2. p. 230., *Lin. Syst.*, 570., *Eng. Bot.*, t. 3.; *E. vága* Sal. in *Lin. Soc. Trans.*, 6. p. 344.; *E. multiflora* Huds. *Fl. Anglica*, 166., *Bull. Fl. Par.*, t. 203.; *E. didyma* Stokes in *Withering's Bot. Arrangement*, 400.; *E. purpurascens* *Lam. Dict.*, 1. p. 488. *Engravings.* *Eng. Bot.*, t. 3.; *Bull. Fl. Par.*, t. 203.; and our *fig.* 870.

Spec. Char., &c. Stem glabrous. Leaves 4—5 in a whorl, contiguous, glabrous. Flowers small, upon footstalks, axillary, mostly 2 in an axil, and those of any branch seeming as if disposed in a raceme, from the flowers being stalked and produced from axils near one another. Bracteas remote from the calyx. Corolla short, bell-shaped, pale purplish red. (*Don's Mill.*, iii. p. 800.) A native of England, in Cornwall; and of the south of France and north of Africa.



870

Varieties.

■ *G. v. 2 pallida.*—Corolla pale red. (*Don's Mill.*)

■ *G. v. 3 rubescens* Bree, *Loud. H. B.*, ed. 2. p. 588.—Corolla rubescent. This must be near the preceding one, and may be identical with it.

■ *G. v. 4 purpurascens* Bree, *Loud. H. B.*, ed. 2. p. 588.—Corolla purplish.

■ *G. v. 5 alba.*—Flowers axillary. Corolla white. (*Don's Mill.*)

■ *G. v. 6 tenella.*—Flowers terminating the small branches. Corolla white. (*Don's Mill.*)

2. *G. MULTIFLO'RA* D. Don. The many-flowered Gypsocallis, or Moor Heath.

Identification. D. Don in Edinb. New Phil. Journ., July 1834; Don's Mill., 3. p. 801.

Synonymes. *Erica multiflora* Lin. Sp., ed. 1. p. 355., *Diss.*, No. 58., with a figure of the flower, *Andr. Heaths*, 2. t. 57., *Ait. Hort. Kew.*, 2. p. 367., *Lodd. Bot. Cab.*, t. 1572.; *E. juniperifolia*, &c., *Garidel. Aix.*, p. 160. t. 32.; *E. multiflora longi-pedicellata* Wendl. *Eric.*, fasc. 5. p. 7.; *E. peduncularis* Presl.

Engravings. Lin. *Diss.*, No. 58., a fig. of the flower; *Bot. Cab.*, t. 1572.; *Garid. Aix.*, p. 160. t. 32.; and our fig. 871.

Spec. Char., &c. Leaves 4—5 in a whorl, glabrous, linear. Flowers axillary, disposed in a racemose corymb. Bractees remote from the calyx. Corolla $1\frac{1}{2}$ to 2 lines long, pale red, bell-shaped, with a reflexed limb. Pedicel twice as long as the corolla. Anthers black, their orifices near the tip. (*Don's Mill.*, iii. p. 801.) A native of France, Spain, and of the south of Europe generally, and in cultivation in British gardens since 1731. It begins to flower in May or June; and, under favourable circumstances, continues to produce flowers in profusion till November or December. Like other heaths, to flower freely, it requires to be kept in a cool, open, airy situation, in which it will attain the height of 2 ft.



3. *G. CA'RNEA* D. Don. The flesh-colour-flowered Gypsocallis, or Moor Heath.

Identification. D. Don in Edinb. New Phil. Journ., July, 1834; Don's Mill., 3. p. 801.

Synonymes. *Erica carnea* Lin. Sp., ed. 2. p. 504., *Curt. Bot. Mag.*, t. 11., *Jacq. Fl. Austr.*, 1. p. 24. t. 31., *Scop. Fl. Carn.*, ed. 2. vol. 1. p. 275., *Lodd. Bot. Cab.*, t. 1452.; *E. herbacea* Lin. *Diss.*, No. 57., with a figure, *Lin. Sp.*, ed. 2. p. 501., *Wendl. Eric.*, 9. p. 7., with a figure; *E. saxatilis* Sal. in *Lin. Soc. Trans.*, 6. p. 343.

Engravings. *Bot. Mag.*, t. 11.; *Jacq. Fl. Austr.*, 1. f. 31.; *Bot. Cab.*, t. 1452.; *Lin. Diss.*, No. 57., with a figure; *Wendl. Eric.*, 9. p. 7., with a figure; and our fig. 872.

Spec. Char., &c. Stems and branches prostrate. Leaves 3—4 in a whorl, linear, glabrous, sharply reduplicate. Flowers axillary, drooping, disposed in racemes, and directed to one side, pale red. Bractees remote from the calyx. Corollas conical, $2\frac{1}{2}$ lines. Anthers with an orifice extending from the middle to the tip. (*Don's Mill.*, iii. p. 801.) A native of the south of Germany and Switzerland, and the north of Wales.



4. *G. MEDITERRA'NEA* D. Don. The Mediterranean Gypsocallis, or Moor Heath.

Identification. D. Don in Edinb. New Phil. Journ., July, 1834; Don's Mill., 3. p. 801.

Synonymes. *Erica mediterranea* Lin. *Mant.*, p. 229., *Diss.*, No. 59., with a figure of the flower, *Wendl. Eric.*, 7. p. 11., *Curt. Bot. Mag.*, t. 471.; *E. lugubris* Sal. in *Lin. Soc. Trans.*, 6. p. 343.

Engravings. Lin. *Diss.*, No. 59., with a figure of the flower; *Bot. Mag.*, t. 471.

Spec. Char., &c. A shrub 4—6 ft. high. Leaves 4—5 in a whorl, linear, cuculate, glabrous. Flowers axillary, disposed in the manner of a raceme, directed to the lower side, so nodding. Bractees above the middle of the pedicels. Corolla pitcher-shaped, red. Anthers dark, foraminose from the middle. (*Don's Mill.*, iii. p. 801.) Native of the south of Europe, in the region of the Mediterranean; and, in 1830, found wild at Cunnemara, on the western coast of Ireland, by Mr. Mackay. It grows there on a declivity by a stream, in boggy ground, at the foot of Urisberg Mountain, near Round Stone, on its western side, occupying a space of above half a mile in length, and covering between 2 and 3 acres of ground, in tufts of from 1 ft. to 2 ft. in height. (*Mag. Nat. Hist.*, iv. p. 167., and ix. p. 127.)

GENUS III.

CALLUNA *Sal.* THE CALLUNA. *Lin. Syst.* Octándria Monogýnia.

Identification. Salisbury in *Lin. Soc. Trans.*, 6. p. 317.; Don's Mill., 3. p. 828.

Synonymes. *Erica* sp. *Lin. and others.*

Derivation. The name of Calluna is derived from *kallunō*, which, as Sir J. E. Smith observes, "is doubly suitable; whether, with Mr. Salisbury and Dr. Hull, we take it to express a cleansing property, brooms being made of ling; or whether we adopt the more common sense of the word, to ornament or adorn, which is very applicable to the flowers." (*Eng. Flora*, 2. p. 224.)

2. *C. VULGARIS* *Sal.* The common Ling, or Heather.

Identification. Salisb. in *Lin. Soc. Trans.*, 6. p. 317.; Smith *Eng. Flora*, 2. p. 224.; Don's Mill., 3. p. 828.

Synonymes. *Erica vulgaris* *Lin. Sp.*, p. 501.; la Bruyère, *Fr.*; Heide, *Ger.*; Lyng, *Dan.*; Liung, *Sued.*; *Erica*, *Ital.*; Brezo, *Span.*; Urze, *Port.*; Weresk, *Russ.*

Engraving. *Eng. Bot.*, t. 1013.

Spec. Char., &c. Leaves 3-cornered in a transverse section of them, arrow-shaped at the base, obtuse at the point, revolute in the lateral margins, imbricate in 4 rows. Flowers disposed in long, terminal, spicate racemes. (*Don's Mill.*, iii. p. 828.) A small, spreading, evergreen shrub; native throughout Europe, plentiful in Britain.

Varieties. In Don's *Miller*, the following forms of this species are enumerated:—

- 2. *C. v. 1 purpurea.*—Flowers purplish red.
- 2. *C. v. 2 spuria.*—Branches tufted. Racemes short. Flowers purplish red.
- 2. *C. v. 3 decumbens.*—Branches decumbent. Racemes short. Flowers purplish red.
- 2. *C. v. 4 tomentosa.*—Leaves and branches woolly. Flowers purplish red.
- 2. *C. v. 5 alba.*—Flowers white, less crowded. Corolla shorter.
- 2. *C. v. 6 flore pleno.*—Flowers double, pale purplish red.
- 2. *C. v. 7 foliis variegatis.*—Leaves variegated. Flowers purplish.
- 2. *C. v. 8 aurea.*—Leaves variegated with yellow.
- 2. *C. v. 9 coccinea.*—Flowers deep red.
- 2. *C. v. 10 spicata.*—Racemes long. Flowers red or white.
- 2. *C. v. 11 and 12.*—Two varieties are mentioned by Sir W. J. Hooker, as being in cultivation in the Glasgow Botanic Garden, where they have retained their differences for years. They have both pubescent branchlets; but the one has deep red flowers, and was received from Aberdeenshire; and the other, which was received from Arran, has white flowers, that appear later than those of the other varieties. The first may be called *C. v. 11 atro-rubens*, and the second *C. v. 12 serotina*.

Description, &c. The common heath varies considerably in size, according to the soil and situation in which it grows. In open, elevated, exposed moors, where there is scarcely any surface soil, it seldom exceeds 1 ft. in height; but in sandy soils, in open woods, it often reaches the height of 3 ft. or 4 ft., growing erect. On the sides of mountains, in Scotland and Ireland, it sometimes forms a bed or close matting of recumbent or trailing stems, which are 3 ft. or 4 ft. in length; the bed extending for many miles together. The stems are bushy, and are repeatedly and irregularly branched. The plant is of slow growth, seldom making shoots longer than 3 in. or 4 in. in one season, even when young; and, when of 5 or 6 years' growth, not more than half that length; but it is of great duration.

Geography. The common heath abounds in almost every part of Europe,

more especially in the northern countries. It is found in Iceland, Greenland, and Kamtschatka, and in Nova Scotia and Newfoundland. In Britain, it flourishes best in the upland and moorland zones; but it descends to the sea level in the south of England. In the north, and on the Grampian Mountains, it grows at the height of 3000 ft. above the level of the sea. In deciduous copse-woods, it commonly gives place to *Facelinium Myrtillus*; but in open pine groves it maintains its ground. It covers extensive tracts in France and Germany, and it is common in all the temperate parts of the Russian empire, and probably, also, in Siberian Russia.

History. As some species of heath were known to the Greeks and Romans, it is not improbable that they were acquainted with the Calluna, though it is not included specifically in the plants of Theophrastus. It is mentioned by all the modern European writers on plants, and more especially by those of the northern parts of Europe, as its numerous names in northern languages imply. It is described by Gerard, who says that it is "the heath that the ancients took to be the right and true heath;" but he does not state his grounds for this assertion.

Properties and Uses. There are few plants, that are abundant in a state of nature, which man has not applied to a great variety of useful purposes. The most important use of the heath, throughout Europe, is as an herbage plant. In the Highlands of Scotland, in the north of Sweden, and in all heathy countries with an imperfect agriculture, cattle and sheep browse on the young shoots in the winter and spring, when they can procure no other food. It is true, these shoots are powerfully astringent, and not very nutritive; and they even affect the milk of cows not accustomed to eat them, and turn it red; but, nevertheless, they are valuable for keeping the animals alive till the season of pasture grass returns. According to some French agricultural writers, the mutton of sheep fed upon heath, or upon pastures in which the heath abounds, is of a richer flavour, and more nourishing, than that which is fed on grass only; and the wool of such sheep is said to be produced in larger quantities. Heath is used, both in Scotland and Sweden, for thatching houses, for heating ovens, for making besoms, scrubbing-brushes, and baskets; for weaving into fences, for covering underground drains, and for a great variety of rural purposes. In the Western Highlands, Dr. Walker informs us, it is twisted into ropes; and the walls of the cabins of the inhabitants of that bleak coast are formed with alternate layers of heath, and a sort of cement made of black earth and straw. The Highlanders there not only employ it in the walls of their houses, and for covering them instead of thatch, but they make their beds of it; and this was the case, in 1804, and may still be so, in the summer dwellings, called sheelings, on the Grampian Mountains, at no great distance from Perth. The walls of these summer lodgings are built of turf; and on the floor of the apartment, about 3 ft. from the wall, and parallel to it, a fence made of stakes, and twined with long heath, partitions off a space for sleeping in; and no other bedding is put into this space than a thick layer of heath. In most of the Western Isles, the inhabitants, in Pennant's time, dyed their yarn yellow by boiling it in water with the green tops and flowers of this plant: and woollen cloth boiled in alum water, and afterwards in a strong decoction of the tops, comes out of a fine orange colour. In some of these islands, leather is tanned in a strong decoction of heath. Formerly the young tops are said to have been used alone, to brew a kind of ale; and Boethius relates that this liquor was much used by the Picts. In some of the Western Isles, it is said, they still brew ale with one part malt, and two parts of the young tops of heath, sometimes adding hops. The flowers of heath of every kind abound in honey; and those of this and the other indigenous species are much frequented by bees. In various parts of Scotland and the north of England, bee-hives are carried, in the beginning of August, from the cultivated to the heathy districts, for the sake of the flowers; where they remain two or three months, and are brought back in the autumn. The wood makes excellent charcoal; and the ashes are rich in potass, which accounts for the diuretic properties of the plants. The

honey produced from the flowers of heath, and, indeed, from the *Vaccinium*, the *Azalea*, and the whole of the *Ericacææ*, is of a dark brown colour, and has a particular flavour, which, to some persons, is disagreeable, but to others is preferable to that of the low country honey. Medicinally, the shoots of the heath are considered diuretic and astringent; and, in Pliny's time, a decoction of the leaves of some species was considered a remedy for the bites of serpents: but the *Calluna*, at present, is not included in any materia medica. The branches of the heath afford shelter to many birds, and the seeds constitute a principal part of the food of the grouse, and other inhabitants of the moors. It is a remarkable circumstance, that the peculiar construction of the seed-vessel, with which, Sir J. E. Smith informs us, Gærtner was so much struck (see *Gen. Char.*, p. 1076. and p. 1077.), is calculated to retain the seed in it a whole year. The foliage of the heath, in England, affords nourishment to the larva of the *Phalæna quercus*, or the great egger moth. In England, it is also very liable to be encumbered by the smaller dodder (*Cuscuta Epithimum*); but neither of these enemies to the plant is common in Scotland. The principal use of the *Calluna*, in British gardens, is as an ornamental plant; and, in sandy or mossy soils, as an edging instead of box. In several gardens about Edinburgh, it is employed in this way; and is found not only to endure clipping as well, or better, than the box; but by forming a more compact edging, it is less apt to harbour snails and slugs. The most effectual mode of destroying heath, where it abounds on soil not worth subjecting to the plough, is to plant it with evergreen trees, such as the Scotch pine; which, when they have grown to a sufficient height to cover the surface, will effectually destroy it by their shade, and thus convert the plants into nourishment for the trees. When heathy ground has been subjected to the plough, it should never be kept in pasture for many years together, unless it is richly manured; for, as the seeds retain their vitality for many years, plants never fail, at the end of a few seasons, to make their appearance among the grass. In the improvement of heath soils, lime is always a principal ingredient; it being found necessary to neutralise the tannin and acid principles which exist in the mould formed by the decay of the heath.

Poetical Allusions, &c. This well-known plant, which covers so many acres of land, particularly in the north of England and Scotland, with its evergreen leaves and beautiful flowers, has been a favourite subject with many British poets, from Burns, whose

“ Moorcock springs,
On whirring wings,
Amid the blooming heather,”

to Mary Howitt, who gives a fine picture of

“ those wastes of heath,
Stretching for miles to lure the bee;
Where the wild bird, on pinions strong,
Wheels round and pours his piping song,
And timid creatures wander free.”

The heath is considered the emblem of solitude; but, from its frequent use as beds in the Highlands, its sweet and refreshing smell rather recalls ideas of social enjoyments and wild though hearty hospitality.

App. I. *List of hardy Species and Varieties of Ericacææ belonging to the Group Ericææ normales, of which Plants are cultivated for Sale in the Tooting Nursery; with some additional Names from the “ Hortus Woburnensis,” marked *.*

The Price of the greater number of sorts in this List is 1s. each, but a few of them are 1s. 6d. each.

Calluna vulgaris (*Erica* L.) *Eng. Bot.*, 1013. Height 1 ft. to 2 ft., Fl. red, June to August.

App. II. *Arrangement of the hardy Heaths included in the preceding List; showing which of them are in Flower, in the open Garden, every Month in the Year; and the Colour of the Flower, and Height of each.*

- January.*
 Gypsocállis cárnea. $\frac{1}{2}$ ft., pink.
 herbácea. Pink.
- February.*
 Èrica arbòrea. 9 ft., white.
 Gypsocállis cárnea. $\frac{1}{2}$ ft., pink.
 herbácea. Pink.
- March.*
 Èrica arbòrea. 9 ft., white.
 austràlis. 10 ft., red.
 Gypsocállis cárnea. $\frac{1}{2}$ ft., pink.
 herbácea. Pink.
 * mediterrànea. 4 ft., pink.
 hibèrnica. Pink.
- April.*
 Èrica arbòrea. 9 ft., white.
 austràlis. 10 ft., red.
 Gypsocállis cárnea. $\frac{1}{2}$ ft., pink.
 herbácea. Pink.
 Èrica mediterrànea. 4 ft., pink.
 scopària. 4 ft., green.
- May.*
 Èrica arbòrea. 9 ft., white.
 austràlis. 10 ft., red.
 mediterrànea. 4 ft., pink.
 scopària. 4 ft., green.
 Gypsocállis umbellàta. 3 ft., purple.
 Èrica víridi-purpùrea. 3 ft., green.
- June.*
 Èrica * Actæ'a. 2 ft.
 arbòrea. 9 ft., white.
 austràlis. 10 ft., red.
 * cinèrea álba. 1 ft., white.
 atropurpùrea. 1 ft., red.
 cárnea. 1 ft., flesh.
 rùbra. 1 ft., red.
 coccínea. 1 ft., red.
 Gypsocállis multiflòra álba. 2 ft., white.
 rùbra. Red.
 Dabæ'cia poliifòlia. 2 ft., purple.
 * nàna. $\frac{1}{4}$ ft., purple.
 álba. White.
 Èrica scopària. 4 ft., green.
 Tétralix álba. 1 ft., white.
 rùbra. 1 ft., red.
 Gypsocállis umbellàta. 3 ft., purple.
 Èrica víridi-purpùrea. 3 ft., green.
 Callùna vulgaris. 2 ft., red.
 álba. White.
 decùmbens. Red.
 flòre plèno. Purple.
 spùria. Red.
 variegàta. Red.
- July.*
 Èrica austràlis. 10 ft., red.
 ciliàris. 1 ft., pink.
 cinèrea álba. 1 ft., white.
 rùbra. 1 ft., red.
 Gypsocállis multiflòra álba. 2 ft., white.
 rùbra. Red.
 Dabæ'cia poliifòlia. 2 ft., purple.
 * álba. White.
 nàna. $\frac{1}{4}$ ft., purple.
 Èrica Tétralix álba. 1 ft., white.
 rùbra. 1 ft., red.
 Gypsocállis umbellàta. 3 ft., purple.
 vågans álba. 1 ft., white.
 rùbra. Red.
 Èrica víridi-purpùrea. 3 ft., green.
 Callùna vulgaris. 2 ft., red.
 álba. White.
 decùmbens. Red.
 flòre plèno. Purple.
 spùria. Red.
 variegàta. Red.
- August.*
 Èrica ciliàris. 1 ft., pink.
 cinèrea álba. 1 ft., white.
 rùbra. 1 ft., red.
 Gypsocállis multiflòra álba. 2 ft.,
 white.
 rùbra. 2 ft., red.
 Dabæ'cia poliifòlia. 2 ft., purple.
 * álba. White.
 nàna. $\frac{1}{4}$ ft., purple.
 Èrica strícta. 2 ft., pink.
 Tétralix álba. 1 ft., white.
 rùbra. 1 ft., red.
 Gypsocállis vågans álba. 1 ft., white.
 rùbra. Red.
 Èrica víridi-purpùrea. 3 ft., green.
 Callùna vulgaris. 2 ft., red.
 álba. White
 decùmbens. Red.
 flòre plèno. Purple.
 spùria. Red.
 variegàta. Red.
 ciliàris. 1 ft., pink.
- September.*
 Èrica cinèrea álba. 1 ft., white.
 rùbra. 1 ft., red.
 Gypsocállis multiflòra álba. 2 ft.,
 white.
 rùbra. Red.
 Dabæ'cia poliifòlia. 2 ft., purple.
 nàna. $\frac{1}{4}$ ft., purple.
 Èrica strícta. 2 ft., pink.

October.

Gypsocállis multiflòra álba. 2 ft., white.
 rubra. Red.
 Erica strícta. 2 ft., pink.

Gypsocállis multiflòra rubra. 4 ft.,
 Red.
 Erica strícta. 2 ft., pink.

November.

Gypsocállis multiflòra álba. 2 ft., white

December.
 Gypsocállis cárnea. $\frac{1}{2}$ ft. pink.
 herbàcea. Pink.

App. III. *List of Cape Heaths which will stand in the open Air, in Autumn, or the Middle of Winter, without Protection, with Fahrenheit's Thermometer 7 or 8 Degrees below Freezing, without suffering in any way from such a Degree of Cold.*

Taken from Mr. McNab's *Treatise on Cape Heaths*, published in 1832. The Prices appended by Messrs. Rollisson in 1836.

Callista acuminàta (Erica L.) *Bot. Cab.*, t. 216.; and our *fig.*

873. Ht. $1\frac{1}{2}$ ft., Fl. red, July to Oct. Price 1s. 6d.

2 pállida *Hort. Brit.* Ht. 1 ft., Fl. pale red, June to July.

comòsa *Hort. Kew. Icon.*, t. 18. Ht. $\frac{3}{4}$ ft., Fl. red, Ap. to Aug. Price 2s. 6d.

2 álba *Andr. Heath.*, v. t. 2. Ht. $\frac{3}{4}$ ft., Fl. red, June to August.

3 rubra *Wendl. Eric.*, xii. p. 7. ic. Ht. $\frac{3}{4}$ ft., Fl. red, June to August.

ferrugínea *Andr. Heath.*, v. t. 3. Ht. 1 ft., Fl. red, May to July. Pr. 7s. 6d.

hyacinthòides *Andr. Heath.*, v. t. 3. Ht. 1 ft., Fl. pink, June to Aug. Pr. 2s. 6d. In the Edinburgh Botanic Garden, in 1836, 2 ft. high.

tenuiflòra *Andr. Heath.*, v. t. 3. Ht. $1\frac{1}{2}$ ft., Fl. light yellow. Ap. to June. Pr. 2s. 6d.

2 álba *Hort. Brit.* Ht. 1 ft., Fl. white, Ap. to June.

3 *lùtea. Fl. yellow.

tetragòna (pugionifòlia *Sal.*) *Andr. Heath.*, v. t. 3. Ht. $1\frac{1}{2}$ ft., Fl. light yellow, July to Sep. Pr. 2s. 6d. In the Edinburgh Botanic Garden, in 1836, 3 ft. high.

ventricòsa *Bot. Mag.*, t. 350. Ht. 1 ft., Fl. flesh-cld., April to September. Pr. 2s. 6d. In the Edinburgh Botanic Garden, in 1836, 2 ft. high.

2 coccínea. Fl. scarlet.

7 erécta. Fl. flesh. In the Edinburgh Botanic Garden, in 1836, 6 ft. 3 in. high.

3 stellífera. Fl. flesh.

4 cárnea. Fl. flesh.

5 álba. Fl. white.

8 nàna. Fl. flesh.

6 supérba. Fl. scarlet.

9 hírsùta. Fl. flesh.

Ceràmia (Erica L.) serpyllifòlia *Lodd. Bot. Cab.*, t. 744.; and our *fig.* 874. Ht. $1\frac{1}{2}$ ft., Fl. white, June to July. Pr. 2s. 6d.

Dasyánthes (Erica L.) Sparmánni *Andr. Heath.*, v. t. 3. (dispera *A. H.*, hystericiflòra *L. T.*) Ht. 1 ft., Fl. dark orange, March to Sept. Pr. 2s. 6d. In the Edinburgh Botanic Garden, in 1836, 5 ft. high.

Désmia (Erica L.) conférta *Andr. Heath.*, v. t. 2.; and our *fig.* 875. Ht. $1\frac{1}{2}$ ft., Fl. white, Feb. to Oct. Pr. 2s. 6d.

Erica aggregàta *Wendl. Ertz.*, f. 13. No. 5.; and our *fig.* 876. Ht. $\frac{3}{4}$ ft., Fl. purple, July. Pr. 1s. 6d. In the Edinburgh Botanic Garden, in 1836, 3 ft. high.

2 álba *Hort. Brit.* Fl. white.

campanulàta *Andr. Heath.*, v. t. 1. Ht. 1 ft., Fl. yellow, April to August. Pr. 2s. 6d. In the Edinburgh Botanic Garden, in 1836, 2 ft. high.



873

874



875



876



- Erica cerinthoides* *Bot. Mag.*, t. 220. Ht. 4 ft., Fl. dark scarlet, May to Nov. Pr. 5s. In the Edinburgh Botanic Garden, in 1836, 5 ft. high.
- | | |
|---|--------------------------------------|
| 1 glabriuscula <i>Swt.</i> Fl. scarlet. | 4 minor <i>H. Wob.</i> Fl. red. |
| 2 hispida <i>Swt.</i> Fl. scarlet. | 5 * nana <i>H. Wob.</i> Fl. red. |
| 3 major <i>H. Wob.</i> Fl. red. | 6 superba <i>Roll.</i> Fl. pale red. |
- congesta *Wendl. Eric.*, f. 17. No. 5. Ht. 1 ft., Fl. white, June to July. Pr. 3s. 6d. In the Edinburgh Botanic Garden, in 1836, 2 ft. high.
- corifolia (articulãris *B. M.*, calycina *A. H.*) *Don's Mill.*, No. 76.; *Lámprotis corifolia* *Don's Mill.*, No. 2., has been called *Erica corifolia* *Bot. Mag.*, t. 422. Ht. 1½ ft., Fl. pale pink, Aug. to Dec. Pr. 2s. 6d.
- cupressina *Roll.* Ht. 1 ft., Fl. pale red, April to June. Pr. 2s. 6d.
- globosa *Andr. Heath.*, v. t. 4. Ht. 1½ ft., Fl. pink, July to September. Pr. 2s. 6d.
- glomerata *Andr. Heath.*, v. t. 4. Ht. 2 ft., Fl. pink, Feb. to April. Pr. 5s.
- gracilis *Wendl. Eric.*, s. p. 9. ic. Ht. ¾ ft., Fl. white, February to June. Pr. 1s. 6d.
- hispidula. Ht. 1 ft., Fl. pale red, June to Aug. Pr. 3s. 6d.
- leucanthera. Ht. ¾ ft., Fl. white, June to May. Pr. 2s. 6d. In the Edinburgh Botanic Garden in 1836, 4 ft. high.
- lucida *Andr. Heath.* v. t. 2. Fl. pink, April to June. ? *Lámprotis lucida* *Don's Mill.*, No. 13.
- margaritacea *Andr. Heath.*, v. t. 1. Ht. 1½ ft., Fl. white, May to Sept. Pr. 1s. 6d.
- montana. Ht. 2 ft., Fl. purple, Oct. Pr. 2s. 6d. In the Edinburgh Botanic Garden, in 1836, 1 ft. high.
- pendula *Lodd. Bot. Cab.*, t. 902. Ht. 1½ ft., Fl. purple, June to Aug.
- perlata. Ht. 1 ft., Fl. purple, March to Aug. Pr. 2s. 6d.
- pubescens. Ht. 1½ ft., Fl. purple, February to Dec. In the Edinburgh Botanic Garden, in 1836, 4 ft. high.
- | | |
|---|--|
| 1 major <i>H. Brit.</i> Fl. purple. | 3 pubescensior <i>H. Brit.</i> Fl. red |
| 2 minor <i>Roll.</i> Fl. red. Pr. 2s. 6d. | 4 verna <i>H. Wob.</i> Purple. |
- ramentacea *Andr. Heath.*, v. t. 1. Ht. 1½ ft., Fl. dark red, June to Dec. Pr. 1s. 6d.
- setacea *Andr. Heath.*, v. t. 1. Ht. 1¾ ft., Fl. white, Feb. to Ap. Pr. 2s. 6d.
- tenella *Andr. Heath.*, v. t. 2. Ht. 2 in., Fl. red, May to Aug. Pr. 1s. 6d.
- Eurýlepis* (*Erica* *L.*) *triflora* *Wendl. Eric.*, xii. p. 13. Ht. 1½ ft., Fl. white, March to June. Pr. 1s. 6d. In the Edinburgh Botanic Garden, in 1836, 3 ft. high.
- Gypsocallis* (*Erica*) *intertexta* *Lodd. Bot. Cab.*, t. 1034.; and our *fig.* 877. Ht. 1½ ft., Fl. yellow, June to July. Pr. 2s. 6d.



Gypsocallis longipedunculata Bot. Cab., t. 103. Ht. 1 ft., Fl. pink, July and Aug. Pr. 2s. 6d.



878

Gyp. nigrita Don's Mill., No. 46., *Andr. Heath.*, v. t. 1. Ht. $\frac{3}{4}$ ft., Fl. white, March to June. Pr. 2s. 6d. In the Edinburgh Botanic Garden, in 1836, 3 ft. high.

Pachysa physodes Bot. Mag., t. 443.; and our figs. 878, 879. Ht. $1\frac{3}{4}$ ft., Fl. white, March to July. Pr. 3s. 6d. In the Edinburgh Botanic Garden, in 1836, 3 ft. high.

Syringodea cruenta *Andr. Heath.*, v. t. 1. Ht. 2 ft., Fl. dark red, May to Sep. Pr. 2s. 6d. 2 *superba* Roll.



879

curviflora *Andr. Heath.*, v. t. 1. Ht. 2 ft., Fl. yellow, July and October. 1 *aurantia*. Fl. orange. 2 *rubra*. Fl. red.

diaphana Don's Mill., No. 2. *Andr. Heath.*, v. t. 4. Ht. $1\frac{1}{2}$ ft., Fl. pink, June to July. Pr. 2s. 6d.

Ewerana *Andr. Heath.*, v. t. 2. Ht. 2 ft., Fl. pink, July and October. Pr. 2s. 6d. In the Edinburgh Botanic Garden, in 1836, 8 ft. 6 in. high.

2 *glabra*. Fl. pink. 4 *longiflora*. Fl. red. 3 *speciosa*. Fl. red. 5 *pilosa*. Fl. red.

exudans Lodd. Bot. Cab., t. 287. Ht. $1\frac{1}{2}$ ft., Fl. red, October to Nov. Pr. 3s. 6d. In the Edinburgh Botanic Garden, in 1836, 4 ft. high.

grandiflora Bot. Mag., t. 189. Ht. 3 ft., Fl. yellow, May to Sep. Pr. 3s. 6d. In the Edinburgh Botanic Garden, in 1836, 6 ft. high.

1 *humilis*. Fl. yellow. 2 *superba*. Fl. yellow.

ignescens *Andr. Heath.*, v. t. 2. Ht. $1\frac{1}{2}$ ft., Fl. red, March to June. Pr. 1s. 6d. In the Edinburgh Botanic Garden, in 1836, 3 ft. high.

? *longiflora* Bot. Cab., t. 983. Ht. 2 ft., Fl. red, Ap. to Aug. Pr. 2s. 6d. *mammosa* *Andr. Heath.*, v. t. 1. Ht. 2 ft., Fl. purple, July to October.

Pr. 1s. 2d. In the Edinburgh Botanic Garden, in 1836, 5 ft. high.

2 *minor*. Fl. purple. 4 *rosea*. Fl. rose.

3 *pallida*. Fl. pale red.

? *tumida* Bot. Reg., t. 65., Don's Mill., No. 98. Ht. $1\frac{1}{2}$ ft., Fl. scarlet, May to Sep. Pr. 5s. In the Edinburgh Botanic Garden, in 1836, 3 ft. high.

verticillata *Andr. Heath.*, v. t. 1. Ht. 3 ft., Fl. scarlet, July to Oct. Pr. 1s. 6d. In the Edinburgh Botanic Garden, in 1836, 6 ft. 10 in. high.

2 *major*. Fl. scarlet.

viridescens Bot. Cab., t. 233. Ht. 1 ft., Fl. greenish, January to June. Pr. 1s. 6d.

App. IV. *List of Cape Heaths which are tenderer than those mentioned in the preceding List, and which, when exposed to the Degree of Cold there stated, will be injured by it, but will not suffer, although fully exposed to a Temperature 4 or 5 Degrees below Freezing.*

Taken from Mr. M' Nab's *Treatise on Cape Heaths*, published in 1832. The Prices appended by Messrs. Rollisson in 1836.

Blæria ericoides (synon. *Erica Blæria*) *Wendl. Coll.*, i. t. 25., Bot. Cab., 85., and our fig. 880. Ht. 2 ft., Fl. white, Aug. to Oct. Pr. 2s. 6d.

Callista (*Erica* L.) *comosa* *Wendl. Eric.*, 12. 7. ic. Ht. $\frac{3}{4}$ ft. Fl. red, April to Aug. Pr. 2s. 6d.

1 *alba*. Fl. white.

2 *rubra*. Fl. red.

Coventryana Lodd. Bot. Cab., t. 423. Ht. 1 ft., Fl. red, June to July. Pr. 3s. 6d.



880



- Callista daphneflora*. Ht. 1 ft., Fl. pale pink, June to Aug. Pr. 1s. 6d.
múndula *Lodd. Bot. Cab.*, t. 114. Ht. 2 ft., Fl. purple, February to October. Pr. 3s. 6d. In the Edinburgh Botanic Garden, in 1836, 2 ft. high.
 2 *màjor* *Lodd.* Fl. purple.
pellúcida *Andr. Heath.*, 2. Ht. 2 ft., Fl. white, June to November. Pr. 2s. 6d.
 2 *rùbra* *H. Wob.* Fl. red.
præ'gnans *Bot. Cab.*, t. 945. Ht. 2 ft., Fl. red, May to July. Pr. 1s. 6d.
 2 *coccínea* *H. Wob.*
Ceràmia (*Erica* *L.*) *urecolàris* *Icon. Hort. Kew.*, 16., and our *fig.* 881. Ht. 1½ ft., Fl. white, May to July. Pr. 1s. 6d.
 ? *articulàris* *Don's Mill.*, No. 25. Ht. 1 ft., Fl. red, May to June. Pr. 2s. 6d.
Ectasis *Sebàna*, *Erica* *Sebàna aurántia* *Andr. Heath.* v. t. 1. Ht. 2 ft., Fl. orange, March to June. Pr. 2s. 6d.
 2 *fúscà*. Fl. brown. 3 *lùtea*. Fl. yellow. 4 *mìnor*. Fl. orange.
Erica *assúrgens*. Ht. 1 ft., Fl. white., May to June. Pr. 1s. 6d.
barbàta *Andr. Heath.*, 2. Ht. 1 ft., Fl. white, May to Aug. Pr. 2s. 6d.
 2 *màjor*. Fl. red. 3 *mìnor*. Fl. red.
Bonplandiàna *Bot. Cab.*, t. 345. Ht. 1 ft., Fl. pale yellow, March to Sept. Pr. 2s. 6d. In the Edinburgh Botanic Garden, in 1836, 8 ft. 3 in. high.
 ? *càfra* *Bot. Cab.*, t. 19. Ht. 1½ ft., Flowers white, Feb. to Oct. Pr. 1s. 6d.
 2 *spicàta*. Fl. white.
cerinthòides *Bot. Mag.*, t. 220. Ht. 4 ft., Fl. dark scarlet, May to Nov. In the Edinburgh Botanic Garden, in 1836, 5 ft. high.
 1 *màjor* *H. Wob.* Fl. red. 3 *nàna* *H. Wob.* Fl. red.
 2 *mìnor* *H. Wob.* Fl. red.
decòra *Andr. Heath.*, v. t. 3. Ht. 2 ft., Fl. purple, Jan. to Nov. Pr. 5s.
depréssa *Andr. Heath.*, v. t. 2. Ht. ¾ ft., Fl. yellow, June to August. Pr. 5s. In the Edinburgh Botanic Garden, in 1836, 1 ft. 6 in. high.
mollíssima. Ht. 1 ft., Fl. white, May to June. Pr. 2s. 6d.
Persóluta *Bot. Mag.*, 342. Ht. 1 ft., Fl. purple, Feb. to May. Pr. 1s. 6d. In the Edinburgh Botanic Garden, in 1836, 3 ft. high.
 2 *álba*. Fl. white. 3 *rùbra*. Fl. red.
propéndens *Andr. Heath.*, v. t. 2. Ht. 1½ ft., Fl. purple, July to August. Pr. 2s. 6d.
pubéscens. Ht. 1½ ft., Fl. purple, Feb. to Dec. Pr. 1s. 6d.
 1 *màjor* *H. Wob.* Fl. pale red. 3 *vérna* *H. Wob.* Fl. pale red.
 2 *mìnor* *H. Wob.* Fl. pale red.
quadriflòra. Ht. 1 ft., March to Aug., Pr. 2s. 6d. In the Edinburgh Botanic Garden, in 1836, 3 ft. high.
refléxa. Ht. 1½ ft., Fl. white, May to June. Pr. 2s. 6d. In the Edinburgh Botanic Garden, in 1836, 5 ft. high.
 2 *rùbra*. Fl. red. In the Edinburgh Botanic Garden, in 1836, 5 ft. high.
rùbens (*pedunculàris* *Sal.*) Ht. 1 ft., Fl. purple, April to October. Pr. 1s. 6d. In the Edinburgh Botanic Garden, in 1836, 3 ft. high,
viscària *Icon. Hort. Kew.*, 1. Ht. 2½ ft., Fl. red, March to July. Pr. 1s. 6d.
cylíndrica *Bot. Cab.*, 1734. Ht. 2 ft., Fl. white, May to June. Pr. 1s. 6d. In the Edinburgh Botanic Garden, in 1836, 5 ft. high
divaricàta *Lodd.* Fl. white, Ap. to May, Pr. 2s. 6d. In the Edinburgh Botanic Garden, in 1836, 1 ft. high.
gélida *Bot. Cab.* 699. Ht. 3 ft., Fl. green, Ap to June. Pr. 1s. 6d.



Erica incarnata Andr. *Heath.*, 1. Ht. 1 ft., Fl. pale red, Feb. to June. Pr. 1s. 6d. In the Edinburgh Botanic Garden, in 1836, 2 ft. high.

trivialis M'Nab.

Eurýlepis (*Erica* L.) *álbens* Bot. *Mag.*, t. 440., and our fig. 882. Ht. 1½ ft., Fl. white, March to Aug. Pr. 2s. 6d. In the Edinburgh Botanic Garden, in 1836, 3 ft. high.

Halicácaba Andr. *Heath.*, v. t. 2. Ht. 1 ft., Fl. yellow, May to Aug. In the Edinburgh Botanic Garden, in 1836, 2 ft. high.

Eurystègia (*Erica* L.) *triceps* Bot. *Cub.*, 62., and our fig. 883. Ht. 1 ft., Fl. white, May to June. Pr. 2s. 6d.

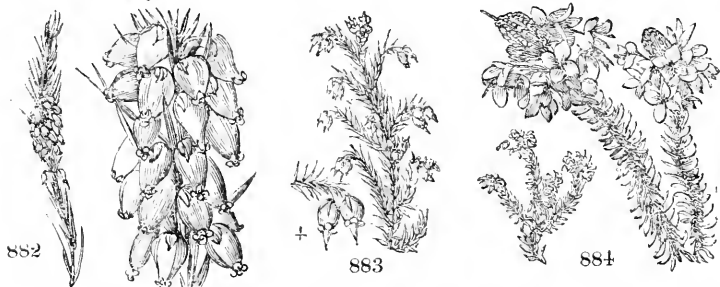

Gypsocállis (*Erica* L.) *nudiflora* Smith *Icon.* 3. 7. Ht. 2 ft. Fl. dark yellow, July to Aug. Pr. 1s. 6d. In the Edinburgh Botanic Garden, in 1836, 3 ft. high.

Lophándra (*Erica* L.) *cúbica* Andr. *Heath.*, v. t. 1., and our fig. 884. Ht. 1 ft., Fl. purple, Ap. to July. Pr. 1s. 6d.

2 minor. Fl. red.

3 major Hort. *Brit.* Fl. purple.

Lámprotis (*Erica* L.) *calycina* Andr. *Heath.*, 3., and our fig. 885. Ht. 2 ft., Fl. purple, May to July. Pr. 3s. 6d.

2 major H. *Wob.* Fl. pale red.

Páchysa (*Erica* L.) *báceans* Bot. *Mag.*, t. 358 Ht. 1½ ft., Fl. purple, Ap. to June. Pr. 1s. 6d. In the Edinburgh Botanic Garden, in 1836, 4 ft. high.

Syringòdea (*Erica* L.) *abiétina*. Sep. to March. Pr. 1s. 6d.

? *clavæflora* Don's *Mill.*, No. 91., Andr. *Heath.*, v. t. 2. Ht. ½ ft., Fl. green, Aug. to October. Pr. 2s. 6d.

colòrans Bot. *Reg.*, t. 601., Bot. *Cub.*, 224. Ht. 2 ft., Fl. white, Ap. to June. Pr. 1s. 6d. In the Edinburgh Botanic Garden, in 1836, 4 ft. high.

concinna Andr. *Heath.*, v. t. 2. Ht. 2½ ft., Fl. flesh., Sep. to Oct. Pr. 1s. 6d. In the Edinburgh Botanic Garden, in 1836, 4 ft. high.

díscolor Andr. *Heath.*, v. t. 1. Ht. 2 ft., Fl. red, March to Nov. Pr. 2s. 6d.

elàta Andr. *Heath.*, v. t. 2. Ht. 3 ft., Fl. orange, July to Sep. Pr. 2s. 6d. In the Edinburgh Botanic Garden, in 1836, 6 ft. high.

Eweràna Andr. *Heath.*, v. t. 2. Ht. 2 ft., Fl. pink, July to Oct. Pr. 2s. 6d. In the Edinburgh Botanic Garden, in 1836, 8 ft. 6 in. high.

2 glàbra. Fl. pink.

4 longiflora. Fl. red.

3 speciòsa. Fl. red.

5 pilòsa. Fl. red.

Linnaèana (*linnaèoides* Andr. *Heath.*, v. t. 2.; *perspicua* Hort. *Kew.*) Ht. 1½ ft., Fl. purple, Jan. to May. Pr. 1s. 6d. In the Edinburgh Botanic Garden, in 1836, 4 ft. high.

2 supérba. Fl. purplish white.



- Syringödea linnæoides* Andr. Heath., v. t. 2. Ht. 1½ ft., Fl. purplish white, April to May. Pr. 2s. 6d. In the Edinburgh Botanic Garden, in 1836, 5 ft. high
- perspícua* *Wendl. Eric.*, 1. 7. ic. Ht. 1½ ft., Fl. white, March to June. Pr. 2s. 6d. In the Edinburgh Botanic Garden, in 1836, 3 ft. high.
- 2 *nàna*. Fl. white.
- radiàta* *Andr. Heath.*, v. t. 1. Ht. 1 ft., Fl. crimson, August to November. Pr. 3s. 6d. In the Edinburgh Botanic Garden, in 1836, 3 ft. 9 in. high.
- 2 *díscolor*. Fl. whitish red.
- simpliciflòra* *Wendl. Eric.*, 17. p. 69. ic. Ht. 2 ft., Fl. orange, March to July. Pr. 1s. 6d. In the Edinburgh Botanic Garden, in 1836, 4 ft. high.
- spicàta* *Andr. Heath.*, v. t. 1. Ht. 2½ ft., Fl. light yellow, All the year. In the Edinburgh Botanic Garden, in 1836, 3 ft. high.
- spùria* *Andr. Heath.*, v. t. 1. Ht. 2 ft., Fl. purple, Ap. to August. Pr. 1s. 6d. In the Edinburgh Botanic Garden, in 1836, 5 ft. 6 in. high.
- 2 *pállida* *H. Wob.* Fl. pale pink.
- tubiflòra* *Andr. Heath.*, v. t. 1. Ht. 2 ft., Fl. pink, April to July. Pr. 1s. 6d. In the Edinburgh Botanic Garden, in 1836, 5 ft. high.
- vestita*. Ht. 3 ft., Fl. white. All the year. Pr. 2s. 6d. In the Edinburgh Botanic Garden, in 1836, 6 ft. 9 in. high.
- 1 *álba*. Fl. white. 6 *coccínea*. Fl. dark red.
- 2 *incarnàta*. Fl. pink. 7 *lùtea*. Fl. yellow.
- 3 *purpùrea*. Fl. purple. 8 *mutàbilis*. Fl. scarlet.
- 4 *ròsea*. Fl. light red. 9 *élegans*. Fl. purple.
- 5 *fùlgida*. Fl. orange.

App. V. *List of a few of the larger Specimens of exotic Heaths, cultivated in the Royal Botanic Garden, Edinburgh; with their Dimensions, &c., as taken from the Plants, 12th July, 1836. Communicated by Mr. M^cNab.*

The use of this list is, to give an idea of what height the species will attain, if planted against a conservative wall. In all probability, they would attain double the height, planted in the ground, and trained to a wall, of what they do as standards in pots or tubs in a glazed house. The wall ought to have an eastern or western aspect; in order to moderate the temperature of the hotter summer months, and to avoid the direct influence of the sun in spring and autumn, when the plants are covered with hoar-frost. The plants in the Edinburgh Botanic Garden are all known as *Ericæ*, though we have given them Mr. Don's new names; but those who do not approve of these appellations, have only to substitute the word *Erica* for the new generic name, the specific names generally not having been changed; where both names have been changed, we have given the old ones in parentheses.

	Height without Tubs.	Circum- ference.	Depth of Tubs.		Height without Tubs.	Circum- ference.	Depth of Tubs.
	ft. in.	ft. in.	in.		ft. in.	ft. in.	in.
<i>Callista magnífica</i>	5 6	14 0	16	<i>Eurýlepis Monsoniàna</i>	6 0	9 0	15
<i>ventricòsa</i>	2 0	12 0	21	<i>sexifària</i>	6 0	10 0	15
<i>erècta</i>	6 3	10 0	18	<i>Eurýlòma jasminiiflòra</i>	4 2	12 0	18
<i>vària</i> (<i>Erica Cassòni</i> <i>M^cNab</i>)	4 6	12 0	20	<i>obbàta umbellàta</i>	3 0	9 0	20
<i>metulæflòra</i>	2 9	9 0	22	<i>Aitoniana</i>	4 3	7 6	19
<i>quadrangulàris</i> (<i>Erica</i> <i>eròsa M^cNab</i>)	2 0	6 0	16	<i>anpullàcea</i>	2 6	9 0	18
<i>Muscàri</i>	4 2	8 3	16	<i>retòrta</i>	2 6	7 6	19
<i>juliàna</i>	2 0	7 3	15	<i>trícòlor màjor</i>	3 0	6 0	15
<i>Ectasis Sebàna</i>	4 4	11 6	20	<i>Shannoniàna</i>	2 6	9 0	18
<i>Banksiàna</i>	1 3	7 0	15	<i>princeps</i>	2 3	7 6	15
<i>pícta</i>	4 2	13 6	22	<i>Gypsocállis lanàta</i> (<i>Erica</i> <i>flàccida M^cNab</i>)	5 3	13 6	22
<i>Erica Bonplandiàna</i>	8 3	7 0	16	<i>Syringòdea vestita</i> <i>coc-</i> <i>cinea</i>	6 9	13 0	20
<i>borida</i>	6 0	10 0	18	<i>abiétina</i>	6 2	18 0	24
<i>cerinthòides</i>	5 0	10 0	16	<i>spùria</i>	5 6	14 6	21
<i>Solàndri</i>	2 0	9 6	18	<i>radiàta</i>	3 9	10 6	20
<i>deprèssa</i>	1 6	8 3	20	<i>rùbida</i>	4 6	8 0	18
<i>montàna</i>	1 0	6 0	15	<i>Bowieàna</i>	6 0	9 0	15
<i>odoràta</i> (<i>odòra-ròsea</i> <i>M^cNab</i>)	2 0	12 6	15	<i>verticillàta</i>	6 3	10 0	20
<i>Eurýlepis glàbra</i>	4 10	6 0	16	<i>echiniflòra</i>	3 6	12 0	18
				<i>Eweràna</i>	8 6	26 0	40

App. VI. Culture of the hardy and half-hardy Species and Varieties of *Ericææ* belonging to the Group *Ericææ normales*.

The hardy Species of *Ericææ normales* are most commonly propagated by layering the branches in very sandy peat. The shoots require no cutting or twisting; but, if they are buried in the soil, about 1 in. deep, and to within 1 in. of their points, and the soil be kept firm and moist over them, they will root freely in two or three months, in the spring or autumn. Layers made in October or November will be fit to take off in the following May or June; as will layers made in February or March. Some of the commoner heaths are also propagated by division, or detaching stems or branches which may have produced roots; and all the species may be raised from seeds when these ripen. The soil in which all the species and varieties thrive best is sandy peat, though some of the species will thrive with a greater proportion of loam intermixed with the peat than others. Whatever soil is used, it ought to be mixed with pieces of freestone or brickbats, as reservoirs of moisture, and placed on a stratum of gravel, as drainage, for reasons which will be hereafter mentioned.

A *Heathery, or Ericetum, in the open Ground* is justly considered as one of the most interesting ornaments of the flower-garden or pleasure-ground, from its being at all times green, and exhibiting plants in full flower during every month in the year. Perhaps the most complete hardy heath garden in England is that at Woburn Abbey. There, Mr. Forbes informs us, "Each species or variety is confined to a separate bed, the beds being edged with the *Calluna vulgaris* and *Erica Tétralis*; and so disposed, that the tallest-growing kinds are arranged towards the centre of the parterre: whilst the whole are so intermixed, in point of colour, as to produce the most lively contrast possible." (*Hort. Wob.*, p. 282.) A plan of the parterre for hardy heaths is given in the *Hortus Woburnensis*, exhibiting upwards of 70 groups; but, as the distribution of the species and varieties, among these groups, so as that the tallest-growing kinds may be "arranged towards the centre," and the whole "so intermixed in point of colour as to produce the most lively effect possible," is not given in the *Hortus Woburnensis*, we have written to His Grace the Duke of Bedford, to request that he would authorise Mr. Forbes to supply us with so interesting a desideratum. In every case, the shapes and sizes of the beds of a parterre, especially one to be planted with lignous plants, which may be considered fixtures, are of trifling consequence in comparison with the arrangement of the plants in them. We have been the more anxious to indicate this arrangement, in the case of the Woburn ericetum, because the late Mr. George Sinclair, F.L.S., who designed the beds, and, we presume, planted them, had a scientific knowledge of, and an excellent taste in, colours. His arrangement of the heaths in these beds, therefore, so as to produce a harmonious effect, we consider to be of great interest to gardeners intending to plant a heathery; and we are happy in being able, through the kindness of the Duke of Bedford, to lay it before our readers.

The hardy ericetum at Woburn Abbey is situated in front of the Cape ericetum, and the form of the beds is exhibited in *fig.* 886. In this figure,

a is the passage under the Cape heathery, which forms a portion of a covered way, leading from the mansion to the different objects of interest adjoining it; such as the green-house, sculpture gallery, tennis-court, Chinese dairy, plant-stoves and palm-house now erecting, and finally to the pleasure-ground, including the aviary, arboretum, salictum, grass-garden, American garden, &c.

b is a broad gravel walk; being a portion of the main walk of the pleasure-ground.

c, Descent from the porch of the Cape heathery.

d, Shrubbery, chiefly consisting of rhododendrons and azaleas.

1 to 73, Heaths, and other *Ericæææ*, arranged as in the following list.

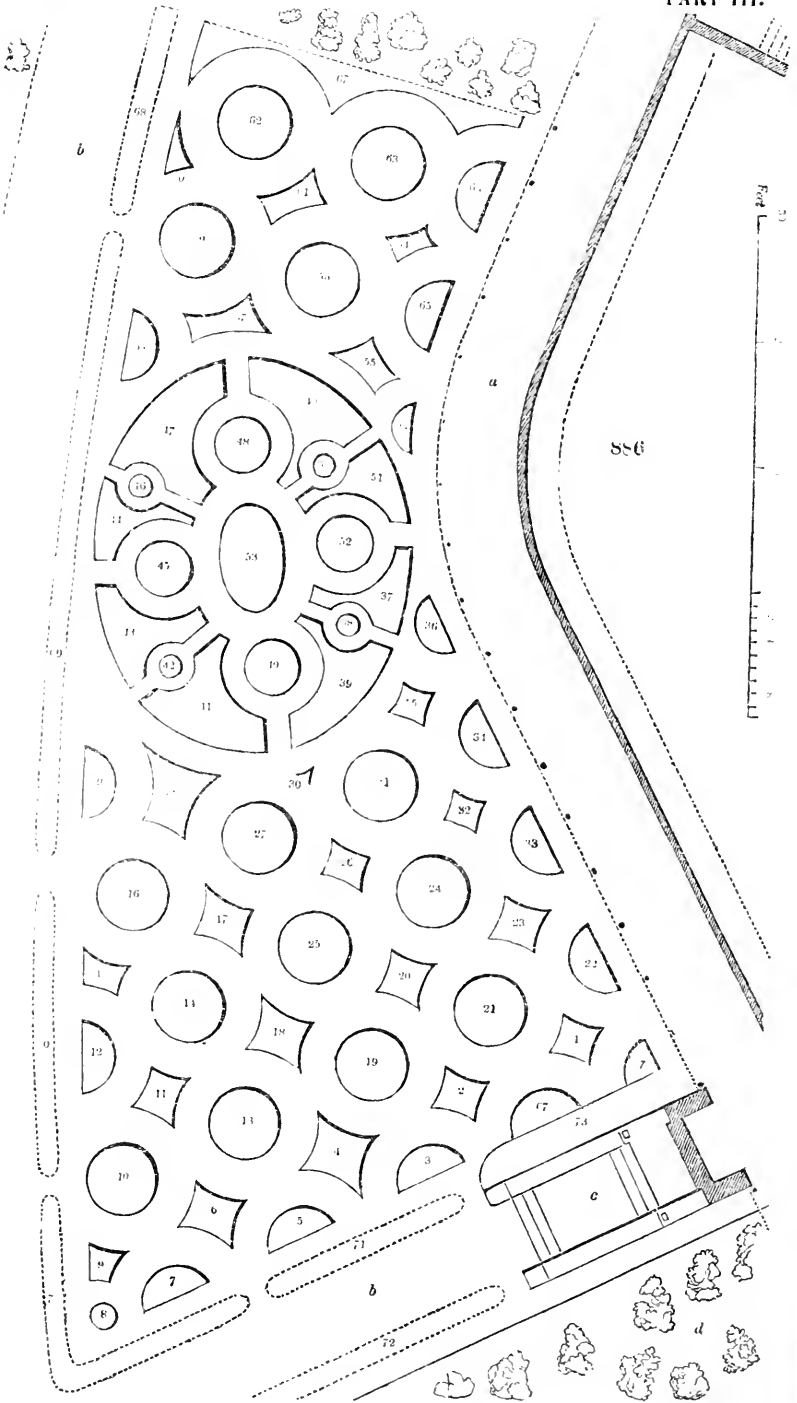

- | | |
|---|--|
| 1, Gypsocállis (<i>Erica</i>) vágans álba. | 36, Gypsocállis (<i>E.</i>) cárnea. |
| 2, <i>Erica</i> cinèrea. | 37, Gypsocállis (<i>E.</i>) vágans pállida. |
| 3, Phyllódoce taxifólia (<i>Menzièsia</i> cærùlea). | 38, <i>Erica</i> cinèrea atropurpùrea. |
| 4, Azàlea procúbens. | 39, Dabæ'cia poliifólia nàna (<i>Menzièsia</i>). |
| 5, <i>Erica</i> austràlis. | 40, Cape heaths. |
| 6, Gypsocállis (<i>E.</i>) mediterrànea. | 41, Callùna (<i>E.</i>) vulgàris flòre plèno. |
| 7, <i>Erica</i> cinèrea álba. | 42, Syringódea (<i>E.</i>) rùbida. |
| 8, <i>Erica</i> scopària. | 43, Dabæ'cia poliifólia (<i>Menzièsia</i>). |
| 9, <i>Erica</i> cinèrea atropurpùrea. | 44, Dabæ'cia poliifólia. |
| 10, Cape heaths. | 45, <i>Erica</i> arbòrea. |
| 11, Phyllódoce taxifólia (<i>Menzièsia</i> cærùlea). | 46, <i>Erica</i> cinèrea atropurpùrea. |
| 12, Dabæ'cia poliifólia álba (<i>Menzièsia</i>). | 47, Cape heaths. |
| 13, Cape heaths. | 48, Gypsocállis (<i>E.</i>) vágans pállida. |
| 14, Dabæ'cia poliifólia nàna (<i>Menzièsia</i>). | 49, <i>Erica</i> Actæ'a. |
| 15, <i>Erica</i> ciliàris. | 50, <i>Erica</i> floribúnda. |
| 16, <i>Erica</i> Actæ'a. | 51, Cape heaths. |
| 17, Gypsocállis (<i>E.</i>) vágans rùbra. | 52, <i>E'mpetrum</i> nigrum. |
| 18, Cape heaths. | 53, Cape heaths. |
| 19, Callùna (<i>E.</i>) vulgàris spicàta. | 54, Callùna (<i>E.</i>) vulgàris spùria. |
| 20, Dabæ'cia (<i>Menzièsia</i>) poliifólia. | 55, Dabæ'cia poliifólia (<i>Menzièsia</i>). |
| 21, Gypsocállis (<i>E.</i>) mediterrànea. | 56, Gypsocállis (<i>E.</i>) mediterrànea. |
| 22, Cape heaths. | 57, Cape heaths. |
| 23, <i>Erica</i> viridipurpùrea. | 58, <i>Erica</i> arbòrea. |
| 24, Gypsocállis (<i>E.</i>) vágans álba. | 59, <i>Erica</i> austràlis. |
| 25, <i>Erica</i> arbòrea. | 60, Callùna (<i>E.</i>) vulgàris variegàta. |
| 26, Callùna (<i>E.</i>) vulgàris álba. | 61, Gypsocállis (<i>E.</i>) vágans álba. |
| 27, Gypsocállis (<i>E.</i>) mediterrànea. | 62, <i>Erica</i> strícta. |
| 28, <i>Erica</i> strícta. | 63, <i>Erica</i> viridipurpùrea. |
| 29, <i>Erica</i> scopària mínima. | 64, Callùna (<i>E.</i>) vulgàris. |
| 30, <i>Erica</i> cinèrea atropurpùrea. | 65, <i>Erica</i> Tétralix. |
| 31, <i>Erica</i> austràlis. | 66, Gypsocállis (<i>E.</i>) cárnea. |
| 32, Gypsocállis (<i>E.</i>) cárnea. | 67, Gypsocállis cárnea herbàcea. |
| 33, Azàlea procúbens. | 68, Gypsocállis cárnea. |
| 34, <i>Erica</i> scopària. | 69, Gypsocállis cárnea herbàcea. |
| 35, Gypsocállis (<i>E.</i>) vágans tenélla. | 70, Gypsocállis cárnea. |
| | 71, Gypsocállis cárnea. |
| | 72, Gypsocállis cárnea herbàcea. |
| | 73, Rhododendrons. |

In order to study the effect, in point of colours, which this ericetum will have in every month of the year, we recommend the reader of leisure, and more especially the young gardener, to make 12 copies of *fig.* 886., and then to look at App. II. (p.1088.), and observe the sorts of heath which will be in flower in each month of the year, their colours, and their heights. Then let him take the copy of the plan of the ericetum for January; and, as he will find by the list, App. II., that there will be only two sorts in flower during that month, viz. Gypsocállis cárnea and G. c. herbàcea, both of which have pink flowers; let him colour with pink all the beds indicated to be planted with that sort, colouring all the other beds green. This will give 8 red beds and 65 green ones for the month of January. To indicate the height which the plants in each bed are supposed to attain, the height of each sort, as indicated in the list, may be taken from the scale; and each bed drawn in isometrical projection, as shown in *fig.* 887., which is supposed to represent bed No. 21., intended to be planted with Gypsocállis mediterrànea, a species estimated to grow to the height of 4 ft. Whether the operation of colouring is performed on a ground plan, such as *fig.* 886., or on an isometrical view to show the height, prepared after the manner described, the colouring ought to be applied from the list



887

in App. II. to twelve different copies of the plan, so as to show the appearance which the ericetum will have, or ought to have, in every month of the year. We know that in practice it is impossible to attain to perfection in matters of this kind; but still it is highly advantageous to proceed upon sound principles, and to have a *beau idéal* of the effect to be produced in view. For this reason, we recommend gardeners, when they are forming a scheme for planting a flower-garden, always to try the effect which it will have during the principal summer months, by drawing a plan for each of these months, and colouring the beds in each with the colours of the flowers of those plants which are intended to be simultaneously in bloom. Such coloured plans being shown to the employers (and more especially to the female part of the family, who have generally considerable taste in the arrangement of colours), useful hints may be received, and the beds altered until perfect harmony is produced. Another mode, and one which would afford an excellent exercise for young gardeners, would be for the gardener to lay before his employers, once in every year, twelve copies of the plan of his flower-garden (for which purpose it might be lithographed), and these copies being coloured by the lady of the family agreeably to her taste, or ideas of what constitutes harmony, the problem for the gardener to solve would be: "Required, the kinds of plants, and the modes of treating them, necessary to produce the given colours in the given months." Of course, the plans and this problem for every year would require to be given to the gardener a year before the time when it was intended to be carried into execution, in order that he might have time to prepare and propagate the requisite kinds and numbers of plants. These remarks, though apparently not immediately applicable to ericetums, or flower-gardens composed of hardy heaths, are yet decidedly so when Cape heaths are included; and they are also applicable to gardens of low American shrubs, including azaleas, rhododendrons, &c., such as will be hereafter treated on and described.

A symmetrical Ericetum. The hardy ericetum at Woburn Abbey is of an irregular shape, because it is adapted to a particular situation; and the surface being a bank, sloping towards the house containing the Cape heaths, it is seen to most effect when walking along the covered way (*a*); but, where an independent ericetum is to be formed, we would recommend a level surface sunk 2 ft. or 3 ft. below a surrounding walk; and we would further advise, as a desideratum in all hardy ericetums, that all the narrow walks between the beds be paved with pebbles, brick, stone, or some other perfectly smooth surface. The reason is, that when the path is of gravel or sand, the small delicate foliage and flowers of the heaths, which rest almost on the ground, are soiled and disfigured with the sand and lighter particles of gravel, after every heavy shower. *Fig. 888.* is such a plan as we would recommend. The sectional line (*a b*) shows that the beds are sunk about 3 ft. below the surrounding terrace walk. From this walk the beds are separated by a sloping bank, the upper and lower verges of which may be of turf, and the middle part may be planted with that variety of heath which comes into flower at the season when it is desired that the ericetum should look most gay. Thus, for the ericetum of a winter or spring residence, it may be planted with *Gypsocallis carnea*; and, for a summer residence, it may be planted with *Calluna vulgaris*, or *Erica cinerea atropurpurea*. In particular soils and situations, the whole of this bank, as well as the verges, may be of fine turf, or of rock-work, planted with heaths. The descent to the beds, from the surrounding gravel walk, is by six steps. The manner in which the beds are proposed to be planted is very simple. The centre bed is to be occupied solely with species exceeding 3 ft. in height, the tallest-growing kinds being placed in the centre of the bed. Each of the other beds is to be filled with heaths which never exceed 3 ft. in height; every bed being limited to heaths which come into flower in the same month. In *fig 888.*, one half of the beds are numbered, to show how this is done. Thus, the beds marked 1 and 12, of which there will be six in the ericetum, will be wholly occupied with *Gypsocallis*

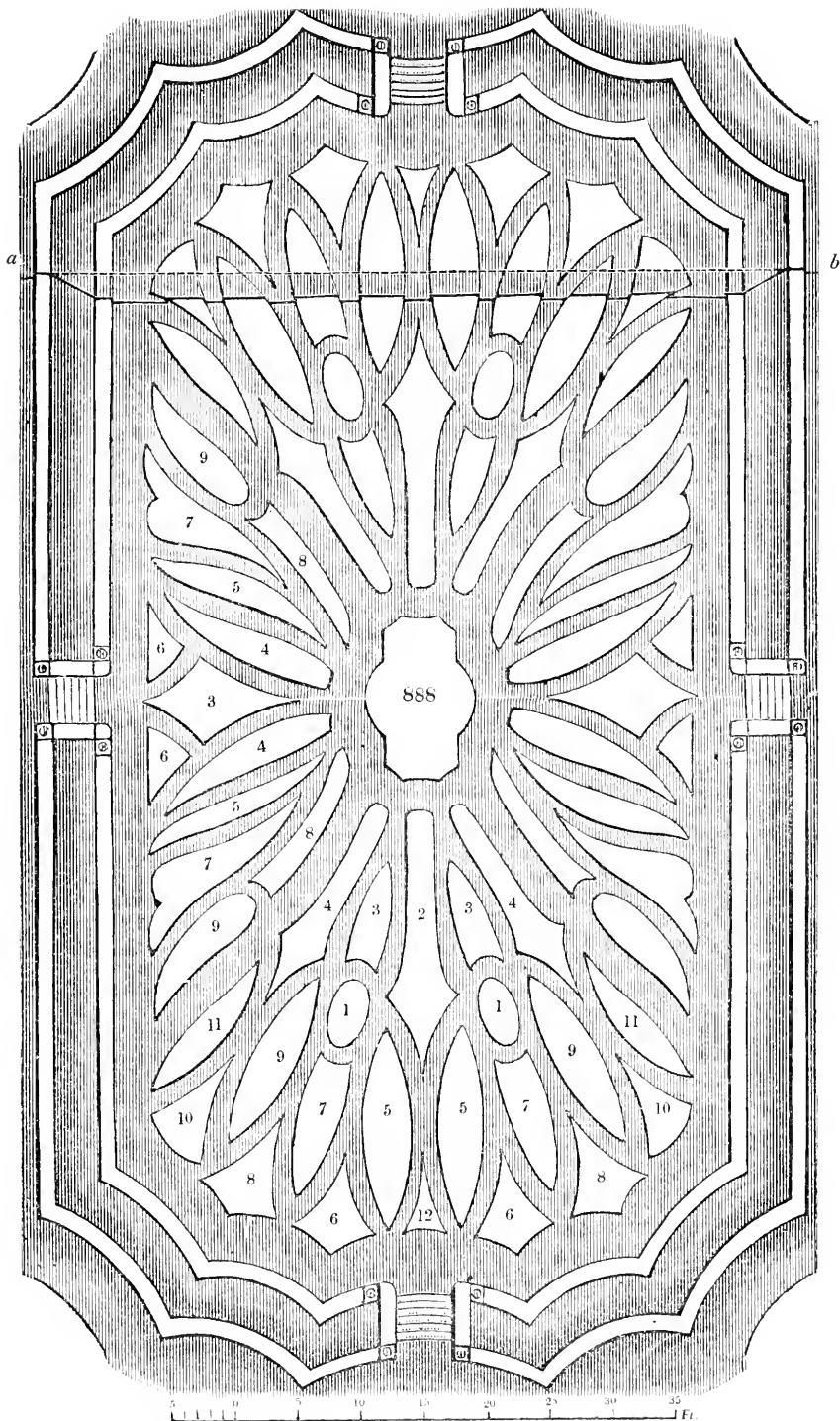

carnea and *G. c. herbacca*, because these are the only dwarf heaths that are in flower during the first and twelfth months of the year. In like manner, the beds marked 9, of which there are eight in all, will be wholly occupied with *Erica cinerea alba* and *rubra*, *Gypsocallis multiflora alba* and *rubra*, and *Daboecia polifolia*, and *D. p. nana*, these being the only heaths which never exceed 3 ft. in height, that come into flower in the ninth month (September). Should this mode not be approved of, one sort may be confined to a bed; the only principle which is essential to the proper effect of this plan being, that all the sorts which have any chance of exceeding 3 ft. in height, should be confined to the central bed, in order that they may not interfere with the symmetry of the figure, as seen from the side of the surrounding terrace walk.

Half-hardy, or Cape, Heaths are generally propagated by cuttings: but, as seeds are frequently ripened in this country, and are also regularly received from the Cape of Good Hope, that mode of propagation is common; and, about London, is generally adopted in preference to the other; the plants being raised with less trouble and attention, though requiring a longer time before they are fit for sale. We shall first slightly notice the mode of raising heaths from seeds, and afterwards that of propagating them by cuttings.

Seeds of Cape heaths generally arrive in England, from the Cape of Good Hope, in the months of July and August; and Mr. Bowie (*Gard. Mag.*, vol. i. p. 364.) recommends the latter month as a favourable time for sowing them. Mr. M'Nab, however, prefers February, or early in March. The seeds should be sown in pots, well drained, and filled to within one fourth of an inch of the top, with "very sandy peat earth, made level and firm; the seeds should then be sown on the surface, and scarcely any covering put over them. This precaution is absolutely necessary, as the seeds of all the heaths are very small, and unable to push through a deep covering. The pots, after sowing, should be watered with a very fine watering-pot, and placed in a cold frame under glass, where they should remain. They will require water every day; and, if the weather be very dry, and there is much sun, they should be shaded with a mat in the middle of the day. As soon as the seeds begin to vegetate, the frame should have a little air admitted to prevent damp, and this should be increased as the young seedlings gain strength. Whenever the plants are sufficiently large to bear handling without injury, they should be potted out into small-sized pots, always putting several plants in the same pot, and placing them near the edge of it; as some of the seedlings may be expected to damp off in the first potting." (*Treatise*, &c., p. 15.) The best soil for this potting, Mr. M'Nab considers to be one half peat and one half sand, increasing the proportion of peat in subsequent pottings. Mr. Bowie pots first in three fourths sandy peat, and one fourth sandy loam; and, at subsequent pottings, he increases the proportion of sandy loam, till he pots finally in sandy loam only. We must confess, however, that we do not think that there are many species of Cape heaths which would thrive in this soil; though, on turning to the volume of the *Gardener's Magazine* above referred to, a list will be found of the habitats of ten different groups of Cape heaths, not one of which is stated to be sandy peat, and only two in a situation where a black vegetable soil, something like British bog soil, occurs. The seeds of Cape heaths Mr. Bowie has known to vegetate well after having been upwards of twelve years in England.

By Cuttings. Mr. M'Nab finds "The greater proportion of heaths strike root freely, when the cuttings are made of the young wood after it has become sufficiently firm to prevent its damping off. The pots for the reception of the cuttings should be about nine or ten inches in diameter at the mouth. It is a good method, in preparing the pots for the cuttings, to fill them to within $1\frac{1}{2}$ in. of the top with pieces of broken pots, or cinders, the upper pieces of which should be of a smaller size than those below; over which should be put a thin layer of live moss (*Hypnum*), to prevent the sand from working down among the potsherds or cinders; then the remainder of the pot should be filled with fine sifted sand to the level of the edge, and the

sand pressed down very firm. After being well watered, the pot is then fit to receive the cuttings." Mr. M'Nab prefers "pit-sand for striking heath cuttings in; the colour of which is of little importance, whether white, grey, or yellowish: it should, however, be as free as possible from earthy and irony matter. The length of the cuttings must depend on the habit of the species. Of some of the free-growing sorts, they may be about $1\frac{1}{2}$ in. long; and from other sorts, that are of a more stunted growth, they may not exceed half an inch in length: in both cases, they should be taken from the plant at the part where the young shoot springs from the older wood. The leaves should be stripped off about half the length of the cutting, carefully, and so as not to wound the bark; and the end should be cut clean across with a sharp knife or with scissors. The cutting is then fit to be inserted into the pot prepared for its reception. In all ordinary cases, pots of the size above mentioned will hold many different kinds of heaths. In extensive nursery collections, where great quantities of plants are wanted, one pot may be filled with cuttings of the same species, when such can be got in sufficient quantities; but in private collections this is not necessary, for, in general, only a few plants of a sort are all that are required. When this is the case, the kinds selected to be put in the same pot should be as nearly of the same habit as can be estimated at the time: for example, supposing four pots are intended to be filled with cuttings, the following sorts may be selected for each pot:—

First Pot. *Ectasis melastoma*, *Petiverii*, *Sebana*, *Plukenetii* var. *penicillata*, &c.

Second Pot. *Syringodea pinea*, *pinifolia*, *vestita*, *grandiflora*, *purpurea*, &c.

Third Pot. *Callista ventricosa*, *prægnans*; *Syringodea Linnæana*, *linnæoides*, *coldrans*, &c.

Fourth Pot. *Eurydima Aitoniana*, *jasmiflora*, *ampullacea*, *Irbyana*, &c.

Unless this, or some similar mode of selection, be attended to, one sort will be found to strike root in a much shorter time than others in the same pot, which will be inconvenient when potting them out. . . . When the pot is filled with the cuttings, it should be well watered with a watering-pot having a fine rose; and placed in a close shady part of the stove; admitting as little air as possible near to where the pots of cuttings are placed, and taking care to water them freely every day. Indeed, when treated as above directed, there is little risk of over-watering them; for, in consequence of their being well drained, the water is allowed to pass freely through; and, so far from injuring the cuttings, they are benefited by it." Mr. M'Nab adds, that he is "convinced that all Cape heaths will strike in this way, when good cuttings can be procured of them." He very seldom uses bell-glasses for heath cuttings; nor does he "consider them necessary for heaths in general. Some of them, however, which are more difficult to strike, such as *Eurystegia* (*E.*) *glauca*, *Syringodea* (*E.*) *aurea*, *Lamprotis* (*E.*) *taxifolia*, and a few other species, may be put under bell-glasses, and placed in the stove beside the others. Where no stove is at hand to put the pots of cuttings in, and where the situation in which they are to be placed has much air, then bell-glasses are absolutely necessary. The pots, in this case, should be prepared for the cuttings, which are to be covered with bell-glasses, in the same way as before recommended. The size of the pot must be regulated by the size of the glass which is intended to cover the cuttings. The glass, in this case, will require to be wiped occasionally, to prevent any damp from injuring the cuttings; and, when they have struck root, the glass should be removed gradually, some time before the cuttings are potted out." Mr. M'Nab believes "that cuttings of heaths will strike root when put in at any season, if the cuttings are in a proper state; that is, when the young shoots are just old and firm enough to prevent them from damping off when first put in. Early in the spring, however," he considers "to be the best time for them; as the cuttings will then be rooted, and potted out, in sufficient time to get established in the pots before the following winter. . . . When the cuttings are rooted, which will be easily known by their beginning to grow freely, they should be potted into the smallest-sized pots, and kept for ten days or a fortnight in a close shaded place; they may then be gradually exposed in a more airy part of the green-house, care being taken to shade them for a few

hours in the heat of the day, if there happen to be much sun at the time. This shading should only be continued till the young plants are enabled to bear the full heat of the sun. The soil for the first potting should be one half peat and one half sand, always taking care to drain the pots well with small pieces of broken pots or cinders. The second potting must depend much on the season of the year: if the first potting is done in the spring, the second should be performed as soon as the young roots appear round the inside of the pots; but, if the first potting is in the summer, then the second will not be necessary till the following spring. The soil for the second potting should be about two thirds peat and one third sand; and in all the after-pottings the soil should be the same as recommended below." (*Treatise on Cape Heaths, &c.*, p. 14.)

The soil most suitable for Cape heaths, according to Mr. M'Nab, is black peat, "taken from a dry heath, or common, which is never overflowed with water. In general, it should not be taken off more than 5 in. or 6 in. deep. This, however, must partly depend on the subsoil; for, in some cases, at 12 in. or 14 in. deep, the soil is quite as good as at the surface. Whatever heath, or other vegetable production, is on the surface, should be taken along with the peat earth to the compost ground, and there laid up in a heap till wanted. It frequently happens that peat earth, taken from such situations, has sand intermixed with it in its original state; but, where this is not the case, a quantity of coarse white sand should be procured, and mixed with the earth in the compost ground. This should be, at least, to the extent of one fourth or one fifth of the whole: and, if it exceed this quantity, it will not be found injurious to the health of the plant." Mr. M'Nab prefers "a coarse white sand, when it can be procured; but, when that cannot be had, any coarse pit or river sand will answer equally well; and, if an opportunity should offer of procuring sand from a freestone quarry, or from the hewings of sand stones used in buildings, that may be substituted; but, in either case, the sand should be free from iron matter. When the earth and sand are properly mixed, the compost is fit for use." (*Treatise, &c.*, p. 16.) Whether compost for heaths or other plants should be used in a recent state, or after it has lain a year or two in the compost ground, and been frequently turned over, is a point on which cultivators differ in opinion. In the case of the compost which Mr. M'Nab recommends for heaths, he has found no difference whether it was used immediately when brought from the common, or after it had lain some time, and been turned over and mixed for years. Mr. M'Nab has grown, in this soil, in tubs, 3 ft. over, the freer-growing heaths, such as *Syringò-dea* (*E.*) *Eweràna*, *abiétina*, *v. estica coccínea*, *grandiflòra*, *Bonplandiàna*, &c., to the height of 8 ft.; the plants being bushy in proportion, and, when in flower, covered with blossoms from the edge of the tub to the top of the plant. A small quantity of manure (*viz.* about one eighth part of rotten cow-dung) is frequently added by Mr. M'Nab to the above compost; which shows, contrary to the opinion of some, that, like other plants, heaths are capable of being fed, artificially, with food containing animal matter. Mr. M'Nab has also tried liquid manure; but he is "unable to give particular directions" as to the proportions in which it should be used. Besides manure, which Mr. M'Nab adds occasionally, he considers it a great advantage to introduce into the soil considerable quantities of coarse soft freestone, broken into pieces of from 1 in. to 4 in. or 5 in. in diameter. The quantity of stone which he introduces will, he says, "in most cases, if broken down into sand, and added to the sand previously in the soil, form about one third part of the whole mass." The reason given by Mr. M'Nab for introducing the stone is extremely interesting and important; and, like every line in his most valuable treatise, it ought to sink deep into the mind of the young and thinking gardener:—"When stones are mixed with the earth in the way above recommended, heaths will never suffer so much in the summer from occasional neglect in watering them, as they would do if the stones were not made use of; because these stones retain the moisture longer than the earth, and, in the winter, they allow

a freer circulation of any superabundant moisture which may be given, through the mass." (*Treatise*, &c., p. 25.) Mr. Bowie, also, recommends small stones and fragments of garden pots to be mixed with the soil in which heaths are grown: but the practice seems to have been first introduced (probably before 1820) by Mr. James Niven, who was many years a collector at the Cape, and who died at Pennycuik, near Edinburgh, in 1827. (See *Gard. Mag.*, vol. ii. p. 255.) The thorough drainage of the pots or tubs, the judicious mixture of lumps of freestone with the soil, and the addition of thoroughly consumed cow-dung, seem important points in the culture of Cape heaths in pots, and afford equally important hints for their culture in the free soil, either against a conservative wall, or in beds in the open ground, with temporary coverings of glass or boards during winter.

The Treatment of Cape Heaths as half-hardy Shrubs is a subject on which we can derive but little assistance, either from books, or from the experience of practical men. Mr. McNab is of opinion that, in the climate of Edinburgh, the Cape heaths ought never to be taken out of doors, but should be kept in the house, even during summer, giving them plenty of air, and keeping them cool during winter. It is commonly supposed, he says, that turning heaths out of doors, for four or five months in summer and autumn, makes them hardier, and enables them better to stand the winter; but he very properly differs from this opinion, finding from experience that, when heaths and other green-house plants are kept in the house during summer, the young wood gets better ripened, and is, consequently, better able to resist cold in winter. The greatest care is requisite to keep the house in which heaths are grown well ventilated; for which purpose the glass of the roof and sides should be made to open; and the plants should never be so near as to touch each other with the extremities of their shoots: on the contrary, they ought always to be at least 3 in. or 4 in. apart, in order to admit of a free circulation of air round each. "Except in cases of high wind or heavy rain, both top and front lights should be open night and day; and, besides watering the earth in the pots freely when they require it, the plants should be well watered overhead with the garden engine every day; and, if the weather be hot and dry, this operation should be performed twice every day; namely, both morning and evening." "The chief objection," Mr. Marnock observes, "to heaths and other green house plants being kept in the house in summer is, that, being exposed to the sun, the earth in the pots becomes dry, and the extremes of heat and cold, wet and dry, to which the roots are thence subjected, cause the plants to assume a brown and unhealthy appearance; and, generally, the leaves on the lower branches to fall off. These evils may, however, be effectually prevented by using double pots; the empty pot which is intended to form a screen for the other which contains the plant, being sufficiently large to receive the latter within it, so that the tops of both are nearly on a level. I have practised this mode for the last three years, both with stove and green-house plants; and, during the dry summer of 1832, I had at Bretton Hall at least 100 of the latter in pots, protected in this way." (*Gard. Mag.*, vol. x. p. 32.) When heaths are attacked by aphides, which they very seldom are, a little tobacco smoke for two nights in succession will destroy them. It is always better to apply the smoke two or three times, if necessary, in small quantities, than the same quantity of tobacco all at once, because there is less risk of injuring the plants. When heaths in pots happen to be frozen during winter, there is nothing more injurious to them than the application of fire heat to such an extent as to thaw the soil. All that ought to be done is, by covering the sashes with mats, or by other means, to prevent the increase of the frost, and leave the soil to be thawed by the natural return of genial weather. In the Botanic Garden of Edinburgh, we believe, fire heat, or artificial heat of any kind, is seldom or never applied to the heath-house. Some valuable remarks on this subject, by Mr. Marnock, the curator of the Sheffield Botanic Garden, will be found in the *Gardener's Magazine*, vol. x. p. 31.

When Cape heaths are planted out, either against an open wall, or on a bed to be protected during winter, the soil should be previously prepared, mixed with stones, and placed on a substratum of drainage, in conformity with Mr. McNab's directions for preparing the soil, and growing and managing heaths in pots. The plants turned out should, at least, be of four or five years' growth; because it is found from experience, that stout plants of half-hardy species of every kind of shrub will bear more cold the first winter, when planted in the open ground, than weak plants. As heaths require a free circulation of air around them at all seasons, they will probably succeed better when planted in a bed of soil in the open garden, and protected by a movable roof, than when planted against a wall: but this movable roof must consist chiefly of glass, on account of many of the species being in a growing and flowering state during the winter season. We have no doubt that, in various parts of the south of England, most of the sorts enumerated in App. III., if thoroughly established in the open ground, would require no protection whatever. The branches would exclude the frost from the soil; and, if the tops were occasionally killed down to within 2 ft. or 3 ft. of the roots, the plants would spring out again the following season, and soon recover what they had lost. The south-east side of a natural hill would be the most suitable situation for such an ericetum, provided care were taken in early spring, when the plants were covered in the morning with hoarfrost, to thaw it off by watering them before sunrise; but, in situations where this precaution cannot be attended to, a south-west aspect would be preferable. In the *Gardener's Magazine*, vol. i. p. 374., we have suggested the idea of planting the Cape heaths in suitable soils in the open garden, and covering them, during six months in the year, by a glass roof, supported by movable iron props, which might fit into fixed sockets, so as to show no vestige of the structure during summer, when it was removed. The heat might be conveyed, by flues or steam-pipes, under the paths. At Woburn, many of the duplicates of the Cape heaths, which are kept under glass during winter, are turned out into the parterre of hardy heaths during summer, "where they generally flower, grow vigorously, and form themselves into handsome bushy plants." The tenderest and most difficult to propagate of these are taken up in autumn, repotted, and replaced in the heathery; while the more hardy and easily propagated species are suffered to remain till they are destroyed by frost, or to take their chance of the winter proving mild; in which case they survive it. *E. Actæ'a*, *E. triflora*, and *E. floribunda* stood out during two winters at Woburn, though there were 14° of frost. (*Hort. Wob.*, p. 283.) Mr. Robertson of the Kilkenny Nursery is persuaded that a number of Cape heaths would stand the open air in Ireland, without the slightest protection whatever; more especially on the sea coast. He has grown in a frame, 6 ft. high behind, and 6 in. high in front, without any means of artificial heat whatever, a number of sorts to a high degree of perfection. The bed is composed of three layers: the lowest of loose stones, 6 in. thick; the one over it of fine, sifted, rotted loam, mixed with sand, peat soil being there very scarce; and the third, or surface stratum, of sandy peat, 16 in. or 18 in. deep. The plants are turned out of the pots into this soil; and, during summer, they require frequent watering, all possible air on temperate days, and shading on scorching sunny ones. The shading is effected by a mat, and the ventilation by tilting up the glass at both ends, so as to produce a thorough current of air. In winter, the same attention to air is given, but no water whatever. The plants are screened from rain at all seasons, and well matted up during severe frosts in winter; but no kind of artificial heat is applied (See *Gard. Mag.*, vol. x. p. 206.) Mr. Rutger, during his residence in Cornwall, having a number of duplicates of Cape heaths, planted a clump of them in the open air, which succeeded admirably with very slight protection during winter. "Having made choice of a situation," he says, "after making a suitable excavation, and laying in the bottom of it a thick drainage of brickbats, broken pots, &c., over which I laid dead fern roots and other matters, I covered the whole with peat earth to the depth of

about 10 in., and in the month of April turned out my plants. Many of these grew to admiration, and flowered beautifully in the following autumn. Having succeeded thus far, and being fearful lest the plants should be disfigured, or perhaps killed, by the winter's frost, I proceeded to erect a temporary frame over them, with melon lights, old sashes, and feather-edged boards; the latter serving for the back, and nearly half of the roof sloped backwards, and the old sashes for the front and ends, so that the whole, when finished, looked something like a little green-house. The lights were always off in mild weather, and also in frosty weather during the day when the sun shone. In the month of April the frame was removed, and during the summer the plants grew rapidly, presenting a mass of vigorous shoots, covered with most beautiful foliage, and flowers of a very superior size and brilliancy of colour. This clump was admired by all who saw it. The species consisted of [we give the old names] *Erica coccinea*, *verticillata*, *grandiflora*, *cruenta*, *ignescens*, *versicolor*, *mammosa*, *costata*, *tubiflora*, *Archeriana*, *curviflora*, *concinna*, *exurgens*, *vestita*, *cerinthoides*, *ventricosa*, *baccans*, *Eweriana*, *Sparmanni*, *spuria*, and *melastoma*, with some others which I do not now remember. At the end of three years, when I left Cornwall, the plants had arrived at a fine state of maturity, and were far superior to any I had ever before, or have since, seen. (*Gard. Mag.*, vol. ix. p. 585.) No ligneous flowering shrubs, whether hardy or half-hardy, are better deserving of culture than the heaths; for, as we have before observed (*Gard. Mag.*, vol. i. p. 366.), "of what other genus can it be said, that every species, without exception, is beautiful throughout the year, and at every period of its growth? in flower or out of flower, and of every size and age? perpetually green, perpetually in flower; and these flowers of various colours and sizes, and of many shapes?" "The two splendid natural orders *Ericaceæ* and *Epacridææ*" [*Ericææ* normales *D. Don*, and *Epacridæææ Lindl.*], Mr. Marnock observes, "perhaps contain a greater number of really beautiful plants, than are to be found in all the other orders put together."

GENUS IV.



ANDRO'MEDA L. THE ANDROMEDA. *Lin. Syst. Decándria Monogýnia.*

Identification. D. Don in *Edinb New Phil Journ.*, 17. p. 157.; Don's *Mill.*, 3. p. 828.
Synonymæ. *Polifolia Burbaum Cent.*, 5. p. 5. t. 55. f. 1.; *Andrómæda* sp., *L.*
Derivation. *Andrómæda* was the name of the daughter of Cephalus, king of Ethiopia. She was tied naked to a rock, and exposed to be devoured by a sea-monster to appease the wrath of Neptune; but was delivered by Perseus, who afterwards married her, and they had many children. The following reasons for the application, by Linnæus, of the name of *Andrómæda* to this genus of plants are extracted from Sir J. E. Smith's translation of Linnæus's *Lachesis Lapponica*:—" *Andrómæda polifolia* was now (June 12.) in its highest beauty, decorating the marshy grounds in a most agreeable manner. The flowers are quite blood-red before they expand; but, when full grown, the corolla is of a flesh-colour. Scarcely any painter's art can so happily imitate the beauty of a fine female complexion; still less could any artificial colour upon the face itself bear a comparison with this lovely blossom. As I contemplated it, I could not help thinking of *Andrómæda*, as described by the poets; and the more I meditated upon their descriptions, the more applicable they seemed to the little plant before me; so that, if these writers had it in view, they could scarcely have contrived a more apposite fable. *Andrómæda* is represented by them as a virgin of most exquisite and unrivalled charms; but these charms remain in perfection only so long as she retains her virgin purity, which is also applicable to the plant now preparing to celebrate its nuptials. This plant is always fixed on some little turfy hillock in the midst of the swamps, as *Andrómæda* herself was chained to a rock in the sea, which bathed her feet, as the fresh water does the roots of this plant. Dragons and venomous serpents surrounded her, as toads and other reptiles frequent the abode of her vegetable resemblance, and, when they pair in the spring, throw mud and water over its leaves and branches. As the distressed virgin cast down her blushing face through excessive affliction, so does this rosy-coloured flower hang its head, growing paler and paler till it withers away. Hence, as this plant forms a new genus, I have chosen for it the name of *Andrómæda*." (*Tour in Lapland*, &c., vol. i. p. 188.) Linnæus has drawn this fanciful analogy still farther in his *Flora Lapponica*. "At length," says he, "comes Perseus, in the shape of summer, dries up the surrounding water, and destroys the monsters, rendering the damsel a fruitful mother, who then carries her head (the capsule) erect." These extracts are curious, not only as showing the motives which induced Linnæus to bestow this apparently inapplicable name on the plant, but as showing that the severe studies, and earnest search after truth, of the great naturalist, had not destroyed the vividness of his fancy, or the powers of his imagination.

■ 1. *A. POLIFOLIA* L. The Poly-leaved Andromeda, or Moorwort.

Identification. Lin. Sp., 564; Lin. Fl. Lapp., 161. t. 1. f. 3; CEd. Fl. Dan., t. 54; Smith in Eng. Bot., t. 713; Pall. Fl. Ross., 1. t. 1; Pluk. Alm., 175. f. 1; Don's Mill., 3. p. 829.
Synonyms. *Rhododendron polifolium Scop. Carn.*, No. 482; wild Rosemary, Poly Mountain, Marsh Cistus, Moorwort, Marsh Holy Rose; *Andromède, Fr. and Ger.*
Engravings. Lin. Fl. Lapp., t. 1. f. 3; Fl. Dan., t. 54; Eng. Bot., t. 713; Fl. Ross., 1. t. 1; Pluk. Alm., 175. f. 1; and our fig. 889.

Spec. Char., &c. Leaves oblong, glaucous beneath. Corollas ovate, flesh-coloured, or pale red. Segments of calyx ovate, spreading, white, sometimes tipped with red. (*Don's Mill.*, iii. p. 829.) A native of the northern countries of Europe, on turf bogs; as of Russia, Sweden, Denmark, Switzerland, Germany, Britain, &c.; of North America, in Canada and Labrador, Bay of St. Lawrence, &c., in bogs, and on the borders of mountain lakes; and in New York and Pennsylvania. In Britain, in mossy bogs in the mountainous parts of England and Ireland, and the lowlands of Scotland. It is cultivated in gardens, in moist peaty soil, and it is only in such soil, and in an open airy situation, that it can be preserved for any length of time. Like all the species of this order, it is propagated by layers, and sometimes by division. It flowers from May to September. This species and the following are sometimes admitted into ericetums, as being nearly allied to heaths, but in our opinion very improperly, for two reasons: first, because the leaves are so much broader than those of any heath, that, both in a general and a botanical point of view, they destroy the unity of the whole or scene; and, secondly, because, to grow these two andromedas properly, they require to be planted in much moister peat than is suitable for any species of heath.



Varieties. The following varieties, the first of which may be considered as the normal form of the species, are enumerated in *Lodd. Cat.*, ed. 1836.

- *A. p. 1 angustifolia* Lodd. Bot. Cab., t. 1591., and our fig. 890., has narrow leaves.
- *A. p. 2 ericoides* has the habit of a heath.
- *A. p. 3 grandiflora* Lodd. Bot. Cab., t. 1714., and our fig. 891., has large flowers.
- *A. p. 4 latifolia* Lodd. Bot. Cab., t. 546., and our fig. 892., has broad leaves.



890



891



892



893

- *A. p. 5 minima* has small flowers.
 - *A. p. 6 revoluta* Lodd. Bot. Cab., t. 725., and our fig. 893., has the flowers bent back.
 - *A. p. 7 scotica* is common in Scotland.
 - *A. p. 8 stricta* has the branches erect.
- 2. *A. ROSMARINIFOLIA* Pursh. The Rosemary-leaved Andromeda.

Identification. Pursh Fl. Amer. Sept., 1. p. 291; Don's Mill., 3. p. 829.
Synonyme. *A. polifolia Michx. Fl. Bor. Amer.*, 2. p. 254., *Pall. Fl. Ross.*, 2. p. 53.
Engraving. *Pall. Fl. Ross.*, 2. p. 53. t. 70. f. B.

Spec. Char., &c. Leaves linear-lanceolate, convex, revolute, white beneath, and canescent above. Corollas nearly globose. Calycine segments oblong red. Flowers white, tinged with red. (*Don's Mill.*, iii. p. 829.) A shrub growing to the height of 1 ft.; a native of Newfoundland and Labrador, and flowering in June. It is occasionally to be met with in collections, but when it was introduced is uncertain.

GENUS V.

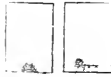

CASSIOPÆ D. DON. THE CASSIOPE. *Lin. Syst. Decándria Monogýnia.*

Identification. D. Don in Edinb. New Phil. Journ., 17. p. 157.; Don's Mill., 3. p. 829.

Synonymy. *Andrómeda hypnoides* *Lin. Sp.*, 563., *Lin. Fl. Lapp.*, 165. t. I. f. 3.,

Ed. Fl. Dan., t. 10., *Pall. Fl. Ross.*, p. 55. t. 73. f. 2., *Hooker in Bot. Mag.*, t. 2936.

Derivation. From *Cassiope* wife of Cepheus, and mother of Andromeda, whose foolish boast that her beauty was superior to that of the Nereides provoked the wrath of Neptune. (See p. 1105.)

1. *C. HYPNÕIDES* D. Don. The Hypnum-like Cassiope.

Identification. D. Don in Edinb. New Phil. Journ., 17. p. 157.; Don's Mill., 3. p. 829.

Synonymy. *Andrómeda hypnoides* *Lin. Sp.*, 563., *Lin. Fl. Lapp.*, 165. t. I. f. 3., *Ed. Fl. Dan.*, t. 10., *Pall. Fl. Ross.*, p. 55. t. 73. f. 2., *Hooker in Bot. Mag.*, t. 2936.

Engravings. *Lin. Fl. Lapp.*, t. I. f. 3.; *Fl. Dan.*, t. 10.; *Pall. Fl. Ross.*, t. 73. f. 2.; *Bot. Mag.*, t. 2936.; and our *fig.* 894.

Spec. Char., &c. A small creeping shrub, resembling a kind of moss. Leaves loose, flat, and needle-like. Flowers small, with a red calyx, and white corolla. (*Don's Mill.*, iii. p. 829.) A native of Lapland, Denmark, and Siberia, on the mountains, where it covers whole tracts of land; and on the north-west coast of North America. Introduced in 1798; but rare in collections, from the difficulty of keeping it. There are plants at Messrs. Loddiges, where it flowers in June and July, and is protected during winter.



894

2. *C. TETRAGO'NA* D. Don. The 4-cornered-branched Cassiope.

Identification. D. Don in Edinb. New Phil. Journ., 17. p. 157.; Don's Mill., 3. p. 829.

Synonymy. *Andrómeda tetragona* *Lin. Sp.*, 563., *Lin. Fl. Lapp.*, 166. t. I. f. 4., *Pall. Fl. Ross.*, p. 50. t. 73. f. 4., *Hooker in Bot. Mag.*, t. 3181.

Engravings. *Lin. Fl. Lapp.*, t. I. f. 4.; *Pall. Fl. Ross.*, t. 73. f. 4.; *Bot. Mag.*, t. 3181.; and our *fig.* 895.

Spec. Char., &c. Leaf obtuse, minutely ciliated, its margin revolute, in such a manner as to render the leaf tumid, and somewhat 2-celled. Leaves appressedly imbricate in 4 rows, and into a 4-cornered column, of which the stem or branch is the axis and support. (*Don's Mill.*, iii. p. 829.) A native of Lapland and Siberia; and, in North America, of Canada, Labrador, and the north-west coast; and of the Island of St. Lawrence, Kotzebue Sound. Introduced in 1810, and cultivated by Messrs. Loddiges, and in some other collections. It flowers in March and April, and requires protection during winter. This species and the preceding one may, without destroying the harmony of the scene, be admitted into the ericetum; but they are both difficult to keep, requiring a sandy peat, which should never be stirred after planting; and which should be kept cool, and, as far as practicable, in an equable degree of moisture throughout the year. Covering the soil round the plant closely with small pebbles, immediately after it is planted, has the effect of consolidating the soil, and retaining moisture; but in very hot sunshine, it produces rather too much heat.



895

App. i. *Hardy Species of Cassiope, not yet introduced.*

C. lycopodioides D. Don; *Andrómeda lycopodioides* *Pall. Fl. Ross.*, p. 55. t. 73. f. 1.; is a small moss-like, creeping shrub, with red flowers, a native of Siberia and the Island of St. Lawrence.

C. ericoides D. Don; *Andrómeda ericoides* *Pall. Fl. Ross.*, p. 56. t. 73. f. 3.; is a heath-like creeping shrub, a native of Dahuria and Kantschatka.

C. Redówskií G. Don in *Don's Mill.*, 3. p. 829.; *Andrómeda Redówskií* Cham. et Schlecht. in *Linnaea*, 1. p. 517., is a procumbent much-branched shrub, a native of the east of Siberia.

C. Mertensiana G. Don, *Don's Mill.*, 3. p. 829.; *Andrómeda Mertensiana* Bongard in *Mém. Acad. Petersb.*, 2. p. 152. t. 5.; is a procumbent shrub, with the habit of *C. tetragona*, indigenous to the Island of Sitcha.

C. fastigiata D. Don; *Andrómeda fastigiata* *Wall. Pl. Rar. Asiat.*, 3. t. 254.; *A. cupressiformis* *Wall. MSS.*; is a procumbent shrub, a native of Nepal and Mongol.

GENUS VI.

CASSANDRA D. Don. THE CASSANDRA. *Lin. Syst.* Decándria Monogýnia.

Identification. D. Don in Edinb. New Phil. Journ., 17. p. 157.; Don's Mill., 3. p. 830.

Synonymy. *Andróméda* sp. *Lin. and others.*

Derivation. The name of a daughter of Priam and Hecuba.

■ 1. *C. CALYCU'LA* D. Don. The calyculated Cassandra.

Identification. D. Don in Edinb. New Phil. Journ., 17. p. 157.; Don's Mill., 3. p. 830.

Synonymy. *Andróméda calyculata* *Lin. Sp.*, 563., *Pall. Fl. Ross.*, 2. p. 53. t. 71. f. 1., *Lodd. Bot. Cab.*, t. 1464.

Engravings. *Pall. Fl. Ross.*, 2. t. 71. f. 1.; *Bot. Cab.*, t. 1464.; and our fig. 896.

Spec. Char., &c. Leaves elliptic-oblong, bluntish, obsoletely serrulated, rusty beneath. Racemes recurved, leafy. Bractees of the calyx (these constitute the calyculus, or secondary and outer calyx, implied by the term calyculata) broad, ovate, acuminate. Corollas oblong-cylindrical. (*Don's Mill.*, iii. p. 830.) A native of North America, from Canada to Virginia, on the mountains, in bogs and swamps. It grows also in Sweden, Prussia, Siberia, &c. Introduced in 1748, and frequent in collections. Flowering from February to April.



896

Varieties. The following forms of this species are enumerated in Don's *Miller*:—

■ *C. c.* 1 *ventricosa* Sims *Bot. Mag.*, t. 1286.—Corolla inflated.

■ *C. c.* 2 *latifolia* Lodd. *Bot. Cab.*, t. 530.—Leaf broad.

■ *C. c.* 3 *nana* Sims *Bot. Mag.*, t. 862., *Lodd. Bot. Cab.*, t. 826.—Dwarf.

■ 2. *C. (C.) ANGUSTIFO'LIA* G. Don. The narrow-leaved Cassandra.

Identification. Don's Mill., 3. p. 830.

Synonymy. *Andróméda calyculata* β *angustifolia* *Ait. Hort. Kew*, 2. p. 70.; *A. angustifolia* *Pursh Fl. Amcr. Sept.*, 1. p. 291.; *A. crispata* *Desf. et Link.*, and our fig. 897.

Spec. Char., &c. Leaves linear-lanceolate, acute, the edges somewhat waved and revolute, the under-surface rusty. Racemes recurved, leafy. Bractees of calyx minute. Corollas oblong-ovate. (*Don's Mill.*, iii. p. 830.) A native of Carolina and Georgia, in open swamps. Introduced in 1748, growing to the height of 1 ft., and flowering in February and April. It is frequent in collections.



897

GENUS VII.

ZENOBIA D. Don. THE ZENOBIA. *Lin. Syst.* Decándria Monogýnia.

Identification. D. Don in Edinb. New Phil. Journ., July, 1834.; Don's Mill., 3. p. 830.

Synonymy. *Andróméda* sp. *Michaux.*

Derivation. From *Zenobia*, a queen Palmyra, distinguished for her virtue and learning. (*D. Don.*)

❖ 1. *Z. SPECIOSA* D. Don. The showy-flowered Zenobia.

Identification. D. Don in Edinb. New Phil. Journ., July, 1834; Don's Mill., 3. p. 830.

Synonymy. *Andrōmeda speciosa* Michx. Fl. Bor. Amer., 256; Lodd. Bot. Cab., t. 551.

Engravings. Bot. Cab., t. 551; and our figs. 898.

Description. Leaves oval, obtuse, mucronate, crenate, or serrate, veiny. Flowers white, drooping, disposed in racemes. Branches in the flower-bearing part naked of leaves. (*Don's Mill.*, iii. p. 830.) A very ornamental little shrub, native of North Carolina, in swamps. This very handsome species was introduced in 1800. It grows to the height of 2 ft. or 3 ft., and flowers in June.

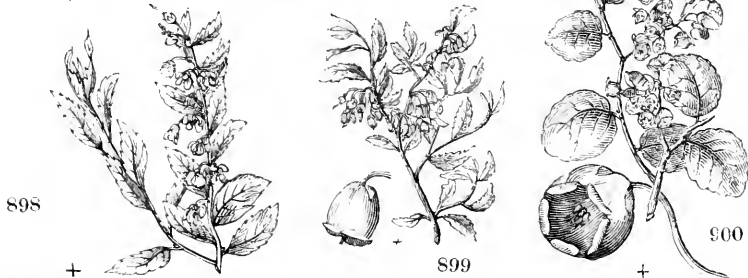

Varieties. In Don's *Miller* the following forms are enumerated and described: —

❖ 2. *Z. s. 2 nitida* Pursh Fl. Amer. Sept., i. p. 294., under *Andrōmeda cassinefolia* Vent. *Malm.*, 79.; and our fig. 899. — Leaves oblong-ovate, serrate, green on both surfaces. Flowers white.

❖ 3. *Z. s. 3 pulverulenta* Pursh Fl. Amer. Sept., i. p. 294., under *Andrōmeda speciosa*; *A. pulverulenta* *Bartram Itin.*, 476., *Curt. Bot. Mag.*, t. 667.; *A. cassinefolia* β Vent. *Hort. Cels.*, 60.; *A. speciosa* var. γ glauca *Wats. Dend. Brit.*, t. 26.; *A. dealbata* *Lindl. Bot. Reg.*, t. 1010.; *A. ovata* *Soland. MS.* in *Herb. Banks.*; and our fig. 900. — Leaves roundish-ovate, distantly crenate, covered with white powder, as are the branches. Flowers white.

GENUS VIII.



LYONIA Nutt. THE LYONIA. *Lin. Syst.* Decāndria Monogynia.

Identification. Nutt. Gen. Amer., 1. p. 268.; D. Don in Edinb. New Phil. Journ., 17. p. 158.; Don's Mill., 3. p. 830.

Synonymy. *Andrōmeda* sp. *Lin.* and various authors.

Derivation. In commemoration of *John Lyon*, an indefatigable collector of North American plants, who fell a victim to a dangerous epidemic amidst those savage and romantic mountains which had so often been the theatre of his labours. (*Don's Mill.*, iii. p. 830.)

Description. Evergreen and deciduous shrubs, and also a tree. Natives of North America, and bearing the common character of the plants of the order, both in respect to beauty, soil, situation, propagation, and culture.

A. *Leaves evergreen.*

❖ 1. *L. FERRUGINEA* Nutt. The rusty-looking Lyonia.

Identification. Nutt. Gen. Amer., p. 266.; Don's Mill., 3. p. 830.

Synonymy. *Andrōmeda ferruginea* *Walt. Fl.*, 138., *Vent. Matm.*, t. 80.; *A. ferruginea* β *fruticosa* *Michx. Fl. Bor. Amer.*, 1. p. 252.

Engraving. *Vent. Malm.*, t. 80.

Spec. Char., &c. Shrubby, evergreen. Leaves on long petioles, coriaceous, obovate, usually obtuse, quite entire, with hardly revolute edges, and co-

vered with brown, umbilicate, bran-like scales, as is every other part of the plant. Flowers axillary, 3 or 5 together, upon pedicels. Corolla small, ovate, globose, white inside, rusty-looking outside. (*Don's Mill.*, iii. p. 830.) A native of Georgia, Florida, and Mexico, in pine woods, where it grows to the height of from 3 ft. to 5 ft., and flowers in June and July. It was introduced in 1784, and is occasionally to be met with in collections. There are plants at Messrs. Loddiges's, which are kept under glass during winter.

■ 2. *L. RIGIDA* Nutt. The rigid-leaved *Lyonia*.

Identification. Nutt. Gen. Amer., 1. p. 266.; Don's Mill., 3. p. 830.

Synonymes. *Andróméda ferruginea* Willd. Sp., 2. p. 609.; *Ait. Hort. Kew.*, 2. p. 67.; *A. ferruginea* 1 *arboréscens* Michx. Fl. Bor. Amer., 1. p. 252.; *A. rigida* Pursh Fl. Amer. Sept., 1. p. 292., Lodd. Bot. Cab., t. 430.

Engraving. Bot. Cab., t. 430.

Spec. Char., &c. Arborescent, evergreen. Leaves crowded, coriaceous, rigid; their petioles short; their disks cuneate-lanceolate, acute, entire, convex, with revolute edges, and clothed with brown, umbilicate, bran-like scales, as is every other part of the plant. Flowers produced, in Britain, in April and May, axillary, several together. Corolla globose, white inside. Closely akin to *L. ferruginea*; but the two are distinguishable by their different habits, especially by their times of flowering. (*Don's Mill.*, iii. p. 831.) There are plants at Messrs. Loddiges's kept under glass during winter.

■ 3. *L. MARGINATA* D. Don. The marginated-leaved *Lyonia*.

Identification. D. Don in Edinb. New Phil. Journ., 17. p. 159.; Don's Mill., 3. p. 830.

Synonymes. *Andróméda marginata* Du Ham. Arb.; *A. coriacea* Willd. Sp., 2. p. 613., *Ait. Hort. Kew.*, 2. p. 70., *Sims Bot. Mag.*, t. 1095.; *A. lucida* Lam. Encyc., 1. p. 157.; *A. mariana* Jacq. Icon. Rar., 3. t. 465.

Engravings. Bot. Mag., t. 1095.; Jacq. Icon. Rar., t. 465.; and our fig. 902.

Spec. Char., &c. A small shrub, evergreen, glabrous. Branchlets indistinctly 3-sided. Leaves coriaceous, oval, acuminate, quite entire, glabrous, punctured with very fine punctures; the mid-rib running through the deflexed margin. Flowers upon pedicels, axillary, aggregate. Calyx of a dark red colour, its segments long, linear.

Corolla cylindrical, pale red. (*Don's Mill.*, iii. p. 830.) A native of Carolina and Florida, in sandy forests; flowering in June and July. It was introduced in 1765, and, in British gardens, grows to the height of 2 ft.

901



Variety.

■ *L. m. 2 rubra* Lodd. Bot. Cab., t. 672.; and our fig. 901.—Flowers deep red. (*Don's Mill.*)

B. *Leaves deciduous.*

■ 4. *L. MARIANA* D. Don. The Maryland *Lyonia*.

Identification. D. Don in Edinb. New Phil. Journ., 17. p. 159.; Don's Mill., 3. p. 831.

Synonymes. *Andróméda mariana* Lin. Sp., 564., *Sims Bot. Mag.*, t. 1579., *Pluk. Mant.*, 448.

Engravings. Bot. Mag., t. 1579.; and our fig. 903.

Spec. Char., &c. Leaves deciduous, oval, acutish at both ends, entire, glabrous, rather coriaceous, paler beneath. Flower-bearing branches almost leafless. Flowers on pedicels, aggregate, large, white, sometimes tinged with red. Calyx leafy. Corolla ovate-cylindrical. Capsule conoid. (*Don's Mill.*, iii. p. 831.) A native of North America, from New

903



England to Florida, in woods and dry swamps, especially in sandy soil; growing to the height of 2 ft., or upwards, and flowering from May to August.

Variety.

♣ *L. m. 2 oblonga* Swt. has oblong leaves.

♣ 5. *L. RACEMOSA* D. Don. The racemose-flowered *Lyonia*.

Identification. D. Don in Edinb. New Phil. Journ., 17. p. 159; Don's Mill., 3. p. 831. "The cells of the anthers are said to be biaristate [2-awned] at the apex: it is, therefore, probably a species of *Zenobia*." (Don's Mill.)

Synonymes. *Andrōmeda racemosa* Lin. Sp., 564., L'Hérit. Stirp., 2. t. 13.; *A. paniculata* Walt. Car., 138., Gronov. Virg., 67.

Engraving. L'Hérit. Stirp., 2. t. 13.

Spec. Char., &c. Leaves deciduous, oval-lanceolate, acute, serrulate, membranous, glabrous. Flowers white. Spikes terminal, secund, elongated, simple, or branched. Bractees linear, acute, two at the base of a calyx, which is acute. Corolla cylindrical. (Don's Mill., iii. p. 831.) A native of North America, from Canada to Carolina, in bogs and swamps, where it becomes a middle-sized shrub, which may be reckoned one of the finest in North America, not only for the graceful appearance of its flowers, but also for their fine odour. It was introduced in 1736, grows to the height of 3 ft. or 4 ft., and flowers in June and July. A very desirable species.

♣ 6. *L. ARBOREA* D. Don. The Tree *Lyonia*.

Identification. D. Don in Edinb. New Phil. Journ., 17. p. 159; Don's Mill., 3. p. 831.

Synonyme. *Andrōmeda arborea* Lin. Sp., 565., Sims Bot. Mag., t. 905., Catesb. Car., 1. t. 71.

Engravings. Bot. Mag., t. 905.; Catesb. Car., 1. t. 71.

Spec. Char., &c. A beautiful tree, from 40 ft. to 60 ft. high. Branches taper. Leaves deciduous, oblong, acuminate, serrate, with mucronate teeth, glabrous, acid. Flowers in terminal panicles of many racemes. Corollas white, ovoid-cylindrical, downy. (Don's Mill., iii. p. 831.) A native of North America, from Pennsylvania to Florida, in the valleys of the Alleghany Mountains. The leaves have a very pleasant acid taste, from which the species has been called the sorrel-tree. They are frequently made use of by hunters in the mountains to alleviate thirst. It was introduced in 1752, and flowers in June and July. There is a tree of this species at Purser's Cross, which, in 1835, was 18 ft. high; and there is one of nearly the same height in the garden of Lady Tankerville, at Walton upon Thames. In the Botanic Garden at Carlsruhe, there is a tree which was about the same height in 1828, and which ripens seeds every year, from which abundance of plants have been raised.

♣ 7. *L. PANICULATA* Nutt. The paniced-flowered *Lyonia*.

Identification. Nutt. Gen. Amer., 1. p. 266.; Don's Mill., 3. p. 831.

Synonyme. *Andrōmeda paniculata* Lin. Sp., 564., L'Hérit. Stirp., 2. t. 12., Wats. Dend. Brit., t. 57.

Engravings. L'Hérit. Stirp. Nov., 2. t. 12.; Dend. Brit., t. 57.; and our fig. 904.

Spec. Char., &c. Downy. Leaves deciduous, obovate-lanceolate, narrowed to both ends, almost entire, the upper surface of the older leaves nearly glabrous. Flower-bearing branches terminal, paniced, nearly naked of leaves. Flowers small, in peduncled racemes. Corollas nearly globose, downy, white. (Don's Mill., iii. p. 831.) A native of North America, occurring from Canada to Carolina, in all swamps and woods. It was introduced in 1748, and, in British gardens, grows to the height of 3 ft. or 4 ft., flowering in June and July.

904



♣ 8. *L. SALICIFOLIA* Wats. The Willow-leaved *Lyonia*.

Identification. Wats. Dend. Brit., t. 38.

Engravings. Dend. Brit., t. 38.; and our fig. 905.

Spec. Char., &c. Leaves alternate, long-lanceolate, acuminate, scarcely serru-

late, shining, strewed with a few short gland-like hairs. Racemes of flowers compound, alternately sessile on the terminal branches. Flowers white, 1-petaled, globular, contracted at the mouth. (*Wats.*) A desirable species, nearly allied to *L. paniculata*, which flowers in June and July, but which is less remarkable in point of floral beauty, than for its fine shining foliage. Unfortunately for this, and other species of *Lyonia* and *Andr meda*, they are generally crowded together in masses, so that nothing is seen of any sort, but the points of its shoots struggling with those of others for light and air; whereas, were they planted singly, they would form objects so totally different, and of such superior beauty, as hardly to be recognised for the same species.



9. *L. FRONDO'SA* Nutt. The branchy *Lyonia*.

Identification. Nutt. Gen. Amer., 1. p. 267.; Don's Mill., 3. p. 831.
Synonyme. *Andr meda frondosa* Pursh Fl. Amer. Sept., 1. p. 295.

Spec. Char., &c. Densely villose with whitish hairs. Leaves deciduous, oblong or oblong ovate, blunt or acutish, often rusty, prominently veined; the lateral margins revolute, entire, and rough. Flowers white, in a terminal leafy panicle. Corollas globose, hispid, or downy. (*Don's Mill.*, iii. p. 831.) A native of the lower counties of Virginia and Carolina. Introduced in 1806, and growing to the height of 3 ft.; flowering in May and June. There are plants at Messrs. Loddiges's.

10. *L. MULTIFLO'RA* Wats. The many-flowered *Lyonia*.

Identification. Wats. Dend. Brit., t. 128.; Don's Mill., 3. p. 831.
Engravings. Dend. Brit., t. 128.; and our fig. 906.

Spec. Char., &c. Leaves deciduous, narrow, lanceolate, serrate, sprinkled with hair-like atoms. Flowers numerous, small, white, disposed in terminal panicles, that are composed of numerous grouped racemes. (*Don's Mill.*, iii. p. 831.) A native of North America; perhaps it is only a variety of *L. paniculata*. In British gardens, it grows to the height of 2 ft., flowering in July. The date of its introduction is uncertain; probably in 1812, by Lyon.



11. *L. CAPREÆFO'LIA* Wats. The Goat-Willow-leaved *Lyonia*.

Identification. Wats. Dend. Brit., t. 127.; Don's Mill., 3. p. 831.
Engravings. Dend. Brit., t. 127.; and our fig. 907.

Spec. Char., &c. Leaves deciduous, coriaceous, elliptic, with a short acuminate termination, serrulate, sprinkled with short fleshy hairs. Flowers white; disposed in racemes and corymbs that are mixed, lateral, and leafy. Corollas rather silky, globular, coarctate. A native of North America. Perhaps it is only a variety of *L. paniculata*. (*Don's Mill.*, iii. p. 831.)



App. i. *Doubtful Species of Lyonia, not yet introduced.*

L. rhomboid lis G. Don; *Andr meda rhomboid lis* N. Du Ham., 1. p. 192; is a native of Florida and Carolina, with triquetrous and floriferous branches, described in the *Nouv. au Du Hamet*, from dried specimens, and stated not to be yet cultivated in Europe.

GENUS IX



LEUCO'THOË D. Don. THE LEUCOTHÖE. *Lin Syst. Decándria Monogýnia.*

Identification. D. Don in Edinb. New Phil. Journ., 17. p. 159; Don's Mill., 3. p. 831.

Synonymes. *Andrómeda* sp. of authors previously.

Derivation. *Leucothöe* was a beautiful nymph, beloved by Apollo; who was buried alive by her father when he discovered her amour, and changed into the tree that bears the frankincense by her lover. (*Ovid. Met.*, iv. 196.) *Leucothöe* was also a name given to Ino after she was changed into a sea deity.

Description, &c. Evergreen shrubs, natives of North America, with coriaceous leaves, dentately spinulose; and flowers white, racemose, axillary, or terminal.

■ 1. *L. AXILLA'RIS* D. Don. The axillary-racemed *Leucothöe*.

Identification. D. Don in Edinb. New Phil. Journ., 17. p. 159; Don's Mill., 3. p. 832.

Synonymes. *Andrómeda axilláris* *Sotander* in *Hort. Kew.*, 2. p. 89; *Pursh Fl. Amer. Sept.*, 1. p. 292.

Engraving. Our fig. 908.

Spec. Char., &c. Leaves oblong or oval, acuminate; in the outward part of its length cartilaginous in the margin, and serrulate with mucronate teeth; upper surface glabrous; under surface covered with glandular hairs. Young branches clothed with powdery down. Flowers white, in short, spicate, sessile, axillary racemes, attended by scaly bractees. Corolla ovate-cylindrical. Filaments ciliated, very short, Capsule depressed, globose. (*Don's Mill.*, iii. p. 832. A native of North America, from Virginia to Georgia, on the mountains, where it grows to the height of 2 ft. or 3 ft. Introduced in 1765, and flowering in May and June.



Variety.

■ *L. a. 2 longifolia*; *Andrómeda longifolia* *Pursh Fl. Amer. Sept.*, i. p. 293., *Sims Bot. Mag.*, t. 2357.; *A. Wálteri* Willd.—Leaves linear-lanceolate, very long. (*Don's Mill.*)

■ 2. *L. SPINULO'SA* G. Don. The spinulose-toothed-leaved *Leucothöe*.

Identification. Don's Mill., 3. p. 832.

Synonymes. *Andrómeda spinulösa* *Pursh Fl. Amer. Sept.*, 1. p. 293.; *A Castesbævi* Walt. *Fl. Car.*, p. 137., Willd. *Sp.*, 2. p. 613., *Sims Bot. Mag.*, t. 1955., *Lodd. Bot. Cab.*, t. 1320.

Engravings. *Bot. Mag.*, t. 1955; *Bot. Cab.*, t. 1320; and our fig. 909.

Spec. Char., &c. Leaves glabrous, coriaceous, ovate-oblong, rounded at the base, gradually narrowed to the tip, acuminate, serrulate with teeth that are spinulose in some degree. Flowers white, disposed unilaterally, and rather loosely, in subspicate, axillary, subsessile racemes, and attended by scaly bractees. Corolla short, ovate-cylindrical. It resembles *L. axilláris* D. Don in several respects. (*Don's Mill.*, iii. p. 832.) A native of Lower Carolina, in North America, where it forms a shrub 2 ft. high. It was introduced in 1793, and flowers in May and June.



■ 3. *L. ACUMINA'TA* G. Don. The acuminate-leaved *Leucothöe*.

Identification. Don's Mill., 3. p. 832.

Synonymes. *Andrómeda acumináta* *Ait. Hort. Kew.*, 2. p. 70., *Pursh Fl. Amer. Sept.*, 1. p. 293., *Smith Exot. Bot.*, t. 89; *A. lucida* *Jacq. Icon. Rar.*, 1. t. 79; *A. populifolia* *Lam. Encycl.*, 1.

p. 195; *A. reticulata* *Wall. Fl. Car.*, 137; *A. formosissima* *Bartr.*; *A. laurina* *Michx. Fl. Amer. Bot.*, 1. p. 253; Pipe-stem-wood, *Amer. Engravings.* *Exot. Bot.*, t. 89; *Jacq. Icon. Rar.*, 1. t. 79; and our *fig.* 910.

Spec. Char., &c. Glabrous. Stems hollow. Leaves ovate-lanceolate, gradually narrowed to the tip, entire or unequally serrate, shining, nettedly veined, coriaceous. Flowers white, numerous, upon pedicels, drooping, disposed in racemes that are axillary, very short, corymbose, and nearly naked. Corolla cylindrically ovate. (*Don's Mill.*, iii. p. 832.) A native of North America, in Georgia and Florida, in sandy swamps. The shrub bears a great abundance of flowers, which give it a fine appearance. Its stems are used by the natives for making their pipe stems; whence the name of pipe-stem wood. It was introduced in 1765; grows to the height of 2 ft. or 3 ft., and flowers in July and August.



910

■ 4. *L. FLORIBUNDA* *D. Don.* The numerous-flowered *Leucothoe*.

Identification. *D. Don* in *Edinb. New Phil. Journ.*, 17. p. 159; *Don's Mill.*, 3. p. 832
Synonymy. *Andromeda floribunda* *Lyon Herb.*, *Ker Bot. Reg.*, t. 807., *Pursh Fl. Amer. Sept.*, 1. p. 293., *Sims Bot. Mag.*, t. 1566.
Engravings. *Bot. Reg.*, t. 807.; *Bot. Mag.*, t. 1566.; and our *fig.* 911.

Spec. Char., &c. Glabrous. Leaves ovate, oblong, acute, finely serrulate, appressedly ciliate, coriaceous. Flowers white, numerous, disposed unilaterally in racemes that are axillary and terminal, and constitute panicles. Pedicels with 2 bracteas. (*Don's Mill.*, iii. p. 832.) A native of North America, in Georgia, on the mountains, where it grows to the height of 2 ft. or 3 ft., and flowers in May and June. It was introduced in 1812, and, being extremely difficult to propagate, is still rare in collections. There are plants at Messrs. Loddiges's, at Messrs. Chandler's, and at Messrs. Osborne's at Fulham. Plants, some years since, were 10 guineas each, but they may now be had at a guinea. The plant is very prolific in flowers, and is extremely beautiful.



911

■ 5. *L. SPICATA* *G. Don.* The spicate-racemed *Leucothoe*.

Identification. *Don's Mill.*, 3. p. 832.
Synonymy. *Andromeda spicata* *Wats. Dend. Brit.*, t. 36.
Engravings. *Wats. Dend. Brit.*, t. 36.; and our *fig.* 912.

Spec. Char., &c. Glabrous, except that the branchlets are beset with short white hairs. Leaves elliptical-lanceolate, acute, ovate, or taper at the base, serrated. Flowers white, disposed unilaterally in long lateral and terminal racemes. (*Don's Mill.*, iii. p. 832.) A native of North America, occurring from Canada to Florida, where it forms a shrub 2 ft. in height, flowering in June. There are plants in British gardens; but when it was introduced is uncertain.



+ 912

GENUS X.



PIERIS *D. Don.* THE *PIERIS.* *Lin. Syst.* Decándria Monogýnia.

Identification. *D. Don* in *Edinb. New Phil. Journ.*, 17. p. 159; *Don's Mill.*, 3. p. 832.
Synonymy. *Andromeda* sp. *Wallich.*
Derivation. *Pieris*, a general appellation of the Muses, who were called Pierides, from their birth-place, Pieria, in Thessaly.
Description, &c. Trees and shrubs, natives of Nepal and Japan; and considered as only half-hardy.

† 1. P. OVALIFO'LIA D. Don. The oval-leaved Pieris.

Identification. D. Don in Edinb. New Phil. Journ., 3. p. 832; Don's Mill., 3. p. 832.

Synonymes. *Andrõmeda ovalifõlia* Wall. in *Asiat. Res.*, 13. p. 391., with a figure; *A. capricida* Hamilton MSS.

Engravings. *Asiat. Res.*, 13. p. 391.; and our fig. 913.

Spec. Char., &c. Leaves oval, acuminate, 2—4 in. long, 1—2 in. broad, rounded at the base, entire, downy when young. Flowers upon downy pedicels, and disposed unilaterally in lateral, leafy, lengthened racemes, many in a raceme. Racemes numerous. Segments of calyx ovate, and acute. Corolla oblong, downy, pale flesh-colour. (*Don's Mill.*, iii. p. 832.) A native of Nepal at Suembu and Sirinagur, where it forms a tree from 20 ft. to 40 ft. in height, the leaves and branches of which are poisonous to goats, as is implied in the epithet *capricida*. It flowers in May. It was introduced in 1825, and there are plants at Messrs. Loddiges's. With a view to keep up a distinctive character between the plants kept in green-houses and hot-houses, and those grown in the open air, we do not think it advisable to multiply, in collections, exotic species of genera of which the majority are hardy, and common in gardens; but, botanically, every species is interesting.



App. i. Half-hardy Species of *Pieris* not yet introduced.

P. formõsa D. Don (*Don's Mill.*, 3. p. 832.), *Andrõmeda formõsa* Wall., is a native of Nepal, where it forms an evergreen tree, with the habit of *A'rbutus* or *Cõtëbra*. The leaves are lanceolate, acuminate, crenulated, and glabrous; and the flowers rose-coloured, each furnished with a small bractea at the base. This would appear to be a very desirable species; and if it were introduced, and even found only half-hardy, some new sort might be obtained from it by means of cross-fecundation with hardy free-growing species.



P. lanceolata D. Don (*Don's Mill.*, 3. p. 832.), *Andrõmeda lanceolata* Wall., *A. squamulosa* D. Don (*Prod. Fl. Nep.*, p. 149.), is a small-branched tree, with elliptic leaves from 3 in. to 4 in. long, and purplish corollas.

P. japonica D. Don, *Andrõmeda japonica* Thunb., and our fig. 914., is a native of Japan, with glabrous, lanceolate, crenulated leaves, and red flowers.

GENUS XI.



PHYLLO'DOCE Sal. THE PHYLLODOCE. *Lin. Syst.* Decãndria Monogýnia.

Identification. Sal. Par., t. 36.; D. Don in Edinb. New Phil. Journ., July, 1834; Don's Mill., 3. p. 832.

Synonymes. *Andrõmeda* sp. L.; *Menziõsia* sp. Swartz, *Smith*.

Derivation. *Phyllodoce*, in mythology, was the name of one of the nymphs of Cyrene, daughter of the river Peneus.

Description, &c. Small evergreen shrubs, natives of the north of Europe, Asia, and North America; with linear leaves, obtuse, and spreading; and flowers terminal, solitary, or several together, in a sort of umbel.

† 1. P. TAXIFO'LIA Sal. The Yew-leaved Phyllodoce.

Identification. Sal. Par., t. 36.; Don's Mill., 3. p. 833.

Synonymes. *Menziõsia cæreulea* Swz. in *Lin. Soc. Trans.*, 10. p. 377. t. 30. f. a., *Smith Engl. Bot.*, t. 2469., *Lodd. Bot. Cab.*, t. 164.; *Andrõmeda cæreulea* *Lin. Sp.*, p. 563., *Lin. Fl. Lapp.*, p. 165. t. 1., f. 5.; *A. taxifõlia* *Pall. Fl. Ross.*, p. 54. t. 72. f. 2., *Lin. Fl. Lapp.*, ed. 2., p. 153. t. 1. f. 5., *Fl. Dan.*, t. 57.; *Erica cæreulea* *Willd. Sp.*, 2. p. 393.

Engravings. *Lin. Soc. Trans.*, 10. t. 50. f. a.; *Eng. Bot.*, t. 2469.; *Bot. Cab.*, t. 164.; *Fl. Lapp.*, t. 1. f. 5.; *Pall. Fl. Ross.*, t. 72. f. 2.; *Fl. Dan.*, t. 57.; *Gmel. Sib.*, 4. p. 151. t. 57. f. 2.; and our fig. 915.

Spec. Char., &c. Leaves with denticulated margins. Peduncles aggregate, glanded. Segments of the calyx acuminate. Anthers one third of the length of the filaments. Corolla blue or purple; red, on the authority of Pursb, in the species as found in North America. (*Don's Mill.*, iii. p. 833.) A native of Europe, North America, and Asia. In Europe: in Scotland on dry heathy moors, rare; near Aviemore, in Strathspey, on the authority of Mr. R. Brown of Perth; in the Western Isles of Shiant, on the authority of Mr. G. Don. In North America: on the White Hills of New Hampshire; and on the



north-west coast of Labrador. In Asia: on the mountains of Uda, in the north. Cultivated in British gardens, in moist peaty soil, where it forms a low, trailing, evergreen heath-like shrub.

2. *P. EMPETRIFORMIS* *D. Don*. The Empetrum-like Phyllodoce.

Identification. *D. Don* in *Edinb. New Phil. Journ.*, July, 1834; *Don's Mill.*, 3. p. 833.

Synonymy. *Menziësia empetriformis* *Smith* in *Lin. Soc. Trans.*, 10. p. 280; *Hook. Bot. Mag.*, t. 3176.

Engravings. *Bot. Mag.*, t. 3176; and our *fig.* 916.

Spec. Char., &c. Leaves with denticulated margins. Peduncles aggregate, sparingly glanded. Segments of the calyx ovate, obtuse. Corolla pale red. Anthers the length of the filaments. (*Don's Mill.*, iii. p. 833.) A native of North America; introduced in 1810, and forming a low, creeping, heath-like shrub, seldom exceeding 6 in. in height, and producing its pale red flowers in June and July.



916

GENUS XII.



DABÆCIA *D. Don*. THE DABÆCIA. *Lin. Syst.* Octándria Monogýnia.

Identification. *D. Don* in *Edinb. New Phil. Journ.*, 17. p. 160; *Don's Mill.*, 3. p. 833.

Synonymy. *Erica* sp. *Lin.*; *Andrómeda* sp. *Lin.*; *Menziësia* sp. *Juss.*

Derivation. *D. polifolia* *D. Don* is called, in Ireland, St. Dabæc's heath.

Description, &c. Low, heath-like, evergreen, shrubs, natives of the north of Europe and North America.

1. *D. POLIFOLIA* *D. Don*. The Poly-leaved Dabæcia.

Identification. *D. Don* in *Edinb. New Phil. Journ.*, 17. p. 160; *Don's Mill.*, 3. p. 833.

Synonymy. *Andrómeda Dabæcia* *Lin. Syst.*, 496; *Erica Dabæcia* *Lin. Sp.*, 599; *Eng. Bot.*, t. 35; *Menziësia Dabæcia* *Dec. Fl. Gall.*, 674; *Erica hibernica*, &c., *Raii Hist.*, 3. *Suppl.*, 244; *Menziësia polifolia* *Juss. Ann. Mus.*, 1. p. 55; *Fl. Hb.*, p. 180; *Faccinnum cantabrigium* *Huds. Fl. Angl.*, ed. 1. p. 143; *Petin. Gaz.*, 27. f. 4; Irish Whorts, Cantabrian Heath, St. Dabæc's Heath.

Engravings. *Eng. Bot.*, t. 35; *Petin. Gaz.*, 27. f. 4; *Sweet's Brit. Fl.-Gard.*, 2. s. t. 276; and our *figs.* 917, 918.

Spec. Char., &c. A bushy evergreen shrub, 1 ft. to 2 ft. high. Leaves elliptic, flat, clothed with white tomentum beneath. Flowers purple, in

917

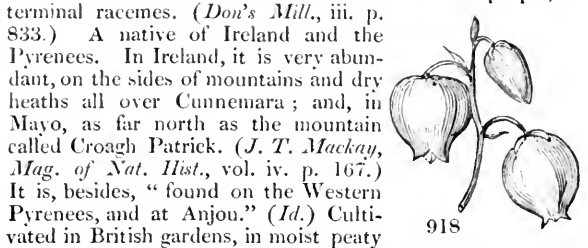

918

terminal racemes. (*Don's Mill.*, iii. p. 833.) A native of Ireland and the Pyrenees. In Ireland, it is very abundant, on the sides of mountains and dry heaths all over Cunnemara; and, in Mayo, as far north as the mountain called Croagh Patrick. (*J. T. Mackay, Mag. of Nat. Hist.*, vol. iv. p. 167.) It is, besides, "found on the Western Pyrenees, and at Anjou." (*Id.*) Cultivated in British gardens, in moist peaty soil. This species and its variety are very commonly introduced into heatheries, as closely resembling hardy low-growing heaths in their foliage and general habit. The foliage is of a darker green than almost any other heaths, and the leaves, singly, are also larger.

Variety.

1. *D. p.* 2 *fløre álbo* *Swt. Brit. Fl. Gard.*, 2d ser., t. 276. — A variety with white flowers, which was discovered in Cunnemara, in 1820, growing along with the common variety. (*Mag. of Nat. Hist.*, vol. iv. p. 167.) There are plants in Knight's Exotic Nursery, King's Road; and in other nurseries.

GENUS XIII.



ARBUTUS Camer. THE ARBUTUS, or STRAWBERRY TREE. Lin. Syst. Decándria Monogýnia.

Identification. Camer. Epit., p. 163.; Gærtn. Fruct., 59.; Tourn. Inst., 368.; Juss. Gen., 160.; H. B et Kunth Nov. Gen. Amer., 3. p. 279.; Adans. Fam.; Don's Mill., 3. p. 834.

Synonymes. Andráehne Clus.; Arbutus sp. Lin. Gen., No. 750., Schrad. Gen., 750.; Arbousier Fr.; Sandbeere, Ger.; Abbatro, Ital.

Derivation. From ar bois, austere bush, Celtic; in allusion to the austere quality of the fruit.

Description, &c. Robust evergreen shrubs, or low trees; natives of Europe, Asia, and North and South America; and, in British gardens, considered as some of the most ornamental of hardy evergreen shrubs. They are of easy culture, in sandy loam, or loam and peat; and they are readily propagated, the common kinds by layers, cuttings, or seeds, and the rarer and tenderer sorts by grafting on those that are more common and hardy. All the species have the outer bark more or less tinged with red. Plants, in British nurseries, are from 6d. to 2s. 6d. each. At Bollwyller and New York they are greenhouse plants.

♣ † 1. A. UNEDO L. The Unedo Arbutus, or Strawberry Tree.

Identification. Lin. Sp., 566.; Mill. Icon., t. 48.; Cam. Epit., 1681.; Barrel. Icon., t. 674.; Eng. Bot., t. 2377.; Don's Mill., 3. p. 134.; Eng. Flora, 2. p. 254.; Fl. Hib., p. 182.

Synonymes. L'Arbousier commun, Arbousier des Pyrénées, or Fraïsier en Arbre, Fr.; Erdbeereartige Sandbeere, Ger.; Komaá, Mod. Græck.

Engravings. Mill. Ic. l. 48.; Barrel. Ic., t. 674.; Eng. Bot., t. 2377.; and our fig. 919.

Spec. Char., &c. Arboreous. Branchlets clothed with glandular hairs. Leaves oblong-lanceolate, glabrous, serrulated. Flowers nodding. Peduncles smooth. (Don's Mill., iii. p. 834.)

A native of the south of Europe, as of Spain, Italy, and Greece; and of Asia, in Palestine, and many other parts. It is also found in the west of Ireland, in the county of Kerry, near the Lake of Killarney, on barren limestone rocks, where the country people eat the fruit.

Varieties. The following forms of this species are given in Don's Miller, and are to be procured in the principal London nurseries.

♣ † A. U. 1 álbus Ait. Hort.

Kew., ii. p. 71. — Flowers white. This is the common sort, raised in nurseries by seed. The flowers are sometimes of a greenish or yellowish-white, and sometimes reddish. The colour of the fruit also varies in a similar manner.

♣ † A. U. 2 rúber Ait. Hort. Kew., ii. p. 71. — Flowers reddish. This is the handsomest variety in cultivation. It is commonly propagated by layers, by cuttings, or by grafting on the species. Mackay mentions a single tree of this variety near the entrance to Glengariff, growing on red slate.

♣ A. U. 3 plénus Ait. Hort. Kew., ii. p. 71. — Flowers semidouble.

♣ A. U. 4 schizopétalus. — Corolla cut into more than the number (5) of segments constant to the corolla of the species.

♣ A. U. 5 integrifólius. — Leaves entire. (Sims Bot. Mag., t. 2319.)

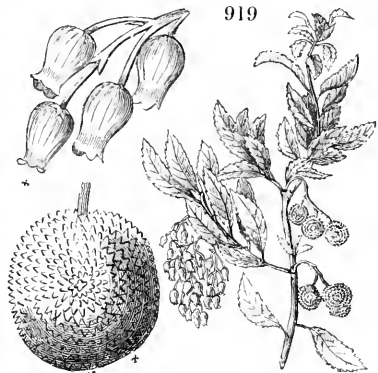

* A. U. 6 *crispus*. — Leaves curled and cut.

* A. U. 7 *salicifolius*. — Leaves narrow.

Description, &c. The common arbutus will grow to the height of 20 ft. or 30 ft.; but, unless pruned to a single stem, it assumes more the character of a huge bush than that of a regular-headed tree. When it is pruned, however, it forms a small, picturesque-headed, evergreen tree of great beauty, at every season of the year; and particularly so in autumn, when it is covered with its white bell-shaped flowers, which are slightly tinged with pink, intermixed with its large strawberry-like fruit, which is 12 months before it arrives at perfection, and which is, therefore, seen on the tree at the same time as the flower. Smith says that the fruit is insipid, and scarcely eatable in England; but that in the Levant it is said to be much larger and more agreeable, as well as more wholesome. The reddish hue of the bark is very remarkable in this and some other species of *Arbutus*. The rate of growth of the tree, when young, and properly treated, will average 1 ft. a year for the first 10 years; and the plant is of considerable durability.

Geography. The arbutus is a native of the south of Europe, also of various parts of Asia, and of Africa, about Mount Atlas and Algiers; and it is particularly abundant in Italy, in the woods of the Apennines. In France, it grows as far north as lat. 56°; but it requires protection, in the winter, in the neighbourhood of Paris. In Britain, it is one of the doubtful natives; for, though it seems to be perfectly naturalised in the south of Ireland, it is, as we have seen (p. 34.), considered by many as having been introduced there. Some of the defenders of our indigenous flora, however, feel no doubts on the subject. Mr. Babington, a writer in the *Mag. Nat. Hist.*, says, — “It has been doubted, if” *Arbutus U'nedo* “is indigenous at Killarney; but I cannot conceive it possible for any person, who has observed it on the spot, to believe it to have been ‘introduced by the monks of Mueross Abbey,’ which is the theory of the sceptical. It grows in several isolated spots, far up the mountains, and is in its greatest beauty when springing from the crevices of rock on the islets of the upper lake. My conclusion is, that it is truly an aboriginal native of that country. The fruit is excellent.” (!) (Vol. ix. p. 245.) Mr. J. Drummond, in Mackay’s *Flora Hibernica*, says that it is certainly indigenous.

History. The arbutus was known to the Greeks and Romans; but, according to Pliny, it was not held in much esteem; for, as the specific name implies, he adds, the fruit was considered so bitter, that only one of it could be eaten at a time. There can be no doubt, however, that it was an article of food, in the early ages, both in Greece and Italy; since in these countries, and also in Spain, as well as about Killarney, in Ireland, it is still eaten by the common people. Virgil recommends the young shoots as winter food for young goats, and as fit for basket-work. Horace praises the tree for its shade; and Ovid celebrates its loads of “blushing fruit.” It is spoken of by Gerard as, in his time, growing only in some few gardens in England. It is mentioned by various writers, both in poetry and in prose, who have been charmed with its beauty. Among others, Mrs. Barbauld, in her poem entitled *Corsica*, written in 1769, gives the following description of its appearance in that island in a wild state:—

— “While, glowing bright
Beneath the various foliage, wildly spreads
The arbutus, and rears his scarlet fruit
Luxuriant mantling o’er the craggy steeps.”

And Miss Twamley has the following lines on this tree in her *Romance of Nature* published in 1836.

“See, like a ladye in a festal garb,
How gaily deck’d she waits the Christmas time!
Her robe of living emerald, that waves
And, shining, rustles in the frost-bright air,
Is garlanded with bunches of small flowers, —
Small bell-shaped flowers, each of an orient pearl
Most delicately modeled, and just tinged
With faintest yellow, as if, lit within,
There hung a fairy torch in each lamp-flower.”

Properties and Uses. A sugar and a very good spirit have been extracted from the fruit in Spain, and a wine in Corsica: but, in Britain, the sole use of the plant is as an ornamental evergreen shrub or low tree. In the neighbourhood of Algiers it forms hedges; and there, in Greece, and also in Spain, the bark is used by tanners; and the charcoal made from the wood is highly valued. The wood is white, hard, and heavy, but brittle, and with little elasticity. The durability and abundance of its shining green foliage; the brownish red colour of its young shoots; the waxy and delicate appearance of its flowers, which are produced in abundance, at a season when most plants are beginning to shed their leaves; and the splendour of its fruit, which, as before observed, is intermixed with the flowers, and often remains on all the winter; render it a most desirable plant. In ornamental plantations, the pink-flowered variety deserves the preference, not only on account of the beauty of its flowers, but because the young shoots and the nerves of the leaves partake of a reddish hue.

Soil, Situation, &c. The common arbutus will thrive in any tolerably free soil; though it seems to grow fastest, and attain the largest size, in deep sandy loam. It will grow either in open or sheltered situations, but does not thrive under the shade of trees. The species is readily propagated by seeds, which should be sown, as soon as they are separated from the pulp of the fruit, in pots of light, rich, sandy soil, or heath mould, and then placed in the shade, where they can be protected from the frost and the sun. Plants raised from seed do not generally flower till 5 or 6 years old. The double, and the scarlet-flowered, and all the other varieties, are propagated by layers; or by cuttings of the wood in a growing state, taken off in July, and treated like cuttings of heath.

Statistics. In the environs of London, in the arboretum at Kew, the common arbutus is 12 ft. high; and it is equally high, or higher, at a great number of places within the same distance of the metropolis. In the Mile End Nursery it is 15 ft. high, and the diameter of the head is 45 ft. In the Garden of the Horticultural Society, and in the arboretum of Messrs Loddiges, plants, 10 years planted, have attained the height of 10 ft. In Scotland, in Argyllshire, at Castle Mainard, it is 13 ft. high. In Ireland, on the lower lake of Killarney, a tree, or large bush, was 36 ft. in diameter in 1805; one at Power's Court is equally large; and a similar one existed at Newtown Mount Kennedy, but was blown down in 1804; at Morn Park, Cork, it is 32 ft. high, the diameter of the trunk 2 ft. 3 in., and of the head 23½ ft. The price of plants, in the London nurseries, is from 6d. to 1s. each, according to the size, or from 1l. 7s. 6d. to 3l. 15s. per hundred; and the scarlet-flowered variety is 2s. 6d. a plant. At Bollwyller, and at New York, both the species and varieties are green-house plants.

† 2. *A. HYBRIDA* Ker. The hybrid Arbutus, or Strawberry Tree.

Identification. Ker Bot. Reg., t. 619.; Don's Mill., 3. p. 834.
Synonymy. *A. andrachnoides* Link Enum., 1. p. 395.
Engravings. Bot. Reg., t. 619.; and our fig. 920.

Spec. Char., &c. Branchlets pilose. Leaves oblong, acute, serrated, glabrous. Panicle terminal, pendulous, downy. Flowers white. Calyx glabrous.

(Don's Mill., iii. p. 834.) Apparently a hybrid between *A. U'nedo*, and *A. Andrachne*. It has been cultivated in British gardens ever since the commencement of the present century, and is believed to have been originated in the Fulham Nursery, where there were, till lately, some of the largest specimens in the neighbourhood of London, and where there is still one, about 20 years planted, which is nearly 20 ft. high. This species grows as rapidly as the *A. U'nedo*, forms fully as large a tree, is more beautiful in its flowers which are in larger panicles, and is nearly as hardy. It flowers freely, and sometimes bears fruit, but is generally propagated by grafting. Plants in the garden of the London Horticultural

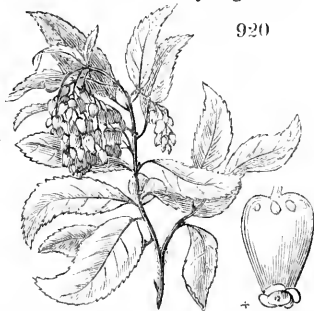

Society, and in the arboretum of Messrs. Loddiges, are 12 ft. high, after having been 10 years planted.

Variety.

- † * *A. h. 2 Milleri* (*A. Milleri* Mayes in West of England Journ. of Science and Lit., Jan. 1835; and Gard. Mag., xi. p. 259.) was raised from seed in the Bristol Nursery, from the scarlet-flowered variety of *A. U'nedo* and *A. Andrachne*. The flowers are of a delicate pink, the leaves are large, and the plant vigorous.

‡ 3. *A. ANDRACHNE* L. The *Andrachne Arbutus*, or *Strawberry Tree*.

Identification. Lin. Sp., 566; Ehret Act. Angl., 57. p. 114. t. 6; Ker Bot. Reg., t. 113; Sims Bot. Mag., t. 2024; Don's Mill., 3. p. 834.

Synonymes. *A. integrifolia* Lam.; *Andrachne Theophrasti* Clus. Hist., 1. p. 48; *Andrachne Park. Theatr.*, 1490., f. 2. This is the *Adrachne* of Theophrastus; and it is called *Adrachila* in modern Greek.

Engravings. Ehret Act. Angl., 57. t. 6; Bot. Reg., t. 113; Bot. Mag., t. 2024; Park. Theatr., 1490. f. 2; and the plate in our last Volume.

Spec. Char., &c. Leaves oblong, bluntish, entire in some, a little serrated in others, glabrous. Panicles terminal, erect, clothed with viscid down. Flowers greenish white. Fruit like that of *A. U'nedo*. (*Don's Mill.*, iii. p. 384.) A native of Greece, Asia Minor, and Tauria.

Varieties.

Tournefort enumerates three varieties, which he observed in the Levant:—

1. With serrated leaves;
2. With a large oblong fruit;
3. With large compressed fruit: but there is only the following variety, which is probably the first of those mentioned by Tournefort, in British nurseries:—

- † *A. A. 2 serratifolia* (*A. serratifolia* Nois.; the *serrated-leaved Arbutus*, as shown in *Lodd. Bot. Ceb.*, t. 580, and our fig. 921; *Don's Mill.*, 3. p. 834.) has the leaves serrated, and narrower than those of the species. The flowers are yellowish, and disposed in terminal clusters. It is cultivated in British gardens; but it is not known when, or from what country, it was introduced.



921

Description. This species differs from the common *arbutus* in having much longer leaves, smooth, coriaceous, and shining, and but slightly, if at all, serrated, and polished; but the outer bark cracks, and peels off in very thin papery layers, annually. By this feature alone it is readily distinguished from the common *arbutus*. The flowers resemble those of the common sort; but the fruit is oval, with flat seeds; whereas in the common sort the seeds are pointed and angular. The plants, when young, are somewhat tender; but, if kept in pots till 2 ft. or 3 ft. high before they are planted out, they will endure the winters in the neighbourhood of London without any protection; and will grow nearly as rapidly as the common *arbutus*, becoming eventually much larger and finer trees.

Geography. The *Arbutus Andrachne* is most abundant in the Levant. It is found in the Isle of Candia, and in various islands of the Archipelago, in the neighbourhood of Damascus, Aleppo and Antioch; also on Mount Olympus, about Smyrna, and in various other parts of Syria. It is found in some places in the north of Africa.

History. The tree abounds in Greece, and is mentioned by Theophrastus and other writers under the name of *Adrachne*. Pausanias says that the *Adrachne* produces the best fruit on Mount Helicon. In the *Nouveau Du Hamel*, it is stated that the translators of Pausanias have confounded two names, by which the Greeks designated two plants quite different: *Adrachne*, which is the species of *Arbutus* now before us; and *Andrachne*, the *Portulaca* of the Latins, and the modern *Verónica Beccabunga*. Clusius, J. Bauhin, Ray, and Tournefort recognised this difference, and spelt the word accordingly; but Linnæus paid no attention to it. Theophrastus says that the *Adrachne* is a tree of which the leaves at the extremities of the branches are always green;

and that its wood is employed for making tools for the weaver, and spindles for the women. Pliny says that the *Adrachne* resembles the *Unedo*; and *Adrachla* is the vulgar name for this species of *Arbutus* throughout Greece, at the present day, as indicated in the synonymes above. This species was first brought to England from Smyrna in 1724, and cultivated at Eltham by Dr. Sherard; many years afterwards, it was sent from London to Paris; and it is now frequent in the gardens in the neighbourhood of both capitals: in the environs of London, as a shrub or low tree in the open ground; and about Paris, as a conservatory plant for training against a wall, and protecting in winter. In Smith's *Correspondence of Linnæus*, it is stated that the *Arbutus Andrachne* flowered for the first time in Europe in Dr. Fothergill's garden at Ham House, in Essex, in May, 1766. The plant there was raised from seed sent to Dr. Fothergill from Dr. Russell of Aleppo, in 1756. After Dr. Fothergill's death, the plant was sold by auction, in August, 1781, for 53*l.* 11*s.* It was purchased by a nurseryman for the purpose of being cut up into scions for grafting on the common *Arbutus*. It is also stated that a tree fully twice as large as that at Ham House, which was long the boast of the Chelsea Botanic Garden, was killed by the cold winter of 1796.

Properties and Uses. In countries where it is indigenous, the fruit is eaten, and the wood used for fuel and other useful purposes. The tree was so abundant in the neighbourhood of Aleppo, that, in Russell's time, it supplied nearly half the fuel in the city. In Britain, it is only to be considered in the light of an ornamental tree; and there are few evergreens which can be compared with it for the beauty and varied disposition of its foliage, and the singularity of the bark of its trunk, which annually presents a new and smooth surface to the eye.

Soil, Situation, &c. A free sandy loam, kept rather moist, seems to suit this tree where the climate is favourable to it: for example, in the neighbourhood of London; but farther north, a dry soil will be found preferable, in order that the plant may not be stimulated to make more wood than it can thoroughly ripen. The situation should always be sheltered, though not shaded by other trees. In a gardenesque arrangement of trees, the particular beauty of the trunk and branches of the *andrachne* will be best observed; but, if planted in picturesque masses in a shrubbery, its forms and foliage will harmonise very well with those of other species of *Arbutus*, and of the larger *Ericacææ*.

Statistics. In the environs of London there are plants of *Arbutus Andrachne*, as standards, from 8 ft. to 10 ft. high: one in the Hackney arboretum, 12 ft. high; and one in the Chelsea Botanic Garden 12 ft. high: there are also plants at White Knights, 13 ft. high, with heads 15 ft. in diameter. There is a tree of this species in the Edinburgh New Botanic Garden, which was removed thither from the old one in 1822, when it was 13 ft. in height, with a stem 10½ in. in diameter, at 1 ft. from the ground. We have received notices of several other large specimens; but, as *A. hybrida* resembles *A. Andrachne* in general appearance, and in the circumstance of casting its bark, we believe that species to have been frequently mistaken for the Oriental one in some of the accounts that have been sent us, from the rapid growth attributed to the trees. Price of plants, in the London nurseries, is from 3*s.* 6*d.* to 5*s.* each.

4. *A. PROCERA Douglas.* The tall *Arbutus*, or *Strawberry Tree*.

Identification. Lindl. Bot. Reg., t. 1573.

Engraving. Bot. Reg., t. 1573.

Spec. Char., &c. A robust shrub, or rather tree, a native of the mountainous woody parts of the north-west coast of North America, sent by Mr. Douglas to the London Horticultural Society, in 1827. It bears a general resemblance to *A. Andrachne*, but differs from it altogether in the form and serratures of its leaves, and in the form and size of its flowers, the corollas of which are of a delicate greenish white. Till the plant is 3 or 4 years old, it requires protection during winter; and it will probably be found advisable, in most situations north of London, to train it to a wall. There is a plant against the wall, in the Garden of the Horticultural Society, which has stood there since 1830, and has grown as high as the wall. In the Fulham Nursery, this species appears to grow with greater rapidity than any other of the genus. It is propagated by grafting on the common species; and plants are 7*s.* 6*d.* each.

■ 5. *A. TOMENTOSA* Pursh. The downy *Arbutus*, or *Strawberry Tree*.

Identification. Pursh Fl. Amer. Sept., 1. p. 282; Hook. Bot. Mag., t. 3320; Hook. Fl. Amer. and Ex. Bot., 129. f. 1.; Don's Mill., 3., p. 835.

Synonymy. *Arctostaphylos tomentosa* Lindl. Bot. Reg., t. 1791.

Engravings. Bot. Mag., t. 3320; Hook. Fl. Amer., and Exot. Bot., 122., f. 1.; Bot. Reg., t. 1791.

Spec. Char., &c. Shrubby. The whole plant, except the flowers, downy while young. Branches hispid. Leaves with short and hispid petioles, midribs hispid, and disks oval, acute, subcordate at the base, and clothed with white tomentum beneath. Flowers bracteated, disposed in somewhat headed racemes, that are axillary, and shorter than the leaves. Corolla campanulately pitcher-shaped, pure white. (*Don's Mill.*, iii. p. 835.) A native of the west coast of North America, where it was collected by Mr. Menzies, and also by Mr. Douglas, and introduced in 1826. It deserves a place in every collection, from its copious evergreen foliage and showy flowers, which appear in profusion in a green-house in December, and in the open air in March. Plants have been kept in the open air in the garden of William Harrison, Esq., of Cheshunt, since 1831.

Variety.

- *A. l. 2 nuda* Hook. et Arnott in Beech. Voy. Pt. Bot., 144., Hook. Fl. Bor. Amer., 2. t. 129. f. 4.—The plant is quite destitute of long stiff hairs. (*Don's Mill.*, iii. p. 835.)

■ 6. *A. DENSIFLORA* H. B. et Kunth. The densely flowered *Arbutus*, or *Strawberry Tree*.

Identification. H. B. et Kunth: Nov. Gen. Amer., 3. p. 280. l. 260; Don's Mill., 3. p. 835.

Engraving. H. B. et Kunth Nov. Gen. Amer., 3. p. 280. l. 260.

Spec. Char., &c. Branches angular, pilose. Leaves 4—5 inches long; their petioles long, pilose; their disks oblong, acute, sharply toothed, coriaceous, glabrous above, and shining beneath, clothed with brown-tinged down, and the middle nerve with long rusty-hued hairs. Flowers crowded, disposed in panicles that are terminal and composed of approximate racemes. Pedicels furnished with 3 bracteas at the base. Corolla oval, white. Filaments dilated and pilose at the base. (*Don's Mill.*, iii. p. 835.) A native of Mexico, on the eastern declivities between La Plata and Xalapa; growing to the height of 20 ft. It was introduced in 1826, and is somewhat tender.

App. i. *Hardy Species of Arbutus not yet introduced.*

A. laurifolia Lin. Syst., 407., Suppl., 238., is a native of North America, but of what part is unknown, as Mr. G. Don could find nothing respecting it in the Linnaean herbarium.

A. Menziesii Pursh Fl. Amer. Sept., 1. p. 282., Hook. et Arn. in Beech. Voy., p. 143., is a tree, with leaves broad-oval, quite entire, glabrous, petioles long. Racemes axillary and terminal, paniced, and dense. It is a native of the north-west coast of America, where it was collected by Mr. Menzies.

A. cordifolia; *Arctostaphylos cordifolia* Lindl. Bot. Reg., Sept. 1835; was discovered by Mr. Menzies, on the north-west coast of America.

A. glauca; *Arctostaphylos glauca* Lindl., l. c.; discovered in California by the unfortunate Douglas.

App. ii. *Half-hardy Species of Arbutus.*

A. canariensis Lam. Dict., vol. 1., Bot. Mag., t. 1577., and our fig. 922., is a native of the Canary Islands, with oblong-lanceolate serrated leaves, glaucous beneath; and greenish white flowers, on hispid panicles. It has been in cultivation in British green-houses and cold-pits since 1796; flowering in May and June; and, there can be no doubt, would stand against a conservative wall with the usual protection.

A. petiolaris H. B. et Kunth is a tree, a native of Mexico, on mountains, where it attains a large size. The leaves are 3 or 3½ in. long.

A. furens Hook. et Arn. is a low-growing shrub a native of Chili, about Concepcion. The fruit is a reddish brown berry, which, when eaten, is said to cause delirium.

A. ratapensis H. B. et Kunth, and *A. mollis* H. B. et Kunth, which are natives of Mexico; and *A. ferruginea* Lin. Syst., 408., which is a native of New Granada, are described in Don's *Müller* as trees; but they have not yet been introduced



GENUS XIV.

ARCTOSTA'PHYLOS *Adans.* THE BEARBERRY. *Lin. Syst.* Decándria
Monogýnia.

Identification. Gall. *Adans. Fam.*; H. B. et Kunth *Nov. Gen. Amer.*, 3. p. 277; Spreng. *Syst.*, 2. p. 287.

Synonymes. U'va-úrsi *Dod., Tourn.*; *Arbutus* sp. *Lin.*

Derivation. From *arktos*, a bear, and *staphulè*, a grape.

Description. Evergreen undershrubs, natives of Europe and of North and South America.

* 1. *A. U'VA-U'RSI* *Spreng.* The common Bearberry.

Identification. Spreng. *Syst.*, 2. p. 827; Don's *Mill.*, 3. p. 835.

Synonymes. *Arbutus U'va-úrsi* *Lin. Sp.*, 566., *Fl. Lapp.*, No. 162., t. 6. f. 5., *Woodv. Med. Bot.*, 194. t. 70., *Fl. Dan.*, t. 33., *Blackw.*, t. 592., *Smith Eng. Bot.*, 714.; *Arbutus buxifolia* *Stokes Bot.*, 509.; *U'va-úrsi buxifolia* *Sal. in Gray's Arr.*, 2. p. 490.; Bearberries, and Bear-whortle-berries, *Eng.*; Barentraube, or Barenbeere, *Ger.*; Beerenduui, *Dutch.*; la Basserole, *Fr.*; Uva d'Orzo, *Ital.*; Uva de Oso, *Span.*; Uva de Urso, *Port.*; and Uva-ursi in the works of most old botanists.

Engravings. *Lin. Fl. Lapp.*, No. 162. t. 6. f. 5.; *Woodv. Med. Bot.*, 194. t. 70.; *Fl. Dan.*, t. 33.; *Blackw.*, t. 592.; *Engl. Bot.*, t. 714.; *Schmidt Baum.*, t. 158.; and our *fig.* 923.

Spec. Char., &c. Stems procumbent. Leaves permanent, obovate, quite entire, coriaceous, shining. Flowers fasciculate. Drupe 5-celled. Leaves

like those of the common box. Flowers pale red, or white with a red mouth, growing in small clusters at the extremities of the branches. (*Don's Mill.*, iii. p. 836.) A trailing shrub, a native of North America,

in the pine barrens of New Jersey, in mountains and rocky situations of Canada and New England, and in the Island of Unalaska. It is abundant on the continent of Europe; as, for example, in Sweden,

Denmark, and most parts of the north; also in Switzerland, Germany, Carniola, Dauphiné, Savoy, Siberia, &c. With us, it is common upon dry, heathy, mountainous, and rocky places, throughout the Highlands and Western Isles of Scotland; also in the north of England and Wales; flowering in May and June; and producing red berries, which are ripe in September. The berries

are filled with an austere mealy pulp, and serve as food for grouse and other birds in Britain; and, in Sweden, Russia, and America, they form a principal part of the food of bears. The whole plant is powerfully astringent: it abounds in the tannin principle; and, both in Sweden and America, it has been used for tanning leather, and dyeing it an ash-grey colour. It is also prescribed by rural practitioners in nephritic complaints; and, on the plains of the Mississippi, it is smoked by the Indians as a febrifuge. In British gardens, it finds a place among other peat-earth plants; and, though a native of cold and elevated regions, it thrives well in peat, kept moist, in the vicinity of London.

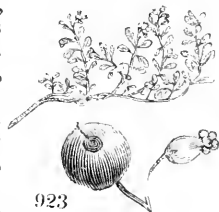

923

* 2. *A. ALPINA* *Spreng.* The Alpine Bearberry.

Identification. Spreng. *Syst.*, 2. p. 287; Don's *Mill.*, 3. p. 836.

Synonymes. *Arbutus alpina* *Lin. Sp.*, 566., *Ed. Fl. Dan.*, 73., *Smith Eng. Bot.*, t. 2030., *Lightf. Fl. Scot.*, 215. t. 11. f. a. b.

Engravings. *Engl. Bot.*, t. 2030.; *Lightf. Fl. Scot.*, 215. t. 11. f. a. b.

Spec. Char., &c. Stems procumbent. Leaves obovate, acute, wrinkled, serrated, deciduous. Racemes terminal. Pedicels rather hairy. The flowers grow in reflexed racemes, and are pure white. The berries are black when ripe, and of the size of a sloe, with a taste somewhat resembling that of black currants, but more mawkish; insomuch, that Linnaeus says the Laplanders will scarcely eat them. Haller, on the contrary, thinks the flavour not

unpleasant. (*Don's Mill.*, iii. p. 836.) A trailing shrub, native of Denmark, Switzerland, Dauphiné, Savoy, Siberia, &c. Found wild in many places of the Highlands of Scotland, in dry barren moors. Nothing is more common, says Linnæus, in all the Lapland alps, in Dalecarlia, from their tops to their bases, round the White Sea, especially in very sandy places. It is also found in Canada, and the more northern parts of America, in the Aleutian Isles, &c. In British gardens, it has long been a favourite peat-earth trailing shrub, requiring an airy situation. It does not thrive in the immediate vicinity of London, nor where it is much sheltered; but, either on rockwork, in beds of dry peat, or in moist peat, it grows with great luxuriance, and occasionally ripens fruit.

App. i. Half-hardy Species of *Arctostaphylos* not yet introduced.

- A. polifolia* H. B. et Kunth (*Don's Mill.*, 3. p. 836., *Andróméda tedifolia* Humb., is a native of the temperate parts of Mexico, growing to the height of from 4 ft. to 6 ft.
A. glaucescens H. B. et Kunth (*Don's Mill.*, 3. p. 836.) is a native of Mexico, with lanceolate-oblong leaves, and scarlet corollas.
A. pungens H. B. et Kunth (*Don's Mill.*, 3. p. 836.) is a native of Mexico, in elevated places, near Moran and Villalpando, where it forms a branchy shrub, about a foot in height.
A. Hookeri G. Don (*Mill. Dict.*, 3. p. 826.), *Arbutus pungens* Hook., is a native of Chili, where it forms a prostrate shrub, with the habit and leaves of *A. Uva-ursi*.

GENUS XV.



PERNETTYA Gaud. THE PERNETTYA. *Linn. Syst.* Decandria Monogynia.

Identification. Gaud. in *Frez. Voy.*, p. 154 t. 67.; *Don's Mill.*, 3. p. 836.

Derivation. Named after *Dom Pernetty*, the author of the *Account of a Voyage to the Falkland Isles*; a work remarkable for its interest, as well as for its candour and exactness. The original species of this genus was mentioned by this traveller under the name of "Bryère à feuilles pointues." (*Lindl. in Bot. Reg.* t. 1675.)

Description. Evergreen undershrubs. Natives of North and South America.

1. *P. mucronata* Gaud. The mucronate-leaved Pernettya.

Identification. Gaud. in *Ann. Sc.*, 5. p. 102.; *Don's Mill.*, 2. p. 836.

Synonymy. *Arbutus mucronata* *Linn. fil. Suppl.*, p. 230., *Forst. in Com. Gart.*, 9. p. 31., *Graham in Bot. Mag.*, t. 303., *Lam. Ill.*, t. 336. f. a., *Lodd. Bot. Cab.*, t. 1848., *Penny Cyc.*, vol. 4. p. 255.

Engravings. *Lindl. Bot. Reg.*, t. 1675.; *Bot. Mag.*, t. 3093.; *Lam. Ill.*, t. 336. f. a.; *Lodd. Bot. Cab.*, t. 1848.; and our fig. 924.

Spec. Char., &c. Leaves ovate, cuspidate, denticulately serrulate, stiff, shining on both surfaces. Pedicels axillary, bracteate, about equal in length to the leaves. Flowers white, drooping. (*Don's Mill.*, iii. p. 836.) A shrub growing to the height of from 2 ft. to 3 ft.; a native of Terra del Fuego, Cape Horn, and the Straits of Magellan. It was introduced in 1828, and flowers in May. In the garden of W. Harrison, Esq., of Cheshunt, in Hertfordshire it has, within 3 years, formed an evergreen bush, 3½ ft. in diameter, and 2½ ft. high, in a bed of peat soil. It is a hardy evergreen shrub, of considerable beauty, on account of the neat appearance and dark colour of its foliage. (*Bot. Reg.*, May, 1834.)



2. *P. pilosa* G. Don. The pilose, or hairy, Pernettya.

Identification. *Gard. Mag.*, 10. p. 286.; *Don's Mill.*, 3. p. 837.; *Bot. Mag.*, t. 3177.

Synonymy. *Arbutus pilosa* *Graham*. Dr. Lindley says, "As far as habit and the structure of the flowers are concerned, *Arbutus pilosa* *Graham* would be referable to *Pernettya*; but we incline to believe that plant an *Andróméda*" (*Bot. Reg.* t. 1675.) the doctor speaking of the genus *Andróméda* as it stood previously to Professor Don's division of it.

Engraving. *Bot. Mag.*, t. 3177.

Spec. Char., &c. Stem pilose, proeumbent. Leaves ovate-elliptic, ciliate serrulated, coriaceous, without a mucro, and callous at the point. Pedicels axillary, 1-flowered, elongated, deflexed. Corolla ovate, with blunt revolute teeth, white. (*Don's Mill.*, iii. p. 837.) A prostrate shrub, a native of Mexico. Introduced in 1828, or before; and found to be perfectly hardy in the Edinburgh Botanic Garden, and in the garden of Canonmills Cottage. The hairy prostrate branches are furnished with numerous toothed evergreen leaves, 9 lines long, and $4\frac{1}{2}$ broad. The flowers are not large.

App. i. *Hardy Species of Pernéttya not yet introduced.*

P. microphýlla Gaud. (*Don's Mill.*, 3. p. 836.), *Arbutus microphýlla* Forst., *A. serpyllifolia* Lam., is a native of the Straits of Magellan, where it grows to the height of 2 ft. or 3 ft., but has not yet been introduced.

P. Myrsinites G. Don (*Mill. Dict.*, 3. p. 836.), *Andrómeda Myrsinites* Lam., is a native of the Straits of Magellan, in woods on the mountains; where it grows to the height of 2 ft. or 3 ft.

App. ii. *Half-hardy Species of Pernéttya.*

P. empetrifolia Gaud (*Don's Mill.*, 3. p. 836.), *Arbutus empetrifolia* Lindl., *A. pùmila* Willd., *Andrómeda empetrifolia* Lam., is a much-branched, diffuse shrub, with lateral, solitary, drooping, white flowers, and leaves like those of *Empetrum*. It is a native of the Falkland Islands, where it grows to the height of 2 ft. or 3 ft., but has not yet been introduced.

P. pùmila Gaud. (*Bot. Reg.*, May, 1834), *Arbutus pùmila* Forst., is a native of Magellan, introduced in 1820, of which there were plants in the Horticultural Society's Garden.

P. Cavanillesiana G. Don (*Mill. Dict.*, 3. p. 837.), *Andrómeda prostrata* Cav., is a prostrate shrub, a native of South America, not yet introduced. *P. purpurca* D. Don is a native of Peru, with purple flowers; and *P. ciliàris* D. Don is a native of Mexico.

GENUS XVI.



GAULTHE'RIA L. THE GAULTHERIA. *Liv. Syst.* Decándria Monogýnia.

Identification. Lin. Gen., No. 551.; Schreb., 449.; Gærtn. Fruct., 63.; Juss. Gen., p. 161.; R. Br. Prod., p. 559.; H. B. et Kunth Nov. Gen. Amer., 3. p. 282.

Derivation. So named by Kalm, from *Gaulthier*, a physician and botanist of Canada.

Description. Procumbent, evergreen shrubs, natives of the colder parts of North and South America.

♁. I. G. PROCUMBENS L. The procumbent Gaultheria.

Identification. Lin. Sp., 565.; Don's Mill., 3. p. 839.; Lodd. Cat., ed 1836.

Synonymes. Partridge Berry, Mountain Tea, Spring Winter Green, *Smith's History of Nova Scotia.*

Engravings. Andr. Bot. Rep., 116.; Kalm Amœn., 3. p. 14. t. 1. f. 6.; Du Ham. Arb., 1. p. 286. t. 113.; Lodd. Bot. Cab., t. 82.; Sims Bot. Mag., t. 1896.; and our fig. 925.

Spec. Char., &c. Stem procumbent. Branches erect, naked at bottom, but with crowded leaves at top. Leaves obovate, acute at the base, finely and ciliate toothed. Flowers few, terminal, nutant. A little shrubby plant somewhat resembling seedling plants of *Kalmia latifolia*. Flowers white. Berries red, eatable, and known by the name of partridge berries. The leaves, if properly cured, make a most excellent tea; for which reason, it is likewise known by the name of mountain tea. It was introduced in 1762, grows 4 in. or 5 in. in height, and produces its small white flowers from July to September. The flowers are succeeded by red fruit, which, in British gardens, remain on the plant a great part of the winter. It is difficult to preserve alive, except in a peat soil kept moist. (*Don's Mill.*, iii. p. 837.) A native of North America, in dry woods, on mountains, and in sandy places, from Canada to Virginia.



925

2. *G. SHALLON* Pursh. The Shallon Gaultheria.

Identification. Pursh Fl. Amer. Sept., 1. p. 283.; Don's Mill., 3. p. 839.; Lodd. Cat., ed. 1836.

Engravings. Pursh Fl. Amer. Sept., 1. fig.; Hook. Bot. Mag., t. 2843.; Lindl. Bot. Reg., t. 1411.; Lodd. Bot. Cab., t. 1372.; and our fig. 926.

Spec. Char., &c. Procumbent, hairy on the stems. Leaves ovate, subcordate, serrated, glabrous on both surfaces. Racemes secund, bracteate, clothed with rusty down. Branches warted, clothed with rusty down when young. Leaves broad, abruptly acuminate. Pedicels scaly. Corolla white, tinged with red, downy, urceolate, with a closed limb. Berries globose, acute, fleshy, purple. This plant grows in the shade of close pine forests, where hardly any thing else will thrive, which makes it a very desirable shrub for plantations. The berries of the shallon are much esteemed by the natives, on account of their agreeable flavour. (*Don's Mill.*, iii. p. 837.) It was introduced in 1826, and is a native of North America, on the Falls of the Columbia, and near the Western Ocean. In British gardens, this plant is as hardy as if it were indigenous. It grows to the height of 2 ft. or 3 ft. in sandy peat, or even in sandy loam, in 3 or 4 years producing abundance of fruit, which forms excellent food for partridges, and may be used in tarts. In the North of England, and in Scotland, it has already been planted as undergrowth in artificial plantations, and in belts, clumps, and thickets in parks, for the sake of the shelter and food which it affords for game. It thrives in the immediate vicinity of London, growing luxuriantly in the Hackney arboretum.



926

App. i. *Half-hardy Species of Gaultheria*

G. fragrantissima Wall. (*Don's Mill.*, 3. 840.), *G. fragrans* D. Don, *A. rbutus laurifolia* Humil., is an evergreen shrub, a native of Nepal, at Narainhetty; with leaves coriaceous, reticulately veined; from 2 m. to 4 in. long; with corollas oblong, silky, pale red, and very sweet-scented. It was introduced in 1824, but we have not seen a plant.

App. ii. *Hardy and half-hardy Species of Gaultheria, not yet introduced.*

G. nummularioides D. Don Prod. Fl. Nep., p. 150., *Don's Mill.*, 3. p. 839., is a native of the alps of Nepal, where it forms a much-branched procumbent shrub, with filiform branches, cordate leaves, and small flowers, on very short axillary pedicels.

G. ciliata Cham. et Schlecht. in Linnæa, 5. p. 126., *Don's Mill.*, 3. p. 839., is a glabrous shrub, with coriaceous lanceolate leaves, sharply serrated; a native of Mexico, on Mount Orizaba, along with *Solanum tuberosum*. The leaves are half an inch long, the flowers white, and the berries black.

Several other species are described in *Don's Miller*, as natives of different parts of South America and Nepal; and as requiring the green-house or stove.

GENUS XVII.



EPIGÆA L. THE EPIGÆA. *Lin. Syst.* Decándria Monogýnia.

Identification. *Lin. Gen.*, No. 550.; *Schreb. Gen.*, No. 240.; *Nutt. Gen. Amer.*, 1. p. 269.; *Don's Mill.*, 3. p. 841.

Synonymes. *Memécylum Mich. Gen.*, 13.; *May Flower, Nova Scotia.*

Derivation. From *epi*, upon, and *gaia*, the earth; the plant creeps upon the surface of the earth.

Description. Creeping, tufted, evergreen shrubs, with fragrant flowers in dense, axillary, and terminal racemes; natives of North America.

♣ I. E. RE'PENS L. The creeping Epigæa.

Identification. Lin. Sp., 565.; Don's Mill., 3. p. 841.; Lodd. Cat., ed. 1836.

Engravings. Andr. Bot. Rep., 102.; Lam. Ill., t. 367. f. 1.; Lodd. Bot. Cab., 160.; Pluk. Alm., t. 107. f. 1.

Spec. Char., &c. Branches, petioles, and nerves of leaves very hairy. Leaves cordate-ovate, quite entire. Corollas cylindrical. Flowers white, tinged with red, very fragrant. (*Don's Mill.*, iii. p. 841.) It is a native from Nova Scotia to Carolina, on shady rocks and in stony woods, on the sides of hills, and at the roots of pines; where it forms a creeping shrub, flowering from May to July. It was introduced in 1736; and succeeds in peat soil, kept rather moist, and protected with a frame or hand-glass, or with snow, during very severe frosts.

GENUS XVIII.



PHALEROCA'RPUS G. Don. THE PHALEROCA'RPUS. Lin. Syst. Octándria Monogýnia.

Identification. Don's Mill., 3. p. 341.

Synonymes. *Vaccinium hispidulum* Lin.; *Gaulthèria* Pursh; *Oxycoccus* Nutt.; *Arbutus* Lam.

Derivation. From *phaleros*, white, and *karpos*, a fruit; in reference to the colour of the berries.

Description. A small creeping plant, with hispid branches; small, roundish-oval, acute leaves; and axillary, solitary, nearly sessile, ? white flowers; and the habit of wild thyme.

♣ I. P. SERPYLLIFO'LIA G. Don. The Wild-Thyme-leaved Phaleroarpus.

Identification. Don's Mill., 3. p. 841.

Synonymes. *Vaccinium hispidulum* Lin. Sp., 500., *Michx. Fl. Bor. Amer.*, 1. p. 228. t. 23., *Lodd. Cat.*, ed. 1836.; *Gaulthèria serpyllifolia* Pursh *Fl. Amer. Sept.*, 1. p. 283. t. 13.; *Arbutus filifórmis* Lam. *Dict.*, 1. p. 228.; *Oxycoccus hispidulus* Pers.

Engravings. *Michx. Fl. Bor. Amer.*, 1. t. 23.; Pursh *Fl. Amer. Sept.*, t. 13.

Spec. Char., &c. Berries white, produced in considerable quantities, aromatic, not very acid, and rather insipid than agreeable. The shrub has the same aromatic taste and smell as *Gaulthèria procumbens*. (*Don's Mill.*, iii. p. 841.) It is a native from Canada to Pennsylvania; and Nuttall has observed it north-westward of Lake Michigan; and Pursh remarks that it abounds more particularly where cedars and other evergreens are predominant; keeping pretty constant pace with the northern forests of pines, larches, and firs; and growing always amidst Sphágnum. It is a creeping shrub, flowering in April and May. It was introduced in 1815, and, in British gardens, it is cultivated in moist peat, in an open airy situation.

GENUS XIX.



CLE'THRA L. THE CLE'THRA. Lin. Syst. Decándria Monogýnia.

Identification. Lin. Gen., No. 553.; Schreb. Gen., 751.; Gartn. Fruct., 1. p. 301. t. 63.; Juss. Gen., 160.; Gron., 43.; Nutt. Gen., 1. p. 275.; H. B. et Kunth Nov. Gen. Amer., 3. p. 288.; Don's Mill., 3. p. 841.

Synonymie. *Cuellària* Ruiz et Pav. Syst., 105.

Derivation. From *klèthra*, the Greek name of the alder; alluding to a supposed resemblance in the leaves.

Description. Deciduous shrubs, with alternate leaves, and terminal, solitary, or paniced racemes of white, bracteated flowers. From the appearance of the plants in British gardens, we are strongly inclined to think that all the sorts may be referred to one species.

♣ 1. *C. ALNIFOLIA* L. The Alder-leaved Clethra.

Identification. Lin. Sp., 566; Don's Mill., 3. p. 841; Pursh Fl. Amer. Sept., 1. p. 301; Lodd. Cat., ed. 1836.

Synonyme. *C. alnifolia* var. *α* *denudata* Ait. Hort. Kew., 2. p. 73.

Engravings. Schmidt Baum., t. 47; Lam. Ill., 369; Du Ham. Arb., 1. p. 176. t. 71; Mill. Icon., 28; Catesb. Car., 1. t. 66; and our fig. 927.

Spec. Char., &c. Leaves cuneate-obovate, acute, coarsely serrated above, glabrous on both surfaces, and of the same colour. Racemes spicate, simple, bracteate, clothed with hairy tomentum. (*Don's Mill.*, iii. p. 841.) It is a native of North America, from New England to Virginia, in swamps; where it forms a shrub growing from 3 ft. to 4 ft. high, and producing its white flowers from July to September. It was introduced in 1731; and is frequent in British gardens, among other peat-earth shrubs, where it is valued for its flowers.



♣ 2. *C. (A.) TOMENTOSA* Lam. The downy Clethra.

Identification. Lam. Dict., 2. p. 46; Don's Mill., 3. p. 842; Pursh Fl. Amer. Sept., 1. p. 301.

Synonymes. *C. alnifolia* β *pubescens* Ait. Hort. Kew., 2. p. 73; *C. incana* Pers. Ench., 1. p. 482.

Engravings. Wats. Dend. Brit., t. 39; and our figs. 928, 929.

Spec. Char., &c. Leaves cuneate-obovate, acute, finely serrated at top, clothed with white tomentum beneath. Racemes spicate, simple, bracteate, villously tomentose. This is a very distinct species, although it has been considered by some as a mere variety of the preceding. (*Don's Mill.*, iii. p. 842.) It is a native of North America, in Virginia and Carolina, in swamps; where it forms a shrub growing from 3 ft. to 4 ft. high, and flowering from July to October. It was introduced in 1731, and is frequent in collections.



♣ 3. *C. (A.) PANICULATA* Ait. The panicle-flowered Clethra.

Identification. Ait. Hort. Kew., 2. p. 73; Don's Mill., 3. p. 842; Pursh Fl. Amer. Sept., 1. p. 302.

Spec. Char., &c. Leaves narrow, cuneate-lanceolate, acute, acuminately serrated, glabrous on both surfaces. Panicle terminal, elongated, composed of racemes, and clothed with white tomentum. (*Don's Mill.*, iii. p. 842.) It is a native of Carolina, where it is a shrub growing 3 ft. or 4 ft. high, and flowering from July to October. Said to have been introduced in 1770; but the plants which bear this name in British gardens appear to be nothing more than *C. alnifolia*.

♣ 4. *C. (A.) ACUMINATA* Michx. The acuminate-leaved Clethra.

Identification. Michx. Fl. Amer. Bor., 1. p. 260; Don's Mill., 3. p. 842; Pursh Fl. Amer. Sept., 1. p. 302; Lodd. Bot. Cab., t. 1427; Lodd. Cat., ed. 1836.

Synonyme. *C. montana* Bartr. Cat. Engraving. Lodd. Bot. Cab., t. 1427.

Spec. Char., &c. Leaves oval, acuminate, bluntish at the base, serrated, glabrous on both surfaces, rather glaucous beneath. Racemes spicate, almost solitary, bracteate, clothed with white tomentum. Flowers resembling those of *C. alnifolia*. (*Don's Mill.*, iii. p. 842.) It is a native of Carolina, on the high mountains; where it forms a large shrub, or low tree, growing from 10 ft. to 15 ft. high, and flowering from July to October. It was introduced in 1806, and is frequent in collections.

♣ 5. *C. (A.) SCA'BRA* Pers. The rough-leaved Clethra.

Identification. Pers. Ench., 1. p. 482; Don's Mill., 3. p. 842; Pursh Fl. Amer. Sept., 1. p. 302.

Spec. Char., &c. Leaves broad, cuneate-obovate, acute, scabrous on both surfaces, coarsely serrated; serratures hooked. Racemes spicate, sub-panicled, bracteated, finely tomentose. (*Don's Mill.*, iii p. 842.) A native of the western parts of Georgia, where it was collected by Mr. Lyon, and by him introduced into Britain in 1806. It is a shrub, growing to the height of 3 ft. or 4 ft., and flowering from July to October.

App. i. *Half-hardy Species of Clèthra.*

C. arborea Ait. (*Bot. Mag.*, t. 1057.; and our fig. 931.) is a well-known green-house tree-like shrub, and is by far the handsomest species of the genus. It is a native of Madeira, with oblong, attenuated, lanceolate, serrated leaves, glabrous on both surfaces; and spike-formed racemes of white flowers, resembling those of the lily of the valley. It was introduced in 1784; grows from 8 ft. to 10 ft. high, in pots, and still higher when planted in the bed of a conservatory; and flowers from August to October. It thrives best in a sandy peat; and, if planted against a conservative wall, and sufficiently protected during winter, it would thrive in favourable situations; although plants flowering so late in the season are not the most desirable for such a purpose, for obvious reasons. A plant in the Kilkenny Nursery has stood against a south wall for several years, and Mr. Robertson is of opinion, that, in that part of Ireland, it will ultimately prove as hardy as the *O'lea ex-celsa*, which lives through the winter there as a standard. There is a variety of this with the leaves variegated, which is found in some collections.

C. ferruginea Ruiz et Pav. Fl. Per., 4. t. 380. fig. b, is a native of Peru, on mountains, where it grows to the height of 15 ft. It was introduced in 1800, and is probably as hardy as *Clèthra arborea*.

C. tinifolia Swartz; *Tinus occidentalis* L., *Brown's Jam.*, 214. t. 21. fig. 1.; is a native of the south of Jamaica, and also of Mexico, where it grows to the height of 14 ft. It was introduced in 1825. *C. mexicana* Lodd. *Cat.*, ed. 1836, appears to be this species.

Other species of Clèthra, requiring a green-house, are described in *Don's Miller*; but they have not yet been introduced.



App. I. *Half-hardy Genera belonging to the Section Ericææ and § Andromèdeæ of the Order Ericææ.*

Agarista 'a mythological name, in commemoration of the beautiful daughter of Clisthenes; in reference to the beauty of the flowers) *D. Don*. (*G. Don's Mill.*, 3. p. 837.) This genus is composed of evergreen shrubs, natives of the Mauritius and South America, which were formerly included under *Andrómèda*. Only one species is introduced, and that is an inhabitant of the green-house.

A. buxifolia G. Don; *Andrómèda buxifolia* Lam., *Bot. Mag.*, t. 2660., *Bot. Cab.*, t. 1494.; is a native of the Island of Bourbon, introduced in 1822, and producing its pink flowers in June and July. It forms a fine evergreen shrub for a conservatory, where it grows to the height of 6 ft. or 7 ft., and would, probably, live against a conservative wall, with sufficient protection.

Sect. II. RHODOREÆ.

The *Rhodoreæ* include genera of some of the most singularly ornamental evergreen and deciduous peat-earth shrubs that adorn our gardens; for what would our American ground be without the genera *Rhododéndron* and *Azàlea*? Our conservatories would suffer equally without the Indian and Chinese species of these families. "Of all the genera in existence," *G. Don* observes, "*Rhododéndron*" (under which he includes the *Azàlea*) "comprises the most handsome, elegant, and showy shrubs for adorning shrubberies or planting singly on lawns." Though, in Britain, these plants are solely cultivated as ornamental, yet, in their native countries, they are not without their other uses. "The *Rhodoreæ*," *Mr. Royle* observes, "abound in stimulant, and even deleterious, properties. Thus *Rhododéndron pònticum*, *R. máximum*, *R. ferrugíneum*, and *R. chrysánthum* are poisonous to cattle which feed on them; and yet, in moderate doses, are used in medicine, for the cure of rheumatism, &c. *Azàlea procúbens* L. and *Lèdum palústre* are accounted diuretic; and *L. latifólium*, being more stimulant, is used as a tea, under the name of Labrador tea, but determines to the head. *Kálmia latifólia* is accounted poisonous, and honey collected by bees from its flowers is of a deleterious nature; as is that of *A. pòntica*, which was so injurious to the soldiers in the Retreat of the Ten Thousand. In the Himalayan species, *Rhododéndron arbóreum* is more remarkable for its uses as a timber tree than the other species.

The flowers are eaten by the hill people, and formed into a jelly by European visitors. The leaves of *R. campanulatum*, being used as a snuff by the natives of India, are imported from Cashmere, under the names of hoolas-kasmeerec (Cashmere snuff) and burg-i-tibbut (Thibet leaf), though easily procurable within the British territories. It is remarkable that De Candolle mentions the employment in the United States, for a similar purpose, of the brown dust which adheres to the petioles of kalmias and rhododendrons. The leaves of *R. lepidotum* (a species not yet introduced into Europe) are highly fragrant, and of a stimulant nature." (*Illust.*, p. 219.) The culture of all the species is nearly the same: they all require peat earth, or, at least, thrive best in it; and some of them will not live without it. They may all be propagated by cuttings of the growing shoots, planted in fine sand, and covered with a glass, or by layers; but the best plants of all the species are procured from seed. The varieties can, of course, only be continued by cuttings or layers; and the stools for these require to be planted in beds of peat, which should be kept tolerably moist. The seeds, if ripened in this country, should be sown soon after gathering; and those imported from America, immediately on being received; because, though the seeds of all the *Ericacæ* will retain the vital principle for several years (see p. 1100.), yet the longer they are kept out of the soil, the less likely they are to germinate, and the greater will be the risk of losing some of them. They should be sown in pots or boxes, or in a border shaded from the direct influence of the sun; and kept in a uniform state of moisture, and protected from the frost. In sowing, the surface of the soil should previously be made quite smooth, and gently pressed down, or watered till it has settled to a level surface; and, after the seeds have been equally distributed over this surface, they should be covered with no more soil than is barely requisite to conceal them from the eye. Seeds sown in autumn will germinate in the following spring, and be fit for transplanting into nursery lines or pots by the autumn, or by the spring of the following year. These directions will apply generally to all the species, but are more particularly applicable to those which are perfectly hardy. The culture of the half-hardy sorts will be noticed after describing them.

GENUS XX.



RHODODE'NDRON L. THE RHODODENDRON, or ROSE BAY. *Lin. Syst.* Penta-Decándria Monogýnia.

Identification. *Lin. Gen.*, No. 548; *Schreb. Gen.*, No. 746; *Gærtn. Fruct.*, 1. p. 304. t. 63; *Juss. Gen.*, 158; *D. Don* in *Edinb. Phil. Journ.*; *Prod. Fl. Nep.*, p. 152; *Don's Mill.*, 3. p. 843.

Synonymes. *Azàlea* sp. of authors; *Rhodbra* *Lin.*; *Chamarhododéndros* *Tourn. Inst.*, t. 373; *Rhododendron*, *Fr.*, *Ital.*, and *Span.*; *Alybalsam*, *Ger.*

Derivation. From *rhodon*, a rose, and *dendron*, a tree; in reference to the terminal bunches of flowers, which are usually red, or rose-colour.

Description, &c. Shrubs or trees, usually evergreen, but in the *Azàlea* division almost entirely deciduous, with quite entire alternate leaves, terminated by a withered tip, or yellow gland; and terminal, corymbose, showy flowers. Cultivated in sandy peat, kept rather moist, and propagated by layers, seeds, or cuttings. Under this genus Professor D. Don has included the *Azàlea*, which, however technically correct, appears to us injudicious in a practical point of view; and, though we have followed his arrangement in this article, yet we have indicated two sections, containing the Indian or tender, and the Asiatic and American or hardy, azaleas, which those who cultivate extensive collections of these shrubs may, if they choose, consider as constituting the genus *Azàlea* as heretofore. Such persons, therefore, may view the genus *Azàlea* as remaining exactly as it is in our *Hortus Britannicus*.

§ i. *Pónticum* D. Don.

Sect. Char. Limb of calyx short, 5-lobed. Corolla campanulate. Stamens 10. Ovarium 5-celled. Leaves coriaceous, evergreen. (*Don's Mill.*, iii. p. 843.)

■ 1. *R. PÓNTICUM* L. The Pontic Rhododendron, or Rose Bay.

Identification. Lin. Sp., 562; Don's Mill., 3. p. 843.; Lodd. Cat., ed. 1836.

Engravings. Pall. Fl. Ross., 1. p. 43. t. 29.; Jacq. Icon. Rar., 1. t. 78.; Lam. Ill., t. 364.; Bot. Mag., t. 650.; and our fig. 931.

Spec. Char., &c. Leaves oblong-lanceolate, glabrous on both surfaces, attenuated towards the thick petioles, with a streak on the upper surface, of a wide lanceolate form. Racemes short, corymbose. Leaves sometimes becoming ferruginous beneath. Corolla purple, or purplish pink, large; with ovate, acute, or lanceolate segments. Calyx minute, 5-toothed, somewhat cartilaginous. (*Don's Mill.*, iii. p. 843.) An evergreen shrub; a native of Pontus (now Armenia), in Asia Minor, where it grows to the height of 10 ft. or 12 ft.; flowering in May and June. It was introduced in 1763, and is frequent in British gardens.



Varieties.

- *R. p. 2 obtusum* Wats. Dend. Brit., t. 162., Don's Mill., iii. p. 843., has the leaves subcordate, coriaceous, obtuse, and the calyx very short, and unequally and undulately crenated. It grows from 3 ft. to 4 ft. high, and has purple flowers. Found wild in Armenia.
- *R. p. 3 myrtifolium* Lodd. Bot. Cab., t. 908., Don's Mill., iii. p. 843., has the leaves small, and the flowers purple. It is a native of Gibraltar.
- *R. p. 4 Smithii* Swt. Brit. Fl.-Gard., n. s., t. 50., Don's Mill., iii. p. 843., has the leaves lanceolate, and clothed with white tomentum beneath; corymbs many-flowered; ovarium tomentose, and 10-celled. The flowers are of a rosy purple, approaching to crimson, elegantly spotted with black. A hybrid, raised by Mr. Smith, at Coombe Wood, from the seed of *R. pónticum*, impregnated by the pollen of *R. arboreum*.
- *R. p. 5 Lowii* Gard. Mag., vol. xi. p. 190. Corolla white; the upper segments marked by a few dull scarlet spots. This is a most striking variety, originated by M. Jacob Makoy. It is named after Mr. Low of Clapton.
- ✧ ■ *R. p. 6 azaleoides*; *R. azaleoides* Desf.; *R. p. β subdeciduum* Andr. Bot. Rep., t. 379., Hayn. Abbild., t. 15.; is a hybrid between *R. pónticum* and some species of *Azalea*, with fragrant blossoms. It was originated about 1820, and is a favourite in collections. There is a subvariety, *R. p. α. 2 odoratum* Lodd. Cat., in which the flowers are supposed to be more odoriferous than in *R. p. azaleoides*.

Nursery Varieties. The following are cultivated by Messrs. Loddiges. (*Catalogue of Plants, &c., at Hackney, 16th ed., 1836.*)

<p><i>R. p. álbum.</i> angustifolium. angustissimum. arbutifolium. bromelæefolium bullatum. cassinæfolium. cæruleascens. contortum. crispum.</p>	<p><i>R. p. fl. pléno.</i> fol. argenteis. fol. aureis. fol. marginatis. frondosum. grandiflorum. incarnatum. intermedium. kalmiæfolium.</p>	<p><i>R. p. macrophyllum.</i> nivaticum. obtusum. ovatum. pygmaeum. roseum. salicifolium. spectabile. violaceum.</p>
--	--	--

Description. The *Rhododéndron pónticum* is the commonest species of the genus in British gardens, where it grows to the height of from 5 ft. to 15 ft., or upwards; forming a dense bush, which will spread over a large

space, if it be allowed abundance of room. The branches are round, with a rather testaceous bark, marked by scars. The leaves are long, coriaceous, quite entire, smooth and shining above, and somewhat ferruginous beneath. The flower buds are large and terminal, and the corollas of a fine purple. The seeds are small, and of irregular shape, like minute sawdust. In proper soil, if kept moist, the plant will make shoots, when young, of 1 ft. or more in length in a season, attaining the height of 4 ft. or 5 ft. in 5 or 6 years: but afterwards it grows more slowly; and, when a large bush, seldom makes shoots above 6 in. in length. It appears to be of considerable durability.

Geography. The *Rhododendron ponticum* is a native of the Levant, in various places; of Georgia, Caucasus, and the Himalayas, and various other parts of Asia; but not of North America, unless *R. purpureum* and *R. catawbiense* be varieties of this species, which may very possibly be the case. According to Pallas, this shrub is found nowhere in Russia, except in the southern calcareous district of Caucasus, where it grows in humid situations, along with the beech and the alder. Like all hair-rooted plants, it is generally found, in a wild state, in soft or minutely divided soil, but not always in soil analogous to our peat. It is often found on clayey loam, but it is only when this is kept moist, by being in a shady situation. On mountains, it never ascends so high as to approach the line of perpetual snow.

History. The rhododendron was well known to the Greeks, both by that name, and by the name of rhododaphne, or the rose laurel. The Romans also were acquainted with this shrub; but, as Pliny observes, they had not the good fortune to give a name to it; for it was in ancient Italy, as it is at present throughout Europe, known principally by its original Greek name. The ancients were well acquainted with the poisonous qualities of the flowers of the rhododendron and azalea, both of which are abundant in Pontus; and the flowers had such an influence on the honey of the country, that the Romans would not receive it in tribute, but obliged the inhabitants of that part of Pontus to pay them a double portion of wax in lieu of it. Both the rhododendron and the azalea were abundant in the neighbourhood of Trebisond, in the time of Xenophon, and they still are so. Xenophon reports that, when the army of 10,000 Greeks, in their celebrated retreat, approached that city, his soldiers, having eaten the honey which they found in the environs, were seized with a violent vomiting and purging, followed by a species of delirium, so severe, that those least affected resembled drunken persons, and the others madmen. The ground was strewed about with the bodies of the soldiers, as it is after a battle. Nobody died, however, and the malady disappeared 24 hours after it had commenced, leaving only a sensation of great weakness. Turner, in his *Herbal*, must have had this story in view, when, in 1568, he wrote the following passage: — “I have sene thys tre (the rhododaphne) in diverse places of Italy; but I care not if it neuer com into England, seyng it in all poyntes is lyke a Pharesy; that is, beauteus without, and within a rauenus wolf and murderer.” It is possible, however, that Dr. Turner may have referred to the oleander, to which, as appears by Gerard (edit. 1636, p. 1406.), the names of rhododendron, rhododaphne, nerium, and oleander were at that time applied. The poisonous properties of the flowers of the *R. ponticum* are denied by Gùldenstadt, and also by Pallas; both these authors asserting that it was the honey from the flowers of *Azàlea pontica* (which grows plentifully among the bushes of the *R. ponticum*) that produced the deleterious effect on Xenophon’s soldiers; it having been found, in modern times, that honey made from the flowers of this shrub, taken in large quantities, is highly deleterious. *R. ponticum* (as we have seen, p. 83.) was first introduced by Conrad Loddiges, in 1763; and it has since spread through the country with such an extraordinary degree of rapidity; that there is now scarcely a shrubbery or pleasure-ground in Britain without it.

Properties and Uses. In its native country, we are not aware that this plant is applied to any use, except that to which all woody plants are applicable; viz. of being cut down for fuel. In Britain, it is planted as an

ornamental shrub, not only in open situations, but, on a large scale, in woods, to serve as undergrowth, and as a shelter for game. Professor Henslow, in a communication to the *Magazine of Natural History*, vol. ix. p. 476., mentions that he had seen some crystals of a substance resembling sugarcandy, which were found in the decaying flowers of the *R. pόνticum*. The syrup, which afterwards hardened into these crystals, always exuded "from the upper surface of the thickened base upon which the ovary is seated, and apparently from a minute glandular spot placed between the sinus formed by the two upper teeth of the calyx." The plant was in a morbid state, and the crystals were found more particularly within some of the flowers that had withered without fully expanding. In the *Bulletin Universel*, *R. pόνticum* is stated to contain some grains of common sugar, of a pure white colour, on the surface of the upper division of the corolla.

Soil, Situation, &c. It will grow in almost any soil; but, in England, it seems to thrive best in sandy peat, or deep sandy loam. In the common manured earth of gardens it succeeds worse than in unmanured loams of a close texture, even strong clays, particularly if the latter be kept moist. The want of tenacity of the manured garden soil alluded to, more especially in a dry season, seems not to allow it to cohere sufficiently to the small hair-like roots of this order of plants, to enable their very minute spongioles to imbibe nourishment from it.

Propagation. All the rhododendrons may be propagated by cuttings of the young shoots, taken off in a growing state, when their lower ends have begun to ripen, and planted in pure sand, and covered with a bell-glass; but, in general, this mode is only worth adopting in the case of new and rare sorts. By layers, also, is a common mode with sorts which do not seed freely, or with particular varieties: but by far the most general method practised in gardens is by seeds. These are produced in abundance in this country; and they are also received from America. They are ripe in August and September; and, though they will retain their vegetative properties for upwards of a year, and some of them for several years, it is considered safest to sow them soon after they are gathered. The seeds should be sown in peat soil, or very fine sandy loam, in a shady border, or in pots; and treated as recommended at the head of this section.

Culture. After seedling plants have been a year in pots, or in the seed-bed, they are transplanted into nursery lines, and removed every year, or every second year, and placed at greater distances, till they have attained the size at which it is considered desirable to sell them, or to plant them where they are finally to remain. At whatever age or size they are removed from the nursery, they require, in common with all hair-rooted plants, to have a small ball of soil attached to their roots, and to have these carefully protected from drought by mats. In consequence of almost all the rhododendrons and azaleas being removable with balls, they may be transplanted at any season of the year, though the autumn and spring are the periods generally made choice of. In consequence, also, of peat soil readily adhering to the fibrils of this genus, and, indeed, of all the Ericæcæ, it becomes less necessary to grow them in pots for the convenience of removal, than is the case with most other rare and valuable trees and shrubs: for example, the *Magnoliæcæ*. In some of the English nurseries, plants of *Rhododéndron pόνticum* are trained with single stems, to the height of 4 ft. or 5 ft., before they are suffered to branch off; and, so treated, they make very handsome small trees.

Statistics. In the environs of London, some of the largest rhododendrons are in the arboretum at Kew, where they are nearly 12 ft. high. In the woods at Kenwood, there are also several of this height. At Wimbledon House, there is a bush, which, in 1834, was 33 ft. in diameter. In Hampshire, at Cuffnells, there is one which, in 1834, was 15 ft. high, and the branches covered a space 39 ft. in diameter. In Bedfordshire, at Woburn Abbey, in dry sand, without any bog or other artificial soil, a plant, 20 years planted, in 1835 formed a bush 28 ft. in diameter. In Derbyshire, at Shipley Hall, there is a *Rhododéndron pόνticum*, which, in 1835, was 16 ft. high, the branches of which cover a space 56 ft. in diameter. In Scotland, at Minard, in Argyllshire, there is a plant 8 ft. high, which covers a space 20 ft. in circumference. In Ireland, at Oriel Temple, near Dublin, one, 60 years planted, was, in 1834, 16 ft. high, and covered a space 38 ft. in diameter. At Morn Park, near Cork, there is a plant which, in 10 years, is 9½ ft. high, and the space covered by the branches is 92 ft. 6 in. in diameter. At Castle Freke, in the same county, there is one about the same size.

Commercial Statistics. The price of plants of the species, in the London nurseries, is from 1*l.* 5*s.* to 5*l.* per hundred; and of the varieties, from 1*s.* 6*d.* to 5*s.* each; and seeds are 2*s.* per ounce. At Bollwyller, 2 years' seedlings are 25 francs per hundred, and the varieties from 1 franc to 2 francs each. At New York, plants of the species are 1 dollar each, and of the varieties 2 dollars.

■ 2. *R. MA'XIMUM* L. The largest Rhododendron, or *American Rose Bay*.

Identification. Lin. Sp. Pl., p. 563; Don's Mill., 3. p. 843; Lodd. Cat., ed. 1836.

Engravings. Bot. Mag., t. 951; Lam. Ill., 364; Schmidt Baum., t. 121; Mill. Icon., 229; Catesb. Car., 3. t. 17. f. 2; and our fig. 932

Spec. Char., &c. Arborecent. Leaves elliptic-oblong, acute, convex, bluish at the base, whitish or rusty beneath, glabrous. Calycine segments oval-obtuse. Segments of corolla roundish. Flowers pale red, in umbellate corymbs, studded with green, yellow, or purple protuberances. (*Don's Mill.*, iii. p. 843.) A native of North America, from Canada to Carolina, on the mountains, near rivulets and lakes, upon rocks and barren soils, where it continues flowering a great part of the summer; and where it forms a shrub growing to the height of from 10 ft. to 15 ft., flowering from June to August. Introduced in 1736, and frequent in collections. This species is not nearly so easy of culture as *R. ponticum*, and neither grows nor flowers so freely in British gardens. Though introduced by Peter Collinson in 1736, it did not flower in England till 1756, as Miller informs us; who adds, that the only person who then succeeded in raising it was Mr. James Gordon, at Mile End. The culture, &c., are the same as for *R. ponticum*. Plants of this species, in the London nurseries, are 1*s.* each, and seeds 3*s.* 6*d.* per oz.; at Bollwyller plants are 4 and 5 francs each; and at New York, from 50 cents to 1 dollar, and of the white variety 2 dollars.



932

Though introduced by Peter Collinson in 1736, it did not flower in England till 1756, as Miller informs us; who adds, that the only person who then succeeded in raising it was Mr. James Gordon, at Mile End. The culture, &c., are the same as for *R. ponticum*. Plants of this species, in the London nurseries, are 1*s.* each, and seeds 3*s.* 6*d.* per oz.; at Bollwyller plants are 4 and 5 francs each; and at New York, from 50 cents to 1 dollar, and of the white variety 2 dollars.

Varieties.

- *R. m.* 2 *album* Hort. has pure white flowers, and is comparatively rare in British gardens.
- *R. m.* 3 *hybridum* Hook. Bot. Mag., t. 3454; *R. fragrans* Hort.; *R. hybridum* Lodd. Cat.; is supposed to be a hybrid originated by fertilising the common white glaucous-leaved Azalea with the pollen of *R. maximum*. This variety has fragrant flowers, and, according to Sir W. J. Hooker, is "amply worthy of a place in every garden and shrubbery."

■ † 3. *R. (M.) PURPU'REUM* G. Don. The purple-flowered Rhododendron, or *American Rose Bay*.

Identification. Don's Mill., 3. p. 843.

Synonymes. *R. maximum* γ *purpureum* Pursh *Fl. Amer. Sept.*, 1. p. 297; *R. ponticum macrophyllum* Lodd. Cat.

Spec. Char., &c. Arboreous. Leaves large, oblong-elliptic, flattish, acute, bluish at the base, green, and glabrous on both surfaces. Segments of corolla oblong and obtuse. Flowers large, purple. Calycine segments obtuse. This shrub approaches near to *R. ponticum*; but it differs in its foliaceous calyx, and otherwise. It grows to an immense size; its stem being often found 18 in. and more in diameter; and its foliage triple the size of that of any other species. (*Don's Mill.*, iii. p. 843.) It is a native of Virginia and Carolina, on the highest mountains, near lakes; where it forms a large shrub, or tree, growing to the height of 25 ft., flowering in May and June. This species appears to be in cultivation in some British nurseries, under the name of *R. arboreum americanum*; but in Messrs. Loddiges's

arboretum it is named *R. pόνticum macrophyllum*. The year of its introduction into British gardens is uncertain; nor has it been much cultivated.

■ 4. *R. Pu'RSII* G. Don. Pursh's Rhododendron, or American Rose Bay.

Identification. Don's Mill., 3. p. 843.

Synonymæ. *R. maximum* β *album* Pursh Fl. Amer. Sept., 1. p. 297.

Spec. Char., &c. Arboresecent. Leaves cuneate-lanceolate, flat, glabrous, tapering gradually to the base, paler beneath. Calycine segments oval, obtuse. Segments of corolla roundish-oblong. Flowers white, and smaller than those of *R. maximum*. (*Don's Mill.*, iii. p. 843.) A native of New Jersey and Delaware, in shady cedar swamps; where it forms a shrub growing from 6 ft. to 8 ft. high, flowering from June to August. It was introduced in 1811, but is not common in collections.

■ 5. *R. CATAWBI'ENSE* Michx. The Catawba Rhododendron.

Identification. Michx. Fl. Bor. Amer., 1. p. 258; Don's Mill., 3. p. 843. Lodd. Cat., ed. 1836.

Engravings. Bot. Mag., t. 1671; Lodd. Bot. Cab., t. 1176; and our fig. 933.

Spec. Char., &c. Leaves short-oval, rounded, and obtuse at both ends, glabrous, of a different colour beneath. Calycine segments elongated oblong.

Flowers purple, disposed in umbellate corymbs. (*Don's Mill.*, iii. p. 843.)

It is a native of the high mountains of Virginia and Carolina, particularly near the head waters of the Catawba River, where it is a shrub, about 4 ft. high, flowering from June till August. Introduced in 1809, and now one of the most common species in gardens. It is of more robust growth than either *R. pόνticum* or *R. maximum*, but, in other respects, seems intermediate between them. There are many hybrids in cultivation between it and the former species, though without names; partly from the minuteness of the shades of distinction between them, and partly from their having been raised by nurserymen who had not sufficient influence or energy to bring them under the notice of botanists. There are some very distinct varieties in the Knaphill Nursery. Plants vary in price from 1s. to 5s.

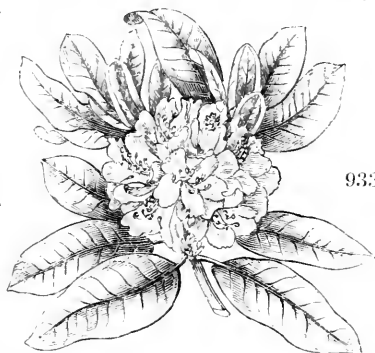

933

Plants vary in price from 1s. to 5s.

Varieties.

■ *R. c. 2 Russellianum* Brit. Fl.-Gard, 2d s., t. 91., *Don's Mill.*, iii. p. 843.—Leaves oblong, finely tomentose beneath. Corymbs many-flowered. Flowers of a bright rosy red, approaching to crimson. A hybrid raised from the seed of *R. catawbiense*, impregnated by the pollen of *R. arboreum*, by Mr. Russell of Battersea. It is a very splendid variety, but somewhat tender.

■ *R. c. 3 tigrinum* Hort. is a variety with a corolla much resembling that of *R. c. Russellianum*, but with obvious spots on the inside.

■ *R. c. 3 tigrinum* Hort. is a variety with a corolla much resembling that of *R. c. Russellianum*, but with obvious spots on the inside.

■ 6. *R. CHRYSANTHUM* L. The golden-flowered Rhododendron.

Identification. Lin. Syst., 405, Suppl., 237; Don's Mill., 3. p. 843; Lodd. Cat., ed. 1836.

Synonymæ. *R. officinale* Salisb., p. 121. t. 54.

Engravings. Pall. Itin. Append., p. 729. No. 87. t. n. f. 1—2; Fl. Ross., 1. p. 44. t. 20; Woodv. Med Bot., 433. t. 149; Salisb. Par. Lond., t. 80; Gmel. Sib., 4. t. 54.

Spec. Char., &c. Leaves acutish, attenuated at the base, oblong, glabrous, reticulately veined, and of a rusty colour beneath. Flowers and buds clothed with rusty tomentum. Pedicels hairy. Calyx hardly any. Segments of the corolla rounded. Ovarium tomentose. Branches decumbent, beset with rusty stipula-formed scales. Flowers handsome, large, drooping, revolute, rather irregular, yellow. Stigma 5-lobed. (*Don's Mill.*, iii. p. 844.) It is a native of Siberia, on the highest mountains; and of Caucasus, where it forms a low evergreen undershrub, growing from

6 in. to 1 ft. in height, and flowering in June and July. Pallas found it in Kamtschatka, growing in the hollows at the foot of mountains, and by the margins of stagnant pools. It is indigenous through the whole of Siberia, from Lake Baical to the river Lena; thriving equally on the tops of mountains covered with snow, and in the peat bogs of the valley. It was introduced in 1796, but is not common in collections, being very difficult to keep. The best plants, in the neighbourhood of London, are at the Knaphill Nursery, Woking, Surrey. This shrub has a place in the British materia medica, and is frequently prescribed as a substitute for colchicum, in the cure of the gout and rheumatism. Its value as a medicine was first discovered by Gmelin and Steller, when travelling in Siberia, who inform us that the Siberians have recourse to it in rheumatic and other affections of the muscles and joints. The manner of using the plant by the Siberians is, by putting two drachms of the dried leaves in an earthen pot, with about 10 oz. of boiling water, and keeping it nearly at a boiling heat for a night: this they take in the morning, and, by repeating the dose three or four times, generally effect a cure. It is said to occasion heat, thirst, a degree of delirium, and a peculiar sensation of the parts affected. (*Woodville.*)

■ 7. *R. CAUCASIUM* Pall. The Caucasian Rhododendron.

Identification. Pall. Fl. Ross., 1. p. 46 t. 30; Don's Mill., 3. p. 844.; Lodd. Cat., ed. 1836.
Engravings Bot. Mag., t. 1143.; and our fig. 934.

Spec. Char., &c. Leaves ovate-oblong, clothed with rusty tomentum beneath, rugged and green above. Peduncles hairy. Bracteas elongated, tomentose. Ovarium downy. Root creeping. Branches procumbent. Flowers purple or white, disposed in umbellate corymbs. Corollas rotate, with wavy, rounded segments. (*Don's Mill.*, iii. p. 844.) A native of Caucasus, on high rocks, near the limits of perpetual snow; where it forms an evergreen shrub, growing 1 ft. high, and flowering in August. It was introduced in 1803, but is rare in collections. There are plants at Messrs. Loddiges's, and at Knaphill.



934

Varieties. The following hybrids are among the handsomest rhododendrons in cultivation:—

- *R. c. 2 stramineum* Hook. Bot. Mag., t. 3422., has straw-coloured corollas. A plant of this variety in the Glasgow Botanic Garden, in April, 1835, was 2 ft. high, and 3 ft. in diameter, with the extremities of its fine leafy branches terminated with clusters of large, beautiful, straw-coloured flowers. The climate of Scotland seems to suit this, and some of the other species found in the coldest parts of the Russian empire, better than that of the south of England.
- *R. c. 3 pulcherrimum* Lindl. Bot. Reg., t. 1820. f. 2., is a hybrid, obtained by Mr. Waterer of the Knaphill Nursery, between *R. arboreum* and *R. caucasicum*, in 1832. It is described as a "most beautiful variety," quite hardy, and an abundant flowerer.
- *R. c. 4 Nobleanum* Hort., Bot. Reg., t. 1820. f. 1., is a hybrid, very much like the preceding one in all respects, except that its flowers are of a deep and brilliant rose colour.

■ 8. *R. PUNCTATUM* Andr. The dotted-leaved Rhododendron.

Identification. Andr. Bot. Rep., 36.; Vent. Cels., t. 15.; Don's Mill., 3. p. 844.; Lodd. Cat., ed. 1836.
Synonymes. *R. ferrugineum* var. *minus* Pers. Ench., 1. p. 478.; *R. minus* Michx. Fl. Bor. Amer., 1. p. 258.; *R. punctatum* var. *minus* Wats. Dend. Brit., 162. A.
Engravings. Andr. Bot. Rep., 36.; Vent. Cels., t. 15.; Wats. Dend. Brit., t. 162. A.; and our fig. 935.

Spec. Char., &c. Leaves oval-lanceolate, acute at both ends, glabrous, beset with rusty resinous dots beneath. Pedicels short. Calycine teeth short.

Segments of corolla ovate, a little undulated. Flowers pink, disposed in umbellate corymbs. Corollas funnel-shaped. Capsules elongated. (*Don's Mill.*, iii. p. 844.) It is a native of Carolina, on the mountains, particularly at the head waters of the Savannah River, where it forms an evergreen shrub, growing to the height of 4 ft., and flowering in July and August. Introduced in 1786, and frequent in collections.



935

Variety.

- *R. p. 2 majus* Ker, Bot. Reg., t. 37.—Leaves and flowers larger.

■ 9. *R. FERRUGINEUM* L. The rusty-leaved Rhododendron.

Identification. Lin. Sp., 562; Don's Mill., 3. p. 844; Lodd. Cat., ed. 1836.

Engravings. Jacq. Obs., 1. p. 26. t. 16; Fl. Austr., 3. t. 255; Lodd. Bot. Cab., 65; Lob. Icon., 366; and our fig. 936.

Spec. Char., &c. Leaves oblong, attenuated at both ends, glabrous, shining and green above, but thickly beset with rusty dots beneath. Calycine segments dentately ciliated. Leaves like those

of the box tree; when young, ciliated with a few hairs at bottom. Flowers of a beautiful rose colour or scarlet, disposed in umbellate corymbs, marked with ash-coloured or yellow dots. Corollas funnel-shaped. Filaments hairy at bottom. (*Don's Mill.*, iii. p. 844.) It is a native of the Alps of Europe, as of Switzerland, Austria, Savoy, Dauphiné, and Piedmont; where this species and *R. hirsutum* terminate ligneous vegetation, and furnish the shepherds with their only fuel. It is an evergreen shrub, growing about 1 ft. high, and flowering from May to July. Introduced in 1752, and frequent in collections.

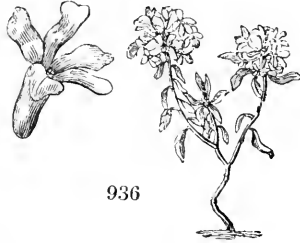

936

Variety.

- *R. f. 2 album* Lodd. Cat., ed. 1836, has white flowers.

■ 10. *R. (? F.) HIRSUM* L. The hairy Rhododendron.

Identification. Lin. Sp., 562; Don's Mill., 3. p. 844.

Engravings. Jacq. Austr., 1. t. 98; Bot. Mag., 1. 1853; Lodd. Bot. Cab., t. 479; Lob. Icon., 468; and our fig. 937.

Spec. Char., &c. Leaves ovate-lanceolate, or elliptic, acutish, ciliated, with rusty hairs on the margins, glabrous above, dotted and hairy beneath. Calycine segments fringed, bearded. Flowers pale red or scarlet, disposed in umbellate corymbs. Corollas funnel-shaped. (*Don's Mill.*, iii. p. 844.) It is a native of the Alps of Europe, and of Switzerland, Austria, Styria, Dauphiné, &c.; where it forms a shrub growing from 1 ft. to 2 ft. high, flowering from May to July. Introduced in 1656, and possibly only a variety of the preceding species.



937

Variety.

- *R. (f.) h. 2 variegatum* has the leaves edged with yellow.

■ 11. *R. SETOSUM* D. Don. The bristly Rhododendron.

Identification. D. Don in Wern. Soc. Trans., 3. p. 408; Prod. Fl. Nep., 152; Don's Mill., 3. p. 844.

Spec. Char., &c. Branchlets beset with bristles. Leaves oval, mucronate, bristly on the margins and under surfaces. Pedicels beset with glandular hairs. Calycine segments rounded, coloured, naked, crenulated. A small, stiff, much-branched shrub. Leaves half an inch long. Flowers

purple, size of those of *R. dauricum*, disposed in umbellate corymbs. Calyx purple. Filaments bearded at the base. Stigma capitate. (*Don's Mill.*, iii. p. 844.) A native of Nepal, in Gossainthan; where it is a shrub, growing from half a foot to one foot in height; but it has not yet flowered in England, where it is considered as a frame shrub. It was introduced in 1825; but we have not seen the plant.

■ *R. macrophyllum* D. Don (*G. Don's Mill.*, iii. p. 843.) is a native of the north-west coast of North America, where it was collected by Mr. Menzies; and there are specimens in Mr. Lambert's herbarium; but the plant has not yet been introduced. The petioles of the leaves are 1 in., and their disks from 7 in. to 8 in., long; and the flowers are smaller than those of *R. maximum*, and white.

§ ii. *Lephipherum* D. Don.

Derivation. From *lepis*, a scale, and *pherō*, to bear; leaves covered with small scales. Limb of calyx dilated, 5-lobed. Corolla campanulate or rotate. Stamens 10. Ovarium 5-celled. Leaves membranous; sometimes deciduous, but generally persistent. Shrubs, natives of Europe, North America, and the Himalayas.

2. 12. *R. LAPPO'NICUM* Wahl. The Lapland Rhododendron.

Identification. Wahl. Fl. Suec., p. 249; Don's Mill., 3. p. 845.

Synonymes. *Azalea lapponica* Lin. Fl. Suec., p. 64, Sp., t. 214, Fl. Lapp., ed. Smith, p. 59. t. 6. f. 1.

Hook. Bot. Mag., 3106; A. ferruginea Hort.

Engraving. Our fig. 938.

Spec. Char., &c. Shrub, branched, procumbent. Branches divaricate. Corollas rotately funnel-shaped. Young branches obscurely pubescent, warted. Leaves oblong, obtuse, stiff, beset with honeycomb-like dots, yellowish and scaly beneath; deep green above; and pale green, and at length yellowish, beneath; thickly beset with hollow dots on both surfaces, which are covered by umbilicate permanent scales. Flowers crimson, disposed in umbellate corymbs, 5—6 together, surrounded by large dotted scales, or bracteas. Calyx covered with yellow scales, ciliated. Segments of corolla unequal, and undulated. Stamens 5—8, equal in length to the corolla. Stigma capitate, 5-lobed. Filaments hairy at the base. (*Don's Mill.*, iii. p. 845.) It is a native of the arctic regions of Europe, Asia, and North America, where it forms a procumbent shrub, flowering in July. Introduced in 1825, but rare in collections.



2. 13. *R. DAURICUM* L. The Daurian Rhododendron.

Identification. Lin. Sp., 562; Don's Mill., 3. p. 845; Lodd. Cat., ed. 1836.

Engravings. Pall. Fl. Ross., 1. p. 47. t. 52; Andr. Bot. Rep., t. 4; Bot. Mag., t. 836; Lodd. Bot. Cab., t. 605; Amm. Ruth., 181. t. 21.

Spec. Char., &c. Leaves deciduous, oblong, attenuated at both ends, glabrous, but sprinkled with rusty scales, especially beneath. Limb of calyx 5-toothed. Corollas rotate. Roots knobbed, abounding in fibres. Stems twisted and knobbed in the wild state. Petioles downy. Leaves dotted on both surfaces, but ferruginous beneath. Before they fall in autumn, they become of a dusky red colour. The flowers rise before the leaves, from the tops of the branches, from buds which are composed of concave downy scales. Corolla purple. (*Don's Mill.*, iii. p. 845.) It is a native of Siberia, peculiar to the alpine tracts of Eastern Asia. It appears first at the mouth of the river Yenissei; and beyond that, especially from the river Uda, in the pine woods, it begins to be common; but about the Baikal it is most abundant, and extends through the deserts of the Mongols to China and Thibet. At the Lena it becomes more rare; and beyond that it is much dwarfer, with more slender flowers, and narrower leaves. Pallas informs us that the leaves are narcotic, fragrant, and possess the odour of those of *Ledum palustre*; and that, like it, they are used to drive away bugs, and also as tea. The fruit, he says, is employed for intoxicating fish, but in what manner, or for what purpose, he does not state. A shrub, growing from 2 ft. to 6 ft. high; flowering from December to March. Introduced in 1780, and frequent in collections.



Variety.

- α *R. d. 2 atrovirens* Ker, Bot. Reg., t. 194., Bot. Mag., t. 1888., Lodd. Cat., ed. 1836, is subevergreen. Leaves deep green, and shining above. It is a native of Siberia.

R. lepidotum Wall. (*Royle Illust.*, p. 260. t. 64. f. 1.; *Don's Mill.*, 3. p. 845.) is a native of Nepal, with the habit of *R. dauricum*, but with leaves of a thinner texture; and with every part of the plant beset with ferruginous scale-like dots. It grows to the height of 2 ft. or 3 ft., but has not yet been introduced.

§ iii. *Chamæcistus* D. Don.

Derivation. From *chamai*, on the ground, and *cistus*, the rock rose; plants with the habit of species of *Helianthemum*. Limb of calyx foliaceous, 5-cleft. Corolla rotate. Stamens 10. Ovarium 5-celled. Diminutive, prostrate, evergreen shrubs, with small membranous leaves.

- α 14. *R. CAMTSCHATICUM* Pall. The Kantschatka Rhododendron.

Identification. Pall. Fl. Ross., 1. p. 48. t. 33.; Don's Mill., 3. p. 845.

Engravings. Gmel. Sib., 4. p. 126. No. 13.; and our fig. 940.

Spec. Char., &c. Leaves obovate, acutish, 5-nerved, naked, ciliated, peduncles hairy, usually twin. Calyxine segments ciliated, foliaceous. Corollas purple, rotate. (*Don's Mill.*, iii. p. 845.) A prostrate shrub, flowering in July; a native of Kamtschatka and the Aleutian Islands, in muddy places on the mountains. Introduced in 1802, but rare in British gardens. There are plants at Messrs. Loddiges's.



940

- α 15. *R. CHAMÆCISTUS* L. The Ground-Cistus Rhododendron.

Identification. Lin. Sp., 502.; Don's Mill., 3. p. 854.; Lodd. Cat., ed. 1836.

Engravings. Jacq. Fl. Austr., 3. t. 217.; Bot. Mag., t. 488.; Bot. Cab., t. 1491.; Michel. Gen., 225. t. 106.; Pluk. Phyt., t. 23. f. 4.; and our fig. 941.

Spec. Char., &c. Leaves oblong-lanceolate, attenuated at both ends, stiffish, glandularly ciliated. Peduncles usually twin, and, as well as the calyxes, beset with glandular hairs. Corollas rotate, pale purple. A dwarf tufted shrub, with small leaves, about the size of those of a species of *Helianthemum*. (*Don's Mill.*, iii. p. 845.) A native of the Alps of Europe, as of Austria, Carniola, Mount Baldo, and near Salzburg; and in Eastern Siberia. It grows about half a foot high, and flowers in May and June. Introduced in 1786; but seldom to be met with in British gardens. Having very small leaves, it may without impropriety be introduced in such ericetums as admit *Daboëcia*, and other genera resembling the hardy heaths in general appearance.



941

§ iv. *Pentanthèra* D. Don.

Derivation. From *pente*, five, and *anthèra*, an anther; flowers pentandrous.

Sect. Char. Limb of calyx short, 5-lobed. Corolla funnel-shaped. Stamens 5. Ovarium 5-celled. Leaves deciduous. This group includes the hardy azaleas of the gardens, which have mostly deciduous leaves, and are quite distinct in their appearance from the plants of the preceding groups of this genus, which are all evergreen and subevergreen. We, therefore, think that it would be much better to constitute this section the genus *Azalea*, and retain as names for the species those in common use. The convenience of such an arrangement, in gardens where there are so many hundred varieties of *Azalea*, where so many are being annually produced, and where these varieties are so much in demand, will be felt by every gardener. It may be perfectly true, according to the usual principles of forming genera, that *Azalea* and *Rhododendron* are not generically distinct; but, when the adherence to this rule of science, as it may be called, leads to so much confusion and inconvenience as in the present case, in practice, we certainly

think it ought to be departed from; for, after all, the use of names is merely a matter of convenience. Agreeably to our determination not to institute any new genus, or to distinguish as species kinds not hitherto regarded as such, we have refrained from treating this section as a distinct genus; but, after Mr. Don's name, we have given the name previously applied, and then the common English name, leaving them to be adopted by the practical gardener, if he should think fit. At the same time, those who prefer following Mr. Don have only to pass over the names which we have put in parenthesis. We shall adopt the same mode when we come to the group which contains the Indian azaleas, which we have treated as half-hardy.

16. *R. FLAVUM* G. DON. (*AZALEA PONTICA* L.) The Pontic, or common, Azalea.

Identification. Don's Mill., 3. p. 847.

Synonymes. *Azalea pontica* Lin. Sp., 1669., *Curt. Bot. Mag.*, t. 433.; *Azalea arborescens* Lin. Sp., ed. 1. p. 150., *Buzb. Cent.*, 5. p. 56. t. 69.

Engravings. Bot. Mag., t. 2383.; and our fig. 942.

Spec. Char. &c. Flowers leafy, clammy. Leaves ovate, oblong, pilose, ciliated. Corolla funnel-shaped. Stamens very long. (*Don's Mill.*, iii. p. 847.) There are a great number of varieties of this species in the gardens, differing principally in the colour of their flowers, and the hue of the leaves. The flowers of the species are of a fine bright yellow; but those of the varieties are of all shades, from yellow to copper, or orange, colour; and they are sometimes of a pure white, or of white striped with yellow and red. This shrub is deciduous, and a native of the Levant, of Pontus, of Caucasus, Asiatic Turkey, &c. It grows to the height of from 4 ft. to 6 ft., and flowers in May and June. It was introduced in 1793.



Varieties and Hybrids. As this species seeds freely, and is easily cross-fecundated with the North American species, an immense number of varieties of it have been originated in British and Continental gardens. Plants first began to be produced in this way, in the Hammersmith Nursery, about the beginning of the present century; and they have since been raised every where: many hundreds by Mr. Waterer of the Knaphill Nursery; many in the Earl of Caernarvon's gardens at High Clere; and many by the commercial gardeners and amateurs of Belgium, especially in the neighbourhood of Ghent. The High Clere seedlings, and those of Ghent, are, perhaps, the richest-coloured flowers; but some equally beautiful have been raised by Mr. Waterer, Mr. Donald, and others. The varieties and hybrids which are considered as belonging to *Azalea pontica*, which are given in Loddiges's *Catalogue* for 1836, are the following:—

A. p. 2 alba.	A. p. 5 cœpnea.	A. p. 8 glauca.	A. p. 11 pallida.
3 aurantia.	6 flammea	9 ignescens.	12 tricolor.
4 crocata.	7 fulgens.	10 ochroleuca.	

17. *R. NUDIFLORUM* Torr. (*AZALEA NUDIFLORA* L.) The naked-flowered Azalea.

Identification. Torr. Fl. Un. St., 1. p. 140.; Don's Mill., 3. p. 847.

Synonymes. *Azalea nudiflora* Lin. Sp., 214.; *Azalea periclymenoides* Michx. Fl. Bor. Amer., 1. p. 115., *Pursh Fl. Amer. Sept.*, 1. p. 152.; the American Honeysuckle; May Flowers, and wild, or upright, Honeysuckle, Amer.

Engraving. Our fig. 943.

Spec. Char., &c. Leaves lanceolate-oblong, nearly smooth, and green on both surfaces, ciliated on the margins, having the midrib bristly beneath, and woolly above. Flowers rather naked, not clammy, scarlet, pink, white, striped, variegated, red, purple, &c., disposed in terminal clustered racemes, appearing before the leaves. Tube of corolla longer than the divisions. Teeth of calyx short, rather rounded.



Stamens much exserted. (*Don's Mill.*, iii. p. 847.) A deciduous shrub, a native of North America, from Canada to Georgia, on the sides of hills; where it grows from 3 ft. to 4 ft. high, flowering from April to June. Introduced in 1734. It is the parent of numerous varieties, and, in conjunction with the preceding species, of numerous hybrids.

Varieties and Hybrids.

- ☼ *R. n. 1 coccineum* D. Don; *Azàlea n. coccinea Sims, Bot. Mag.*, t. 180.; has the flowers scarlet, and the leaves lanceolate. It is a native of Georgia, near Savannah.
- ☼ *R. n. 2 rutilans* D. Don; *A. n. rutilans Ait. Hort. Kew.*, p. 319.; *A. periclymenoides rutilans Pursh Fl. Amer. Sept.*, i. p. 152.—The flowers are deep red. Calyxes minute.
- ☼ *R. n. 3 carneum* D. Don; *A. n. carnea Ait.*, l. c., *Ker Bot. Reg.*, t. 120.; *A. p. carnea Pursh*, l. c.—The corollas are pale red, having the tube red at the base, and the calyx foliaceous.
- ☼ *R. n. 4 album* D. Don; *A. n. alba Ait.*, l. c.; *A. p. alba Pursh*; has the flowers white, and the calyx middle-sized.
- ☼ *R. n. 5 papilionaceum* D. Don, *A. p. papilionacea Pursh*, has reddish flowers, with the lower segment white, and the calyx foliaceous.
- ☼ *R. n. 6 partitum* D. Don, *A. p. partita Pursh*.—The flowers are pale red, 5-parted, even to the base.
- ☼ *R. n. 7 polyandrum* D. Don; *A. p. polyandra Pursh*, l. c.; has flowers of a rose colour, short. Stamens 10—20. It is found near Philadelphia.
- ☼ *R. n. 8 Gorenianum* D. Don in *Brit. Fl.-Gard.*, iii. t. 263., and our fig. 944., has the branches tomentosely downy. Leaves evergreen or deciduous, oblong, acute, downy while young, but glabrous in the adult state, and recurved at the apex. Tube of corolla a little shorter than the segments. Flowers delicate light purple, disposed in terminal racemose corymbs. It is a hybrid raised from the seed of *A. nudiflora* impregnated by the pollen of a hybrid raised between *R. ponticum* and *R. catawbiense*. This variety Mr. G. Don considers as proving “clearly that *Rhododendron* and *Azàlea* are not generically distinct;” (*Don's Mill.*, iii. p. 387.) which we believe to be the case, according to the canons for distinguishing genera, at present in use among botanists: but, as before observed, we have kept the genus *Azàlea* distinct, for the sake of expediency, independently altogether of our own private opinion, that genera ought to be established on a totality of characters and properties; not taking merely the form and organisation of the parts of fructification.
- ☼ *R. n. 9 rubrum* Lodd. *Bot. Cab.*, t. 51., has the flowers red.
- ☼ *R. n. 10 eximium* D. Don was raised, in 1829, from seeds of *R. nudiflorum coccineum majus*, to which pollen of *Rhododendron arboreum* had been applied. It resembles its female parent, having very little affinity with *R. arboreum*, except in its evergreen leaves and decandrous flowers.



The varieties and hybrids assigned to *A. nudiflora* in Loddiges's *Catalogue* for 1836 are the following:—

A. n. 2 álba et rúbra.
 3 amœ'na.
 4 blánda.
 5 carnea.
 6 caroliniana.
 7 Cobúrgia.
 8 coloráta.
 9 conspicua.
 10 crispa.
 11 cúmula.
 12 discolor.
 13 fastigiáta.
 14 flore pleno.
 15 flórida.
 16 globósa.
 17 grandiflora.
 18 incána.
 19 incarnáta.
 20 mirábilis.
 21 montána.
 22 ochroleuca.

A. n. 23 pállida.
 24 pallidósa.
 25 papilionácea.
 26 periclymenóides.
 27 purpuráscens.
 28 purpúrea.
 29 rósea (fig. 945).
 30 rubérrima.
 31 rubicúnda.
 32 rúbra.
 33 rúfa.
 34 rótilans.
 35 serotina.
 36 stamina.
 37 stelláta.
 38 tricolor.
 39 vária.
 40 variábilis.
 41 variegáta.
 42 versicolor.
 43 violácea.



945

❖ 18. *R. bicolor* G. Don. (A. (S.) *bicolor* Pursh.) The two-coloured-flowered Azalea.

Identification. Don's Mill., 3. p. 847.

Synonymes. *Azalea bicolor* Pursh *Fl. Amer. Sept.*, 1. p. 153; *Azalea nudiflora* var. *bicolor* *Ait. Hort. Kew.*, 1. p. 319, *Tree Ehret.*, 48.

Spec. Char., &c. Leaves oblong, clothed on both surfaces with fine hoary pubescence, not bristly on the nerve. Flowers small, not clammy, naked. Tube of corolla hardly longer than the segments. Calyxes very short; having one of the segments linear, and 4 times longer than the rest. Filaments exerted. Branchlets hispid. (*Don's Mill.*, iii. p. 848.) The flowers, which are slender, and smaller than those of most of the species, are of a pale rose colour, or nearly white, with a deep-red-coloured tube. The plant is a native of Carolina and Georgia, on barren sandy hills; where it forms a shrub growing from 3 ft. to 4 ft. high, and flowering in May and June. It was introduced in 1734, and is frequent in British gardens; though it does not appear to us to deserve to be considered in any other light than as a variety of *R. nudiflorum*.

❖ 19. *R. calendulæceum* Torr. (A. (S.) *calendulæcea* Michx.) The Marigold-flowered Azalea.

Identification. Torr. *Fl. Un. St.* p. 140.; Don's Mill., 3. p. 847.

Synonymes. *Azalea calendulæcea* Michx. *Fl. Bor. Amer.*, 1. p. 156., *Lodd. Bot. Cab.*, t. 1394.; *A. nudiflora* var. *coccinea* *Ait. Hort. Kew.*, 319.

Engravings. *Bot. Mag.*, t. 172.; *Lodd. Bot. Cab.*, t. 1394.; *Bot. Reg.*, t. 1154.; and our fig. 946.

Spec. Char., &c. Leaves oblong, pubescent on both surfaces, but afterwards hairy. Flowers large, not clammy, rather naked. Teeth of calyx oblong. Tube of corolla hairy, shorter than the segments. (*Don's Mill.*, iii. p. 847.) The plant is indigenous to North America, from Pennsylvania to Carolina; where it forms a shrub from 2 ft. to 6 ft. high, and producing its yellow, red, orange-coloured, or copper-coloured flowers from May till June; which, according to Pursh, is without exception, the handsomest shrub in North America.



946

Varieties.

❖ *R. c. 2 Mortèrii* Swt. *Fl.-Gard.*, 2d s., 10., is a hybrid between *R. calendulæcea* and one of the red varieties of *R. nudiflorum*, of which there are two subvarieties; one with a flesh-coloured corolla, having the upper segment orange-coloured, edged with flesh-colour, called *R. Mortèrii carneum*; and another, called *R. Mortèrii* var. *præstans*, with pale copper-coloured flowers, tinged with blush.

❖ *R. c. 3 fulgidum* Hook., *A. e. fulgida* *Hort.*, has the corollas of an orange-red colour, with bright green leaves, which spread out beneath the corymbs of flowers, and form a rich background to them.

20. *R. CANE'SCENS* *G. Don.* (*A. (N.) CANE'SCENS Michx.*) The canescent Azalea.

Identification. Don's Mill., 3. p. 848.

Synonyme. *Azalea canescens Michx. Fl. Bor. Amer., 1. p. 150., Wats. Dend. Brit., t. 116.*

Engraving. Wats. Dend. Brit., t. 116.

Spec. Char., &c. Leaves obovate-oblong, downy above, and tomentose beneath, not bristly on the middle nerve. Flowers not clammy, nearly naked. Tube of corolla hardly shorter than the segments. Teeth of calyx very short, rounded, obtuse. Stamens hardly exerted. (*Don's Mill., iii. p. 848.*) A native of Lower Carolina, on the banks of rivers; and of Virginia, on the mountains of the Cacapon Springs, near Winchester; where it forms a shrub growing 3 ft. or 4 ft. high, and producing its rose-coloured flowers in May and June. Introduced in 1812, and cultivated in several of the London nurseries.

21. *R. VISCO'SUM* *Torr.* (*A. VISCO'SA L.*) The clammy-flowered Azalea.

Identification. Torr., l. c.; Don's Mill., 3. p. 847.

Synonyme. *Azalea viscosa Lin. Sp., 214., Pluk. Alm., 106. t. 161. f. 4., Catesb. Car., 1. t. 57.*

Engraving. Our fig. 947.

Spec. Char., &c. Leaves oblong-obovate, acute, smooth and green on both surfaces, ciliated on the margins, having the midrib bristly. Flowers produced in terminal clusters, and clammy, leafy, and hairy. Tube of corolla as long as the segments. Teeth of the calyx short, rounded. Stamens hardly longer than the corolla. There are a great many varieties of this species (see *Loud. Hort. Brit., p. 66.*), varying in the colour of the flowers, and otherwise. (*Don's Mill., iii. p. 847.*) A native of North America, from Canada to Georgia, in swamps and shady woods; where it forms a shrub growing from 2 ft. to 4 ft. high, and producing its white sweet-scented flowers in July and August. Introduced in 1734, and, like the preceding sort, the parent of numerous varieties and hybrids.



Varieties.

2. *R. v. 2 ornatum* *Swt. Fl.-Gard., 2d s., t. 137.*, is a hybrid raised from the seed of *R. viscosum* β *rubescens*, fertilised by the pollen of *Rhododendron ponticum*.

The varieties and hybrids, in Loddiges's *Catalogue* for 1836, of *A. viscosa* are as follows:—

A. Varieties.

A. v. 2 <i>alba</i>	A. v. 5 <i>penicillata.</i>	A. v. 8 <i>variegata.</i>
3 <i>crispa.</i>	6 <i>pra'cox.</i>	9 <i>vittata.</i>
4 <i>dealbata.</i>	7 <i>pubescens.</i>	10 <i>violæ odore.</i>

B. Hybridæ altaelercenses. Hybrids raised at High Clere.

11 <i>amœna.</i>	20 <i>eudæmon.</i>	26 <i>ochroleuca.</i>
12 <i>actiuata.</i>	21 <i>cùprepes.</i>	29 <i>poikila.</i>
13 <i>auroræ.</i>	22 <i>Govènia.</i>	30 <i>pòntica Howard.</i>
14 <i>basilissa.</i>	23 <i>Herbertiana.</i>	hexapla.
15 <i>calodendron.</i>	24 <i>imperatrix.</i>	31 <i>pulchella.</i>
16 <i>calocoryphe.</i>	25 <i>inelyta.</i>	32 <i>regalis.</i>
17 <i>Cartonia.</i>	26 <i>jasminodora.</i>	33 <i>rùgens.</i>
18 <i>charicssa.</i>	27 <i>lépida.</i>	34 <i>thyrsiflora.</i>
19 <i>coccinea nobilis.</i>		

C. Hybridæ belgicæ. Hybrids raised in Belgium.

35 <i>Agate.</i>	49 <i>crœca.</i>	58 <i>Ferrôckii.</i>
36 <i>álbo plêno.</i>	globôsa.	59 <i>flamboyante.</i>
37 <i>amâbilis.</i>	50 <i>crûenta.</i>	60 <i>falgida.</i>
38 <i>amarantina.</i>	51 <i>cùprea.</i>	61 <i>fâlva.</i>
39 <i>amœnissima.</i>	<i>álba.</i>	62 <i>glôria mûndi.</i>
40 <i>árdens.</i>	<i>élegans.</i>	<i>máxima.</i>
41 <i>âtro-rùbens.</i>	<i>exîmia.</i>	<i>minor.</i>
42 <i>aurántia máxima.</i>	<i>globôsa.</i>	63 <i>Gulíchmus prlms.</i>
43 <i>blandina.</i>	<i>rûbra.</i>	64 <i>hýbrida coccifera.</i>
44 <i>calendulæca globôsa.</i>	<i>spléndens.</i>	<i>coccinea.</i>
<i>insignis.</i>	52 <i>decorata.</i>	<i>nivea.</i>
<i>nôva.</i>	53 <i>dœcus hortòrum.</i>	65 <i>incarnata máxima.</i>
<i>superba.</i>	54 <i>dulcêdo.</i>	<i>rûbra.</i>
45 <i>cardon.</i>	55 <i>elçeta.</i>	66 <i>lépida.</i>
46 <i>coccinea máxima.</i>	<i>máxima.</i>	67 <i>lutea rubicûnda.</i>
<i>speciôsa.</i>	<i>rûbra.</i>	68 <i>magnifica.</i>
47 <i>concinna.</i>	56 <i>elegantissima.</i>	69 <i>maritima incarnata.</i>
48 <i>coriscans.</i>	57 <i>exquisita.</i>	70 <i>miniata.</i>

71 mirábilis.	83 præstantíssima.	96 speciosa.
72 mixta triúmphans.	84 pulch'illa.	97 speciosíssima.
73 miniáta.	85 punicea.	98 splendens.
74 Mort'erii.	86 récqui.	99 splendida.
75 nè plus últra.	87 regina b'elgica.	100 sulph'urea.
76 nobilis.	88 restantíssima.	101 sup'érba.
77 nóritas antill'escens.	89 rigida incarnáta.	102 tricolor Jac'obí.
78 noritáta.	90 robústa.	Wolff.
79 óptima.	91 rubra aurántia.	103 triúmphans.
80 ornáta pállida.	fúlva.	104 variegáta.
81 picturáta	92 rubricáta.	105 venústa.
82 póntica glob'osa.	93 sanguinea.	106 venustíssima.
Konink.	94 Satúrní.	107 versicolor
tricolor var.	95 sev'era.	

22. *R. GLAUCUM* G. Don. (A. (v.) GLAU'CA Pursh.) The glaucous-leaved Azalea.

Identification. Don's Mill., 3. p. 848.

Synonymes. *Azalea glauca Pursh Fl. Amer. Sept.*, 1. p. 154., *Lam. Ill.*, t. 493., *Wats. Dend. Brit.*, t. 5.; *Azalea viscosa* var. *floribunda* *Ait. Hort. Kew.*, 1. p. 319.

Spec. Char., &c. Branchlets hispid. Leaves oblanceolate, acute, glabrous on both surfaces, glaucous beneath, ciliated on the margins, having the midrib bristly. Flowers very clammy, leafy. Tube of corolla twice longer than the segments. Calyx very short. Filaments about equal in length to the segments of the corolla. (*Don's Mill.*, iii. p. 848.) The shrub is dwarfer than any of the other North American species of *Azalea*; and it produces its fragrant white flowers in great abundance. Nuttall considers this as only a variety of *R. viscosum*, differing in nothing but in the under surface of the leaves being glaucous; in which opinion we concur. It is a native of North America, from New England to Virginia, in swamps of a clayey soil; where it forms a shrub, growing about 2 ft. high, and flowering in June and July. Introduced in 1734, and common in gardens.

23. *R. HISPIDUM* Torr. (A. (v.) HISPIDA Pursh.) The hispid Azalea.

Identification. Torr. Fl. Un. St., p. 140.; Don's Mill., 3. p. 847.

Synonymes. *Azalea hispida Pursh Fl. Amer. Sept.*, 1. p. 154., *Wats. Dend. Brit.*, t. 6.; *Azalea viscosa* var. *glauca Ait. Hort. Kew.*, 1. p. 319.?

Engravings. *Dend. Brit.*, t. 6.; and our fig. 948.

Spec. Char., &c. Branches straight, very hispid. Leaves long-lanceolate, hispid above, and smooth beneath, glaucous on both surfaces, ciliated on the margins, having the nerves bristly beneath. Flowers very clammy, leafy. Tube of corolla wide, scarcely longer than the segments. Teeth of calyx oblong, rounded. Filaments exserted. (*Don's Mill.*, iii. p. 487.) The flowers are white, with a red border, and a tinge of red on the tube, which makes them appear to be of a rose colour before expansion; and they have sometimes 10 stamens. This sort may be distinguished from the other hardy azaleas by its bluish appearance. It is found wild in New York and Pennsylvania, on the borders of lakes on the highest part of the Blue Mountains; where it grows from 10 ft. to 15 ft. high, and flowers in July and August. It was introduced in 1734, and is now to be met with in most collections.



24. *R. NITIDUM* Torr. (A. NITIDA Pursh.) The glossy-leaved Azalea.

Identification. Torr., l. c.; Don's Mill., 3. p. 847.

Synonymes. *Azalea nitida Pursh Fl. Amer. Sept.*, 1. p. 153., *Ker Bot. Reg.*, t. 414.

Engravings. *Bot. Reg.*, t. 414.; and our fig. 949.

Spec. Char., &c. Branches smoothish. Leaves oblanceolate, rather mucronate, coriaceous, smooth on both surfaces, shining above, having the nerve bristly beneath, with revolute ciliated margins. Flowers clammy, leafy. Tube of corolla a little longer than the segments. Calyx very short. Filaments exserted. (*Don's Mill.*, iii. p. 847.) The flowers are white, tinged with red; and the leaves dark green and shining. They are also smaller than those of any other hardy species of *Azalea*. The plan



is a native of North America, from New York to Virginia, and is found in deep mossy swamps on the mountains. It is a shrub, growing from 2 ft. to 4 ft. in height, and flowering in June and July. Introduced in 1812, and in cultivation in British nurseries.

25. *R. SPECIOSUM* G. Don. (*A. SPECIOSA* Willd.) The showy Azalea.

Identification. Don's Mill., 3. p. 848.

Synonymes. *Azalea speciosa* Willd. *Enum.*, p. 10., *Wats. Dend. Brit.*, t. 116. ;

A. coccinea Lodd. *Bot. Cab.*, t. 624.

Engravings. *Bot. Cat.*, t. 624. ; *Dend. Brit.*, t. 116. ; and our *fig.* 950.

Spec. Char., &c. Branches hairy. Leaves lanceolate, ciliated, acute at both ends. Calyx pubescent. Corolla silky, with obtuse, ciliated, lanceolate, undulated segments. Stamens exserted. (*Don's Mill.*, iii. p. 848.) We are strongly inclined to think that this, and several other sorts, which, in conformity with the practice of modern writers, we have treated as species, are only varieties; in short, it would not surprise us, if ultimately it should turn out that there was only one species of *Azalea* indigenous to North America, and one species to Asia.



950

26. *R. ARBORESCENS* Torr. (*A. ARBORESCENS* Pursh.) The arborescent Azalea.

Identification. Torr., 1. c. ; Don's Mill., 3. p. 847.

Synonymes. *Azalea arborescens* Pursh *Fl. Amer. Sept.*, 1. p. 153. ; *A. arborea* Bart. *Cat.*

Spec. Char., &c. Leaves obovate, rather obtuse, smooth on both surfaces, glaucous beneath, ciliated on the margins, having the midrib almost smooth. Flowers not clammy, leafy. Tube of corolla longer than the segments. Calyx leafy, with the segments oblong and acute. Filaments exserted. (*Don's Mill.*, iii. p. 847.) Pursh, writing of this species, in 1814, says, "This beautiful species has, to my knowledge, not yet been introduced into the gardens. I have only seen it in its native place, and in the garden of Mr. John Bartram, near Philadelphia, whose father introduced it many years ago. It rises from 10 ft. to 15 ft. high; and forms, with its elegant foliage, and large, abundant, rose-coloured flowers, the finest ornamental shrub I know. The flowers are not so pubescent as those of the other species. The scales of the flower buds are large, yellowish brown, and surrounded with a fringed white border." (*Pursh Fl. Amer. Sept.*, i. p. 153.) It was introduced in 1818; and there are plants of it at Messrs. Loddiges's; but it is not frequent in collections.

§ v. *Rhodora* D. Don.

Identification. Don's Mill., 3. p. 848.

Derivation. From *rhodon*, a rose; in reference to the colour of the flowers.

Sect. Char. Limb of calyx 5-toothed. Corolla bilabiate: upper lip broadest, and 2—3-cleft; lower one bidentate. Stamens 10. Capsule 5-celled, 5-valved. Leaves deciduous. (*Don's Mill.*, iii. p. 848.)

27. *R. RHODORA* G. Don (*RHODORA CANADENSIS* L.) The Canada Rhodora.

Identification. Don's Mill., 3. p. 843.

Synonymes. *Rhodora canadensis* Lin. *Sp.*, 56L., *L'Hérit. Stirp. Nov.*, 1. p. 141. t. 68., *Lam. Ill.*, t. 364., *Curt. Bot. Mag.*, t. 474.

Engravings. *L'Hérit. Stirp. Nov.*, 1. t. 68.; *Lam. Illust.*, t. 364.; *Bot. Mag.*, t. 474.; and our *fig.* 951.

Spec. Char., &c. Leaves oval, quite entire, pubescent and glaucous beneath. Flowers in terminal clusters, or racemose umbels; and pale purple, protruded before the leaves. (*Don's Mill.*, iii. p. 848.) A native of Canada, Newfoundland, and on the mountains of New York and Pennsylvania, in bogs. A deciduous shrub, growing about 2 ft. high, and flowering in April and May. Introduced in 1767, and frequent in collections, where it is highly prized for its early flowering and beauty. Plants of this species, in the British nurseries, are 1s. each; at Bollwyller, 3 francs; at New York, ?

App. i. *Half-hardy Species of Rhododendron (and Azalea).*

§ i. Booram.

Derivation. The name of *R. arboreum* in Nepal.

Spec. Char., &c. Limb of calyx 5-lobed. Corolla campanulate. Evergreen trees, natives of the Himalayas, and other mountainous regions of northern India.

A. *Species already introduced into British Gardens.*

† 28. *R. ARBOREUM* Smith. The scarlet-flowered Tree Rhododendron.

Identification. Smith Exot. Bot., t. 6.; Hook. Exot. Fl., 158.; Don's Mill., 3. p. 844.

Synonymy. *R. purpureum* Hamilt. MSS.

Engravings. Smith Exot. Bot., t. 6.; Lindl. Bot. Reg., t. 896.; and our fig. 951.

Spec. Char., &c. Leaves lanceolate, acute, silvery beneath, tapering to the base. Peduncles and calyxes woolly. Segments of corolla 2-lobed, with crenulated curled margins. Capsules 10-celled, tomentose. Leaves 4—6 in. long. Flowers large, scarlet, dotted with black on the upper lip inside, disposed in dense heads. Stigma capitate, crenulated. (*Don's Mill.*, iii. p. 844.) A tree, 20 ft. high, very showy when in blossom; a native of Nepal, on the mountains at Narainhetty, where it is called booram by the natives. It was introduced in 1817, and flowers, in conservatories, in April and May. Plants in Knight's Exotic Nursery, sown there in 1821, are now, in 1836, 18 ft. high, with trunks 8 in. in diameter: they grow in pots 2 ft. in diameter, and flower abundantly every year, or every other year. These flowers secrete honey to such an extent, that, when the plant is shaken, it falls from them like large drops of rain; and Mr. Knight informed us that he believed each head of flowers would yield from a teaspoonful to a dessert-spoonful at a time. After being exhausted, a fresh supply is secreted; so that the quantity that one head might produce, if the tree were frequently shaken, appears to be limited only by the duration of the flowers.

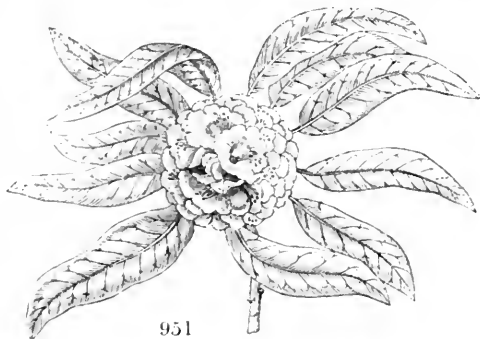

951

Varieties and Hybrids.

- 1 *R. a. 1 sanguineum* Lindl. Bot. Reg., t. 890., has the corollas blood-coloured, and may be considered as the species. Those spoken of above are of this kind.
- 2 *R. a. 2 roseum* Swt. Brit. Fl.-Gard., 2d ser. t. 389., Bot Reg., t. 1240., has rosy-coloured corollas. This variety was raised by Mr. Smith, at Combe House, in 1819, from Nepal seeds, and the plants flowered when they were not more than 2 ft. high. According to Dr. Wallich, *R. a. roseum* occurs with *R. a. niveum* on the mountain of Sheopore, at an elevation of 10,000 ft. above the level of the sea. It is likely, therefore, to be less tender than *R. arboreum sanguineum*, which is found at a much lower elevation, and it may ultimately prove to be quite hardy. There are plants of this sort at Mr. Knight's and Messrs. Loddiges's.
- 3 *R. a. 3 niveum* Swt.; *R. album* Hamilt. MSS., Swt. Fl.-Gard., t. 148., Don's Mill., iii. p. 844.; *R. arboreum floribus niveis* D. Don Prod. Fl. Nep., p. 154.; *R. arboreum album* Wall. Pl. Asiat. Rav., ii. t. 123.; has white flowers spotted with purple on the upper lip. Dr. Lindley, speaking of this variety, says, "Never did we behold any flower

more perfectly lovely than this. Its leaves, of the richest and deepest green, mellowed by the warm tone of their under surface; its large clusters of bell-shaped flowers, hanging loosely, yet compactly, by their slender stalks; and the half-transparent snowy corollas; form together an effect which few objects could rival, and none surpass." (*Bot. Reg.*, July, 1834.) This variety and *R. a. roseum*, as already remarked, are found at an elevation of 10,000 ft. above the level of the sea; and Dr. Wallich states that they are confined to the single mountain of Sheopore: *R. a. roseum* is there by far the most common variety. He says, "They attain the size of very large forest trees, and are noble objects at all times. They blossom simultaneously in April, in which state their beauty surpasses description, the ample crown of the trees being entirely covered with bunches of large and elegant blossoms." The common red-flowered, or parent, species (*R. a. sanguineum*) is also found on Sheopore; but it is less frequent there than in lower situations, where it blossoms a month earlier than the varieties. The hardness of the varieties of any species being proved, affords a presumption that the species itself is only accidentally tender, and that, after some generations, it may become hardy.

‡ *R. a. 4 cinnamomeum*; *R. cinnamomeum* *Wall. Cat.*, No. 760., and *Don's Mill.*, iii. p. 384.; has the leaves clothed with an intense rusty tomentum beneath; and corollas like those of *R. a. niveum*, but not of so clear a white, and spotted with brown instead of purple. It was introduced from Nepal in 1817, and flowered for the first time in the Chelsea Botanic Garden in 1832.

‡ *R. a. 5 venustum* *D. Don*, *Brit. Fl.-Gard.*, May, 1835, 2d ser., t. 285., is a hybrid, and an exceedingly showy and interesting plant. It was raised by Mr. Wm. Smith, nurseryman, Norbiton Common, near Kingston, Surrey, from seeds of *R. caucasicum*, that had been fertilised by the pollen of *R. arboreum*, and appears hardier than the species.



952

Other varieties and hybrids of R. arboreum and other half-hardy species may be found in the nurseries, some with and others without names; some of them rather tender, and others, such as R. a. altaicereuse (fig. 952.) quite hardy or nearly so. The names of several new varieties will doubtless appear in the nurserymen's catalogues, and in the botanical periodicals, before this work is completed: for there are many hundreds of seedlings of R. arboreum fertilised with hardy species; and hardy species fertilised with R. arboreum, in Knight's Exotic Nursery, in the Norbiton Common Nursery, and in various others, which are now (Sept. 1, 1836) showing blossom buds for the first time. Many of these hybrids will appear, be recorded, and afterwards, when they are supplanted by others of still newer origin, lost.

■ 29. *R. CAMPANULA'TUM* *D. Don*. The bell-shaped-flowered Rhododendron.

Identification. *D. Don* in *Wern. Mem.*, 3. p. 409.; *Prod. Fl. Nep.*, p. 153.; *Don's Mill.*, 3. p. 84.
Engravings. *Lodd. Bot. Cab.*, t. 1944.; *Swt. Fl.-Gard.*, 2d s., t. 241.; and our *fig. 953.*

Spec. Char., &c. Leaves elliptic-oblong, mucronate, rusty beneath, rather cordate at the base. Segments of corolla flat, emarginate. Ovarium 6-celled, glabrous. Under surfaces of leaves clothed with fine scaly pubescence, at first of a purplish hue, then changing to nearly white, and afterwards to a deep ferruginous brown. Flowers copious, disposed in corymbose clusters. Pedicels glabrous. Bracteas fringed. Corollas large, pale pink, changing to white, having the upper lip marked with irregular purple spots. Filaments bearded at the base. This species surpasses all others in the size of its flowers, except one found in Java by

Dr. Horsfield. (*Don's Mill.*, iii. p. 844.) A shrub, growing to the height of from 3 ft. to 5 ft., a native of Nepal, on Gossainthan, a high mountain to the north of the valley. It was raised in 1825, by Messrs. Loddiges, from seeds received from Dr. Wallich, and flowers in April. This species seems much less tender than any of the others yet received from the Himalayas; and, plants having stood out in the arboretum of Messrs. Loddiges for several winters without protection, and without having received any injury, it may be considered as very nearly hardy.



953

● *R. barbátum* Wall., *Don's Mill.*, 3. p. 844. Leaves oblong-lanceolate, acute, obtuse at the base, yellowish beneath. Calycine segments dilated, membranous. Ovarium 10-celled, glandular, hispid. Petioles and midrib of leaves bristly. Filaments glabrous, toothless. Leaves a span long. Corolla dark red, with broad, rounded, cloven segments. Ovarium thickly beset with glanduliferous bristles. A tree, a native of Nepal, introduced in 1830 or before, and of which there are plants at Messrs. Loddiges's, and in some other nurseries.

■ *R. zeyláncicum* Lodd. Cat., and *R. strictum* Lodd. Cat., appear to be varieties of *R. arbaticum*; but from the plants in the Hackney collection being small, and not having yet flowered, it is difficult to say with certainty what they are.

B. Species not yet introduced.

■ *R. formósum* Wall. Pl. Rar. Asiat., 3. p. 3. t. 207., *Don's Mill.*, 3. p. 835., has the leaves lanceolate, attenuated at the base, beset with rusty dots beneath, and the flowers about the size of those of *R. pónticum*, white, suffused with red. It is a shrub, a native of Nepal, which is not yet introduced.

■ *R. linearifólium* Poir., *Don's Mill.*, 3. p. 844., has linear coriaceous leaves, and small flowers in corymbs. It is a native of the East Indies; but very little is known respecting it, and it may probably belong to some other genus.

§ ii. Pogonánthum.

Derivation. From *pogón*, a beard, and *anthos*, a flower; throat woolly inside.

Sect. Char. Limb of calyx short, 5-lobed. Corolla salver-shaped, with a cylindrical tube, and a spreading limb. Stamens 5, enclosed. Ovarium 5-celled. Evergreen. Leaves coriaceous.

■ 30. *R. ANTHOPOGON* D. Don. The bearded-flowered Rhododendron.

Identification. D. Don in *Mém. Wern. Soc.*, 3. p. 469.; *Don's Mill.*, 3. p. 845.

Synonymie. *R. aromáticum* Wall. Cat.

Engravings. Royle *Illust.*, t. 64. f. 2.; and our fig. 954.

Spec. Char., &c. Branchlets downy. Leaves oval, rusty beneath from lepidotod tomentum. Corollas with a woolly throat. Shrub much branched. Leaves ending in a reflexed mucro, naked above. Flowers glomerate, sulphur-coloured. Pedicels short, lepidotod, and resinous. Calycine segments rounded at the apex, with villous margins. Segments of corolla roundish, with undulated curled margins. Filaments glabrous. Stigma clavate. (*Don's Mill.*, iii. p. 845.) A shrub, from 1 ft. to 1½ ft. high, a native of Nepal, on Gossainthan. It was introduced in 1820, and flowers in April and May.



954

§ iii. Tsutsútsi D. Don.

Derivation. The Chinese name of *A. indica*.

Sect. Char. Limb of calyx foliaceous, 5-cleft. Corolla campanulate. Stamens 5-10. Ovarium 5-celled. Evergreen. Leaves membranous, hispid from hairs. Indian azaleas of British gardens.

A. Indian half-hardy Azaleas already in British Gardens.

■ 31. *R. ÍNDICUM* Swt. (*A. ÍNDICA* Lin.) The Indian Azalea.

Identification. Swt. *Fl.-Gard.*, 2d s., t. 128.; *Don's Mill.*, 3. p. 845.

Synonymie. *Azalea indica* Lin. *Sp.*, 214., *Thunb. Fl. Jap.*, 84., *Sims Bot.*

Mag., t. 1480., *Lodd. Bot. Cab.*, t. 278.

Engravings. *Bot. Mag.*, t. 1480.; *Lodd. Bot. Cab.*, t. 275.; *Swt. Fl.-Gard.*, 2d ser., t. 128.; and our fig. 955.

Spec. Char., &c. Branches strigose. Leaves cuneate-lanceolate, finely crenulate, strigose, attenuated at both ends. Calycine teeth long-lanceolate, obtuse, ciliated, spreading. Flowers terminal, solitary or twin, decandrous; very showy, and scarlet or red. (*Don's Mill.*, iii. p. 845.) A shrub, from 3 ft. to 6 ft. high, a native of China and Japan, where it is much cultivated for the sake of its flowers. It was introduced in 1808, and flowers from March till May. It is a very popular plant in British stoves and green-houses; though, to flower profusely, it requires to be grown in the temperature of the bark-stove. As it cross-fecundates freely with the hardy species, it has led to the production of various hybrids, which are half-hardy, and some of them nearly hardy.



955

Varieties and Hybrids.

- *R. i. 2 phœniceum* Don's Mill., 3. p. 846; A. l. phœnicea *Swt. Brit. Fl.-Gard.*, 2d ser., t. 128., *Hook. in Bot. Mag.*, t. 2657; A. ledifolia phœnicea *Hook. in Bot. Mag.*, t. 3229; has the flowers purple, with the upper segments spotted. It is a native of China, where it forms an evergreen shrub, from 3ft. to 10 ft. in height, and in British gardens, where it is greatly admired, it is commonly kept in the stove. It was introduced in 1824.
- *R. i. 3 p. flore pleno*; A. i. 3 flore pleno *Hook. in Bot. Mag.*, t. 2509., *Bot. Cab.*, t. 1461.; has double purple flowers.
- *R. i. 4 ledifolium*; *R. ledifolium* Don's Mill., 3. p. 846; A. i. álba *Lindl. Bot. Reg.*, t. 811., *Lodd. Bot. Cab.*, t. 1253., and our fig. 956; A. ledifolia *Hook. in Bot. Mag.*, t. 2901.; *Rhododéndron leucanthum* *Bunge*; has pure white flowers, which are large and showy. It is a native of China, about Peking, and, being rather hardier than the preceding varieties, is commonly kept in the green-house. It was introduced in 1819, flowers from March to May, and grows to the height of 5 ft. or 6 ft. Splendid specimens of this and the preceding varieties are annually exhibited at the flower shows of the Horticultural Societies, both in London and the country. In Cornwall, in the gardens of Sir Charles Lemon, at Carclew, this variety grows in rows, forming evergreen hedges, like privet, and flowering magnificently, without the slightest protection.
- *R. i. 5 púchrum* Don's Mill., 3. p. 845; A. i. púchra *Hort.*; *R. púchrum* *Swt. Fl.-Gard.* 2d ser., t. 117; *R. indicum* var. γ . *Smithii* *Swt. Hort. Brit.*; has the calyx very hairy, with subulate segments. Leaves elliptic, acute. Flowers decandrous, terminal, 2-3 together. Corollas large, of a deep rosy purple, spotted with deep red inside. A hybrid from A. i. ledifolia, impregnated with the pollen of A. indica.
- *R. i. 6 ignescens* *Swt.*, Don's Mill., 3. p. 845; A. i. ignescens *Hort.*; has the four lower segments of the corolla flame-coloured and the superior one lilac, and obsoletely dotted. It is a native of China.
- *R. i. 7 aurantiacum* G. Don in Mill. Diet., 3. p. 846; A. i. aurantiaca *Hort.*—Flowers of orange red colour. A native of China.
- *R. i. 8 luteum* *Swt.*, Don's Mill., 3. p. 845; A. i. lutea *Hort.*; has double yellow flowers.
- *R. i. 9 spatulatum* Blum., Don's Mill., 3. p. 846; A. i. spatulata *Hort.*; has the leaves spatulate, mucronate, and beset with rusty strigæ. Flowers large, solitary, deep rose-coloured. Native of China and Japan.
- *R. i. 10 grandiflorum* Blum., Don's Mill., 3. p. 846; A. i. grandiflora *Hort.*; has the leaves oblong-spatulate, mucronate, beset with bristles, or strigæ. Flowers large, solitary, deep rose-coloured. A native of China and Japan.
- *R. i. 11 angustifolium* Blum., Don's Mill., 3. p. 846; A. i. angustifolia *Hort.*; has the leaves narrow-lanceolate.
- *R. i. 12 floribundum* Blum., Don's Mill., 3. p. 846; A. i. floribunda *Hort.*; has the leaves narrow, cuneate-lanceolate, beset with rusty strigæ. Stem much-branched. A native of China and Japan.
- *R. i. 13 Danielsianum*; A. i. Danielsiana *Paxton's Mag. of Bot.*, July, 1834; is a variety with considerable distinctness of habit of foliage, and flowers of a carmine colour, somewhat striped. It was introduced from China by Captain Daniels, in 1830, and plants may be had in the Sloane Street Nursery, and at Messrs. Loddiges's.
- *R. i. 14 lateritium*; A. i. lateritia *Lindl. Bot. Reg.*, t. 1700; has flowers of a bright clear brick colour, a little tinged with rose; and the plant is remarkably bushy, and abundant in leaves, which have a rusty tinge. It was introduced from China in 1823, by Mr. M'Killigan; and plants may be had in the Exotic Nursery, King's Road.
- *R. i. 15 variegatum* Blum., Don's Mill., 3. p. 846; A. i. variegata *Lindl.*; has the corollas variegated. This is a celebrated variety, which was long known to exist in China, from the drawings of it sent to Europe; and to procure which many attempts were made in vain, from nearly the commencement of the present century, till 1832, when it was at last brought alive to England, by the great care of Mr. M'Killigan, the pursuer of the ship Orwell, and an ardent admirer of plants. There are specimens of this variety in the Exotic Nursery. (See *Gard. Mag.*, 9. p. 474.)
- *R. i. 16 speciosum* D. Don, A. i. speciosa *Hort.*, is a hybrid, obtained by Mr. W. Smith in 1820, from seeds of A. indica, the flowers of which had been impregnated with the pollen of A. indica phœnicea. Two other varieties were raised by Mr. Smith at the same time, from the same stock of seeds, one of which frequently produces semidouble flowers. (See *Brit. Fl.-Gard.*, April, 1835; and *Gard. Mag.*, 11. p. 259.)



● 32. *R. SINENSIS* *Swt.* (A. SINENSIS *Lodd.*) The Chinese Azalea.

Identification. *Swt. Fl.-Gard.*, t. 290; Don's Mill., 3. p. 846.
Synonyme. Azalea sinensis *Lodd. Bot. Cab.*, t. 885.
Engravings. *Bot. Cab.*, t. 885; *Brit. Fl.-Gard.*, t. 290; and our fig. 957.

Spec. Char., &c. Leaves elliptic, acutish, pilosely pubescent, feather-nerved, with ciliated margins, canescent beneath; and, though deciduous, yet falling off so slowly, as to constitute it an imperfect evergreen. Corollas downy. Stamens equal in length to the limb of the corolla. Flowers flame-coloured, pentandrous. (*Don's Mill.*, 3. p. 846.) It is a native of China, where it grows from 3 ft. to 4 ft. high, and flowers in May and June. It was introduced in 1823; and is in very general cultivation in British gardens.

Varieties and Hybrids.

- *R. s. 2 flavescens* *Swt. Fl.-Gard.*, t. 290; A. s. 2 flavescens; has yellow flowers.
- *R. s. 3 macranthum* Don's Mill., 3. p. 846; Azalea macrantha *Bunge in Mém. Acad. Petersb.*, 2. p. 115; *R. nitens* D. Don *MSS.*—Leaves opposite, or 3 in a whorl, obovate or lanceolate, mucronulate,



shining, clothed with appressed bristles. Flowers pentandrous. Calycine segments lanceolate, acute, deeply toothed, bristly. Filaments glabrous. Stems several, rising from the rootstock, 2—4 ft. long, procumbent, naked. Branches fasciated, leafy at the tips, beset with appressed silvery bristles, which change to brown as well as the calyxes. Flowers solitary, or in pairs, nearly sessile, involucreted by bractees. Corollas large, of a brilliant salmon colour, glabrous outside; the limb spreading, with oblong blunt lobes; the upper lobes marked with deeper-coloured spots. (*Don's Mill.*, iii. p. 846.) There is a subvariety of this kind, having the flowers pale pink and striped. A procumbent shrub, from 2 ft. to 3 ft. high, a native of Japan, flowering in May and June. Introduced in 1833, but, at present, extremely rare in British gardens.

■ *R. reticulatum* D. Don's MSS., Don's Mill., 3. p. 846.; *A. reticulata* Hort. Leaves broadly ovate, acute, rather coriaceous, sparingly hairy, glaucous, and reticulately veined beneath. Stems erect, 1 ft. or 2 ft. high, stiff. Leaves stiff, $1\frac{1}{2}$ in. long, rounded at the base, bright green, and shining above, beset with a few appressed bristles, as well as the young shoots. This is a shrub, a native of Japan, on the mountains, where it grows from 1 ft. to 2 ft. high, which was introduced in 1834, by Mr. Knight of King's Road, Chelsea; but, as it has not yet flowered in England, very little is known about it.

■ *R. Farrereæ* Tate, *Sud. Fl.-Gard.*, 2d ser., t. 95., Don's Mill., 3. p. 846.; *A. Farrereæ* Hort.; and our fig. 958.; has the branches stiff, villous while young, but glabrous in the adult state. Leaves stiff, coriaceous, ovate, obtuse, ending in a short cartilaginous mucro, attenuated at the base, nerved, and reticulately veined, hairy on both surfaces, with somewhat recurved ciliated edges. Petioles ciliated at the base. Flowers terminal, solitary. Calyx pilose, 5-lobed. Corolla spreading, with undulated segments, lilac, or pale purple-red. It is a dwarf deciduous shrub, with deciduous flowers. A native of China, whence it was brought by Captain Farrer, in 1829. It flowers in March, but very little is known of its habit.

■ *R. decumbens* D. Don MSS., Don's Mill., 3. p. 846.; *A. decumbens* Hort.; has the stem decumbent; leaves ovate, acute; flowers pentandrous; segments of the calyx ovate, acute, ciliated; flowers crimson. (*Don's Mill.*, 3. p. 846.) It is a native of China, whence it was introduced by Knight and Tate in 1823. It flowers in April and May.



958

B. Indian Azaleas not yet introduced.

■ *R. scabrum* Don's Mill., 3. p. 846.; *A. scabra*; *R. maximum* Thunb. *Fl. Jap.*, p. 181.; has the leaves ovate, mucronulate, and acute at the base, coriaceous, and from $1\frac{1}{2}$ in. to 3 in. long. The flowers are of a deep rose colour, and bell-shaped, with the corolla 3 in. in diameter. It is a shrub, a native of Japan, in woods on mountains.

■ *R. mucronatum* G. Don; *A. mucronata* Blum. *Bijdr.*, p. 853.; is a shrub, a native of China; and, according to G. Don, "perhaps the same as *R. ledifolium*" (*A. i. Alba* Lindl.).

■ *R. Burmanni* G. Don; *A. rosmarinifolia* Burm. ex Blum. *Bijdr.*, p. 853., but not of Roth; has the leaves linear-lanceolate, long-acuminate, with recurved margins, clothed with silky down on both surfaces. Flowers pentandrous. It is a shrub, a native of Japan.

■ *R. mollis* G. Don; *A. mollis* Blum. *Bijdr.*, p. 853.; has the branches pilose; the leaves oblong-lanceolate, acute, narrowed at the base, ciliated, very soft beneath; the flowers in fascicles. Calyx very short. Tube clothed with silky tomentum. It is a shrub, a native of China.

■ *R. Lourciviana* G. Don; *A. punctata* Lour. *Coch.*, p. 113.; has the leaves lanceolate, quite entire, rugose about the edges, smooth. Corolla white, dotted with red, as also the calyx, anthers, and germs. Flowers terminal. (*Don's Mill.*, 3. p. 846.) It is a shrub, a native of Cochinchina, where it grows to the height of 4 ft. or 5 ft.

§ iv. Propagation and Culture of the half-hardy Species of *Rhododendron* and *Azalea*.

The soil best suited for these plants is heath mould, or peat as it is commonly called, mixed with fine loam and vegetable mould. For rearing plants from seed, and simply growing the species, such a compost, or even peat alone, or sandy loam, will suffice; but, for producing large plants, which shall flower profusely, the essence of rotted dung, or of some other manure in which animal matter is included, requires to be added. The splendid specimens of *Azalea* and *Rhododendron* which annually attract so much attention in the April and May exhibitions of our Horticultural Societies have, in general, all been grown in very rich soil, and often watered with liquid manure. The Indian azaleas more particularly require a rich soil, in order to flower freely and abundantly, and produce those splendid pyramids of blossoms which are so much admired at our shows. On the other hand, when the Indian species of *Rhododendron* and *Azalea* are to be treated as half-hardy, they ought to be grown in soil which is poor rather than rich, and kept dry, more especially in autumn, in order to insure the production of no more wood than can be ripened.

The situation most suitable for half-hardy rhododendrons and azaleas would appear to be a border in front of a wall facing the east; and because almost all the species of the order, and more especially all the Indian species of the genera *Rhododendron* and *Azalea*, are natives of woods on mountains, and thrive best when somewhat shaded. The best mode, where it is intended to have a good collection, and to display the plants to the greatest advantage, would be to plant them in a conservatory, with a movable roof and sides, both of which could be taken away in summer; or in an open space between two walls, built in the direction of north and south; and on which walls a temporary roof might be placed in the winter season, such as is recommended for the half-hardy *Leguminosæ* (p. 697.), and the half-hardy heaths (p. 1103.). If the Indian, or tree, rhododendrons were grown by themselves in the open ground, being evergreens, they might be covered, during winter, with a roof of boards or thatched hurdles, with only a few windows here and there, as is practised with orange trees in the north of Italy, and sometimes also Paris.

Propagation. The Indian tree rhododendrons are propagated by layers, or by grafting on *R. ponticum* or *R. catawbiense*; and they may also, though with difficulty, be increased by cuttings of the growing wood, planted in sand, and then closely covered with a bell-glass, and put into heat. All the Indian azaleas are very readily propagated by cuttings of the young wood. Both rhododendrons and azaleas ripen seeds in our green-houses; and these should be sown immediately after being gathered, or very early in the spring, in flat pans or pots filled with sandy peat, or peat mixed with a little loam and sand. The seeds should be covered as slightly as possible, and then placed in a very

gentle heat in a frame, or in a shady and moist part of a green-house, taking care that, as soon as the plants begin to come up, they may be placed close to the glass to receive the direct influence of the light, shading them, at the same time, from the sun's rays. The greatest care should be taken to keep the temperature and moisture as equal as possible, and to expose the tender seedlings to the morning and afternoon light; but to exclude the mid-day sun. As soon as the plants have got two or three leaves, they should be transplanted into other pans or pots, filled with the same kind of soil, and shifted into pots of a larger size as soon as these are nearly filled with the roots. This process may be continued for two or three years, when the plants will have attained the height of from 2 ft. to 4 ft., accordingly as they have been kept in a higher or lower temperature. The azaleas may be forced forward with the heat of a stove, so as to make two, or even three, shoots in a year; but the rhododendrons do not so readily admit of expeditious culture. Both rhododendrons and azaleas, whether of the hardy or half-hardy species, force readily; and, by that process, or retardation, may be made to flower at any season of the year.

GENUS XXI.

KAL'MIA L. THE KALMIA. *Lin. Syst. Decándria Monogýnia.*

Identification. *Lin. Gen.*, No. 545; *Gærtn. Fruct.*, 1. p. 305. t. 63.; *Juss. Gen.*, 158.; *Nutt. Gen. Amer.*, 1. p. 267.; *Don's Mill.*, 3. p. 850.

Synonymy. American Laurel.

Derivation. Named by Linnæus in honour of *Peter Kalm*, professor at Abo, in Sweden; author of *Travels in America* in 1753.

Description. Low evergreen shrubs, highly ornamental in their foliage and flowers; natives of North America; of easy culture in peaty soil, and propagated by layers, seeds, or cuttings.

■ 1. K. LATIFO'LIA L. The broad-leaved Kalmia.

Identification. *Lin. Sp.*, 560.; *Bigel. Med. Bot.*, p. 133.; *Pursh Fl. Amer. Sept.*, 1. p. 296.; *Don's Mill.*, 3. p. 850.; *Lodd. Cat.*, ed. 1836.

Synonymy. Mountain Laurel, Calico Bush, Calico Flower, *Amer.*

Engravings. *Curt. Bot. Mag.*, t. 175.; *Waugh. Amer.*, t. 25. f. 50.; *Catesb. Car.*, 2. t. 98.; *Trew Ehrh.*, t. 38. f. 1.; *Pluk. Mant.*, t. 379. f. 6.; and our fig. 959

Spec. Char., &c. Leaves on long petioles, scattered, or 3 in a whorl, oval, coriaceous, smooth, and green on both surfaces. Corymbs terminal, downy, and viscid. (*Don's Mill.*, iii. p. 850.) Flowers white, tinted with pale pink, delicately spotted. A shrub, very elegant when in flower, growing to the height of from 3 ft. to 10 ft.; a native of North America, from Canada to Carolina, on the sides of stony hills. It was introduced in 1734, and flowers in June and July. This shrub, in its native soil, continues flowering great part of the summer; and, according to Kalm, forms one of the greatest ornaments of those parts of America where it is indigenous; and it is only in particular places where it thrives; though, according to Michaux, on the Alleghanies it occupies tracts of more than 100 acres. These are generally rocky, sterile, and near water. After it was introduced into England, it was for several years very unsuccessfully cultivated, till Mr. Peter Collinson procured some plants of it from Pennsylvania, where the climate being nearer to that of England, than either that of Carolina or Virginia, the plants obtained from it grew vigorously, and flowered in Mr. Catesby's garden at Fulham, for the first time in England, in 1741. Leaves of this species are poisonous to cattle and sheep, but not to deer. The wood is very hard, and is used by the Indians for making spoons and other domestic utensils. Michaux states that, of all the American woods, that of the *Kalmia latifolia* the most nearly resembles the European box; so that it might be probably worth while to import it for the use of wood-engravers.

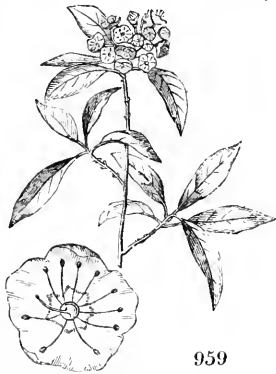

959

■ 2. *K. ANGUSTIFOLIA* L. The narrow-leaved Kalmia.

Identification. Lin. Sp., 561.; Pursh Fl. Amer. Sept., 1. p. 296.; Don's Mill., 3. p. 850.; Lodd. Cat., ed. 1836.

Synonymy. Sheep Laurel, Amer.

Engravings. Curt. Bot. Mag., t. 331.; Lodd. Bot. Cab., t. 502.; Catesb. Car., 3. t. 17. f. 1.; Trew Ehrh., t. 38. f. 2.; and our fig. 960.

Spec. Char., &c. Leaves petiolate, scattered, or 3 in a whorl, oblong, obtuse, rather rusty beneath. Corymbs lateral. Bracteas linear. Peduncles and calyxes clothed with glandular pubescence. (*Don's Mill.*, iii. p. 850.) Flowers dark red. This shrub is called sheep laurel, because it is considered poisonous to sheep. A shrub, growing from 1 ft. to 2 ft. high; a native of North America, from Canada to Carolina, in bogs, swamps, and sometimes in dry mountain lands. It was introduced in 1736, and flowers from May to July.



Variety.

- *K. a.* 2 *ovata* Pursh Fl. Amer. Sept., i. p. 296., is a native of New Jersey, on the mountains, with broader leaves and a taller stem.

■ 3. *K. GLAUCA* Ait. The glaucous-leaved Kalmia.

Identification. Ait. Hort. Kew., ed. 2., p. 61.; Pursh Fl. Amer. Sept., 1. p. 296.; Don's Mill., 3. p. 850.

Synonymy. *K. polifolia* Wagh. Act. Soc. Berol., 8. p. 129. t. 5.

Engravings. Curt. Bot. Mag., t. 177.; Lam. Ill., t. 363.; L'Hérit. Stirp. Nov., 2. t. 9.; Lodd. Bot. Cab., t. 1568.; Wagh. Act. Soc. Berol., 8. p. 129. t. 5.; and our fig. 961.

Spec. Char., &c. Branchlets somewhat 2-edged. Leaves opposite, on short petioles, oblong, smooth glaucous beneath, with revolute edges. Corymbs terminal, compound, bracteate. Pedicels and calyxes glabrous. (*Don's Mill.*, iii. p. 850.) A very handsome, upright, small shrub, from 1 ft. to 2 ft. high, with pale red flowers. According to Nuttall, the flowers are disposed in terminal compound corymbs, each corymb composed of 3 racemose corymbules; and the pedicels and calyxes are said by him to be clothed with powdery viscid pubescence. A native of the bogs of Canada, and on the borders of the mountain lakes of New York and Pennsylvania, and of the Island of Sticha. It was introduced in 1767, and flowers in April and May. The flower is comparable to a miniature parasol: the corolla to the covering, the stamens to the rays that keep the covering distended, and the style to the handle.



Variety.

- *K. g.* 2 *rosmarinifolia* Pursh Fl. Amer. Sept., i. p. 296.—Leaves linear, more revolute on the margins, and having the under surface green. Mr. Pursh discovered this variety in a bog near Albany, and is inclined to think it a distinct species.

■ 4. *K. CUNEATA* Michx. The wedge-shaped-leaved Kalmia.

Identification. Michx. Fl. Bor. Amer., 1. p. 257.; Pursh Fl. Amer. Sept., 1. p. 296.; Don's Mill., 3. p. 850.

Spec. Char., &c. Leaves scattered, sessile, cuneate-oblong, glandularly pubescent beneath, minutely armed at the apex. Corymbs lateral, few-flowered. Branches twiggy. Leaves deciduous. Flowers white, red at the bottom, disposed in sessile, lateral, fastigiate clusters. (*Don's Mill.*, iii. p. 850.) A shrub, 1—2 ft. high, a native of Carolina, on the mountains. It was introduced in 1820, and flowers in May and June.

■ 5. *K. HIRSU'TA* Walt. The hairy Kalmia.

Identification. Walt. Fl. Carol., 138.; Pursh Fl. Amer. Sept., 1. p. 296.; Michx. Fl. Bor. Amer., 1. p. 257.; Curt. Bot. Mag., t. 138.

Synonymy. *K. ciliata* Bartr. Itin., 18.

Engravings. Curt. Bot. Mag., t. 138.; and our fig. 962

Spec. Char., &c. Branches, leaves, and calyxes very hairy.

Leaves opposite and alternate, almost sessile, elliptic. Peduncles axillary, solitary, 1-flowered, longer than the leaves. (*Don's Mill.*, iii. p. 850.) A beautiful little shrub, but difficult to cultivate; growing to the height of from 2 ft. to 3 ft. Leaves small, like thyme. Flowers large, red. A native of South Carolina and Georgia, in barren pine woods. It was introduced in 1786, and flowers from June to August. From the small size of the leaves, and the diminutive habit of growth of the plant, it might be admitted among the genus *Erica*, in what might be called a miscellaneous ericetum; taking care to plant it in a suitable soil.



962

GENUS XXII.



MENZIE`SIA Smith. THE MENZIESIA. *Lin. Syst.* Octándria Monogýnia.

Identification. Smith Icon. ined., 56; Nutt. Gen. Amer., 1. p. 251; D. Don in Edin. Phil. Journ. 17. p. 170.

Derivation. Named in honour of *Archibald Menzies*, F.L.S., &c., surgeon and naturalist to the expedition under Vancouver; in which he collected many specimens of plants on the north-west coast of America, New Holland, Van Diemen's Land, &c.

Description. Deciduous shrubs, natives of North America.

❖ 1. *M. FERRUGÍ`NEA* Smith. The rusty-flowered Menziesia.

Identification. Smith Icon. ined., 1. p. 56. t. 56.; Pursh Fl. Amer. Sept., 1. p. 264; Don's Mill., 3. p. 850.

Synonymy. *M. urceolaris* Salisb. *Par. Lond.*, No. 44.

Engravings. Smith Icon. ined., 1. p. 56. t. 56.; and our fig. 963.

Spec. Char., &c. Corolla urceolate, with rounded lobes.

Leaves and branches hairy. Leaves obovate-lanceolate. Flowers of a rusty colour. (*Don's Mill.*, iii. p. 850.) A shrub, growing to the height of from 3 ft. to 4 ft.; a native of the north-west coast of America, particularly on the Columbia River, and on the Island of Sitcha. It was introduced in 1811, and flowers in May and June.



963

❖ 2. *M. GLOBULA`RIS* Salisb. The globular-flowered Menziesia.

Identification. Salisb. *Par. Lond.*, t. 44; Pursh Fl. Amer. Sept., 1. p. 264; Don's Mill., 3. p. 850.

Synonymes. *M. Smithii* Michx. Fl. Bor. Amer., p. 235; *Azalea pilösa* Lam. *Ill.*, 494; *M. pilösa* Pers. *Ench.*, 1. p. 420.

Spec. Char., &c. Corolla globose, with rounded lobes; leaves and branches hairy. Leaves lanceolate. Flowers yellowish brown. (*Don's Mill.*, iii. p. 850.) A shrub, growing to the height of from 3 ft. to 5 ft.; a native of Virginia and Carolina, on high mountains; plentiful on the Cacapoore Mountains, near Winchester, in Virginia. It was introduced in 1806, and flowers in May and June.

GENUS XXIII.



AZA`LEA D. Don. THE AZALEA. *Lin. Syst.* Pentándria Monogýnia.

Identification. D. Don in Edinb. Phil. Journ.; Don's Mill., 3. p. 830.

Synonymes. *Azalea procumbens* Lin. and many authors; *Loiseleuria* Desf.; *Chamaledon* Link *Enum.*, 1. p. 210.

Derivation. From *azaleos*, dry, or arid; in reference to the habitation of the plant.

Description. A diminutive, procumbent, evergreen shrub, a native of Britain and North America.

* 1. A. PROCUMBENS L. The procumbent Azalea.

Identification. Lin. Sp., 205; Pursh Fl. Amer. Sept., 1. p. 154; Don's Mill., 3. p. 851.

Synonymes. Chamæledon procumbens Link Enum., 1. p. 210.; Loiseleuria procumbens Desf.

Engravings. Fl. Dan., t. 9.; Lin. Fl. Lapp., ed. 2., p. 60. t. 6. f. 2.; Eng. Bot., t. 865.; Lodd. Bot. Cab., t. 762.; Bot. Misc., 2. p. 64. t. 53.; and our fig. 964.

Geography, &c. Native of Europe, on mountains; plentiful on the tops of mountains in Scotland, but rare on the mountains in the north of England. In North America, it is found wild in the alpine regions of the White Mountains, New Hampshire, and on Grandfather Mountain, Carolina, &c. A procumbent shrub, flowering in April and May, and requiring to be grown in sandy peat, either in a border or in pots, and in an airy situation. The flowers are small, and rose-coloured; and, according to Pursh, do not appear in Carolina till July. The same author says, "This plant has so much affinity to *Lêdum buxifolium* Ait. (*Leiophyllum thymifolium* Pers.), that I have scarcely been able to persuade myself that they are distinct plants. Comparing specimens of different varieties of the latter, with those of *A. procumbens* from different countries, in Mr. Lambert's herbarium, I could find no other distinction between both, than that of the *Lêdum* being an upright little shrub, with decandrous flowers, which are white, whereas the present species has procumbent stems, and pentandrous red flowers. It most certainly ought to be taken from this genus, or else all the rest but this one united with *Rhododéndron*." (*Pursh Fl. Amer. Sept.*, i. p. 155.) This has been done by Mr. David Don, in his new arrangement of the order *Ericacææ*, which has been adopted in G. Don's *Mill.*, and which we have followed.



GENUS XXIV.



LEIOPHYLLUM Pers. THE LEIOPHYLLUM. Lin. Syst. Decándria Monogýnia.

Identification. Pers. Ench., 1. p. 477.; Spreng. Syst. 2. p. 276.; Don's Mill., 3. p. 851.

Synonymes. Ammýrsine Pursh Fl. Amer. Sept., 1. p. 280.; Fischera Swartz; *Lêdum buxifolium* Berg., Ait.

Derivation. From *leios*, smooth, and *phylton*, a leaf; in reference to the smoothness of the leaves.

Description. Diminutive, but erect, evergreen shrubs, natives of North America, on mountains.

* 1. L. THYMIFOLIUM Pers. The Thyme-leaved Leiophyllum.

Identification. Pers. Ench., 1. p. 477.; Spreng. Syst., 2. p. 215.; Don's Mill., 3. p. 831.

Synonymes. *Lêdum buxifolium* Bergius in Act. Petrop., 1779, p. 1. t. 3. f. 2., Ker Bot. Reg., t. 531.,

Ait. Hort. Kew., 2. p. 66., Lodd. Bot. Cab., t. 52.; *Lêdum thymifolium* Lam. Dict., 3. p. 459., and Ill., t. 363. f. 2.; *Lêdum serpyllifolium* L'Hérit. Stirp. Nov., 2. t. 10.; Ammýrsine buxifolia Pursh Fl. Amer. Sept., 1. p. 301.; Sand Myrtle, New Jersey.

Engravings. Bergius in Act. Petrop., 1777, p. 1. t. 3. f. 2.; Bot. Reg., t. 531.; Ait. Hort. Kew., 1. p. 66.; Lodd. Bot. Cab., t. 52.; Lam. Ill., t. 363., f. 2.; L'Hérit. Stirp. Nov., 2. t. 10.; and our fig. 965.

Description, &c. A shrub, from 6 in. to 1 ft. high, a native of New Jersey, and the mountains of Carolina, particularly on the highest summits of the Catawba ridge. It is an elegant little shrub, growing in its native habitats, according to Pursh, to the height of about 6 in., and sometimes a foot; the delicacy of its leaves, and abundance



of its white flowers, rendering it highly ornamental. It was introduced in 1736, and flowers in May and June.

L. prostratum; Ammýrsine prostrata *Swt., Loud. Hort. Brit.*, No. 28221.; *A. Lyoni Swt. Hort. Brit.*, ed. 1830, p. 344.—Branches spreading. Leaves oblong. We had this plant some years ago, but have now lost it. It appeared distinct from *L. thymifolium Pers.*; but, whether specifically so or not, we are uncertain.

GENUS XXV.



LÈDUM L. THE LEDUM. *Lin. Syst. Decándria Monogýnia.*

Identification. *Lin. Gen.*, No. 546.; *Gærtn. Fruct.*, 2. p. 145. t. 112.; *Juss. Gen.*, 159.; *Nutt. Gen. Amer.*, 1. p. 275.

Derivation. *Lèdon* was the name applied by the ancients to a plant producing the substance called labdanum, and now known by the name of *Cistus Lèdon*. In foliage, the *Lèdum* of modern botanists bears some distant resemblance to the plant of the ancients.

Description, &c. Evergreen shrubs of small size, or decumbent; natives of Europe and North America.

1. *L. PALU'STRE L.* The Marsh Ledum.

Identification. *Lin. Sp.*, 651.; *Cæd. Fl. Dan.*, t. 1031.; *Pursh Fl. Amer. Sept.*, 1. p. 300.; *Don's Mill.*, 3. p. 851.

Synonymes. *Lèdum silesiacum Clus. Pan.*, 68.; *Rosmarinum sylvés-tre Cam. Epit.*, 546.

Engravings. *Du Ham. Arb.*, 1. t. 67.; *Schmidt Baum.*, t. 136.; *Lodd. Bot. Cab.*, t. 560.; *Hayne Abbild.*, t. 57.; and our *fig. 966.*

Spec. Char., &c. Leaves linear, with revolute margins, clothed with rusty tomentum beneath. Stamens 10, longer than the corolla. Flowers white. Leaves resembling those of rosemary. (*Don's Mill.*, iii. p. 851.) A shrub, 2 ft. high; a native of Canada, in swamps, and round the mountain lakes of New York; in Kotzebue's Sound, &c.; also of the north of Europe, as of Denmark, Silesia, &c. It was introduced in 1762, and flowers in April and May.

Variety.

- 1. *L. p. 2 decumbens Ait. Hort. Kew.*, ed. 2., vol. iii. p. 48., is a decumbent shrub, a native of Hudson's Bay.



966

2. *L. LATIFOLIUM Ait.* The broad-leaved Ledum, or Labrador Tea.

Identification. *Ait. Hort. Kew.*, 2. p. 65.; *Pursh Fl. Amer. Sept.*, 1. p. 300.; *Don's Mill.*, 3 p. 851.

Synonymes. *L. grœnlândicum Retz. Obs.*, 4. p. 26., *Fl. Dan.*, t. 567.; *L. palustre Michx. Fl. Bor. Amer.*, 1. p. 259.; *Labrador Tea, Amer.*

Engravings. *Jacq. Icon.*, 3. t. 464.; *Schmidt Baum.*, t. 164.; *Lam. Ill.*, t. 363.; *f. 1.*; *Lodd. Bot. Cab.*, t. 534.; *Fl. Dan.*, t. 567.; and our *fig. 967.*

Spec. Char., &c. Leaves linear-oblong, with replicate margins, clothed with rusty tomentum beneath. Stamens 5, about the length of the corolla. Flowers white. (*Don's Mill.*, iii. p. 857.) A larger and broader-leaved shrub than *L. palustre*; growing to the height of from 2 ft. to 4 ft.; the leaves of which are said to be used, in Labrador, as a substitute for tea. Bees are very fond of the flowers. A native of Canada, in mossy swamps; and of Greenland, Labrador, Newfoundland, and Hudson's Bay. This, or the preceding species, has lately been found in Ireland. It was introduced in 1763, and flowers in April and May.



967

2. 3. *L. CANADENSE* Lodd. The Canadian Ledum.

Identification. Lodd. Bot. Cab., t. 1049.; Don's Mill., 3. p. 851.
Engravings. Lodd. Bot. Cab., t. 1049.; and our fig. 968.

Spec. Char., &c. Leaves ovate-petiolate, white beneath. Flowers disposed in terminal umbellate corymbs, large. Flowers white. (*Don's Mill.*, iii. p. 851.) A shrub, from 3 in. to 6 in. high; a native of Canada, in swamps; and flowering in April and May. It is in cultivation in British gardens, but the year of its introduction is uncertain.



968

Sect. III. *VACCINIÆ* D. Don.

Identification. D. Don in Edinb. Phil. Journ., 17. p. 152.; Don's Mill., 3. p. 851.

Sect. Char., &c. Anthers 2-celled. Ovary connate with the calyx. Disk perigynous, nectariferous. Fruit baccate. Gemmation scaly. The genera in this section agree with *Vaccinium* in the ovary adhering to the calyx. (*Don's Mill.*, iii. p. 851.) Deciduous and evergreen shrubs, natives of Europe and North America; cultivated in peat soil, and propagated, generally, by division of the plant, but sometimes by layers, and, when necessary, by cuttings or seeds.

GENUS XXVI.



VACCINIUM L. THE WHORTLEBERRY. *Lin. Syst.* Oct-Decándria Monogýnia.

Identification. Lin. Gen., 291.; Ait. Hort. Kew., 2. p. 555.; Pursh Fl. Bor. Amer., 1. p. 282.; Juss. Gen., 162.; Nutt. Gen. Amer., 1. p. 263.; Lam. III., 286.; Gertn. Fruct., t. 28.; Don's Mill., 3. p. 851.

Synonymes. *Vitis idæa* Tourn. Inst., t. 377.; Airelle, Fr.; Heidelbeere, Ger.

Derivation. An ancient Latin name, but whether of a berry or a flower, has been a point in dispute among critics, as well as its etymology.

Description. The species are shrubs, varying in height from 6 in. to 10 ft., some natives of Europe, but the greater part of North America. They are gemmaceous, with the bud scales often permanent on the base of the small branches; and the leaves often beset with resinous dots. The flowers are pedicellate, and either in solitary racemes, or in tufts. They are generally drooping, inodorous, tinted with various shades of red or pink, never blue, and scarcely ever yellow. They are succeeded by berries, black, purple, bluish, or red, covered with a fine bloom, generally eatable: some of them agreeable, and excellent in tarts; and others austere, acid, and scarcely wholesome in a raw state. In general, it may be observed, that the species are in a good deal of confusion, from the whole of them never having been studied together in the same garden. We have followed the arrangement of G. Don, as the latest and best, not having had an opportunity ourselves of examining all the species said to be in cultivation in British gardens. The best collection of large plants of the genus *Vaccinium*, in England, is at White Knights; and of plants for sale, at Messrs. Loddiges's. Price, of the common sorts, from 1s. 6d. to 2s. 6d. each; of the rarer kinds, from 3s. to 5s. each.

A. *Leaves deciduous.*

a. *Pedicels 1-flowered, usually solitary, rarely twin, or fasciculate.*

1. *V. MYRTILLUS* L. The Little-Myrtle-like Whortleberry, or common Bilberry, or Bleaberry.

Identification. Lin. Sp., 498.; Ger. Emac., 1415.; Matth. Valgr., 1. p. 410.; Cam. Epit., 135.; Smith Eng. Fl., 2. p. 219.; Don's Mill., 3. p. 851.; Lodd. Cat., ed. 1826.

Engravings. Engl. Bot., t. 456.; Fl. Dan., t. 974.; and our fig. 969.

Spec. Char., &c. Pedicels solitary, 1-flowered. Leaves serrated, ovate, smooth.

Stem acutely angular, smooth. Calyx hardly divided. Corolla globose, generally 5-cleft, of a very delicate, waxy, pink hue. (*Don's Mill.*, iii. p. 852.) A shrub, from 6 in. to 2 ft. high; a native of heaths, stony moors, and mountain woods, throughout most parts of Europe, especially the more northern countries; and also in the north of Africa and Asia; and at Nootka Sound and Nova Scotia, in America. It is plentiful in Britain and Ireland, and also in Iceland. According to H. C. Watson, it becomes procumbent about the subalpine zone in England, and rarely produces flowers. Only the loftiest mountains in Scotland rise sufficiently high to arrest its ascent. It is seen on the summit of Ben Lawers, 4000 ft. above the level of the sea, and on some other mountains rather higher. In general, it grows at elevations of from 200 ft. to 600 ft. higher than *Empetrum nigrum*. It is found in every country in Britain, from Cornwall to Caithness, least frequently in the south-eastern countries, and increases in quantity as we advance northward. "This is one of the species," Mr. Watson observes, "that, if allowed, would overrun Britain, and form, with *Calluna vulgaris* and *Empetrum nigrum*, much of the natural physiognomical character of its vegetation." (*Outlines, &c.*, p. 201.) The berries of this species are of a bluish black, about the size of currants, and covered with a mealy bloom: they are eaten in tarts, or with cream, or made into jelly, in the northern and western counties of England and Scotland; and, in other parts of the country, they are made into pies and puddings. In Devonshire, the berries are eaten with clotted cream; in Poland, mixed with wood strawberries, and eaten with new milk, they are considered a great delicacy. Their juice has been employed to stain paper or linen purple. In autumn, many kinds of game live upon their berries, and the plant affords them shelter. In gardens, it may be cultivated in sandy peat, kept moist, in a situation airy, but somewhat shaded.



969

Variety.

✻ *V. M. 2 baccis albis* has white fruit. At the moment when we were writing this article (June 6. 1836), Mr. John Booth of the Floetbeck Nursery, near Hamburg, called on us, and, among other information, stated that a patch of 154 plants of this variety had lately been discovered in the Black Forest, and that he had plants of it for sale.

Mr. Menzies brought from the west coast of North America specimens of what may be considered as a gigantic variety of *V. Myrtillus*, which he found growing there to the height of 7 ft. or 8 ft.; but it has not yet been introduced.

✻ 2. *V. ULIGINOSUM* L. The bog Whortleberry, or great Bilberry.

Identification. Lin. Spec., 499; Smith Eng. Fl., 2. p. 210.; Don's Mill., 3. p. 851.; Lodd. Cat., ed. 1836.
Synonymy. *Myrtillus grandis* *Bauh. Hist.*, 1. p. 518.
Engravings. Eng. Bot., t. 581.; Fl. Dan., t. 231.; and our fig. 970.

Spec. Char., &c. Pedicels somewhat aggregate, 1-flowered. Leaves obovate, entire, smooth. Branches terete. Taller than the common bilberry, and of a more glaucous hue. Leaves glaucous beneath. Flowers flesh-coloured, with 8 long-horned stamens. Berries large, juicy, black, and covered with a mealy bloom. (*Don's Mill.*, iii. p. 852.) A shrub, about 2 ft. high; a native of Sweden, Germany, Siberia, Switzerland, Savoy, Scotland, and the north of England; as well as in the more northern parts of America, and on its west coast; and on the Island of Sitcha, and in the north of Asia, in marshy mountain heaths and alpine bogs. In Scotland,

it flourishes, at an elevation of between 2000 ft. and 3000 ft., on the Grampians; and at the height of 3500 ft. in Aberdeenshire. It is said to cover extensive tracts of land on the west coast of Greenland, along with *Andr meda tetrag na*. (*Cassiope tetragona* *D. Don*). On the Carpathian Mountains, it grows at an elevation of 6000 ft. (*Watson*.) It produces its flowers in April and May. The berries are agreeable, but inferior in flavour to those of *V. Myrtilillus*: eaten in large quantities, they occasion giddiness, and a slight headache. In France, they are used to colour wines red; and in Siberia and Sweden they furnish an ardent spirit that is highly volatile and intoxicating. They afford excellent sustenance to game. The leaves are added to *Lycopodium alpinum* by the Icelanders; and a yellow dye, for colouring woollens, is produced by an infusion of the two plants. In gardens, it may be cultivated like the preceding species.



3. *V. ANGUSTIFOLIUM* *Ait.* The narrow-leaved Whortleberry.

Identification. *Ait. Hort. Kew.*, ed. 2., vol. 2. p. 356.; *Don's Mill.*, 3. p. 852.

Synonyme. *V. myrtilloides Michx. Fl. Bor. Amer.*, 1. p. 234., *Hook. in Bot. Mag.*, t. 3447.

Engraving. *Bot. Mag.*, t. 3447.

Spec. Char., &c. Pedicels scattered, mostly solitary, 1-flowered, naked. Leaves lanceolate, nearly entire, downy at the ribs and margins. Berries large, and known by the name of bluets. (*Don's Mill.*, iii. p. 852.) A shrub, nearly 2 ft. high; a native of Canada, about Hudson's Bay and Labrador; and of the high alpine woods of the Rocky Mountains, from the Atlantic to the Pacific. It was introduced in 1776, and flowers in April and May. In the Glasgow Botanic Garden it grows about 1 ft. high. The corolla is remarkable for its flagon-shaped appearance, and is of a pale yellowish green or white, tinged with red. The fruit is large, globose, blackish purple, and is highly esteemed by the inhabitants of the countries where the plant is indigenous.

4. *V. CESPITOSUM* *Michx.* The tufted Whortleberry.

Identification. *Michx. Fl. Bor. Amer.*, 1. p. 234.; *Don's Mill.*, 3. p. 852.

Engraving. *Bot. Mag.*, t. 3429.

Spec. Char., &c. Flowers lateral, solitary, nearly sessile. Leaves somewhat wedge-shaped, rounded, obtuse, serrated, membranous, very smooth. A little shrub, with many crowded stems, from 2 in. to 4 in. high, very smooth in every part. Corolla of a short urceolate form. Berries nearly sessile, globose, and blue black, with a glaucous bloom. (*Don's Mill.*, iii. p. 853.) It is a native of America, particularly about Hudson's Bay; and also in the Island of Sitcha, and on the Rocky Mountains. It was introduced in 1823, and flowers in May. In the Glasgow Botanic Garden the blossoms of this species are numerous, and exceeding delicate and beautiful, being white, with a deep tinge of blush.

b. *Flowers in sessile Tufts.*

5. *V. GALEZANS* *Michx.* The Gale-like Whortleberry.

Identification. *Mich. Fl. Bor. Amer.*, 1. p. 232.; *Don's Mill.*, 3. p. 853.

Synonyme. *V. galiformis Smith in Rees's Cycl.*, No. 16.

Spec. Char., &c. Flowers on very short stalks, in sessile tufts. Leaves sessile, lanceolate-wedge-shaped, slightly serrated, downy. Calyx pointed. Corollas ovate, much contracted at the mouth. Style prominent. Flowers small, yellowish white. Berries small, globular, black. *Michaux* describes this shrub as having the aspect of *Myrica Gale*, with slight downy branches. Leaves varying. The pedicels, shorter than the flowers, burst from a bud composed of numerous crowded scales. (*Don's Mill.*, iii. p. 853.) A shrub, growing to the height of 2 ft.; a native of Virginia and Carolina, in shady woods and swamps. It was introduced in 1806, and flowers in May and June.

6. *V. TENELLUM* *Ait.* The delicate Whortleberry.

Identification. *Ait. Hort. Kew.*, ed. 2., vol. 2. p. 358.; *Don's Mill.*, 3. p. 853.

Synonyme. *V. pennsylvanicum Lam. Dict.*, p. 74., *Michx. Fl. Bor. Amer.*, 1. p. 232., *Hook. in*

Bot. Mag.

Engravings. *Wats Dend. Brit.*, t. 35.; *Bot. Mag.*, t. 3434.; and our fig. 971

Spec. Char., &c. Flowers in dense sessile tufts. Leaves nearly sessile, ovate-lanceolate, acuminate, finely serrated, smooth, except the rib and margins. Branches angular, with a downy line on each side. Calyx of 5 deep, acute segments. A low very branching shrub. Corollas pale red, or white. Berries large, bluish black, extremely sweet, and agreeable to eat. (*Don's Mill.*, iii. p. 853.) A shrub, 2 ft. high; a native from New England to Virginia, on dry hills, on a gravelly soil. It was introduced in 1772, and flowers in May. There are plants in the Glasgow Botanic Garden, and at Messrs. Loddiges's.



Variety. The mountains of Pennsylvania produce an immense variety of this species, remarkable for the size and shape of the fruit, leaves, and flowers. Leaves sometimes 1 in. long. (*Don's Mill.*)

7. *V. LIGUSTRINUM Michx.* The Privet-like Whortleberry.

Identification. Michx. Fl. Bor. Amer., 1. p. 283; Don's Mill., 3. p. 853.

Spec. Char., &c. Flowers in tufts, and nearly sessile; as are the leaves, which are also erect, lanceolate, mucronate, finely serrated, veiny and downy. Corolla longish and ovate. Branches angular. (*Don's Mill.*, iii. p. 853.) An erect shrub, from 2 ft. to 3 ft. in height, with membranous leaves, furnished with conspicuous, often purple, veins. Scales of the flower buds often purplish. Corollas purplish red. Berries black. The leaves vary extremely in shape and size. It is a native of North America, from Pennsylvania to Virginia, in dry woods, common on the mountains; and flowering from May to July. There are plants of it at Messrs. Loddiges's.

c. *Flowers disposed in Racemes.*

8. *V. PALLIDUM Ait.* The pale-flowered Whortleberry.

Identification. Ait. Hort. Kew., ed. 2., vol. 2. p. 355; Don's Mill., 3. p. 853.

Spec. Char., &c. Racemes bracteate. Corolla cylindrically bell-shaped. Leaves ovate, acute, finely serrated. (*Don's Mill.*, iii. p. 853.) This low shrub is a native of North America, whence it was said to have been sent, in 1772, to the Kew Gardens, by Dr. Samuel Martin; but Pursh never met with it in a wild state in America. It grows to the height of about 2 ft., and flowers in May and June. We believe it is not now to be found in British gardens.

9. *V. ARBOREUM Marsh.* The Tree Whortleberry.

Identification. Marsh. in Michx. Fl. Bor. Amer., 1. p. 290; Don's Mill., 3. p. 853; Lodd. Cat., ed. 1836.

Synonymy. *V. diffusum Ait. Hort. Kew.*, ed. 2., 2. p. 356.

Engraving. Bot. Cab., t. 1885.

Spec. Char., &c. Pedicels axillary and solitary, or terminal and racemose, naked. Leaves ovate, acute, with slight glandular serratures, polished above, and rather downy beneath. Corollas bell-shaped, acute. Stamens the length of the tube. Corollas white, tinged with red. Berries globular, black, almost dry. Branches terete, downy while young. (*Don's Mill.*, iii. p. 853.) This species joins the solitary-flowered species with the racemose-flowered species; the axillary flowers being solitary and pedicellate, and the terminal ones racemose. A native of North America, from North Carolina to Florida, in dry woods, on the rocky banks of rivers; where it grows to the height of from 10 ft. to 20 ft., forming a very elegant shrub, which flowers in May and June. It was introduced in 1765, and is occasionally to be met with in collections. There is a plant of this species, 10 ft. high, in the walled garden at White Knights, and there are plants at Messrs. Loddiges's.

10. *V. STAMINEUM L.* The long-stamened Whortleberry.

Identification. Lin. Sp., 498; Don's Mill., 3. p. 853.

Synonymy. *V. album Pursh Fl. Amer. Sept.*, 1. p. 285; *V. elevatum Banks Herb.*, Lodd. Cat.,

Pluk. Mant., 92., *Phyt.*, t. 339., f. 3.

Engravings. Andr. Bot. Rep., t. 263.; and our fig. 972.

Spec. Char., &c. Racemes downy, with oval bracteas as long as the flowers. Anthers 2-horned on the back, twice as long as the spreading bell-shaped corolla. Leaves elliptic, acute, entire, glaucous, and rather downy beneath. Stem 2 ft. high, with numerous green branches, which are downy while young. Leaves $1\frac{1}{2}$ in. or 2 in. long, on very short downy stalks. Flowers decandrous, copious, white, having linear anthers, which are horned near the base. Berries greenish, or white, called deer-berries. The bracteas resemble the leaves, but are much smaller.

972



(*Don's Mill.*, iii. p. 853.) It is a shrub; native of North America, from New England to Florida, where it grows from 1 ft. to 2 ft. high, and flowers in May and June. It was introduced in 1772; and there are plants, both of the species and the variety, at Messrs. Loddiges's.

Variety.

- α *V. s. 2 album* H. B. et Kunth Nov. Gen. Amer., iii. p. 267.—The leaves are larger, and ciliated on the nerves beneath, and on the margins. Corolla campanulate and white. It is a native of Mexico, in woods, between Pachuca and Real del Monte, where it seldom grows above 6 in. high.

- α II. *V. dumosum* Ait. The bushy Whortleberry.

Identification. Ait. Hort. Kew., ed. 2., vol. 2. p. 356.; Don's Mill., 3., p. 853.

Synonymes. *V. irondosum* Michx. Fl. Bor. Amer., 1. p. 230.; *V. hirtellum* Ait. Hort. Kew., ed. 2., vol. 2. p. 357.

Engravings. Curt. Bot. Mag., t. 1106.; Andr. Bot. Rep., t. 112.; and our figs. 973.

Spec. Char., &c. Racemes downy, with oval bracteas, and the pedicels with 2 lanceolate bractcoles. Leaves obovate, mucronate, entire, downy, and viscid. Ovarium hairy. Corolla bell-shaped, obtuse, longer than the stamens. A low bushy shrub, with round branches. Leaves $1\frac{1}{2}$ in. long. Calycine segments fringed. Corollas white, tinged with pink, rather large. Berries black, and globular. (*Don's Mill.*, iii. p. 853.) It is a native from New Jersey to Florida, in dry sandy woods, particularly in pine forests, where it grows from 2 ft. to 3 ft. high, and flowers in June and July. It was introduced in 1774. There are plants at Messrs. Loddiges's.



973

Variety.

- α *V. d. 2 humile* Wats. Dend. Brit., t. 32.—The flowers are white; anthers red; pedicels solitary, axillary. Shrub, 6 in. high.

- α 12. *V. corymbosum* L. The corymbose-flowered Whortleberry.

Identification. Lin. Sp., 499.; Don's Mill., 3. p. 853.; Hook. in Bot. Mag., t. 3423.; Lodd. Cat., ed. 1826

Synonymes. *V. amœnum* Ait. Hort. Kew., ed. 2., vol. 2. p. 358.; Andr. Bot. Rep., t. 138.; *V. disomorphum* Michx. Fl. Bor. Amer., 1. p. 231.; *V. elevatum* Hort.; *V. album* Lam. Dict., 1. p. 13.

Engravings. Wats. Dend. Brit., t. 123.; Bot. Rep., t. 138.; Bot. Mag., t. 3433.; and our figs. 974, 975

Spec. Char., &c. Flowering branches almost leafless. Racemes corymbose, drooping, with membranous bracteas, which are shorter than the downy flower stalks. Leaves elliptic, acute, minutely serrated, smooth, with downy ribs. (*Don's Mill.*, iii. p. 853.) A tall shrub, sometimes 7 ft. or 8 ft. high, with numerous roughish round branches, which are, however, somewhat angular and downy while young. Leaves $1\frac{1}{2}$ in. to 2 in. long, tipped with a glandular point. Racemes rising from the branches of the preceding year, and seldom accompanied by leaves. Bracteas reddish, membranous, and fringed. Calycine segments broad and shallow. Corollas white or reddish, cylindrically urceolate, rather angular, and contracted at

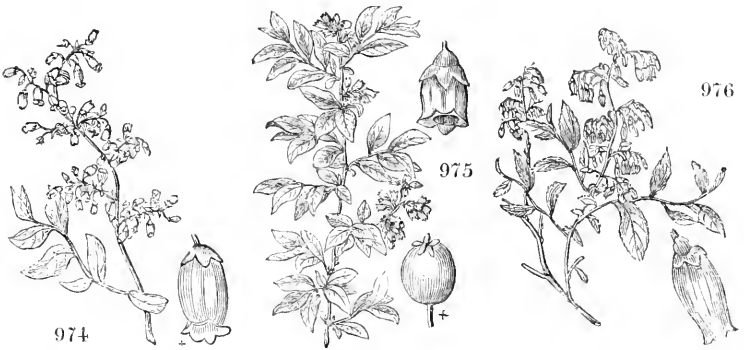

the mouth. Stamens 10, downy. Anthers enclosed, having a double pouch at the base, but no spurs. Berries black, insipid. This species has a number of varieties, in size, shape, and colour of the leaves, flowers, and fruit. It is a native of North America, from Canada to Carolina and Georgia, in swamps and wet woods, where it grows from 4 ft. to 7 ft. high, and flowers in May and June. It was introduced in 1765, and is frequent in collections. In the Duc d'Arenberg's garden at Enghien, it is cultivated in the peat border, for its fruit, which is used like that of the cranberry. (*Neill's Hort. Tour*, p. 322.)

Varieties.

- ✧ *V. c. 2 virgatum* Ait. Hort. Kew., ed. 2., vol. 2. p. 358., Don's Mill., 3. p. 854.; and our fig. 976.—The flowers are white, tinged with crimson or pale red; very elegant, and smaller than the species. Racemes short, lateral and terminal. A shrub, a native of Virginia and Carolina, in swamps, where it grows 2 ft. high.
- ✧ *V. c. 3 fuscatum* Ait. Hort. Kew., l. c., Pursh, Hooker; *V. formosum* Andr. Bot. Rep., t. 97., Bot. Reg., t. 302.; *V. virgatum* Wats. Dend. Brit., t. 33., but not of Ait.; and our fig. 977.; has the flowers striped with red and white, and the calyx downy. It is a native of Lower Carolina and Georgia, in swamps.
- ✧ *V. c. 4 angustifolium*, *V. virgatum* var. *angustifolium* Wats. Dend. Brit., t. 34., has the leaves narrow, lanceolate, and acuminate at both ends, sessile, besprinkled with brown, minute, pedicellate glands beneath, and hairy on the midrib above. Flowers almost white. This variety, like the preceding ones of *V. corymbosum*, is very handsome, and very distinct; and, in British gardens, of easy culture, in sandy peat soil, which, however, as in all similar cases, must be kept cool, and of an equable degree of moisture.



✧ 13. *V. ALBIFLORUM* Hook. The white-flowered Whortleberry.

Identification. Hook. in Bot. Mag., 3428.; Gard. Mag., vol. 11. p. 475.

Synonymy. *V. album* Lam.?

Engraving. Curt. Bot. Mag., t. 3428.

Spec. Char., &c. Leaves oval-lanceolate, obscurely serrulate, membranous, pilose beneath, with spreading hairs, especially on the midrib and primary veins. Flower-bearing branches leafless. Racemes a little corymbose, directed to one side, drooping, bracteated with shortly deciduous bracteas. Calyx spreading, with a tendency to be reflexed. Corolla broadly oval. Ovary wholly inferior. (*Hooker in Bot. Mag.*, t. 3428.) The affinity of "this very pretty species is undoubtedly with *V. corymbosum* of Linnæus and American authors;" but the half-superior ovary of *V. corymbosum*, and the wholly inferior one of *V. albiflorum*, and other points of difference implied in those noticed in the specific character above, have induced Dr. Hooker "to think that the two are permanently distinct." *V. albiflorum* has been received at the Glasgow Botanic Garden, from North America, and it flowers in May. It is "a small shrub, with spreading branches." (*Bot. Mag.*, t. 3428.)

❖ 14. *V. MARIA'NUM* Wats. The Maryland Whortleberry.

Identification. Wats. Dend. Brit., t. 124.; Don's Mill., 3. p. 854.

Synonymy. *V. marilandicum* Lodd. Cat., ed. 1836.

Engravings. Dend. Brit., t. 124.; and our fig. 978.

Spec. Char., &c. Racemes lateral, numerous, many-flowered. Corolla cylindrical, contracted at the mouth. Leaves elliptic, coriaceous, glabrous, distinctly and minutely denticulated. Flowers decandrous, white. (*Don's Mill.*, iii. p. 854.) A native of North America, where it is a shrub growing from 3 ft. to 4 ft. high, and flowering in May and June. It was introduced in 1812; and there are plants at Messrs. Loddiges's.



❖ 15. *V. GRANDIFLO'NUM* Wats. The great-flowered Whortleberry.

Identification. Wats. Dend. Brit., t. 125. f. A.; Don's Mill., 3. p. 854.; Lodd. Cat., ed. 1836.

Engravings. Dend. Brit., t. 125. A.; and our fig. 979., from a plant at Messrs. Loddiges.

Spec. Char., &c. Racemes terminal, 3—4-flowered. Corollas cylindrical, contracted at the mouth. Leaves lanceolate, finely serrated, attenuated at both ends, glabrous. Flowers white, decandrous. (*Don's Mill.*, iii. p. 854.) A native of North America, where it forms a shrub, growing 1½ ft. high, and flowering in July and August. It was introduced in 1812. To us it appears very doubtful, whether this, and the two following sorts, be not varieties of the same form; and, indeed, we might apply the same remark to various other sorts, which we have given as species.



❖ 16. *V. ELONGA'TUM* Wats. The elongated Whortleberry.

Identification. Wats. Dend. Brit., t. 125. B.; Don's Mill., 3. p. 854.; Lodd. Cat., ed. 1836.

Engravings. Dend. Brit., t. 125. B.; and our fig. 980.

Spec. Char., &c. Corymbs few-flowered, bractless. Pedicels downy. Leaves elliptic-lanceolate, serrulated, each tipped by a glandular hair, and having a few hairs on the nerves. Branchlets downy. Corollas white, with reflexed teeth. (*Don's Mill.*, iii. p. 854.) A native of North America, where it is a shrub, growing 3 ft. or 4 ft. high, and flowering in July and August. It was introduced in 1812; and there are plants in the London nurseries.



❖ 17. *V. MINUTFLO'NUM* Wats. The minute-flowered Whortleberry.

Identification. Wats. Dend. Brit., t. 125. C.; Don's Mill., 3. p. 854.; Lodd. Cat., ed. 1836.

Engravings. Dend. Brit., t. 125. C.; and our fig. 981.

Spec. Char., &c. Racemes terminal, few-flowered. Corollas cylindrical, with erect teeth. Leaves rather coriaceous, bluntly subserrated, each tipped by a gland. Flowers white. (*Don's Mill.*, iii. p. 854.) A native of North America, where it is a shrub, growing to about 1 ft. high, and flowering in July and August. Introduced in 1812.



❖ 18. *V. GLA'BRUM* Wats. The glabrous Whortleberry.

Identification. Wats. Dend. Brit. t. 125. D.; Don's Mill., 3. p. 854.; Lodd. Cat., ed. 1836.

Engravings. Dend. Brit., t. 125. D.; and our fig. 982.

Spec. Char., &c. Spikes lateral. Corollas campanulately cylindrical. Leaves elliptic, entire, glabrous. Flowers rose-coloured. (*Don's Mill.*, iii. p. 854.) A native of North America, flowering in July and August, and introduced in 1812. "A delicate, beautiful, and perfectly smooth plant." (*Dend. Brit.*, t. 125.)



❧ 19. *V. FRONDO`SUM* L. The frondose Whortleberry.

Identification. Lin. Sp., 499.; Don's Mill., 3. p. 854.; Lodd. Cat., ed. 1836.

Synonymes. *V. glaucum* Michx. *Fl. Bor. Amer.*, 1. p. 231.; Blue Tangles, *Amer.*

Engraving. Andr. Bot. Rep., t. 140.

Spec. Char., &c. Racemes loose. Bracteas obovate, not half so long as the slender pedicels, which bear 2 small linear bracteoles in the middle. Leaves obovate-oblong, obtuse, entire, smooth. Flowers small, almost globular, and white. Berries large, blue, globular, eatable; called by the country people in America, blue tangles. Branchlets frondose (that is, abounding in leaves), terete, smooth, and slender. Leaves 2 in. or 3 in. long, glaucous beneath, and sprinkled with minute resinous dots. Racemes lateral, from the former year's wood. Flowers drooping, greenish white, and shaped like those of the lily of the valley, but smaller. Anthers not prominent. (*Don's Mill.*, iii. p. 854.) A native of North America, from New Jersey to Carolina, in open woods, where it is a shrub growing 3 ft. high, and flowering in May and June. Introduced in 1761, and frequent in British collections.

Variety.

- ❧ *V. f.* 2 *venustum* Ait. Hort. Kew., ed. 2., vol. ii. p. 357.; *V. frondosum* var. β lanceolatum Pursh *Fl. Amer. Sept.*, i. p. 786.—The leaves are lanceolate, and acute at both ends.

❧ 20. *V. RESINO`SUM* Ait. The resinous Whortleberry.

Identification. Ait. Hort. Kew., ed. 2., vol. 2. p. 357.; Don's Mill., 3. p. 854.; Lodd. Cat., ed. 1836.

Synonymes. *Andrōmeda baccata* Wagh. *Amer.*, t. 30. f. 69.

Engravings. Curt. Bot. Mag., t. 1288.; and our fig. 983.

Spec. Char., &c. Racemes leafless, viscid, downy, with lanceolate bracteoles on the pedicels. Leaves obovate-lanceolate, bluntish, entire, covered with resinous dots. Calyx in 5 deep ovate segments, longer than the ovary. Branches round, and downy when young. Leaves usually 1½ in. long, bright green on both sides, and rather viscid. Racemes lateral, upon last year's wood, and drooping. Flowers greenish yellow. Berries black, eatable. (*Don's Mill.*, iii. p. 854.) A native of North America, from Canada to Carolina, where it is common in woods and on mountains, forming a shrub growing 2 ft. high, and flowering in May and June. Introduced in 1782, and frequent in collections.



Varieties.

- ❧ *V. r.* 2 *rubescens* Pursh *Fl. Amer. Sept.*, i. p. 286., Curt. Bot. Mag., t. 1288., has the corollas reddish.
- ❧ *V. r.* 3 *lutescens* Pursh, l. c.; *V. parviflorum* Andr. Bot. Rep., t. 125.; has the leaves lanceolate, and the flowers reddish yellow.

❧ 21. *V. ARCTOSTA`PHYLOS* L. The Bear's Grape Whortleberry.

Identification. Lin. Sp., 500.; Don's Mill., 3. p. 854.; Lodd. Cat., ed. 1836.

Engraving. Our fig. 984., from the plant in the Horticultural Society's Garden.

Spec. Char., &c. Racemes lateral. Bracteas all at the base of the pedicels. Leaves elliptic, acute, minutely serrated, hairy beneath. Stamens as long as the corolla, which is bell-shaped, with very hairy filaments. Calyx slightly 5-lobed. Young branches downy on both sides. Leaves 2½ in. long. Racemes from the wood of the preceding year, below the fresh leafy shoots, drooping, rather hairy; each composed of 8—10 pendulous flowers, of a dirty white colour, tinged with purple. Anthers spurred at the base. Corollas bell-shaped, hairy. (*Don's Mill.*, iii. p. 854.) A native of the coast of the Black Sea, where it was gathered by Tournefort, who describes it as a shrub about the height of a man, with a trunk as thick as a man's arm. It usually grows 8 ft. or 10 ft. high in British gardens, and flowers from April

till June. It was introduced in 1800; and, though commonly grown only as an ornamental shrub, yet might be cultivated for its fruit, which is produced in very great abundance, is agreeable to the taste, and makes excellent tarts. There are plants at White Knights upwards of 10 ft. high, and there are others in the Knaphill Nursery 6 ft. high, which produce abundance of fruit every year. All the culture required is, to place the plants in sandy peat, or in peat and leaf mould, kept moist. There seems to be a good deal of confusion, in British gardens, between this species and the following one, and we have not been able to satisfy ourselves on the subject. All that we can state with certainty is, that there are plants bearing the name of *V. Arctostáphylos* in Loddiges's arboretum, and the other places mentioned, which answer to the description given, and are well worth cultivating for their fruit.



22. *V. (? A.) PADIFOLIUM* Smith. The Bird-cherry-leaved Bear's Grape. Whortleberry.

Identification. Smith in Rees's Cycl., No. 99; Don's Mill., 3. p. 854; Lodd. Cat., ed. 1836. *Synonymes.* *V. Arctostáphylos* Andr. Bot. Rep., t. 30.; Curt. Bot. Mag., t. 974; *V. maderense* Link Enim., p. 375; *V. caucásicum* Hort.; *V. padifolium caucásicum* Hort. Soc. Cat. of Fruit., edit. 1826, p. 293.

Engravings. Andr. Bot. Rep., t. 30.; Curt. Bot. Mag., t. 974.; and our figs. 985, 986.

Spec. Char., &c. Racemes lateral. Bracteas all at the base of the pedicels.

Leaves ovate-lanceolate, acute, serrulated, smooth on both surfaces, except the midrib. Stamens nearly as long as the bell-shaped corolla, with smooth, slightly fringed filaments. Calyx 5-lobed. Corollas larger than those of *V. Arctostáphylos*,



pale green, with a purple tinge: sometimes it appears to be all over purple externally. (*Don's Mill.*, iii. p. 854.) The Caucasian plant, discovered by Pallas, is said not to differ from that of Madeira. Pallas says the berries are black, juicy, eatable, and gratefully acid; and he sometimes found the flowers 4-cleft. A shrub, from 6 ft. to 10 ft



high; a native of Madeira, on the loftiest parts of the island, where it forms impenetrable thickets. It was introduced in 1777, and flowers from June till August. From observing the plants of this alleged species, of large size, in the Knaphill Nursery, in the Hammersmith Nursery, and in the Horticultural Society's Garden, we are inclined to think that it is nothing more than a variety of *V. Arctostáphylos*.

A. *Leaves evergreen.*

a. *Flowers racemose.*

23. *V. CARACASANUM* H. B. et Kunth. The Caraccas Whortleberry.

Identification. H. B. et Kunth Nov. Gen. Amer., 3. p. 266; Don's Mill., 3. p. 855.

Spec. Char., &c. Racemes axillary, twice as long as the leaves. Flowers secund, octandrous or decandrous. Leaves elliptic, acute, crenulated, coriaceous, glabrous, shining above. Anthers 2 horned on the back. Branchlets angular, glabrous. Leaves shining above, 9-10 lines long. Racemes crowded at the tops of the branches. Corolla campanulate, glabrous, reddish white, with a 4-5-parted limb. Segments ovate, acutish. Filaments membranous, ciliated. (*Don's Mill.*, iii. p. 855.) It is a native of the southern declivity of Mount Silla de Caraccas, where it is a shrub, flowering in May and June. It was introduced in 1825.

24. *V. VITIS IDÆA* L. The Mount Ida Whortleberry, or Cowberry.

Identification. Lin. Sp., 500; Eng. Fl. 2. p. 220; Don's Mill., 3. p. 855; Lodd. Cat., ed. 1836.

Synonymes. *Vitis idæa rubra* Cam. Epit., 136; the red Whortleberry.

Engravings. Lodd. Bot. Cab., t. 1023; Eng. Bot., t. 598; Fl. Dan., t. 40.; and our fig. 987.

Spec. Char., &c. Racemes terminal, drooping with ovate concave bracteas, which are longer than the pedicels. Leaves obovate, revolute, minutely toothed, dotted beneath. Corolla bell-shaped. Root creeping, woody.

Stems ascending, a span high. Young branches terete, downy. Leaves like those of box, but darker. Flowers pale pink, 4-cleft, octandrous. Anthers without spurs. Berries blood-red, acid, austere, and bitter; less palatable than either the cranberry or bilberry. (*Don's Mill.*, iii. p. 855.) It is a native of dry, barren, stony woods and heaths, in the north of Europe; plentiful in Scotland, Westmoreland, Derbyshire, and Wales. Mr. Pursh says it occurs on rocks near the sea coast, from Canada to New England; but the American plant is more robust than the European, with considerably larger leaves. Pallas states that it is found in the whole of Russia, and throughout Siberia, more especially in pine woods. It grows, in elevated exposed situations, to the height of 5 in. or 6 in.; but, in sheltered places in sandy peat soil, it attains the height of 1 ft., producing its pale flesh-coloured flowers in May and June, and ripening its fruit from August to October, according to the season. The berries are scarcely to be eaten raw; but they are made into pies in Derbyshire; and, in Sweden, a rob, or jelly, is made from them, which is eaten with all kinds of roast meat, and is considered preferable to red currant jelly as a sauce for venison. In Sweden, this preserve is also considered an excellent medicine in colds, sore throats, and all irritations of the mouth or fauces. In Siberia, the berries are macerated, during the autumn and part of the winter, in water; and afterwards they are eaten in a raw state, and fermented along with barley or rye, and a spirit distilled from them; or with honey, and a wine produced. Sweetmeats are also made of them with honey or sugar, which, in 1814, we found in frequent use in Moscow, at balls and masquerades. In Sweden and Norway, the plant is said to be used in gardens for edgings, as box is in Central Europe; and, in British gardens, it is sometimes so applied to American beds and borders, and in other cases where the soil is peat. From its smooth shining foliage, and the beauty of its flowers and fruit, the latter being retained on the plant for several months, it forms a more beautiful and varied edging than box, provided clipping can be dispensed with. The berries of this plant form an important article of commerce in the sea ports bordering the Gulf of Bothnia, whence they are sent to the south of Europe along with cranberries.



25. *V. (V.) BUXIFOLIUM* Salisb. The Box-leaved Whortleberry.

Identification. Salisb. Par., t. 4.; *Don's Mill.*, 3. p. 856.; *Lodd. Cat.*, ed. 1836.

Synonyme. *V. brachycerum* Michx. *Fl. Bor. Amer.*, 1. p. 234.

Engravings. *Curt. Bot. Mag.*, t. 928.; *Lodd. Bot. Cab.*, t. 648.; and our *figs.* 988, 989.

Spec. Char., &c. Racemes axillary, of few flowers. Leaves petiolate, obovate, toothed, or crenated, smooth on both surfaces. Stems tufted. Corollas roundish-ovate. Filaments glandular. Stigma capitate. Flowers white, delicately striped with red. (*Don's Mill.*, iii. p. 856.) A handsome little shrub, in stature and general aspect resembling *V. vitis idæa*. The leaves are, however, smooth, even, and not dotted on the under side. Corollas globular, contracted at the mouth, not bell-shaped.

Stamens 10. Anthers spurless at the base, discharging their pollen by lateral, not terminal, apertures. It is a native of the western parts of



Virginia, near Winchester and the Sweet Springs; where it grows about 6 in. high, and flowers in June. It was introduced in 1794, and forms a very handsome plant, frequent in collections. In all probability, it is only a variety of *V. Vitis idæa*.

26. *V. MYRTIFOLIUM Michx.* The Myrtle-leaved Whortleberry.

Identification. Michx. Fl. Bor. Amer., 1. p. 229; Don's Mill., 3. p. 856.

Spec. Char., &c. Creeping, quite smooth. Leaves petiolate, oval, shining, revolute, sparingly and minutely toothed. Racemes axillary, nearly sessile, of few flowers. Corolla bell-shaped, somewhat inflated, minutely 5-toothed. Anthers without dorsal horns. (*Don's Mill.*, iii. p. 856.) Michaux describes the berries as small, globose, crowned by the calyx, black, on short stalks. It is a native of Carolina, where it forms a creeping shrub, flowering from May to July. It was introduced in 1812.

27. *V. NITIDUM Andr.* The glossy-leaved Whortleberry.

Identification. Andr. Bot. Rep., t. 480; Pursh Fl. Amer. Sept., 1. p. 289; Don's Mill., 3. p. 856.

Engravings. Curt. Bot. Mag., t. 1550; and our fig. 990.

Spec. Char., &c. Racemes terminal, corymbose. Bractees shorter than the pedicels. Leaves elliptic-obovate, acute, crenated, smooth, and shining. Corollas cylindrical. Stems either erect or diffuse. Leaves $\frac{1}{2}$ in. to 1 in. long, paler and veiny beneath. Pedicels, bractees, and calyx, very smooth, of a shining red or purple colour. Calyx of 5 broad, but rather shallow, segments. Corollas ovate, oblong, white or pink, with 5 slight spreading teeth, decandrous. The branches are downy on two opposite sides. (*Don's Mill.*, iii. p. 856.) It is a native of Carolina, where it is a decumbent shrub, or rising to above 1 ft. high; flowering in May and June. It was introduced in 1794, and is frequent in collections.



990

28. *V. CRASSIFOLIUM Andr.* The thick-leaved Whortleberry.

Identification. Andr. Bot. Rep., t. 105; Pursh Fl. Amer. Sept., 1. p. 289; Don's Mill., 3. p. 856.

Engravings. Bot. Rep., t. 105; Curt. Bot. Mag., t. 1152.

Spec. Char. &c. Racemes lateral and terminal, corymbose. Bractees shorter than the pedicels. Leaves elliptic, crenated, smooth, paler and veiny beneath. Corolla bell-shaped. Stem diffuse. A hairy shrub, requiring some shelter from our variable winters and springs. Leaves not an inch long, with a little minute pubescence on the midrib and petioles. Flowers 5-cleft, decandrous, prettily variegated with pink and white, drooping, on red corymbose stalks. Stamens hairy. (*Don's Mill.*, iii. p. 856.) A native of Carolina, where it forms a trailing shrub, flowering in May and June. It was introduced in 1787.

29. *V. OVA'TUM Pursh.* The ovate-leaved Whortleberry.

Identification. Pursh Fl. Amer. Sept., 1. p. 290; Hook. et Arn. in Beech. Voy., Pt. Bot., p. 114; Don's Mill., 3. p. 856; Lodd. Cat., ed. 1836.

Engraving. Our fig. 991.

Spec. Char., &c. Racemes axillary and terminal, bracteate, short. Leaves on short petioles, oblong, ovate, acute, revolute, serrated, smooth, coriaceous. Corolla cylindrical, campanulate. Calyxes acute. Shrub much branched. Branches hairy, as well as the petioles. The foliage is like that of *Pernettia mucronata*. (*Don's Mill.*, iii. p. 856.) It was found by Governor Lewis, on the banks of the Columbia River, and by Mr. Menzies, on the north-west coast of America. It flowers in May, and was introduced in 1826. There are plants at Messrs. Loddiges's.



991

30. *V. CANADENSE Richards.* The Canada Whortleberry.

Identification. Richards. in Franklin 1st Journ., Append.; Don's Mill., 3. p. 856; Hook. in Bot. Mag., t. 3446.

Engraving. Bot. Mag., t. 3446.

Spec. Char., &c. Leaves lanceolate, acute at both ends, quite entire, downy. Racemes terminal. Flowers in racemes, of from 4 to 6 in each. Style enclosed. Corolla short, and campanulate, white, tinged with red. Stem much branched. Leaves often 1 in. long. Berries blue black, agreeable to the taste. It may be readily known from *V. corymbosum*, by its dwarf size, leafy flow-

ering branches, and campanulate corolla; from *V. pennsylvanicum* by its large quite entire leaves, and wider mouth to the corolla; and from both by its leaves being very hairy. (*Bot. Mag.*, Nov. 1835.)

b. *Flowers disposed in scaly Tufts, nearly sessile.*

21. 31. *V. MYRSINITES Michx.* The Myrsine-like Whortleberry.

Identification. Michx. Fl. Bor. Amer., 1. p. 233.; Pursh Fl. Amer. Sept., 1. p. 290.; Don's Mill., 3. p. 856.

Spec. Char., &c. Flowers in terminal and lateral tufts. Leaves sessile, oval, mucronate, obscurely serrated, smooth and shining above, and rather hairy and dotted beneath. Stem erect, much branched. Corolla oblong-ovate. (*Don's Mill.*, iii. p. 856.) A beautiful little shrub, with slightly downy branches. Leaves glandular beneath. Tufts of flowers axillary, with purple scales. Caly-cine segments scarlet. Corolla of a fine purple colour, 5-toothed. Stamens 10. It is a native of Carolina and Florida, in dry sandy woods, where it is a small shrub, flowering in May and June. It is said to be introduced, but when is uncertain; and we have never seen a plant.

Varieties.

21. V. M. 2 *lanceolatus* Pursh Fl. Amer. Sept., 1. p. 290., has the leaves lanceolate, acute at both ends.
21. V. M. 3 *obtusus* Pursh, l. c., has the leaves roundish-obovate.

22. 32. *V. HUMIFUSUM Grah.* The trailing Whortleberry.

Identification. Graham in Edinb. Phil. Journ. June, 1831; Don's Mill., 3. p. 857.

Spec. Char., &c. Pedicels axillary, solitary, 1-flowered, furnished with many bracteas. Leaves evergreen, ovate, acutish, quite entire, glabrous on both surfaces, ciliated. Stem prostrate, creeping. Flowers decandrous. Anthers obtuse, nutic. Branchlets downy. Flowers drooping. Corollas campanulate, white, often partially tinged with red outside, with reflexed teeth. Stigma capitate. Filaments glabrous, flattened. Fruit edible, well flavoured. (*Don's Mill.*, iii. p. 857.) It is a native of North America, on the Rocky Mountains. A creeping shrub, flowering in May and June. Introduced in 1827; but we have not seen the plant.

App. i. *Hardy Species of Vaccinium not yet introduced.*

V. Chamissonis Bongard, *Don's Mill.*, iii. p. 852.; *V. Myrtillus* Cham. et Schlecht. in *Linnaea.*, 1. p. 525. Pedicels solitary, 1-flowered, short, deflexed while in fruit. Leaves elliptic, nearly entire, obtuse, mucronated, glabrous, glaucous beneath. Calyx 5-toothed. Flowers decandrous. Branches erect, angular. Corolla white, urceolate, with short obtuse lobes. Anthers awned on the back. Berries black. It is a native of the Island of Sitcha, where it is a shrub, growing about 1 ft. high.

V. ovalifolium Smith, *Don's Mill.*, 3. p. 852. Pedicels solitary, 1-flowered. Leaves elliptic, obtuse, pointless, entire, smooth, strongly veined beneath. Stem angular. Calyx hardly divided. A shrub, growing from 10 ft. to 12 ft. high, native of the north-west coast of America, where it was collected by Mr. Menzies; and in the Island of Sitcha, by Bongard.

V. parvifolium Smith, *Don's Mill.*, 3. p. 852. Pedicels solitary, 1-flowered, clavate while bearing the fruit. Leaves elliptic, obtuse-pointed, entire, smooth, glaucous, and slightly veined beneath. Stem acutely angular. Calyx hardly divided. The leaves much smaller than those of *V. ovalifolium*; as are the berries, which are red, and make excellent tarts. A native of the north-west coast of America, where it was collected by Mr. Menzies; and in the Island of Sitcha, by Bongard.

V. salicinum Cham. et Schlecht. is a creeping shrub, with the habit of *Saxil alpigena*; a native of Oonalaschka, on mossy hills.

V. cylindraceum Smith is a native of the Azores, on mountains, where it is called *uva de serra*, or mountain berry. Flowers drooping, and nearly 1 in. long.

V. confertum H. B. et Kunth is a native of Mexico, on high mountains, near Moran and Cerro de Oyamel, growing to the height of 1 ft.

V. obtusum Pursh Fl. Amer. Sept., 1. p. 190. Pedicels axillary, solitary, 1-flowered. Leaves small, oval, rounded, and blunt at each end, mucronate, entire, coriaceous, smooth. Stem creeping. A native of the north-west coast of America, where it was gathered by Mr. Menzies.

App. ii. *Half-hardy Species of Vaccinium not yet introduced.*

In *Don's Miller*, p. 852. to p. 857., the following species of *Vaccinium* are described as not yet introduced:—

V. geminiflorum H. B. et Kunth is a native of Mexico, with the habit of *V. Myrtillus*; growing to the height of 1 ft.

V. hirtum Thunb. is a native of Japan, growing to the height of 2 ft. or 3 ft., on hills.

V. calycinum Smith is a native of the Sandwich Islands, in woods, upon lofty mountains; and growing to the height of 2 ft. or 3 ft.

V. bracteatum Thunb. is a native of Japan, in the Island of Nippon, with racemes 2—3 in. long.

V. ciliatum is a native of Japan, where it is called *sasjebu*, with leaves 1—2 in. long.

V. ledifolium Poil is a native of Brazil, in the province of Minas Geraes, on the higher mountains, in dry places; growing to the height of 1 ft.

V. floribundum H. B. et Kunth is a native of Peru, with leaves 6—7 lines long, besprinkled with a few black dots beneath.

V. leucanthum Cham. in *Linnaea* is a native of Mexico, with white flowers, and black edible fruit.

V. villosum Smith in *Rees's Cycl.* is a native of Mexico, whence specimens were sent to Linnæus by Mutis.

V. Schlechtendühii G. Don is an erect, much-branched, evergreen shrub, with leaves 2 in. long, and 9 lines broad; a native of Mexico, in woods.

V. scabrum Pohl is a shrub, about 1 ft. high, a native of Brazil, in turfy bogs.

V. montanum Pohl is a diffuse shrub, a native of Brazil, in dry places, with leaves 8 lines long, and 4 broad.

V. cereum Forst. is a small shrub, 6 in. high, a native of Otahete and Owyhee.

V. reticulatum Smith is a native of the Sandwich Islands, on the high mountains, where it was collected by Mr. Menzies. Leaves 1 in. long, with revolute margins.

V. penduliflorum Gaud. is an erect glabrous shrub, a native of the Sandwich Islands, at the altitude of 500 hexapodes.

V. microphyllum Herb. Reinwdt. is a shrub, a native of the Celebes, on the mountains.

V. dentatum Smith is a native of the Sandwich Islands, on lofty mountains, where it was discovered by Mr. Menzies.

V. empetrifolium H. B. et Kunth is a creeping shrub, a native of the western declivity of the burning mountain Aritisana, between Pintoc and Pinantura.

V. penzanceoides, *V. acuminatum*, and *V. alaternoides* H. B. et Kunth, are South American species, of which very little is known.

GENUS XXVII.



OXYCOCBUS Pers. THE CRANBERRY. *Lin. Syst.* Octándria Monogýnia.

Identification. Pers. Syn., 1. p. 419; Pursh Fl. Amer. Sept., 1. p. 263; Nutt. Gen. Amer., 1. p. 250; Don's Mill., 3. p. 857.

Synonymy. *Vaccinium* sp. of Lin. and others.

Derivation. From *ozus*, sharp, and *kokkos*, a berry; in reference to the sharp acid taste of the berries.

Description. *Calyx* 4-toothed. *Corolla* 4-parted, with nearly linear, revolute segments. *Stamens* 8, with connivent filaments. *Anthers* tubular, 2-parted. *Berries* many-seeded.—Small, prostrate, trailing, evergreen shrubs, with small leaves, growing in boggy morasses, often among living masses of Sphagnum. Branches filiform, proliferous. Flowers produced at the base of the spring branchlets, in short gemmaceous racemes. Pedicels filiform, conspicuously bibracteate. Berries red, rarely white, acid. (*Don's Mill.*, iii. p. 858.) Natives of Britain and North America.

2. *O. PALUSTRIS* Pers. The marsh, or common, Cranberry.

Identification. Pers. Ench., 1. p. 419; Don's Mill., 3. p. 858.

Synonymy. *O. vulgaris* Pursh Fl. Amer. Sept., 1. p. 263; *O. europæus* Nutt. Gen. Amer., 1. p. 251; *Vaccinium Oxycoccus* Lin. Sp., 500; *Smith Eng. Bot.*, t. 319; *Ed. Fl. Dan.*, t. 80; *Vacciniur Oxycoccus* var. *α ovalifolius* Michx. Fl. Bor. Amer., 1. p. 228; *Vaccinia palustris* Ger. Emac., 1419.

Lob. Icon., 2. t. 109; *Oxycoccus* Cord. Hist., 140. 2. f. 1; Mossberries, Moorberries, Fenberries, Marshworts, or Whortleberries, Cornberries, Eng.; Airelle canneberge, Fr.; gemeine Moosebeere, Ger.

Derivation. The name of Cranberry is supposed to be given from the peduncles of the flowers being crooked at the top, and, before the expansion of the flowers, resembling the head and neck of a crane (*Smith and Withering*); or because they are much eaten by cranes.

Engravings. Eng. Bot., t. 319; Ed. Fl. Dan., t. 80; Lob. Icon., 2. t. 109; and our fig. 992.

Spec. Char., &c. Stems filiform, trailing. Leaves small, ovate, entire, acute, smooth, with revolute margins. Pedicels terminal, 1-flowered, of a delicate pink or rose colour. Segments of corolla oval. Leaves convex, and dark shining green above, and glaucous beneath. Stems reddish. Pedicels few together, about the tops of the branches, red, slightly hoary. Corolla pink, with reflexed oblong segments. Stamens with purple downy filaments, and yellow anthers. Berries pear-shaped, globular, often spotted, crimson, of a peculiar flavour, with a strong acidity, grateful. (*Don's Mill.*, iii. p. 858.) A low, trailing, subevergreen shrub; seldom rising higher than 3 in. or 4 in.; flowering in May and June, and ripening its fruit in August and September. It is a native of turfy mossy bogs in the mountainous parts of Europe; common in Switzerland, Russia, Scotland, Ireland, and the north of England, as well as in the east, as in Lincolnshire and the neighbouring part of Norfolk. Pursh speaks of it as common on the boggy mountains of North America, from Canada to Pennsylvania, and in the Island of Oonalashka,



where it is a creeping shrub, flowering in May and June. Pallas says it is found in turfy bogs, in the north of Russia, and throughout the whole of Siberia, as far as the Northern Ocean. The berries remain during the whole winter under the snow; and are collected in spring, after it is thawed and gone, as well as in autumn, before it falls. In the north of Europe, as well as in Britain, cranberries have been in use from time immemorial, for supplying an acid drink during the hot summer months, for tarts, and other purposes. For culinary purposes, they are exported from Russia and Sweden to most parts of Europe. During the latter end of the last century, cranberries from Lincolnshire and the north-west corner of Norfolk were sold in the streets of Norwich by cart-loads; but the extensive enclosures that have been made since that period have, in many parts, destroyed their native bogs. Lightfoot records that at Longtown, on the borders of Cumberland, not less than 20*l.* or 30*l.* worth were sold each market day, for five or six weeks together, and dispersed over different parts of the kingdom. The numerous enclosures, drainages, and improvements of heath and boglands, which have taken place since the commencement of the present century, have nearly destroyed all our native cranberries; and England is now chiefly supplied with cranberries from Russia and Sweden, and with the sort produced by *O. macrocárpus* from North America. The Russian cranberries are considered to be superior in quality to those of America. The total quantity from both countries imported, according to M'Culloch, is from 30,000 to 35,000 gallons annually.

Properties and Uses. The berries are powerfully acid and astringent, and they have a peculiar flavour, which is agreeable to some, though disliked by others. In a wild state, they are eaten by cranes and other birds. They may be kept several years, if gathered when quite dry, and then closely corked in dry bottles, and placed in a cool dry cellar. They will also keep in bottles or in casks of water; which last mode is that practised in the north of Europe and America, and in which state they are exported from place to place as articles of commerce. In Sweden and Russia, they are used for tarts and sweetmeats, and the expressed juice is considered efficacious in fevers. The bankers in Russia, Pallas informs us, make use of the fruit for whitening their silver money, which they do by boiling it in the juice, when the sharp acid dissolves the superficial particles of the copper alloy. The same thing is done in Sweden to whiten silver plate. In Britain, almost the only use to which the berries are applied is that of making tarts; and for this purpose, since the plant in a wild state has become scarce, this species and *O. macrocárpus* have been cultivated in various gardens. (See *Encyc. of Gard.*, ed. 1832, p. 137.) In Russia, and in some parts of Sweden, the long filiform shoots of the oxycoccus are collected in spring, after most of the leaves have dropped off, and are dried, and twisted into ropes, which are used to tie on the thatch of houses, and even for harnessing horses.

Propagation and Culture. The plant is abundantly increased by laying sandy soil on its shoots, at the distance of 5 in. or 6 in. from its main stem, when it will send down roots abundantly. When it is to be grown for its fruit, a bed of peat soil should be prepared in an open airy situation, where it can be kept moist; or the margin of a pond may be made choice of, and the plants planted there in peat soil, in a bed encircling the pond, 1 in. or 2 in. above the level of the water, and about 1 ft. distant from it. The cranberry may also be grown in beds of dry sandy peat; and it is alleged by some who have tried this method in British gardens, that the fruit produced, though smaller in quantity, is of a better flavour. We have little doubt of this, arguing from general principles; and we think it probable that the fruit would be further improved, both in bulk and flavour, if it were grown in peat and leaf mould, rather than in peat alone. A bed, containing a very few square yards, will produce a considerable quantity of fruit, though not nearly so much as a bed of equal extent of the American cranberry, to be next described.

2. *O. MACROCARPUS* Pursh. The large-fruited, or American, Cranberry.

Identification. Pursh Fl. Amer. Sept., 1. p. 263; Don's Mill., 3 p. 858.

Synonymes. *Vaccinium macrocarpum* *Att. Hort. Kew*, ed. 1., vol. 2. p. 13. t. 7., *Hook. in Bot. Mag.*, t. 2506., *Lam. Ill.*, t. 286. f. 4.; *Vaccinium hispidulum* *Wangh. Amer.*, t. 30. f. 67.; *Vaccinium Oxycoccus* β *oblongifolium* *Michx. Fl. Bor. Amer.*, 1. p. 228.

Engravings. *Dend. Brit.*, t. 122.; *Bot. Mag.*, t. 2506.; and our fig. 993.

Spec. Char., &c. Stems filiform, trailing. Leaves elliptic-oblong, nearly flat, and obtuse, distantly sub-serrulated on the margins, glaucous beneath, downy at the points when young. Segments of the corolla linear-lanceolate. Flower-bearing branches erect, proliiferous. Pedicels lateral. Points of young leaves, peduncles, and the margins of the calyx and bractees, downy. Berries spherical, red, often remaining throughout the winter. (*Don's Mill.*, iii. p. 858.) This is a trailing shrub, resembling the preceding species, but it is a larger and more robust plant. Several flowers come forth at the ends of the last year's branches, surmounted by the shoots of the present year. The bractees are situated on the upper part of the pedicels in this species, while in *Oxycoccus palustris* they are situated on the lower part. The berries are also larger, and of a brighter red. It is a native of North America, from Canada to Virginia, in bogs, principally on a sandy soil; and it is also frequently found on high mountains. It flowers from May till July. Introduced in 1760, and frequent in collections; producing, when cultivated for its fruit, which is used in all respects like that of the common cranberry both in America and Europe, a larger quantity on a given space than *O. palustris*.



Propagation, Culture, &c. This species may, like the other, be propagated by cuttings taken from the points of the growing shoots, and planted in sand under a hand-glass; or by layers, or division of the plant. In gardens, it may be cultivated as directed for the common cranberry; or in floating islands formed by filling old boats with peat soil, which may be anchored in a river, or fixed stationary in ponds or other pieces of artificial water. Sir Joseph Banks was the first person who cultivated the American cranberry in England for its fruit. He grew it on the margin of a pond, in a box of peat soil, suspended in water, and procured immense crops. An account of his mode of proceeding is given in the *Horticultural Society's Transactions*, vol. i. p. 71.; and in the *Encyclopædia of Gardening*, ed. 1835, p. 937. As the results of Sir Joseph Banks's mode of culture, we may here mention, that, in the year 1813, his crop averaged one fifth of a gallon, or about as many cranberries as will make a good-sized cranberry tart, for every $2\frac{1}{2}$ square ft. The size of the beds in which they were grown was equivalent to 18 ft. square; and the total quantity produced from this space was $3\frac{1}{2}$ Winchester bushels. It is probable that by improvements in the method of culture; such as withholding moisture at the ripening season, mixing the peat soil with leaf mould, or consumed stable dung or night soil; or, probably, by keeping the peat moist with liquid manure instead of common water, and full exposure to the sun, something might be done in the way of increasing the size and flavour of the fruit. At all events, the subject is worth experimenting upon by the practical gardener and the amateur. Those who are fond of overcoming difficulties, and producing objects at once highly artificial, altogether new, and singular as well as beautiful, might try to graft the *Oxycoccus*, standard high, on some species of *Vaccinium* or *Andrómæda*.

Variety.

2. *O. m. 2 fôlis variegâtis* Hort., *Vaccinium macrocarpum* fôl. var. *Lodd. Cat.*, has variegated leaves, and is a very ornamental plant for keeping in pots, or on moist rockwork.

3. O. ERE'CTUS Pursh. The erect Cranberry.

Identification Pursh Fl. Amer. Sept., 1. p. 264.; Don's Mill., 3. p. 858.
Synonyme. *Vaccinium erythrocarpum Michx. Fl. Bor. Amer.*, 1. p. 227.,
 and *Lodd. Cat.*, ed. 1836.
Engravings. Wats. Dend. Brit., t. 13.; and our fig. 994.

Spec. Char., &c. Leaves oval, acuminate, serrulated, and ciliated. Pedicels axillary. Corolla, before expansion, long and conical, at length revolute. Stem erect. Branches flexuous. Leaves membranous, somewhat hairy. Flowers red. Berries scarlet (Watson says black), quite transparent, and of an exquisite taste. Very different in habit from the other species. (*Don's Mill.*, iii. p. 858.) It is a native of Virginia and Carolina, on lofty mountains, where it grows to the height of 2 ft.; flowering in May and June. It was introduced in 1806; and there are plants at Messrs. Loddiges's, and in other nurseries. It is rather remarkable, that this species has not yet been cultivated in the kitchen-garden, as a fruit shrub.



App. I. Genera of Ericaceæ, of which it appears doubtful if any hardy ligneous Species have yet been introduced.

GENUS I.



BRYA'NTHUS Gmel. THE BRYANTHUS. *Lin. Syst.* Decándria Mono-gýnia.

Identification. Gmel. Sib., 4. p. 133. t. 57. f. 3.; Don in Edinb. Phil. Journ., 17. p. 160.; Don's Mill., 3. p. 833.
Synonymes. *Andrómeda* sp. *Lin.*; *Menziësia* Swartz and Pursh; *Erica* sp. *Thunb.*
Derivation. From *bryon*, a moss, and *anthos*, a flower.
Gen. Char., &c. *Calyx* 5-leaved, imbricate. *Corolla* deeply 5-parted, spreading. *Stamens* 10, shorter than the corolla. *Filaments* flattened, glabrous. Cells of *anthers* short, awned behind. *Stigma* obtuse. *Capsule* 5-celled.—Trailing evergreen shrubs, natives of Asia and North America.

1. B. GME'LINI D. DON. Gmelin's Bryanthus.

Identification. D. Don in Edinb. Phil. Journ., 17. p. 160.; Don's Mill., 3. p. 833.
Synonymes. *Menziësia bryántha Swartz in Lin. Trans.*, 10. p. 378. t. 30. f. b.; *Andrómeda bryántha Lin. Mant.*, 238., *Pall. Fl. Ross.*, p. 57. t. 74. f. 1.; *Erica bryántha Thunb. Diss.*, No. 8., *Willd. Sp.*, 2. p. 386.; *Bryánthus repens serpyllifolia flore roseo Gmel. Sib.*, 4. p. 133. t. 57. f.

Engravings. Swartz in *Lin. Trans.*, 10. p. 378. t. 30. f. b.; *Pall. Fl. Ross.*, p. 57. t. 74. f. 1.; *Gmel. Sib.*, 4. p. 133. t. 57. f. 3.; and our fig. 995.

Spec. Char., &c. Branchlets pruinose. Leaves with denticulated margins. Peduncles glandular, many-flowered. Anthers mutic. Style filiform. Flowers red. (*Don's Mill.*, iii. p. 833.) A trailing shrub, a native of Kamtschatka, about Port Ochotsk, and of Behring's Island, where it grows in thick masses covering a great extent of surface, like wild thyme. Pallas says that he first observed it near the Sea of Ochotsk, in low mossy situations, also in Kamtschatka, and Behring's Island, being the only ornament of the rocks which compose the greater part of its surface; sometimes also he found it along with *E'mpetrum* and mosses, in boggy places. This very elegant little plant would form a most desirable introduction for the British ericetum, from its close general resemblance to the genus *Erica*. We have been informed that it is already in the Glasgow Botanic Garden, and the climate of that part of Britain is doubtless better adapted to it than that of London; but if we have been misinformed, and it is not yet introduced, there could not be much difficulty in procuring it through the medium of the Botanic Garden of St. Petersburg or of Upsal. The directors of these gardens, and indeed the directors of botanic gardens generally, are always happy when they can supply any wants of their friends: and the greater the distance of those friends the better; because the articles they are entitled to ask in return, are the more likely to be new and rare to them.

995



2. *B. STELLERI* D. Don. Steller's Bryanthus.

Identification. D. Don, l. c.; Don's Mill., 3. p. 833.

Synonymes. *Andróméda Stelleriana* Pall. Fl. Ross., p. 58. t. 74. f. 2.; *Menziesia empetriformis* Pursh Fl. Amer. Sept., 1. p. 265., but not of others.

Engravings. Pall. Fl. Ross., p. 58. t. 74. f. 2.; and our fig. 996.

Spec. Char., &c. Branchlets glabrous. Leaves with obsolete crenulated edges. Flowers solitary, nearly sessile. Anthers 2-horned behind. Style conical. Flowers pale red. Don's Mill., iii. p. 833.) A trailing shrub, a native of the north-west coast of America, on the Rocky Mountains, and near the mouth of the Columbia River, and in the Island of Sitcha. This plant, Pallas observes, although a specimen is preserved in the herbarium of Steller, has been altogether omitted by the two Gmelins; perhaps because Steller himself described it imperfectly. In his MS. he says, "it occurs together with the former *B. Gmelini*"; its mode of growth, and time and place of flowering, are also much the same, so that before the flowers expand they can scarcely be distinguished from each other." The flowers, however, are different; being larger, and about half an inch broad; with a monopetalous, white, 5-cleft corolla. The fruit resembles that of *B. Gmelini*. It appears to us highly probable from this description, that the two sorts are only different states of the same species; but, be this as it may, the plants would not be the less interesting, if introduced into our collections. We recommend such of our readers as live in alpine situations, to direct their attention to the procuring of plants of *Bryanthus* from their native habitat—either in Russia or North America. Perhaps they may be procured from the most northern parts of North America; or by means of some of those numerous British travellers who, at present, are to be found in every part of the globe.

Cladothamnus pyrolæformis Bongard in Mém. Acad. Petersb., 2. p. 155; *Pyrola fruticosa* Eschscholtz; is a much-branched evergreen shrub, a native of the north-west coast of America, growing to the height of from 4 ft. to 6 ft.



App. II. Half-hardy ligneous Species of *Ericaceæ*.

There are no plants, Dr. Lindley observes, "more general favourites among collector than the species of *Ericaceæ*. It is, however, very remarkable, that, notwithstanding the extensive commerce of England, the zeal of her merchants, and the enterprise of individuals, some of the most magnificent of these plants are still known to Europeans only from the dried specimens in the herbariums of botanists. We allude to the noble genus *Befaria*, which contains many species more beautiful than even *Rhododendron* and *Azalea*; to the *Thibaudias*, with long tubular crimson blossoms, and to many species of *Gaylussacia*. The finest of these plants inhabit the Cordilleras of Peru, in the country of the emponas; and, certainly, if one half the sum that has been sometimes wasted in ill-considered undertakings were applied judiciously to an expedition into this region, there would be no reasonable doubt of success, and the results would be indescribably important." (*Bot. Reg.*, as quoted in *Gard. Mag.*, xi. p. 523.)

GENUS I.



ENKIANTHUS Lour. THE ENKIANTHUS. *Lin. Syst.* Decandria Monogynia.

Identification. Lour. Cochin., 276.; Don's Mill., 3. p. 833.

Synonyme. *Meladra* Sal. in *Hort. Trans.*, 2. p. 156.

Derivation. From *egkuos*, pregnant, and *anthos*, a flower. The flowers swollen.

Gen. Char., &c. Calyx 5-cleft, with coloured bracteas. Corolla campanulate, with a 5-cleft limb, and with 5 pits at the base of the tube. Stamens 10, inserted in the base of the corolla. Style filiform. Berry 5-celled.—Low evergreen shrubs, natives of China, where they are held in high veneration by the natives; in Britain, somewhat difficult of culture. They grow best in sandy loam, mixed with a little peat, with a very moderate degree of heat, rather less than that of a conservatory, and placed near the glass. Cuttings of the ripened wood will root in sand under a bell-glass. As they flower from September to February, and as their flowers, which are of pink mixed with white, are extremely beautiful and showy, they are valuable ornaments in the winter; but, from their flowers appearing at that season, they are more fit for a cold-pit or a conservatory, than a conservative wall. Till lately, as far as we have been able to learn, these plants have only been well cultivated and flowered, in England, in the conservatory of W. Wells, Esq., at Redleaf, in Kent. A plant, however, flowered in the spring of 1836, at Drayton Green, in the garden of Mrs. Lawrence. They do not succeed well, if disturbed after being once planted.

1. *E. QUINQUEFLO'RUS* Lour. The five-flowered Enkianthus.

Identification. Lour. Cochin., p. 276.; Don's Mill., 3. p. 834.

Synonyme. *E. reticulatus* Lindl. *Bot. Reg.*, t. 883., *Botanist*, t. 1.

Engravings. Andr. Rep., t. 102.; Ker Bot. Reg., t. 201.; *Bot. Mag.*, t. 1649.; Lodd. Bot. Cab., t. 1101.; Lindl. Bot. Reg., t. 883.; *Botanist*, t. 1.; and our figs. 997, 998.

Spec. Char., &c. Stem shrubby. Leaves oval-lanceolate, acuminate somewhat waved on the margins. Flowers 5—6 together, at the tops of the branches; generally pink, or with the calyx red, and the corolla nearly white. Don's Mill., iii. p. 834.) A shrub, growing to the height of from 5 ft.

997



to 10 ft.; a native of the south of China. Introduced in 1812, and flowering from February to September

E. biflorus Lour. Coch., p. 276., Don's Mill., 3. p. 834. Stem shrubby. Leaves oval-lanceolate. Flowers twin, terminal, and red. A shrub, a native of the south of China. (Don's Mill., iii. p. 834.) Not yet introduced.

Vireya is a genus which differs from *Rhododendron* in the calyx being small, and in the stamens not being attached to the corolla. The leaves are scattered and verticillate, quite entire, coriaceous, and covered with scaly dots beneath; and the flowers are disposed in terminal fascicles. The species are chiefly parasitical



998

shrubs, flowering throughout the year; five of them are described in Don's *Miller*, but none of them are introduced.

Bejaria Humb. et Bonp., *Bejaria* Mutis, is a genus of alpine shrubs, with the habit of some species of *Rhododendron*; natives of North and South America; ten species of which are described in Don's *Miller*; but only two of them have been yet introduced. The noble genus *Bejaria*, Dr. Lindley observes, as quoted above, "contains many species more beautiful than even *Rhododendron* and *Azalea*."

B. glauca Humb. et Bonp. Pl. Æquin., 2. p. 118. t. 177., Don's Mill., 3. p. 849., is a glabrous shrub, with leaves oblong, obtuse, glaucous beneath. Racemes terminal and axillary. Pedicels somewhat fastigate. The plant is much branched, and the branchlets are angular. The corolla is flesh-coloured, and smooth. It is a native of South America, in the alpine regions of the province of Venezuela. It was introduced in 1826, grows to the height of from 3 ft. to 6 ft., and flowers in June and July. We have not seen the plant.

B. racemosa Vent. Cels., p. 51. t. 5., Don's Mill., 3. p. 849.; *B. paniculata* Michx.; has the branchlets smooth, and sometimes hispid. The leaves are ovate-lanceolate, and glabrous; and the flowers are disposed in racemose terminal panicles. Corollas purple. It is a native of Georgia and Florida, in sandy places. It was introduced in 1810, grows to the height of from 3 ft. to 5 ft., and flowers in June and July.

Hymenánthes japonica Blum. Bijdr., 862., and Don's Mill., 3. p. 849., is a shrub, nearly allied to the preceding genus, but differing from it in having a small calyx, and monopetalous corolla. It is a native of Japan, from which country specimens were received by Blume, under the name of *Rhododendron maximum*.

Gaylussiccia H. B. et Kunth is a genus of evergreen and deciduous shrubs, natives of South America, with scattered coriaceous leaves, and scarlet bracteate flowers; but none of the species have been yet introduced. *G. luxifolia* H. B. et Kunth Nov. Gen. Amer., 3. p. 276. t. 257., is a native of Caraccas, on Mount Avila. The flowers of this, and of most of the other sorts, are scarlet.

Thibaúfia is a genus of evergreen shrubs, natives of Peru, with coriaceous entire leaves, and drooping bracteate flowers, disposed in lateral corymbose racemes. Twenty species, green-house or stove plants, have been described, but none of them are yet introduced. *T. cordifolia* H. B. et Kunth Nov. Gen. Amer., 3. p. 271. t. 255., a native of New Granada, on the Andes, will give an idea of the genus.

Cavendishia nobilis Lindl. is a shrub, with laurel-like leaves, and its flowers arranged in capitate racemes, mostly terminal. The corolla is bright crimson, and tubular, about 1 in. long "A most lovely plant," which constitutes a new genus, nearly related to *Thibaúfia*. It is a native of the Cordilleras of Peru, whence dried specimens were sent home by Mr. Mathews; and the plant in a living state, Dr. Lindley anticipates, will soon find its way to England. (See *Bot. Reg.*, Sept. 1835, and *Gard. Mag.*, xi. p. 523.)

Agapetes D. Don, Don's Mill., 3. p. 862., is a genus, the species of which are evergreen shrubs, natives of the East Indies, chiefly of Java, with lanceolate coriaceous leaves with denticulated margins, and scarlet flowers, corymbose and racemose. Sixteen species have been described by D. Don, and also in Don's *Miller*; but none of them have been yet figured or introduced.

Ceratosëma Juss. is a genus of evergreen shrubs, natives of Peru, with oblong coriaceous leaves, and large scarlet flowers. *C. grandiflora* is described by Ruiz et Pav. in *Fl. Per.*, 4. t. 383. f. b.

App. III. Of the Cultivation of the Hardy Ericacææ, including the Laying out and Planting of an Ericacetum.

In taking a survey of all the different species composing the order Ericacææ, it will be found that, in a practical point of view, they are all shrubs; very few of them exceeding 5 ft. or 6 ft. in height, till they attain a considerable age. The only exceptions to this remark are to be found in the genera *Arbutus*, *Andróméda*, and *Vaccínium*; two or three species of which attain the height of small trees in 10 or 12 years. All the species of Ericacææ either require, or prefer, a soil containing more or less of peat or heath mould; and that, though some species of several of the genera will grow in common garden soil, that even these will grow better in soil containing a mixture of sand and peat, together with rich loam, or loam and leaf mould. Hence the Ericacææ, from being a truly natural order in their physiognomy, from being all nearly alike in point of magnitude, from all requiring the same kind of soil, from the species consisting both of deciduous and evergreen plants, and from some of them flowering in every month of the year, are peculiarly well adapted for being cultivated together, so as to occupy one entire scene or garden. This garden, for obvious reasons, we propose to call an ericacetum, which, the

reader will bear in mind, differs from an ericetum, in containing all the plants of the order *Ericææ*, while an ericetum, or heathery, is limited to the species of the section *Ericææ normales*.

All plants which require peat soil do so in consequence of their having hair-like roots; and, in the culture of the ligneous *Ericææ*, as of all plants whatever in peat soil, to insure success, it is essentially necessary to keep the soil in an equable degree of moisture. The reason is, that plants having hair-like roots never extend these to any great distance from the stem, or main root; and, consequently, that they draw their nourishment, or what, in a practical sense, is equivalent to it, their moisture, from a very limited space. Hence, no plants suffer more from drought than the *Ericææ*, whether in the open air in beds, or in the green-house in pots; and no plants are more difficult to recover after they have sustained injury from being kept too dry. Hence, in very hot summers, the rhododendrons, azaleas, and other shrubs of this order, which grow in common garden or shrubby soil, are frequently killed to the ground, without shooting up again the following year, as is the case with the shrubs of most other orders, killed down by drought. Every American garden, therefore, ought to be laid out in some situation, and, according to some principle, not only favourable to the retention of the natural moisture of the soil, but also favourable to the application of moisture artificially. A level surface at once supplies both the conditions to a certain extent; and a level surface, sunk 5 ft. or 6 ft. below the surrounding surface, supplies both in the most perfect manner. The advantage of placing an American ground in an excavation some feet under the surrounding surface is, that the soil in the excavation will always be moister than that of the surrounding surface, in proportion as the one is lower than the other. The soil in such an excavation will also be found cooler than that of the general surface, though both may be alike exposed to the direct rays of the sun. These results may not at the first sight appear obvious; but they take place in consequence of temperature and water having both a continual tendency to come to a level.

An ericetum ought, therefore, to be laid out in an excavation, the surface of which is reduced to a perfect level, in order to gain all the advantages of moisture and coolness which the natural situation affords: and, to admit of supplying water artificially to the soil in the beds in the most economical manner; and, at the same time, in the manner best adapted for the plants, the excavation should be intersected with drains at regular distances; all these drains communicating with a main drain in the centre, and this main drain communicating with the source of the water, which should be so arranged as to be turned on and turned off at pleasure. The drains may be laid out in parallel lines, 10 ft. or 12 ft. apart, and 2 ft. or 3 ft. under the surface; and they may be formed of bricks, laid without mortar, 9 in. deep, and $4\frac{1}{2}$ in. wide. The main drain in the centre, with which they communicate, may be a foot wide, and a foot deep. The bottom of all the drains ought to be on the same level. The water may be admitted to one end of the main drain by various means. If conveyed under ground in a pipe, that pipe should be 3 ft. or 4 ft. under the surface, so as not to be injured by frost; and the stopcock may be reached from the surface through a vertical shaft of 2 in. or 3 in. in diameter, formed by brickwork, and closed at the surface by a brick or stone, so as not to appear unsightly. If the water is supplied from a pump on the spot, that pump need not lift the water higher than the upper surface of the drain; and it may easily be contrived with a removable handle, so as to have no appearance of a pump, except when it is in use. Where the water is supplied by water-carts, or from a pond at a short distance, it is only necessary to pour it into the main drain through a funnel carried up in masonry or brickwork to the surface, from the centre of the main drain, having a stopper of brick or stone to put on when not in use.

Water may be supplied artificially to an ericetum by surface drains; but these will not apply so well as under drains, in cases where the garden con-

sists solely of beds and gravel walks, as is sometimes the case; but they are peculiarly applicable where the general surface is of turf, even if that surface should not be level. The opening of these surface drains need not be more than $2\frac{1}{2}$ in. wide, and 6 in. deep, formed of bricks, laid on edge for the sides,

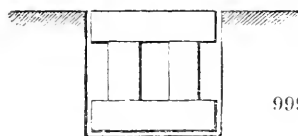

999

and flatwise for the bottom and top, as shown in *fig. 999*. The upper surface of the covering bricks of this drain should be level with the surface of the lawn; and, as the covers would be laid on alternately crosswise and lengthwise, the appearance would be as in *fig. 1000*. The upper sur-

face of the bricks, being exposed to the air and weather, would soon assume a dingy colour, so as to harmonise with the green of the turf; and, being as perfectly even and smooth as the ground on each side, they would offer no obstruction to walking, rolling, or mowing. The brick-



1000

work of the drain should be formed without mortar, in order to let the water escape at the bottom and sides; and to admit of taking off the top bricks to clear out any fibrous roots, or any other obstruction that might be formed in it. If the appearance of the bricks were thought a deformity, the brickwork might be sunk 3 in. deeper, and covered with turf; and, if the expense of bricks were an object, it might be lessened by employing earthenware pipes, of small diameter, not cementing them at the joints, or using draining or ridge tiles, and setting them on common flat tiles, and covering the whole with soil and turf, so as not to show any appearance of a drain on the surface, as shown in *fig. 1001*. Drains of this kind are not adapted for being laid out in parallel straight lines in ericacetaums, because these lines would necessarily interfere with the dig groups; but they are well adapted for being carried in irregular lines in the glades of turf between the beds; and they may be supplied with water at one or both ends. Even an ericacetaum, or other garden or lawn, on an irregular surface, may be watered in this way, on the principle on which surface irrigation is practised on hilly ground; viz. beginning on the highest spot, and winding the drain about,

always with a certain degree of steepness, till the lowest ground is reached. The whole of any lawn or park, however irregular it might be on the surface, might be kept moist in this way during the hot summer months, without a drop of water being ever seen upon the grass.

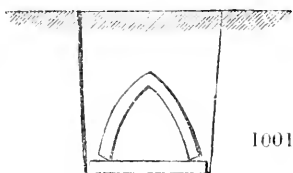

1001

Another mode of supplying water to an ericacetaum is by simply flooding the surface, which, being on a perfect level, might be done to the depth of an inch or more, in the evening, once or twice a week, during very hot weather, without risk of injuring the plants.

Should, however, the surface of the ericacetaum be 5 ft. or 6 ft. below the general surface of the ground, and if it be formed in a soil not naturally very porous and dry, such as gravel or sand, chalk, &c., very little artificial watering will be necessary; and both under drains and surface drains may be omitted.

In planting an ericacetaum, whatever may be the form of the bed, the plants ought to be placed so far apart as to allow them to branch out freely in every direction without touching one another. It is only when they are grown in this manner that they flower freely, and become covered with flowers on every side, and over the whole plant. In the after-management, whenever any plant

gets so large as to touch the adjoining ones, it ought to be taken out; or, if it is an old plant, it may, perhaps, be cut back; or all the plants in the bed may be taken up, and re-arranged at greater distances from one another than they were before.

We have already observed (p. 1076.) that no plants suffer less from removal than the *Ericacææ*, because they may always be taken up with balls, and, indeed, may be removed when they are in full flower. The best season for removal is moist weather in autumn; and the next best, moist weather in April or May. (See *McNab's Hints on the Planting and general Treatment of Hardy Evergreens*; and *Gard. Mag.*, vol. vii. p. 78., and vol. xii. p. 567.)

The soil of the beds ought to be wholly renewed every five or six years; and, when this is done, all the plants ought to be taken up and divided, pruned, or thrown away, and replaced with other plants, as may be found necessary. The soil removed may be laid in ridges, in the reserve garden, and mixed with an equal quantity, or more, of leaf mould; and, after lying a year or two, it may again be put to use in the ericacetum. The cultivator of *Ericacææ*, of roses, and of other shrubs that are grown chiefly for their flowers, should bear constantly in mind, that these will not be produced in abundance, and of fine forms and colours, unless the plant have ample nourishment, light, and air. Instead, therefore, of rhododendrons and azaleas being planted in poor heath soil, and being crowded together so as to show only the upper surface of the plants, as they now are in most gardens, they ought to be planted in sandy peat and loam, enriched with a large proportion of leaf mould; and each shrub ought to stand perfectly detached; and it should rather be as much as 2 ft. from the adjoining one, than so near it as 2 in., in order that the roots may have sufficient space on every side to enable them to collect nourishment, and that the heads of the plants may not shade one another. The only two ericacetums that we recollect seeing managed to our satisfaction in these particulars are, that of the Rev. Thomas Garnier, at Bishopstoke Vicarage; and that at Bagshot Park, under the care of Mr. Toward. At the former place the *Ericacææ* are planted in roundish groups on the lawn adjoining the house; and they grow so vigorously that they are taken up and replanted every two years, generally in the month of September. The azaleas and rhododendrons are taken up with large balls of earth; and the ground is so well watered at the time of replanting, that the plants never lose any of their leaves. They are placed at such distances as nearly to touch one another; so that, if they were not taken up, and placed farther apart every two years, they would soon form a matted thicket, and display blossoms only on their upper surface; whereas, by keeping each plant distinct, it displays its blossoms all round from the ground to the summit. The soil in which these plants are grown is composed of two thirds of sandy peat, and one third of rich loam. The loam, Mr. Garnier finds absolutely necessary to promote the vigorous growth of azaleas, rhododendrons, and almost all kinds of American shrubs. (*Gard. Mag.*, vol. x. p. 129.) Mr. Gow, gardener at Tullyallan, in Perthshire, found *Rhododéndron póncium*, and some others of the more vigorous-growing *Ericacææ*, thrive in clayey loam, and in common garden soil, which had been deeply trenched, and mixed with abundance of leaf mould and road scrapings. (*Ibid.*, p. 35.)

The order in which the different species of *Ericacææ* are disposed in an ericacetum may be various. Where there are but a few kinds to be distributed over a large space, the same species may occur in two or three places; but, where there is a very complete collection, most effect will be produced by keeping all the plants, of every species and variety, together; so that the same species may never be found in two different places. Where the object is more to excite a botanical interest than a floricultural or a picturesque one, the genera, species, and varieties should follow each other, or be grouped together, much in the same way as they are in botanical works; for example, in this *Arboretum*: but, in other cases, the evergreen species may be intermixed with the deciduous ones, so as to give a clothed appearance to every

part in the winter season. If there were sufficient room, the mode which we should recommend as decidedly the best would be, to allot a circular space of dug ground to every plant, according to its size, enlarging the diameter of that circle as the plant increased, and grouping the circles along one or both sides of a walk. The next best plan is, to have a circle devoted to each genus and its species, of kinds of which there are few varieties; and to each species and its varieties, where the varieties of each species are numerous; or to have a group to consist of several plants for each variety of the more showy kinds of azalea and rhododendron; and place the less showy kinds in groups containing two or three sorts each.

The design *fig.* 1002. is calculated for an ericacelum of this description. In it the space *a a* included by the wall is a perfectly level lawn; and it is also perfectly level from *b*, by *c*, to *a*. Beyond these points, the ground gradually rises, and is planted solely with American trees. The groups in which shrubs are represented are planted with evergreens; and all the others with deciduous shrubs. The groups also from *c* to *d* are devoted to American shrubs not belonging to the order *Ericææ*, deciduous and evergreen; so that this scene, taken as a whole, may be considered as an American arboretum and fruticetum.

For displaying a choice collection of *Ericææ* to the greatest advantage, the most effectual mode is, to dispose of them in lineal succession; so as that one species or variety may be examined quite near the eye, and one after another. *Fig.* 1003. is a design made with a view to this mode of disposing of a complete collection. The beds marked *a* and *b* are to be planted with evergreens at regular distances; as are the central groups in which shrubs are indicated. The other beds and circular groups, which are shaded, are for deciduous shrubs. The general surface is perfectly level, and the surrounding plantation consists solely of the pine and fir tribe, including the genera *Cuprèssus*, *Thiija*, and *Juniperus*. The lowest-growing species are placed next the walk, and the taller ones behind in gradual succession, so that the trees may rise one above another, and form a complete amphitheatre of perpetual verdure. If such an ericacelum were formed in a rocky country, in one of those small level spots of peat soil, which so frequently occur in North Wales and in the west of Scotland, the expense would be very trifling, and the effect would be interesting and splendid beyond description, presenting the character of alpine scenery as a framework to the American picture. In detail, this design differs from the preceding one in each particular system of concentric beds being hollowed out in the middle, as indicated by the sectional line *f f*. The central beds, being so much lower than the others, are intended to contain the taller-growing evergreen species; such as *Arbutus* and *Rhododéndron*, for the two larger beds; *Andrómeda* for the next largest; *Vaccínium* for the next; and *Erica* for the least. From the walk *g*, in each of the systems, it is intended that the eye should look down upon the central bed, the surface of which, taking the height of a man's eye from the ground at $5\frac{1}{2}$ ft., will be 9 ft. below it.

As an example of a very simple, but still ornamental, mode of laying out an ericacelum, we refer to *fig.* 1004., which is adapted for the same piece of ground, excavated to the same depth, and reduced to one level, as in the preceding designs. In this plate, *a* represents the situation of an exotic ericetum, and *b* of a hardy ericetum; *c* an azalea garden, near which, at *d*, there may be a summer-house, or a range of plant-houses; *e e* are groups planted with deciduous and evergreen American *Ericææ*; and *f f* are beds which may be planted with other peat-earth plants which are natives of Europe and Asia; and the trees forming the amphitheatre to this picture may be composed of evergreens from all countries. An ericacelum of this kind, as it is supposed to contain only the hardiest species in the open air, would be well adapted for the northern parts of the island; since many of the American deciduous shrubs thrive in the open air, even in Sutherlandshire.

These three designs being adapted to a particular situation (as explained in

1002

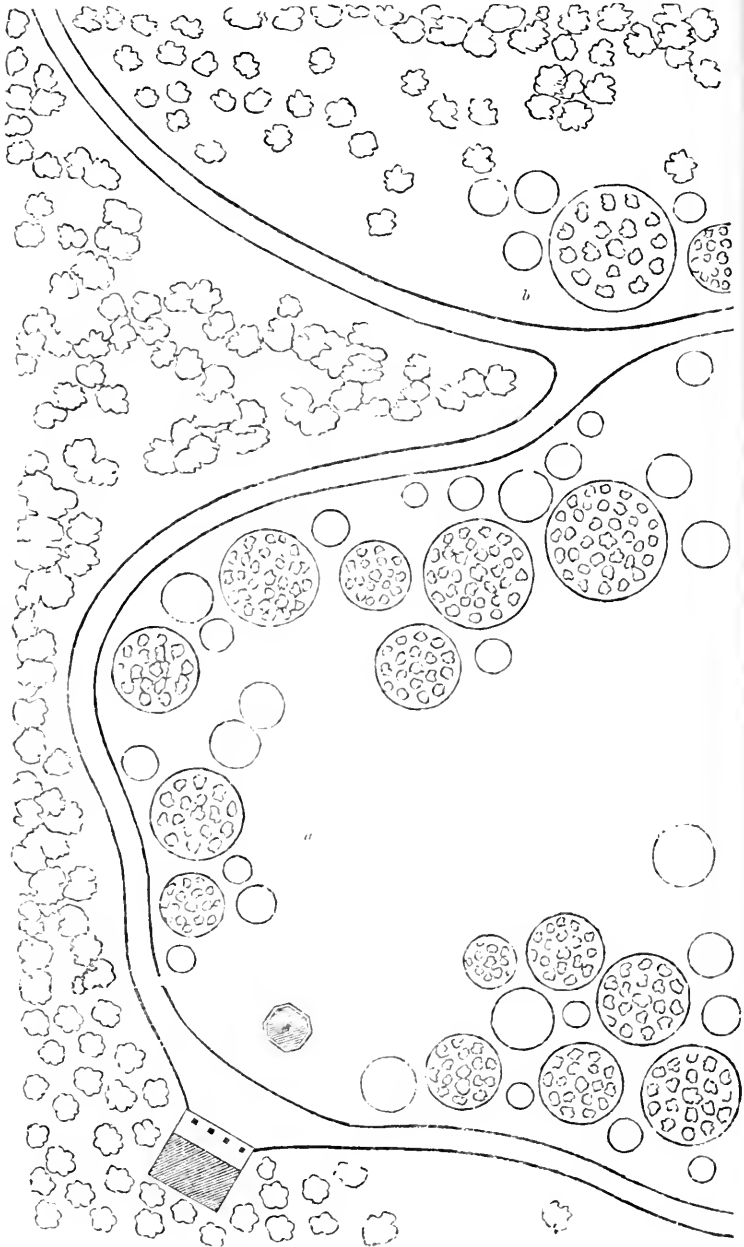

1002

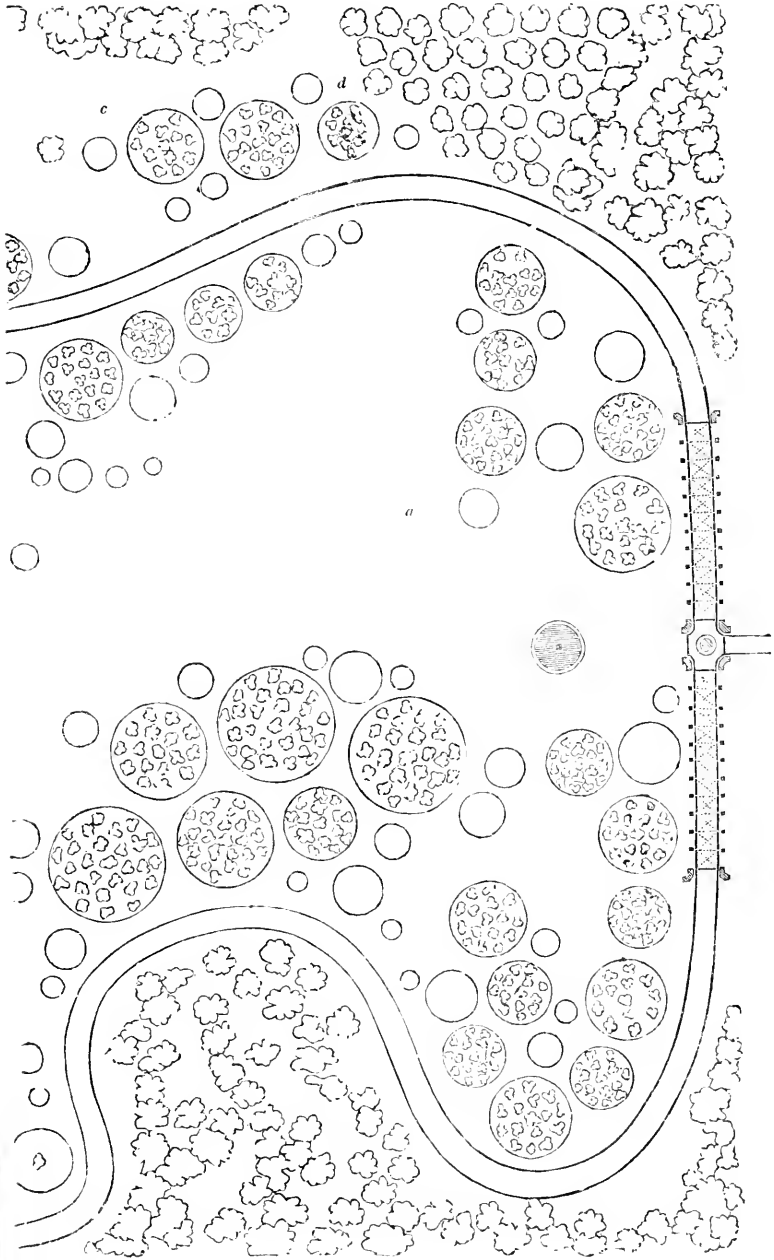

1003

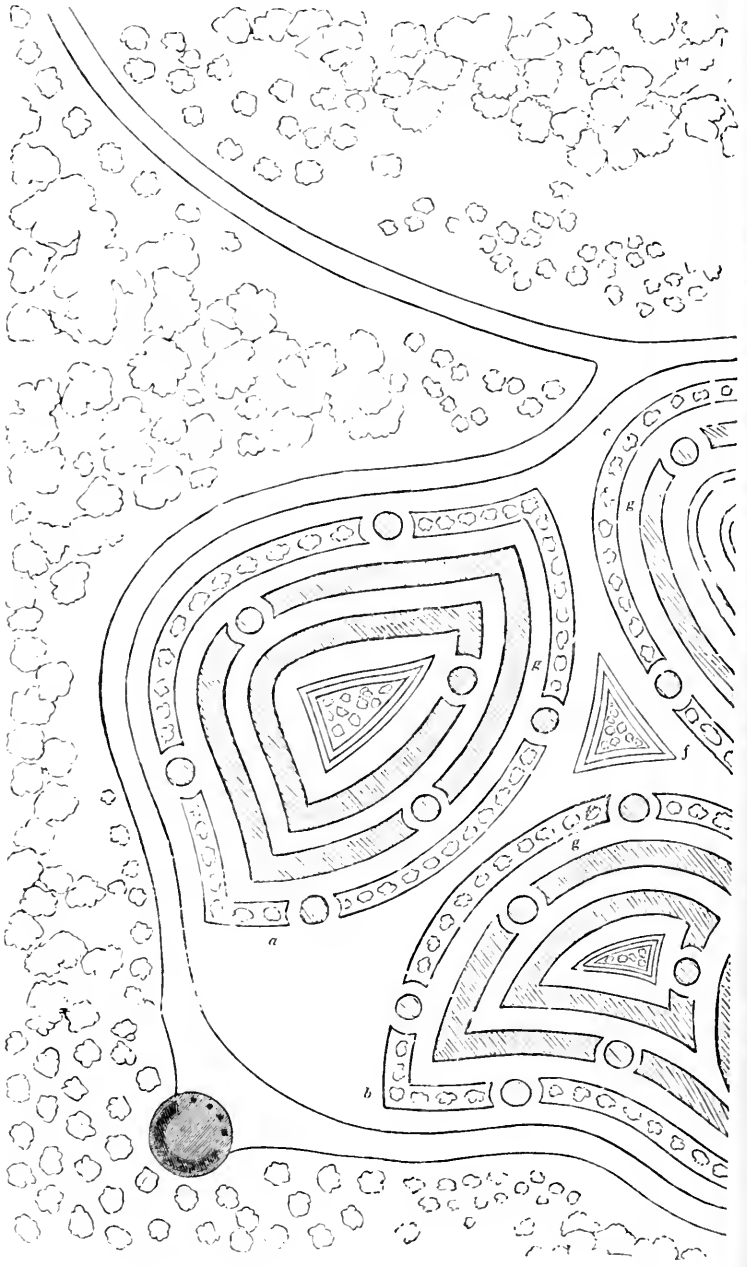

1003

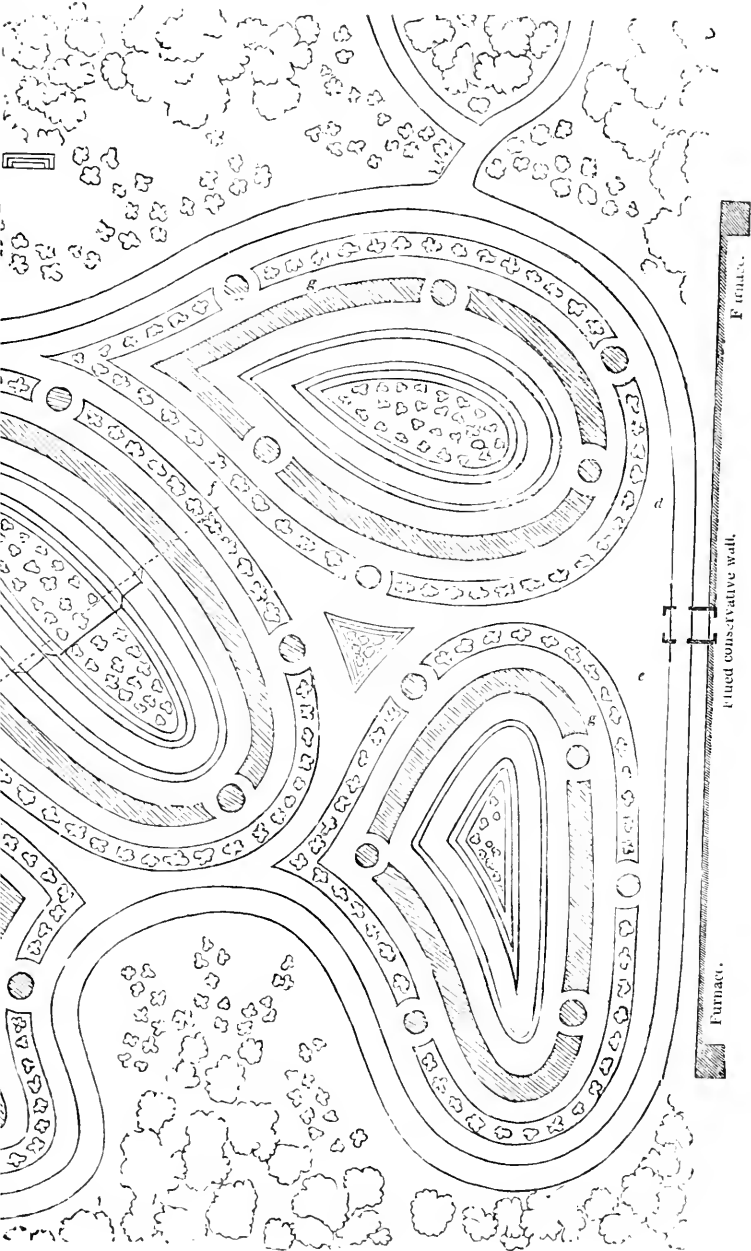

1004

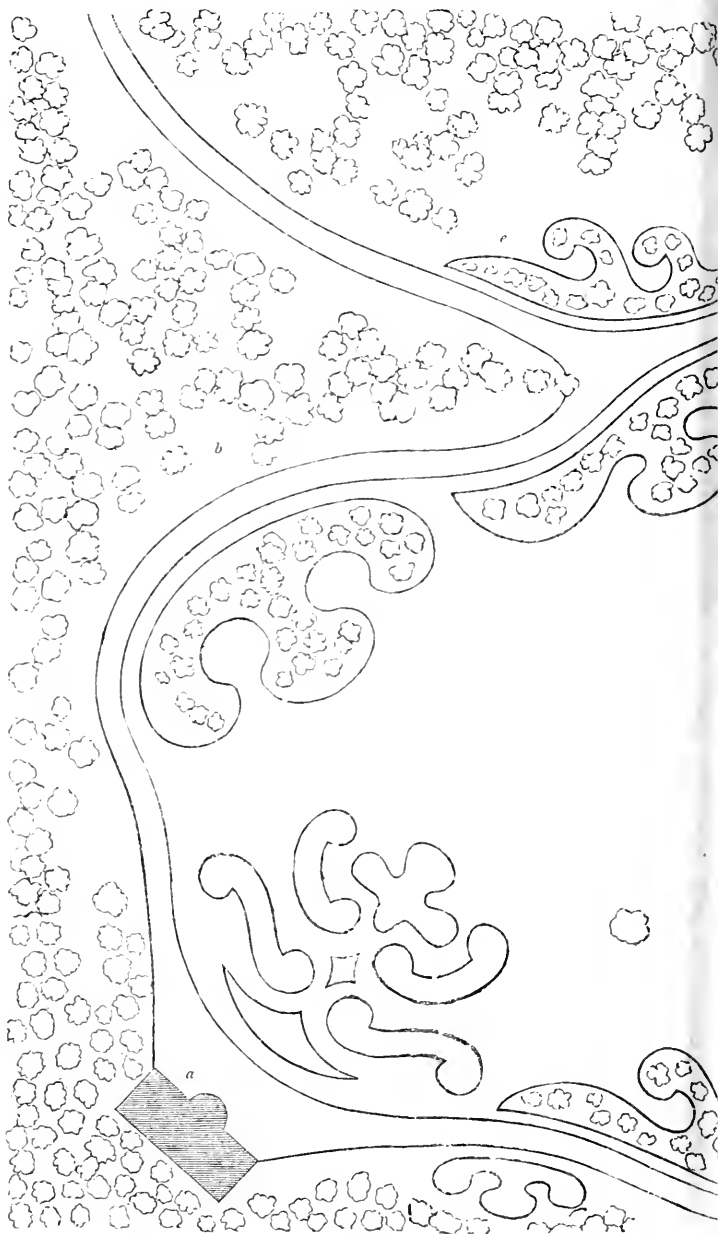

1004

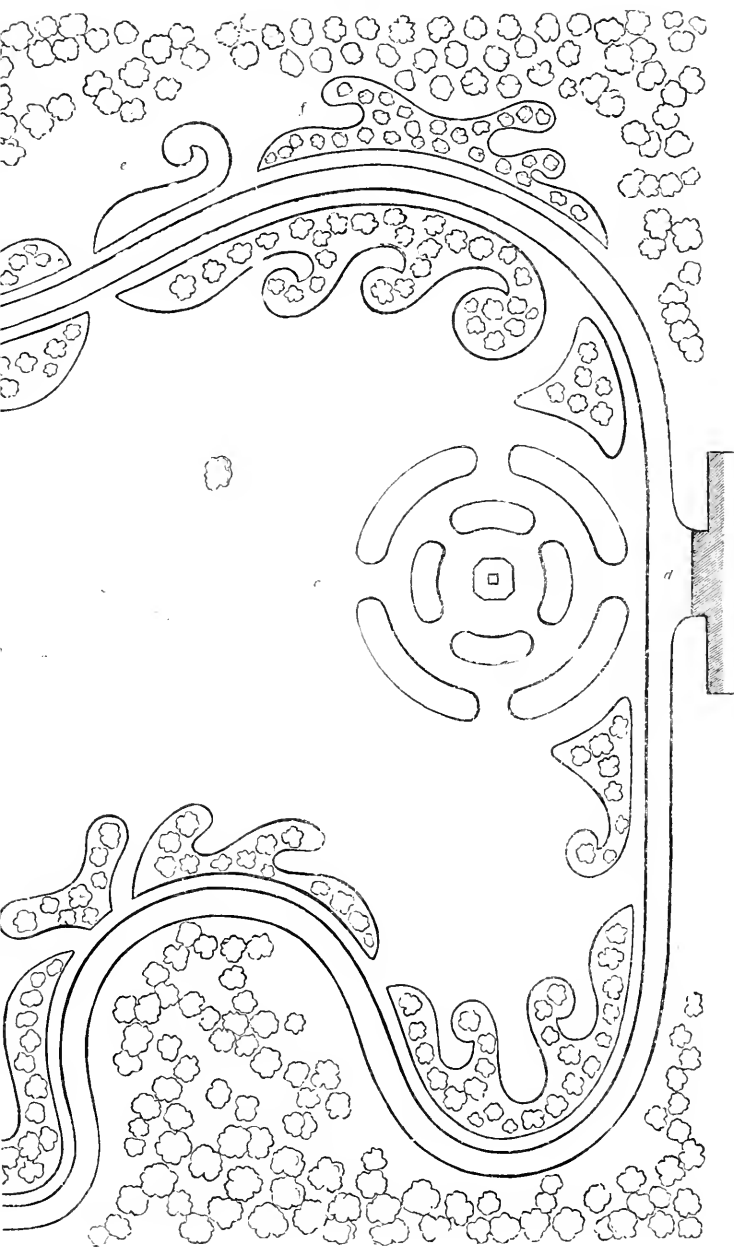

Gard. Mag., xi. p. 237.), by their irregularity of outline, show that no particular form is necessary for an ericacelum, or any other description of American garden, or other fruticetum; provided the surface be either brought to a level, or so contrived as to be kept cool and moist, either by nature or art. The

1005

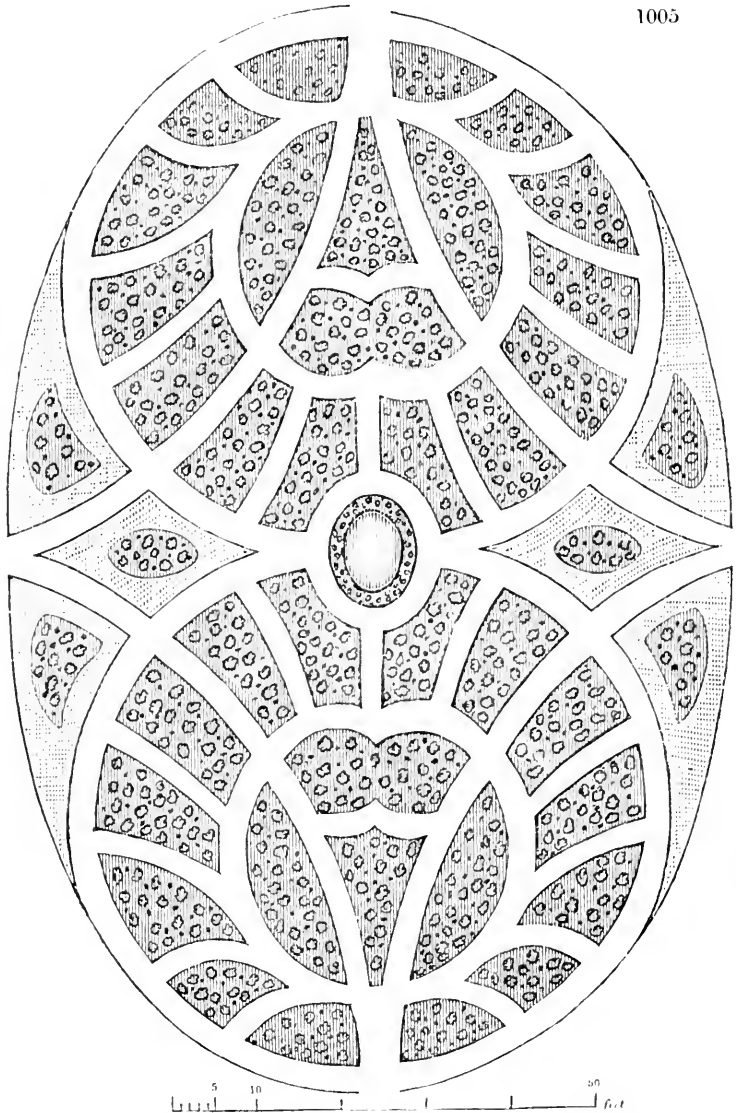

most irregular rocky surface may be planted as an ericacelum, provided it is naturally cool and moist, either from the quality of the soil, the presence of water, or the nature of the climate. For example, in Cumberland or Westmoreland, among the lakes, an ericacelum may be planted any where, without regard to either moisture or surface, from the abundance of rain that falls in that climate.

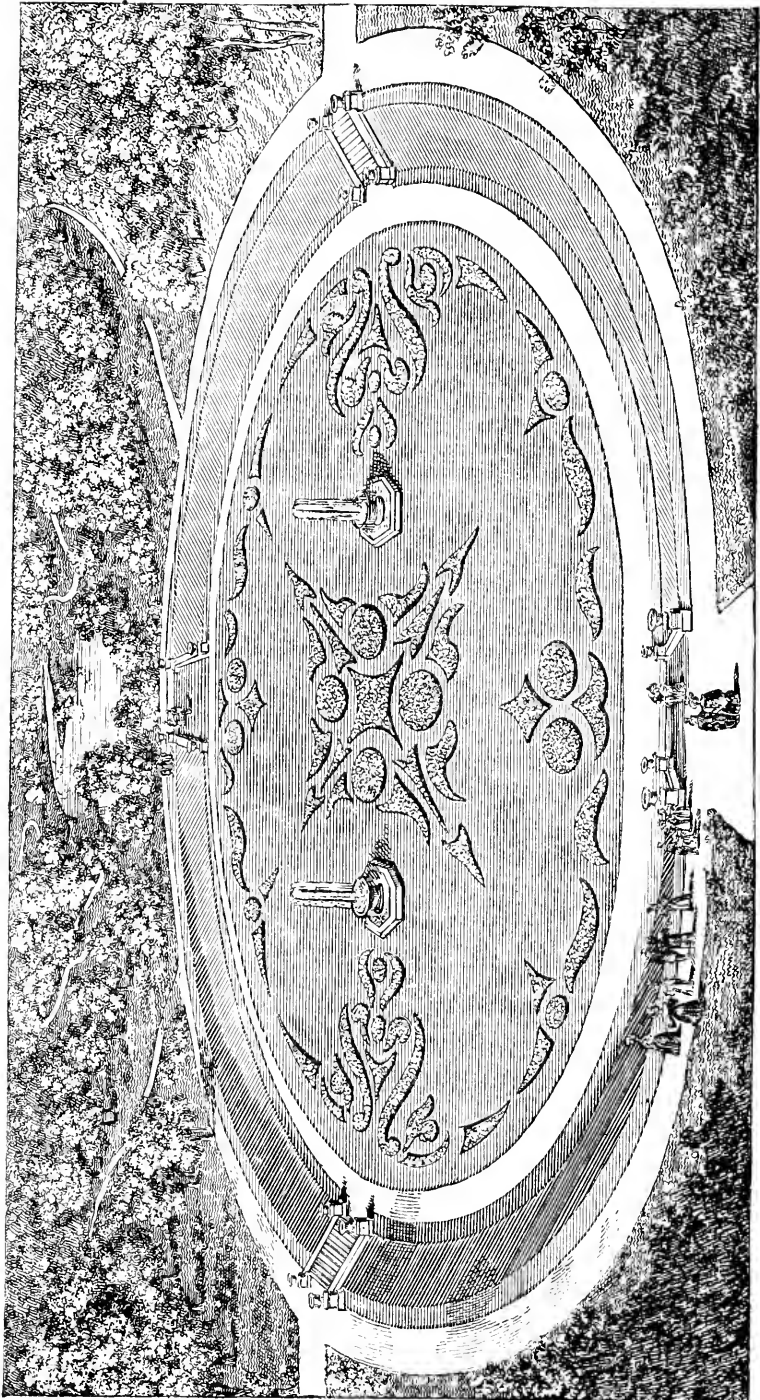

Where a regular form is preferred, and where the space to be devoted to an ericacetus is limited, we would recommend an excavation surrounded by a sloping bank and a terrace walk, treated in the same general style as the design for the ericacetus *fig.* 888. p. 1099. In such a case, the substratum of every walk might, if necessary, be made into a drain, which could easily be done by forming the walks of pavement, supported by two walls of brick, 4 in. wide, and 1 ft. or 1 ft. 8 in. high. *Fig.* 1005. p. 1184. is a design for the area of an oval ericacetus by Mr. Rutger, which may be treated in the same manner as the ericacetus referred to. Instead of being surrounded by a sloping bank of turf, this design is supposed to be bounded by a sloping bank of rhododendrons, so arranged as to complete the figure of a parallelogram. Beyond these evergreens, and 8 ft. or 10 ft. above the level of the area, may be a terrace walk; and beyond that a border, and a wall, for containing half-hardy ligneous species, and growing a collection of bulbs. A portion of the area is shown in turf, with beds in the centre of each compartment. These beds are supposed to be exclusively devoted to Cape heaths, grown in large pots or tubs, like those in the Edinburgh Botanic Garden, plunged out in these beds in the summer time, and taken in on the approach of winter. The beds, after the pots are removed, may be turfed over till the following spring; or filled with winter-flowering hardy heaths.

Every description of garden, to be complete, requires some architectural appendages to be introduced into it. As water is so necessary in the cultivation of all plants, an architectural fountain is at once an ornamental and a useful object to every scene of culture, however small, or however large; and the magnitude and style of design of fountains may be varied almost infinitely. The next class of useful ornaments are, seats, or resting places, open and covered: and these lead to an almost endless variety of structures; some of wood, and portable; and others of wood, of rustic-work, or of masonry, and permanently fixed. *Fig.* 1006. p. 1185. is a design from the elegant pencil of Mr. Lamb, in which the ericacetus is of an oval form, surrounded by a terrace 5 ft. above it, from which there are flights of steps to descend to the area containing the beds for the plants. This area is ornamented with two fountains; and there are stone seats along the terrace walks, and also in the surrounding amphitheatre of trees.

CHAP. LXX.

OF THE HARDY AND HALF-HARDY LIGNEOUS PLANTS OF THE ORDER SYMPLOCA'CEÆ.

THIS order contains only one genus, *Symplocos*, the species of which are chiefly tender shrubs or trees from South America; but there is one, a native of China, which is considered half-hardy; and another, a native of Nepal, which might probably thrive in the open air with a little protection, but which has not yet been introduced. In the south of England, wherever there is a tolerably complete collection of half-hardy ligneous plants, the genus *Symplocos*, as being the representative of an order, should never be omitted.

Symplocos snica Ker Bot. Reg., t. 710., and our *fig.* 1007., has the leaves elliptic-oblong, attenuated at both ends, mucronately serrated, downy on both surfaces, and wrinkled; racemes compound, terminal, and axillary. It is a shrub, growing to the height of 3 ft., a native of China. Introduced in 1822, and producing its delightfully fragrant white flowers in May. It requires a wall, and is rare in British collections.

S. cratægoides Hamilt., Don's Mill., 4. p. 3., has ovate, acute, serrated leaves, and the habit of *Cerasus Mahaleb*. It has not yet been introduced



CHAP. LXXI.

OF THE HARDY LIGNEOUS PLANTS OF THE ORDER STYRACEÆ :

GENUS I.

STYRAX L. THE STORAX. *Lin. Syst. Decándria Monogýnia.*

Identification. Lin. Gen., No. 595.; Tourn., t. 369.; Juss. Gen., 156.; Gærtn. Fruct., l. p. 284. t. 59. Lindl. Nat. Syst. Bot., 2d edit., p. 228.; Don's Mill., 4. p. 4.

Synonymes. Alibocifier, Fr.; Storax, Ger.

Derivation. The word *storax*, applied to this plant by Theophrastus and Dioscorides, is a mere alteration of *assthirak*, the Arabic name of *S. officinale*.

Gen. Char., &c. *Calyx* permanent, campanulate, 5-toothed. *Corolla* monopetalous, funnel-shaped, deeply 3—7-cleft, but usually 5- or 6-cleft, valvate in æstivation. *Stamens* 10, exserted. Filaments monadelphous at the base, adnate to the tube of the corolla. *Anthers* linear, 2-celled, dehiscing lengthwise inwardly. *Ovarium* superior, 3-celled, many ovuled, erect. *Style* 1. *Stigma* obsolete 3-lobed. *Drupe* nearly dry, containing a 1-celled, 1—3-seeded nut. *Testa* of seed double; inner cobwebbed, outer spongy. *Embryo* inverted, with elliptic cotyledons, and a thick superior radicle. *Albumen* fleshy. (*Don's Mill.*, iv. p. 4.) — Elegant trees or shrubs, of which 27 species are described in Don's *Miller*, chiefly natives of Asia and South America; but there are four hardy species, natives of Europe or North America, which are cultivated in British gardens. They require a soil rather light than otherwise, on account of their hair-like roots; and to be placed against a wall, in the climate of London, when it is intended that they should flower freely. In affinity, as well as in general appearance, this genus approaches near to that of *Halësia*; and there is such a close general resemblance among all the allied species of *Styrax*, that they may possibly be only varieties of one form. The price of plants, in the London nurseries, is from 1s. 6d. to 2s. each.

♁ 1. *S. OFFICINALE* L. The official Storax.

Identification. Lin. Sp., 635.; N. Du Ham., 7. p. 7.; Don's Mill., 4. p. 4.; Lodd. Cat., ed. 1836.

Synonymes. Lagomélia, *Modern Greek*; *Sturax kalamitës*, *Ancient Greek*.

Engravings. Cav. Diss., 6. p. 338. t. 118. f. 2.; Woodv. Med. Bot., 197. t. 71.; Church, et Stev. Med. Bot., 1. t. 47.; Andr. Bot. Rep., 631.; Lodd. Bot. Cab., 928.; Plenck Icon., 341.; Mill., fig. 260.; Lob. Icon., 151.; N. Du Ham., 7. t. 4.; and our fig. 1008.

Spec. Char., &c. Leaves ovate, clothed with hoary hairs beneath, shining and green above. Racemes simple and axillary, 5—6-flowered, shorter than the leaves. Leaves about 2 inches long. Flowers white. Drupe ovate globose. (*Don's Mill.*, iv. p. 4.) A shrub or low tree, from 12 ft. to 15 ft. high; a native of Syria and the Levant. Introduced in 1597, and producing its flowers, which resemble those of the orange, but are smaller, in June and July. It is naturalised in hedges in some parts of Italy, particularly near Tivoli. It has been known in England since the time of Gerard, who had two small trees of it in his garden, "the which," he says, "I have recovered of the seed." As the plant does not grow very freely, except when placed against a wall, it is not very common in collections, though it well merits a place there, on account of the beauty of its pure white flowers, and the great profusion in which they are produced. The finest specimen in the neighbourhood of London, and perhaps in Britain, is in the Chelsea Botanic Garden, where it is 12 ft. high, against



1008



a wall, flowering profusely every year, and ripening fruit. There is also a very fine tree against a wall at Messrs. Loddiges's, which was profusely covered with flowers when we saw it, on June 18. 1836; and with fruit, on August 18. of the same year.

Properties and Uses. The *Styrax officinale* is chiefly useful in a medical point of view; the powerful and fragrant balsam called storax being obtained from it. For this purpose, incisions are made in the bark of the trunk and branches, from which incisions the resin issues in a liquid state, and is either collected in reeds (whence its ancient Greek name of *Sturax kalamitēs*), or left to harden, when it is scraped off in irregular compact masses, interspersed with smaller pieces, which are called tears. Storax is stimulant and expectorant, and was formerly prescribed for asthma and chronic affections of the windpipe; but, according to Dr. Thompson, it is now scarcely ever used. In Gerard's time, there were made from it "sundry excellent perfumes, pomanders, sweet waters, sweet bags, sweet washing-balls, and divers other sweet chains and bracelets." In the present day, it is much used in Roman Catholic countries to burn as incense. Chemically, it consists principally of resin, with a small portion of benzoic acid; and it dissolves easily in spirits of wine. The common storax of commerce differs from that of the apothecaries, and is a liquid balsam, said to be obtained from *Liquidambar styraciflua*.

Soil, Propagation, &c. A light sandy soil, rich rather than poor, suits this species best; and it is generally propagated by seeds obtained from the south of France. It will also grow by layers, and by cuttings. It is observed in the *Nouveau Du Hamel*, that it does not flower well in pots or boxes; and that it does best near Paris when placed against a wall with a southern exposure, and protected during winter. In the neighbourhood of London, however, it does not require protection. Its rate of growth, for the first ten years, is not above 8 in. or 9 in. a year. Price of plants, in the London nurseries, 1s. 6d. each.

✻ 2. *S. GRANDIFOLIUM* Ait. The large-leaved Storax.

Identification. Ait. Hort. Kew., 2. p. 75.; Pursh Fl. Amer. Sept., 2. p. 450.; Don's Mill., 4. p. 4.
Synonymes. *S. officinale* Walt. Fl. Carol., 140.; *S. grandifolium* Michx. Fl. Bor. Amer., 2. p. 41.
Engravings. Lodd. Bot. Cab., t. 101b.; Wats. Dend. Brit., t. 129.; and our fig. 1009.

Spec. Char., &c. Leaves broad, obovate, acuminate, green above, but clothed with hoary tomentum beneath. Lower peduncles solitary, 1-flowered. Flowers white. (*Don's Mill.*, iv. p. 4.) A shrub or low tree, growing from 8 ft. to 10 ft. high. A native of North America, in woods, on the banks of rivers from Virginia to Georgia. Introduced in 1765, and flowering from June to August. It is a fine ornamental shrub, but not common in collections. *Halèsia díptera*, the leaves of which closely resemble those of *Styrax grandifolium*, but differ from it in not being downy beneath, is frequently sold for it in the nurseries. It requires the same treatment as *S. officinale*, of which it appears to us to be only a variety.



✻ 3. *S. LEVIGATUM* Ait. The smooth-leaved Storax.

Identification. Ait. Hort. Kew., 2. p. 72.; Willd. Sp. Pl., 2. p. 624.; Don's Mill., 4. p. 4.
Synonymes. *S. octandrum* L'Hérit. Stirp. Nov., 2. t. 17.; *S. glabrum* Cav. Diss., 6. p. 340. t. 188. f. 1., Pursh Fl. Amer. Sept., 2. p. 450.; *S. læve* Walt. Fl. Carol., 140.; *S. americanum* Lam. Dict., 1. p. 82.
Engravings. Bot. Cab., t. 960.; Wats. Dend. Brit., t. 40.; and our fig. 1010.

Spec. Char., &c. Leaves oval-lanceolate, acute at both ends, glabrous on both surfaces, toothed. Peduncles axillary, or twin, 1-flowered. Stamens

from 6—10. (*Don's Mill.*, iv. p. 4.) A shrub, from 3 ft. to 4 ft. high; a native of South Carolina and Virginia, in swamps. It is stated to have been introduced in 1765, and it flowers in July and August. It bears a close general resemblance to *S. officinale*, but is smaller in all its parts. Whether a species or a variety is a matter of the less consequence in a gardening point of view; as few plants of the woody kind better deserve a place against a wall, on account of the beauty of its white blossoms, which resemble those of the jasmine, and are produced in the greatest abundance, on almost every part of the plant. In fine seasons, these are succeeded by fruit about the size of a red currant, or of the fruit of the nettle tree. Price, in the London nurseries, 2s. each; and at New York, 50 cents.



1010

✻ 4. *S. PULVERULE'NTUM* Michx. The powdery Storax.

Identification. Michx. Fl. Bor. Amer., 1. p. 41.; Wats. Dend. Brit., t. 41.; Don's Mill., 4. p. 4.

Synonyme. *S. lævigatum* Curt. Bot. Mag., t. 921.

Engravings. Bot. Mag., t. 921.; Wats. Dend. Brit., t. 41.; and our fig. 1011.

Spec. Char., &c. Leaves almost sessile, ovate or obovate, obtuse, clothed with powdery tomentum beneath. Flowers axillary, and nearly terminal by threes, on short pedicels. (*Don's Mill.*, iv. p. 4.) A shrub, from 4 ft. to 6 ft. high; a native of Virginia and Carolina, in woods. It was introduced in 1794, and flowers from June to August. According to Pursh, it bears a close general resemblance to *S. grandifolium*.



1011

CHAP. LXXII.

OF THE HARDY LIGNEOUS PLANTS OF THE ORDER HALESIA'CEÆ.

GENUS I.



HALE'SIA Ellis. THE HALESIA, or SNOWDROP TREE. *Lin. Syst.*
Dodecándria Monogýnia.

Identification. Ellis in *Lin. Gen.*, No. 596.; *Gärtn. Fruct.*, 1. p. 160. t. 32.; *Juss. Gen.*, 156.; *Lindl. Nat. Syst. Bot.*, p. 228.; *Don's Mill.*, 4. p. 6.

Synonyme. Halésie, *Fr.* and *Ger.*

Derivation. Named by Ellis in honour of the learned and venerable *Stephen Hales*, D.D. F.R.S., author of *Vegetable Statistics*.

Gen. Char., &c. *Corolla* monopetalous, ventricosely campanulate, with a 4-lobed erect border. *Stamens* 12 to 16. *Filaments* combined into a tube at the base, and adnate to the corolla. *Anthers* oblong, erect, 2-celled, dehiscent lengthwise. *Orarium* inferior. *Style* 1. *Stigma* simple. *Drupe* dry, corticate, oblong, with 2—4-winged angles, terminated by the permanent style, containing a 2—4-celled putamen, which is acute at both ends. *Cells* 1-seeded. *Seeds* attached to the bottom of the cells. *Testa* of seeds simple, very thin. *Embryo* the length of albumen, with linear-oblong cotyledons, and a long, linear, compressed, inferior radicle. *Albumen* fleshy.—Trees, with alternate serrated leaves, and lateral fascicles of pedicellate

drooping, white flowers. (*Don's Mill.*, iv. p. 6.) Nearly allied to *Symplocææ*. The species are among the hardier of the North American trees. Both in England and Scotland, in favourable situations, they attain the height of from 20 ft. to 30 ft.; and, in the climate of London, they not only flower freely, but ripen seeds in abundance.

‡ 1. H. TETRA'PTERA L. The four-winged-fruited *Halesia*, or common *Snowdrop Tree*.

Identification. Lin. Sp., 636.; Ellis in Phil. Trans., vol. 51. p. 931. t. 22. f. A.; *Don's Mill.*, 4. p. 6.

Synonyms. The Snowdrop Tree, Silver Bell Tree, *Amer.*

Engravings. Curt. Bot. Mag., t. 910.; Lodd. Bot. Cab., t. 1173.; Cav. Diss., 6. p. 338. t. 186.; Lam. Ill., 403.; our fig. 1012.; and the plate in our last Volume.

Spec. Char., &c. Leaves ovate-lanceolate, acuminate, sharply serrated. Petioles glandular. Fruit with 4 wings. Leaves acuminate, with the middle depressed. Flowers pure white, 9—10 in a fascicle, drooping, resembling those of the snowdrop. The wood is hard and veined; the bark is of a darkish colour, with many irregular fissures. (*Don's Mill.*, iv. p. 6.) A tree, from 15 ft. to 30 ft. high, a native of South Carolina, along the banks of rivers. It was introduced in 1756, and flowers in April and May. Its flowers are produced in great abundance; and, from their shape, colour, and pendulous appearance, they are considered as resembling those of the snowdrop. It is one of the most ornamental of the American deciduous trees, and richly deserves a place in every collection. The rate of growth, for the first five or six years, is 1 ft. or 18 in., or more, a year; and in ten years it will attain the height of 12 ft., or 15 ft., if properly treated; but, as it is generally kept too dry, it is seldom seen at above half this height at that age. It ripens seeds freely in this country; from which, or from imported seeds, it is readily increased. The seeds often remain above a year in the ground. Planted singly in an American ground, or in a sheltered situation in a shrubbery, or plantation, this tree makes a splendid appearance in May.



Statistics. In the environs of London, the finest specimens are at Purser's Cross and Syon House, in both which places it is 30 ft. high, with a trunk from 16 in. to 18 in. in diameter. There is a very singular tree at Syon, of which there is a portrait in our last Volume, the diameter of the head of which is 52 ft. Another tree, at Syon, 29 ft. high, has the diameter of the head 40 ft. In Surrey, at Bagshot Park, a tree, 20 years planted, is 20 ft. high, the diameter of the trunk 5 in., and of the head 12 ft., in sandy loam. In Devonshire, at Kenton, it is 25 ft. high. In Cornwall, at Caulen Penryn, 20 ft. high. In Shropshire, at Willey Park, 15 years planted, it is 17 ft. high. In Staffordshire, at Treutham, 26 years planted, it is 15 ft. high, the diameter of the trunk 11 in., and of the head 25 ft.; at Alton Towers, 10 years planted, it is 15 ft. high; and in the Handsworth Nursery, it is 20 ft. high, with a trunk 12 in. in diameter, in loose sandy gravel. In Suffolk, at Ampton Hall, 10 years planted, it is 8 ft. high. In Scotland, in Aberdeenshire, at Thainston, it grows 1 ft. a year as a standard, but dies back a few inches annually. In Argyllshire, at Toward Castle, 8 years planted, it is 7 ft. high. In Banffshire, at Huntly Lodge, 12 years planted, it is 12 ft. high. In Ireland, in the county of Down, at Ballyleady, 20 years planted, it is 17 ft. high; the diameter of the trunk 8 in., and of the head 20 ft. In France, at Scéaux, near Paris, 12 years planted, it is 16 ft. high; at Nantes, in the nursery of M. De Nerrières, 19 years planted, it is 20 ft. high. In Hanover, at Schwöbber, it is 30 ft. high. In Prussia, in the Berlin Botanic Garden, 20 years planted, it is 10 ft. high. In Italy, at Monza, 24 years planted, it is 16 ft. high.

Commercial Statistics. Price of plants, in the London nurseries, 1s. 6d. each; and of seeds, 3s. a quart. At Bollwyller, plants are 2 francs each; and at New York, 50 cents.

‡ 2. H. (T.) PARVIFLORA Michx. The small-flowered *Halesia*, or *Snowdrop Tree*.

Identification. Michx. Fl. Bor. Amer., 2. p. 40.; Pursh Fl. Bor. Amer., 2. p. 450.; *Don's Mill.*, 4. p. 6.

Engravings. Bot. Reg., t. 952.; and our fig. 1013.

Spec. Char., &c. Leaves ovate, oblong, acute, nearly entire. Flowers octandrous. Fruit clavate, slightly winged. Leaves downy, glaucous beneath. Racemes paniced. Flowers white, drooping. Calycine teeth ovate. (*Don's Mill.*, iv. p. 7.) A tree, 10 ft. high, a native of Florida, introduced in 1802,

and flowering in May. From the plants of this sort in the Horticultural Society's Garden, we are convinced that it is nothing more than a variety of *H. tetraëtera*, from which it differs chiefly in having the leaves somewhat downy. It well deserves a place, however, in every collection, even if it were less distinct than it is; and, to make sure of the continuance of the kind, it ought to be propagated by layers or cuttings, rather than by the usual mode of seeds; which, in this species, as in the preceding one, are ripened in abundance in England. Plants of this sort in Prince's *Catalogue*, New York, are marked at 1 dollar each.



1013

¶ 3. *H. DIPTERA* L. The two-winged-fruited *Halesia*, or *Snowdrop Tree*.

Identification. Lin. Sp. Pl., 636.; Don's Mill., 4. p. 7.

Engravings. Cav. Diss., 6. p. 338. t. 187.; Lodd. Bot. Cab., t. 1172.; and our fig. 1014.

Spec. Char., &c. Leaves ovate, acute, serrated. Petioles smooth and even. Pedicels elongated. Fruit with 2 large opposite wings, and 2 obsolete ones. Flowers octandrous. Leaves much larger than those of either of the preceding species. (*Don's Mill.*, iv. p. 7.) A tree, 10 ft. high, a native of Georgia and Carolina, in shady places, on banks of rivers. It was introduced in 1758, and flowers in April and May. The leaves of this species are broad, resembling those of *Styrax grandifolium*, with which, as it does not frequently flower in a young state, it is generally confounded in nurseries. The only flowering plant that we know of, in the neighbourhood of London, is against a wall in the arboretum of Messrs. Loddiges, where it ripens seeds. It is commonly propagated by layers; and the price of plants, in the London nurseries, is 5s. each; at New York, 1 dollar.



1014

CHAP. LXXIII.

OF THE HARDY LIGNEOUS PLANTS OF THE ORDER SAPOTACEÆ.

GENUS I.



ARGANIA Rœm. et Schultes. THE ARGANIA. Lin. Syst. Pentândria Monogýnia.

Identification. Rœm. et Schultes Syst., 46.; Don's Mill., 4. p. 27.; Lindl. Nat. Syst. Bot., 2d edit., p. 226.

Synonymes. *Sideroxylon spinosum* Lin.; *P'Argan*, Fr.; *Eisenholz*, Ger.

Derivation. From *argan*, the aboriginal name of the tree.

Gen. Char., &c. *Calyx* 5—10 cleft: the leaflets, or rather scales, roundish, concave, disposed in a double series. *Corolla* cup-shaped, 5-parted, with ovate-lanceolate, submarginate segments, having 5 petal-like linear-subulate segments, adhering to the base of the corolla, and alternating with its segments. *Stamens* 5, filiform, length of corolla, and adnate to its base. *Anthers* incumbent, ovate, keeled on the back. *Ovarium* conical, hairy. *Style* glabrous, length of stamens. *Stigma* simple. *Drupe* ovate, terminated by the style, 2—3-celled. *Cells* 1-seeded. *Seeds* hard, smooth, having a lon-

gitudinal furrow inside. (*Don's Mill.*, iv. p. 28.)—A small evergreen tree, a native of the north of Africa, and somewhat tender in British gardens, where it should be planted against a wall.

♣ 1. *A. SIDEROXYLON* *Rœm. et Schultes.* The Iron-wood Argania.

Identification. *Rœm. et Schultes Syst.*, 4. p. 502; *Don's Mill.*, 4. p. 28.

Synonymes. *Sideroxylon spinosum* *Lin. Sp.*, p. 279., exclusive of the synon. of *Rheede Mal.*, *Ait. Hort. Kew.*, ed. 2., vol. 2. p. 14., *Dry.* in *Lin. Trans.*, 2. p. 225., *Correa* in *Ann. Mus.*, 8. p. 393.; *Elaeodendron Argan* *Retz. Obs.*, 6. p. 26., *Willd. Sp.*, 1. p. 1148., exclusive of the synon.; *Rhânnus pentaphyllus* *Jacq. et Boccone, Schousb. Mar.*, p. 89.; *Rhânnus siculus* *Lin. Syst.*, 3. p. 227., exclusive of the synonyme, *Comm. Hort. Amst.*, 1. p. 161. t. 83. *Engravings.* *Comm. Hort.*, t. 83.; and our fig. 1015.

Spec. Char., &c. An evergreen tree of middle size, with a bushy head. Branches terminated by strong spines. Leaves lanceolate, entire, bluish, glabrous, paler beneath; the lower ones in fascicles. Flowers lateral, and axillary, scattered, crowded, sessile. Corolla greenish yellow. Fruit dotted with white, size of a plum, full of white milky juice. (*Don's Mill.*, iv. p. 28.) A native of the southern parts of the kingdom of Morocco; abundant in woods situated in the southern provinces, between the rivers Tausif and Sur; where it is a tree, growing to the height of from 15 ft. to 20 ft., flowering in July. It was introduced in 1711, and is occasionally met with in collections. It will stand our winters as a standard, but thrives best when planted against a wall. It is called argan by the Moors, who extract an oil from the fruit, which they use at table, and which the Europeans employ in a variety of preparations. A large plant against the wall, in the arboretum of Messrs. Loddiges, flowers abundantly every year. There are plants in the Horticultural Society's Garden, and in the Hammersmith and other nurseries. The argania thrives in a sandy loam, and is generally propagated by layers. Price of plants, in the London nurseries, 5s. each.



1015

GENUS II.



BUMELIA *Swartz.* THE BUMELIA. *Lin. Syst.* Pentândria Monogýnia.

Identification. *Swartz Prod.*, p. 49.; *Fl. Ind. Occ.*, 1. p. 493.; *Schreb. Gen.*, 1736.; *Lindl. Nat. Syst. Bot.*, 2d edit., p. 226.; *Don's Mill.*, 4. p. 29.

Synonymes. *A'chras* sp. *Lin.*, *Poir.*; *Sideroxylon* sp. *Lam.* and others; *Chrysophýllum* sp. *Aubl.* and others; *Hochstamm, Ger.*

Derivation. From *boumelia*, the Greek name for the common ash.

Gen. Char., &c. *Calyx* 5-parted. *Corolla* with a short tube, and a 5-parted limb, furnished with 2 scales at the base of each segment. *Stamens* 5, inserted in the tube of the corolla, and opposite its segments, having as many membranous scales, or sterile filaments, alternating with them. *Ovarium* 5-celled. *Cells* 1-ovuled. *Stigma* simple. *Drupe* ovate, 1-seeded. *Seed* albuminous. (*Don's Mill.*, iv. p. 29.)—Subevergreen shrubs, or low trees. Leaves scattered, entire, permanent. Peduncles axillary and lateral, 1-flowered, usually crowded in fascicles. Flowers whitish. The hardy species are chiefly natives of Mexico and Carolina, and subevergreen, somewhat spiny, and rather tender in British gardens.

❖ 1. *B. LYCÏOÏDES* Gærtn. The Box-thorn-like Bumelia.

Identification. Gærtn. fil. Carp., 3. p. 127. t. 120.; Pers. Ench., 1. p. 237.; Don's Mill., 4. p. 30.
Synonymes. Sideroxylon lycioides Du Ham. Arb., 2. p. 260. t. 68., Willd. Sp., 1. p. 1090., Ait. Hort. Kew., ed. 2., vol. 2. p. 12., Pursh Fl. Amer. Sept., 1. p. 155.; S. læve Walt. Fl. Carol., p. 100.
Lycioides Sp. Lin. Hort. Cliff., p. 488.
Engravings. Gærtn. Fil. Carp., 3. p. 127. t. 120.; Du Ham. 2. p. 260. t. 68.; and our fig. 1016.

Spec. Char., &c. Spiny. Leaves broad-lanceolate, bluntish, tapering to the base, glabrous. Flowers in axillary fascicles. Spines subulate. Leaves 2 in. long, deciduous, a little silky while young. Flowers greenish white. Segments of corolla ? trifid: perhaps from the two scales inside each segment. (*Don's Mill.*, iv. p. 30.) A shrub, a native of Carolina, found in shady woods, where it grows to the height of 8 ft. or 10 ft., flowering in August. It was introduced in 1758, and is not unfrequent in London collections. There are vigorous-growing plants in the Horticultural Society's Garden, as standards; and in the Botanic Garden at Kew, and in Messrs Loddiges's arboretum, against walls. In the Horticultural Society's Garden, the distinction between *Argania* and *Bumelia* is very obvious; but that between *Bumelia lycioides* and *B. ténax* is much less so; as may be seen by the plants at Messrs. Loddiges's, at Kew, and in the Horticultural Society's Garden. Price of plants, in the London nurseries, 2s. 6d. each; and of the seeds, 1s. per ounce.



1016 +

❖ 2. *B. RECLINATA* Vent. The reclinate-branched Bumelia.

Identification. Vent. Choix, t. 22.; Pursh Fl. Amer. Sept., 1. p. 155.; Don's Mill., 4. p. 30.
Synonymes. Sideroxylon reclinatum Michx. Fl. Bor. Amer., 1. p. 122.
Spec. Char., &c. Spiny, bushy, diffusely reclinate. Leaves small, obovate, quite smooth. Flowers in axillary fascicles. Young branches terminated by a long spine. Leaves alternate, or in fascicles. Flowers small, white. Corolla and scales serrated. Sterile filaments subulate, entire. Drupe ovate. (*Don's Mill.*, iv. p. 30.) According to Pursh, a small straggling shrub, a native of Georgia, on the banks of rivers, where it grows 3 ft. or 4 ft. high, flowering in January. It was introduced in 1806, but we have not seen the plant.

‡ 3. *B. TENAX* Willd. The tough-branched Bumelia.

Identification. Willd. Sp., 1. 1085.; Enum., p. 248.; Don's Mill., 4. 30.
Synonymes. B. chrysophylloides Pursh Fl. Amer. Sept., 1. p. 155.; Sideroxylon ténax Lin. Mant., p. 48., Jacq. Coll., 2. p. 252., Lam. Dict., 1. p. 245.; S. sericeum Wall. Fl. Car., p. 100.; S. chrysophylloides Michx. Fl. Bor. Amer., 1. p. 123.; Chrysophyllum carolinense Jacq. Obs., 3. p. 3. t. 54.; C. glabrum Juss.
Engravings. Jacq. Obs., 3. t. 54.; and our fig. 1017.

Spec. Char., &c. Leaves obovate-lanceolate, of a rusty silvery colour beneath, silky. Flowers in axillary fascicles. Branches very tough. Bark white. Leaves deciduous. Calycine and corolline segments ovate obtuse. Segments of nectary trifid. Stamens the length of corolla. Drupe oval. Flowers white. (*Don's Mill.*, iv. p. 30.) A tree, a native of Carolina, in dry situations, where it grows to the height of 20 ft., flowering in July and August. It was introduced in 1765, and is occasionally met with in collections. There is a plant in the Horticultural Society's Garden 7 ft. high, as a standard; and one 10 ft. high in Messrs. Loddiges's, against a wall. The latter stands close to a plant of *Bumelia lycioides*; and, if they are correctly named, we should have no hesitation in giving it as our opinion that they are not specifically distinct. A plant, named *Bumelia sericea*, against the wall of the Horticultural Society's Garden, where it has stood between three and four years, appears to be of this species.



1017 +

✽ 4. *B. LANUGINOSA* Pursh. The woolly-leaved Bumelia.

Identification. Pursh Fl. Amer. Sept., 1. p. 155.; Don's Mill., 4. p. 80.

Synonymes. *Sideroxylon lanuginosum* Michx. Fl. Bor. Amer., 1. p. 123.; *S. ténax* Wall. Fl. Car., p. 100.

Spec. Char., &c. Rather spinose. Branchlets spreading, downy. Leaves oval-lanceolate, glabrous above, and woolly beneath, but not silky. Flowers in axillary fascicles; very nearly allied to *B. ténax*, but differs in the leaves being woolly beneath, not silky, often obtuse. (*Don's Mill.*, iv. p. 30.) A small tree, a native of Carolina and Georgia, in humid situations among bushes. It was introduced in 1806; but we have not seen the plant.

✽ 5. *B. OBLONGIFOLIA* Nutt. The oblong-leaved Bumelia.

Identification. Nutt. Gen. Amer., 1. p. 135.; Don's Mill., 4. p. 30.

Spec. Char., &c. Spiny. Leaves smooth, oblong, obtuse, deciduous. Flowers conglomerate, nearly sessile, very numerous. Scales, or sterile filaments, trifid. Tree, with numerous twisted branches.

Calyx segments ovate, concave. Drupe purple. Wood fetid. (*Don's Mill.*, iv. p. 30.) A tree, a native of North America, on the Mississippi, near the lead mines of St. Louis; it is also abundant as far down the river as Natches, where it grows to the height of 18 ft. or 20 ft.; flowers in July and August. It was introduced in 1818; but we have not seen the plant.

B. salicifolia Swz., *Sideroxylon salicifolia* Lam., *Achras salicifolia* L., is a native of Jamaica and St. Domingo; but there is a tree against a wall in the open air in the Botanic Garden at Kew, which appears to be a *Bumelia*, which Mr. Smith, the botanical foreman there, thinks may be of this species. It is at once distinguished from *B. lycioides*, which stands beside it, by its much larger, pale green, and willow-like leaves.

CHAP. LXXIV.

OF THE HARDY LIGNEOUS PLANTS OF THE ORDER EBENACEÆ.

GENUS I.



DIOSPYROS L. THE DATE PLUM *Lin. Syst. Polygàmia Dice'cia.*

Identification. Lin. Gen., No. 1161.; Juss. Gen., 156.; Gærtn. Fruct., 2. p. 478. t. 179.; Lindl. Nat. Syst. Bot., 2d edit., p. 227.; Pr. Br. Prodr., p. 525.; Don's Mill., 4. p. 38.

Synonymes. *Ebenus Conon.*; *Guaiaçana* Tourn., 371.; *Plaqueminier*, Fr.; *Dattelpflaume*, Ger. *Derivation.* *Diospyros dios*, divine, and *pyros*, wheat, was a name given by the ancients to the common groundwell (*Lithospermum officinale*). Its application to the date plum probably arose from confounding the Greek *pyros*, wheat, with the Latin *pyrus*, a pear tree, to the fruit of which the date plum may have been thought to bear some resemblance.

Gen. Char., &c. Flowers polygamous. *Calyx* deeply 4-cleft, sometimes 3- or 6-cleft. *Corolla* urceolate, 4-cleft; sometimes 3- or 6-cleft. *Male flowers* having the stamens inserted by pairs into the base of the corolla, twice the number of its segments, with double or twin filaments, and the rudiment of a pistil. *Hermaphrodite flowers* having fewer and sterile stamens. *Ovarium* 8—12-celled; cells 1-seeded. *Berry* globose, with a spreading calyx which is at length reflexed. *Albumen* horny. (*Don's Mill.*, iv. p. 38.) Deciduous low trees, with white or pale yellow flowers. Natives of Europe, the north of Africa, Western Asia, the islands of the Indian Archipelago, and North America. The hardy species in cultivation in British gardens belong to the Levant and North America.

✽ 1. *D. LOTUS* L. The European Lotos, or common Date Plum.

Identification. Lin. Sp., 1510.; Willd. Sp., 4. p. 407.; Ger. Emac., 1495. f. 1.; Park. Theatr., 1523. t. 3.; Don's Mill., 4. p. 38.

Synonymes. *Pseudobolus* Matth.; *Guaiaçana patavina* Tourn.; Italian *Lignum Vitæ*, Wood of Life, Poekwood, Bastard Menynwood, Gerard; Date of Trebisonde; *Plaqueminier*, faux Lotier, Fr.; Italianische Dattelpflaume, Ger.

Engravings. Mill. Icon., t. 116.; Pall. Fl. Ross., 1. p. 20. t. 58.; Wagh. Amer., 84. t. 28. f. 58.; and the plates in our last Volume.

Spec. Char., &c. Leaves oblong, acuminate, downy beneath; leaf buds hairy inside. Flowers small, reddish white. Fruit size of a cherry, yellow when ripe, sweet with astringency: it is recommended as a cure for diarrhœa. (*Don's Mill.*, iv. p. 38.) A tree, a native of the southern parts of Caucasus,

the woods of Hyrcania, and the whole coast of the Caspian Sea, and Mauritania; where it grows to the height of from 20 ft. to 30 ft., and sometimes much higher. It flowers in July, and ripens its fruit in October. The leaves are of a beautiful dark glossy green above, and, when mature, and exposed to the air, assume a purplish hue beneath: they do not change colour in autumn, but drop off simultaneously with the first attack of sharp frost. It was cultivated by Gerard, who says that it grows beautifully near Lyons, in France; and that he planted "in the garden of Barne Elms, neere London, two trees; besides there groweth another in the garden of Mr. Gray, an apothecary of London, and in my garden likewise." Gerard adds that this plant "has been reputed for the lotus of Theophrastus:" but Dr. Walsh (see *Gard. Mag.*, vol. i. p. 294.) says that the *Diospyros Lôtos* is not described by the ancients; and Dr. Sibthorp and others, particularly Mr. Hogg (*Journ. of Bot.*, vol. i. p. 203.; and *Gard. Mag.*, vol. x. p. 391.), consider the *Céltis australis*, or nettle tree, as the true *Lôtos* of the *Lo-tophagi*. The *Diospyros Lôtos* ripening its fruit freely in the south of France and Italy, seeds have been readily procured; and the plant has never been rare in British collections; but, as it is somewhat tender, there are few large specimens of it. It grows at the rate of 1 ft. or 18 in. a year, for the first ten years, especially if the soil in which it is planted is free and loamy, and rich rather than poor. According to Dr. Walsh, the *Diospyros Lôtos* was originally brought to Constantinople from the country beyond the Caspian Sea; whence its name of the date of Trebisonde. The fruit is sometimes brought to the market at Constantinople, under the name of Tarabresan Curmasi; and in that part of Europe it appears to grow much larger than either in Britain or in Italy, being nearly the size of a walnut; it is however austere, and unfit for the table, unless as a conserve. In the neighbourhood of London, it bears fruit in abundance; but these are extremely austere, and seldom larger than a small cherry. Were it considered desirable to cultivate the *diospyros* for its fruit, superior varieties might be easily procured from the East, or by selection from seedlings, and continued by grafting. The wood of this species is white, light, and of very little use.

Statistics. In the environs of London, the oldest trees are at Syon, where there is a curious specimen (a portrait of which is given in our last Volume), only 15 ft. high, but with a head 39 ft. in diameter. In our garden at Bayswater, there is a tree which, in 1835, was 10 years planted, and 16 ft. high. In 1834, this tree ripened fruit for the first time; and on this day, July 12. 1836, it is covered with thousands of blossoms. In Messrs. Loddiges's arboretum, and in the garden of the Horticultural Society, are several trees which have grown at nearly the same rate. In Cheshire, at Eaton Hall, a tree, 14 years planted, is 13 ft. high. In Ireland, at Louth, a tree, 6 years planted, is 10 ft. high. In France, in the neighbourhood of Paris, the tree attains the height of from 20 ft. to 30 ft., and ripens fruit; but there is a specimen in the *Jardin des Plantes* which has attained the height of 45 ft. In the Botanic Garden at Toulon, there is one which, in 48 years, has attained the height of 30 ft. In Germany, at Vienna, at Laxenbourg, in 12 years it has attained the height of 10 ft. In Italy, at Monza, in 24 years it has attained the height of 35 ft. In Russia, in the Crimea, it has attained the height of between 30 ft. and 40 ft.; the tree being frequent in that country.

Commercial Statistics. The price of plants, in the London nurseries, is 2s. each, and seeds 2s. a packet; at Bollwyller, 1 franc; and at New York, 1 dollar.

‡ 2. *D. VIRGINIA'NA L.* The Virginian Date Plum, or *Persimon*.

Identification. Lin. Sp., 1510.; Don's Mill., 4. p. 39.

Synonyme. *Guaiaquina* Catesb. Car., 2. t. 76., Pluk. Alm., 244. f. 5.

Engravings. Mill. Icon., 126.; Wats. Dendr. Brit., t. 146.; Park. Par., 570. t. 569. f. 6.; and the plates in our last Volume.

Spec. Char., &c. Leaves ovate-oblong, acuminate, glabrous, shining above, and paler beneath, reticulately veined. Petioles short and curved, and, as well as the branchlets, downy. Leaf buds glabrous. Flowers quadrifid, rarely quinquefid. Flowers pale yellow (*Don's Mill.*, iv. p. 39.) A tree, growing to the height of 20 ft. or 30 ft. in the neighbourhood of London, but much higher in the United States, whence it was introduced in 1629. It flowers in July, and its fruit is ripe about the time the tree drops its leaves in November.

Variety.

- *D. v. 2 dulcis* Prince's Cat. for 1829, Foreman's Sweet Persimon, is characterised as having sweeter fruit than the species.

Description, Geography, &c. The persimon is readily distinguished from the European date plum, by its leaves being nearly of the same shade of green on both surfaces; while those of the latter are of a dark purplish green above, and much paler, and furnished with somewhat of a pinkish down, beneath. The leaves of the persimon vary from 4 in. to 6 in. in length; and when they drop off in the autumn they are often variegated with black spots. The size of the tree varies as much as that of the leaves. In the vicinity of New York, it is seldom more than 30 ft. high; but in the southern states it attains the height of 60 ft., or more, with a trunk 18 in. or 20 in. in diameter. The tree is found in a wild state in North America, from 42° N. lat. to Louisiana. It is common in the state of New Jersey, and still more so in Pennsylvania, Maryland, and Virginia. When it was brought to England is uncertain: but it has been in cultivation, though not very common, since the time of Parkinson. The fruit of this species is so abundant in the southern states of North America, that one tree often yields several bushels. The fruit, when ripe, is about the size of a bullace plum, reddish, and furnished with 6—8 oval stones, which are slightly swollen at the sides, and of a dark purple colour. The fruit is not palatable till it has been softened by frost, when it becomes sweet, though still astringent. It adheres to the branches, long after the leaves have dropped; and, when it falls, it is eagerly devoured by wild and domestic animals. In Virginia, the Carolinas, and the western states, the fruit is sometimes gathered up, pounded with bran, and formed into cakes, which are dried in an oven, and kept to make beer. For this purpose, they are dissolved in warm water, and hops and yeast are added to the mixture. The fruit itself, bruised and fermented, yields an ardent spirit, which is said to become excellent when it acquires age. The wood of the tree is greenish in the softer parts; but the heart-wood is brown, hard, compact, and strong and elastic, but liable to split. At Baltimore, screws and mallets have been made of it; at Philadelphia, shoe-lasts: and, in Carolina, wedges for splitting trees. Michaux says that he was assured by the coachmakers in Charleston, that they had employed it for the shafts of chaises, and found it preferable to the ash, and all other species of wood, except the lance-wood of the West Indies. The farmers in Virginia assert that grass grows more vigorously beneath the persimon than beneath any other tree; and this fact is attributed to the speedy decay of its leaves, which form an excellent manure. A greenish gum exudes from the tree, but in very small quantities, and no use has yet been made of it. The inner bark, which is extremely bitter, is said to have been employed with success in intermittent fevers. In Britain, and throughout Europe, it is cultivated solely as an ornamental tree. It is propagated by seeds, and seems to prefer a soft black soil, rather moist, and a sheltered situation.

Statistics. The largest tree of this species, in the neighbourhood of London, is in the arboretum at Kew, where it is 40 ft. high: at Syon, there is a tree 17 ft. high, diameter of the trunk 10 in., and that of the head 20 ft. In Bedfordshire, at Amptill, there is a tree, 55 years planted, which is 25 ft. high, the diameter of the trunk 1½ ft., and of the head 30 ft.; the soil loamy, on a clayey subsoil. In Berkshire, at White Knights, a tree, 24 years planted, is 18 ft. high, the diameter of the trunk 5 in., and of the head 14 ft. In Staffordshire, in the Handsworth Nursery, a tree, 10 years planted, is 12 ft. high. In Worcestershire, at Croome, a tree, 20 years planted, is 20 ft. high. In France, the tree attains about the same height as the *Diospyros Lotus*, in the neighbourhood of Paris, and ripens its fruit. In Germany, in the neighbourhood of Vienna, there are old trees of this species, between 50 ft. and 40 ft. high. In Italy, at Monza, a tree, 24 years planted, is 40 ft. high. In North America, in Bartram's Botanic Garden, there is a specimen 80 ft. high.

Commercial Statistics. Plants, in the London nurseries, are 1s. 6d. each, and seeds 1s. per packet; at Bollwyller, 1 franc each; at New York, plants of the species are 50 cents each, and of a variety named Foreman's sweet persimon, 75 cents each.

‡ 3. *D. (v.) PUBESCENS Pursh.* The downy-leaved Virginian Date Plum.

Identification. Pursh Fl. Amer. Sept., 1. p. 265.; Don's Mill., 4. p. 38.
Synonymy. *D. virginiana* var. *Michx.* *Arb. For.*

Spec. Char., &c. Leaves oblong, acute, downy beneath. Petioles long. Fruit few-seeded. (*Don's Mill.*, iv. p. 38.) A tree, a native of North America, in the lower counties of Virginia, Carolina, and Georgia; where it grows to the height of from 20 ft. to 30 ft., and flowers in April. It was introduced by Lyon, in 1812. Michaux makes this only a variety of *D. virginiana*, occasioned by difference of climate; which, he observes, exerts an extraordinary influence on the development of all trees that are common to different parts of the United States; but Pursh considers it a distinct species; not only on account of the difference in the structure of the fruit, but in the shape and downiness of the leaves. There are plants in the Horticultural Society's Garden, and in the arboretum of Messrs. Loddiges; judging from which, we feel inclined to agree entirely with Michaux.

App. I. Other Species of Ebenaceæ.

In the catalogue of Messrs. Loddiges for 1836 are the names *Diospyros angustifolia*, *D. ferrilis*, and *D. lucida*; but we have not seen the plants. The plants bearing these names in the Horticultural Society's Garden appear to be only varieties of *D. virginiana*. *D. Mabilis* Roxb., *Bot. Mag.*, t. 1129, is cultivated as a fruit tree in the Isle of France. The fruit is about the size of a quince, of a pink colour, with a fleshy rind, firm white pulp, and agreeable flavour.

• *Embryopteris Kaki* L., *D. chinensis* Blume, Konia or Kaki, *Kampff. Amoen. t. 306*, is a native of Japan, where it is an evergreen fruit tree, growing to the height of 15 ft. or 15 ft. It was introduced in 1753, and, both in France and England, is kept in green-houses; but it would probably live against a conservative wall in a favourable situation. The sweetmeat known in France by the name of *figues-caques* is made of this fruit.

CHAP. LXXV.

OF THE HARDY LIGNEOUS PLANTS OF THE ORDER OLEACEÆ.

DISTINCTIVE Characteristics. Flowers hermaphrodite, sometimes diœcious. Calyx 1-leaved, divided, permanent. Corolla hypogynous, monopetalous, 4-cleft; sometimes 4-petaled. Petals connected by pairs to the middle of the filament, rather valvate in æstivation; sometimes wanting. Stamens 2, alternating with the segments or petals of the corolla. Anthers 2-celled; cells dehiscing lengthwise. Ovary simple, guarded by no glandular disk, 2-celled; cells 2-seeded. Ovules pendulous, collateral. Style simple, or wanting. Stigma bifid or undivided. Fruit drupaceous, baccate, or capsular, often 1-seeded by abortion. Seeds with dense copious albumen. Embryo middle-sized, longitudinal, straight. Cotyledons foliaceous, half free. Radicle superior. Plumule inconspicuous. Leaves opposite, simple, rarely pinnate. Flowers racemose or panicled, terminal or axillary, with opposite unibracteate pedicels. (*Don's Mill.*, iv. p. 44.) Trees and shrubs, natives of both hemispheres, and for the most part deciduous. Some of them are timber trees; medicinally, for the most part, they are bitter. One genus, the *Olea*, produces a valuable oil; and from others (the *Ornus* and *Fraxinus*) is obtained the sweet purgative manna. The *Syringa* supplies some of our most beautiful deciduous shrubs, and the *Ligustrum* and *Phillyrea* some useful evergreens. We have arranged the genera containing hardy species in the three following sections.

As most of the species of this order may be grafted on one another, it is probable their flowers might be reciprocally fecundated; in which case, some curious hybrids might be produced between the privet and the lilac, the privet and the olive, the lilac and the ash, &c. The generic characteristics under the following sections are taken from *Don's Mill.* iv.

SECT. I. OLEINÆ.

Sect. Char. Corolla short, monopetalous, campanulate or urceolate, 4-cleft.

Stamens 2, with short filaments, and erect anthers. Fruit drupaceous.

LIGUSTRUM *Tourn.* Corolla funnel-shaped, having the tube exceeding the

calyx. Stamens enclosed. Style very short. Stigma bifid. Berry globose, containing two chartaceous nuts.

PHILLYREA *Diosc.* Corolla short, campanulate. Stamens a little exserted. Stigma thickish. Berry globose, having one of the cells usually abortive.

CHIONANTHUS *Lin.* Calyx 4-parted. Segments of corolla linear, and long. Stamens enclosed. Style short. Stigma trifid. Drupe containing a striated 1-seeded nut.

Sect. II. *SYRINGEÆ.*

Sect. Char. Corolla funnel-shaped or campanulate, 4—5-parted. Stamens 2, short. Fruit capsular, 2-celled.

SYRINGA *Lin.* Calyx tubular, short, 4-toothed. Corolla funnel-shaped, with an elongated tube, and a 4-parted limb. Stamens enclosed, style filiform. Stigma thickish, bifid. Capsule oblong, 2-celled, 2-valved; dehiscence loculicidal. Seeds solitary, compressed, with membranous margins.

FONTANESIA *Labill.* Calyx 4-parted. Corolla of 2 petals. Stamens elongated, and stigma bifid. Capsule papery, indehiscent. Cells 1-seeded

Sect. III. *FRAXINIEÆ.*

Sect. Char. Flowers polygamous. Calyx 4-parted or wanting. Stamens 2, short. Anthers dehiscing externally. Stigma nearly sessile, bifid. Fruit 2-celled, compressed, winged at the top, usually 1-seeded.

FRAXINUS *Tourn.* Flowers polygamous. Petals wanting. Samara 1-celled.

ORNUS *Pers.* Flowers hermaphrodite or polygamous. Calyx 4-parted. Petals 4. Samara 2-celled.

Sect. I. *OLEINÆ.*

GENUS I.



LIGUSTRUM *Tourn.* THE PRIVET. *Lin. Syst.* Diándria Monogýnia.

Identification. *Tourn. Inst.*, t. 367.; *Lin. Gen.*, No. 9.; *Schreb. Gen.*, No. 23.; *Gartn. Fruct.*, 2. p. 72. t. 92.; *Juss. Gen.*, p. 106.; *Lam. Ill.*, 1. t. 7.; *Lindl. Nat. Syst. Bot.*, 2d edit., p. 308.; *Don's Mill.*, 4. p. 44.

Synonymes. Troëne, *Fr.*; Rainweide, *Ger.*

Derivation. Said to be from *ligo*, to tie; in reference to its flexible branches.

Gen. Char. Calyx short, tubular, 4-toothed. Corolla funnel-shaped, with the tube exceeding the calyx, and the limb 4-parted. Stamens 2, with short filaments, inserted into the tube of the corolla. Style very short. Stigma obtuse, bifid. Berry globose, containing 2 chartaceous, 1-seeded nuts. Albumen hardish. Embryo inverted. (*Don's Mill.*, iv. p. 44.)—Shrubs, with opposite leaves, and terminal, compound, thyrsoïd racemes of white flowers; generally subevergreen. Natives of Europe, and some parts of Asia, Africa and North America, and readily propagated by cuttings in common soil.

♂ ♀ 1. *L. VULGARE* *Trag.* The common Privet.

Identification. *Trag. Hist.*, 1005.; *Lin. Sp.*, 1. p. 10.; *Don's Mill.*, 4. p. 44.

Synonymes. *L. germánicum* *Bauh. Hist.*, 475.; *Prim*, or *Prim-print*; Troëne, *Puine blanc*, *Fr.*; gemeine Rainweide, *Ger.*; *Ligustro Olivella*, *Ital.*

Derivation. This plant was anciently called prim, or prim-print, from its being used for verdant sculptures, or topiary work, and for primly cut hedges. *Puine blanc* seems to imply a "little white shrub," from the whiteness of the blossom of the privet; which is alluded to by Virgil, and other poets, but which soon vanishes, and changes to brown, when exposed to the direct influence of the sun. The German name is combined of *rain*, green, and *wicde*, a willow; alluding to its being supple like the willow, and nearly evergreen. *Olivella* seems to signify the little olive. The

common English name of Privet may have been given to it from its being frequently planted in gardens to conceal privies.

Engravings. Engl. Bot., t. 764.; Curt. Lond., t. 300.; CEd. Fl. Dan. t. 1141.; Schmidt Baum., 3. t. 147.; Lam. Ill., 1. t. 7.; Bull. Herb., t. 295.; Mill. Ic., 162.; Baxt. Brit. Fl. Pl., vol. 2. t. 119.; and our *figs.* 1019, 1020.

Spec. Char., &c. Leaves elliptic-lanceolate, glabrous. Racemes compound, coarctate. The flowers are sweet-scented, white at first, but soon change to a reddish brown. Berries dark purple, almost black. (*Don's Mill.*, iv. p. 44.) A shrub, indigenous to Britain; growing to the height of from 6 ft. to 10 ft., in a wild state; and flowering in June and July.

Varieties.

- ♣ *L. v. 2 leucoârpum.* *The white-berried Privet.*
- ♣ *L. v. 3 xanthoârpum.* *The yellow-berried Privet.*
- ♣ *L. v. 4 chloroârpum.* *The green-berried Privet.*
- † ♣ *L. v. 5 sempervirens, L. italicum Mill.,* and our *fig.* 1018. *The Italian, or evergreen, Privet.* —This is a most desirable variety for shrubberies; and it is so distinct, that it was considered by Miller as a species.
- ♣ *L. v. 6 variegâtum.* *The variegated-leaved Privet.* —Leaves variegated with yellow.
- ♣ *L. v. 7 angustifolium.* *The narrow-leaved Privet.*



Description. The common privet is a much-branched twiggy shrub, with the bark of a greenish ash colour, dotted with numerous prominent points. The leaves, in exposed situations, and on poor soils, are deciduous; but in sheltered situations, and more especially when the plant is cultivated in gardens, they remain on throughout the winter. When the plant is found in woods and hedges in the middle and south of England, it is generally subevergreen; but in the north of England, and in Scotland, it is more commonly deciduous.



Geography, and History. The common privet is a native of most parts of Europe, in woody wastes and hedges, from N. lat. 51° to 57°, in

plains; and it is also found in the north of Africa, in the west and east of Asia, including Japan and the Himalayas; and in North America, from Canada to Virginia. In England, it is very common in woods and hedges; and, in Scotland, it is found as far north as Forfar. It is also indigenous in Ireland. It is almost always found on good soils, more or less loamy or calcareous, and moist. It is believed to have been known to the Greeks (see p. 18.), under the name of phillyrea; and it undoubtedly was so to the Romans, it being mentioned both by Virgil and Pliny; the latter stating that the berries were given to chickens to cure them of the pip. It is described by Gerard as growing naturally in the hedgerows of London gardens, and in every wood in all the countries of Europe, except Poland. In this last particular, however, he is mistaken; as, according to Schubert's *Catalogue*, p. 107., the plant is found wild in the neighbourhood of Warsaw. In British gardens, the privet has been held in high estimation, for several centuries, for its use in making hedges; either alone, or mixed with the common thorn, and as affording a screen for concealing objects.

Properties and Uses. The leaves of the privet are bitter and astringent; notwithstanding which they are eaten by cattle, sheep, and goats, but not by horses. The wood is white, hard, and, when of sufficient size, well adapted for the purposes of the turner. The berries, which ripen in autumn, and remain on the trees during winter, are excellent food for blackbirds, thrushes,

bullfinches, pheasants, and other birds. A rose colour is drawn from them, for tinting maps and prints; and their juice, with the addition of alum, is used for dyeing wool and silk green. In Germany, they furnish a colour for painting playing cards; and in Flanders their juice is employed for colouring wine. But one of the most remarkable products of the berries is a greenish, mild, agreeably flavoured oil; which may be used both for culinary purposes and lamps, and for making soap. For making this oil, the berries are put into a cask for twelve or fifteen hours; they are then taken out and ground, and afterwards pressed, and the oil skimmed off. The marc, or mass of husks and seeds, is then ground a second time, heated and moistened, and again pressed; when a supply of oil of an inferior description is obtained, which is used for coarser purposes. In Belgium and Silesia, the small twigs are used by the tanners; and for this purpose the privet hedges are clipped in the month of June; and the clippings are dried in the sun, or in stoves, and afterwards reduced to powder; in which state they are sent to the tanneries. In Belgium, the shoots are used, like those of the osier, for tying articles, in basket-making, &c., and as props for vines. The wood makes a superior description of charcoal, which is used in the manufacture of gunpowder. In Britain, the most valuable use of the privet is as a hedge plant, and as an undergrowth in ornamental plantations. On the Continent, it is also much used as a hedge plant, the sets being taken from the indigenous woods; and, unlike other shrubs so transplanted, seldom failing to grow freely. This is, doubtless, one reason why the plant has been so much employed for hedges, wherever it is indigenous. From its property of growing under the drip of trees, it forms a good subevergreen undergrowth, where the box, the holly, or the common laurel would be too expensive, or too tedious of growth. The privet has been long used in the court-yards of dwelling-houses, for concealing naked walls, and preventing the eye from seeing objects or places which it is considered desirable to conceal from the view. It thrives well in towns where pit-coal is used; and the best hedges surrounding the squares of London are of this shrub. Trained against a white stone or plastered wall, it produces a very pleasing effect, suggesting the idea of a large vigorous-growing myrtle. The evergreen variety forms a most valuable plant in suburban shrubberies; and both it and the common sort, when trained with a single stem 6 ft. or 8 ft. high, will make some of the most desirable small trees that can be planted on a lawn; on account of their neat compact form, and somewhat pendulous, and yet picturesquely tufted, branches, their profusion of white flowers, and their groups of black fruit, which remain on all the winter, and form a powerful attraction to the blackbird and the thrush in spring. The varieties with white, yellow, and green fruit are very ornamental during winter, as is the variegated-leaved variety during spring. The privet may be used as a stock for the different species of lilac, and, probably, for all the *Oleaceæ*.

Soil, Situation, Propagation, &c. The privet grows best in rather a strong loam, somewhat moist; and it attains the largest size in an open situation; but it will grow on any soil, and under the shade and drip of deciduous trees, though by no means of evergreen ones. In good moist soils, under the shade of trees, or in hedges protected by the hawthorn, it becomes nearly evergreen, as it does, also, when cultivated in rich garden soils, in sheltered situations. Though all the varieties bear seed, and the common sort in great abundance, yet plants, in British nurseries, are almost always raised by cuttings, which not only produce larger plants of the species in a shorter period, but continue the varieties with greater certainty. When plants are to be raised from seed, the berries should be treated like haws, and kept a year in the rot-heap, or sown immediately after being gathered, as, if otherwise treated, they will not come up for 18 months. As shrubs, privet plants require very little pruning; but, as low trees, they must have the side shoots from the stem carefully rubbed off whenever they appear. Treated as hedges, or as verdant sculptures, for which they are particularly well adapted, they may be clipped twice a year, in June and March; and, every five or six years, the sides of the hedges ought to be

severely cut in, one side at a time, so as to remove the network of shoots, which, in consequence of continual clipping, forms on the exterior surface, and which, by preventing the air from getting to the main stems, would seriously injure the plants.

Accidents, Diseases, &c. The privet is not subject to be injured by the weather, nor is it liable to the canker, mildew, or other diseases; but the *Sphinx ligüstri*, or privet hawk moth (fig. 1021.), and the *Phalæna syringaria*, feed on it in their caterpillar state; as does the *Cántharis vesicatòria* (see p. 1224.), the well-known blister-beetle, commonly called the Spanish fly. The larva of the privet hawk-moth is grass green, with stripes of white, purple, or flesh colour, on the sides; the chrysalis (*a*, in fig. 1021.) is brown; and the eggs (of which *b* represents one of the natural size, and the section of another magnified showing the embryo insect,) are oval. The perfect insect measures $4\frac{1}{2}$ in. when its wings are expanded; and the larva feeds principally on the privet, though it is found occasionally on the lilac, laurustinus, &c.

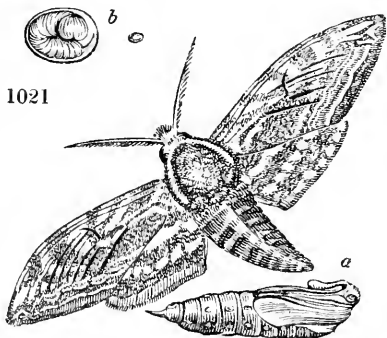

Commercial Statistics. Plants, in the London nurseries, are 16s. per hundred; at Bollwyller, plants of the species are 20 francs per 100, and the variety with white fruit 50 cents, and that with green fruit 1 franc per plant; and at New York, the species is $37\frac{1}{2}$ cents, and the varieties 50 cents per plant.

❖ ❖ ♀ ♀ 2. *L. SPICATUM* Hamilt. The spiked-flowered Privet.

Identification. Hamilt. MSS. ex D. Don Prod. Fl. Nep., p. 107.; Don's Mill., 4. p. 45.
Synonymes. *L. nepalense* Wall. in Rox. Fl. Ind., 1. p. 151., Pl. Rar. Asiat., 3. p. 17. t. 231.; *L. lanceolatum* Herb. Lamb.; *L. nepalense* var. *glabrum* Hook. in Bot. Mag., t. 2921.
Engravings. Pl. Asiat. Rar., 3. p. 17. t. 231.; Bot. Mag., t. 2921.; and our fig. 1022.

Spec. Char., &c. Leaves elliptic, acute, hairy beneath, as well as the branchlets. Flowers crowded, almost sessile, spicate, disposed in a thyrs, having the axis very hairy. Bractæas minute. Flowers white. (Don's Mill., iv. p. 45.) A shrub, from 6 ft. to 8 ft. high; a native of Nepal, on the mountains. It was introduced in 1823, and flowers in June and July. Though commonly treated as a green-house plant, there can be little doubt of its being as hardy as *L. lucidum*, the species to be next described. It should be grafted on the common privet; and, if planted in a dry soil and rather sheltered situation open to the sun, it will be the more likely to make no more wood than what it can ripen before winter.



❖ ❖ ♀ ♀ 3. *L. LUCIDUM* Ait. The shining-leaved Privet, or Wax Tree.

Identification. Ait. Hort. Kew., 1. p. 19.; Don's Mill., 4. p. 45.
Engravings. Bot. Mag., t. 2565.; and our figs. 1023. and 1024. The former, drawn to a scale of 1 in. to 4 ft., is a portrait of a tree in the Fulham Nursery, as it appeared in October, 1835.

Spec. Char., &c. Leaves ovate-oblong, acuminate, shining above. Panicles thyrsoid, spreading much. Leaves broad. Flowers white. This tree

affords a kind of waxy matter. (*Don's Mill.*, iv. p. 45.) A tree, from 10 ft. to 20 ft. high, a native of China. It was introduced in 1794, and flowers profusely in September and October. This species forms a very handsome low subevergreen tree; or, when it is not trained to a single stem, a large showy bush. There are good specimens of it, as trees, between 10 ft. and 12 ft. high, in the Fulham and Brompton Nurseries; and, as shrubs, in the Horticultural Society's Garden, and in Messrs. Loddiges's

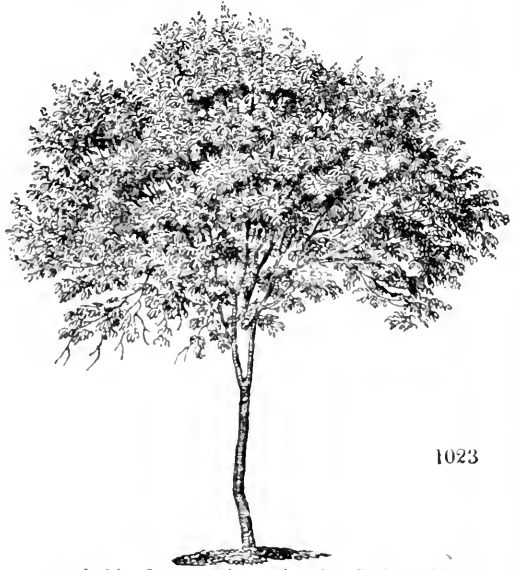

1023

arboretum. There is a remarkably fine specimen in the Duke of Marlborough's private garden at Blenheim; and there are some, also, at White Knights. It is propagated by layers, or by grafting on the common privet. Price of plants, in the London nurseries, from 1s. to 1s. 6d. each.

Variety.

- ♂ ♀ *L. l. 2 floribundum* Donald's Cat. has larger bunches of flowers than the species.

L. salicifolium. A plant to which this name might be suitable has been in the arboretum at Kew since 1823. It was raised from a withe, which had been tied round a package of plants, received from the Cape of Good Hope in that year, by Mr. Smith. It bears a close general resemblance to the common privet, but differs from it in having the leaves much larger, and the flowers in large compound spikes, like those of *L. lucidum*. The leaves, in form, colour, and texture, closely resemble those of the plants alluded to in the following appendix, as having been raised by Messrs. Loddiges from Kamaon seeds. The plant is quite hardy, and retains its foliage the greater part of the winter. It flowers freely every year, but has not yet ripened seeds.



1024

App. i. *Species of Ligustrum not yet introduced.*

♂ *L. sinense* Lour. Coch., 19, *Don's Mill.*, 4. p. 45., is a native of China, near Canton, with lanceolate, tomentose leaves, white flowers, and small brown berries. It grows to the height of 6 ft. or 8 ft.

♂ *L. japonicum* Thunb. *Fl. Jap.*, p. 17. t. 1.; *L. latifolium* *Vitm.*; is a native of Japan, with oblong-ovate, grooved leaves, and white flowers, growing to the height of 6 ft. or 8 ft.

♂ *L. pubescens* Wall. Cat., 1742., is a native of the Burmese empire, with downy branches, and flowers and fruit in panicles; the berries are oblong.

♂ *L. bracteolatum* D. Don *Prod. Fl. Nep.*, 107.; *L. japonicum* *Hamilt.*; *Phyllirea bracteolata* *Herb. Lamb.*; has the leaves ovate-lanceolate, the flowers disposed in bracteate panicles, and the peduncles very hairy. It is a native of Nepal.

As the seeds of the privet will keep several years, it is to be hoped that the above species will, at no distant period, be introduced through the exertions of Dr. Wallich and other botanists of the East. Some plants in the arboretum of Messrs. Loddiges, lately raised from seeds received from Kamaon, in the Himalayas, appear to belong to this genus.

GENUS II.



PHILLY`REA *Tourn.* THE PHILLYREA. *Lin. Syst.* Diándria Monogýnia.

Identification. Dioscor. ; *Tourn. Inst.*, 367. ; *Lin. Gen.*, No. 19. ; *Vaill. Acad. Scienc.*, p. 197. t. 13. f. 85—87. ; *Juss. Gen.*, 106. ; *Gartn. Fruct.*, 2. p. 11. t. 92. ; *Vent. Mal.*, 2. p. 313. ; *Lam. Ill.*, 1. t. 8. ; *Lindl. Nat. Syst. Bot.*, p. 308. ; *Don's Mill.*, 4. p. 45.

Synonymes. *Filaria*, *Fr.* ; *Steinlinde*, *Ger.*

Derivation. From *phylton*, a leaf ; or from *Philyra*, the mother of Chiron, who was changed into a tree.

Gen. Char., &c. *Calyx* small, tubular, 4-toothed, permanent. *Corolla* short, campanulate, rotate, 4-cleft, deciduous. *Stamens* a little exerted, with short filaments. *Style* simple. *Stigma* thickish. *Drupe* globose, containing a 2-celled nut ; one of the cells usually abortive. *Seed* solitary in each cell. *Albumen* rather farinaceous or fleshy. (*Don's Mill.*, iv. p. 45.)—Leaves opposite, racemes axillary. Flowers greenish white. Drupes black, globose. Evergreen shrubs, or low trees ; natives of the south of Europe, and of some parts of Western Asia. In British gardens, where they have been in cultivation for nearly three centuries, they are all most desirable evergreen shrubs, on account of their shining dark green leaves, and the fragrance of their numerous white flowers, which are propagated by cuttings or layers ; and will grow in any common garden soil. The different sorts described as species are, probably, only varieties, originated at a time when the phillyrea was the principal evergreen in British nurseries. At the present day, one half of these varieties are only to be found in botanic gardens, because there is no demand for them in the nurseries. We think there should be only one specific name, which may be that of *P. oppositifolia*, under which all the other sorts might be arranged as varieties and sub-varieties. We have not, however, ventured to adopt this name, in conformity with our principle, of giving no new names whatever ; but we have adopted the names *P. angustifolia*, *P. media*, and *P. latifolia*, as botanical species, believing these forms to be most distinct, and most common in a wild state. By general observers, the phillyrea is frequently confounded with the alaternus ; but the species of that genus have their leaves placed alternately on their branches, whereas in the phillyrea they are opposite. The alaternus has, also, 5 stamens to each flower ; while the phillyrea has only 2. Gerard mentions that the phillyrea grows wild about Ascalon ; that it was brought to England from Narbonne and Montpellier, in France ; and that he planted several sorts in the Earl of Essex's garden, at Barn Elms, near London ; adding, "I have them growing in my garden likewise." (See p. 38. and p. 39.) Price of plants, in the London nurseries, 5*l.* per hundred, or 1*s.* 6*d.* each ; at Bollwyller and New York they are greenhouse plants. It was formerly, like the alaternus, which, as we have before observed (p. 531.), was often confounded with the phillyrea, in much repute for covering naked walls, and clipping into figures of balls, men, animals, &c. The largest phillyrea hedge in England is said to be at Brampton Park, near Huntingdon, the seat of Lady Olivia B. Sparrow.

* 1. *P. ANGUSTIFOLIA* *L.* The narrow-leaved Phillyrea.

Identification. *Lin. Sp.*, 1. p. 10. ; *Vahl Enum.*, 1. p. 36. ; *Don's Mill.*, 4. p. 45. ; *Lodd. Cat.*, ed. 1836.

Synonymes. *P. obliqua Tenore Syll.*, p. 9. ; *P. media Tenore Fl. Neap.*, 3. p. 6.

Engravings. *Lam. Ill.*, 8. 3. ; and our fig. 1025.

Spec. Char., &c. Leaves linear-lanceolate, quite entire. Branches beset with elevated dots. Leaves obsoletely veined. (*Don's Mill.*, iv. p. 45.) A shrub, from 8 ft. to 10 ft. high ; a native of Italy and Spain. It was intro-

1025 *Varieties.*

- *P. a. 2 lanceolata* Ait. Hort. Kew., i. p. 11. —Leaves lanceolate. Branches erect.
- *P. a. 3 rosmarinifolia* Ait. Hort. Kewensis; and our fig. 1026. —

Leaves lanceolate-subulate, elongated. Branches straight.

- *P. a. 4 brachiata* Ait. Hort. Kew., i. p. 11. —Leaves oblong-lanceolate, shorter than in the other varieties. Branches divaricate.

- 2. *P. MEDIA* L. The intermediate, or lance-leaved, Phillyrea.

Identification. Lin. Sp., p. 10.; Don's Mill., 4. p. 43.; Lodd. Cat., ed. 1836.

Synonymes. *P. latifolia* var. *i-media* Lapeyr. *Pl. Pyr.*, p. 4.; *P. ligustrifolia* Mill. *Dict.*, No 4.; *P. brachyvis* Tenore *Syll.*, p. 2.; *P. latifolia* var. *ligustrifolia* Poll. *Pl. Ver.*, 1. p. 7.

Engravings. Kerner, t. 774.; N. Du Ham., 2. t. 27.; and our fig. 1027.

Spec. Char., &c. Leaves lanceolate, quite entire, or a little serrated in the middle, triple-nerved, veiny. (*Don's Mill.*, iv. p. 45.) A shrub, from 10 ft. to 15 ft. high; a native of the south of Europe. It was introduced in 1597, and flowers in May and June. The culture of this is similar to that of the preceding and following sorts. For exposed situations, in the central and southern districts of England, few shrubs are better adapted than this kind of phillyrea. It grows slowly and regularly on every side; and in the course of a dozen years forms a dense evergreen bush, of somewhat hemispherical shape, having naturally more of a gardenesque character than belongs to any other species or variety of the genus. This sort, and *P. angustifolia*, are those most commonly to be met with in British nurseries.



1026



1027

Varieties.

- *P. m. 2 virgata* Ait. Hort. Kew., 1. p. 11. —Leaves lanceolate. Branches erect.
- *P. m. 3 buxifolia* Ait. Hort. Kew., 1. p. 11. —Leaves oval-oblong, bluntish.

- 3. *P. (M.) LIGUSTRIFOLIA* Ait. The Privet-leaved Phillyrea.

Identification. Ait. Hort. Kew., 1. p. 11.; Don's Mill., 4. p. 45.

Synonymes. *P. virgata* Willd. *Enum.*, 1. p. 12.; *P. media* var. *l.* Willd. *Sp.*, 1. p. 42.; *Phillyrea* iii. (*Bus. Hist.*, p. 52.

Engraving. Lob. *Icon.*, 2. p. 131.

Spec. Char., &c. Leaves oblong-lanceolate, subserrated in the middle, obsolete veined. Branches erect. (*Don's Mill.*, iv. p. 45.) A shrub, from 10 ft. to 15 ft. high; a native of the south of Europe, as of Spain and the south of France. It was introduced in 1596, and flowers in May and June.

- 4. *P. (M.) PENDULA* Ait. The drooping-branched Phillyrea.

Identification. Ait. Hort. Kew., 1. p. 11.; Don's Mill., 4. p. 45.

Synonymes. *P. media* γ *Willd. Sp.*, 1. p. 43.

Spec. Char., &c. Leaves oblong-lanceolate, acute, obsolete serrated at the apex, veiny. Branches drooping. (*Don's Mill.*, iv. p. 46.) A shrub, from 10 ft. to 15 ft. high; a native of the south of Europe. Introduced in 1597, and flowering in May and June.

- 5. *P. (M.) OLEIFOLIA* Ait. The Olive-leaved Phillyrea.

Identification. Ait. Hort. Kew., 1. p. 11.; Don's Mill., 4. p. 46.

Synonymes. *P. media* δ *Ait. Hort. Kew.*, 1. p. 11.; *P. racemosa* Link *Jahrb.*, 1. p. 160.

Engraving. Pluk., t. 310. f. 1.

Spec. Char., &c. Leaves oblong-lanceolate, almost entire, obtuse, narrowed at the base, veiny. Branches erectish. (*Don's Mill.*, iv. p. 46.) A shrub, from 10 ft. to 15 ft. high; a native of the south of Europe. Introduced in 1597, and flowering in May and June.

❖ 6. *P. LATIFOLIA* L. The broad-leaved Phillyrea.

Identification. Lin. Sp., 10; Don's Mill., 4. p. 46; Lodd. Cat., ed. 1836.

Synonymes. *P. latifolia* β serrata Poll. Fl. Ver., 1. p. 7.; *P. latifolia* β Ten. Fl. Neap., 3. p. 6.; *P. spinosa* Ten. Syll., p. 9. No. 2.; *P. latifolia* β spinosa Seg. Ver., 2. p. 273.

Engravings. Smith Fl. Græc., t. 2.; and our fig. 1028.

Spec. Char., &c. Leaves ovate, rounded at the base, serrated, veiny. Young leaves sub-cordate at the base. (*Don's Mill.*, iv. p. 46.) A tree, 23 ft. to 30 ft. high, a native of the south of Europe. It was introduced in 1597, and flowers in May and June. This forms a very handsome, large, ever-green bush; and, with a little management in the way of training, it might be moulded into a very handsome small tree, which, from its fixed rigid shape and limited dimensions, would have a sort of architectural character, well adapted for being placed near the house, on the lawn of a suburban garden. The largest plant that we know of, in the neighbourhood of London, stands in the garden of Earl's Court House, and was, in 1836, upwards of 18 ft. high, with a head nearly as much in diameter.



❖ 7. *P. (L.) LÆVIS* Ait. The smooth Phillyrea.

Identification. Ait. Hort. Kew., 1. p. 12.; Don's Mill., 4. p. 46; Lodd. Cat., ed. 1836.

Synonymes. *P. latifolia* var. *A.* Willd. Sp., 1. p. 43.; *P. latifolia* Mill. Dict., No. 1.

Engravings. Lob. Icon., 132. f. 2.; Du Ham. Arb., t. 125.

Spec. Char., &c. Leaves elliptic-oblong, almost entire, veiny, bluntish; an inch or more in length, a little narrowed at the base, blunt, and with a small mucro at the point. (*Don's Mill.*, iv. p. 46.) A shrub, from 10 ft. to 20 ft. high; a native of the south of Europe and north of Africa. Introduced in 1597, and flowering in May and June.

❖ 8. *P. (L.) OBLIQUA* Ait. The oblique-leaved Phillyrea.

Identification. Ait. Hort. Kew., 1. p. 12.; Don's Mill., 4. p. 46.

Synonymes. *P. latifolia* γ Willd. Sp., 1. p. 43.; *P. foliacea* Link Jahrb., 1. p. 54.; *Phillyrea* ii. *Clus. Hist.*, p. 52.

Spec. Char., &c. Leaves lanceolate-oblong, serrated, acute at both ends, veiny, bent obliquely. Leaves like those of *Myrica*. (*Don's Mill.*, iii. p. 46.) A shrub, from 10 ft. to 12 ft. high, a native of the south of Europe. Introduced in 1579, and flowering in May and June.

❖ 9. *P. (L.) SPINOSA* Mill. The spiny, or Holly-leaved, Phillyrea.

Identification. Mill. Dict., No. 3.; Ait. Hort. Kew., 1. p. 12.; Don's Mill., 4. p. 46.

Synonymes. *P. filicifolia* Willd. Enum., 1. p. 13.; Lodd. Cat., ed. 1836.; *P. latifolia* β spinosa Willd. Sp., 1. p. 43.; *P. latifolia* longifolia Link Jahrb., 1. p. 54.; *Phillyrea* i. *Clus. Hist.*, p. 51.

Engraving. Pluk. Phyt., t. 310. f. 4.

Spec. Char., &c. Leaves ovate-oblong, rounded at the base, acute, sharply and cuspidately serrated, glabrous, flat, veiny. (*Don's Mill.*, iv. p. 46.) A shrub, from 10 ft. to 20 ft. high; a native of the south of Europe. It was introduced in 1597, and flowers in May and June.

GENUS III.



CHIONANTHUS L. THE SNOW-FLOWER, or FRINGE TREE. Lin. Syst. Diandria Monogynia.

Identification. Lin. Gen., No. 21.; Juss. Gen., 105.; Gaertn. Fruct., 1. t. 39.; Lam. Ill., t. 9. f. 2.; Liubl. Nat. Syst. Bot., p. 308.; Don's Mill., 4. p. 50.

Synonymes. *Chionanthe*, Fr.; *Schneebume*, Ger.

Derivation. From *chiön*, snow, and *anthos*, a flower; in reference to the snow-white flowers of the species.

Gen. Char., &c. Calyx small, 4-parted, or 4-toothed. Corolla with a short

tube and a 4-parted limb; segments of the limb long and linear. *Style* hardly any. *Stigma* 2-lobed. *Anthers* almost sessile. *Drupe* baccate, containing a striated nut. *Seeds* albuminous. (*Don's Mill.*, iv. p. 50.) —Deciduous trees or shrubs, having the branchlets compressed at top. Leaves opposite, simple, entire. Racemes simple or compound, terminal or axillary. Flowers snow-white. This genus differs from *O'lea*, principally in the figure of the segments of the corolla, and in its leaves being deciduous. The only hardy species is a native of North America.

‡ 1. *C. VIRGÍNICA* L. The Virginian Snow-Flower, or Fringe Tree.

Identification. Lin. Sp., p. 11; Don's Mill., t. p. 50; Lodd. Cat., ed. 1836.

Synonymes. Snowdrop Tree, Amer.; Arbre de neige, Fr.; Schneebäume Ger.

Engravings. Lodd. Bot. Cab., t. 1204; Du Ham. Arb., t. p. 165. t. 63; Catesb. Car., t. 1. t. 68; our fig. 1029, to a scale of 2 in. to 1 ft.; and fig. 1030, which is a portrait of a plant in the arboretum of Messrs. Loddiges, to a scale of 1 in. to 4 ft.

Spec. Char., &c. Racemes terminal. Peduncles 3-flowered. Flowers pedicellate. Leaves lanceolate, glabrous, resembling those of a deciduous magnolia. Drupe purplish. (*Don's Mill.*, iv. p. 50.) A tree from 10 ft. to 30 ft. high, a native of North America. It was introduced in 1796, and flowers from May to July. It requires to be



grown in moist soil, either sandy peat or sandy loam, and in a sheltered situation. It may be propagated by layers; but as seeds are easily imported from America, and as the plant does not root very readily, that mode is not often adopted. It may also be propagated by grafting on the common ash; and, if this were done standard high, it would, from its large leaves, and the beauty and singular appearance of its snow-white flowers, which look like fringe, form a splendid tree. The leaves are often 1 ft. long, and nearly half as broad; but neither the leaves nor the flowers will attain any degree of perfection, unless the soil be kept moist. The largest plant that we know of, in the neighbourhood of London, is at Syon, where, in 1835, it was upwards of 10 ft. high, with a trunk 7 in. in diameter. The price of plants, in London, is 1s. 6d. each, and of seeds 1s. a packet; at New York, plants are 50 cents each.

Varieties.

- ♣ ‡ *C. v. 2 latifolia* Catesb. Car., t. 69., Kern., t. 607., Ait. Kew., 1. p. 23.; *C. v. montana* Pursh Fl. Amer. Sept., 1. p. 8.; has the leaves oval-lanceolate, coriaceous, glabrous; panicles dense; drupes oval. A native of Carolina. Introduced in 1736. There is a plant of this variety in the Marylebone Nursery.
- ♣ ‡ *C. v. 3 angustifolia* Ait. Hort. Kew., ed. 2., vol. 1. p. 23.; *C. trifida*

March; has the leaves lanceolate and glabrous. There is a plant in the Horticultural Society's Garden.

✻ *C. v. 4 maritima* Pursh Fl. Amer. Sept., i. p. 8.; *C. maritima* Lodd. Cat., ed. 1836; is a native of North America, in boggy woods by the sea side; having the leaves obovate-lanceolate, membranous, and pubescent; the panicles very loose; and the drupes elliptic. There is a fine plant of this variety, as a stool, in the Marylebone Nursery.

App. I. *Half-hardy ligneous Species of Oleaceæ belonging to the Section Oleinæ.*

Olea L., the olive, is an important genus in the south of Europe, and in the temperate parts of Asia and Africa, by the sea coast: and it promises also to be a valuable tree in Australia. There are a number of species; but none of them are of much value in rural economy, except the *O. europæa*. In Don's *Miller*, 26 species are described, from which we shall select three, and some varieties, which are found to stand the open air, in the neighbourhood of London, against a south wall, with very little protection. We shall also give a selection of varieties suitable for introducing into Australia and other colonies.

♣ *O. europæa* L.; *O. Oleaster Hoffm. segg Fl. Port.*, 1. p. 387., *Don's Mill.*, 4. p. 46.; *O. europæa communis Ait.*; *O. sylvestris Mill. Dict.*, *Blackw.*, t. 113.; is a native of Portugal, the south of France, Spain, and Italy; and is to the cultivated olive (*O. e. sativa*) what the crab is to the apple.

♣ *O. e. sativa*; *O. sativa Hoffm. segg*; *O. europæa Michx. Arb.*, 2. t. 37.; and our fig. 1031.; the cultivated olive, is said to have been brought originally from Asia to France, Spain, and Italy; in which countries it has been cultivated almost from time immemorial. The subvariety *O. e. s. longifolia* (fig. 1032.) is that chiefly cultivated in France and Italy, and *O. e. s. latifolia* in Spain. The fruit of the latter is nearly twice the size of the common olive of Provence or Italy; but the oil is so rank in flavour as to be too strong for most English palates. The oil, and the fruit in a pickled state, are sent chiefly from Languedoc, Leghorn, and Naples, to England. The best oil is from Leghorn, and the best pickles are from Genoa and Marseilles. The tree seldom exceeds 30 ft. in height; is branchy, glaucous, evergreen, and of such great longevity, that some plantations in Italy, as at Terni (which we passed through in 1819, on our way to the Falls of Marmora), are supposed to have existed from the time of Pliny. The tree delights in schistous calcareous declivities, but does not thrive in elevated situations, or at a distance from the sea. The best oil is produced from fruits grown on calcareous soils. Olive oil may be said to form the cream and butter of Spain and Italy; and the tree has been celebrated in all ages as the bounteous gift of Heaven, and as the emblem of peace and plenty. Olive oil is made by crushing the fruit to a paste, then pressing it through a hempen or rush bag, adding hot water, and afterwards skimming off the oil from its surface. Pickled olives are prepared from unripe fruit, chiefly from the subvariety *O. e. s. oblonga* (Pignola, *Ital.*; Picholine, *Fr.*), by steeping them in alkaline water, and afterwards bottling them in salt and water, with or without some kind of spice, or aromatic. The olives propagated, in some parts of Italy, by cuttings, and what are called uovoli (little eggs), and in other parts by seed. The uovoli are knots, swellings, or tumours in the wood, occasioned by the sap not returning freely to the root, but swelling through the bark of the stock, and thus forming excrescences containing embryo buds. They are separated from the trunk by introducing a sharp penknife between the trunk and the uovolo, and so detaching the latter. The mother plant suffers no injury from the operation. The uovoli are planted in the same manner as bulbs. When raised from seed, the fruit should be treated like baws; and, though some will come up in October if sown in spring, yet the greater number will not make their appearance till the following May. Seedling plants have the advantage of never throwing up suckers; and in Tuscany, where this mode of propagation is generally practised, it is said to produce invariably the largest and strongest trees. A variety of interesting information on the propagation of the olive, communicated by Signor Luigi Manetti of Monza, will be found in the *Gardener's Magazine*, vol. vii. p. 663., and vol. viii. p. 68.; and the fullest account of the tree and its uses, &c., hitherto published, in the *Nouvau Du Hamel*, vol. v. p. 65. to p. 124. In Britain, specimens of the olive may be found in various gardens in the neighbourhood of London, which have stood out for several years against a south wall without any protection. A tree in the garden of Camden House produced a crop of olives in 1790. Some in the Horticultural Society's Garden have stood out eight years against a wall; and one, of a very hardy variety, received from the Nikitka Garden, in the Crimea, has stood out some years as a standard, without being in the slightest degree injured, even by the severe winter of 1835-6. In Ireland, the olive survives the winters perfectly in the neighbourhood of Dublin, but never flowers. In Devonshire, in warm places, it passes the winter as a standard; and against a wall bears abundant crops of fruit. In general, the more hardy varieties of the common olive may be considered as equally hardy with the common varieties of the camellia.

The Subvarieties of the olive are very numerous. Those in most common cultivation in British gardens are, *O. e. s. longifolia* Ait., Bot. Cab., t. 456., and our fig. 1032.; *O. e. s. ferruginea* Ait., Royle Illust., t. 65. f. 1., and our fig. 1033., a native of the Cape of Good Hope, and, according to Royle, of the Himalayas, with the leaves rusty beneath; *O. e. s. latifolia* Ait., *O. hispanica* Mill., *Blackw.*, t. 199., which, as has already been observed, is chiefly cultivated in Spain; *O. e. s. obliqua* Ait.; and *O. e. s. buxifolia* Ait. Besides these, there are 15 garden varieties of the cultivated olive



described in Don's *Miller*, on the authority of Don Roxas Clemente y Rubio's edition of *Herrera's Agricultura*; and 32 in the *Nouveau Du Hamel*. All these subvarieties deserve trial in new colonies, where it is desired to introduce the culture of the olive; but, for those who cannot procure the whole of them, we give the following selection from Michaux's *N. Amer. Syl.*, p. 192., as comprising those most esteemed in France:—

1. *Olivier pleurcur* (*Olea craniomórpha* N. Du Ham., v. p. 75. No. 14.) is one of the largest and finest trees. Its branches are numerous, and pendent, like those of the weeping willow. Its fruit is good for the table, and yields a pure and abundant oil. This tree should be placed in valleys rather than on elevated grounds, as it has more to apprehend from drought than from cold. There are individuals of this kind, in Languedoc, that have three times survived the general destruction of the common olives by frost.

2. *Olivier à Fruit arrondi* (*Olea sphaerica* N. Du Ham., v. p. 78. No. 26.) is also among the kinds least sensible to cold. It requires moisture, a good soil, and abundant manure. Its oil is of a superior quality.

3. *Olivier de Lucques* (*Olea minor lucensis* N. Du Ham., v. p. 72. No. 9.) is hardy, and yields a fruit proper for preserving.

4. and 5. *Olivier à petit Fruit rond*, N. Du Ham., v. p. 72. No. 2.; and *Olivier de Salon*, N. Du Ham., v. p. 76. No. 19.; are good for oil, and prefer dry and elevated grounds.

6. *Olivier amygdalin* (*Olea amygdalina* N. Du Ham., v. p. 78. No. 25.) is much esteemed about Montpellier for its fine and abundant oil.

7. *Olive Picholine* (*Pignola, Ital.*; *Olea oblonga* N. Du Ham., v. p. 74. No. 12.) yields the kind of olives most celebrated for pickling. This variety is not delicate in the choice of soil and climate.

8. *O. excelsa* Ait. is a native of Madeira, whence it was introduced in 1784. It has stood out in Ireland, for several years, without any protection whatever, in the nursery of Mr. Robertson of Kilkenny, who thinks it will ultimately prove a valuable addition to our hardy evergreens. (See *Gard. Mag.*, vol. iii. p. 106.) In July, 1836, this tree measured 30 ft. in height, and the head 7 ft. in diameter. A second tree of the same species, Mr. Robertson informs us, has stood out equally well in an exposed situation; and neither has ever received any protection whatever.

9. *O. americana* L., Michx. Arb. Amer. 3. t. 6., and our fig. 1034., the devil-wood of the Americans, is a tree, a native of the southern states, as far north as Norfolk, in Virginia. It is sometimes found as high as 30 ft. or 35 ft.; but its ordinary height is 10 ft. or 12 ft. The leaves are 4 in. or 5 in. long, of a shining light green; and they remain on two or three years. The fertile and barren flowers, Michaux states, are on separate trees; though, according to Linnæus (*Mant.*), there are male and female flowers on the same plant with hermaphrodites. The flowers are very small, of a pale yellow, and strongly scented; appearing about the end of April. The fruit is round, about twice the size of the common pea; and, when ripe, of a purple colour, approaching to blue. It ripens in October, and remains attached to the tree during a great part of the winter, forming a fine contrast to the foliage. This plant is considerably harder than the common olive; and, in the climate of London, would probably stand the open air, in a sheltered situation, as a standard. There is a very handsome flourishing plant against the wall, in the arboretum of Messrs. Loddiges, which receives no protection whatever.

10. *O. fragrans* Thunb., *Bot. Mag.*, t. 1552., *Bot. Cab.*, t. 1786., and our fig. 1035. f is a native of Japan and China, where it is much cultivated for the sake of its sweet-scented flowers; which, it is said, are used for giving flavour to tea. The plant, though not very hardy, would probably stand against a conservative wall, with a little protection. The scent of this plant, Messrs. Loddiges observe, "is astonishing; and so diffusive, that we distinctly noticed it, when in bloom, on the back wall of our green-house, at considerably more than 100 yards' distance." (*Bot. Cab.*, t. 1786.)

11. *O. capensis* L.; *O. buxifolia* Mill., *Hort. Elth.*, l. t. 160. f. 194., *Bot. Reg.*, t. 613.; has coriaceous, oblong, dense, and rigid leaves. It is a native of the Cape of Good Hope, where it forms a tall tree; and, if grafted on the common privet, would doubtless stand against a conservative wall, with a little protection.



1033

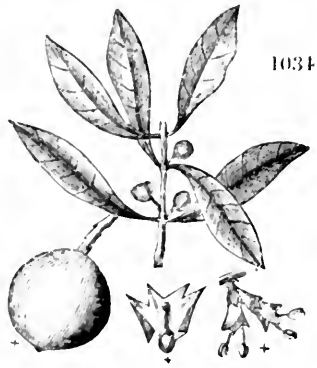

1034



1035

Sect. II. SYRINGÆÆ.

GENUS IV.



SYRINGA L. THE LILAC. *Lin. Syst.* Diándria Monogýnia.

Identification. *Lin. Gen.*, No. 22.; *Gärtn. Fruct.*, l. t. 49.; *Lindl. Nat. Syst. Bot.*, ed. 2., p. 308.; *Don's Mill.*, 4. p. 51.

Synonymes. *Lilac* Tourn. *Inst.*, t. 372., *Juss. Gen.*, p. 105.; *Lilas, Fr.*; *Flieder, Ger*

Derivation. From *siriux*, the native name in Barbary. The tubes of the finest Turkish pipes are manufactured from the wood of this shrub; and also from that of the *Philadelphus coronarius*, to which the name was originally given (see p. 951.). Hence the old English name of Pipe Tree, which was applied both to the *Philadelphus* and the *Syringa*. Lilac is from *lilac*, or *lilag*, the Persian word for a flower.

Gen. Char., &c. *Calyx* small, 4-toothed. *Corolla* funnel-shaped, with a 4-parted limb. *Stamens* 2, enclosed. *Stigma* trifid. *Capsule* ovate, compressed, 2-celled, 2-valved, 2-seeded; valves navicular, with a narrow dissepiment in the middle. (*Don's Mill.*, iv. p. 51.)—Deciduous shrubs, with simple leaves and thyrsoid terminal panicles of flowers, which are oppositely branched. Flowers purple or white. Natives of Europe and the colder parts of Asia; highly valued in the gardens of temperate climates for the beauty and fragrance of their flowers, and the profusion in which these are produced in the spring of the year. The natural mode of propagating is by suckers, which all the species produce in abundance; and they will all grow in any common soil. The price of plants, in the London nurseries, is from 6*d.* to 1*s.* 6*d.* each; at Bollwyller, from 30 cents to 2 francs; and at New York, where all the sorts are quite hardy, from 25 cents to 50 cents.

♣ *S. VULGARIS L.* The common Lilac.

Identification. *Lin. Sp.*, 11.; *Don's Mill.*, 4. p. 51.; *Lodd. Cat.*, ed. 1836.

Synonymes. *Lilac vulgaris Gærtn.*; Pipe Privet, or Pipe Tree; Lilas commun, *Fr.*; gemeiner Flieder, *Ger.*

Engravings. *Lam. Ill.*, t. 7.; *Schmidt Baum.*, t. 77.; *N. Du. Ham.*, t. 61.; *Schkuhr Handb.*, 1. t. 2.; and our *fig.* 1036.

Spec. Char., &c. Leaves ovate-cordate, acuminate. The common blue lilac, now so plentiful in every plantation, was a great rarity in the year 1597. (*Don's Mill.*, iv. p. 51.) A shrub, from 8 ft. to 10 ft. high, a native of Persia, and of Hungary, of chalky precipices in the Cverna valley, and Mount Doglet, as well as of the whole group of rocks along the Danube. In cultivation in Britain in 1597, and flowering in May.

Varieties.

♣ *S. v. 1 cærulea* *Clus. Hist.*, i. p. 56., *Ger. Emac.*, 1399. f. 2., *Besl. Eyst.*, t. 1. f. 2., *Park. Par.*, 407. t. 409. f. 4., *Theatr.*, 1467. f. 1. *The common blue Lilac.*—There is a subvariety, with the leaves imperfectly variegated.

♣ *S. v. 2 violæcea* *Curt. Bot. Mag.*, t. 183., *Mill. Ic.*, t. 163. *The common purple Lilac*; also called the Scotch Lilac, because it was first recorded in *Sutherland's Catalogue of the Edinburgh Botanic Garden.*

♣ *S. v. 3 alba.* *The common white Lilac.*—This variety flowers earliest.

♣ *S. v. 4 alba major* *Lodd. Cat.*, ed. 1836, has larger flowers than the previous variety.

♣ *S. v. 5 alba plèna, S. plèna* *Lodd. Cat.*, is said to have the flowers double; but the plant bearing this name in the Horticultural Society's Garden has single flowers.

♣ *S. v. 6 rubra* *Lodd. Cat.* has red flowers.

♣ *S. v. 7 rubra major* *Lodd. Cat.*, ed. 1836; the Lilas de Marly of the French gardeners; has flowers larger than the parent variety.

Other Varieties. A number of plants have been raised from seed by Mr. Williams of Pitmaston, of which there are six sorts, tolerably distinct, in the Horticultural Society's Garden. The French nurserymen are also in possession of some new seedlings; but none of all that we have observed are so well deserving of culture as the common blue, violet, red, and white. In the arboretum of Messrs. Loddiges there is a plant marked *S. chinensis*, which appears to be *S. vulgaris alba*; and another, received from Soulange-Bodin, marked Charles X. (*S. v. Caroli* *Lodd. Cat.*, ed. 1836), which appears to be a variety of *S. v. purpurea*. Another, marked *S. sibirica*, appears to be *S. v. purpurea*; but, these plants, except the first, being quite young, we have only seen them in leaf.

Description, &c. The common lilac grows to the height of 20 ft. and

upwards in good free soil; and, though it naturally sends up abundance of suckers in every direction, so as to form a dense mass of stems, yet, when these are cleared away as they appear, and only one stem left, it may be trained to form a very handsome small tree, beautiful when in leaf, and preeminently so when in flower. The rate of growth is considerable, varying, according to the soil and situation, from 18 in. to 3 ft. in a year, for the first five or seven years. The duration is not great; probably between twenty and thirty years, in rich soils, and between forty and fifty in such as are dry and comparatively poor. Plants which are never allowed to produce suckers of any size, and in which the bunches of flowers have been thinned out, ripen seeds; and these, according to Miller, produce plants which are true to their varieties. The common lilac was, till lately, thought to be exclusively a native of Persia; but, within the last few years, it has been found by Dr. Baumgarten in Transylvania. (*Flora Transyl.*, vol. i. p. 16.) The blue and the white varieties were cultivated by Gerard and Parkinson, in 1597, under the name of the blue-pipe and white-pipe; and, apparently, confounded with *Philadelphus*, which was also called pipe tree. The first time the lilac was made known to European botanists was by a plant brought from Constantinople to Vienna, by the ambassador Busbequius, towards the end of the 16th century. From the plant being very showy, of the easiest culture, and extremely hardy, it soon spread rapidly throughout the gardens of Europe. In some parts of Britain, and various parts of Germany, it is mixed with other shrubs, or planted alone, to form garden hedges; and, as a proof of its hardiness, we may mention that there are hedges of it by the road-sides, in the neighbourhood of Ulm and Augsburg, in the elevated, and consequently cold, region of Bavaria. Mixed with sweet briars, sloe thorns, scarlet thorns, Guelder rose trees, &c., it forms beautiful hedges to cottage gardens, where there is abundance of room. In the survey of the royal gardens of Nonsuch, planted in the time of Henry VIII., there is mentioned a fountain "set round with six lilac trees, which bear no fruit, but only a very pleasant smell." (*Syl. Fl.*, ii. p. 47.) Many poets have alluded to this tree; and Cowper, in the following lines, enumerates some of the kinds commonly grown in British gardens:—

"The lilac, various in array, — now white,
Now sanguine, and her beauteous head now set
With purple spikes pyramidal, — as if
Studious of ornament, yet unresolved
Which hue she most approved, she chose them all."

2. *S. JOSIKÉA* Jacq. Josika's Lilac.

Identification. Jacq. in *Bot. Zeit.*, 1831, t. 67.; *Rehb. Pl. Crit.*, No. 1049. t. 780.; *Don's Mill.*, 4. p. 51.; *Lodd. Cat.*, ed. 1836.

Engravings. Hook. *Bot. Mag.*, t. 3278.; *Lindl. Bot. Reg.*, t. 1733.; *Rehb. Pl. Crit.*, No. 1049. t. 780.; and our *figs.* 1037, 1038.

Spec. Char., &c. Leaves elliptic-lanceolate, acute, ciliated, wrinkled, glabrous, on short petioles, white beneath. Flowers purple. (*Don's Mill.* iv. p. 51.) A shrub, from 6 ft. to 8 ft. high; a native of Transylvania, where it was discovered by the Baroness Von Josika, in compli-

1036



1037



1038

ment to whom it was named by Baron Jacquin. It is an upright shrub, with spreading branches, and purple twigs. Its leaves are elliptic-lanceolate, 3 in. long, and $1\frac{1}{4}$ in. broad, shining and lucid green above, and white beneath, in the manner of those of the balsam poplar; but of a deep dark green, something like that of the leaves of *Chionánthus*. It was found growing in shady places, near water, along with *Fāgnus sylvática*, *Cōrylus Avellāna*, *Frāxinus*, *Spiræ'a*, *Rōsa*, *Ribes*, and *Atrāgene*, and rising from the height of 12 ft. to that of 18 ft. (See *Allgem. Gartenzeit.*, vol. i. p. 5.) This sort has certainly a very different appearance from the common lilac; but it may, after all, be only a variety of it. It was first sent to Britain by Messrs. Booth of the Floetbeck Nurseries; and there are now plants in the Garden of the Horticultural Society, in the Edinburgh Botanic Garden, and in some other collections; so that there can be no doubt but that, by grafting and budding, it will soon be as easily to be procured in the British nurseries as the common lilac. The price of plants, in the Fulham Nursery, is 7s. 6d. each.

3. *S. PE'RSICA L.* The Persian Lilac.

Identification. Lin. Sp., 11; Don's Mill., 4. p. 51.; Lodd. Cat., ed. 1836.

Synonymes. *Lilac minor Mench*; *Lilac persica Lam.*; *Lilas de Perse, Fr.*

Engravings. Curt. Bot. Mag., t. 486.; Mill. Fig., 164. f. 1.; Mant., t. 57.; Pluk. Phyt., 227. f. 8.; and our fig. 1039.

Spec. Char., &c. Leaves small, lanceolate, entire.

Flowers purple. (*Don's Mill.*, iv. p. 51.) A shrub, from 4 ft. to 6 ft. high; a native of Persia. Introduced in 1640, and flowering in May and June. It is one of the most common, and, at the same time, one of the most ornamental, of our low deciduous shrubs. It is frequently planted in pots, and forced so as to come into flower at Christmas, for the purpose of ornamenting rooms; and it is remarkable, that, though the flowers are very fragrant when they expand naturally in the open air, yet in the hot-house they are quite scentless; doubtless from the want of sufficient light to elaborate the volatile oil, which is the cause of the odour. In Paris, it is said, they retard the Persian lilacs, by placing them in an icehouse in December, and keeping them there till the September or October following, when they will come into bloom without the aid of artificial heat about Christmas, so as to be ready for the bouquets given as presents on New Year's Day. (See *Gard. Mag.*, vii. p. 247.) The species is generally propagated by cuttings, and the varieties by layers.



1039

Varieties.

♣ *S. p. 2 álba* Lodd. Cat., ed. 1836. *The white Persian Lilac.*—Leaves lanceolate, entire. Flowers white.

♣ *S. p. 3 laciniata* Lodd. Cat., ed. 1836, Mill. Dict., No. 3., Icon., t. 164. f. 2., and our fig. 1040., Lin. Hort. Cliff. 6., Lodd. Bot. Cab., 1107., Munting, t. 56., Tourn. Inst., 602.; *S. capitata Gmel. Itin.*, iii. p. 304. t. 32. f. 1., *Schmidt Baum.*, ii. p. 79.; *Lilas à Feuilles de Persil, Fr.* *The cut-leaved Persian Lilac.*—This variety has some of its leaves pinnatifidly cut, and nearly all of them cut in some manner.



1040

- ✻ *S. p.* 4 *salvijolia* Lodd. Cat., ed. 1836, has the leaves somewhat hoary, like those of the common sage.

✻ 4. *S. ROTHOMAGENSIS* Renault. The Rouen Lilac.

Synonymes. *S. dubia* Pers. *Ench.*, 1. p. 9.; *Lilæcum rothomagense* Renault *Fl. de l'Orn.*, p. 100.; *S. média* Dum. *Cours.*, 1. p. 709., *Lodd. Cat.*, ed. 1836.; *Lilas Varin*, N. Du Ham.; *S. chinensis* Willd. *Sp.*, 1. p. 48., *Ecrol. Baumz.*, p. 498., *Don's Mill.*, 4. p. 51.; *S. sibirica* Hort.; the Siberian Lilac, Hort

Engravings. N. Du Ham., 2. t. 63.; and our fig. 1041.

Spec. Char., &c. Leaves ovate-lanceolate. Flowers purple. (*Don's Mill.*, iv. p. 51.) An intermediate plant between *S. vulgaris* and *S. persica*. In Belgium, there is a hybrid between this and *S. vulgaris*, called *S. média*, or the Belgic Lilas de Marly; which is probably the *S. rothomagensis* of Turp. et Poit. *Fl. de Par.* A shrub, from 6 ft. to 8 ft. high; a hybrid between *S. vulgaris* and *S. persica*; raised at Rouen by M. Varin, the director of the Botanic Garden there, and introduced into British gardens in 1795; flowering in May and June. It is of very vigorous growth, and a most abundant flowerer; and, in favourable soils and situations, it will attain the height of 10 ft. or 12 ft. This sort, and the preceding one, grafted standard high on the ash, or the common privet, would form very ornamental trees.



Varieties. The following are mentioned in the *Bon Jardinier* for 1836:—

- ✻ *S. r.* 2 *Lilas Royal* *Bon Jard.* has the flowers more compact than the Belgic Lilas de Marly.
- ✻ *S. r.* 3 *sanguinea* Hort.; *Lilas saugé*, Fr.; differs from the *Lilas Varin* in having the flowers more red and more beautiful. There are plants in the arboretum of Messrs. Loddiges. It is probably identical with the variety mentioned in *Gard. Mag.*, vii. p. 379., of which there are plants in the Grosvenor Nursery, King's Road, cultivated by Mr. Dennis. *S. coccinea* and *S. chinensis rubra* Lodd. Cat., ed. 1836, appear to be identical with this variety, or very slightly different; but the plants are too small to have yet produced flowers.

App. i. *Species of Syringa not yet introduced.*

S. Emodi Wall. Cat., No. 2831., *Don's Mill.*, 4. p. 51., *Royle Illust.*, p. 267. t. 65. f. 2.; and our fig. 1041.; has the leaves elliptic-oblong, glaucous beneath, attenuated at the base, and acuminate at the apex. Branches warted. Thyse terminal and paniced. Capsules almost cylindrical. The bud-scales permanent at the base of the year's shoots. A shrub, from 8 ft. to 10 ft. high, a native of Kamaon, towards the Himalayas, with purple flowers, which appears to be a very desirable plant. All the lilacs are so beautiful, both in foliage and flowers, and of such easy culture in any common garden soil, and even in climates of considerable severity, that the number of sorts, provided they are truly distinct, can hardly be too much increased. The objection which we have to this genus of shrubs is, their liability to throw up suckers, which, as we have more than once before observed, have a disorderly and ungardensque appearance, and are only suitable for scenery in which the object is to imitate wild and neglected nature. For this reason, we have often wished that all the sorts of lilac cultivated in British gardens were worked on stocks of the common privet, on which, it is said, they will succeed perfectly. As the privet is quite hardy, and does not throw up suckers, this, we think, would be a real improvement, at least with reference to gardensque beauty.

S. villosa Vahl Enum., 1. p. 38., *Don's Mill.*, 4. p. 51., is a native of China, on mountains about Peking; and, according to G. Don, it is, perhaps, the same as *Ligustrum sinense* Lour.



GENUS V.



FONTANESIA Labill. **THE FONTANESIA.** *Lin. Syst.* Diándria Monogýnia,

Identification. Labill. Pl. Syr., dec. 1. p. 9. t. 1.; Lam. III., l. 1. 22.; Lindl. Nat. Syst. Bot., ed. 2., p. 308.; Don's Mill. 4. p. 51.

Derivation. Named after *René Louiche Des Fontaines*, author of *Flora Atlantica*, 2 vols. 4to, Paris, 1798-99, and several other works.

Gen. Char., &c. *Calyx* 4—6-parted, permanent. *Corolla* 4—6-parted, deciduous. *Stamens* 2, elongated. *Stigma* bifid, hooked. *Capsule* a 2—4-winged, 2-celled, papery, indehiscent samara; cells 1-seeded. (*Don's Mill.*, iv. p. 51.) A subevergreen shrub, with lanceolate leaves, and axillary racemes of yellowish white flowers. This genus seems to be a connecting link between the tribes *Fraxiniæ* and *Olèinæ*.

♂ ♀ **I. F. PHILLYREÏDES** Labill. **The Phillyrea-like Fontanesia.**

Identification. Labill. Syr., dec. 1. p. 9. t. 1.; Don's Mill., 4. p. 51.; Lodd. Cat., ed. 1836.
Engravings. Lodd. Bot. Cab., t. 1308.; and our fig. 1043.

Description, &c. A shrub or low tree, growing to the height of from 10 ft. to 14 ft., or upwards, with leaves acute at both ends; a native of Syria, between Laodicea and Mount Cassius, and of Sicily. It was introduced in 1787, and flowers in June. The flowers are at first of a greenish white, or yellowish green; but they afterwards become of a brownish yellow, and remain on the tree two or three months. The leaves of the plant, in Syria, and in the neighbourhood of Alexandria, and also in Italy, remain on till spring; but, in the neighbourhood of Paris and London, they drop off in the course of the winter, like those of the common privet; to which plant the fontanesia bears a close general resemblance, though it is strikingly different in having a rough exfoliating bark. It grows rapidly, forming a large bush 10 ft. or 12 ft. high in as many years; or, if trained to a single trunk, a very handsome tree, with numerous slender, divergent, drooping branches. There are plants of it in the Horticultural Society's Garden, and in the arboretum of Messrs. Loddiges, 8 ft. or 10 ft. high, which flower freely every year; and one in the Kew Garden, 8 ft. high. It is readily propagated by layers, by cuttings, or by grafting on the common privet. Grafted standard high on the ash, it would form a very handsome drooping-branched tree. Plants, in the London nurseries, are 1s. each.



Forsythia Vahl is a genus named in honour of William Forsyth, Esq., Royal Gardener at Kensington, author of *Observations on the Diseases of Trees*, &c., who died in 1804; and to whose son, of the same name, who died in 1835 (See *Gard. Mag.*, vol. xi. p. 496.), we are much indebted for contributions to the historical part of this work, and to that of the *Encyclopædia of Gardening*.

F. suspensa Vahl, *Syringa suspensa* Thunb., *Lilac perþense* Lam., is a native of Japan, where it is cultivated for the elegance of its flowers, which are yellow. It is an ascending shrub, with pendent tetragonal branches, and oval, simple, or trifoliate leaves. It is probably half-hardy or quite hardy; and it is to be regretted that it is not yet introduced.

Sect. III. **FRAXINIÆ.**

GENUS VI.

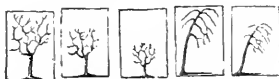

FRA'XINUS Tourn. **THE ASH.** *Lin. Syst.* Polygámia Diœ'cia.

Identification. Tourn. Inst., 343.; *Lin. Gen.*, No. 1160.; *Michx. Gen.*, 107.; *Juss. Gen.*, 105

Schkuhr Handb., t. 375; Lam. Ill., t. 858; Gärtn. Fruct., l. t. 39; Lindl. Nat. Syst., Bot., p. 308; Don's Mill., 4. p. 53.

Synonymes. Frêne, Fr.; Esche, Ger.

Derivation. The derivation of *Fraxinus* given in Don's *Miller* is, from *phrassō*, to enclose; the ash having been formerly used for making hedges. Linnaeus derives it from *phraxis*, a separation, because the wood splits easily. Others derive it from *frangitur*, because the young branches are easily broken; or which may have been applied ironically, in allusion to the extreme toughness of the old wood. None of these derivations, however, appears very satisfactory. The English name of ash may be derived either from the Saxon word *æse*, a pike; or from the colour of the bark of the trunk and branches, which resembles that of wood ashes.

Gen. Char., &c. *Flowers* polygamous. *Calyx* none, or 4-parted, or 4-toothed. *Corolla* none. *Stamens* 2, in the male flowers. *Anthers* sessile, or on short filaments, dehiscing outwardly. *Female flowers* the same, except that they have no stamens, but have each a pistil, that has a bifid stigma. *Fruit*, or samara, 2-celled, compressed, winged at top. *Cells* 1-seeded. (*Don's Mill.*, iv. p. 53.)—Deciduous trees, with opposite, impari-pinnate, rarely simple leaves; and lateral racemes of greenish yellow flowers. Natives of Europe, the north of Africa, part of Asia, and of North America. The species are raised from seeds; and the varieties chiefly by grafting on *Fraxinus excelsior*, but partly also from seeds. There is a great tendency in all the species to sport into varieties; and many of what are by botanists described as species are, in our opinion, not entitled to that distinction. In the neighbourhood of Edinburgh, on the banks of the Esk, more especially on the estate of Dalhousie, we are informed that the ash is indigenous over several acres of steep rocky declivities bordering the river, and that many very distinct varieties may there be collected. The American ash seems as prolific in varieties as the European species; and some of these varieties, which by botanists are treated as species, generally come true from seed; a circumstance no more surprising than that particular varieties of fruit trees should frequently come nearly as true to the parent variety, as the seedlings of species come true to species. All the ashes are of easy culture in good soil, and in a sheltered situation. The general price of the American plants is from 1s. 6d. to 2s. 6d. per plant; and seeds may be obtained of six or seven of the sorts at 4d. per quart.

A. *Leaflets broad, smooth or shining on the upper surface. Natives of Europe.*

‡ 1. *F. EXCELSIOR L.* The taller, or common, Ash.

Identification. Lin. Sp., p. 1509; Willd. Sp., 4. p. 1099; Don's Mill., 4. p. 53; Lodd. Cat., ed. 1836.

Synonymes. *F. apétala* Lam. *Fl. Fr.*, *Lam. Ill.*, t. 858. f. 1.; *F. rostrata* Guss. *Fl. Rav.*, p. 374.; *F. Orynus* Scop. *Carn.*, No. 1219.; *F. crōsa* Pers.; *F. crispa* Bosc; le Frêne, Fr.; Aesche or Esche, Ger. and Dutch; Ask, Dan. and Swed.; Frassino, Ital.; Fresno, Span.; Fréixo, Port.; Jas, Jasen, or Jassen, Russ.; Æse, Sar.

Engravings. Fl. Dan., t. 969; Smith Eng. Bot., t. 1692; Svensk. Bot., 175; Lam. Ill., t. 858. f. 1.; Blackw., t. 328; Dodon. Pempt., 771.; Lob. Icon., 2. p. 107. f. 2.; our fig. 1044.; and the plates in our last Volume.

Spec. Char., &c. Leaflets almost sessile, lanceolate-oblong; acuminate, serrated, cuneated at the base. Flowers naked. Samara obliquely emarginate at the apex. The leaves have generally 5 pairs of leaflets, but sometimes 6. The flowers are produced in loose spikes, from the sides of the branches. On some there are only female flowers; on others hermaphrodite ones; and on others male ones; while on some trees the flowers are found in two of these states, or in all of them. (*Don's Mill.*, iv. p. 53.) A tree, from 30 ft. to 80 ft. high, flowering in March and April, before the leaves appear.

Varieties. These are very numerous; but we shall give chiefly those which are allowed to be varieties by botanists, and are described as such in Don's *Miller*, or in our *Hortus Britannicus*; afterwards indicating those which are treated by botanists as species, and which we have accordingly kept distinct, but which we are decidedly of opinion are nothing more than varieties.

‡ *F. e. 2 pëndula* Ait. Hort. Kew, ed. 2., vol. v. p. 475., Lodd. Cat., ed. 1836; Frêne Parasol, Fr.; and the plate in our last Volume. *The pëndulous*, or weeping, Ash.—Branches pendulous. This sin-

gular and beautiful variety was discovered, about the middle of the last century, in a field belonging to the vicar of Gamlingay, near Wimpole, in Cambridgeshire. Professor Martyn, in his edition of Miller's *Dictionary*, published in 1807, says that he recollects it for nearly forty years as a very fine pendulous-branched tree. In June, 1835, the tree was visited, at our request, by Mr. James Dall, late gardener to the Earl of Hardwicke, at Wimpole, who sent us the following account of it:—"The tree is now comparatively in ruins. The trunk girths 6 ft. at 1 ft. from the ground. The trunk is 12 ft. high; at which height it branches out into two arms, each about 15 ft. in length. Three years ago, ten decaying branches were lopped off, and four have been since blown off by the wind. The tree formerly stood in the open field; but it is now included in the garden occupied by the Rev. Mr. Hepworth, the present



1044

vicar of the parish. Mr. Hepworth enquired of the late clerk of the parish, who has been dead more than 20 years, and who, at the time of his death, was 90 years old, how long he recollects the tree. His answer was, ever since he was a boy, and that it was the same size then that it is now." When grafts first began to be taken from this tree by the nurserymen, we have not been able to ascertain; but there are weeping ashes in the county estimated at 50 years' growth. Many have been planted in England; some in Scotland and Ireland; some, also, in France and Germany; and the name of the variety is in the American catalogues. In the list of ash trees planted in the government gardens at Odessa, by M. Descemet, is one with pendent branches, found in a bed of seedlings, which may possibly be somewhat different from the English variety. The weeping ash is commonly grafted standard high; and, as it is very hardy, and grows with very great rapidity, it is a valuable tree for forming arbours, or for covering seats, more especially in public gardens. An ash tree, 100 ft. high, such as are sometimes to be met with in woods, might be changed into a singular object by grafting it at the summit with a weeping ash. If in the midst of a wood, a number of trees might be cut down round it so as to form an open area of 100 ft. or 200 ft. in diameter, which would give an opportunity of seeing the tree advantageously on every side. The weeping ash ripens seeds in abundance. We have not heard whether these seeds produce upright-growing trees generally, or whether they do not occasionally send up pendulous-branched ones; but, judging from analogy, we think it extremely probable that the latter may be the case.

‡ *F. e. péndula* var. The Cowpen Ash. (*fig.* 1045.)—As we are uncertain whether this is a variety, or a mere variation, and strongly suspect it to be only the latter, we have not put a number before the name. Drawings of two of these trees (of one of which, 60 ft. high, *fig.* 1045. is an engraving) were sent us, in February, 1836, by M. J. F. Sydney, Esq., of Cowpen, near Morpeth, who gives the fol-

1045

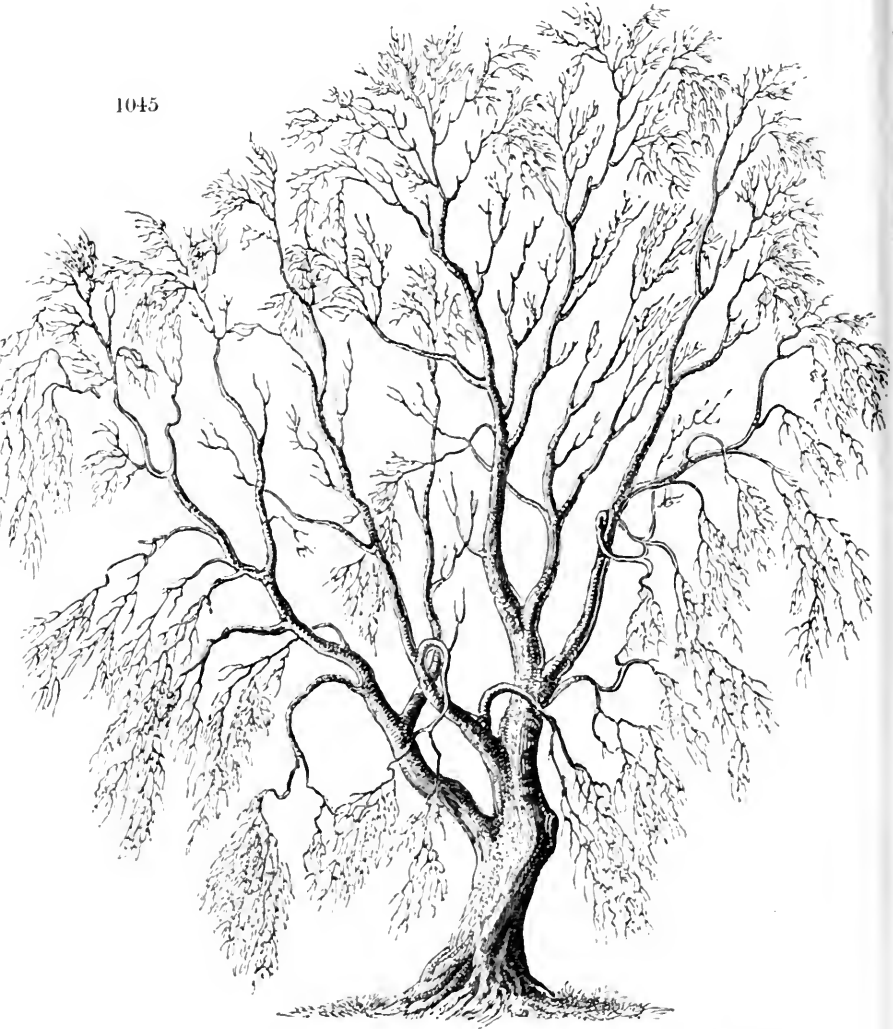

lowing account of them:—"No. 1. (*fig.* 1045.) grows upon a bank, or high ground, in a hedgeway, about a quarter of a mile beyond Morpeth, by the side of the Edinburgh turnpike-road. No. 2., an elegant tree, between 55 ft. and 60 ft. high, stands close to the edge of the bank of the river Wansbeck, a little beyond the new bridge which leads to the Milton Road; and there is another ash tree, of the same description, a short distance before reaching the bridge. These three trees are the only ones that I know the localities of; and, though I have been told at Morpeth, by several persons, that they thought there were more of the same kind of trees growing in the neighbourhood, yet no one knew where, or was even sure of the circumstance. These trees have long attracted my attention, from the gracefulness of their appearance, and from their dissimilitude to the other ash trees in this

neighbourhood. The ash is particularly abundant in this part of Northumberland." Mr. Sydney having kindly sent us grafts of the Cowpen ash, we have distributed them among the nurserymen, and plants have been raised from them in the Fulham Nursery. Mr. George M^r Leish, a correspondent of the *Gardener's Magazine*, informs us that there are a number of ash trees growing out of the rocks immediately below the Rumbling Bridge, on the Duke of Athol's estate, a few miles from Dunkeld, which are probably not above 30 years of age, which have weeping branches, that droop almost to the surface of the water. Whether these trees belong to the common weeping ash, to the Cowpen variety or variation, or to the Kincairney ash, to be next described, remains to be ascertained.

- ‡ F. e. 3 *Kincairnie*, the *Kincairney Ash*, has the spray alternately pendulous, and rigidly upright, and thus forms a tree of fantastic shape. The original specimen grows on the estate of Mungo Murray, Esq., in Kincairney, in the parish of Caputh, near Dunkeld, Perthshire. It is 46 ft. high; the trunk, at 12 ft. from the ground, is 3 ft. in diameter; and the diameter of the head, in the widest part, is 74 ft. It appears to have been first brought into notice by Mr. Gorrie, who sent us a drawing and description of it in 1833 (see *Gard. Mag.*, vol. x. p. 384.); and who, having at that time directed the attention of Messrs. Dickson and Turnbull of Perth to its propagation, they, we are informed, have now plants of it for sale.
- ‡ F. e. 4 *áurea* Willd. Enum., p. 1059.; *F. áurea Pers. Eneh.*, ii. p. 604., *Lodd. Cat.*, ed. 1836; the *golden-barked Ash*; has the bark of the trunk and branches yellow and dotted; and the leaflets sessile, lanceolate, unequally serrated, acuminate, cuneate at the base, and glabrous. It is conspicuous, particularly in winter, not only from the yellow colour of its bark, but from the curved, contorted character of its branches, which somewhat resemble the horns of an animal.
- ‡ F. e. 5 *áurea péndula* has the bark yellow, and the branches as pendulous, and of as vigorous growth, as those of *F. e. péndula*. There are fine specimen plants of this variety in the New Cross Nursery, and in the Marylebone Nursery, New Road.
- ‡ F. e. 6 *críspsa*; *F. críspsa Bose*; *F. atrovirens Desf. Arb.*, i. p. 104.; has the leaves dark green, crumpled, and curled. The darkness of the green of the leaves is remarkable; and this and their crumpled appearance, combined with the rigid stunted character of the whole plant, render it a striking object. The largest tree we know of, of this variety, is at Farnham Castle, Surrey; where, in 50 years, it has attained the height of 15 ft.; the diameter of the trunk 4 in., and of the head 5 ft. In Jersey, in Saunders's Nursery, there is a tree, which, in 12 years, has attained the height of 8 ft.; the diameter of the trunk 3 in., and of the head 3 ft.
- ‡ F. e. 7 *jaspídea* Willd., *Lodd. Cat.*, ed. 1836, the *striped-barked Ash*, has the bark of the trunk and branches streaked with reddish-white. There are specimens at West Dean, in Surrey, 9 years planted, and 21 ft. high; at Eaton Hall, in Cheshire, 14 years planted, and 16 ft. high; and at Ampton Hall, in Suffolk, 18 years planted, and 20 ft. high.
- ‡ F. e. 8 *purpuráscens* Descemet, the *purple-barked Ash*, has the bark purple. It was found in a bed of seedlings by M. Descemet; and there are plants of it in the collection under his care at Odessa.
- ‡ F. e. 9 *argétea* Desf. Arb., *Lodd. Cat.*, ed. 1836, the *silver-striped-leaved Ash*.—Leaves variegated with white.
- ‡ F. e. 10 *lútea*, the *yellow-edge-leafleted Ash*, has the leaflets edged with yellow.
- ‡ F. e. 11 *erósa* Pers. Eneh., i. p. 604., has the leaflets closely toothed.

- † *F. e. 12 horizontalis* Desf., Pers. Ench., i. p. 604., Lodd. Cat., ed. 1836, *the horizontal-branched Ash*, has the branches spreading horizontally.
 † *F. e. 13 verrucosa* Desf., Pers. Ench., i. p. 604., Lodd. Cat., ed. 1836, *the warted-barked Ash*, has the branches warted.
 † *F. e. 14 verrucosa pëndula*. — A tree of this variety in the Horticultural Society's Garden was, in 1835, 10 ft. high, after being 16 years planted.
 † *F. e. 15 nana* Lodd. Cat., ed. 1836, *F. e. humilis Hort.*, *the dwarf Ash*, seldom exceeds 3 ft. in height, but there is a plant in the Horticultural Society's Garden, bearing this name, which is 7 ft. high, and its stem immediately above the graft is 4 in. in diameter. The leaves of this variety resemble those of the common ash, but the leaflets are much smaller and closer together.
 † *F. e. 16 fungosa* Lodd. Cat., ed. 1836. *The fungus-barked Ash*.
 † *F. e. 17 verticillata* Lodd. Cat., ed. 1836. *The whorled-leaved Ash*.
 † *F. e. 18 villosa nana* Descemet is a seedling, discovered accidentally, of which there are plants in the Odessa collection.

Other Varieties. In addition to the above varieties of the common ash, there are several names in the *Catalogue* of Messrs. Loddiges, and in the collection in the Chiswick Garden, which will be found in an appendix to this article. The plants to which these names apply, are, for the most part, small, or crowded among other trees or shrubs; so that we have been unable to determine whether they are truly distinct or not.

Description. The common ash is one of the noblest of our forest trees. In a close grove, and in a free deep soil, it becomes one of the loftiest of British trees, with a trunk free from branches to a great height. Standing singly, it throws out large limbs, which divide into numerous branches, forming a full spreading head, with a short, but very thick, trunk. In some situations, particularly on rocky steeps, the branches on old trees become pendent; but, as in all cases of old ash trees whatever, as Sir J. E. Smith observes, there is a tendency in the extremities of the lower branches to curve upwards. The bark is ash-coloured when old, and dark grey when young. The buds are short, oval, obtuse, and constantly black: and, by this last circumstance, the common ash is easily distinguished from the American species. The leaves are opposite, and are composed of from 5 to 13 leaflets, slightly pedicellate, smooth, oval, acuminate and serrated. The common petiole is semicylindrical, with a channel on the upper side. The roots are numerous, and take a horizontal direction; and they are furnished with more fibres than those of most other forest trees. Both fibres and roots are white, which, indeed, is the case with the roots of all the *Oleaceæ*. If the tree is planted in good soil, it grows rapidly when young, attaining the height of 15 ft. and upwards in 10 years. The height of full-grown trees, in the most favourable situations, is from 80 ft. to 100 ft., and their duration several centuries. No deciduous tree whatever, in cultivation in British plantations, is more injurious to plants growing under it, than the ash; from its numerous fibrous roots, which, rising close to the surface, exhaust the soil, and prevent the vegetation of almost every other plant, except those that have also fibrous roots.

Geography. The common ash is indigenous to central Europe, to Sweden, to Norway, to Russia, to the south of Europe, to the north of Africa, and to Japan; and there is a species in America (the white American ash) which closely resembles it in many respects, except that it has whitish buds instead of black ones. In Britain, the ash is found in most parts of the island, from Ross-shire to Cornwall. It always grows best in good, somewhat calcareous, soil; which, though not boggy, is generally adjoining water. Its most favourite situations are on the steep rocky banks of rivers, or on the sides of glens, at the base of which, where there is generally a great depth of soil, and a stream not very distant, the tree attains its largest size. The most profitable age for felling the ash appears to be from 80 to 100 years. It will continue pushing from stools or from pollards, for above 100 years.

History. The ash was known to the Greeks, whose name for it was melia or boumelia; and both Greeks and Romans made their spears of its wood. It was also valued by them for its medical properties. By the Roman agricultural writers it is recommended as peculiarly fit for making agricultural implements, to which purpose it is chiefly applied in modern times.

Properties and Uses. The timber of the ash is very elastic; so much so, that a joist of this timber will bear more before it breaks than one of that of any other tree indigenous to Europe. It weighs, per cubic foot, 64 lb. 9 oz. when green; and 49 lb. 8 oz., when dry. The value of the timber is increased by the rapidity of its growth; and, as in the case of the sweet chestnut, the wood of young trees is more esteemed than that of old ones. The texture of the wood is alternately compact and porous; and, where the growth has been vigorous, the compact part of the annual layers bears a greater proportion to the porous, and the timber is comparatively tough, elastic, and durable. In durability, however, and also in rigidity, it is inferior to the oak: but it is superior to that wood, and to every other, in toughness and elasticity; and hence its universal employment in all those parts of machinery which have to sustain sudden shocks; such as the circumference, teeth, and spokes of wheels, beams of ploughs, &c. (*Tredgold's Carpentry.*) Since the use of iron became so general in the manufacture of instruments and machines, the value of the ash is somewhat diminished, at least in Britain; it still, however, ranks next in value to that of the oak, and is held even to surpass it for some purposes. It is much in use by the coachmaker, the wheelwright, and the manufacturer of agricultural implements. It is highly valued for kitchen tables, as it may be scoured better than any other wood, and is not so liable to run splinters into the scourer's fingers. For the same reason, it was formerly much used in staircases; and in old houses, for example, at Wroxton Abbey, near Banbury, the seat of the Earl of Guildford, the staircase is entirely formed of this wood. Milkpails, in many parts of England, are made of thin boards, sawed lengthwise out of the tree, each rolled into a hollow cylinder, with a bottom affixed to it. The roots, and the knotty parts of the trunk, are in demand by cabinet-makers, for this curious dark figures formed by their veins, which make a singular appearance when polished. Evelyn says that "Some ash is so curiously cambled and veined, that skilful cabinet-makers prize it equally with ebony, and call it green ebony." It makes excellent fuel, burning even when newly cut, with very little smoke; and it is said to be the best of all woods for smoke-drying herrings. It makes excellent oars, and also blocks and pulleys. Few other trees become useful so soon, it being fit for walkingsticks at four or five years' growth; and for handles for spades and other implements, at nine or ten years' growth. An ash pole, Nicol observes, 3 in. in diameter, is as valuable and durable for any purpose to which it can be applied, as the timber of the largest tree. (*Plant. Cal.*, p. 77.) It is particularly valuable for hop-poles, hoops, crates, handles to baskets, rods for training plants, forming bowers, for light hurdles, and for wattling fences; and also for walkingsticks. In Staffordshire, in the neighbourhood of the potteries, the ash is cultivated to a great extent, and cut every five or six years for crate-wood, which is in great demand for forming crates to pack up the articles manufactured in the potteries. In Kent, and in various places in the neighbourhood of London, the most profitable application of the young ash is for walkingsticks, plant-rods, hoops, and hop-poles. For the latter purpose, coppice-woods are cut over every twelve or fourteen years, according to the nature of the soil; and, for the former purposes, every five or seven years. The ashes of the branches and shoots of this tree afford a very good potash; the bark is used for tanning nets and calfskins; the leaves, in some places, for feeding cattle in autumn, and in others in spring, and for adulterating tea. The leaves and shoots, eaten by cows, are said to give the milk and butter a rank taste; but this does not appear to have been considered a great evil by the Romans, as they recommended the leaves of the ash, next to the leaves of the elm, for fodder. In moist pastures, inter-

persed with, or surrounded by, numerous trees in hedgerows, the leaves, after dropping in the autumn, communicate a bitter taste to the water both in the ditches and ponds, and possibly, also, to the milk of cows; but this does not hold good more with respect to the ash than to other trees: indeed, the most objectionable is the oak, the leaves of which, in autumn, give a decidedly bitter taste both to water and milk. Our correspondent Mr. Sydney of Cowpen, near Morpeth, who lives in a country where the ash tree is more abundant than any other tree, says, "The statement made by several writers, that butter made from the milk of cows which have eaten ash leaves has a disagreeable taste, is certainly not founded in fact. Much excellent butter is made in this neighbourhood, on farms where it would be impossible to prevent the cows from feeding upon the leaves of the ash; and yet I have never met with a farmer's wife or dairy-woman, in the neighbourhood of Morpeth, who had ever heard of the supposed injury done to butter." The Arabian, as well as the Greek and Roman, physicians highly extol the medicinal properties of the seed, which the Latins named *lingua avis*, bird's tongue, from some supposed resemblance. It is said to be good for the dropsy, stone, and many other diseases. M. De Perthuis states that the sap of the ash is an excellent remedy for the gangrene. For this purpose, the sap is extracted from the leaves by maceration; and from the green wood by putting one end of a branch or truncheon of it into the fire, and gathering the sap, as it rises from the other end, with a spoon. A decoction of the bark, or of the leaves, has been used as a tonic; and an infusion of the leaves as an aperient. The ash keys, which have an aromatic, though rather bitter, flavour, were formerly gathered in a green state, and pickled with salt and vinegar, to be sent to table as a sauce, or, as Evelyn expresses it, "as a delicate salad." In Siberia, the keys are infused in the water used for drinking, to give it an agreeable flavour.

The Use of the Ash in Plantations has been objected to on account of the injury which it does to every thing that grows in its shade; but, though we admit that this, and its love of shelter, constitute a decided reason why it should not be planted in hedgerows, or where it is expected to make profit from plants growing under its shade, yet it affords no argument against planting it in masses, where the object is the production of timber or coppice-wood. As the tree, when standing singly, forms a most ornamental object on a lawn, and, though it may impede the growth of the grass, yet does not destroy it, there is no reason why the ash should not be admitted into pleasure-grounds, as well as the cedar, or any other dense evergreen, under which grass will not thrive. It has been observed, that female and hermaphrodite trees, from the quantity of seeds which they produce, never exhibit such a handsome clothing of foliage as the male trees; and hence, in some situations, where an ornamental ash tree is wanted, it may be desirable to make sure of a male by grafting.

The Ash, with reference to picturesque Beauty, is thus characterised by Gilpin:—"The ash generally carries its principal stem higher than the oak and rises in an easy flowing line; but its chief beauty consists in the lightness of its whole appearance. Its branches, at first, keep close to the trunk, and form acute angles with it; but, as they begin to lengthen, they generally take an easy sweep; and the looseness of the leaves corresponding with the lightness of the spray, the whole forms an elegant depending foliage. Nothing can have a better effect than an old ash hanging from the corner of a wood, and bringing off the heaviness of the other foliage with its loose pendent branches: and yet, in some soils, I have seen the ash lose much of its beauty in the decline of age. Its foliage becomes rare and meagre; and its branches, instead of hanging loosely, often start away in disagreeable forms. In short, the ash often loses that grandeur and beauty in old age which the generality of trees, and particularly the oak, preserve till a late period of their existence. The ash also, on another account, falls under the displeasure of the picturesque eye. Its leaf is much tenderer than that of

the oak, and sooner receives impression from the winds and frost. Instead of contributing its tint, therefore, in the wane of the year, among the many-coloured offspring of the woods, it shrinks from the blast, drops its leaf, and, in every scene where it predominates, leaves wide blanks of desolated boughs, amidst foliage yet fresh and verdant. Before its decay, we sometimes see its leaf tinged with a fine yellow, well contrasted with the neighbouring greens. But this is one of nature's casual beauties: much oftener, its leaf decays in a dark, muddy, unpleasing tint; and yet, sometimes, notwithstanding this early loss of its foliage, we see the ash, in a sheltered situation, when the rains have been abundant, and the season mild, retain its green (a light pleasant green) when the oak and the elm in its neighbourhood have put on their autumnal attire." (*For. Scen.*, p. 37.)

"It is in mountain scenery that the ash appears to peculiar advantage; waving its slender branches over some precipice which just affords it soil sufficient for its footing, or springing between crevices of rock; a happy emblem of the hardy spirit which will not be subdued by fortune's scantiness. It is likewise a lovely object by the side of some crystal stream, in which it views its elegant pendent foliage, bending, Narcissus-like, over its own charms." (*Strutt's Sylva*, 8vo edit., p. 79.)

"The beauty of the roots of the ash," Gilpin observes, "is of a picturesque nature. They are often finely veined, and will take a good polish. Dr. Plot, in his *Natural History of Oxfordshire* (chap. vi. § 80.), speaks of certain knotty excrescences in the ash, called the brusca and mollusca, which, when cut and polished, are very beautiful. He particularly mentions a dining-table made of the latter, which represents the exact figure of a fish. With regard to the exact figure of animals and other objects, which we meet with both in stone and wood, I cannot say I should value them much as objects of beauty. They may be whimsical and curious; but, in my opinion, the roots and veins of wood and stone are much more beautiful when they are wreathed in different fantastic forms, than when they seem to aim at any exact figures. In the former case, they leave the imagination at liberty to play among them, which is always a pleasing exercise to it; in the latter, they are, at best, awkward and unnatural likenesses, which often disgust the picturesque eye, and always please it less than following its own fancy, and picking out resemblances of its own." (*For. Scen.*, p. 38.)

The wreathed Fascia in the Ash Tree is likewise of the picturesque kind, and consists of a sort of excrescence, which is sometimes found on a leading branch, and is called by this name. "The fasciated branch is twisted and curled into a very beautiful form; which form it probably takes, as Dr. Plot supposes, from too quick an ascent of the sap (see *Nat. Hist. of Oxf.*, ch. vi. § 82.); or, as other naturalists imagine, from the puncture of some insect in the tender twig, which diverts the sap from its usual channel, and makes the branch monstrous. The wreathed fascia is sometimes found in other wood, in the willow particularly, and in the holly; but most commonly it is an excrescence of the ash. I have a fasciated branch of ash, found in the woods of Beaulieu, in the New Forest, which is most elegantly twisted in the form of a crosier; and I have seen a holly, also, twisted like a ram's horn. We have this appearance sometimes in asparagus." (*Id.*, p. 39.)

The Spray of the Ash (*fig.* 1046.) "is very different from that of the oak, the elm, or the beech. As the boughs of the ash are less complex than those of the oak, so is its spray. Instead of the thick intermingled bushiness which the spray of the oak exhibits, that of the ash is much more simple, running in a kind of irregular parallels. The main stem holds its course, forming at the same time a beautiful sweep; but the spray does not divide, like that of the oak, from the extremity of the last year's shoot, but springs from the sides of it. Two shoots spring out, opposite each other; and each pair in a contrary direction. Rarely, however, do both the shoots of either side come to maturity: one of them is commonly lost as the tree increases, or, at least, makes no appearance in comparison with the

other, which takes the lead. So that, notwithstanding this natural regularity of growth (so injurious to the picturesque beauty of the spruce fir, and some other trees), the ash never contracts the least disgusting formality from it. It may even receive great picturesque beauty; for sometimes the whole branch is lost as far as one of the lateral shoots; and this occasions a kind of rectangular junction, which forms a beautiful contrast with the other spray, and displays an elegant mode of hanging to the branches of the tree. This points out another difference between the spray of the

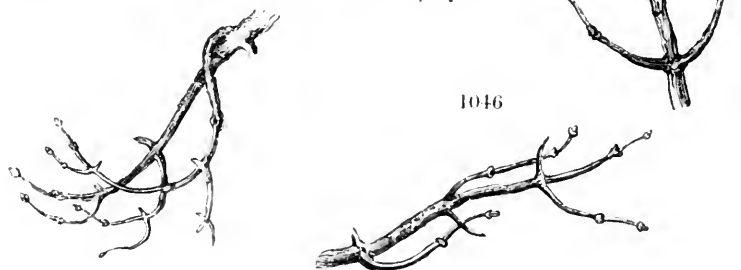

oak and that of the ash. The spray of the oak seldom shoots from the under sides of the branches; and it is this chiefly which keeps the branches in a horizontal form. But the spray of the ash, often breaking out on the under side of the branch, forms very elegant pendent boughs." (*Id.*, p. 112.)

Disseminating Properties of the Ash. The ash, like the sycamore, from the wedge-like shape of its keys, or seeds, is liable to fix itself in the crevices of rocks, ruins, walls, and even in the clefts of old trees. On the piers of the entrance to Blenheim Park from Woodstock there were, in 1834, a sycamore established on one pier, and an ash on the other, each about 5 ft. high. (See *Gard. Mag.*, vol. x. p. 99.) On the ruins of Sweetheart Abbey, in Dumfriesshire, there is a large tree of the common sycamore on the top of a wall, which, in 1806, when we last saw it, had sent down a fibrous root on the outside of the wall, completely exposed to the air, for the height of 10 ft. or 12 ft., till it reached the ground. This fibre soon afterwards acquired considerable thickness, and now constitutes, as we are informed, the main stem of the tree. A similar circumstance took place with a weeping willow, in the Botanic Garden of Carlsruhe, which will be hereafter mentioned; and the same thing happens not unfrequently with the oak. Mr. Gilpin quotes the following instance from Dr. Plot, of an ash establishing itself on, and finally destroying, a willow: — "An ash key rooting itself on a decayed willow, and finding, as it increased, a deficiency of nourishment in the mother plant, began to insinuate its fibres, by degrees, through the trunk of the willow into the earth. There receiving an additional recruit, it began to thrive, and expand itself to such a size, that it burst the willow in pieces which fell away from it on every side; and, what was before the root of the ash, being now exposed to the air, became the solid trunk of a vigorous tree." (*For. Scen.*, p. 40.)

Historical, poetical, and mythological Allusions. The ash is mentioned both by Hesiod and Homer; the latter of whom not only speaks of the ashen spear of Achilles, but informs us that it was by an ashen spear that he was slain. In the heathen mythology, Cupid is said to have made his arrows first of ash wood, though they were afterwards formed of eypress. The Scandinavians also introduce this tree into their mythology. It is stated in the *Edda*, that the court of the gods is held under a mighty ash, the summit of which reaches the heavens, the branches overshadow the whole surface of the earth, and the roots penetrate to the infernal regions. An eagle rests on its summit to

observe every thing that passes; to whom a squirrel constantly ascends and descends, to report those things that the exalted bird may have neglected to notice. Serpents are twined round the trunk; and from the roots there spring two limpid fountains, in one of which wisdom lies concealed, and in the other a knowledge of the things to come. Three virgins constantly attend on this tree, to sprinkle its leaves with water from the magic fountains; and this water, falling on the earth in the shape of dew, produces honey. Man, according to the *Edda*, was formed from the wood of this tree. Ancient writers of all nations state that the serpent entertains an extraordinary respect for the ash. Pliny says that, if a serpent be placed near a fire, and both surrounded by ashen twigs, the serpent will sooner run into the fire than pass over the pieces of ash; and Dioscorides asserts that the juice of ash leaves, mixed with wine, is a cure for the bite of serpents. Evelyn mentions that, in some parts of England, the country people believe that, if they split young ash trees, and make ruptured children pass through the chasm, it will cure them; and the Rev. W. T. Bree relates an instance, within his personal knowledge, of this extraordinary superstition having been lately practised in Warwickshire. (See *Mag. Nat. Hist.*, vol. vii. p. 557.) Another superstition is that of boring a hole in an ash tree, and imprisoning a shrew mouse in it: a few strokes with a branch of a tree thus prepared is supposed to cure lameness and cramps in cattle, all of which the poor mouse is accused of having occasioned. (*Ibid.*, p. 564.) There is also a proverb in the midland counties, that, if there are no keys on the ash trees, there will be no king within the twelvemonth, in allusion to the ash tree being never totally destitute of keys. Lightfoot says that, in many parts of the Highlands of Scotland, at the birth of a child, the nurse or midwife puts one end of a green stick of this tree into the fire, and, while it is burning, gathering in a spoon the sap, or juice, which oozes out at the other end, administers this as the first spoonful of food to the newly born baby. Many poets have mentioned the ash, and the following passages allude to the situations in which it is said most to thrive:—

“The ash asks not a depth of fruitful mould,
But, like frugality, on little means
It thrives; and high o'er creviced ruins spreads
Its ample shade, or on the naked rock,
That nods in air, with graceful limbs depends.”

BIDLAKE'S *Year*.

———“Here amid the brook,
Grey as the stone to which it clung, half root,
Half trunk, the young ash rises from the rock;
And there the parent lifts its lofty head,
And spreads its graceful boughs.”

SOUTHEY'S *Roderick*.

———“Nature seems t'ordain
The rocky cliff for the wild ash's reign.”

DRYDEN'S *Virgil*.

Soil and Situation. The ash, it is said by Boucher, will grow in very barren soil, and in the bleakest and most exposed situations; but, though it will grow under such circumstances, it is certain that it will not attain a timber-like size there. According to Lightfoot, it will stand the sea breeze; and, according to Woodward, in Withering's *Botany*, if planted by ditch sides, or in low boggy situations, the roots act as under-drains, and render the ground about them firm and hard. Mr. Ley, in his *Land Steward*, says that no land is more proper for ash than swampy boggy soils, that cannot be drained so as to grow grass or corn. On this remark, Mr. Mitchell (*Dendrologia*, p. 41.) observes, that such places are good for growing ash poles, to cut down at from 12 to 20 years old; but that timber grown in such situations soon gets knotty and diseased. The preceding opinions we regard as in a great measure erroneous. Sang, whom we consider as the very first modern authority in all matters respecting the hardier forest trees, observes, of the ash, that “it is found in the highest perfection on dry loamy soils. On such it spontaneously grows. In moist, but not wet soils, it grows fast, but soon sickens. It will grow freely on most kinds of soils, if the situation

be tolerably good, except on retentive clays or tills. In wet soils, it soon sits up (ceases to increase either in girth or height), languishes, and dies. In rich lands its wood is short and brittle; in sandy soils it is tough and reedy; qualities which, for several purposes, very much enhance its value. In loam, mixed with decomposed rock, at the bottom of a mountain (as at Alva, in Stirlingshire, and Ochertyre, in Perthshire), the ash arrives at a great size. (*Sang's edit. of Nicol's Planter's Calendar*, p. 51.) Dr. Walker, a close observer of nature, and an ardent lover of trees, says, "The ash should be planted on dry banks, in glens and gullies, in places encumbered with large loose stones, and in all rocky places, wherever there is shelter; but the largest trees," he says, "will always be found where they have running water within reach of their roots. There is no situation," he adds, "too high, or too cold, for the ash, provided it has shelter; but without shelter it never makes a considerable tree at a great height, even though standing in a good soil." (*Highlands of Scotland, &c.*, vol. ii. p. 235.) Shelter, and a dry good soil within reach of water, are, then, essential for the prosperity of the ash. The most proper station for the ash, according to Nicol, is the forest or the grove. Marshall recommends the ash to be planted alternately with the oak; because, as the ash draws its nourishment from the surface, and the oak from the subsoil, the ground would thus be fully and profitably occupied. As the value of the timber depends on the closeness and cleanness of the grain, there can be no doubt whatever that the ash ought to be planted either along with its own species, or with other trees, so as to draw it up with a straight clean stem.

Propagation and Culture. The species is always propagated by seed, and the varieties by grafting or budding on the species. The seeds (which are included in what are commonly called keys, but botanically samaras,) are generally ripe in October; when they should be gathered, and taken to the rotting-ground, where they should be mixed with light sandy earth, and laid in a heap of a flat form, not more than 10 in. thick, in order to prevent them from heating. Here they should be turned over several times in the course of the winter; and in February they may be removed, freed from the sand by sifting, and sown in beds in any middling soil. The richness or quality of the soil, Sang observes, is of little consequence; but it should be well broken by the rake, and the situation should be open, to prevent the plants from being drawn up too slender. The seeds may be deposited at the distance of half an inch every way, and covered a quarter of an inch with soil. The plants may be taken up at the end of the year, and planted in nursery lines; and at the end of the second year they may be removed to where they are finally to remain. In timber or copse-wood plantations, no management peculiar to this tree requires to be described.

Accidents, Diseases, Insects, &c. When the ash stands alone, its far extended branches are liable to be broken off by high winds; but, except on unsuitable soils, it is not subject to the canker, or other diseases. Being late in leafing, it is by no means so liable to the attacks of insects as the species of *Rosaceæ*, which come early into leaf; at least, this is the case in Britain: but, in France, it is objected to the ash, that the leaves are liable to be destroyed by the Spanish flies; and also by bees, ants, and birds, in the middle of summer. "If nature had produced the ash for no other purpose than for the embellishment of forests," says the writer of the article *Fráxinus* in the *Nouveau Du Hamel*, "we might almost say that she had failed in her end, or had opposed herself to her own views, in destining the leaves of that tree to be the food of an insect, *Cántharis vesicatòria* Auct. (*fig.* 1047.), a beetle of a beautiful golden green, with black antennæ, which devours them with avidity. The ash tree is no sooner covered with leaves, than these are attacked by such a number of cantharides, or Spanish

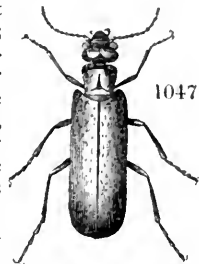

flies, that the trees, during the remainder of the summer, have a dismal appearance; and, though the insect which devours the leaves may please the eye by its elegant form, and its colours of green and gold, yet it spreads abroad a smell which is so disagreeable, that it causes the common ash to be excluded from our forests, where the flowering ash, and some of the American species, are alone introduced." (*N. Du Ham.*, vol. iv. p. 58.) M. Piroille, in one of the early volumes of the *Bon Jardinier*, mentions that, even when the cantharides are dead on the trees, they become dried to a powder, which it is difficult to pass the trees without inhaling. The particles of this powder, being parts of those flies that cause the blistering of the skin when a blister plaster is applied, are, of course, dangerous to persons who inhale them; and, on this account, ash trees are never planted near villages in France. Giles Munby, Esq., in a paper in the *Magazine of Natural History*, vol. ix. p. 119., states that he saw an ash tree overhanging the road near Dijon, so crowded with the *Cantharis vesicatoria*, that the excrement of the insects literally blackened the ground. On passing underneath the tree, he felt his face as if bitten by gnats, and smelt a most disagreeable sickening smell, which extends, he says, 20 or 30 yards from the tree, according to the direction of the wind. The insects are collected, and sold at 6s. per pound when dried. Fortunately, these insects are not numerous in England. In France they appear about midsummer, more particularly on the ash and lilac, on the leaves of which they feed. In Russia, according to Pallas, the cantharides abound on the *Lonicera tatarica*, and are collected from that plant in great quantities for the apothecaries. The *Dorcus parallelopipedus* (fig. 635. in p. 886.) and the *Sinodendron cylindricum* (fig. 1048.; in which *a* is the female, and *b* the male), especially in the larva state, live in the decayed wood of the ash, as well as in that of most other trees. (See an interesting article on this subject by the Rev. W. T. Bree, in the *Magazine of Natural History*, vol. vi. p. 327.) It has been observed, that, when woodpeckers are seen tapping those trees, they ought to be cut down, as these birds never attempt to make holes in this tree till it is in a state of decay. The timber of the ash, Michaux observes, is subject to be worm-eaten, and for that reason it is rarely employed in building houses.



1048



Statistics. Recorded Ash Trees in England. Dr. Plot mentions an ash, with a trunk 8 ft. in diameter, which was valued at 30l. Evelyn speaks of divers trees, "lately sold in Essex, in length 152 ft." Moses Cook mentions one at Cashibury, with a clean stem 58 ft. high, and 2 ft. in diameter, half way from the ground. The great ash at Woburn Abbey, stands in a row of those trees, in the park, about a quarter of a mile from the mansion; and, as Strutt observes, "is an extraordinary specimen of the size which this tree will attain in favourable situations. It is 90 ft. high from the ground to the top of its branches; and the stem alone is 28 ft. It is 23 ft. 6 in. in circumference on the ground, 20 ft. at 1 ft., and 15 ft. 3 in. at 3 ft. from the ground. The circumference of its branches is 113 ft. in diameter; and the measurable timber in the body of the tree is 343 ft.; and in the arms and branches, one of which is 9 ft. in circumference, 529 ft.; making altogether 872 ft. of timber." (*Strutt's Sylva*, 8vo ed., p. 79.) (See Statistics of existing Trees.) Mitchel says, there are ash trees in Blenheim Park, Oxfordshire, and Hagley Park, Worcestershire, 10' ft. high; at Fawsley, in North Hampshire, from 80 ft. to 100 ft. high, and 14 ft. in circumference. In Moor Park, Hertfordshire, 100 ft. high, and 12 ft. in circumference; and at Longleat, in Wiltshire, there are many trees with clear stems of 50 ft., and from 9 ft. to 12 ft. in circumference. In Whitaker's *History of Craven*, published in 1805, an ash is mentioned as having been lately felled at the House of Broughton, in Craven, which contained 500 cubic ft. of timber, and sold for 45l. (*Whit. Craven*, p. 80.) A curious ash, growing on the top of a wall at Saltwood Castle, near Hythe, is described in *Gard. Mag.*, vol. xii.

Recorded Ash Trees in Scotland. The great ash at Carnoch, in Stirlingshire, supposed to be the largest in Scotland, which, says Sir Thomas Dick Lauder, "we have had an opportunity of seeing and admiring," measured, in 1825, according to Strutt's *Sylva* (8vo ed., p. 150.), 90 ft. high, 31 ft. in girth at the ground; and, at the height of 10 ft., it divides into three large limbs, each of which is 10 ft. in circumference. The solid contents of the tree are 679 cubic feet. It was planted about the year 1596, by Sir Thomas Nicolson, the lord advocate of James VI. There is a beautiful engraving of it in Strutt's *Sylva Britannica*. Mr. Strutt's drawing of this tree was made in 1825, at which time, he says, it was in "full vigour and beauty, combining airy grace in the lightness of its foliage and the playful ramifications of its smaller branches, with solidity and strength in its silvery stem and principal arms." (*Sylva*, p. 151.) This tree, Sir Michael Shaw Stewart informs us, is now (Aug. 20. 1836) much in the same state in which it was when the drawing was taken by Mr. Strutt. At Earls-mill, near Darnawa Castle, the seat of the Earl of Moray, in Morayshire, there is an ash which girths above 17 ft., at 3 ft. from the ground. "There is a small hole at the root of it, large enough to admit one man at a time; and, on creeping into it, the cavity is found to be so great as to allow three people to stand upright in it at the same moment. The interior has been in this state during the memory of the oldest persons; and yet until an accident in July, 1824, nothing could be more grand than its head, which was formed of three enormous limbs, variously sub-

1049

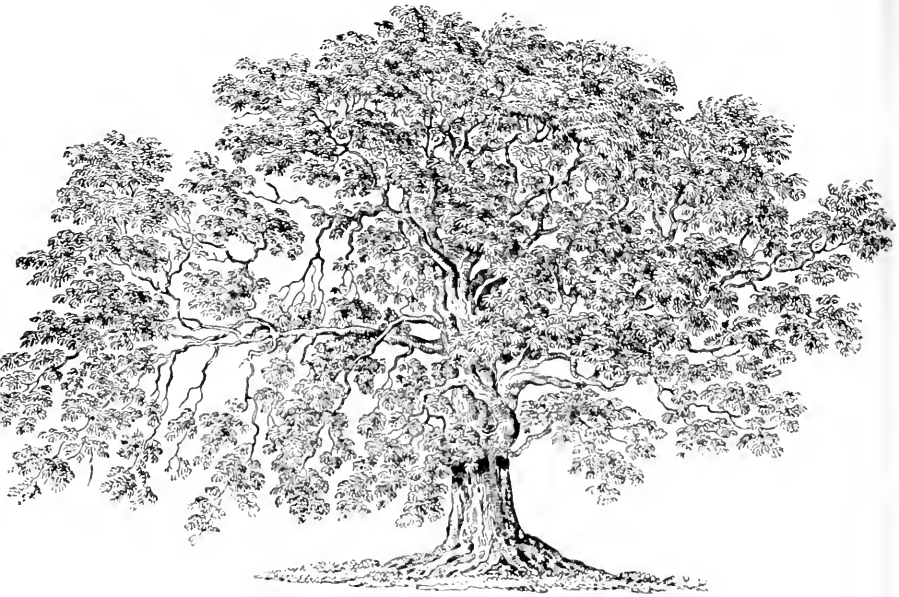

divided in bold sweeping lines. The foliage, though appearing late, was, and, indeed, still is, abundant and beautiful. But, some days before the 23d of July, 1824, its great southern limb was broken down by a high wind; and, although the ruin thus created was sufficiently deplorable, yet it was strikingly sublime." *Lauder's Gilpin*, vol. i. p. 82 and 83.) A drawing of this tree, made by Mr. J. Steven, drawing-master, Elgin, has been kindly sent to us by William M'Leod, Esq., from which fig. 1049 is an engraving to a scale of 1 in. to 12 ft. The branch broken off was about 30 ft. long. The cavity in the interior of the trunk is of a regular cone-like shape, terminating in a point, and is 11 ft. in diameter at the bottom, and 6 ft. high. An ash tree in the churchyard of Kilmalie, in Lochaber, the parish church of the Lochiel family, burnt down during the troubles in 1746, was long considered as the largest and most remarkable tree in Scotland. Its remains were measured in October, 1764, and, at the ground, the circumference was no less than 58 ft. (*Walker's Essays*, p. 17.) This tree stood on a deep rich soil, only about 30 ft. above the level of the sea, in Lochiel, with a small rivulet running within a few paces of it. (*Sang.*) An ash tree near Bonhill House, in Dumbartonshire, which is surrounded with a sloping bank of earth, about 3 ft. in height, measured in circumference, in September, 1784, at 4 ft. above the general surface of the ground, 34 ft. 1 in. The proprietor has fitted up a room in the inside of it, with benches around, and glass windows. The diameter of the room is 8 ft. 5 in., and its roof is near 11 ft. in height. Sir T. D. Lauder informs us that 18 people can dine in this tree; that, though decayed at the heart, it lives in the bark, and forms a great deal of new wood; and that the trunk, which is a vast mass, is covered with fresh vigorous branches. *Lauder's Gilpin*, vol. i. p. 265.) A few yards from Cessford Castle, in Roxburghshire, there is a venerable ash tree, which measures in circumference, at the base, 27 ft. 8 in. An ash near the church of Logierait, in Perthshire, measured, at 1 ft. from the ground, in 1770, 16 ft. The same tree, measured in March, 1812, was found to be, at breast high, 21 ft. 6 in. in circumference. (*Sang.*) An ash at Newbottle, in Mid-Lothian, standing east from the house, near the river, in the month of July, 1789, measured in circumference 11 ft. 4 in. (*Walker's Essays*, p. 12.) An ash in the Island of Loch Leven, in Fifeshire, in September, 1796, measured in circumference, at 4 ft. from the ground, 12 ft. An ash at Lord Morton's, near Aberdeen, in Fifeshire, measured in March, 1812, extended in length of bole 50 ft.; and in girt, at 4 ft. high, 10 ft. 3 in. An ash tree at Wemyss Castle, in Fifeshire, growing about 100 yards from the door of the Castle, measured, on the 15th of March, 1812, 35 ft. bole; and in circumference, at 4 ft. from the ground, 15 ft. 3 in. At Biel, in East Lothian, near the East Bridge, an aged ash was in girt, at breast height, July 28, 1812, 11 ft. 4 in. in circumference. An ash at Whittinghame, in East Lothian, was in girt, in 1813, 12 ft. 9 in. (*Sang's Nicol*, p. 547.) An ash at Yair, in Selkirkshire, measured, at the surface of the ground, 12 ft. 9 in. in circumference. (*Selkirkshire Rep.*, p. 284.) The Glamis ash tree at Castle Huntley, in Perthshire, measured in circumference, at the ground, 27 ft.; and, at a yard high, 17 ft. (*Stat. Account Scot.*, vol. xix. p. 467.) At the river of Blackburn, in the parish of Castle-town, in Roxburghshire, the trunk of an old ash measured in circumference 18 ft. *Ibid.*, vol. xvi. p. 70.) An ash at Midstrath, in the parish of Bins, measured, at the ground, 20 ft. (*Ibid.*, vol. ix. p. 129.) An ash near Deskford, in the county of Banff, called St. John's Tree, measures in girt 24 ft. 5½ in. *Ibid.*, vol. viii. p. 263.)

Recorded Ash Trees in Ireland. Arthur Young, in his *Irish Tour*, mentions ash trees of 70 ft. and 80 ft. in height, which were only of 35 years' growth. The stem of an ash on the banks of the Avonmore was about 14 ft. round, and carried nearly the same dimensions for 18 ft. in height. An ash at Dunganston was 12 ft. round, with a clear trunk of 30 ft., and arms extending nearly 90 ft. on each

side. At Donirey, near Clare Castle, in the county of Galway, was an ash that, at 4 ft. from the ground, measured 42 ft. in circumference, and at 6 ft. from the ground it measured 33 ft. The trunk had long been quite hollow, a little school having been kept in it. Near Kennity Church, in King's County, is an ash with a trunk 21 ft. 10 in. round, and 17 ft. high, before any branches proceed from it. The branches are of enormous size. When a funeral of the lower class passes by this tree, they lay the corpse down for a few minutes, say a prayer, and then throw a stone to increase the heap, which has been for many years accumulating round the root.

Existing Ash Trees, as indicated by the Return Papers sent to the Arboretum Britannicum.

Fraxinus excelsior in the Environs of London. At Mount Grove, Hampstead, there is a tree 85 ft. high, the diameter of the trunk 3 ft. 10 in., and that of the head 75 ft. There are large common ash trees at Fulliam, where the tree attains the height of 30 ft. in 10 years, and 70 ft. in 60 years.

Fraxinus excelsior South of London. In Devonshire, at Killerton, 150 years planted, and 78 ft. high, the diameter of the trunk 4 ft. 3 in., and that of the head 65 ft., in loam on clay. In Dorsetshire, in Melbury Park, 200 years planted, and 90 ft. high, diameter of the trunk 5 ft. 1 in., and of the head 66 ft., in sandy loam on loose gravel. In Hampshire, at Alresford, 81 years planted, and 64 ft. high, the diameter of the trunk 3 ft. 1 in., and of the head 69 ft., in loam on gravel, in an exposed situation. In Kent, at Cobham Hall, 120 ft. high, with a trunk 6 ft. 8 in. in diameter, straight, and without a branch for a great height. In Somersetshire, at Nettlecombe, 90 years planted, and 60 ft. high, the diameter of the trunk 3 ft. 7 in., and of the head 12 ft. 6 in. In Wiltshire, at Wardour Castle, 60 years planted, and 70 ft. high, the diameter of the trunk 4 ft. 6 in., and of the head 48 ft.

Fraxinus excelsior North of London. In Bedfordshire, at Woburn Abbey, the large ash mentioned above, which, on August 10. 1836, His Grace the Duke of Bedford informs us, was exactly in the same state in which the drawing was taken by Mr. Strutt. In Denbighshire, at Llanbede Hall, 45 years planted, and 65 ft. high; and 50 years planted, and 75 ft. high. In Derbyshire, at St. Helen's, a tree with a trunk 6 ft. in diameter, at 1 ft. from the ground, and 4 ft. 10 in. in diameter, at 18 ft. from the ground. In Gloucestershire, at Doddington, 85 ft. high, the diameter of the trunk 7 ft., and of the head 93 ft., in deep sand on a dry subsoil. In Herefordshire, at Moocas Court, an ash growing on the edge of a dingle, with immensely large roots, running on the surface of the ground for 50 ft. and upwards down the steep side of the dingle, has a clear trunk of 30 ft., which, at 15 ft. from the ground, is 7 ft. in diameter; the contents of this trunk, and of 3 large limbs, make 1003 ft. In Leicestershire, at Donington Park, trees from 80 to 100 years planted are from 90 ft. to 100 ft. high, with trunks 6 ft. in diameter; at Whatton House, there is a very old tree, 50 ft. high, with a trunk 9½ ft. in diameter, and the diameter of the head 88 ft. In Northamptonshire, at Cranferd, near Kettering, on the estate of the Rev. Sir George Robinson, a superb tree, with a fine branchy head. In Northumberland, at Woolsington, 100 years planted, and 70 ft. high; at Hartburn, 173 years planted, and 60 ft. high, the diameter of the trunk 5 ft. 9 in., and of the head 80 ft.; near Morpeth, at Cowpen, the weeping trees mentioned p. 1214. as 60 ft. high. In Oxfordshire, in Tew Park, a tree is 98 ft. high, the diameter of the trunk 6 ft. 2 in., and of the head 97 ft. On the same estates there are ash trees, which in 15 years have attained the height of 40 ft., with trunks 1 ft. 4 in. in diam. at the ground, and 10 in. in diam. at 6 ft. in height. In Pembrokeshire, at Golden Grove, 70 years planted, and 90 ft. high. In Suffolk, at Finborough Hall, 70 years planted, and 70 ft. high. In Warwickshire, at Marstoke Castle, near Coleshill, a tree with a clear trunk upwards of 50 ft. before it branches out, presenting nearly the same diameter throughout, a remarkably fine specimen.

Fraxinus excelsior in the Environs of Edinburgh. At Woodhouselee, 80 ft. high; at Hopetoun House, 70 ft. high.

Fraxinus excelsior South of Edinburgh. In Ayrshire, at Kilkerran, 30 years planted, and 60 ft. high, the diameter of the trunk 9 ft., and of the head 75 ft.; at Kilhenzie, 75 ft. high, the diameter of the trunk 7 ft., and of the head 80 ft. In Kircudbrightshire, at St. Mary's Isle, 80 ft. high, the diameter of the trunk 4½ ft., and of the head 48 ft.

Fraxinus excelsior North of Edinburgh. In Banffshire, at Gordon Castle, 82 ft. high, the diameter of the trunk 5 ft., and of the head 60 ft. In Fifeshire, at Dysart House, 90 ft. high. In Forfarshire, at Monboddio, 140 years planted, and 70 ft. high, the diameter of the trunk 3 ft. 4 in.; at Benvie, on the estate of Gray, an ash containing 465 cubic feet of timber, exclusive of the branches that are under 1 ft. in circumference; at Courtachy Castle, 102 years planted, and 75 ft. high. In Perthshire, at Taymouth, 160 years planted, and 60 ft. high; and 200 years planted, and 50 ft. high. In Ross-shire, at Bralian Castle, 85 ft. high, the diameter of the trunk 5 ft., and of the space covered by the branches 93 ft. In Sutherlandshire, at Dunrobin Castle, 180 years planted, and 76 ft. high, the diameter of the trunk 2 ft. 5 in., and of the head 44 ft.; another tree, 108 years planted, and 57 ft. high, the diameter of the trunk 3 ft. 2 in., and of the head 162 ft. In Stirlingshire, at Callander Park, 70 ft. high, the diameter of the trunk 4 ft., and of the head 70 ft., on gravel; in Bannockburn Wood, 70 ft. high, the diameter of the trunk 5 ft., and of the head 78 ft.; at Blair Drummond, 180 years planted, and 82 ft. high, the diameter of the trunk 4 ft. 4 in., and of the head 56 ft.; at Sanchie, 90 years planted, and 116 ft. high, the diameter of the trunk 2 ft. 8 in., and of the head 35 ft.

Fraxinus excelsior in Ireland. At Cypress Grove, 50 ft. high, the diameter of the trunk 2 ft., and of the head 70 ft. In Munster, at Castle Freke, near Cork, 65 ft. high, the diameter of the trunk 5 ft., and of the head 35 ft., in reclaimed bog on clay. In Leinster, at Kilkenny, 60 years planted, and 65 ft. high. In Down, at Moira, 60 ft. high, the diameter of the trunk 6 ft., and of the head 90 ft. At Ballyleady, 60 years planted, and 56 ft. high. In Galway, at Cool, 57 ft. high. In Fermanagh, at Enniskillen, an old tree, with a trunk 12 ft. in diameter at 3 ft. from the ground, on transition limestone. In Longford, at Pakerham, 85 years planted, with a trunk 2 ft. 5 in. in diameter, and clear of branches to the height of 13 ft.: it stands in drained bog, which is from 18 ft. to 20 ft. in depth. In Tyrone, at Baron's Court, 80 years planted, and 50 ft. high. In Sligo, at Mackree Castle, 95 ft. high, the diameter of the trunk 4 ft. 10 in., and of the head 54 ft. In Limerick, at Adare, is a tree of unknown age, under which the family treasure of the Earl of Dunraven's ancestors lay concealed during the troubles of 1688.

Fraxinus excelsior in Foreign Countries. In France, in Paris, at the Jardin des Plantes, 60 years planted, and 56 ft. high; at Nantes, in the nursery of M. De Nerrières, 80 years planted, and 60 ft. high. In Prussia, near Berlin, at Sans Souci, 40 years planted, and 50 ft. high. In Sweden, in the Botanic Garden at Lund, 70 ft. high. In Italy, at Monza, 40 years planted, and 60 ft. high. In Russia, in the Government Garden at Odessa, 11 years planted, and 23 ft. high.

Statistics of Fraxinus excelsior pëndula. In the environs of London there are many fine specimens of this tree, generally from 15 ft. to 25 ft. high, with branches drooping to the ground, and covering a space of from 20 ft. to 30 ft. in diameter, or upwards. One of the largest is in the Leyton Nursery. In the gardens of some taverns and public-houses there are also large specimens; one in front of the

Vernon Arms, in Pleasant Row, Pentonville, has the branches trained on horizontal trellises, at the height of about 7 ft. from the ground, over 28 seats, and 14 tables, covering a space 36 ft. long by 21 ft. wide. (*Gard. Mag.*, vol. x. p. 385.) At York House, Twickenham, there is a weeping ash, which has been 50 years planted, and is 15 ft. high; the diameter of the trunk is 12 in., and of the head 21 ft. In Dorsetshire, at Melbury Park, there is a tree, 50 years planted, and 22 ft. high, the trunk 1 ft. 1 in. in diameter, and the head 28 ft. In Somersetshire, at Hinton House, there is a tree, 20 years planted, which is 19 ft. high, the diameter of the trunk 1 ft., and of the head 25 ft. In Wiltshire, at Bowood, a weeping ash, 35 years planted, is 20 ft. high, with the diameter of the head 30 ft. In Hertfordshire, at Cheshunt, a tree 22 ft. high has a head 24 ft. in diameter. In Derbyshire, at Chatsworth, there is a weeping ash of large size, which the Duke of Devonshire had transplanted from the nursery of Messrs. Wilson, near Derby. The tree, according to the newspapers, was 50 years old when it was removed, and, including the earth about its roots weighed nearly 8 tons. (See *Gard. Mag.*, vol. x. p. 386.) In Ireland, in the environs of Dublin, there are several good specimens, the best of which seems to be in the Glasnevin Botanic Garden, which, after being 35 years planted, is 35 ft. high, with a head 13 ft. in diameter.

Commercial Statistics. Plants, in the neighbourhood of London, are, 2 years' seedlings, 3s. per 1000; transplanted plants, 1 ft. or more in height, 10s. per 1000; 2 ft. high, 20s.; and 3 ft. high, 40s.: and the varieties are, in general, from 1s. 6d. to 2s. 6d. each. At Bollwyller, the varieties of the common ash are from 1 franc to 1 franc and 5 cents each; and at New York they are 50 cents each.

‡ 2. *F. (E.) HETEROPHYLLA Vahl.* The various-leaved Ash.

Identification. Vahl Enum., l. p. 53; Don's Mill., 4. p. 54.

Synonymes. *F. simplicifolia Willd. Sp.*, 4. p. 1028.; *Lodd. Cat.*, ed. 1836, *Berl. Baumz.*, p. 121 t. 3. f. 3.; *Smith Eng. Bot.*, t. 2476.; *F. monophylla Desf. Arb.*, 1. p. 102.; *F. simplicifolia Hort.*; *F. excelsior* β *diversifolia Ait.*; *F. excelsior* var. *t. Lam. Dict.*, 2. p. 554.; *F. excelsior* β *heterophylla Dec.*; *F. integrifolia* and *diversifolia Hort.*

Engravings. *Berl. Baum.*, p. 121. t. 3. f. 3.; *Eng. Bot.*, t. 2476.; our *fig.* 1050.; and the plate of this tree in our last Volume.

Distinctive Char., &c. Leaves simple or trifoliate, dentately serrated. Samara oblong-lanceolate, 1 in. long, obtuse and emarginate at the apex. Leaves usually simple, but sometimes with 3 or 5 leaflets, 3—4 in. long, ovate, subcordate, or acuminate at the base and apex. Branches dotted. Buds black. Perhaps only a variety of *F. excelsior*. (*Don's Mill.*, iv. p. 54.) A tree, from 30 ft. to 40 ft. high, flowering in April and May. It is a native of Europe; in England, in woods. There is a tree of this variety at Syon, 61 ft. high; one in the Edinburgh Botanic Garden, 34 ft. high; and one in Higgins's Nursery, Tipperary, which, 25 years planted, is 40 ft. high. Some botanists consider this kind of ash as a species; but Sir Thomas Dick Lauder states that Mr. McNab, of the Edinburgh Botanic Garden, sowed seeds produced by the tree in that garden, supposed to have been originally planted by Sutherland, and found that the plants had pinnated leaves; and Mr. Sinning, garden inspector of Poppilsdorf, near Bonn, sowed seeds of the common ash, which he gathered in a distant forest, many of which came up with simple leaves. Nearly 1000 of these plants were transplanted, and left to become trees; when they were about 8 ft. high, above 20 of them were observed to have simple leaves, and almost as many to have only 3 leaflets; though occasionally they showed a greater number. (*Allgemeine Garten Zeitung*, vol. iii. p. 6.) It is curious to observe the number of different names which have been applied to this variety of ash, by different botanists; and instructive to remark that the majority of them have considered it a distinct species. When such a very obviously distinct variety as this has received from botanists so many names, what may we not expect in the case of obscure varieties?



1050

Varieties.

☞ *F. (c.) h. 2 variegata* (fig. 1051.), the variegated various-leaved Ash, was discovered, in 1830, in the grounds of Captain Moore of Eglantine, near Hillsborough, in the county of Down, in Ireland. The variegation appeared in summer, on the point of one of the shoots of a tree of 15 years' growth; and Captain Moore marked it, and had the portion of shoot which showed the variegated leaves taken off, and grafted the following spring. The parent tree has never since shown the slightest tendency to variegation, but the grafted plants continue true. The habit of this kind of ash, we are informed, is much more that of a shrub than of a tree; and a number of plants of it have been propagated by Mr. Davis of the Ogle's Grove Nursery, who sells them at one guinea each. It is also in the Tooting Nursery. The circumstance of the parent plant having never shown any symptoms of variegations since 1830, while all the scions taken from the variegated shoot have continued variegated, shows the great importance of taking advantage of every sport, or deviation from the usual form in trees, when the object is to increase the number of varieties.

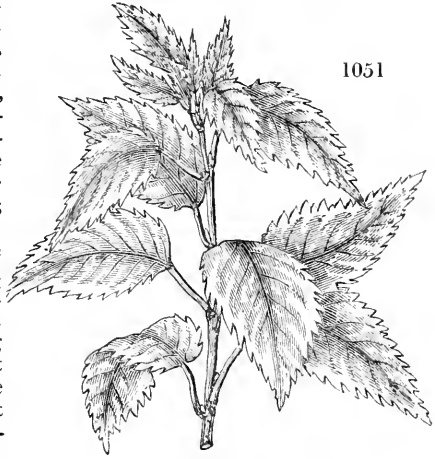

☞ 3. *F. (E.) ANGUSTIFOLIA* Bauh. The narrow-leaved Ash.

Identification. Bauh. Hist., 1. pt. 2. p. 177.; Vahl Enum., 1. p. 52.; Willd. Sp., 4. p. 1100.; Don's Mill., 4. p. 55.

Synonymic. *F. salicifolia* Hort.

Spec. Char., &c. Leaflets sessile, lanceolate, remotely denticulated, in 3—4 pairs, from $1\frac{1}{2}$ in. to 2 in. long, lanceolate. Samaras entire at the apex and acute, obtuse at the base. Branchlets green, dotted with white. Buds brown. Peduncles below the leaves, solitary, 2 in. long. Flowers naked. (*Don's Mill.*, adapted, iv. p. 55.) A tree, a native of Spain, flowering in May. It is said by some to be nearly related to *O'rnus europæa*; but by Vahl to *F. excelsior*. There is a plant in the Horticultural Society's Garden, which, in 1835, was 13 ft. high, after being 10 years planted; and from examining which it appears to us clear that this variety belongs to *F. excelsior*.

Other Sorts of the common European Ash, treated by botanists as species, might have been added to the above, but it is difficult to know where to stop. Were it not for the respect which we think it our duty to pay to the opinions of what are considered established authorities, we should have marked all the kinds in this, and the following section, as varieties of *F. excelsior*.

B. Leaflets small, smooth or shining above. Natives of the South of Europe, the North of Africa, or the West of Asia.

☞ 4. *F. (E.) PARVIFOLIA* Willd. The small-leaved Ash.

Identification. Willd. Sp., 1. p. 1101.; Tenore Syll., p. 9. No. 5.; Don's Mill., 4. p. 54.

Engravings. Willd. Berl. Baumz., p. 155. t. 2. f. 2.; our fig. 1052.; and the plate in Vol. VII. 7.

Spec. Char., &c. Leaflets 5—7 pairs, sessile, roundish ovate and oblong, attenuated at the base; quite entire at the base, but sharply serrated at the apex, mucronate. Flowers naked. Branches purplish, trigonal at the top. (*Don's Mill.*, iv. p. 54.) A tree, from 30 ft. to 40 ft. high, a native of the Levant. Introduced in 1822, and flowering in April and May. In the environs of London, at Ham House, there is a tree 54 ft. high, the diameter of the trunk 2 ft. 6 in., and of the head 40 ft. In the Horticultural Society's Garden, and in the arboretum at Messrs. Loddiges's, there are several varieties of this tree; some of them having leaflets almost as long as those of the common ash. In other places, and particularly in the nursery lines at Messrs. Loddiges's, there are plants, some of the leaves of which have roundish leaflets, and others long ones; so that it is impossible for us to doubt that this kind is only a variety of *F. excelsior*.



1052

‡ 5. *F. (E. P.) ARGENTEA* Lois. The silvery-leaved Ash.

Identification. Lois. Fl. Gall., 697.; *Don's Mill.*, 4. p. 54.

Spec. Char., &c. Leaves with usually 3 pairs of rather coriaceous, elliptic, ovate, shortly cuspidate, bluntly toothed leaflets, on short petiolules. Leaves silvery grey. (*Don's Mill.*, iv. p. 54.) A tree, a native of Corsica, in the fissures of rocks. Introduced in 1835, and flowering in April and May. There are plants in the arboretum of Messrs. Loddiges. This variety must not be confounded with *F. e. foliis argenteis*, which is merely a variegation of the common ash (*F. excelsior*).

‡ 6. *F. (E. P.) OXYCARPA* Willd. The sharp-fruited Ash.

Identification. Willd. Sp., 4. p. 1100.; *Don's Mill.*, 4. p. 55.

Synonymes. *F. oxyphylla* Bieb. Fl. Taur., 2. p. 450.; *F. Ornus*

Pall. Itin. Taur.

Engraving. Our fig. 1053.

Spec. Char., &c. Leaflets 2—3 pairs, almost sessile, lanceolate, acuminate, serrated, glabrous. Flowers naked. Samara lanceolate, attenuated at both ends, mucronate. Branchlets green, with white dots. Buds brown. (*Don's Mill.*, iv. p. 55.) A tree, a native of Caucasus. Introduced in 1815, and flowering in May. There are plants of this very distinct kind of ash in the garden of the Horticultural Society, and in the arboretum of Messrs. Loddiges. Of all the varieties of the small-leaved ash, this appears to us to be the most beautiful, except, however, the pendulous variety of *F. lentiscifolia*. The leaves are of a dark glossy green, and are produced in tufts at the ends of the branches.



1053

‡ 7. *F. (E.) PALLIDA* Bosc. The pale-barked Ash.

Identification. Bosc ex Spreng. Syst., 1. p. 96.; *Don's Mill.*, 4. p. 56.

Spec. Char., &c. Leaves with 3 pairs of glabrous, almost sessile, ovate-lanceolate, toothed leaflets. Branches yellow. (*Don's Mill.*, adapted.) In *Don's Miller* this kind is stated to be a native of North America; but in the Horticultural Society's Garden, and in the arboretum of Messrs. Loddiges, the plants to which this name is affixed obviously belong to *F. excelsior*. The specimen in the Horticultural Society's Garden was, in 1834 (having been 10 years planted), 10 ft. high.

‡ 8. *F. LENTISCIFOLIA* Desf. The Lentiscus-leaved Ash.

Identification. Desf. Cat. Hort. Par., p. 52; Willd. Sp., p. 1101.

Synonyms. *F. tamariscifolia* Vahl Enum., 1. p. 52.; *Don's Mill.*, 4. p. 54.; *F. parvifolia* Lam. Dict., 2. p. 540.; *F. aleppensis* Pluk. Phyt., 182. f. 4.

Engravings. Pluk. Phyt., 182. f. 4.; our fig. 1054.; and the plate of this species in our last Volume.

Spec. Char., &c. Leaflets petiolate, oblong and lanceolate, sharply serrated, the serratures mucronate; 4—5 pairs according to Vahl; 6—7 pairs according to Willd.; $\frac{1}{2}$ in. long, terminal one smaller than the lateral ones. Branches dark purple. Buds brown. Flowers naked. Samara narrow, gradually widening to the apex, and retuse there. (*Don's Mill.*, adapted.) A tree, a native of the country near Aleppo. Introduced in 1710, and flowering in May and June. The largest specimen near London is at Purser's Cross, where it is upwards of 50 ft. high; and there is one at Syon 19 ft. high. 1054 There is also a tree at Croome, in Worcestershire, 45 years planted, and 35 ft. high; and one at West Dean, in Sussex, 10 years planted, and 21 ft. high. In France, a tree in the park at Clairvault, 44 years planted, is 29 ft. high. Plants, in the London nurseries, are commonly propagated by grafting; but seeds which are received from the north of France come true to their kind.



Variety.

‡ F. l. 2 *pendula* has slender pendulous branches, and forms a very elegant tree. It was introduced in 1833 from the Floetbeck Nurseries; and there are plants in the Horticultural Society's Garden, and the arboretum of Messrs. Loddiges. This is a rapid-growing and most beautiful tree, which, when better known, will become very popular.

C. *Leaves and Leaflets large, glaucous and downy beneath. Natives exclusively of North America.*

From carefully observing all the alleged species of American ash in the Horticultural Society's Garden, and in the arboretum of Messrs. Loddiges, we are convinced they are all variations of one and the same species. The most distinct of these, as far as respects the leaves, appears to be *F. a. pubescens*; and as far as respects the shoots, *F. a. quadrangulata*: but it is proper to remark, that, as the plants referred to as having been examined are all of small size, and some of them miserable specimens, there may be some of the varieties much more distinct than we are aware of. At the same time we hold it as a principle, that a difference, to be specific, must be recognisable in the exterior appearance of the plant, in every stage of its age and growth, and at every season of the year. Seeds of several sorts of American ash are annually imported from America by Mr. Charlwood, and perhaps by other London seedsmen, and sold at 4s. a quart; but, as these seeds are generally purchased by private gentlemen in distant parts of the country, and not by the London nurserymen, who can produce saleable plants at a much cheaper rate by budding or grafting, we have not had an opportunity of observing whether or not the plants are true to the specific descriptions. If they did come tolerably true, we should not, on that account, be the less inclined to consider them varieties; since the seeds of varieties of fruit trees, of timber trees, and of ornamental shrubs much in cultivation, and indeed of varieties of all plants whatever, always come up more or less true; though individuals among seedlings of such varieties may be found widely varying from the general character of the variety, and hence so many new varieties and subvarieties. Many thousand seedlings of what Cobbett called the American ash (doubtless *F. americana* Willd.) were purchased from him by his admirers in different parts of England, and we have no doubt the possessors of such of the plants as are now become trees of 10 or 12 years' growth, might select from among them many varieties very distinct. How far the alleged species may differ

in the form of their flowers and fruit, we have had no opportunity of judging; having only heard of one American ash which has ripened seed in England, and never having seen the flowers of any of the sorts. Supposing all the alleged species of American ash to be but varieties, they will not be more numerous than the varieties which are, or might be, distinguished, of the common European ash; and not half so many as there are of *Quercus Cœrris*, *Q. Flex*, and other species of oak, of which nobody takes any notice, because they cannot be readily propagated by grafting.

Sorts of American Ash, of which Seeds may be procured from the London Seedsmen, more particularly Mr. Charlwood.

F. americana Willd., *F. acuminata* Charlwood's *Cat.*, ed. 1835. No. 9., and fig. 1055.

F. (a.) pubescens Walt., *F. pubescens* and *F. tomentosa* Charlwood's *Cat.*, ed. 1835. No. 10., and fig. 1055. in p. 1234.

F. (a.) sambucifolia Vahl. No. 11., and fig. 1057. in p. 1235.

F. (a.) juglandifolia Lam. No. 13., and fig. 1062. in p. 1237.

F. (a.) caroliniana Lam. No. 14., in p. 1237.

F. (a.) epiptera Michx. No. 15., in p. 1237.

‡ 9. *F. AMERICANA* Willd. The American Ash.

Identification. Willd. *Sp.*, 4. p. 1102.; Michx. *N. Amer. Syl.*, 3. p. 59.; Lodd. *Cat.*, ed. 1836.

Synonymes. *F. acuminata* Lam. *Dict.*, 2. p. 542., *Don's Mill.*, 4. p. 56., *Pursh Fl. Amer. Sept.*, 2. p. 9.; *F. discolor* Muhl.; white Ash, green Ash. *Amer.*

Engravings. Michx. *N. Amer. Syl.*, 3. t. 118.; our fig. 1055.; and the plate of this species in our last Volume.

Spec. Char., &c. Leaflets 7, petiolate, oblong, acuminate, shining above, quite entire, glaucous beneath. Flowers calyculate. (*Don's Mill.*, adapted.) A tree, a native of North America, from Canada to Carolina, in woods. Introduced in 1723, and flowering in May.

Variety.

‡ *F. a. 2 latifolia* has broader leaves than the species. The plant of this variety in the Horticultural Society's Garden was, in 1835, after being 10 years planted, 11 ft. high.

Description, Geography, &c. In Michaux's *North American Sylva*, *F. americana* is said to be one of the most interesting among the American kinds of ash for the qualities of its wood; and the most remarkable for the rapidity of its growth, and for the beauty of its foliage. It rises with a straight clean trunk, often undivided to the height of more than 40 ft. The leaves are 12 in. or 14 in. long; the leaflets 3 in. or 4 in. long; and they are borne on short petiolules. Early in spring, the leaflets are covered with a light down, which gradually disappears, till, at the approach of summer, they are perfectly smooth, of a light green colour above, and whitish beneath. This difference in the colour of the surfaces of the leaflets is peculiar to this species; and hence it has been named *F. discolor*. It is called the white ash from the colour of its bark, by which it is easily distinguished, in America, from the other sorts indigenous there. In Britain, all sorts of American ash are readily known from *Fraxinus excelsior*, by their lighter bark, and by the paler green of

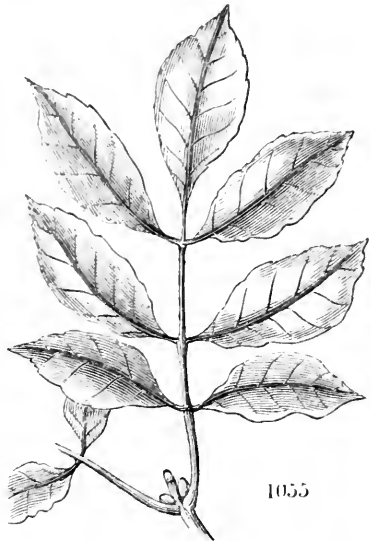

1055

their leaves. The species or variety under consideration is abundant in New Brunswick and Canada; and, as a cold climate is more congenial to it than a warm one, it is found in greater numbers north of the Hudson River than south of it. Its favourite situations are the banks of rivers and the edges or acclivities of swamps, where it attains the height of 80 ft., with a trunk 3 ft. in diameter. In "the upper part of New Hampshire, it is always accompanied by the white elm (*Ulmus montana*), yellow birch (*Bétula lutea*), white maple (*Acer eriocarpum*), hemlock spruce (*Abies canadensis*), and black spruce (*Abies nigra*); and in New Jersey it is mingled with the red maple (*Acer rubrum*), shell-bark hickory (*Carya alba*), and button-wood (*Platanus occidentalis*). In large trees, the heart-wood is reddish, and the sap-wood is white. It is used, in America, for all the various purposes to which the wood of the ash is applied in Europe; and for other uses peculiar to the circumstances of the former country. The wood is exported to Europe, and especially to England, in planks. About the year 1826, when Cobbett became a nurseryman, and strongly recommended several kinds of American trees, several plantations were formed, in different parts of England, of the white ash: but a sufficient time has not yet elapsed to judge of the value of the tree as compared with the common European ash. The American sorts of ash, it is observed by Descemet, writing at Odessa, have the great advantage of prospering in soils where the European ash will languish. They are not, he says, like *F. excelsior*, subject to lose their leaves by the ravages of the insect *Cántharis vesicatoria* in the middle of summer, and may, consequently, be planted in the neighbourhood of dwelling-houses. They resist the burning heats of summer much better than the European ash tree, and maintain a deep green foliage during the hottest weather, when that of the common ash becomes pale, and very frequently withers and drops: in short, the American ash trees, he adds, deserve to be extensively cultivated in forests, in lines for bordering roads, and in small groups in parks and pleasure-grounds. (*Tableau Historique, &c.*, p. 39.) In the neighbourhood of London, young trees are generally more or less injured by the spring frosts; nevertheless, in Surrey, at St. Ann's Hill, there is a tree, 36 years planted, which is 33 ft. high; and in Bedfordshire, at Southhill, one, 22 years planted, which is 14 ft. high. In France, at Clairvault, a tree, 30 years planted, is 30 ft. high. The plants of this species in the Horticultural Society's Garden, were, in 1835, from 10 ft. to 15 ft. high, after being 10 years planted. Price of plants, in the London nurseries, 1s. 6d. each, and of seeds 4s. per quart; at Bollwyller, plants are 1 franc; and at New York, 50 cents.

‡ 10. *F. (A.) PUBESCENS* Walt. The downy Ash.

Identification. Walt. Fl. Car., p. 254.; Vahl Enum., p. 51.; Pursh Fl. Amer. Sept., 1. p. 9.; Willd.

Sp., 4. p. 1103.; Don's Mill., 4. p. 55.

Synonymes. *F. nigra Du Roi Harbk.*, ed. 2., vol. 1. p. 398.; *F. tomentosa Michx. N. Amer. Syl.*, 3.

p. 63.; red Ash, black Ash, *Amer.*

Engravings. Michx. N. Amer. Syl., 3. t. 119.; and our *fig. 1056.*

Spec. Char., &c. Leaflets 3—4 pairs, petiolate, elliptic-ovate, serrated, downy or tomentose beneath, as well as the petioles and branches. Flowers calyculate. Racemes rather compound. Calyx campanulate. Samara narrow-lanceolate, obtuse, with a short mucro at the apex, 2 in. long. Stamens 2—3—4. (*Don's Mill.*, iv. p. 55.) A tree, 30 ft. high; introduced in 1811, and flowering in May. Though Michaux has described the leaflets as denticulated, yet in his figure, of which *fig. 1056.* is a reduced copy, they are perfectly entire, as they are for the most part in the living plants at Messrs. Loddiges.

Varieties.

‡ *F. (a.) p. 2 longifolia* Willd. Sp., iv. p. 1103., Pursh Fl. Amer. Sept., 1.

p. 9., *Lodd. Cat.*, ed. 1836; *F. pennsylvanica Marsh.*; has the leaflets ovate-lanceolate, attenuated, somewhat serrated.

‡ *F. (a.) p. 3 latifolia* Willd., Pursh Fl. Amer. Sept., 1. p. 9., has the leaflets ovate, broad.

- ‡ *F. (a.) p. 4 subpubescens* Pers. Ench., ii. p. 605., Pursh Fl. Amer. Sept. 1., p. 9.; ? *F. subvillòsa* Bosc; has the leaflets petiolate, elliptic-oblong, acuminate, sharply serrated, downy beneath; common petioles glabrous.

Description, &c. According to Michaux, this tree rises perpendicularly to the height of 60 ft., with a trunk 15 in. or 18 in. in diameter. The length of the annual shoots, and the spaces between the buds, are one half those of *F. americana*; and the tree is of smaller size, and slower growth. The leaves are from 12 in. to 15 in. long, downy on the under surface; and on insulated trees this down becomes red on the approach of autumn, both on the leaves and shoots of that year; whence, probably, the name of red ash. The bark of the trunk is of a deep brown, and the heart-wood of a brighter red than that of the white ash. This tree is most abundant in Pennsylvania, Maryland, and Virginia; where it prefers swamps and places frequently inundated, or liable to be covered with water by copious rains. In these situations, it is accompanied by the shell-bark hickory (*Carya álba*), bitter nut hickory (*Carya amara*), swamp white oak (*Quercus Prinus discolor*), red maple (*Acer rubrum*), sweet gum (*Liquidambar Styraciflua*), and tupelo tree (*Nýssa bicolor*). In the United States, the wood of the red ash is applied to the same uses as that of the white ash; compared with which, it is somewhat harder, and less elastic. In Britain, it can only be considered as an ornamental tree. The specimen in the Horticultural Society's Garden was, in 1834, after having been 10 years planted, 19 ft. high. Price of plants, in the London nurseries, 1s. 6d. each, and of seeds 4s. per quart; at Bollwyller, plants are 1 franc each; and at New York, 50 cents.



1056

‡ 11. *F. (A.) SAMBUCIFOLIA* Vahl. The Elder-leaved Ash.

Identification. Vahl Enum., 1. p. 51.; Willd. Sp., 4. p. 1099.; Muhl. Nov. Act. Scrut. Berol., 3. p. 393.; Pursh Fl. Amer. Sept., 1. p. 8.; Don's Mill., 4. p. 54.; Lodd. Cat., ed. 1836.
Synonymes. *F. nigra* Macneil; *F. crispa* Hort.; the black Ash, Water Ash, Amer. Engravings. Michx. N. Amer. Syl., 3. t. 122.; and our figs. 1057. and 1058.

Spec. Char., &c. Leaflets 3 pairs, 3—4 in. long, acute at both ends, sessile, ovate-lanceolate, serrated, having the axils of the veins villous beneath. Young branches green, beset with black dots. Buds brown or blue. Flowers like those of the common ash. (*Don's Mill.*, iv. p. 54.) A tree, 30 ft. high; a native of North America, from Canada to Carolina. Introduced in 1800, and flowering in May.

Variety.

- ‡ *F. (a.) s. 2 crispa* Lodd. Cat., ed. 1836, has the leaves curled. There are plants of this variety in the arboretum of Messrs. Loddiges. Michaux mentions another sort of black ash, found in Kentucky; but which, he says, he is too imperfectly acquainted with to be able to describe.

Description, &c. The black ash, Michaux says, grows to the height of 60 ft. or 70 ft., with a trunk 2 ft. in diameter. The buds are of a deep blue, and the young shoots are sprinkled with dots of the same colour, which disappear as the season advances. The leaves, at their unfolding, are accompanied by scales, which fall after two or three weeks: they are 12 in. or 15 in. long when fully developed; and the leaflets are sessile, of a deep green colour, smooth on

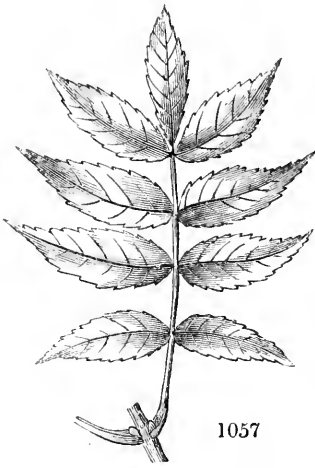

1057

the upper surface, and coated with red down on the main ribs beneath. When bruised, they emit an odour like that of the leaves of the elder. The samaras resemble those of the blue ash (*F. quadrangulata*), and are nearly as broad at the base as at the summit. The black ash is easily distinguished from the white ash by its bark, which is of a duller hue, less deeply furrowed, and has the layers of the epidermis applied in broad sheets. The tree is found in the northern section of the United States, and in the provinces of New Brunswick and Nova Scotia, in great abundance, in the forests. It is generally

1058



found on a moist soil, and usually accompanied by the red maple (*Acer rubrum*), the yellow birch (*Betula lutea*), the black spruce (*Abies nigra*), and the arbor vitæ (*Thuja occidentalis*). In the middle states of the Union, this tree associates with the *Acer rubrum* and *F. pubescens* (No. 10. p. 1233.). Its timber is used for some of the purposes of the white ash; compared with which, its wood is tougher and more elastic, but less durable when exposed to the vicissitudes of dryness and moisture. In the district of Maine, it is preferred to the white ash for hoops; and, as the wood separates readily into thin narrow strips, it is used for making chair bottoms, and corn-riddles; as the common ash is in Britain, and more particularly in Scotland. The black ash is liable to be disfigured with knobs in the trunk, which are sometimes detached to make bowls, and which, when polished, exhibit curious undulations of fibre. This sort, like most of the other kinds of ash, is also very prolific in potash. Plants, in the London nurseries, are 1s. 6d. each, and seeds 4s. per quart.

‡ 12. *F. (A.) QUADRANGULATA Michx.* The quadrangular-branched Ash.

Identification. Michx. Fl. Bor. Amer., 2. p. 255., and N. Amer. Syl., 3. p. 73.; Willd. Sp., 4. p. 1104.; Vahl Enum., 1. p. 50.; Pursh Fl. Amer. Sept., 1. p. 8.; Don's Mill., 4. p. 55.

Synonyms. *F. tetragona Cels ex Dum. Cours.*; *F. quadrangulâris Lodd. Cat.*, ed. 1836.; blue Ash, *Amer.*

Engravings. Michx. N. Amer. Syl., 3. t. 123.; and our *figs.* 1959, 1060.

Spec. Char., &c. Leaflets almost sessile, elliptic-lanceolate, serrated, downy beneath. Samara blunt at both ends. Branches quadrangular. (*Don's Mill.*, iv. p. 55.) A tree, from 63 ft. to 70 ft. high; a native of Ohio, Kentucky, and Tennessee. It was introduced in 1823, and flowers in May.

Variety.

‡ *F. (a.) q. 2 nervosa Lodd. Cat.*, ed. 1836, has the leaves with conspicuous nerves.

Description, &c. The blue ash, in the United States, Michaux observes, "frequently exceeds 60 ft. or 70 ft. in height, and 18 in. or 20 in. in diameter. Its leaves are from 12 in. to 18 in. long, and are composed of 2, 3, or 4 pairs of leaflets, with an odd one. The leaflets are large, smooth, oval-acuminate, distinctly toothed, and supported by short petiolules. The young shoots to which the leaves are attached are distinguished by 4 opposite membranes, 3 or 4 lines broad, and of a greenish colour, extending through their whole length. This character disappears in the third or fourth year, leaving only the traces of its existence. The seeds are flat from one extremity to the other, and a little narrowed towards the base." The blue ash is found only in

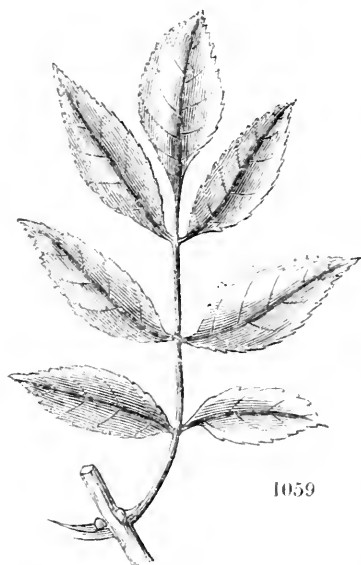

1059

Tennessee, Kentucky, and the southern part of Ohio, where the climate is mild, and the soil fertile in an extreme degree. This fertility seems to serve as a substitute for that degree of moisture which, in the Atlantic states, seems indispensable to the ash. Where this tree abounds, its wood is used for the flooring and covering of houses; though for shingles it is inferior to that of the tulip tree. Plants of this sort are in the Horticultural Society's Garden, and in Messrs. Loddiges's arboretum; but they are of no great height. They are readily distinguished from all the other varieties of American ash, as far as we have been able to observe



1060

of the white American oak (*Quercus alba*). The price of plants is 2*s.* each, and of seeds 4*s.* per quart.

‡ 13. *F. (A.) JUGLANDIFOLIA* Lam. The Walnut-leaved Ash.

Identification. Lam. Dict., 2. p. 543; Willd. Sp., 1. p. 1104; Pursh Fl. Amer. Sept., 1. p. 9; Don's Mill, 4 p. 55; Lodd. Cat., ed. 1836.

Synonymes. *F. viridis* Michx. N. Amer. Syl., 3. p. 65. t. 120.; *F. cœcolor* Muhl.; the green Ash, Michx.; western black Ash, Pursh.

Engravings. Michx. N. Amer. Syl., 3. t. 120.; our figs. 1061, 1062; and the plate in our last Volume.

Spec. Char., &c. Leaflets 2—4 pairs, 3 in. long, membranous, glabrous, but not shining, canescent beneath, downy in the axils of the veins, stalked, elliptic-lanceolate, serrated, glaucous beneath. Petioles calyous. Branches glabrous, and, like the buds, greyish brown. Flowers calyculate. Calyx 4-toothed. Corymbs pendulous. Samara linear. (*Don's Mill.*, adapted.) A tree, from 30 ft. to 50 ft. high; a native from Canada to North Carolina; found in shady wet woods, and chiefly in the western districts. It was introduced in 1724, and flowers in May.

Variety.

‡ *F. (a.) j. 2 subintegerrima* Vahl Enum., i. p. 50.; *F. juglandifolia* β serrata Willd.; *F. caroliniana* Wangenh. Amer., p. 81. ex Willd., *Du Roi Harbk.*, ed. 2., vol. i. p. 400. ex Vahl; *F. Novæ-Angliæ* and *F. caroliniana* Mill. Dict., Nos. 5. 6.?

Description, &c. The green ash is easily recognised by the brilliant colour of its young shoots; and by its leaves being nearly of the same colour on both surfaces. From this uniformity, which is rarely observed in the foliage of trees, Dr. Muhlenburg applied the specific name *cœcolor*; and Michaux gave this tree the popular name of the green ash. The leaves vary in length from 6 in. to 15 in. with from 2 to 4 pairs of leaflets, and an odd one, according to the vigour of the tree, and to the coolness of the soil in which it grows. The leaflets are petiolated, and distinctly denticulated. The seeds are small; and the tree does not attain a great size. The green ash is more common in Pennsylvania, Maryland, and Virginia, than in any other part of the United States; but it is much less common than the white ash and black



1061

ash. In America, the wood is applied to the same purposes as that of the other species; but in France, into which country it was introduced in 1775, and in England, it is only to be considered as an ornamental tree. The finest specimens of it that we have heard of are in the garden of Pope's Villa at Twickenham, but beyond the foundation of the wall which bounded what was Pope's property, where it is 67 ft. high, the diameter of the trunk 3 ft., and of the head 70 ft. This splendid tree, which retains its leaves till Christmas, flowers, but never produces seed. In Pembrokeshire, at Stackpole Court, where, in 40 years, it has attained the height of 60 ft., it ripens seeds, from which many young plants have been raised, and distributed in the plantations.



1062

In Worcestershire, at Croome, in 30 years, it has attained the height of 35 ft. In Scotland, in Fifeshire, at Danibristle Park, 15 years planted, it is 19 ft. high. In Ireland, in the Glasnevin Botanic Garden, one, 35 years planted, is 30 ft. high; and in Louth, at Oriel Temple, there is one, 45 years planted, which is 56 ft. high. Price of plants and seeds as in the preceding sort.

‡ 14. *F. (A.) CAROLINIANA Lam.* The Carolina Ash.

Identification. Lam. Dict., 2. p. 543.; Pursh Fl. Amer. Sept., 1. p. 9.; Vahl Enum., 1. p. 51.; Willd. Sp., 1. p. 1103.; Don's Mill., 4. p. 55.; Lodd. Cat., ed. 1836.

Synonymes. *F. excelsior Walt. Fl. Car.*, p. 254.; *F. serratifolia Michx. fl. Arb.*, p. 33.; *F. lanceolata Borkh.*

Engraving. Michx. N. Amer. Syl., 3. t. 124.

Spec. Char., &c. Leaflets 2—3 pairs, oval, petiolate, serrated, glabrous and shining above. Flowers calyculate. Branches glabrous, and, like the buds, brownish. Racemes loose, 1½ in. long, often twin from the same bud, Pedicels numerous, umbellate. Calyx small, campanulate. (*Don's Mill.*, adapted.) A tree, from 30 ft. to 50 ft. high; a native from Pennsylvania to Carolina. It was introduced in 1783, and flowers in May and June.

Description, &c. This is a very remarkable variety, readily distinguished by the large size of its leaflets, which are nearly round, but acuminate, and seldom consist of more than two pairs, with an odd one. The samaras are unlike those of any of the preceding sorts; being flat, oval, and often almost as broad as they are long. The tree seldom exceeds 30 ft. in height; and it flowers and fruits when 15 ft. or 20 ft. high. In spring, the lower surface of the leaves, and the young shoots, are covered with down, which disappears as the summer advances. This species is limited to the southern states; abounding chiefly on the river at Cape Fear, in North Carolina; and upon the Ashley and the Cooper, in South Carolina. (*Michx.*) In America, it is entirely neglected as a timber tree; and in Europe, it is solely considered as ornamental.

‡ 15. *F. (A.) EPIPTERA Vahl.* The wing-topped-seeded, or two-coloured, Ash.

Identification. Pursh Fl. Amer. Sept., 1. p. 8.; Vahl Enum., 1. p. 50.; Willd. Sp., 4. p. 1102.; Don's Mill., 4. p. 55.; Lodd. Cat., ed. 1836.

Synonymes. *F. canadensis Gærtn. Fruct.*, 1. p. 222. t. 49.; *F. lancea Bosc.*

Engraving. Gærtn. Fruct., 1. t. 49.;

Spec. Char., &c. Leaflets lanceolate-elliptic, subserrated, opaque, and downy beneath on the veins. Samara cuneated, obtuse and emarginate at the

apex, and terete at the bottom. Young branches green, covered with white dots. Bark chinky. Flowers calyculate. Buds brown. (*Don's Mill.*, iv. p. 55.) A tree, 30 ft. high; a native of North America, from Canada to Carolina. Introduced in 1823, and flowering in May. There are plants of this sort in the Horticultural Society's Garden, and in the arboretum of Messrs. Loddiges. A tree in the former collection was, in 1834, 15 ft. high, after being 10 years planted.

‡ 16. *F. (A.) PLATYCARPA Vahl.* The broad-fruited Ash.

Identification. Vahl Enum., 1. p. 49.; Pursh Fl. Amer. Sept., 1 p. 9.; Don's Mill., 4. p. 55.; Lodd. Cat., ed. 1836.

Synonymes. *F. caroliniana Catesb. Car.*, t. 80.; the Carolina Ash, *Amer.*

Engravings. Michx. N. Amer. Syl., 3. fig. 124.; and our figs. 1063, 1064.

Spec. Char., &c. Leaflets almost sessile, very distinctly serrated, elliptic-lanceolate, 2 in. long and 1 in. broad; having the larger veins villous beneath. Samara elliptic-lanceolate, 2 in. long, acute at both ends. (*Don's Mill.*, iv. p. 55.) A tree, from 30 ft. to 50 ft. high; a native of



1063



1064

Virginia and Carolina. Introduced in 1724, and flowering in May. The tree of this sort in the arboretum of the Horticultural Society was, in 1834, 11 ft. high, after having been 6 years planted. It is very easily known from all the other American ashes, by the leaves dying off, in the autumn, of a fine purple.

‡ 17. *F. (A.) EXPANSA Willd.* The expanded Ash.

Identification. Willd. Berl. Baumz., p. 150.; Don's Mill., 4. p. 55.; Lodd. Cat., edit. 1836.

Synonyme. *F. caroliniana Hort. Worlitz.*

Spec. Char., &c. Leaflets 5 pairs, 3 in. long, ovate-oblong, unequally serrated, acuminate, glabrous, but not shining, petiolate. Branches glabrous. Flowers calyculate. Young branches green, smooth. Buds brown. (*Don's Mill.*, iv. p. 55.) A tree 30 ft. to 50 ft. high; a native of North America. Introduced in 1824, and flowering in May. There are plants of this sort in the arboretum of Messrs. Loddiges.

‡ 18. *F. (A.) MIXTA Bosc.* The mixed Ash.

Identification. Bosc ex Spreng. Syst., 1. p. 96.; Don's Mill., 4. p. 55.

Spec. Char., &c. Leaves with 5 pairs of leaflets, glabrous on both surfaces, oblong, almost sessile, unequally toothed. (*Don's Mill.*, iv. p. 55.) A tree, a native of North America. Introduced in 1824, and flowering in May. We have not seen this sort.

‡ 19. *F. (A.) PULVERULENTA Bosc.* The powdery Ash.

Identification. Bosc ex Spreng. Syst., 1. p. 96.; Don's Mill., 4. p. 55.

Spec. Char., &c. Leaves with 6 pairs of leaflets, tomentose beneath, on long petioles, oblong, acute, sinuated. Petioles powdery. (*Don's Mill.*, iv. p. 55.) A tree, a native of North America. Introduced in 1824, and flowering in May. We have not seen the plant.

‡ 20. *F. (A.) RUBICUNDA* Bosc. The reddish-veined Ash.

Identification. Bosc, l. c.; Don's Mill., 4. p. 56.

Spec. Char., &c. Leaves with 3 pairs of coriaceous leaflets, rather tomentose beneath, oblong, acute, a little toothed, and having the veins and petioles reddish beneath. Buds and branchlets grey. (*Don's Mill.*, iv. p. 56.) A tree, a native of North America. Introduced in 1824, and flowering in May. We have not seen this sort.

‡ 21. *F. (A.) LONGIFOLIA* Bosc. The long-leaved Ash.

Identification. Bosc, l. c.; Don's Mill., 4. p. 56.

Spec. Char., &c. Leaves with 3 pairs of leaflets, shining above, but tomentose beneath, and on the petioles. Leaflets oblong-lanceolate, acuminate, a little toothed. Branches hairy. (*Don's Mill.*, iv. p. 56.) A tree, from 30 ft. to 40 ft. high; a native of North America. Introduced in 1824, and flowering in May. We have not seen this sort.

‡ 22. *F. (A.) VIRIDIS* Bosc. The green Ash.

Identification. Bosc, l. c.; Don's Mill., 4. p. 56.; Lodd. Cat., ed. 1836.

Spec. Char., &c. Leaves with 3 pairs of leaflets, shining above, but the veins are downy beneath; leaflets oblong, acute, sharply and unequally serrated. Branches green. (*Don's Mill.*, iv. p. 56.) A tree, a native of North America. Introduced in 1824, and flowering in May. A tree of this sort, in the arboretum of the Horticultural Society, was, in 1834, 13 ft. high, after being 8 years planted.

‡ 23. *F. (A.) CINE'REA* Bosc. The grey Ash.

Identification. Bosc, l. c.; Don's Mill., 4. p. 56.; Lodd. Cat., ed. 1836.

Spec. Char., &c. Leaves with 3 pairs of glabrous leaflets, but the veins are rather pilose beneath; leaflets lanceolate, unequally toothed. Buds linear, grey, pilose. (*Don's Mill.*, iv. p. 56.) A tree, a native of North America. Introduced in 1824, and flowering in May. There are plants of this sort in the arboretum of Messrs. Loddiges.

‡ 24. *F. (A.) ALBA* Bosc. The white Ash.

Identification. Bosc, l. c.; Don's Mill., 4. p. 56.

Synonymes. In the Horticultural Society's Garden there are, or were lately, *F. caroliniana* álba, *F. americana* álba var., and *F. am. álba* affinis; but, whether any of them is a synonyme of the *F. álba* of Bosc, we are unable to determine.

Spec. Char., &c. Leaves with 3 pairs of leaflets, hairy beneath, and on the petioles. Leaflets lanceolate, unequally and sharply toothed, acuminate. Branches grey. (*Don's Mill.*, iv. p. 56.) A tree, a native of North America. Introduced in 1823, and flowering in April and May. We are not aware of any sort being in British gardens under this name: the white ash of Cobbett is our *F. americana*.

‡ 25. *F. (A.) RICHARDI* Bosc. Richard's Ash.

Identification. Bosc, l. c.; Don's Mill., 4. p. 56.; Lodd. Cat., ed. 1836.

Spec. Char., &c. Leaves with 3 pairs of oblong, acute, toothed, glabrous leaflets; but the veins are rather pilose beneath. Branches cinereous, pilose at the base. (*Don's Mill.*, iv. p. 56.) A tree, a native of North America, and flowering there in April and May. Introduced in 1812. There are plants of this sort in the arboretum of Messrs. Loddiges.

‡ 26. *F. (A.) OVA'TA* Bosc. The ovate-leaved Ash.

Identification. Bosc, l. c.; Don's Mill., 4. p. 56.; Lodd. Cat., ed. 1836.

Spec. Char., &c. Leaves pilose beneath, with 3 pairs of leaflets, that are ovate, acute, equally toothed. Buds fulvous. (*Don's Mill.*, iv. p. 56.) A tree, a native of North America, and flowering there in April and May. Introduced in 1812. There are plants in the Hackney Arboretum.

‡ 27. *F. (A.) NI'GRA* Bosc. The black Ash.

Identification. Bosc, l. c.; Don's Mill., 4. p. 56.; Lodd. Cat., ed. 1836.

Spec. Char., &c. Leaves with 3 pairs of glabrous leaflets, which are oblong, acuminate, somewhat sinuately toothed. Branches blackish. (*Don's Mill.*, iv. p. 56.) A tree, a native of North America, and flowering there in April and May. Introduced in 1825. A plant of this sort, in the arboretum of the Horticultural Society, was, in 1834, 13 ft. high, after being 8 years planted.

‡ 28. *F. (A.) ELLIPTICA* Bosc. The elliptic-leaved Ash.

Identification. Bosc, l. c.; Don's Mill., 4. p. 56.; Lodd. Cat., ed. 1836.

Spec. Char., &c. Leaves with 3 pairs of leaflets, pilose beneath, oblong, mucronate, a little toothed. Buds fulvous. Branches brownish black. (*Don's Mill.*, iv. p. 56.) A tree, a native of North America. Introduced in 1824, and flowering in April and May. There are plants of this sort in the arboretum of Messrs. Loddiges.

‡ 29. *F. (A.) FUSCA* Bosc. The brown-branched Ash.

Identification. Bosc, l. c.; Don's Mill., 4. p. 56.

Spec. Char., &c. Leaves with 3 pairs of leaflets, glabrous above, but the veins villous beneath; leaflets oblong, mucronate, unequally toothed. Branches brown. (*Don's Mill.*, iv. p. 56.) A tree, a native of North America. Introduced in 1823, and flowering in April and May. We are not aware of this sort being in British gardens.

‡ 30. *F. (A.) RUFA* Bosc. The rufous-haired Ash.

Identification. Bosc, l. c.; Don's Mill., 4. p. 56.

Spec. Char., &c. Leaves with 2 pairs of leaflets, beset with rufous hairs beneath, lanceolate, acuminate, cuspidate, unequally toothed. (*Don's Mill.*, iv. p. 56.) A tree, a native of North America. Introduced in 1822, and flowering in April and May; but we have not seen the plant.

‡ 31. *F. (A.) PANNO'SA* Vent. et Bosc. The cloth-like-leaved Ash.

Identification. Vent. et Bosc, l. c.; Don's Mill., 4. p. 56.

Engraving. The plate of this species in our last Volume.

Spec. Char., &c. Leaves with 3 pairs of leaflets, villously tomentose beneath, petiolate, ovate, quite entire, attenuated at both ends. Buds fulvous. Petioles glabrous. (*Don's Mill.*, iv. p. 56.) A tree, a native of Carolina. Introduced in 1820, and flowering in April and May. There are plants of this sort in the collection of Messrs. Loddiges; and there is a tree, at Ham House 67 ft. high, the diameter of the trunk is 2 ft. 8 in., and of the head 48 ft. A portrait of this tree, as it appeared in the autumn of 1835, will be found in our last Volume. As far as the present gardener, Mr. James London, has observed, this tree has never flowered.

‡ 32. *F. BO'SCII* G. Don. Bosc's Ash.

Identification. Don's Mill., 4. p. 55.

Synonymy. *F. nana* Bosc, but not Willd.

Spec. Char., &c. Leaves with 3 pairs of glabrous leaflets, oblong, acuminate, and toothed. Common petioles winged at the base. Buds blackish. Branches cinerous. Flowers naked. (*Don's Mill.*, iv. p. 55.) A tree, a native of North America, flowering in May and June.

‡ 33. *F. (A.) POLEMONIFOLIA* Poir. The Greek-Valerian-leaved Ash.

Identification. Poir. in N. Du Ham., 4. p. 66.; Don's Mill., 4. p. 54.; Lodd. Cat., ed. 1836.

Synonymy. *F. nana* Desf. *Hort. Par. et Arb.*, 1. p. 104.; *F. nana* (appendiculata) *Pers. Ench.*, 2. p. 604.

Spec. Char., &c. Leaflets usually 4—5 pairs, quite glabrous, sharply toothed, ovate, nearly sessile, approximate, 6—7 lines long, and 3 lines broad, acute. Petioles a little winged; common petioles winged. Branches of a livid lead-colour. (*Don's Mill.*, iv. p. 54.) A branched shrub, a native of North America, flowering in April and May. Introduced in 1812. There are plants bearing this name in the collection of the Messrs. Loddiges, but we can see nothing in their leaves resembling any species of *Polemonium*.

‡ 34. *F. (A.) TRIPTERA* Nutt. The three-winged-fruited Ash.

Identification. Nutt. Gen. Amer., 2. p. 232.; Don's Mill., 4. p. 56.

Spec. Char., &c. Leaflets obovate, entire, tomentose beneath, oblique at the base. Samara broad, elliptic-obovate, mostly 3-winged, attenuated at the base, 1-seeded. Seed 3-sided. (*Don's Mill.*, iv. p. 56.) A tree, a native of South Carolina, in oak forests, not yet introduced.

‡ 35. *F. CHINE'NSIS* Roxb. The China Ash.

Identification. Roxb. Fl. Ind., 1. p. 150.; Don's Mill., 4. p. 55.

Spec. Char., &c. Leaflets from 3 to 7, lanceolate, serrated. Panicles axillary and terminal. Leaves glabrous. Lateral leaflets on short petioles, and smaller than the terminal one, which is protruded on a winged petiole. Branches erect. Flowers apetalous. Panicles drooping. Style long and curved. (*Don's Mill.*, iv. p. 55.) A tree, growing to the height of from 12 ft. to 20 ft.; a native of China; and flowering in April. We have not heard of this species being in Britain.

‡ 36. *F. SCHIEDEANA* Schlecht. Schiede's Ash.

Identification. Schlecht. et Cham. in Linnæa, 6. p. 1.; Don's Mill., 4. p. 55.

Synonymæ. *Fagàra dùbia* Rœm. et Schult., 3. p. 288.

Spec. Char., &c. Glabrous. Leaves with 3 pairs of sessile, lanceolate, bluntish, quite entire leaflets, or with a few obsolete serratures in front; the old ones the longest, and attenuated at the base; all thin, shining above, and paler beneath. Common petiole channeled. Samara nearly linear, with the wing hardly dilated in front, elliptic-oblong, obtuse at the apex, ending in an oblique little point. Calyx deeply 5-parted. Stigmas 2. (*Don's Mill.*, iv. p. 55.) A tree, 10 ft. to 15 ft. high; a native of Mexico, in warm situations. Not yet introduced.

GENUS VII.



O'RNU.S *Pers.* THE FLOWERING ASH. *Lin. Syst.* Diándria Monogýnia, or Polygámia Díce'cia.

Identification. *Pers.* Ench., 1. p. 8.; Pursh Fl. Amer. Sept., 1. p. 6.; Nutt. Gen. Amer., 1. p. 6.; Lindl. Nat. Syst. Bot., p. 308.; Don's Mill., 4. p. 56.

Synonymes. *Fráxinus* sp. of the older authors; le Frêne à Fleurs, *Fr.*; die blühende Esche, *Ger.*; Oren, *Hebrew*; Oreinë mèlia, *Greek*.

Derivation. From *oros*, the Greek word for a mountain.

Gen. Char., &c. Flowers hermaphrodite, or of distinct sexes. *Calyx* 4-parted or 4-toothed. *Corolla* 4-parted; segments long, ligulate. *Stamens* with long filaments. *Stigma* emarginate. *Samara* 1-celled, 1-seeded, winged. (*Don's Mill.*, iv. p. 56.)—Trees, natives of Europe, North America, and Asia; with impari-pinnate leaves, and terminal or axillary panicles of flowers, distinguished from those of the common ash, by having corollas. Culture and price as in the American species of *Fráxinus*.

‡ 1. *O. EUROPEA* *Pers.* The European Flowering, or *Manna*, Ash.

Identification. *Pers.* Ench., 1. p. 9.; Sav. Trat., ed. 2. t. 1.; Don's Mill., 4. p. 56.

Synonymes. *Fráxinus O'rnus* *Lin. Sp.*, 1510., *Smith Fl. Græc.*, 1. t. 4., *Müll. Ic.*, t. 1., *Lam. Ill.*, 9. t. 858. f. 2., *Woodw. Med. Bot.*, 1. p. 104., *Church et Stev. Med. Bot.*, 2. t. 53., *Lodd. Cat.*, ed. 1836; *F. O'rnus*, and *F. paniculata* *Mill. Dict.*, No. 3. and No. 4.; *F. Horifera* *Scop. Carn.*, No. 1250.; *F. botryoides* *Mor. Præhud.*, 265.; *F. vulgarior* *Scgn. Ver.*, 2. p. 290.

Engravings. *Fl. Græc.*, 1. t. 4.; *Mill. Fig.*, t. 1.; *Lam. Ill.*, 9. t. 858. f. 2.; *Woodw. Med. Bot.*, 1. p. 104. t. 36.; *Church et Stev. Med. Bot.*, 2. t. 53.; *N. Du Ham.*, t. 15.; and the plates of this species in our last Volume.

Varieties. *O'rnus rotundifolia* and *O. americana*, described below as species, are, without doubt, only varieties of *O. europæa*; and there is another variety, introduced from the Continent in 1835, of which there are young plants in the collection of Messrs. Loddiges, bearing the name of *F. O'rnus globifera*.

Spec. Char., &c. Leaves with 3—4 pairs of lanceolate or elliptic, attenuated, serrated, stalked leaflets, which are entire at the base, villous or downy beneath. Flowers greenish white. Peduncles axillary, solitary, shorter than the leaves. Flowers complete or hermaphrodite. Young branches purplish or livid, with yellow dots. Buds cinereous. (*Don's Mill.*, iv. p. 56.) A tree, from 20 ft. to 30 ft. high; a native of the south of Europe. Introduced in 1730, and flowering in May and June.

Properties and Uses. This species, the following one, and, probably, all those of both the genera *Fráxinus* and *O'rnus*, extravasate sap, which, when it becomes concrete, is mild and mucilaginous. This sap is produced in more abundance by *O'rnus europæa* and *O. rotundifolia*, than by any other species; and, collected from these trees, it forms an article of commerce under the name of manna. This substance is chiefly collected in Calabria and Sicily; where, according to the *Materia Medica* of Geoffroy, the manna runs of itself from the trunks of some trees, while it does not flow from others unless wounds are made in the bark. Those trees which yield the manna spontaneously grow in the most favourable situations; and the sap runs from them spontaneously only during the greatest heats of summer. It begins to ooze out about mid-day, in the form of a clear liquid, which soon thickens, and continues to appear till the cool of the evening; when it begins to harden into granules, which are scraped off the following morning. When the night has been damp

or rainy, the manna does not harden, but runs to the ground, and is lost. This kind is called manna in tears, or manna lagrimi; and it is as pure and white as the finest sugar. About the end of July, when the liquid ceases to flow of itself, incisions are made through the bark and soft wood; and into these incisions slender pieces of straw or twig are inserted, on which the manna runs, and, coating them over, hardens on them. This is the common manna of the shops, which is thus collected in the form of tubes; and it is called manna in cannoli, or manna cannoli. Another and inferior sort is procured by making an oblong incision in the trees, in July or August, and taking off a piece of the bark about 3 in. in length, and 2 in. in breadth. This kind, which is called manna grassa, is the coarsest; but, as it is produced with least trouble, and in great abundance, it is also the cheapest. Sometimes, instead of cutting out a piece of bark, and leaving the wound open, two horizontal gashes are made, one a little above the other; in the upper of which is inserted the stalk of a maple leaf, the point of the leaf being fixed in the lower gash, so as to form a sort of cup to receive the manna, and to preserve it from dust and other impurities. The greater part of the manna of commerce is procured in the latter manner; and it is imported in chests, in long pieces, or granulated fragments, of a whitish or pale yellow colour, and in some degree transparent. The inferior kind is of a dark brown colour, in adhesive masses, and is moist and unctuous when felt. Manna from the ash has a peculiar odour, and a sweetish taste, accompanied with a slight degree of bitterness. It is considered aperient; was formerly much used in medicine; but is now chiefly used to disguise other drugs in administering them to children. This manna must not be confounded with the manna of the Scripture, which, as already observed (p.646.) is obtained from the *Alhâgi* Maurorum, and is known in the East, in modern times, as the Persian or Syrian manna; or with the Arabian manna, which, Burckhardt tells us, is obtained from the tamarisk. A similar substance is also obtained from the larch in the south of France, where it is known by the name of manne de Briançon. The rhododendron, the walnut, and the beech, also, yield an analogous substance, as, probably, do various other trees; for the sap of most ligneous plants is more or less sweet and mucilaginous; and, consequently, when collected in any quantity, susceptible of becoming concrete by evaporation. The manna of Lebanon is the gum mastic; and the manna of Poland is composed of the seeds of *Glycèria fluitans*. The seeds of *O. europæa* and of *O. (c) rotundifolia* are small, as exhibited in *fig. 1065*; they have an aromatic flavour, and are very generally employed, in Egypt, for seasoning food. (*Dict. Clus. d'Hist. Nat.*; *Nouveau Cours d'Agric.*, &c.) This and the other species of *O'rnus* are commonly



1065

propagated by grafting on *Fraxinus excelsior*; and as the stock in this case is a much more vigorous-growing plant than the scion, when the graft has been made a foot or more above ground, the stock enlarges on every side, so much more than the scion, as to produce the appearance of the base of a column, as in *fig. 1066. c*; and, if, after the scion of *O'rnus* had grown to the height of 20 ft. or 30 ft., it were headed down to 10 ft. or 12 ft. and budded or grafted with the common ash, the scion would enlarge on every side; and if again headed down to within a foot of the second graft, and regrafted with *O'rnus*, the appearance of the capital of a column would be produced, as

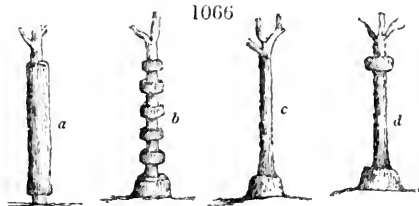

1066

of *fig.* 1066. *d.* If, again, a stock of the common ash were grafted with *O`rnus*, and, after it had grown one year, were headed down to within $1\frac{1}{2}$ ft. or 2 ft. of the graft, and a scion of the common ash inserted; and, at the end of the year, if the shoot produced were grafted with *O`rnus* at the same distance as before, and if this practice were continued, and *O`rnus* and *Fraxinus* grafted alternately at regular distances, till the stem had attained the height of a column, say of 10 ft. or 12 ft., the appearance, after the tree had grown for some years, would be as in *fig.* 1066. *b*; which is what architects call a rusticated column. Again, if *O`rnus* were made the stock, and the common ash grafted on it, and allowed to grow till it attained the height of a column, and if it were then grafted with *O`rnus*, the appearance would be as in *fig.* 1066. *a*, which is that of the Roman fasces, or of a column formed out of spears. The most singular tree of *O`rnus europæa*, perhaps, in Europe, is that noticed by Dr. Neill, as growing in the Leyden Botanic Garden in 1817. In the *Journal of a Horticultural Tour &c.*, p. 153., an engraving is given of this tree, together with its dimensions; and *fig.* 1067. is a copy of this engraving, reduced to a scale of 1 in. to 12 ft. This tree was planted in the time of Boerhaave, and, it is reported, was grafted by the professor himself; it must, therefore, be considerably above 100 years old. Its trunk in 1817 was nearly 12 ft. high; and from the ground to the summit of the branches was about 24 ft. The sloping bark at the junction of the stock and graft was quite smooth and complete all round; a fact, Dr. Neill observes, that would seem to indicate that the stock and graft had originally been nearly adapted to each other with regard to size. "All round the stem are numerous knobs and distorted protuberances, producing the most singular effect. In no place, however, is there any appearance of canker or disease, the bark being every where healthy. The stem is crowned by a thicket of irregular and crowded branches, which form, upon the whole, a fine round head." (*Hort. Tour*, p. 134.) While the revise of this sheet is before us, we have received the dimensions and a portrait of this tree in its present state, through the kindness of Professor Reinwardt of Leyden. It is still a curious tree, but from age and decay considerably different from the figure above given.

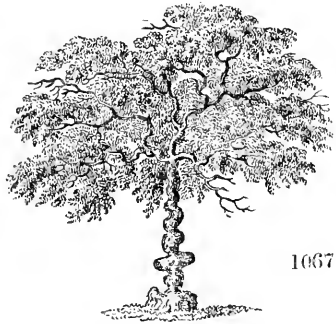

1067

Many oddities of this kind might be produced by the curious gardener. The idea of suggesting them occurred to us some years ago, on seeing a very remarkable specimen in the New Cross Nursery, which has been since removed. There is one at Purser's Cross, and some at Syon; though the largest tree in the latter place (of which an engraving is given in our last Volume) appears to be either a seedling plant, or grafted under the surface of the ground, as no protuberances appear. At Kew, there is one, of which *fig.* 1068. is a sketch (*e* being a view from one side, and *f* a view from the opposite side), which is to our scale of 1 in. to 12 ft. There is also a fine specimen of *O`rnus americana* at Kew, grafted on the common ash; but, as the growth of the two species is nearly alike, there is less difference between the scion and the stock. (See *fig.* 1071. in p. 1245.) At Gunnersbury, the same effect, and to the same extent, has been produced by grafting the variegated on the common sycamore; and, indeed, a similar result may be obtained by grafting any slow-growing tree on a fast-growing one.



1068

Statistics. O`rnus europæa in England. In the environs of London, the largest tree is that at Syon, which is 58 ft. high, and of which a portrait is given in our Third Volume; at Purser's Cross

there is a tree 35 ft. high; another, of the same height, at Ken Wood; and at Kew, one 30 ft. high. South of London, in Devonshire, there is a tree at Endsleigh Cottage, which, in 15 years, has attained the height of 25 ft., with a trunk 9 in. in diameter. In Dorsetshire, at Melbury Park, a tree, 50 years planted, is 36 ft. high. In Surrey, at Bagshot Park, one, 30 years planted, is 20 ft. high. North of London, in Berkshire, at White Knights, a tree, 24 years planted, is 30 ft. high. In Cambridgeshire, in the Cambridge Botanic Garden, one, 40 years planted, is 40 ft. high. In Cheshire, at Kimmel Park, one, 20 years planted, is 24 ft. high. In Oxfordshire, in the Oxford Botanic Garden, a tree, 40 years planted, is 30 ft. high. In Pembrokeshire, at Stackpole Court, there is a tree 70 years planted, and 40 ft. high. In Shropshire, at Willey Park, a tree, 12 years planted, is 21 ft. high. In Worcestershire, at Croomo, a tree, 40 years planted, is 40 ft. high, the diameter of the trunk 22 in., and of the head 25 ft.; at Hagley, 10 years planted, it is 13 ft. high.

Ornus europæa in Scotland. In Ayrshire, at Blair, it is 25 ft. high, with a head 26 ft. in diameter. In Banffshire, at Gordon Castle, it is 26 ft. high. In Clackmannanshire, in the garden of the Dollar Institution, a tree, 12 years planted, is 14 ft. high. In Fifeshire, at Danibristle Park, there is a tree 30 ft. high, with the trunk 14 in. in diameter, and the diameter of the head 30 ft. In Perthshire, in the Perth Nursery, a tree, 25 years planted, is 14 ft. high; the diameter of the trunk 8 in., and of the head 12 ft.

Ornus europæa in Ireland. In the environs of Dublin, at Terenure, 10 years planted, it is only 6 ft. high. In King's County, at Charleville Forest, 50 years planted, it is 34 ft. high. In Louth, at Oriel Temple, a tree, 45 years planted, is 41 ft. high, the diameter of the trunk 1 ft. 2 in., and of the head 35 ft., on clayey soil; it flowers abundantly, but does not form any seed.

Ornus europæa in Foreign Countries. In France, in the Botanic Garden at Toulon, a tree, 40 years planted, is 36 ft. high; at Clerveaux, near Chatelleraut, 29 years planted, it is 29 ft. high. In Holland, in the Botanic Garden at Leyden, is the tree fig. 1067., which is 24 ft. high, the diameter of the stock, or base of the column, is 32 in., and that of the shaft proceeding from it, 16 in. In Austria, at Vienna, in Rosenthal's Nursery, a tree, 14 years planted, is 15 ft. high; at Brüek on the Leytha, one, 45 years planted, is 30 ft. high. In Hanover, at Göttingen, in the Botanic Garden, a tree, 20 years planted, is 16 ft. high.

‡ 2. *O. (E.) ROTUNDFOLIATA Pers.* The round-leafted Flowering, or *Manna*, Ash.

Identification. Pers. Ench., 2. p. 605; Don's Mill., 4. p. 57.

Synonymes. *Fraxinus rotundifolia* Ait. Hort. Kew., 3. p. 445., *Fabl Enum.*, 1. p. 49., *Willd. Sp.*, 4. p. 1105., *Willd. Baum.*, p. 145. t. 2. f. 1.; *F. mannifera* Hort., *Pluk. Alm.*, 182. f. 4., *Bauh. Hist.*, 1. p. 177. t. 2.

Engravings. Willd. Baum., t. 2. f. 1.; Pluk. Alm., p. 4.; Bauh. Hist., 1. f. 2.; and our fig. 1069.

Spec. Char., &c. Leaves with 3—5 pairs of roundish-ovate, bluntly serrated, almost sessile leaflets, which are narrow at the base, rather small, and glabrous. Petioles channeled. Flowers with purplish petals, polygamous. Peduncles axillary. Branches and buds brown. The flowers come out in the spring, before the leaves, like those of other species of this genus, as well as of that of *Fraxinus*. (*Don's Mill.*, iv. p. 57.) A tree, native to Calabria and the Levant, &c., where it grows to the height of from 16 ft. to 20 ft. It flowers in April, and was introduced into Britain in 1697, where it attains the height of 30 ft. or 40 ft. What has been said of *O. europæa* may be considered as applicable to this which, we have no doubt whatever, is only a variety of it.



1069

‡ 3. *O. (E.) AMERICANA Pursh.* The American Flowering Ash.

Identification. Pursh Fl. Amer. Sept., 1. p. 9.; Nutt. Gen. Amer. 1. p. 6.; Don's Mill., 4. p. 57.

Synonymes. *F. americana* Linn. Sp., 1510. ?; *F. Ornus americana* Lodd. Cat., ed. 1836.

Engravings. Our fig. 1070.

Spec. Char., &c. Leaves with 2—5 pairs of oblong or ovate-acuminated, shining, serrated leaflets, each 3—5 in. long, and 2 in. broad, and having the larger veins rather villous, glaucous, and paler beneath, the odd one rather cordate. Flowers with petals, disposed in terminal panicles. Branches brownish grey. Buds brown. Samara narrow, obtuse,



1070

mucronate. (*Don's Mill.*, iv. p. 57.) A tree, a native of North America, where it grows from 30 ft. to 40 ft. high. It flowers in April and May, and was introduced in 1820. The difference between this sort and *O. europæa* is so very slight, that we have no doubt of their being only one species. There are plants in the Horticultural Society's Garden, in the arboretum of Messrs. Loddiges, and in the arboretum at Kew. The tree at Kew is grafted on the common ash; and *fig.* 1071. represents two views of the trunk, to a scale of 1 in. to 12 ft. The point where the scion was inserted in the stock is indicated at *g*, and the circumstance that the former has enlarged nearly as much as the latter, is a proof that *O. (e.) americana* is a more robust-growing plant than *O. europæa*; but by no means that it is a different species. When no other mode can be obtained of rendering a tree gardenesque, that of giving the trunk an architectural base, by grafting a slow-growing on a fast-growing species, may be resorted to with success. Perhaps, also, the application of the art of grafting might be worth adopting for certain ornamental trees to be planted in exposed situations; for the architectural base is strongly expressive of stability.



1071

‡ 4. *O. FLORIBUNDA* G. Don. The abundant-flowered Flowering Ash.

Identification. G. Don in Loud. Hort. Brit., p. 12; Don's Mill., 4. p. 57.

Synonyme. *Fraxinus floribunda* D. Don *Prod. Fl. Nep.*, p. 106., *Wall. Fl. Ind.*, 1. p. 150., *Pl.*

Rar. Asiat., 3. t. 277.

Engravings. *Wall. Pl. Rar. Asiat.*, 2. t. 277.; and our *fig.* 1072.

Spec. Char., &c. Leaves with 2—3 pairs of elliptic-oblong, acuminate, serrated, glabrous, stalked leaflets, and an odd one, varying much in figure, the terminal, or odd, one the largest. Panicles terminal, compound, thyrsoid. Petals linear, clavate (ex *Wall.*); oval, oblong, obtuse (ex *D. Don.*). Samara linear, or narrow-spathulate, obtuse, entire. Bark ash-coloured, dotted. Branchlets compressed. Flowers white. (*Don's Mill.*, iv. p. 75.) A tree, a native of Nepal, where it grows to the height of 30 ft. or 40 ft. It flowers in April, and was introduced



1072

in 1822. There was a plant of this species in the Horticultural Society's Garden, against the conservative wall, which died in the spring of 1836. Notwithstanding the tenderness of this species, we do not see any thing in that circumstance to prevent it from being merely a geographical variety of *O'rnus americana* or *O. europæa*. Though nothing can alter the nature of a plant, yet physical circumstances may to a considerable extent alter its habits, and even its constitution. The common European ash, if cultivated in the Himalayas, would, after many generations, in all probability become as tender as *O. floribunda*; and, in like manner, *O. floribunda*, after being cultivated for several generations in Europe, would in all probability become as hardy as *O. europæa*.

‡ 5. *O. STRIATA* Swt. The striped-barked Flowering Ash.

Identification. Swt. Hort. Brit., p. 256; Don's Mill., 4. p. 57.

Synonymy. *Fraxinus striata* Bosc ex Spreng. Syst., 1. p. 95.

Spec. Char., &c. Leaves with 7 pairs of leaflets, which are villous beneath, as well as the petioles, and oblong, petiolulate, acute, toothed. Buds green. Branches striated. (*Don's Mill.*, iv. p. 57.) A tree, a native of North America, where it grows to the height of 30 ft. It flowers in April and May, and was introduced in 1818. We have not seen this sort.

App. i. *Hardy Species of O'rms not yet introduced.*

O. xanthoxyloides G. Don; *Fraxinus xanthoxyloides* Wall. Cat., No. 2833; has the leaves pinnate; and 5 leaflets, which are small, oblong, tapering to the base, with the apex crenated, and almost sessile. Flowers lateral, aggregate. Fruit lateral, aggregate. Samaras with emarginate wings. A tree, native to Sirinaghur.

O. Moorcroftiana G. Don; *Fraxinus Moorcroftiana* Wall. Cat., No. 2834; has the leaves pinnate; and leaflets, which are 5, oblong, acuminate at both ends, glabrous, almost sessile, paler beneath, finely denticulated, the odd one the largest. Fruit disposed in simple, aggregate, lateral racemes. Samara with an emarginate wing, furnished with a little point in the centre of the notch. A tree, native to Luddac, in the East Indies.

O. urophylla G. Don; *Fraxinus urophylla* Wall. Cat., No. 2835. Leaves pinnate, on long petioles. Leaflets 5-7, on long petiolules, membranous, ovate-oblong, long-acuminate, serrated. Peduncles panicled, axillary. Flowers much smaller than those of *O. floribunda*. A tree, native to Silhet, on the Pundua Mountains. (*Don's Mill.*, iv. p. 57.)

App. ii. *Alphabetical List of the Sorts of Fraxinus and O'rms in the Arboretum of Messrs. Loddiges, and in the Horticultural Society's Garden, with their Names referred to the different Species to which they are presumed to belong.*

The names which are applied to the same plants in the Hackney and Chiswick collections, and in the *Arboretum Britannicum*, are in small capitals; and those of which there are plants in the Chiswick Garden, but not in the Hackney arboretum, have the letters H. S. placed after them.

Names in the Hackney Arboretum, and in the Hort. Soc. Garden.	Identifications, or names of species and varieties to which the plants belong.	Names in the Hackney Arboretum, and in the Hort. Soc. Garden.	Identifications, or names of species and varieties to which the plants belong.
<i>F. acuminata</i> .	<i>F. americana acuminata</i> .	<i>F. juglandifolia</i> .	<i>F. am. juglandifolia</i> .
<i>amarissima</i> .	<i>excelsior parvifolia</i> .	<i>lancea</i> .	<i>lancea</i> .
AMERICA'NA.	AMERICA'NA.	ZENTISCIFOLIA.	ZENTISCIFOLIA.
alba var., H.S.	var.	PE'NDULA.	PE'NDULA.
alba affinis, H.S.	var.	LI'VIDA.	am. lucida.
glabra, H.S.	var.	lucida opaca, H.S.	
LATIFOLIA.	LATIFOLIA.	lyrata.	lyrata.
ovalis, H.S.	var.	microphylla, H.S.	am. var.
retusa, H.S.	var.	monophylla, H.S.	ex. heterophylla.
angustifolia, H.S.	excelsior var.	nana, H.S.	nana.
argentea.	parvifolia.	nigra.	am. nigra.
atrovirens.	atrovirens.	O'rms.	<i>O. europæa</i> .
caroliniana.	am. caroliniana.	<i>O. americana</i> .	(c.) americana.
mollis, H.S.	var.	europæa, H.S.	europæa.
alba var., H.S.	var.	globifera.	(c.) var.
latifolia, H.S.	var.	latifolia, H.S.	(c.) latifolia.
cindrea.	cindrea.	ovata.	<i>F. ovata</i> .
crispa, H.S.	excelsior var.	oxycarpa.	ex. parvifolia.
curvidens.	am. curvidens.	oxyphylla.	parvifolia.
elliptica.	elliptica.	oxyphylla Stevens.	parvifolia.
epiptera.	epiptera.	pallida.	parvifolia var.
EXCELSIOR.	EXCELSIOR.	pannosa.	am. pannosa.
ANGUSTIFOLIA,	ANGUSTIFOLIA.	parvifolia.	ex. parvifolia.
H.S.		parvifolia var.	parvifolia.
argentea, H.S.	foliis argenteis.	parvifolia major, H.S.	parvifolia.
atrovirens, H.S.	excelsior var.	pendula, H.S.	pendula.
ahrea.	parvifolia.	pennsylvanica.	am. pennsylvanica.
FOL. ARGE'NT.	parvifolia.	platycarpa.	platycarpa.
FUNGO'SA.	FI'NGO'SA.	polemoniifolia.	polemoniifolia.
HORIZONTA'LIS.	HORIZONTA'LIS.	pubescens, H.S.	pubescens.
JASPI'DEA.	JASPI'DEA.	pubescens longifolia.	pubescens longifolia.
NA'NA.	NA'NA.	parvifolia.	parvifolia.
nigra, H.S.	var.	virens, H.S.	
pallida, H.S.	var.	quadrangularis.	am. quadrangularata.
PE'NDULA.	PE'NDULA.	quadrangularata, H.S.	quadrangularata.
striped bark, H.S.	jaspidea.	quadrangularis ner-	quadrangularata ner-
undulata, H.S.	var.	vosa.	vosa.
VERRUCO'SA.	VERRUCO'SA.	retusa.	retusa.
VERRUCO'SA PE'N-	VERRUCO'SA PE'N-	Richardi.	Richardi.
DULA, H.S.	DULA.	rotundifolia.	ex. parvifolia.
VERTICILLA'TA.	VERTICILLA'TA.	salicifolia.	salicifolia.
expansa.	expansa.	sambucifolia.	am. sambucifolia.
floribunda, H.S.	O'rms floribunda.	crispa.	var.
fusca, H.S.	<i>F. am. var.</i>	simplicifolia.	ex. heterophylla.
glauca.	glauca.	Theophrasti.	am. Theophrasti.
heterophylla, H.S.	ex. heterophylla.	virens.	ex. parvifolia.
horizontalis, H.S.	ex. var.	viridis.	viridis.

CHAP. LXXVI.

OF THE HARDY AND HALF-HARDY LIGNEOUS PLANTS OF THE
ORDER JASMINACEÆ.

GENUS I.



JASMINUM Forskoel. THE JASMINÆ. *Lin. Syst.* Diándria Monogýnia.

Identification. Forskoel *Egypt. Arab.*, p. 59; Dodon. *Pempt.*, p. 1557; Tourn. *Inst.*, 368; *Lin. Gen.*, No. 17; Juss. *Gen.*, 106; R. Br. *Prod.*, p. 521; *Gärtn. Fruct.*, 1. p. 196. t. 42; *Lam. Ill.*, t. 7; *Lindl. Nat. Syst. Bot.*, 2d edit., p. 369; *Don's Mill.*, 4. p. 59.

Synonymes. *Mongorium* Lam.; *Jessamine*; *Jasmin*, *Fr.* and *Ger.*; *Schasmin*, *Ger.*; *Gelsomine*, *Ital.*; *Jazmin*, *Span.*

Derivation. Linnaeus derives this name from *jon*, a violet, and *asmē*, smell; but the scent of the flowers has no resemblance to that of the violet. Forskoel, in his *Egypt. Arab.*, p. 59, says that it is taken from the Arabian name of the plant, *Ismyin*, which appears much more probable.

Gen. Char., &c. *Calyx* tubular, 5—8-toothed or 5—8-cleft. *Corolla* 5—8-cleft. *Stigma* 2-lobed or bifid. *Berry* didymous, having one of the lobes usually abortive. *Seeds* without albumen. (*Don's Mill.*, iv. p. 59.)—Twining or rambling shrubs. Leaves simple or compound, mostly evergreen. Petioles articulated. Flowers white or yellow, odoriferous. Propagated readily by cuttings in common garden soil, and usually grown against walls.

♣ 1. *J. FRUTICANS* L. The sprig-producing, or shrubby, Jasmine.

Identification. *Lin. Sp.*, 1. p. 9; *Syst.*, ed. 14; *Vahl Enum.*, 1. p. 33; *Don's Mill.*, 4. p. 63.

Synonyme. *J. heterophyllum* March, *Lab. Adv.*, p. 289. t. 200.

Engravings. *Bot. Mag.*, 13. t. 461; *Schmidt Baum.*, 3. t. 148; and our fig. 1073.

Spec. Char., &c. Leaves alternate, trifoliate, and simple, glabrous; leaflets obovate or cuneiform, obtuse. Branches angular. Calycine segments subulate. Peduncles terminal, by threes. Corolla yellow, with oblong obtuse segments. (*Don's Mill.*, iv. p. 63.) A shrub, a native of the south of Europe, and throughout the Levant, where it grows from 6 ft. to 8 ft. high, and flowers from May till October. It was introduced in 1570, and is frequent in British gardens, where it forms a very desirable subevergreen, either for planting in borders, or against walls; flowering freely, and ripening abundance of fruit, which is black when ripe. It sends up numerous suckers; which, when it is desired that the plant should assume a gardenesque character, should all be removed, leaving the branches to proceed from a single stem, or from two, three, or any other small and limited number of stems. On the other hand, when the plant is intended to assume a picturesque or natural habit, it should be allowed to throw up suckers, unlimited by any thing but the circumstances in which it is placed with reference to soil and other plants. In the last character, it is a very suitable plant for the front of a picturesque or wild-looking shrubbery. Plants of this species, in the London nurseries, are 25s. a hundred; at Bollwyller, half a franc per plant; and at New York, 50 cents each.



1073

+

Variety. A semi-double flower has been observed on a plant of this species, in a garden in Suffolk, but we are not aware that it has been propagated. The existence of double-flowered varieties of *J. Sambac* and *J. officinale* shows a tendency in this genus to vary into double flowers.

✱ 2. *J. HUMILE* L. The humble, or Italian yellow, Jasmine.

Identification. Lin. Sp., 1. p. 9. ; Vahl Enum., 1. p. 33. ; Don's Mill., 4. p. 63. ; Lodd. Cat., ed. 1836. *Engravings.* Bot. Reg., t. 350. ; Besl. Eyst., 40. f. 2. ; Knor. Thes., 1. t. 1. ; Schmidt Baum., t. 149. ; and our fig. 1074.

Spec. Char., &c. Leaves alternate, acute, trifoliolate, and pinnate. Branches angular. Calycine segments very short. Plant glabrous. Peduncles terminal, twin, or ternary, 3-flowered. Corolla yellow, with oblong obtuse segments. (*Don's Mill.*, iv. p. 63.) An erect shrub, a native of Madeira, where it grows 3 ft. or 4 ft. high, and flowers from June till September. It was introduced in 1656, and is not unfrequent in collections, being annually imported from Genoa, with the orange tree ; and hence it is frequently called the Italian yellow jasmine. There are vigorous-growing plants of this species in the Horticultural Society's Garden, and in the Hammersmith Nursery. Price 1s. 6d. or 2s. per plant.



✱ 3. *J. HETEROPHYLLUM* Roxb. The various-leaved Jasmine.

Identification. Roxb. Fl. Ind., 1. p. 99. and 164. ; Don's Mill., 4. p. 63. *Synonymes.* *J. arboreum* Hamilt. MSS. In Nepal it is called Goojee and Javana. *Engravings.* Wall. Pl. Asiat. Rar., 3. t. 275. ; and our fig. 1075.

Spec. Char., &c. Arboreous. Leaves alternate, simple or trifoliolate, oblong-elliptic or broad-ovate, acuminate, waved, lucid, firm, glabrous. Panicles terminal, trichotomous, fastigate, corymbose, downy. Calyx urceolate, with short subulate teeth. Segments of the corolla oblong, equal to the tube in length. Leaves varying in size and form. (*Don's Mill.*, iv. p. 63.) This species, in its native country (Nepal), grows to a middle-sized tree, with long round branches, which have a tendency to become rambling. In British gardens, into which it was introduced in 1820, it is always planted against a wall ; and it appears to be as hardy as *J. revolutum*, the next species. Plants against the wall, in the Horticultural Society's Garden, have stood out since 1832, and have flowered freely. The flowers are very numerous, of a bright yellow, and fragrant.



✱ 4. *J. REVOLUTUM* Ker. The revolute-flowered Jasmine.

Identification. Ker Bot. Reg., t. 173. ; Sims Bot. Mag., t. 1731. ; Don's Mill., 4. p. 64. ; Lodd. Cat., ed. 1836.

Synonymes. *J. chrysanthemum* Roxb. Fl. Ind., 1. p. 93. ; the Nepal yellow Jasmine. *Engravings.* Bot. Reg., t. 178. ; Bot. Mag., t. 1731. ; Bot. Cab., t. 966. ; and our fig. 1076.

Spec. Char., &c. Leaves alternate, pinnate. Leaflets 5—7, ovate-lanceolate or elliptic, glabrous, on short petiolules. Corymbs terminal, compound. Calycine teeth very short, mucronate. Branches angular, glabrous. Leaves shining, and flowers bright and yellow, and very fragrant. (*Don's Mill.*, iv. p. 64.) A rambling shrub, a native of the mountainous countries north of Hindostan and of Nepal. Introduced in 1812, and producing its bright

yellow, very fragrant, flowers from May to October. In British gardens, it was for some time after its first introduction kept in the greenhouse, or conservatory, but it is now commonly treated as a wall shrub, where it has attained the height of 15 ft., and it appears to be nearly as hardy as any species of the genus. It is readily propagated by cuttings, and is a fine grower and flowerer in any common soil and exposure. There are splendid plants of it against the conservative wall in the London Horticultural Society's Garden. Plants, in the London nurseries, are 1s. 6d. each; at New York, one dollar.



■ 5. *J. (R) PIBIGERUM D. Don.* The downy *Nepal Jasmine*.

Identification. D. Don Prod. Fl. Nep., p. 106; Don's Mill., 4. p. 64.
Synonymes. *J. Walliehinum* Lindl. Bot. Reg., t. 1409; Climali-swa, *Nepalce*.
Engravings. Bot. Reg., t. 1409.; and our fig. 1077.

Spec. Char., &c. Leaves alternate, pinnate. Leaflets 7—9; ovate-lanceolate or oblong, acuminate, sessile, downy while young. Branches angular, downy. Peduncles elongated, 1-flowered, terminal, subcorymbose, downy. Teeth of calyx short. Segments of corolla 5—6, obtuse. Flowers yellow, and smaller than those of *J. revolutum*. (*Don's Mill.*, iv. p. 64.) This sort so closely resembles the preceding one, that we cannot doubt its being only a variety of it. There is a very large plant of it in the Horticultural Society's Garden, which has stood out on the same wall with *J. revolutum* since 1832. Introduced in 1827, and growing so vigorously in British gardens, as sometimes to make a shoot 6 ft. or more long in one season. It is readily propagated by cuttings, and the price of plants is about the same as that for *J. revolutum*, viz., from 1s. 6d. to 2s. each.



⊞ 6. *J. OFFICINALE L.* The officinal, or common, *Jasmine*.

Identification. Lin. Sp., l. p. 9; Vahl Enum., 1. p. 34; Don's Mill., 4. p. 63.; Lodd. Cat., ed. 1836.
Engravings. Bot. Mag., t. 31.; Lam. Ill., t. 7. f. 1.; Bull. Herb., t. 231.; Schmidt Baum., 3. t. 150.; and our fig. 1078.

Spec. Char. Leaves opposite, pinnate; leaflets ovate, acuminate, terminal one longest. Young buds erectish. Plant glabrous. Branches angular. Calycine segments 5, subulate. Corolla white, 4—5-cleft, sweet-scented. (*Don's Mill.*, iv. p. 63.)

Varieties.

⊞ 1. *J. o. 2 foliis argenteis* Lodd. Cat. has the leaves striped with white.

⊞ 2. *J. o. 3 foliis aureis* Lodd. Cat. has the leaves striped with yellow.

⊞ 3. *J. o. 4 floribus plenis* Hort. has the flowers double, but is very rare.

Description, &c. A climbing shrub, a native of Asia, from the coast of Malabar to Georgia; growing abundantly at the foot of Mount Caucasus, in woods. It generally loses its leaves in the winter season, especially in exposed situations; but, as its young shoots are of a fine deep green, and the plant is generally covered with them, it has the appearance at that season of an evergreen. The shoots are frequently produced 7 ft. or 8 ft. in length, and upwards. It is uncertain when it was introduced into Europe; but it has

been cultivated in the gardens of convents from time immemorial; and it is naturalised in the southern valleys of Switzerland, particularly in the neighbourhood of Aigle. It was so common in British gardens in the time of Gerard, that "Master Lyte" thought it was indigenous. It is to be found in gardens, and against houses, in every part of Europe, from the Mediterranean, as far north as Warsaw; where, however, it requires the green-house during winter. It flowers, more especially in moist seasons, or when supplied with water, from the end of May till October; but, like many other plants prolific in side-suckers, it very seldom produces fruit, even in the south of France and Spain. This year, 1836, there are a few fruit, with perfect seeds, on our plant, at Bayswater.



1078

Properties and Uses. The flowers are highly odoriferous; and, though they do not yield an oil, yet they are much employed, in France and Italy, to communicate their odour both to oils and spirits; and, sometimes, also to powdered sugar. This is effected in the following manner:— Small flasks of cotton are moistened with the oil of ben (an oil drawn from the seeds of *Moringa pterygospërma* Dec., the horseradish tree, a native of the East Indies), or with any other oil not liable to become rancid. Layers of these pieces of cotton are placed between layers of flowers for twenty-four hours, when the cotton is removed; and the oil, being separated from it by expression, is found to be highly aromatic. This oil, put into pure spirit, gives out its odour to it; and the oil being separated, the spirit remains, having imbibed the odour of the jasmine. Powdered sugar, in layers, placed between layers of blossoms, becomes impregnated with the odour in the same manner as the oiled cotton; and the sugar may be afterwards used to flavour various articles, either in a dry state, or in the form of syrup. In every case, the article impregnated with the flavour of the jasmine requires to be kept in vessels closely stopped; because the odour soon evaporates by exposure to the air. These operations may be performed with all the odoriferous species of jasmine; and, indeed, with all odoriferous flowers whatever. The great use of the jasmine, in British gardens, is as a shrub for covering walls, arbours, &c.; for which purpose it may be truly said to be invaluable. It is always green, by its leaves in summer, and by the colour of its young wood in winter; and it is an abundant flowerer. Its flowers are produced during the greater part of summer; they are of an elegant shape, a pure white, and are highly odoriferous. Evelyn, alluding to its flowers, says that, if they were as much employed in England as in Italy and France, our gardeners might make money enough of them. "One sorry tree in Paris," he adds, "has been worth, to a poor woman, near a pistole a year." In the present day, the plant is still a great favourite with the French. The Parisian gardeners train the plants to a single stem in pots and boxes, and expose them all the year in the flower-markets, where they find customers among all ranks. Such is the rapid growth of this plant, that, when once firmly established in good soil, it will make shoots from 10 ft. to 20 ft. long in one season. These shoots, when of 2 years' or 3 years' growth, are used in Greece and Turkey as tubes to tobacco-pipes; and they may be seen, in Constantinople, 8 ft. or 10 ft. long, twisted in various ways. The plant will endure the smoke of London almost as well as the ivy and the aucuba, but it does not blossom so freely among coal smoke as in a purer air. In Paris, it may be found beautifully in flower in back courts, and on the balconies, sills, or outsides of windows, in the most confined parts of the town. A very striking application of this shrub is, to train it up a strong cast-iron rod 20 ft. high, with an umbrella head 8 ft. or 10 ft. in diameter; and, after the head has been covered with shoots, to allow them to droop down on every side to the ground. This is, also, a very pleasing mode of covering the roofs of

cottages, allowing the shoots to droop down on every side like curtains, and drawing them back from the windows in a similar manner to what is done with drapery.

Historical, poetical, and legendary Allusions. The jasmine (of which Cowper observes, —

“ The deep dark green of whose unvarnish'd leaf
Makes more conspicuous, and illumines the more,
The bright profusion of her scatter'd stars, ”)

has been frequently celebrated by the poets; and several of them have alluded to the custom which prevails in some countries, of brides wearing jasmine flowers in their hair when they are married. The origin of the custom is said to be, that a grand-duke of Tuscany had, in 1699, a plant of the deliciously scented jasmine of Goa (*J. odoratissimum*), which he was so careful of, that he would not suffer it to be propagated. His gardener, however, being in love with a peasant girl in the neighbourhood, gave her a sprig of this choice plant on her birthday; and he having taught her how to make cuttings, she planted the sprig as a memorial of his affection. It grew rapidly, and every one who saw it, admiring its beauty and sweetness, wished to have a plant of it. These the girl supplied from cuttings, and sold them so well, as to obtain enough money to enable her to marry her lover. “ The young girls of Tuscany, in remembrance of this adventure, always deck themselves, on their wedding-day, with a nosegay of jessamine; and they have a proverb, that ‘ she who is worthy to wear a nosegay of jessamine, is as good as a fortune to her husband.’ ” (*Sentiment of Flowers*, p. 8.) This custom, however, appears to prevail, also, in the East, according to Moore: —

“ And brides, as delicate and fair
As the white jasmine flowers they wear,
Hath Yemen in her blissful clime.”

The flower alluded to in the beautiful lines below, also by Moore, is *J. Sambac*, a hot-house plant, but, which like many other tender shrubs, might be turned out to blossom for the summer.

“ ’Twas midnight — through the lattice, wreathed
With woodbine, many a perfume breathed,
From plants that wake when others sleep,
From timid jasmine buds, that keep
Their odour to themselves all day,
But, when the sunlight dies away,
Let the delicious secret out
To every breeze that roams about.”

Propagation and Culture. The common jasmine throws up side-suckers in great abundance; by which, by layers, or even by cuttings, it is readily propagated. The double-blossomed variety is rare, and is generally propagated by budding on the species. When it is desired to turn a green jasmine into a variegated one, a single bud of either the silver-leaved, or the golden-leaved, will communicate its variegation to every part of the plant, even to suckers thrown up by the roots. This has been done in the Chelsea Botanic Garden; and we are informed by Mr. Pince of Exeter, that the same result takes place with the variegated laburnum, even if the bud should die, provided a portion of the bark to which it was attached continues to live. We have little doubt that the same thing would take place in the jasmine, and, doubtless, in various other plants.

Insects. That very remarkable lepidopterous in-

1079

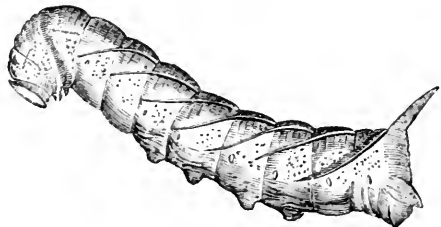

1080

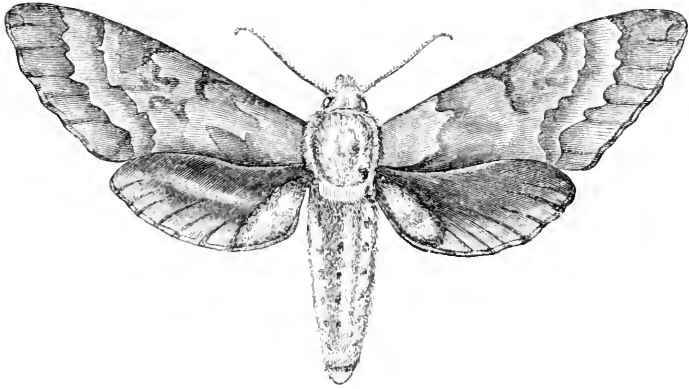

sect, the death's head hawk moth (*Acherontia A'tropos* Fab.), feeds, in the larva state (see *fig.* 1081. *a*), indiscriminately on the different species of jasmine, and on the leaves of the potato. When the perfect insect is captured, it sometimes utters a shrill cry, by the friction of the palpi on the trunk; but, in the opinion of M. Savi, by the escape of air from two cavities in the abdomen. It makes its appearance during autumn, and is very difficult to

1081

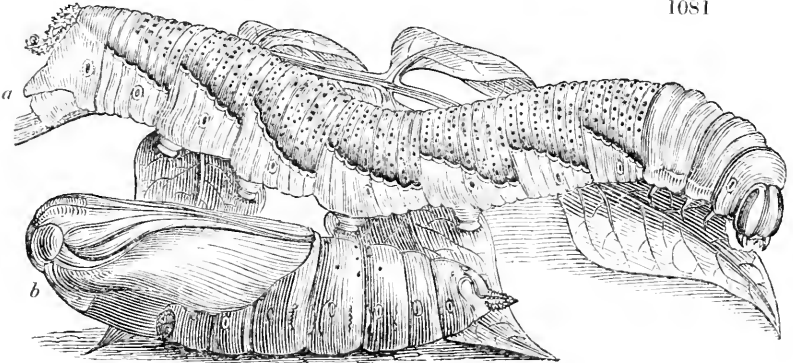

rear beyond the pupa state (*b*). It is indigenous throughout great part of Europe, and also in Africa and India. *Sphinx jasminearum*, of which *fig.* 1079. is the larva, and *fig.* 1080. the perfect insect, also feeds on all the various species of the genus.

Statistics. The largest plant of the *Jasminum officinale* that we recollect having seen was at Cobham Hall, in Kent; where, in 1826, a plant covered great part of one of the fronts of the mansion, and must, at least, have been 50 ft. high. The price of plants, in the London nurseries, of the species, is 2*s.* per hundred; and the varieties, from 1*s.* 6*d.* to 2*s.* 6*d.* per plant: at Bollwyller 30 cents: and at New York, 37½ cents each.

App. i. *Hardy Species of Jasminum not yet introduced.*

J. aureum D. Don, *G. Don's Mill.*, iv. p. 63., is a native of Nepal, with pinnate leaves, which are opposite, and have from 9 to 11 leaflets. The flowers are of a golden yellow.

J. nervosum Lour., *Don's Mill.*, iv. p. 63., is a native of Cochín-China, with pinnate, alternate leaves, and ovate three-nerved leaflets. The flowers are white, and without scent.

App. ii. *Half-hardy Species of Jasmīnum.*

J. odoratissimum L., the Jasmine of Goa (*Bot. Mag.*, t. 285.), is a well-known inhabitant of the green-house; and, being a native of Madeira, it may be kept through the winter in a pit, or against a conservative wall. The flowers are yellow, and extremely odoriferous.

J. glaucum Vahl is a native of the Cape of Good Hope, with lanceolate leaflets like the leaves of the privet, and white flowers resembling those of *J. officinale*, but longer.

J. azoricum Vahl (*Bot. Mag.*, t. 1889.) is a native of the Azores and Madeira, with trifoliolate leaves, and white flowers. The shoots twine, as well as climb; and the plant is, doubtless, half-hardy.

CHAP. LXXVII.

OF THE HARDY AND HALF-HARDY LIGNEOUS PLANTS OF THE
ORDER APOCYNACEÆ.

GENUS I.

*VINCA* L. THE PERIWINKLE. *Lin. Syst.* Pentándria Monogýnia.

Identification. *Lin. Gen.*, No. 295.; *Juss.*, 144.; *Lindl. Nat. Syst. Bot.*, 2d edit., p. 301.; *Don's Mill.*, 4. p. 95.

Synonymes. *Pervinca Tourn.*, t. 45.; *la Pervenche, Fr.*; *Sunngrün, Ger.*

Derivation. In *Don's Miller*, this word is said to be derived from *vinco*, to conquer; because the species subdue other plants by their creeping roots, or bind them by their runners; but a much better origin seems to be from *vinculum*, a band, on account of the suitableness of the shoots for the purpose of making bands.

Gen. Char., &c. *Calyx* 5-cleft; segments linear or subulate, acute. *Corolla* salver-shaped; tube longer than the calyx; throat bearded; segments of the limb flat, oblique, truncate at the apex. *Stamens* 5, inserted in the throat, enclosed. *Filaments* short. *Anthers* ending each in a hairy membrane at the apex, which connive over the stigma. *Stigma* bearded, seated on a flat orbicular disk, which is grooved round the circumference. *Glands* 2, alternating with the ovaries, glabrous, as well as they. *Follicles* 2, erect, terete, narrow, dehiscing lengthwise, few-seeded. *Seeds* cylindrical, naked. *Albumen* fleshy. (*Don's Mill.*, iv. p. 95.)—The hardy ligneous species are creeping evergreens; natives of Europe, in shady places; of the easiest culture; and readily propagated by division, layers, or cuttings.

♣ 1. *V. MAJOR* L. The greater Periwinkle.

Identification. *Lin. Sp.*, p. 304.; *Don's Mill.*, 4. p. 95.; *Lodd. Cat.*, ed. 1836.

Synonymes. *Vinca media Delile*; *Pervinca major Scop. Carn.*, No. 274., *Garid. Aix*, t. 81., *Lob. Icon.*, t. 636.

Engravings. *Eng. Bot.*, t. 514.; *Curt. Lond.*, 4. t. 19.; *Plenck Icon.*, t. 114.; *Baxt. Brit. Fl. Pl.*, vol. 2. t. 158.; and our *figs.* 1082, 1083.

Spec. Char., &c. Stems erectish. Leaves ovate, acute, ciliated. Calycine teeth linear-subulate, ciliated, usually with a small tooth on each side at the base. Segments of corolla broad, obovate. This species is larger in all its parts than the preceding. Corollas fine purplish blue. Flowering stems erect; barren ones trailing. There is a variety of this with variegated leaves. (*Don's Mill.*, iv. p. 95.) A low, trailing or creeping, suffruticose evergreen; a native of the middle and south of Europe, and apparently wild in some parts of Britain. It grows as high as 2 ft., forming a dense dark green, low, trailing bush, growing freely under the shade of other trees; and producing its fine blue flowers from March to September.

Variety.

♣ *V. m. 2 variegata* Hort. has the leaves variegated with white and yellow.

Description, &c. The periwinkle is a trailing evergreen, which produces its beautiful blue flowers all the summer, and is admirably adapted for covering the dug ground in shrubberies, and the banks of hedgerows, as it prefers a shady situation. It is supposed to have been known to the Greeks, and to be the plant that was called by them *Klematis*, from its creeping branches; it being thought that the *Klematis daphnoides* of Dioscorides was the same as the *Vinca Pervinca* of Pliny. It is found wild in the forests of France, Spain, Italy, Switzerland, and other parts of Europe; and



1082

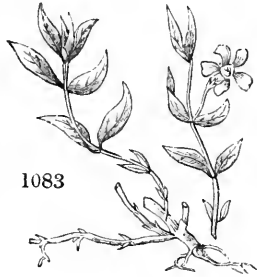

1083

is more abundant in Britain than *V. minor*, though both are supposed to have become naturalised, rather than to be really indigenous. In the middle ages, many curious medical virtues were attributed to this plant; the most amusing of which is that mentioned by Culpepper, that “The leaves of the periwinkle, eaten by man and wife together, do cause love between them.” The principal use of the plant, in modern times, is to cover the dug ground of shrubberies; but, in France, a beautiful fence for flower-gardens is frequently made of it, by training its branches over low palisades or espaliers, taking care to tie them in different places; as, wherever the plant is left at liberty, it will root into the ground. In some parts of Italy, these fences are called *centocchio*, or hundred eyes; a name also given to the flower: but in some other parts of that country the periwinkle is called *fiore di morte*, from the custom which prevails of making garlands of it for dead children. The French call it *violette des sorciers*, from an ancient prejudice that it was used by sorcerers in their incantations. The ancient name of this flower, in England, was *pervinkè*; and it is spoken of under that name by Chaucer:—

“There sprange the violet al newe,
And fresh pervinkè, rich of hewe.”

Few modern British poets seem to have mentioned it, probably from the inharmoniousness and unmanageableness of its modern name. Wordsworth, however, says,—

“Through primrose tufts, in that sweet bower,
The fair periwinkle trailed its wreaths;
And ’t is my faith that every flower
Enjoys the air that breathes.”

Rousseau’s anecdote of this flower is well known. He tells us that he was walking with Madame de Warens, at Charmettes, when she suddenly exclaimed, “There is the periwinkle still in flower.” Rousseau, being short-sighted, had never before observed this flower, which always grows near the ground; and, stooping down, he gazed at it with pleasure. He did not see it again for 30 years; when, being at Gressier, and climbing a hill, with M. Peyrou, he observed something blue among the bushes; and, stooping down to examine it, he uttered, with a cry of joy, “Voilà la pervenche!” and all the tender emotions of the moment when he first saw it rushed back upon his mind. Hence the plant, in France, is consecrated “*Aux doux souvenirs* ;” and is generally planted near a monumental urn, or other ornament or building, dedicated to the remembrance of a friend. The propagation of the periwinkle is very easy; as, though it is seldom raised from seeds, yet the trailing stems of the plant take root freely; chiefly at their tips, or points, in the same manner as those of the bramble or the strawberry. The plant may also be increased by dividing it at the roots. The periwinkle, when wanted to produce ripe seeds, does best when planted in a pot with very little earth, and the lateral shoots cut off.

✻ 2. *V. MINOR* L. The less Periwinkle.

Identification. Lin. Sp., 304.; Don's Mill., 4. p. 95.; Lodd. Cat., ed. 1836.

Synonymes. *Perivnca minor* Scop. Carn., No. 273.; *Perivnca vulgaris* Park. *Theatr.*, 311. f. 1.; *Clématis daphnoides* Dodon. *Pempt.*, 401.

Engravings. Engl. Bot., t. 917.; Curt. Lond., 3. t. 16.; Plenck Icon., t. 183.; Blackw., t. 39.; Hayne Abbild., t. 26.; and our fig. 1084.

Spec. Char., &c. Stems procumbent. Leaves elliptic-lanceolate, glabrous. Calycine segments linear-lanceolate, bluntish. Segments of corolla broadish at top. Flowering stems usually erect. Flowers void of scent. Corolla blue, with white throat, varying to purple and white; of a smaller size than that of *V. major*. This species varies much in the colour of the flowers; they are also sometimes double; and the foliage is sometimes variegated, either with white or yellow stripes. (*Don's Mill.*, iv. p. 95.) A creeping evergreen undershrub; a native of Europe, and found abundantly in Germany, Switzerland, France, Italy, &c. In Britain, it has been found in many places, in hedges and woods, in rather damp situations, where it flowers from March till September. It is of the easiest culture, and, like the preceding species, may be usefully employed in covering naked surfaces, in shaded situations.



1084

Varieties.

- ✻ *V. m. 2 foliis argenteis* Lodd. Cat. has leaves variegated with white.
- ✻ *V. m. 3 foliis aureis* Lodd. Cat. has the leaves variegated with yellow.
- ✻ *V. m. 4 flore albo* Lodd. Cat. has white flowers.
- ✻ *V. m. 5 flore pleno* Lodd. Cat. has double flowers.
- ✻ *V. m. 6 flore puniceo* Lodd. Cat. has red flowers.

App. I. *Half-hardy ligneous Plants belonging to the Order Apocynaceæ.*



1085

rich soil, kept moist, and may be preserved against a conservative wall; though it does not flower freely, except when grown in warm situations, so as thoroughly to mature the wood. There are several varieties and botanical species, for which we refer to the *Hortus Britannicus*. (See, also, the *Gardener's Magazine*, vol. i. p. 492.)

Gelsemium nitidum Michx. Fl. Bor. Amer., 1. p. 120.; *Bigonia sempervirens* L., *Pluk. Alm.*, 359. t. 112. f. 5.; and our fig. 1085.; is a climbing evergreen; a native of North America in the vicinity of rivers, from Virginia to Florida, where it flowers in June and July. It has been in British gardens since 1640; and, though it is generally kept in green-houses or cold-pits, there can be no doubt it would stand against a conservative wall with very little protection.

Nerium Oleander L. (fig. 1086.) is a splendid flowering shrub, very generally cultivated in Italy, and the south of France and Spain, and common in English green-houses. It requires a



1036

END OF THE SECOND VOLUME.







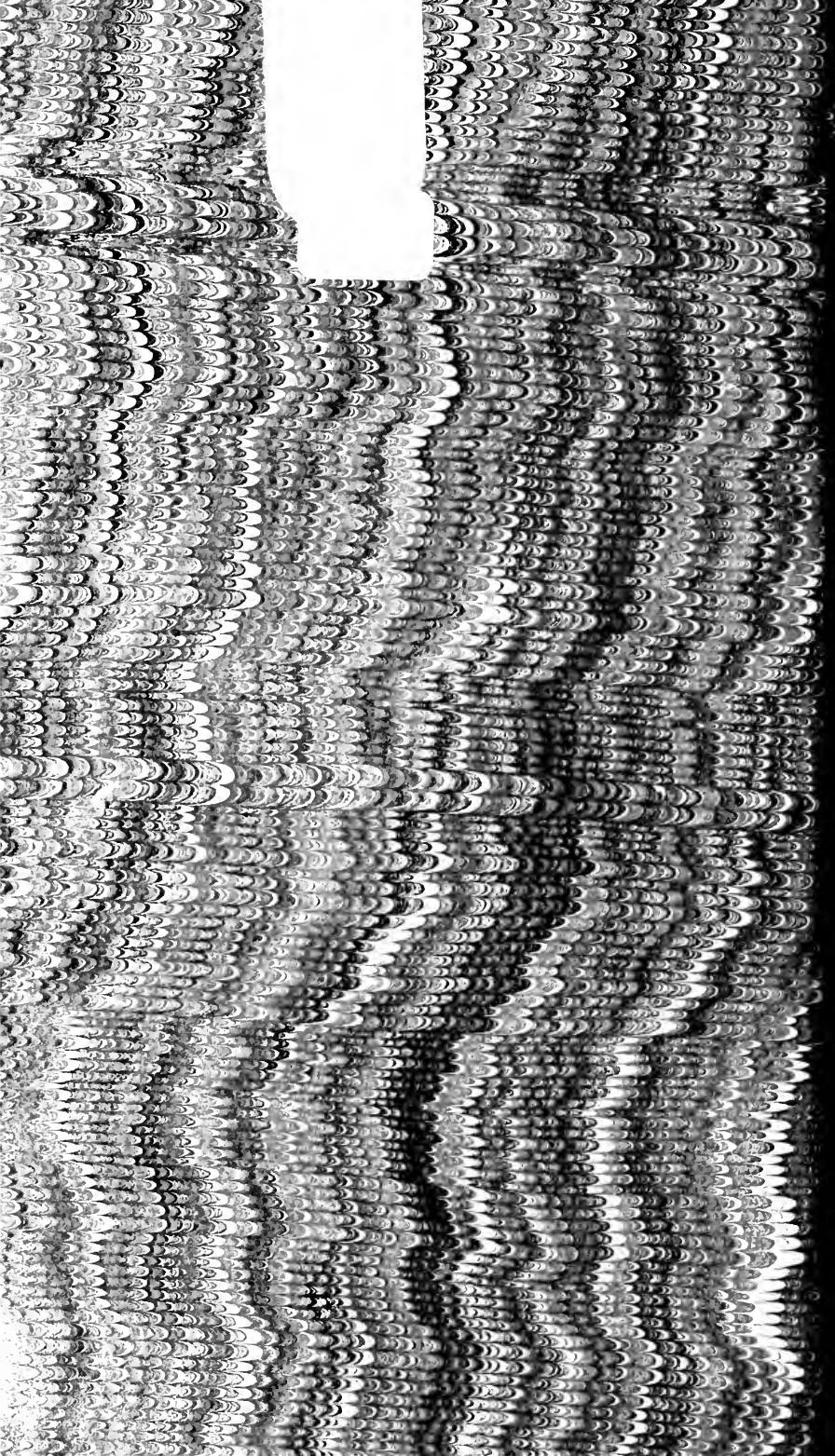

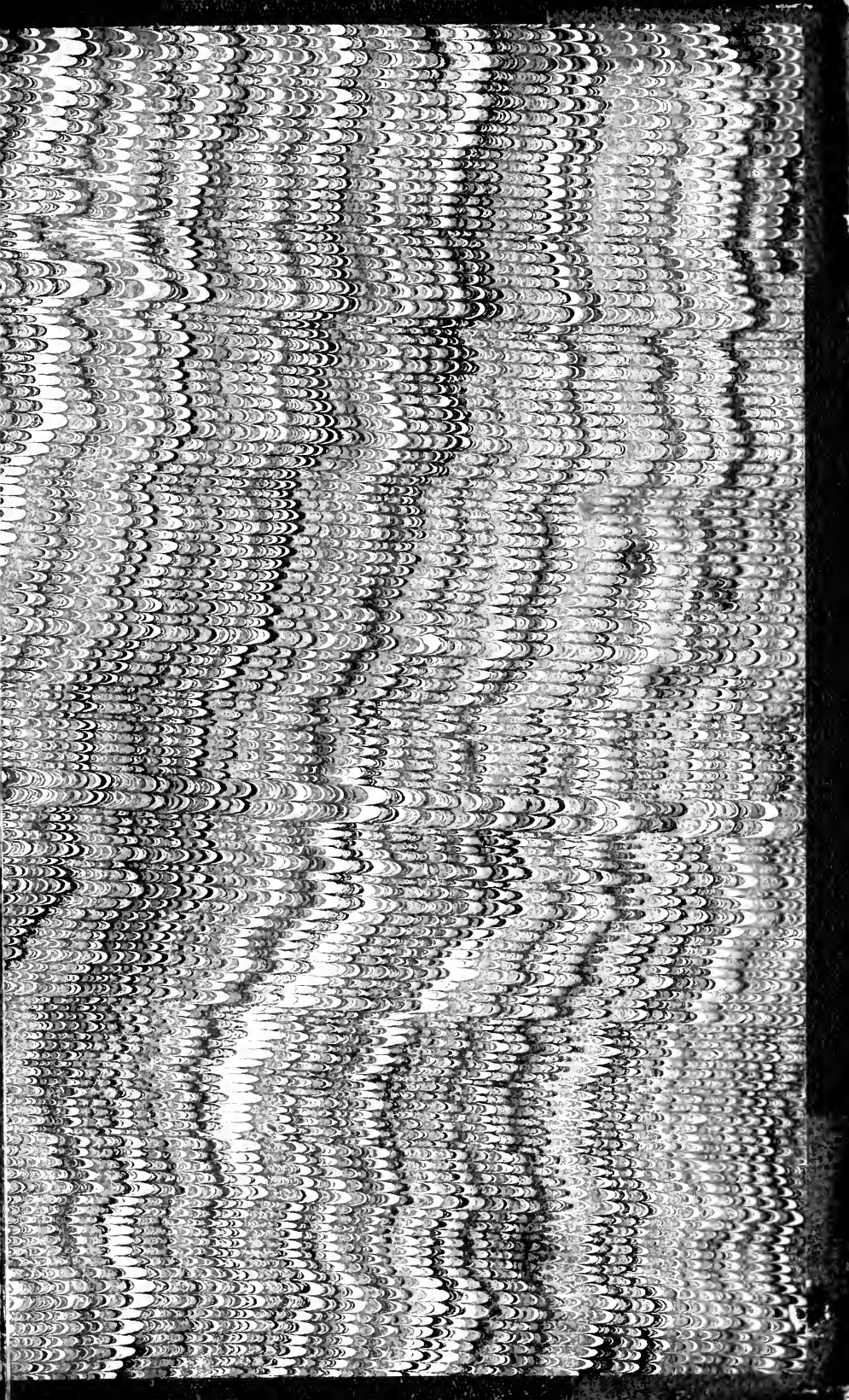

UNIVERSITY OF ILLINOIS - URBANA



3 0112 051870241