

Biological Services Program

FWS/OBS-80/03

JANUARY 1980

Beached Marine Birds and Mammals of the North American West Coast:

A MANUAL FOR THEIR CENSUS AND IDENTIFICATION

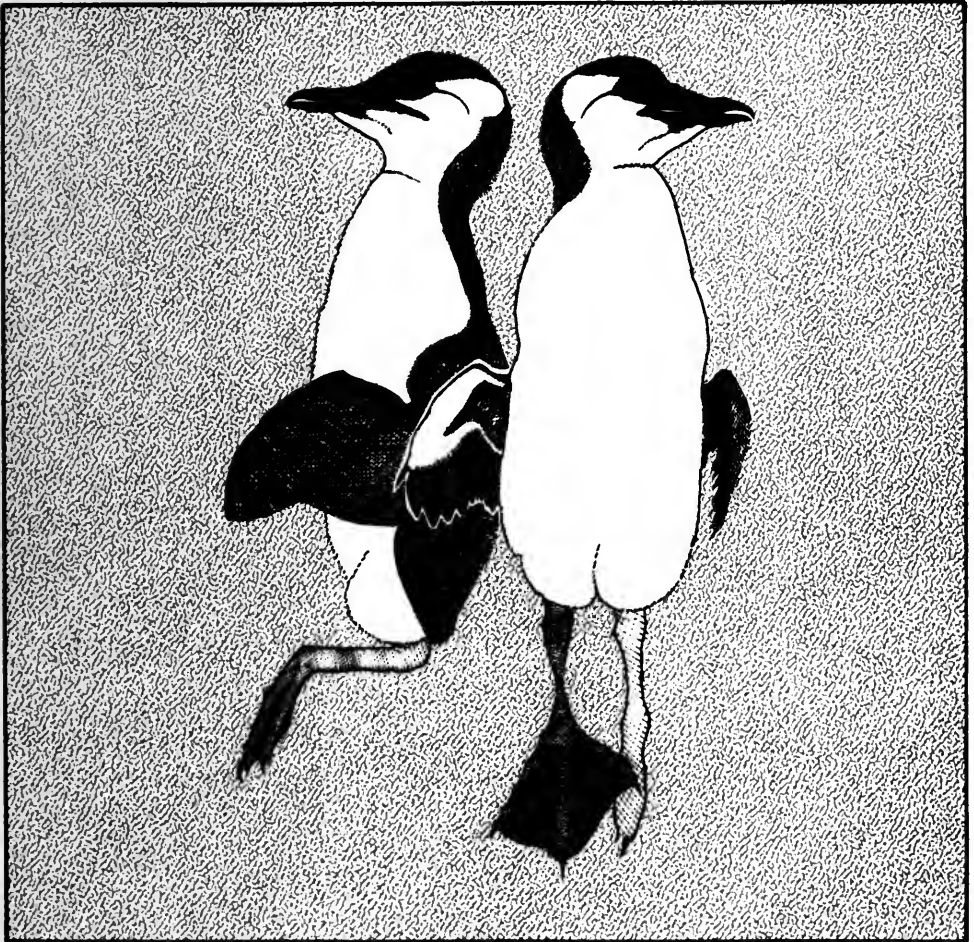

Fish and Wildlife Service

U.S. Department of the Interior

From the collection of



**International
Bird Rescue
Research Center**

Cordelia, California

in association with

o P^{z n m}re^alinger^a
v L^aibrary^p
t

San Francisco, California
2006

The Biological and Wildlife Service key environmental is supporting ecosystem

- To strengthen a primary so life resource impact asses
- To gather, a decisionmake problems ass use.
- To provide b for Departme as those rel

Information dev for use in the plann the impact of develc technical assistance determination of the and an evaluation of and to determine pr the products produc

Projects have l and conversion; pow ment; water resourc water allocation; c ment; and systems i habitat classificat

The Biological Services in Washing management; Nationa and technical exper studies with states Staff, who provide certain Fish and Wi research studies.

the U.S. Fish methodologies on rces and their lows:

ole as wild-ntal

aid of ter

on such

is intended or minimize ivities and issues a ation needs, tion gaps sure that

al extraction le develop- nd western elf develop- tory,

f Biological l planning and al scientific l services rs; Regional and staff at nduct inhouse

FWS/OBS-80/03
January 1980

BEACHED MARINE BIRDS
AND MAMMALS OF THE NORTH AMERICAN
WEST COAST: A MANUAL
FOR THEIR CENSUS AND IDENTIFICATION

BY

David G. Ainley, Gary W. Page, Lisa T. Jones,
Lynne E. Stenzel, and Ronald L. LeValley
Pt. Reyes Bird Observatory
Stinson Beach, California 94970

with drawings by
Helen C. Strong

Contract No. 14-16-001-77027

Project Officer
Jay Watson
U.S. Fish and Wildlife Service
Lloyd 550 Building
Suite 1692
500 NE Multnomah
Portland, Oregon 97232

Performed for
National Coastal Ecosystems Team
Office of Biological Services
Fish and Wildlife Service
U.S. Department of the Interior
Washington, D.C. 20240

DISCLAIMER

The opinions, findings, conclusions, or recommendations expressed in this report are those of the author and do not necessarily reflect the views of the Office of Biological Services, Fish and Wildlife Service, U.S. Department of the Interior, nor does mention of trade names or commercial products constitute endorsement or recommendation for use by the Federal Government.

Digitized by the Internet Archive
in 2007 with funding from
Microsoft Corporation

The correct citation for this report is:

Ainley, D.G., et al. 1980. Beached marine birds and mammals of the North American West Coast: A manual for their census and identification. U.S. Fish and Wildlife Service, Biological Services Program, FWS/OBS-80/03.

207 pp.

<http://www.archive.org/details/beachedmarinebir00natirich>

EXECUTIVE SUMMARY

Personnel of the U.S. Fish and Wildlife Service and other agencies often must identify specimens of marine birds and mammals that have washed onto the shoreline. Beach surveys are also conducted routinely along certain beaches to establish baseline information. Identification of beach-cast specimens can be extremely difficult, particularly after disastrous events such as oil spills and major storms.

The purpose of this manual is to provide information necessary for the correct identification of beach-cast specimens of marine birds and mammals. Identification keys are supplemented by illustrations, glossaries and narrative accounts of species. Instructions are included for the conduct of beach surveys.

This manual includes most species of marine birds and mammals that occur from the Bering Strait, Alaska and along the North American Coast south to Cabo San Lucas at the southern tip of Baja California, Mexico.

Table of Contents

TABLE OF CONTENTS

	Page
List of Plates	<i>vi</i>
List of Figures	<i>vii</i>
Introduction	1
Beached Bird and Mammal Surveys	1
Use of the Manual	2
 MARINE BIRDS	 4
Measurements of Marine Birds	4
Glossary of Terms	7
Key to Bird Keys	16
Bird Keys	
Loons	24
Grebes	25
Albatrosses	26
Petrels	27
Boobies	31
Cormorants	32
Waterfowl	33
Shorebirds	42
Skuas and Jaegers	50
Gulls	51
Terns and Skimmers	62
Alcids	66
Plates	73
Species Accounts	115
Books and Articles for Additional Information	
on Aquatic Birds	151
 MARINE MAMMALS	 153
Measurements and Glossary of Marine Mammal Terms	154
Mammal Keys	159
Pinnipeds	160
Sea Otter	167
Baleen Whales	168
Toothed Whales and Dolphins	170
Plates	176
Species Accounts	178
Books and Articles for Additional Information	
on Marine Mammals	183
Agencies to Notify Concerning Beached Marine Mammals	186
 ACKNOWLEDGEMENTS	 188
INDEX TO SPECIES	189

LIST OF PLATES	Page
1. Bills of Large Loons	73
2. Bills of Small Loons and Grebes	74
3. Bills of Albatrosses	75
4. Bills of Albatrosses, Frigatebirds and Tropicbirds	76
5. Bills of Fulmarine Petrels; and A Top View Comparison of Representative Petrel Bills	77
6. Bills of Shearwaters	78
7. Bills of Storm Petrels	79
8. Bills of Boobies	80
9. Bills of Adult Cormorants	81
10. Bills of Juvenile Cormorants	82
11. Bills of Swans	83
12a. Bills of Geese	84
12b. Bills of Geese	85
13a. Bills of Dabbling Ducks - top view	86
13b. Bills of Dabbling Ducks - side view	87
14a. Bills of Dabbling and Bay Ducks - top view	88
14b. Bills of Dabbling and Bay Ducks - side view	89
15a. Bills of Bay Ducks and Oldsquaws - top view	90
15b. Bills of Bay Ducks and Oldsquaws - side view	91
16. Bills of Scoters - side view	92
17. Bills of Eiders - side view	93
18. Bills of Scoters and Eiders - top view	94
19. Bills of Mergansers and Coots	95
20. Bills of Plovers	96
21. Bills of Oystercatchers, Phalaropes, Turnstones and Surfbirds	97
22. Bills of Medium-sized Sandpipers	98
23. Bills of Large Sandpipers	99
24. Bills of Small Sandpipers	100
25. Bills of Skuas and Jaegers	101
26a. Bills of Large Gulls	102
26b. Bills of Large Gulls	103
27. Bills of Medium-sized Gulls	104
28. Bills of Small Gulls	105
29. Bills of Large Terns and Skimmers	106
30. Bills of Small Terns	107
31. Bills of Large Auks	108
32. Bills of Puffins	109
33. Bills of Murrelets and Auklets	110
34. A large and long webbed foot, in this case, an Arctic Loon	111
35. Webbed feet; three toes webbed, fourth toe minute:	112
1. South Polar Skua	
2. Northern Fulmar	
3. Western Gull	
36. Webbed feet:	113
1. & 2. Three toes webbed, fourth toe absent (alcid, in this case, Pigeon Guillemot)	
3. Three toes webbed, fourth toe lobed (sea duck, in this case, Surf Scoter)	
4. Four toes webbed (in this case, Brandt's Cormorant)	

37. Incompletely webbed, lobed, or unwebbed feet:	114
1. Oystercatcher - partly webbed	
2. Black Tern - partly webbed	
3. Shorebird - not webbed	
4. Coot - lobed	
5. Grebe - lobed	
6. Phalarope - lobed	
38a. Pinniped bacula	176
38b. Pinniped bacula	177

LIST OF FIGURES

1. Example of a beached bird census form	3
2. Measuring bill or culmen length	5
3. Measuring tarsus and toe length	5
4. Measuring wing length (wing chord)	6
5. Measuring the chord of the nail in a skua	7
6. The morphology of a bird's body	8
7. Cross-sectional shapes of body parts	9
8. Morphology of the upper and under wing	10
9. Several parts of a bird's bill	9
10. Shapes of primary feathers	11
11. The mantle	12
12. Different kinds of neck collars	13
13. Scutellate and reticulate tarsus scales	14
14. The speculum	14
15. Subterminal bands	15
16. "Windows" in gull primary feathers	15
17. Comb-like toenail	16
18. Curvatures in partly-folded wings	23
19. The length of upper tail coverts	30
20. Shorebird wings, showing wing stripe and wrist markings .	43
21. Color patterns of shorebird feathers	47
22. Outer three primaries of the Black-headed Gull	51
23. Color patterns in extended wings of three gulls	53
24. Color patterns of outer primaries in terns	65
25. Murre chick old enough to accompany adult at sea	67
26. Murrelets for comparison with Figure 25	68
27. Some baleen whale terms used in the keys	155
28. Some cetacean terms used in the key with a shark for comparison	156
29. Some parts of a pinniped skull	157
30. Dorsal view of a pinniped skull	158
31. Some differences between eared and earless seals	159
32. Some differences between male and female pinnipeds	161
33. Sea lion skull comparisons	162
34. Differences between sea lion skulls and bacula	163
35. Fur seal head comparisons	165
36. Seal skull comparisons	166
37. Some differences between male and female cetaceans	172

INTRODUCTION

Much can be learned about the natural history of marine birds and mammals through the systematic study of beach-cast specimens. The first step in such investigations is the correct identification of the carcasses and to that end this manual was prepared. Identifying a dead animal presents problems different from those confronted when identifying a live one. For the latter, many field guides exist but they depend to a great extent on knowledge of behavior and on characteristics observable from a distance. When confronted with a dead animal, close at hand such clues are no longer useful. This manual contains the necessary clues to identify dead marine birds and mammals occurring along the North American west coast.

The beach-cast specimen can provide insight into a species' anatomy, physiology, diet, diseases, natural/unatural causes of mortality, and other aspects of its natural history. In cases of rare, endangered or infrequently encountered species, a beach-cast specimen becomes an invaluable source of information that would otherwise be impossible to collect. In the cases of more abundant species, still more can be learned by accumulating over the long term, carefully tabulated records of beach-cast carcasses (see BEACHED BIRD AND MAMMAL SURVEYS). As a start, the seasonal patterns of occurrence are revealed. Taken with environmental information, large yearly differences in occurrence patterns help to indicate the factors that affect the distribution of marine species. Similar information can be gathered by direct at-sea observations. This, however, is an extremely expensive and time consuming operation, so much so that only one or two years of direct censuses are usually possible. At-sea observations are also much more difficult to repeat and standardize. The two activities though are complementary because the direct censuses serve to calibrate the beach surveys, both of which after all provide largely an index to a species occurrence and abundance.

BEACHED BIRD AND MAMMAL SURVEYS

Systematic censuses of carcasses on a beach or beaches can yield surprisingly interesting and useful information. To be systematic, censuses need to be made of the same stretch of beach at regular, periodic intervals over an extended period. So useful is the information that major projects have been organized in Great Britain, New Zealand and Australia for a number of years, and more recently in the United States and elsewhere. In some cases, the projects are conducted by government wildlife department personnel and in others by private institutions using volunteer workers. The information gathered is extremely useful in the conservation of marine animals and in just increasing our knowledge about them. Unfortunately, the information has also become useful in assessing the mortality of animals due to man's activities, for instance, in the case of oil spills.

To conduct a beach census the *same* stretch of beach should be surveyed each time at regular intervals. Once every three or four weeks is quite satisfactory. In this way one will derive an index of which animals have occurred, when they occur, and in what abundance. To record all animals that wash in one would have to survey constantly, a very impractical alternative. Each animal encountered is identified and then cast into the dunes so as not to be counted on the next census. When surveying, look for carcasses between and in the highest and the lowest tide lines. You will find the fewest specimens at the water's edge.

Many museums very much want to acquire specimens so in some cases removal might entail transport of carcasses to a museum. In the case of any marine mammal and any endangered species removal is unlawful without a permit; one should merely notify the museum of the animals' whereabouts. Enforcement of these laws is strict. Since it is technically unlawful to "collect" or possess any migratory bird specimen without a federal permit, it is best to be associated, if only in a verbal agreement, with an institution that has such a permit. You will, of course, have to turn over specimens to that institution. The knowledge gained from beached bird censuses is thus further increased when the specimens provided to museums become available for future study.

Figure 1 gives an example of a form for recording beach census data. Its use makes analysis of data at a later date much easier.

USE OF THE MANUAL

This manual includes most of the birds and mammals that have occurred in marine waters from the Bering Strait, Alaska, along the North American coast south to Cabo San Lucas, the southern tip of Baja California, Mexico. It even includes most, but not all, of the species known to have occurred only one or two times in this area. It does not include many of the Asian species that have occurred in the central and western Aleutian Islands.

The first bird keys and first part of the mammal keys are extremely important, as these identify the major group or family to which an animal belongs. In the "Key to Bird Keys" you will be directed to use another set of keys. There are, however, several species that key out only in the Key to Bird Keys Section. You initially have one of four bird keys to consult depending on the size (wing length) of the specimen. In these keys, in those to which one is then directed, and in the mammal keys, one is always given two choices, for example, 1 and 1'. To decide which choice best fits the animal being identified, *ALWAYS READ BOTH CHOICES ENTIRELY*. After each choice will be a number that refers to the next choices to be considered or the species name of the animal, depending on how far along you are.

If you have difficulty in deciding which choice fits your animal, follow both through several further choices in the key to see how other characters fit. Then make your initial choice. In some instances, you will only be able to key out an animal to two or more rather similar species.

Date ____ - ____ - ____ Beach (No. ____) County ____
 No. Miles ____ From ____ To ____

Beach Condition (Circle One): 1 (No Oil) 2 (Slightly Oiled) 3 (Lots of Oil)

Remarks _____

Observers (Last Name, Initial) _____

1 - _____, 2 - _____, 3 - _____

Species Name	Species		Count	Age	Sex	Oiled?	Cond.	Cause of Death	Remarks
	Name	Code							

Notes:

Bird Count

- Should be Count of Birds of a Single Species with All Common Characteristics

- Age, Sex, Oiled, Condition
- HV, IM, AD, FY, SY, TY (For 1, 2, 3 Years)
- F = Female, M = Male
- Y for Yes; Blank for No
- O = Barely Alive, 1 = Fresh, 2 = Decomposing, 3 = Dried
- Oiled, Shot, Tangled in Fishing Line, Strangled by Six-Pack Holder, etc.
- Indicate Color Phase, etc., if Appropriate - Use Back of Form if Necessary
- Conditions Indeterminate - Leave Spaces Blank

If More than One Page is Required for a Single Walk, Use Additional Pages Numbered 2, 3, etc., Repeating Date and Beach at Top of Each Additional Page
 Return to David G. Ainley, 4990 State Route 1, Stinson Beach, CA 94970

Figure 1. Example of a beach census form.

Sometimes in a choice you will encounter two phrases separated by *OR*. The intended meaning is much stronger than a lower case "or". This means that within the choice, you are being given two or more *GROUPS* of characters, only one group of which will fit the specimen. Both phrases, separated by *OR*, cannot fit. If they do, something is not correct (perhaps you made a wrong choice earlier).

If you find a bird carcass with a head, and this is often the case, a collection of drawings is provided with which you match bill shape and size (Plates 1-33) by holding the bill up to the drawing. A WORD OF CAUTION: Please realize that slight variations in size and shape of bills are to be expected. IN CASES WHERE THERE IS OVERLAP THE DRAWINGS MAY GIVE YOU ONLY A GROUP OF SPECIES, and only a rough idea of the two or three most likely ones. For example, Glaucous and Glaucous-winged Gulls overlap in size to a great extent, and also overlap in size with several other species (Western, Herring, Thayer's Gulls). In many species, we provide small and large examples of each. Please use the keys, too - do not rely entirely on the drawings, especially when dealing with loons, storm-petrels, jaegers, gulls and terns.

As another aid to identification a section of "Species Accounts" is given for both birds and mammals. These provide information on the usual timing and locality of occurrence, and in many cases some additional identifying characteristics.

MARINE BIRDS

In this manual, marine birds include avian species that spend a significant part of their life cycle in contact with the marine environment. In more practical terms, the species included are those likely to occur dead on beaches in the prescribed geographic area. Not included are wading birds (herons, egrets, flamingoes, storks, etc.), waterfowl that rarely stray from freshwater, and rails (other than the American Coot). These birds do, but very rarely, occur dead on marine beaches, as do almost any species of land bird. One should be especially aware that pigeons (Rock Doves) are, in fact, found dead on beaches more often than many of the rarer marine species included in the key. As will be mentioned later, if you find a footless and headless pigeon specimen, you will likely try to key it out as a tern.

MEASUREMENTS OF MARINE BIRDS

Many choices require measurements of body parts in metric units. You will thus need a ruler, especially when size differences between two species are small. The ruler presented on the back cover will usually suffice but not always. Sometimes, the measurement is designed only to provide the general difference in size between species; that is, instead of stating in a choice that the carcass is "large" *vs.* "small" (very relative terms) we quantified the difference using real measurements. The measurements are taken as follows:

Bill (or culmen) length - the straight line distance from the bill's tip to where it ends at the skin or feathers of the forehead (Fig. 2). Some birds, e.g., cormorants, have bare skin where the bill reaches the forehead.

Figure 2. Measuring bill or culmen length.

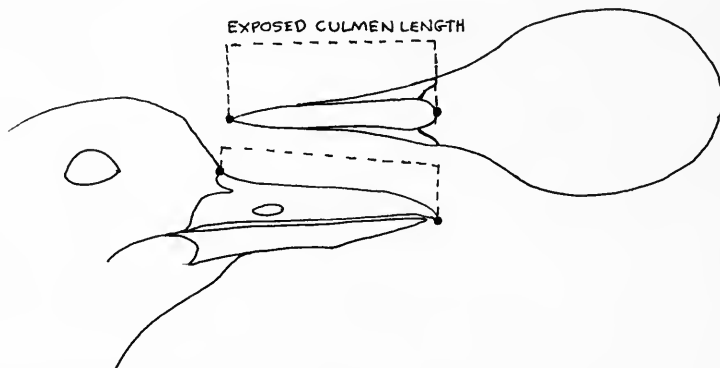

Tarsus (plural - tarsi) length - the length of that bone (tarso-metatarsus) connected to the bird's foot, from the outer edge of one joint (A) to the outer edge of the other (B) in Figure 3.

Toe length - the length of a straightened toe, from the tip (C) to the knuckle (B), as in Figure 3. The key will state whether to measure the inner, outer, or middle toe, or maybe just the longest toe. It should also state whether to include the nail in the measurement.

Figure 3. Measuring tarsus and toe length.

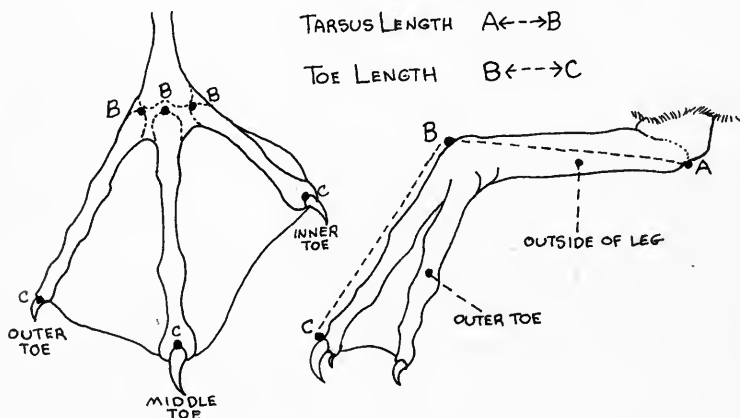

Total wing length - the distance from the shoulder or "arm pit" to the tip of the longest primary in the *extended* wing (see Fig. 8). In conjunction with the width, taken across the wing's upper surface at the wrist (see Fig. 8), a ratio of width to length is derived as an index to wing shape, i.e., long and narrow or short and broad.

Wing length - in a relaxed but folded wing, the distance from the wrist's outer edge to the tip of the longest primary feather (Fig. 4). The wing should be flattened against the ruler. Please note if one of the longest (outer) primary feathers is missing or is only partly re-grown. If one of these feathers is missing, then "wing length" will be shorter than it should be in those species where the outermost primary is longest; the same would be true where the 9th primary is missing in a species where that is the longest feather.

Figure 4. Measuring wing length (wing chord).

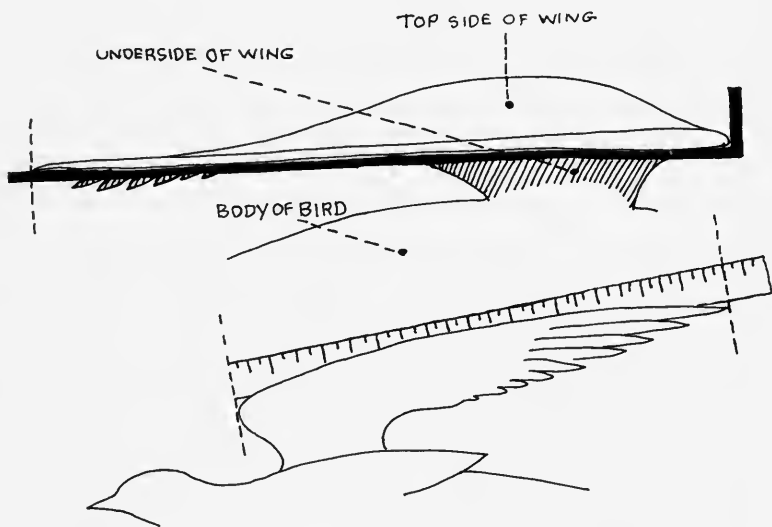

Nail chord - the straight line distance from the point of the bill tip to where the nail's curvature ends (Fig. 5). For birds in which the bill sheath (outer surface of bill that covers internal bone) is divided into distinct sections, such as petrels, cormorants and skuas (see Plates 3-10, 25), the nail is a distinct section. Some birds, such as alcids and terns, have no nail to speak of.

GLOSSARY OF TERMS

As much as possible, we have avoided use of technical words, but the following may need some explanation:

<- a symbol meaning "is less than"; for example:
1 < 2 reads, 1 is less than 2.

>- a symbol meaning "is greater than".

Bill saddle - the bill plate or section, shaped like a saddle, that sits on the culmen or back 2/3 of the bill in adult skuas and jaegers (Fig. 5).

Figure 5. Measuring the chord of the nail in a skua.

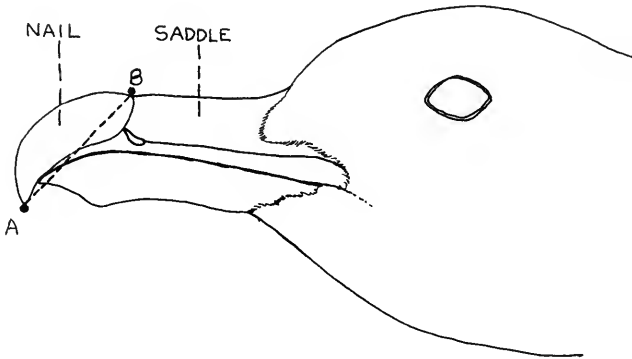
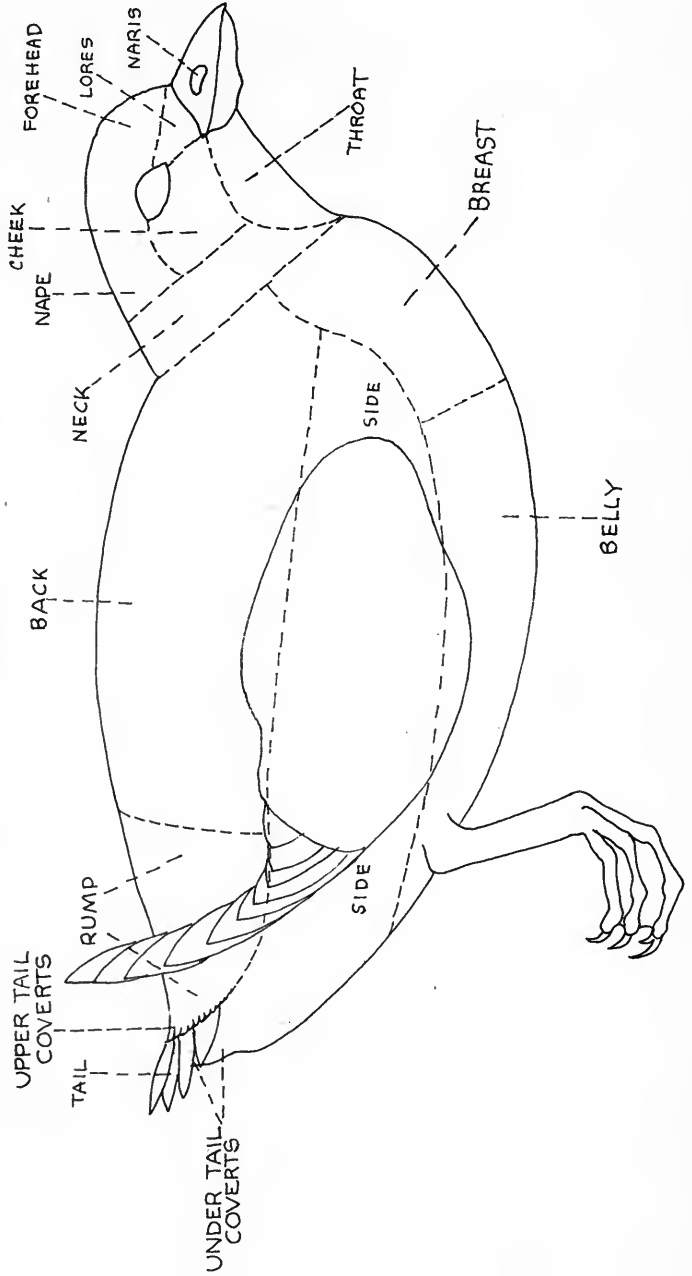

Figure 6. The morphology of a bird's body.



Compressed - refers to the shape of a part when viewed in cross-section (see Fig. 7). Laterally compressed means the sides are flat, as in an oystercatcher's or puffin's bill or a loon's tarsus: (see loon foot illustration).

Dorso-ventrally compressed means the top and bottom are flattened as in a duck's bill.

Figure 7. Cross-sectional shapes of body parts, in this case bills.

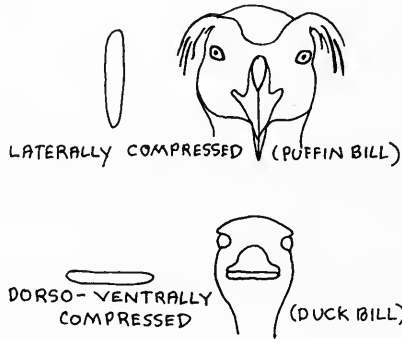

Contour feathers - those that cover the bird's body parts other than feathers of the wings and tail and down feathers.

Culmen - the uppermost ridge of the bill running from the bill's tip to where it meets the skin or feathers of the forehead. The culmen is thus a specific part of the upper bill (see Fig. 9).

Figure 9. Several parts of a bird's bill; see also Figure 5.

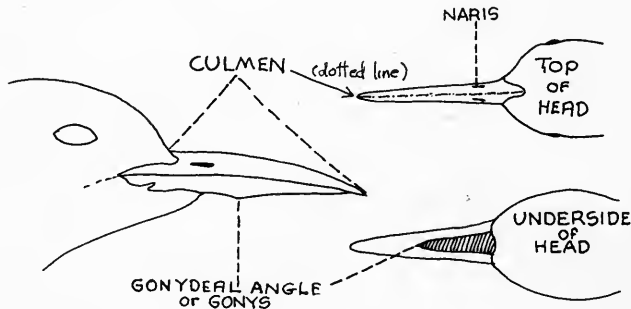
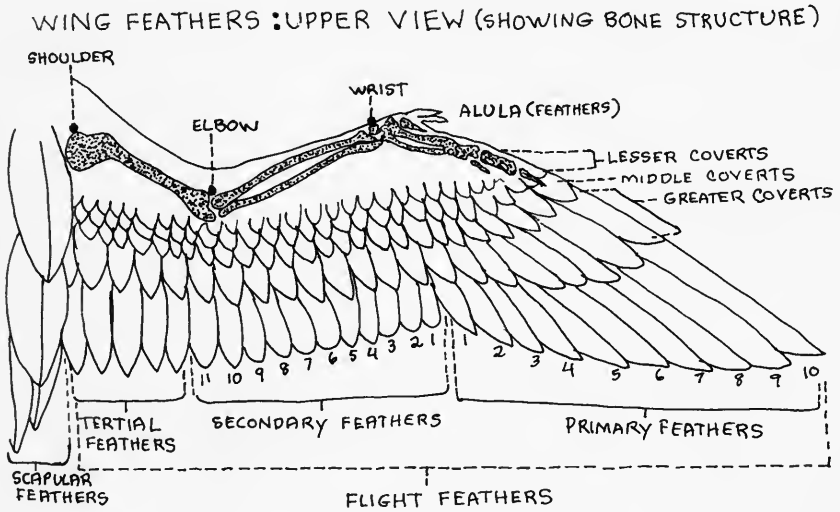
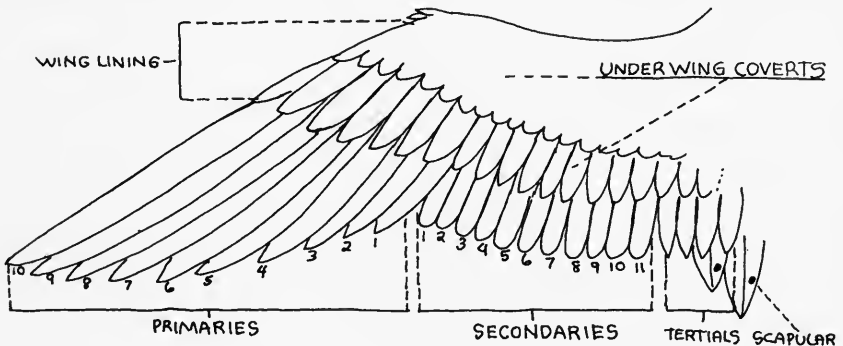

Figure 8. Morphology of the upper and under wing.



WING FEATHERS : UNDER SURFACE



Cut out - refers to the continuity in outline of a primary feather's edge (see Fig. 10). A feather is composed of two webs attached to opposite sides of the shaft. The outer web is on the side away from the bird's body and is usually much narrower than the inner web; the inner web is on the side of the shaft toward the body.

Figure 10. Shapes of primary feathers.

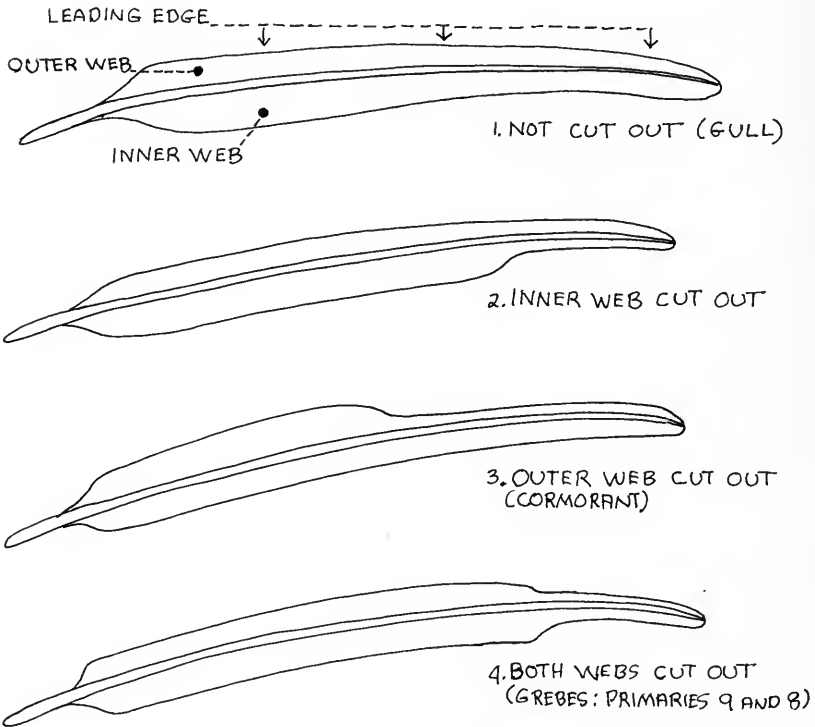

Decurved - refers to a bill that curves downward, as in the Whimbrel (Plate 23).

Down - the small fluffy feathers that lie beneath the covering of contour feathers.

Flight feathers - the large wing feathers (primaries, secondaries and tertials) that provide lift during a bird's flight (see Fig. 8).

Gonys (or Gonydeal angle) - the ridge where the two sides of the lower mandible meet (Fig. 9).

Laterally compressed - see compressed (Fig. 7).

Lores - the area between the eye and the bill (see Fig. 6).

Mantle - the upper surface of the wings (excluding primary feathers) and the area of the back between the wings (Fig. 11).

Marbled - intermixed colors of various shades; variegated.

Nares - the external openings of the nasal passages (singular, naris). These are usually on opposite sides of the upper bill (see Figs. 6 and 9). In petrels they are together in a tube on the top of the bill near its base (see Plate 5); in cormorants, boobies and a few other species they may be lacking.

Nail - the bill tip; see nail chord under bird measurements (Fig. 5).

Figure 11. The mantle.

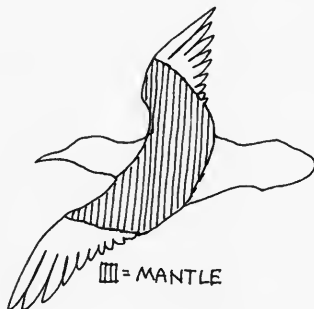

Neck collar - refers to coloration in the neck area (Fig. 12). A collar may be dark and complete (see A below), dark and incomplete (B), light and incomplete (C), or light and complete (D).

Figure 12. The different kinds of neck collars.

NECK COLLARS

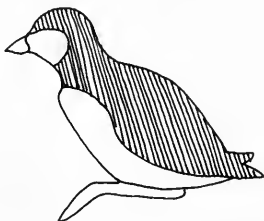

A. DARK AND COMPLETE

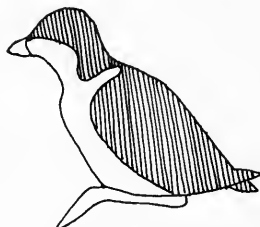

C. LIGHT AND INCOMPLETE

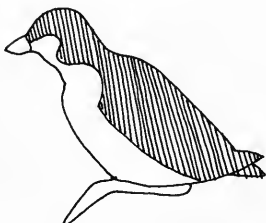

B. DARK AND INCOMPLETE

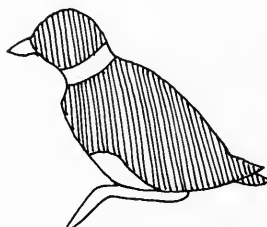

D. LIGHT AND COMPLETE

Primary (or primaries, plural) - the large "flight" feathers that are attached to wing bones from the wrist joint outward (see Fig. 8). These are numbered from the wrist joint outward.

Reticulate - refers to the way in which scales of the legs are positioned; in this case, they do not overlap but rather meet each other as in the mesh of a net or as in the lines around the knuckles on a person's hands (Fig. 13).

Figure 13. Scutellate (a) compared to reticulate (b) scales on the tarsus.

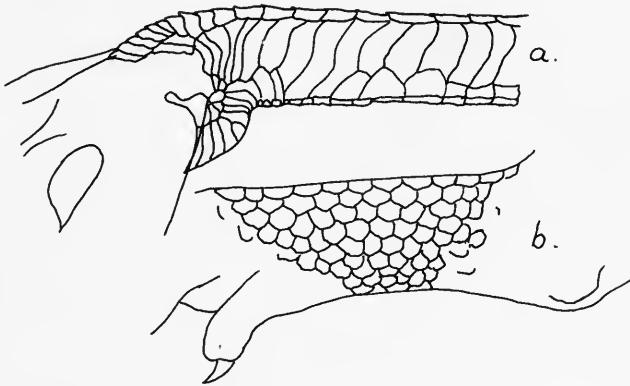

Scutellate - refers to the way in which scales of the legs are positioned, in this case overlapping as in shingles; see reticulate (Fig. 13).

Secondary (or secondaries, plural) - those "flight" feathers that attach to wing bones between the wrist and elbow (see Fig. 8). These are numbered from the wrist inward.

Speculum - in some ducks, that part of the wing, usually feathers of the inner secondaries and greater secondary coverts, that in coloration, strikingly contrasts with the remainder of the wing (Fig. 14).

Figure 14. The speculum.

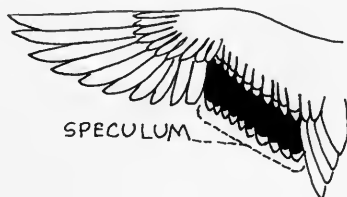

Subterminal - usually refers to color patterning, in the area immediately adjacent to the tip. The dark colorations in Figure 15 are referred to as "subterminal bands".

Figure 15. Subterminal bands.

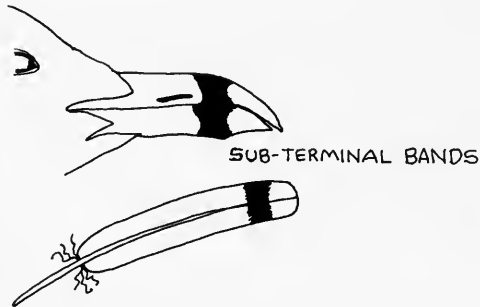

Tertials - those flight feathers attached to wing bones extending from the shoulder to the elbow joint. These are also considered to be the several innermost secondaries (see Fig. 8). In some groups (ducks, shorebirds and terns) the tertials may be very long and pointed compared to the remaining (outer) secondaries.

Underwing - the under surface of the wing; the wing surface that is facing downward in flight or is against the body when the wing is folded (Fig. 8).

Upperwing - the upper surface of the wing; the wing surface that is facing upward in flight or is outermost when the wing is folded (Fig. 8).

Windows - the large white spots within the black area of a gull's wing tip (Fig. 16).

Figure 16. "Windows" in gull primary feathers.



KEY TO BIRD KEYS

If wings are:

use:

- | | |
|---------------------------------------|--------|
| 1. very large, > 470 mm long | Key A. |
| 2. large, 338-467 mm long | Key B. |
| 3. moderate to small, 162-337 mm long | Key C. |
| 4. small, <161 mm long | Key D. |

KEY A: SIZE VERY LARGE, WING >470 mm.

- 1 Primary 10 decidedly longest feather when wing folded completely in natural position; primaries not cut out on either web (Fig. 10); four toes connected by incomplete webs (Plate 37-1,2) OR if fully webbed then only three toes connected (Plates 35, 36-1,2,3) and scales on fore-edge of tarsi scutellate (Fig. 13). 2
- 1' Primary 10 not longest wing feather or equal in length to primary 9; primaries 10-8 may be cut out on one or both webs (Fig. 10); four toes connected by complete webs (Plate 36-4) OR if three toes webbed then scales on tarsi reticulate (Fig. 13). 7
- 2 Wing >600 mm; webbing incomplete, restricted to basal third of toes; nail on middle toes flared and comb-like (Fig. 17). 3
- 2' Wing <580 mm; three longest toes joined by full webs; no toenails comb-like. 5

Figure 17. A booby's or frigatebird's comb-like toenail; (about twice natural size).



KEY A (Cont.)

- 3 Belly (and remainder of plumage) black. MAGNIFICENT FRIGATEBIRD, adult male
- 3' Belly (perhaps head and neck as well) white. 4
- 4 Head and neck black. MAGNIFICENT FRIGATEBIRD, adult female
- 4' Head and neck white. MAGNIFICENT FRIGATEBIRD, immature
- 5 Tarsi compressed or flattened laterally in cross section (Plate 34); tail feathers very short, 16-20 in number. See LOONS (Page 24)
- 5' Tarsi rounded in cross section; tail feathers long, 12 in number. 6
- 6 Very large; wing >474 mm; distance from shoulder to wrist much longer than from wrist to tip of primaries; foot longer than tarsus; tarsi >79 mm; more than 25 secondaries. See ALBATROSSES (Page 26)
- 6' Wing <474 mm; distance from shoulder to wrist not decidedly longer than from wrist to tip of primaries; foot about equal in length to tarsus; tarsi <74 mm; 22 or fewer secondaries. See GULLS (Page 51)
- 7 Primaries 10, 9, 8 and 7 decidedly cut out on outer web (check at least 2/3 of the feather length), inner web tapering gradually to tip; 4 long toes connected by webs; scales on fore-edge of tarsi scutellate; more than 25 secondaries. 8
- 7' Primaries 10, 9, 8 and sometimes 7 cut out on inner web, outer web of 9 and sometimes 8 cut out also; only 3 toes of foot connected by webs, 4th toe reduced in size; scales on legs and feet reticulate; 22 or fewer secondaries. See WATERFOWL (Page 33)
- 8 Wing white with dark primaries. WHITE PELICAN
- 8' Wing entirely dark. 9
- 9 Belly white. BROWN PELICAN, immature
- 9' Belly dark. BROWN PELICAN, adult

KEY B. SIZE LARGE, WING .338-469 mm.

- 1 - Primary 10 longest wing feather. 2
- 1' Primary 10 shorter than 9 and usually shorter than 8. 7
- 2 All 4 toes long and connected by webs (Plate 36-4); middle toenail comb-like (Fig. 17). See BOOBIES (Page 31)
- 2' Only 3 toes connected by webs, 4th toe reduced in size (Plate 35); middle toenail not comb-like. 3
- 3 Tarsus flattened laterally in cross section (Plate 34); 16-20 tail feathers. See LOONS (Page 24)
- 3' Tarsus rounded in cross section; 12 tail feathers. 4
- 4 Wings entirely black on upper surface. See TERNS (Page 62)
- 4' Wings not black on upper surface, wings white to gray or brown. 5
- 5 Wings long and thin in proportion when extended, ratio of width to total length 0.25 or less; tertials and scapulars very long - particularly evident in folded wing; distance from shoulder to wrist less than wrist to wing tip; feet much longer than tarsi; tarsi short (<1/10 wing length); tail deeply forked. See TERNS (Page 62)
- 5' Wings broader in proportion, ratio of width to total length 0.26 or (usually much) more; tertials and scapulars not unusually long; distance from shoulder to wrist about equal OR slightly more than from wrist to wing tip; feet and tarsi about equal in length; tarsi long (>1/10 wing length). 6
- 6 Wings very dark brown all over except for white shafts and bases to outer primaries; in some immatures, contour feathers may be spotted with white, giving bird, especially near flanks and rump, a pronounced checkered appearance; bill black (bill may be light near nostrils); legs and feet black or legs blue and feet black; claws very long and deeply curved (Plate 35-1).

See SKUAS and JAEGERs (Page 50)

KEY B (Cont.)

- 6' Wings gray (charcoal to very light gray) and white OR brown with white flecking throughout OR if entirely brown (immature Heermann's Gull) than remainder of characters do not fit; in immatures, color of contour feathers does not give bird a boldly checkered appearance; legs, feet and bill not black; claws not deeply curved (Plate 35-3).
See GULLS (Page 51)
- 7 Feet with 4 long toes all joined by webs; 12 tail feathers. 8
- 7' Feet with 3 long toes joined by webs, 4th toe reduced in size; 14-24 tail feathers. See GEESE (Page 34)
- 8 Primary 10 only a few mm shorter than 9, only primary 10 cut out and that very slightly; tail decidedly wedge-shaped; bill serrated, not hooked at tip; middle toenail comb-like. See BOOBIES (Page 31)
- 8' Primary 10 shorter than 8 or even 7; primaries 10, 9, 8 cut out on inner web; tail fan-shaped; bill deeply hooked at tip, not serrated along cutting edge; middle toenail not comb-like.
See CORMORANTS (Page 32)

KEY C. SIZE MODERATE TO SMALL, WING 162-337 mm.

- 1 At least 1 (or all) of the outer 5 primaries with inner, outer OR both webs cut out (Fig. 10). 2
- 1' No webs of any primaries cut out. 7
- 2 Wings all of one color (black to brown) on upper surface. 3
- 2' Upper wings with definite contrasting color pattern, if only that some coverts may be white-tipped. 5
- 3 Extended wing broad and rounded; in folded wing primary 10 shorter than 8 or 7. 4
- 3' Extended wing more pointed; in folded wing primary 10 longest OR at least longer than 8. See WATERFOWL (Page 33)

KEY C (Cont.)

- 4' Only primary 10 cut out; ratio of wing's width to total wing length is about 0.32 - 0.38; 3 toes connected by webbing, 4th toe lobed (Plate 36-3); 14-24 tail feathers. See WATERFOWL (Page 33)
- 4' Primaries 10-8 cut out on inner web; wing very broad, ratio of width to total wing length is greater than 0.40; 4 toes connected by webbing (Plate 36-4); 12 tail feathers. See CORMORANTS (Page 32)
- 5 Extended wing broad and rounded; 12 primaries; outer 3 primaries in folded wing very close in length; webbing of primaries cut out near tip as follows: 10 on inner web, 9 and 8 on both webs; no tail; toes broadly lobed but not joined by webbing (Plate 37-5). See GREBES (Page 25)
- 5' Wing more pointed, 11 primaries; primary 10 definitely longest OR 10 slightly shorter than or equal to 9; only primaries 10 and 9 cut out OR if 8 included then cut outs subtle and that on 8 confined to outer web; tail present; feet with 3 webbed toes and a 4th toe reduced in size (Plates 34, 35, and 36-1, 2, 3). 6
- 6 Tips of some wing coverts edged with white - giving flecked appearance - otherwise upper surface of wings dark (almost black); primary 10 longest in folded wing; primaries 10-8 indistinctly cut out, 10 on inner web, 8 on outer and 9 on both; tarsi flattened laterally (Plate 34). See LOONS (Page 24)
- 6' Definite color pattern to wing, if only a single line of white produced by white tips of a row of feathers; primary 9 usually longest feather; tarsi rounded. See WATERFOWL (Page 33)
- 7 Primary 10 in folded wing equal in length to 6, primary 9 longest; wing rounded and stubby, the ratio of width to total length about 0.43; wing charcoal gray with white edge of outer primary; toes very long and lobed (Plate 37-4); bill chicken-like (Plate 19-5). AMERICAN COOT
- 7' Not as in 7. 8
- 8 Wings very long and slender when extended, ratio of width to total length 0.23 - 0.25; distance from wrist to tip of primaries 1 1/2 times the distance from wrist to shoulder; tarsi proportionately small, 1/10 the wing length; upper surface of wing silvery gray (with gray or brown edgings to coverts in immatures) OR black, whitish below. See TERNS (Page 62)

KEY C (Cont.)

- 8' Proportions and colors in wings not as above; tarsi not so minute. 9
- 9 Wing rather stubby - lengths of outer two primaries about equal and not extending much beyond 8th or even 7th; folded wing curved in outline; body feathers close and compact; only 3 toes, all joined by webs (Plate 36-1,2). See ALCIDS (Page 66)
- 9' Not as in 9; wings more pointed - if the tips of primaries 10 and 9 are about equal in extent, they extend decidedly beyond 8; folded wing not decidedly curved; 4 toes. 10
- 10 Tertials very long and pointed; feet webbed, OR only partly webbed, OR not webbed at all (compare Plates 35-37). 11
- 10' Tertials not projecting beyond other secondaries to any great extent; 3 toes, webbed their entire length. 12
- 11 Wing narrow, ratio of width to total length is 0.27 - 0.31; 12 tail feathers. See SHOREBIRDS (Page 42)
- 11' Wing broader, ratio of width to length is 0.34 - 0.38; 12-24 tail feathers. See WATERFOWL (Page 33)
- 12 Bird with distinctive musky odor (not that of rotting flesh!); nostrils together in tube on top of bill (Plates 5 and 6); wings long and narrow, ratio of width to total length 0.22 - 0.29 or less. See PETRELS (Page 27)
- 12' No distinctive odor; nostrils not as in 12; wing broader. 13
- 13 Feet with all 4 toes joined by webs (Plate 36-4); bill without nail or hook at tip OR bill not duck-like; white all over except for feather tips on back and several outer primaries being black. RED-BILLED TROPICBIRD
- 13' Not as in 13. 14
- 14 Upper surface of wing dark brown (sometimes with buffy edges to coverts) except for white bases and shafts of outer primaries; toes very long and toenails deeply hooked (Plate 35-1); legs blue and feet black. See JAEGER'S (Page 50)
- 14 Not as in 14. 15

KEY C (Cont.)

- 15 : Wing entirely black or dark brown, or black or dark brown with several white secondaries; unwebbed 4th toe is lobed (Plate 36-3); outer of 3 webbed toes longest; 12-24 tail feathers.
SEE WATERFOWL (Page 33)
- 15' Wing color not as in 15; 4th toe neither webbed nor lobed (Plate 35-3); middle of 3 webbed toes longest; 12 tail feathers.
See GULLS (Page 51)

KEY D. SIZE SMALL, WING <161 mm

- 1 Primaries 10-8 and sometimes 7 cut out on inner, outer or both webs (Fig. 10); 12 primaries; no tail; tarsi flattened laterally (Plate 37); viewed from above the outer edge of folded wing curves decidedly outward, away from body (Fig. 18a). See GREBES (Page 25)
- 1' Primaries not cut out or 10 and 9 only slightly so; 11 primaries (outermost often minute); prominent tail; tarsi rounded in cross section; shape of wing not as above. 2
- 2 Body plumage compact, feathers overlapping tightly; viewed from above, partly folded wings stubby and decidedly curved inward along outer edge (Fig. 18c); wings rather broad, the ratio of width to total length is 0.30 - 0.40; three toes webbed, the fourth either lobed (Plate 36-3) or absent (Plate 36-1). 3
- 2' Plumage much fluffier, individual feathers overlapping loosely; wings long and slender, ratio of width to total length is 0.22 to 0.31; folded wing straight or curved only slightly inward along outer edge; arrangement of toes not as in 2. 5
- 3 Wing <138 mm; feet with only 3 toes, all connected by webbing (Plate 36-2). See ALCIDS (Page 66)
- 3' Wing 138-161 mm. 4
- 4 Feet with only 3 toes, all connected by webbing; tarsus 15-31 mm; a maximum of 12 tail feathers. See ALCIDS (Page 66)
- 4' Feet with 4 toes, 3 connected by webbing and 4th reduced in size (Plate 36-3); tarsus 30-35 mm; 14-24 tail feathers.
See WATERFOWL (Page 33)

KEY D (Cont.)

- 5 Primary 10 shorter than 8, sometimes shorter than 7; bird largely same color (gray or brown) all over except rump may be white; tertials not notably longer than other secondaries; distinctive musky smell pervades specimen. See PETRELS (Page 27)
- 5' Primary 10 longest primary; usually a stripe running outward along upper surface of wing; belly and back OR back, breast or wings checkered; tertials distinctly longer and more pointed than other secondary feathers; no distinctive musky odor. 6
- 6 Upper surface of wing silver-gray, sometimes with buffy edgings to coverts; exposed portion of outer few primaries darker than rest of wing; tarsi short, $<1/10$ the wing length. See TERNS (Page 62)
- 6' Wing color not as in 6; tarsi proportionately longer, $>1/10$ the wing length. See SHOREBIRDS (Page 42)

Figure 18. The curvature in the outer edge of the partly folded wing.

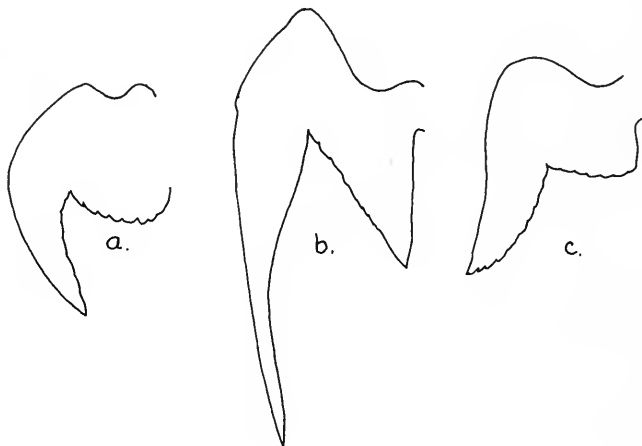

KEY TO LOONS

- 1 - Bill length 45-58 mm; wing length <316 mm (260-315); tarsus length 65-79 mm. 2
- 1' Bill 70-98 mm; wing >319 mm (320-395); tarsus usually >79 mm (73-97). 3
- 2 Bill stiletto-shaped, tip of culmen curved decidedly downward (Plate 2-3). In spring or summer, throat black with green or purple iridescence; back black, each side of upper mantle with column of rectangular white spots. In fall or winter, throat white; back blackish brown, sometimes a few scapular feathers with each having a pair of dull whitish spots. ARCTIC LOON
- 2' Bill slender, appearing upturned due to (1) abrupt upward angulation of lower edge, and (2) a straight (perhaps slightly downcurved) or upward curved culmen especially along posterior two-thirds (Plate 2-2). In spring or summer, throat red; back blackish-brown, feathers at shoulder each with a pair of small gray spots at the tip. In fall or winter, throat white; back blackish-brown, but each feather has a pair of white spots at the tip. RED-THROATED LOON
- 3 Culmen dark along entire (or almost entire) length; bill stiletto-shaped, culmen curved downward (Plate 1-1); central portion of ventral surface of outer 7 primaries light tan, bordered on either side with dark tan; viewed from the front, cross section of bill anterior to nostrils is rounded. COMMON LOON
- 3' Culmen paler, horn color at tip and darkening toward base; culmen often straight, distal one-third of lower mandible with abrupt upward angle giving bill an upturned appearance (Plate 1-2); central portion of outer primaries on ventral surface creamy, bordered on either side by creamy to pale tan; viewed from the front, cross section of bill anterior to nostrils often flat-sided. YELLOW-BILLED LOON

KEY TO GREBES

- 1 Wings >180 mm (181-215) long; bill longer than the head OR bill >44 mm (45-79) long; tarsus >60 mm. 2
- 1' Wings <155 mm; bill shorter than the head OR bill <30 mm; tarsus <45 mm. 5
- 2 Wings with white on inner primaries and outer secondaries; bill length >58 mm; scales on bottom of tarsus smooth; feet olive to yellow. 3
- 2' Wings with no white on primaries only on secondaries; bill 45-56 mm; scales on bottom of tarsus pointed; feet dark brown.
RED-NECKED GREBE
- 3 Bill yellow to orange at base; black of cap not extending to lores; dark of back pale in color. WESTERN GREBE, light phase 4
- 3' Bill yellowish green; black of cap extending below eye to lores; back quite dark. WESTERN GREBE, dark phase 4
- 4 Bill stiletto-shaped (Plate 2-5), 67-80 mm long and 9.5-13.0 mm deep at anterior edge of nares; wing length 192-214 mm.
WESTERN GREBE, male
- 4' Bill much more slender and upturned (Plate 2-6), 55-71 mm long and 8-11 mm deep; wing 184-203 mm. WESTERN GREBE, female
- 5 Only a white spot at tip of inner web of outer secondaries or no white on secondaries; bill chicken-like (very deep and blunt), hooked at tip (Plate 2-1); feathers on front of crown with bristle-like tips; outer lobes of toes wide, webbing between toes extending more than half the toe length. PIED-BILLED GREBE
- 5' Broad white areas on both webs of some secondaries; bill slender, not hooked at tip; feathers on crown without bristle-like tips; outer lobes of toes narrow, webbing extending less than half the toe length. 6
- 6 Bill higher than wide at base; tarsus 44.5-49 mm. In winter, black of cap extending sharply only to level of eye; in breeding plumage, much of neck, upper breast and area along sides chestnut.
HORNED GREBE

KEY TO GREBES (Cont.)

- 6' Width and height of bill at base similar, tip may be slightly upturned; tarsus 38-44.5 mm. In winter, dark of cap extending below eye; in breeding plumage, neck and upper breast black, some chestnut on flanks. EARED GREBE

KEY TO ALBATROSSES

- 1 Body, head and neck white or mottled white and dark brown. 2
- 1' Entirely dark brown. 3
- 2 Area of back between wings white or mottled white and dark brown; culmen 120-145 mm; bill depth measured at anterior edge of nares, 34-35 mm; tarsus 91-101 mm; wing length 518-555 mm. SHORT-TAILED ALBATROSS, adult
- 2' Area of back between wings entirely dark; culmen 99-114 mm; bill depth 24-34 mm; tarsus 78-86 mm; wing 470-510 mm. LAYSAN ALBATROSS, adult and immature
- 3 Bill and feet light tan or yellow; measurements as in 2 SHORT-TAILED ALBATROSS, immature
- 3' Bill and feet black or dark brown; culmen 94-113 mm; bill depth 29-40 mm; tarsus 80-95 mm; wing 485-533 mm. 4
- 4 Considerable white on face. BLACK-FOOTED ALBATROSS, adult
- 4' No (or only a very small amount of) white on face. BLACK-FOOTED ALBATROSS, immature
sub adult, or young adult

KEY TO PETRELS

- 1 Bill length <18 mm; wing length <180 mm; tarsus <30 mm OR if 33-37 mm then feet with yellow on webs; tarsus decidedly longer than middle toe with claw (STORM PETREL). 2
- 1' Bill >25 mm; wing >200 mm; tarsus >38 mm OR if 33-37 mm then feet are entirely black; tarsus not longer than middle toe with claw. 10
- 2 Body, head and neck light to medium bluish-gray; wings with blackish flight feathers but with gray coverts. FORK TAILED STORM-PETREL
- 2' Body, head and neck blackish-gray to sooty brown, except for rump which may or may not be white and secondary upper wing coverts which may or may not be distinctly buffy. 3
- 3 Wing length >165 mm; tarsus 29-33 mm but if close to 33 mm then feet entirely black and no white on rump. BLACK STORM PETREL
- 3' Wings <162 mm; tarsus 25-33 mm but if close to 33 mm then webs of feet with light (yellow) spots and with white feathers in rump, flanks and under tail coverts. 4
- 4 At least some white on some rump feathers (upper tail coverts). 5
- 4' No white on any feathers of rump or flanks. 8
- 5 Tarsus >30 mm; light (yellow) area on webs of feet; some and usually many under tail coverts white. WILSON'S STORM PETREL
- 5' Tarsus <26 mm; feet entirely black; under tail coverts not white. 6
- 6 Upper tail coverts white to the tips including central two (feather shafts dark); tail short, longest tail feather (from skin to tip) 56-57 mm; longest (central) white rump feathers extend about 2/3 the length of the tail (Fig. 19 b); culmen often <12.9 mm (10.6-14.0 mm). GALAPAGOS STORM PETREL
- 6' Rump extensively white with most of the longer upper tail coverts in center of rump having dark tips except perhaps the most central ones which may sometimes be entirely white or entirely dark OR only a few feathers on either side of rump have some white (sometimes confined to one white spot on one feather on either side); longest rump feathers extend only about 1/2 the tail length (Fig. 19 a). 7

KEY TO PETRELS (Cont.)

- 7 Two central-most upper tail coverts within the largely white rump patch completely dark or partly dark OR only a few feathers on either side of rump with at least some white; shafts of white rump feathers dark; bases of outermost tail feathers usually dark, but if white, then only for about 1 cm.
LEACH'S STORM PETREL, light phase
- 7' The several longest upper tail coverts in center of rump white but with dark tips; shafts of white rump feathers white; lateral tail feathers white at base for 2.5 cm or more.
HARCOURT'S STORM PETREL
- 8 Coloration blackish-gray all over (not brown), particularly on ventral surfaces of wings; upper wing coverts not distinctly buffy (only slightly, if at all). 9
- 8' Coloration brown, particularly under wing coverts; upper wing coverts very decidedly buffy forming a bar running diagonally from the body to the wrist (not including scapulars); north of Pt. Conception almost all with wings >144 mm (very rarely to 142 mm long).
LEACH'S STORM PETREL, dark phase
- 9 Wing length <130 mm; bill length <12 mm; central tail feathers longer than or as long as outer ones (i.e., tail wedge-shaped or square, not forked); upper tail coverts (rump feathers) extend about 2/3 the length of tail feathers (Fig. 19b).
LEAST STORM PETREL
- 9' Wing 131-142 mm (very rarely to 145 mm); bill 13-15 mm; tail forked; upper tail coverts extend only about 1/2 the length of tail feathers (Fig. 19a).
ASHY STORM PETREL
- 10 Back, mantle of wings, and rump boldly checkered black and white; broad black band at tip of white tail.
CAPE PETREL
- 10' Coloration not as above. 11
- 11 Underwings white with a broad black bar running from wrist to "armpit"; breast white but belly charcoal gray; bill black, <29 mm long and heavy in proportion (not slender; Plate 5); tarsus <38 mm.
SCALED (MOTTLED) PETREL
- 11' If underwings white then without the broad black bar referred to above; if breast white then belly white also; bill brown, yellow, horn color or pale, >29 mm but if 29-30 mm then especially slender; tarsus >42 mm.

KEY TO PETRELS (Cont.)

- 12 Bill large and thick, nasal tube prominent, about 40% of bill length (Plate 5); lower mandible not decidedly hooked at tip; body stocky; tarsus rounded in cross-section. 13
- 12' Bill slender (especially when viewed from above), nasal tube about 25% of bill length (Plate 6); lower mandible hooked; body slender, torpedo-shaped; tarsus flattened laterally when viewed in cross-section. 15
- 13 Underparts of body white. 14
- 13' Underparts of body light gray to dark brown. NORTHERN FULMAR, dark phase
- 14 Crown, nape and hind neck light gray; underside of head and neck white. NORTHERN FULMAR, intermediate phase
- 14' Head and neck white. NORTHERN FULMAR, light phase
- 15 Belly white or partly white. 16
- 15' Bird entirely dark, except bill and feet may not be dark. 19
- 16 Wing length 270-300 mm; tail decidedly wedge-shaped; under tail coverts white; inner webs of primaries largely white; in fresh plumage, back light to medium gray; a prominent dark "W" pattern visible when both wings are extended (not evident in worn plumage). BULLER'S SHEARWATER
- 16' Wing <270 mm OR greater than 300 mm; tail not decidedly wedge-shaped; under tail coverts dark; inner webs of primaries dark; back brown, never a "W" pattern over wings and mantle. 17
- 17 Wing <270 mm; bill black along top and at tip, remainder bluish-gray; legs and feet light (flesh-colored) but with outer side of tarsus and outer toe black. COMMON SHEARWATER (See Species Accounts)
- 17' Wing >300 mm; bill largely straw-colored except darker along top and at tip; legs and feet entirely light (flesh-colored) but tending toward brown along outer toe. 18

KEY TO PETRELS (Cont.)

- 18 Under tail coverts white; feathers of forehead, face and sides of neck white each with a central dark streak running along the shaft giving a streaked appearance to these areas; coloration of bill warm tan. STREAKED SHEARWATER
- 18' Under tail coverts dark; feathers of forehead, face and sides of neck usually dark but sometimes whitish and broadly tipped with dark coloration imparting a speckled appearance to these areas; straw-colored bill lighter than 18. PINK-FOOTED SHEARWATER
- 19 Bill straw-colored; feet and legs light-colored (pinkish in fresh specimens); wing length 298-333 mm. FLESH-FOOTED SHEARWATER
- 19' Bill and feet dark (black to brownish or bluish); wing 263-320 mm. 20
- 20 Wing linings (under wing coverts) generally brown; small (wing 263-290 mm, culmen 29-35 mm). SHORT-TAILED SHEARWATER
- 20' Wing linings usually light gray, in some cases almost white; larger (wing 280-320 mm; culmen 38-48 mm). SOOTY SHEARWATER

Figure 19. The length of upper tail coverts (rump feathers) relative to the length of the tail: tail coverts (a) about $1/2$ the tail length and (b) about $2/3$ the tail length.

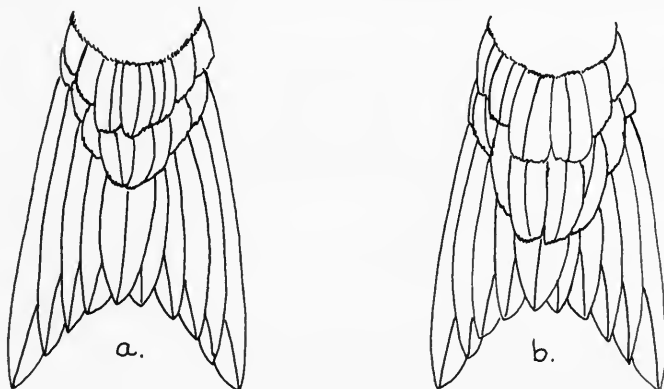

KEY TO BOOBIES

- 1 Belly entirely white or very light gray (almost white). 2
- 1' Belly not white but rather mottled or dark. 8
- 2 Breast very dark brown; demarcation between breast and belly straight and abrupt. 3
- 2' Breast white or light brown; if brown, coloration grading gradually into belly or boundary not straight. 4
- 3 Forehead white or lighter than crown; feet green.
BROWN BOOBY, adult male
- 3' Forehead and crown same dark color; feet more yellow.
BROWN BOOBY, adult female
- 4 Throat entirely white. 5
- 4' Throat with some brown. 6
- 5 Tarsus 34-43 mm; bill length 77-90 mm; bill depth 28-34 mm; feet and legs red.
RED-FOOTED BOOBY
- 5' Tarsus 53-62 mm; bill 98-106 mm; bill depth 35-38 mm; feet and legs blue-gray.
BLUE-FACED BOOBY, adult
- 6 Feathers on head and neck light centrally with outer parts dark giving these areas a streaked appearance; feet light blue.
BLUE-FOOTED BOOBY
- 6' Head and neck not streaked. 7
- 7 Head and neck dark brown, sometimes speckled; measurements as in 5'; feet light blue, occasionally tending toward pinkish.
BLUE-FACED BOOBY, immature
- 7' Non-white color of neck, head or shoulders very light; measurements and foot color as in 5.
RED-FOOTED BOOBY

KEY TO BOOBIES (Cont.)

- 8' Belly mottled dark and white; dark breast clearly defined in contrast to mottled belly - demarcation line straight. BROWN BOOBY, immature
- 8' Belly all one color or dark with light feather tips giving delicate scaled effect. 9
- 9 Dark belly feathers with fine, light edgings; feet green to yellow; bill length 90-101 mm; tarsus 41-51 mm. BROWN BOOBY, immature
- 9' Feathers without light edges; feet reddish; bill 77-90 mm; tarsus 34-43 mm. RED-FOOTED BOOBY

KEY TO CORMORANTS

- 1 General body coloration very dark with green or purple iridescence. 2
- 1' Body all brown or mostly brown (except sometimes belly like 1 above); brown of belly and neck may be a very light sandy color or almost white. 5
- 2 Lower mandible yellow, culmen black. 3
- 2' Bill dark brown all over. 4
- 3 Bill short and deep (length only 2.7 - 3.4 times greater than depth at base) with very prominent and sharp hook, curving far below tip of lower mandible (Plate 9-1); throat skin yellow or orange; back feathers bronze with black edges giving a scaly appearance; long white or black plumes may or may not extend up and back from above each eye. DOUBLE-CRESTED CORMORANT, adult
- 3' Bill thinner (length 3.7 - 4.1 times greater than depth at base), hook barely reaching below lower mandible (Plate 9-4); face and throat skin red; back feathers dark iridescent green, not scaly; flank feathers may or may not be white; two crests on head, one extending back from forehead and the other projecting from back of head. RED-FACED CORMORANT, adult

KEY TO CORMORANTS (Cont.)

- 4 Bill length 64-80 mm; tarsus 59-72 mm; bill 3.8 - 4.3 times longer than deep at base (Plate 9-3); feathers of chin tan; throat pouch may be blue; long, thin white plumes may extend backward from sides of head and back. BRANDT'S CORMORANT, adult
- 4' Bill 42-57 mm; tarsus 47-59 mm; bill very thin, 4.4 - 6.0 times longer than deep at base (Plate 9-5); feathers of chin same color as head and throat; face and throat pouch red; flanks may or may not be white. PELAGIC CORMORANT, adult
- 5 Lower mandible entirely chrome yellow or yellow only at base. 6
- 5' Upper and lower mandible brown. 7
- 6 Face and throat yellow; feathers of back tan with thick, dark brown edges giving a scaly appearance; belly and throat sometimes very light, almost white; bill as in 3 above (Plate 10-1).
DOUBLE-CRESTED CORMORANT, immature
- 6' Face and throat not yellow; back feathers brown with purple iridescence, not prominently scaly; bill as in 3'. RED-FACED CORMORANT, immature
- 7 Measurements as in 4. BRANDT'S CORMORANT, immature
- 7' Measurements as in 4'. PELAGIC CORMORANT, immature

KEY TO WATERFOWL

- 1 Body, head and neck white or very light gray; wings white or white with black primaries; three or four outermost primaries with one or both webs cut out (see Fig. 10). 2
- 1' Coloration largely brown or gray with a little white here or there; no primaries or only outer two decidedly and the third outermost sometimes slightly cut out (see Fig. 10). 5
- 2 Wings entirely white or very light gray; primaries 10-7 have one or both webs cut out; area between eye and bill (the lores) unfeathered; very large bird, wing length 500-680 mm. 3

KEY TO WATERFOWL (Cont.)

- 2' Wings largely white except for black primaries; primaries 10-8 have one or both webs cut out; medium large bird, wing 318-402 mm. 4
- 3 Tail of 20 feathers; usually, but not always, a yellow spot in front of eye; distance from tip of bill to anterior edge of nostril <48 mm; wing length 500-575 mm. WHISTLING SWAN, adult (all white) or immature (gray wash to some feathers)
- 3' Tail of 24 feathers; never a yellow spot in front of eye; distance from tip of bill to anterior edge of nostril >50 mm; wing 544-680 mm. TRUMPETER SWAN, adult (all white) or immature (gray wash to some feathers)
- 4 Bill length 50-63 mm; sides of bill open in a "grin" as in Plate 12a-2, where "grin" is >1/3 the bill depth; wing length 380-470 mm. SNOW GOOSE
- 4' Bill 34-46 mm; not as open on sides, "grin" <1/3 the bill depth; wing 360-400 mm. ROSS' GOOSE
- 5 Tarsus with scutellate scales along front edge (Fig. 13); no primaries cut out OR just primary 10 cut out on inner web OR primary 10 cut out on inner web and 9 cut on outer web OR primaries 9 and 10 cut out on outer webs. (DUCKS) 10
- 5' Tarsus with reticulate scales along front edge; three outer primaries cut out: 10 on inner web, 9 on both webs and 8 (sometimes only slightly) on outer web. (GEESE) 6
- 6 Head and neck black with white cheeks or a white collar (Fig. 12); feet and legs black. 7
- 6' Head and neck not black (except perhaps throat); feet not black. 8
- 7 Black ends at base of neck; white cheeks; upper and under tail coverts not nearly as long as tail. CANADA GOOSE
- 7' Black of neck extends to back and breast; white collar (Fig. 12d); dark cheeks; upper and lower tail coverts usually as long as or longer than tail. BRANT

KEY TO WATERFOWL (Cont.)

- 8 Head and neck entirely white (may be stained rusty); rump color variable, from pure white to light gray; feet purple, pinkish or in fall tending toward orange. SNOW GOOSE, blue phase
- 8' Head and neck with dark (and white) coloration; rump light to dark-brown; feet yellow or pale. 9
- 9 Tail entirely white; back, scapulars, chest and sides silver-gray, feathers becoming black subterminally with white tips. EMPEROR GOOSE
- 9' Tail dark but with white tip; back and scapulars gray brown, feathers with paler tips. WHITE-FRONTED GOOSE
- 10 Hind toe lobed (Plate 36-3). 11
- 10' Hind toe not lobed (similar to Plate 35-3). 46
- 11 Wings without distinctive color pattern (secondaries may be chestnut in male Oldsquaw, choice 14). 12
- 11' Secondaries with distinctive pattern, either brightly or plainly colored (white, black, gray) or tipped with white OR large white patch in shoulder. 18
- 12 Wing length 200-254 mm; tail feathers not modified as in 12'; feet orange, blackish or gray. 13
- 12' Wing 138-155 mm; tail feathers narrow, stiff and pointed; feet grayish blue (sometimes dark gray in juveniles). RUDDY DUCK
- 13 Belly and sides white; may or may not be white on wings; primary 10 cut out on inner web, 9 on outer web; scapulars much longer than secondaries and pointed; bill stubby, length 25-30 mm; tarsus 31-37 mm; feet gray. 14
- 13' No white except on head; primary 9 not cut out; scapulars not notably longer than secondaries, nor notably pointed; bill 36-47 mm; tarsus 40-49 mm; feet orange, red-orange or olive with black webs. 15
- 14 Breast black. OLDSQUAW, male

KEY TO WATERFOWL (Cont.)

- 14' Breast brown anteriorly, but white near belly (which is also white). OLDSQUAW, female
- 15 Feathers of forehead extend forward on top of bill; feet red or orange or orange-brown with black webs; in folded wing, primary 10 equal in length to or longer than 9. 16
- 15' Feathers of forehead end abruptly and evenly at base of bill; feet black or dark greenish-brown with black webs; primary 10 shorter than 9 and 8 and sometimes shorter than 7. 17
- 16 Largely black all over except for white feathers on forehead and nape; bill brightly colored. SURF SCOTER, adult male
- 16' Largely brown; bill dull. SURF SCOTER, adult female and juvenile
- 17 Largely black; base of bill orange; primary 10 distinctive: very thin and cut out almost half its length on inner web and shorter than primary 7. BLACK SCOTER, male
- 17' Largely brown; whitish cheeks; primary 10 shorter than 8 and only indistinctly cut out if at all. BLACK SCOTER, female and juvenile
- 18 Secondaries with blue coloration, sometimes very dull. 19
- 18' Secondaries not brightly colored - plainly colored or tipped with white OR not colored but wing with distinctive large white shoulder patch and elongated sickle-shaped tertials. 22
- 19 Secondaries blue, tipped with white; tertials elongated (longer than other secondaries) and curved outward from body. 20
- 19' Secondaries entirely blue (color may be very dull); tertials not noticeably longer than secondaries and not curved outward. 21
- 20 All wing coverts white. STELLER'S EIDER, male
- 20' All wing coverts brown. STELLER'S EIDER, female
- 21 All wing coverts blue-gray; tertials white. HARLEQUIN DUCK, male

KEY TO WATERFOWL (Cont.)

- 21' Wing coverts brown; secondaries only washed with blue. HARLEQUIN DUCK, female
- 22 Secondaries not distinctively colored but secondary coverts white. 23
- 22' Secondaries distinctively colored. 24
- 23 Tertials dark. KING EIDER, male
- 23' Tertials light. SPECTACLED EIDER, male
- 24 Speculum (secondaries) pearl gray, compared to brownish primaries. 25
- 24' Speculum largely black, white or brown tipped with white. 28
- 25 Forehead sloping; bill elongated, as long as head, and slim (Plate 14b-2). 26
- 25' Forehead abrupt; bill short, broad (half as wide as long) (Plate 14b-3). 27
- 26 Head and neck chestnut; breast black. CANVASBACK, male
- 26' Head, neck and breast brown. CANVASBACK, female
- 27 Head and neck chestnut; breast black. REDHEAD, male
- 27' Head, neck and breast brown. REDHEAD, female
- 28 Speculum dark or mostly dark. 29
- 28' Speculum with much white. 32
- 29 Greater coverts and outer secondaries black, inner secondaries and tertials white. COMMON EIDER, male
- 29' Secondaries and greater secondary coverts brown, tipped with white. 30

KEY TO WATERFOWL (Cont.)

- 30 Tertials tipped with white. SPECTACLED EIDER, female
- 30' Tertials all one color. 31
- 31 Only inner secondaries and inner greater secondary coverts tipped with white. KING EIDER, female
- 31' All secondaries and secondary coverts tipped with white. COMMON EIDER, female
- 32 Secondaries white tipped with dark. (SCAUP) 33
- 32' Secondaries white not tipped with dark (but some secondaries may be entirely dark). 36
- 33 Some white on outer web of the 5 inner primaries and wing length >220 mm. 34
- 33' No white on outer web of the 5 inner primaries and wing length <208 mm (birds not fitting 33 or 33' should be compared with specimens for identification). 35
- 34 Head mostly glossy greenish. GREATER SCAUP, male
- 34' Head brown but forehead and front of face may be white. GREATER SCAUP, female and immature
- 35 Head glossy mostly purple. LESSER SCAUP, male
- 35' As in 34'. LESSER SCAUP, female and immature
- 36 Inner secondaries and inner greater secondary coverts white; outer secondaries and outer greater secondary coverts green; bill long and slender with serrate edges (Plate 19-1). (MERGANSER) 37
- 36' Wing pattern not as above; bill more duck-like (broad and flat). 40
- 37 Nostril near middle of bill; feathering on bill near gape (corner of mouth) extends forward as far as that on lower mandible (Plate 19-1); in dorsal view, forehead feathering extends farther on bill toward bill tip than does feathering on side of upper mandible; wing length 246-285 mm. 38

KEY TO WATERFOWL (Cont.)

- 37' Nostril near base of bill; feathering on side of upper mandible near gape extends forward of that on lower mandible (Plate 19-2); feathering of forehead and on sides of upper mandible extends an equal distance toward bill tip; wing 213-257 mm. 39
- 38 Head, neck and back green; breast, belly and sides white to faintly salmon. COMMON MERGANSER, male
- 38' Head and neck chestnut; distinct demarcation between neck color and whitish of breast. COMMON MERGANSER, female and immature
- 39 Head green, throat largely white; sides grayish. RED-BREASTED MERGANSER, male
- 39' As in 37' but neck color grading gradually into whitish breast. RED-BREASTED MERGANSER, female and immature
- 40 Wing length >255 mm; wing entirely dark except for white of inner and middle secondaries and coverts. 41
- 40' Wing <246 mm. 42
- 41 Body black dorsally; yellow-orange on bill; feet orange with black webs; greater secondary coverts tipped with white. WHITE-WINGED SCOTER, male
- 41' Body brown dorsally; feet brown with black webs; greater secondary coverts entirely dark. WHITE-WINGED SCOTER, female and immature
- 42 Feet yellow with dark webs. 43
- 42' Feet pink or gray. 45
- 43 Breast entirely white. 44
- 43' Breast white with gray collar. BARROW'S and COMMON GOLDENEYE, female and immature
- 44 Greater coverts black, center ones tipped with white; crescent-shaped white spot between eye and bill. BARROW'S GOLDENEYE, male

KEY TO WATERFOWL (Cont.)

- 44' Greater coverts white (though black at bases); round white spot between eye and bill. COMMON GOLDENEYE, male
- 45 Feet pink; triangular white patch on crown of head extending to cheeks; all coverts mainly white. BUFFLEHEAD, male
- 45' Feet gray; head dark except for large white spot behind eye; wing coverts dark. BUFFLEHEAD, female and immature
- 46 Speculum black and white with some greater coverts chestnut. 47
- 46' Speculum containing bright metallic color: blue, green or blue-green. 48
- 47 Chestnut on coverts extensive, forming large patch on wing; rump black. GADWALL, male
- 47' Chestnut on coverts very faint; rump brown. GADWALL, female
- 48 Upper wing coverts light blue forming large blue wing patch. 49
- 48' Upper wing coverts not blue. 53
- 49 Wing length >215 mm; bill spoon-shaped, widest at tip and >56 mm long; feet red-orange. 50
- 49' Wing <200 mm; bill not spoon-shaped, <50 mm long; feet yellow. 51
- 50 Rump, head and neck green; belly and sides cinnamon; breast white. NORTHERN SHOVELER, male
- 50' Generally brown all over. NORTHERN SHOVELER, female
- 51 Generally brown all over, except in wings. BLUE-WINGED and CINNAMON TEAL, female
- 51' Belly cinnamon, either very pale or very dark, rich color. 52
- 52 Belly pale cinnamon (to buffy) with dark spots; head gray, with large white crescent in front of eye. BLUE-WINGED TEAL, male

KEY TO WATERFOWL (Cont.)

- 52' Rich cinnamon red over much of body and head. CINNAMON TEAL, male
- 53 Speculum purplish-blue with upper and lower white borders; feet orange. 54
- 53' Speculum with no purple; feet bluish-gray. 55
- 54 Generally brown all over (except speculum and whitish belly). MALLARD, female
- 54' Sides and belly white; breast cinnamon; rump, head and neck green OR with flecks of these colors in the latter 3 areas. MALLARD, male
- NOTE: In a wing specimen without accompanying feet, Steller's Eider (choice 20) and Harlequin Duck (choice 21) might key out to here; check choices 19-21 to be sure.
- 55 Speculum violet, bronze and green. 56
- 55' Speculum green or green and black. 57
- 56 Speculum glossy, bordered behind with black and white bars and in front by cinnamon-buff bar. PINTAIL, male
- 56' Speculum dull without black bar. PINTAIL, female
- 57 Speculum green and black, edged in front by cinnamon-buff bar; no shoulder patch; wing length <210 mm. 58
- 57' Speculum mostly green, edged in front by black; large white or gray shoulder patch; wing >230 mm. 59
- 58 Upper tail coverts black with ashy edges; under tail coverts black and yellow; sides gray. GREEN-WINGED TEAL, male
- 58' Body brownish all over. GREEN-WINGED TEAL, female
- 59 Middle and greater wing coverts white, forming large white wing patch; green speculum shades to black towards tips of feathers. AMERICAN WIGEON, male
- 59' Middle and greater wing coverts gray; green speculum feathers tipped with white. AMERICAN WIGEON, female

KEY TO SHOREBIRDS

- 1 - Wing length >200 mm. 2
- 1' Wing length <200 mm. 13
- 2 Upper wing with a distinct, single, longitudinal white stripe that extends well into the outer half of the wing (Fig. 20a). 3
- 2' Upper wing without a white stripe extending into the outer half of the wing (Fig. 20b). 5
- 3 Shaft of outermost primary dark brown; dorsal body feathers blackish-brown; bill flattened laterally. AMERICAN OYSTERCATCHER
- 3' Shaft of outermost primary partially white; dorsal body feathering mottled or uniformly gray. 4
- 4 Front half of underwing mostly black; most secondaries mottled above; tail brownish gray mottled with darker gray; bill 50-65 mm long and not swollen dorsally near tip (Plate 22-1). WILLET
- 4' Underwing mostly white and medium gray with some black feathers where it meets the body; tail white, irregularly barred with blackish-brown; bill 25-35 mm long and swollen dorsally near tip (Plate 20-7). BLACK-BELLIED PLOVER
- 5 Upper wing without barring, spots or mottling and completely or nearly completely black or black-brown. 6
- 5' Upper wing not as in 5. 7
- 6 Upper wing nearly or completely black with green iridescent sheen; tail gray; bill slender, straight to very slightly upturned and not compressed laterally; belly white. BLACK-NECKED STILT
- 6' Upper wing nearly or completely blackish-brown without iridescence; tail dark brown; bill stout and compressed laterally (Fig. 7); belly brown-black. BLACK OYSTERCATCHER



Figure 20.

Shorebird wings, showing the (a) presence (Ruddy Turnstone) or (b) absence (Pectoral Sandpiper) of a wing stripe. (c) shows underside of a Dunlin wing with wrist markings.

KEY TO SHOREBIRDS (Cont.)

- 7 Inner half of upper wing with extensive white trailing and leading edges; tail grayish-white or very pale gray; bill slender and markedly upturned (Plate 23-6). AMERICAN AVOCET
- 7' Inner half of upper wing without extensive white areas; tail with barring; ventral body feathering never uniform white or blackish. 8
- 8 Lighter portion of underwings pink, buff or cinnamon; tail brown and barred. 9
- 8' Lighter portion of underwings whitish; tail white to pale buff with dark brown barring. 12
- 9 Underwing more cinnamon or buff than dusky; bill curved downwards or upwards. 10
- 9' Underwing more dusky than pink or buff; bill curved downwards and almost always <100 mm long. 11
- 10 Underside of primaries cinnamon with a variable amount of gray speckling; bill curved upwards (Plate 23-4). MARBLED GODWIT
- 10' Underside of primaries cinnamon with dusky bars; bill curved downward (Plate 23-1). LONG-BILLED CURLEW
- 11 Tail pale rufous or orange-brown, heavily barred with dusky brown. BRISTLE-THIGHED CURLEW
- 11' Tail olive or buffy olive with heavy, dusky brown barring. WHIMBREL
- 12 Wing length >215 mm; upper surface of primary shafts 9 and 10 white; bill length >70 mm. BAR-TAILED GODWIT
- 12' Wing <215 mm; upper surface of shaft of primary 9 much browner than that of primary 10; bill <70 mm. GREATER YELLOWLEGS
- 13 Upper wing with distinct longitudinal white stripe (Fig. 20a). 22
- 13' Upper wing without distinct longitudinal white stripe (Fig. 20b). 14

KEY TO SHOREBIRDS (Cont.)

- 14 Shaft of outermost primary light brown on upper surface, outer web of outermost primary whitish in contrast to much darker inner web; tail with much orangish coloration; bill length 50-80 mm. COMMON SNIPE
- 14' Shaft of outermost primary usually whitish over much of its length; outer web of outermost primary dark as in inner web; tail not extensively orange. 15
- 15 Inner half of upper wing with white or golden spots. 16
- 15' Inner half of upper wing not spotted. 18
- 16 Front half of underwings (underwing coverts) brownish-gray; upper wing often with yellow or golden spots; tail dusky, irregularly barred with grayish-white or gray and yellowish; bill swollen dorsally near tip (Plate 20-6). AMERICAN GOLDEN PLOVER
- 16' Front half of underwings white with gray and brown barring; much of tail whitish with dusky barring; bill not swollen dorsally near tip. 17
- 17 Wing length >175 mm; bill length >47 mm. GREATER YELLOWLEGS
- 17' Wing <175 mm; bill <47 mm. LESSER YELLOWLEGS
- 18 Wing 160-190 mm; gray or white-tipped gray feathers dominate front half of underwing; tail and rump uniformly slate-gray. WANDERING TATTLER
- 18' Wing <160 mm; white feathering conspicuous in some areas on front half of underwing; tail and rump not as in 18. 19
- 19 Inner secondaries with conspicuous white zig-zagging bars; bill length >50 mm; tail barred white and black. LONG-BILLED or SHORT-BILLED DOWITCHER
- 19' Wings and bill not as above. 20
- 20 Central tail feathers mouse gray, outer tail feathers irregularly barred on inner web; toes lobed, margined laterally with conspicuous membrane (Plate 37-6); breast never streaked, spotted or barred but occasionally washed with gray or brown. WILSON'S PHALAROPE

KEY TO SHOREBIRDS (Cont.)

- 20' Central tail feathers black; toes not lobed, without lateral membranes (Plate 37-3); breast with some spotting, streaking or barring at least on sides. 21
- 21 Outermost tail feather distinctly shorter than adjacent ones; shaft of outermost primary usually partially brown dorsally. SHARP-TAILED SANDPIPER
- 21' Outermost tail feather equal to or slightly longer than adjacent one; shaft of outermost primary usually entirely white. PECTORAL SANDPIPER
- 22 Inner half of extended upperwing has a white patch where wing attaches to body (Fig. 20a); tail feathers white with broad black band on outer half. 23
- 22' Upperwing without white patch where wing attaches to body. 24
- 23 Upperwing blackish brown and white without gray-brown, buff or rufous coloration, (except in juveniles where some feathers may be finely buffy-tipped); throat gray-brown to brown-black. BLACK TURNSTONE
- 23' Upperwing coverts with considerable gray-brown, buff or rufous; throat mostly white. RUDDY TURNSTONE
- 24 Wing length >180 mm; front half of underwing mostly black; tail brownish gray mottled with darker gray. WILLET
- 24' Wing not as in 24. 25
- 25 Wing >170 mm; underwing white and gray with some sharply contrasting black feathers where it meets the body; tail white and irregularly barred with blackish-brown; bill 25-35 mm long and swollen dorsally near tip (Plate 20-7). BLACK-BELLIED PLOVER
- 25' Wing not as in 25. 26
- 26 Wing length <115 mm; many upperwing coverts gray-brown with a dark bar near the tip; underwing shows distinct longitudinal white stripe; tail grayish-brown with lateral feathers broadly barred white; body white ventrally or white with heavy black spotting. SPOTTED SANDPIPER

KEY TO SHOREBIRDS (Cont.)

- 26' Wing not as in 26. 27
- 27 Wing length >140 mm, shaft of outermost primary markedly bicolored, white and dark brown on upper surface; bill shorter than head and swollen dorsally near tip (Plate 20-5); rump orange-brown; two dark breast bands. KILLDEER
- 27' Wing not as in 27. 28
- 28 White on upper surface of outer web of two or more of inner 6 primaries restricted to a patch adjacent to shaft and not extending to leading edge of feather (Fig. 21-5); wing length 110-130 mm; bill swollen dorsally near tip, 9-15 mm long; one dark neck band. SEMIPALMATED PLOVER
- 28' Wing does not fit both the above conditions. 29

Figure 21. Color patterns of shorebird feathers.

FIFTH PRIMARIES - NATURAL SIZE

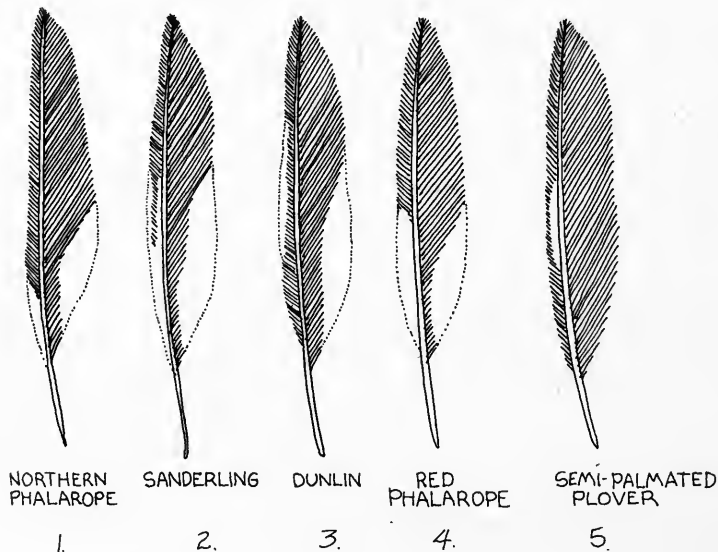

KEY TO SHOREBIRDS (Cont.)

- 29 Underwings light and lacking conspicuous dark markings on leading edge; bill swollen dorsally near tip; hind toe lacking. 30
- 29' Underwings mostly dark or if light then with conspicuous dark markings on the leading edge (Fig. 20c). 31
- 30 Wing length 135-160 mm; bill length 18-24 mm; dark shoulder patch absent; tail gray-brown basally, dark toward tip. MOUNTAIN PLOVER
- 30' Wing 90-115 mm; bill 12-17 mm; shoulder patch present; outer portion of tail whitish with central portion grayish-brown and darker toward tip. SNOWY PLOVER
- 31 White on upper surface of outer web of the 5th primary runs from the feather margin to shaft (Fig. 21-1,2 and 4). 32
- 31' White on upper surface of outer web of the 5th primary does not reach shaft (Fig. 21-3). 35
- 32 Wing length 160-190 mm; tail white basally, dusky near tip. SURFBIRD
- 32' Wing <160 mm. 33
- 33 Black on outer web of 5th primary meets shaft at obtuse angle (Fig. 21-2); toes not lobed. SANDERLING
- 33' Black on outer web of 5th primary meets shaft at acute angle (Fig. 21-1,4); toes lobed. 34
- 34 Wing length 100-118 mm; bill tapering gradually toward sharp tip (Plate 21-3). NORTHERN PHALAROPE
- 34' Wing 120-140 mm; bill swells noticeably laterally near tip before tapering to a point (Plate 21-2). RED PHALAROPE
- 35 Wing length 145-180 mm; secondaries all dark; tail pale brownish-gray, not conspicuously darker centrally. RED KNOT
- 35' Wing <145 mm. 36

KEY TO SHOREBIRDS (Cont.)

- 36 Wing length 109-144 mm. 37
- 36' Wing 80-108 mm. 42
- 37 Shafts of secondaries lack any brown coloration on upper surface; hind toe absent; bill swollen dorsally near tip (Plate 20-3); breast never spotted or streaked. WILSON'S PLOVER
- 37' Shafts of some secondaries have brown on upper surface, ranging from entirely brown to having merely a thin, longitudinal brown streak. 38
- 38 One to four of the inner secondaries predominantly (90% or more) white. 39
- 38' No secondaries predominantly white. 40
- 39 One to two inner secondaries predominantly white; bill black; legs black. DUNLIN
- 39' Three to four inner secondaries predominantly white; ridge on dorsal surface of upper mandible and base of lower mandible brownish; legs yellow or greenish. ROCK SANDPIPER
- 40 No conspicuous white rump patch. BAIRD'S SANDPIPER
- 40' Conspicuous white rump patch (white rump feathers may have some dark brown markings). 41
- 41 Central tail feathers gray; bill noticeably curved downwards, >30 mm long (Plate 24-8). CURLEW SANDPIPER
- 41' Central tail feathers brown-black; bill straight, <30 mm long. WHITE-RUMPED SANDPIPER
- 42 Anterior toes with no trace of webbing (as in Plate 37-3). 43
- 42' Distinct partial web between outer and middle and inner and middle toes (somewhat like Plate 37-2). 44

KEY TO SHOREBIRDS (Cont.)

- 43 = Legs and feet yellowish; throat white, with or without brownish streaking; breast always with brownish streaking; bill width at nail <1.4 mm; wing length 81-96 mm. LEAST SANDPIPER
- 43' Legs and feet black; throat white and breast with gray or buffy-gray wash OR throat rufous and breast with dusky streaking or spotting; bill width at nail >1.4 mm; wing 93-108 mm. RUFIOUS-NECKED SANDPIPER
- 44 Bill length usually <20.0 mm; bill length <10 times bill width at nail. SEMIPALMATED SANDPIPER
- 44' Bill usually >20.0 mm; length >10 times bill width at nail. WESTERN SANDPIPER

KEY TO SKUAS AND JAEGERS

- 1 Large and stout birds; wing length >380 mm; tarsus shorter than middle toe with claw. SKUA, probably SOUTH POLAR SKUA
- 1' Smaller and slightly built; wing <375 mm; tarsus longer than middle toe. 2
- 2 Bill deeper than wide at base, 38-44 mm long; wing length 349-374 mm; tarsus 48-55 mm. POMARINE JAEGER
- 2' Bill wider than deep at base, 27-35 mm long; wing 295-341 mm; tarsus 38-46 mm. 3
- 3 Humerus (wing bone from shoulder to elbow) 94-105 mm long; tarsi and feet almost always black (occasionally bluish in juveniles); bill saddle along culmen usually longer than chord of nail (see Fig. 5). PARASITIC JAEGER
- 3' Humerus 83-88 mm; legs and basal half of toes and webs bluish, remainder of feet black; bill saddle along culmen usually shorter than chord of nail. LONG-TAILED JAEGER

KEY TO GULLS

- | | | |
|----|--------------------------------------------------------------------------------------------------------------------|------------------------|
| 1 | Outer 5 primaries wholly white. | 23 |
| 1' | Outer 5 primaries <u>not</u> wholly white. | 2 |
| 2 | Outer 5 primaries white with black tips; body plumage white with black spots. | IVORY GULL, first year |
| 2' | Outer 5 primaries not white with black tips. | 3 |
| 3 | Wing length <325 mm. | 4 |
| 3' | Wing >325 mm. | 24 |
| 4 | Wing >295 mm. | 5 |
| 4' | Wing <295 mm. | 8 |
| 5 | Outer three primaries uniformly blackish (check inner webs carefully). | 15 |
| 5' | Outer three primaries with white or gray areas. | 6 |
| 6 | Outer three primaries extensively white, with black tips <u>and</u> dark (gray to black) trailing edges (Fig. 22). | 17 |
| 6' | Primaries not as above. | (KITTIWAKE) 7 |

Figure 22. Outer three primaries of the Black-headed Gull.

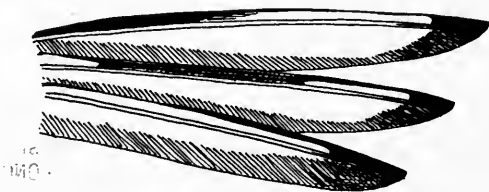

KEY TO GULLS (cont.)

- 7 - Mantle (see Fig. 11) dark gray; culmen length 20 mm or less; tarsus red, and very brightly so in fresh specimens. 18
- 7' Mantle pale gray; culmen 31 mm or more; tarsus black or grayish. 19
- 8 Wing length <230 mm. 20
- 8' Wing >230 mm. 9
- 9 Upper wing surface with three bold triangles of more or less solid color: outer primaries forming black triangle, inner primaries and secondaries forming white triangle, wing coverts and back forming gray or brown triangle (Fig. 23c); tail slightly forked. 21
- 9' Upper wing surface not displaying triangles of solid color. 10
- 10 Wing mostly uniform gray above and below, except black leading edge to outer primary; central tail feathers longer than outer tail feathers; pink cast to underparts. ROSS' GULL, adult
- 10' Not as above. 11
- 11 Outer primaries with conspicuous white areas. 22
- 11' Outer primaries uniformly dark, or with very small white areas at tips; tail white with black band not extending to two outermost tail feathers. FRANKLIN'S GULL, first year
- 12 Wing length >275 mm; underside of wing grayish. 17
- 12' Wing <275 mm. 13
- 13 Upper wing surface with brown or black bar at base of secondaries (Fig. 23b). 14
- 13' Upper wing surface without brown or black bar at base of secondaries. BONAPARTE'S GULL, adult

KEY TO GULLS (cont.)

Figure 23. Color patterning in the extended wings of (a) immature Black-legged Kittiwake and (b) immature Bonaparte's Gull, and (c) immature Sabine's Gull.

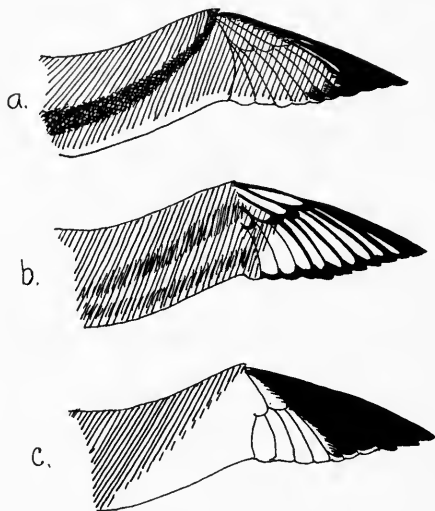

- 14 Wing bar at base of secondaries black; tail distinctly wedge-shaped (central tail feathers longer than outer tail feathers).
ROSS' GULL, first year
- 14' Wing bar at base of secondaries brown; tail not as above.
BONAPARTE'S GULL, first year
- 15 Tail white with black band; top of head, neck and back uniformly brown; wings with brownish cast.
LAUGHING GULL, first year
- 15' Tail white or nearly so; top of head, neck and back not uniformly brown. 16
- 16 Head white with dusky spotting on nape usually extending down neck; wings with brownish cast.
LAUGHING GULL, second year
- 16' Head hooded with black (summer) OR white with dusky spotting on upper nape (winter); wings without brownish cast.
LAUGHING GULL, adult

KEY TO GULLS (Cont.)

- 17 Upper surface of wing with brown bar at base of secondaries (as in Fig. 23a); tail white, banded with black; head with a dark spot behind eye. BLACK-HEADED GULL, first year
- 17' Upper surface of wing without brown bar at base of secondaries; tail white; head black (summer) OR white with dark spot behind eye (winter). BLACK-HEADED GULL, adult
- 18 Outer primary coverts with black; back of neck spotted with black; in outer three primaries, leading edge as dark as tips. RED-LEGGED KITTIWAKE, first year
- 18' Outer primary coverts pure gray; back of neck white; in outer three primaries, only outermost as in 18, the other two are dark only at tips. RED-LEGGED KITTIWAKE, adult
- 19 Upper surface of wing with dark bar at base of secondaries (Fig. 23a); hind neck (nape) with blackish collar; tail white with black band; in outer three primaries, leading edge as dark as tips. BLACK-LEGGED KITTIWAKE, first year
- 19' Upper surface of wing gray without dark bar at base of secondaries; tail pure white; head white (summer) OR smudged with gray on hind neck (winter); in outer three primaries, only outermost as in 19, the other two are dark only at tips. BLACK-LEGGED KITTIWAKE, adult
- 20 Upper surface of wing with bold black bar at base of secondaries (as in Fig. 23a); back feathers dull black with broad white edgings; tail white with black band. LITTLE GULL, first year
- 20' Upper surface of wing and back uniform gray; tail white; head black (summer) OR white with gray smudge on hind neck and black spot behind eye (winter). LITTLE GULL, adult
- 21 Top of head, back and adjacent wing surfaces brownish-gray; tail white, banded with black. SABINE'S GULL, first year
- 21' Back and adjacent wing surfaces uniform gray; head black (summer) OR white with black spot behind eye (winter); tail white. SABINE'S GULL, adult
- 22 Secondaries and tertials gray with conspicuous white tips. FRANKLIN'S GULL, adult

KEY TO GULLS (Cont.)

- 22' Secondaries and tertials not gray with conspicuous white tips. 12
- NOTE: Albino gulls of many species may key out to this step. Identification of albino gulls usually requires comparison with known material by someone very knowledgeable about gulls. Interesting specimens should be saved. Pure white birds or birds with excessively worn and bleached feathers should be treated cautiously.
- 23 Wing length <360 mm; plumage all white; legs black; bill black with yellow tip. IVORY GULL, adult
- 23' Wing >425 mm; plumage usually with some buffy or gray. 61
- 24 Tail nearly all white (dark smudge may be present on a few tail feathers). 25
- 24' Tail not all white. 34
- 25 Head entirely white OR head and neck with dusky streaks; wing length usually >330 mm. 26
- 25' Head black, brown or gray OR head white with a blackish smudging on top extending down back of the neck; wing usually <330 mm. 15
- 26 Wing tips without black. GLAUCOUS-WINGED GULL, adult
- NOTE: Glaucous-winged Gulls interbreed with Western and Herring Gulls. The progeny often have very dark wing tips and may be confused with Western, Herring or Thayer's Gulls. Beach walkers in northern California, Oregon, Washington and British Columbia should be cautious of this problem.
- 26' Wing-tips with black (sometimes dark gray). 27
- 27 Outer three primaries not distinctly darker than inner primaries and secondaries; mantle dark, slate gray.
- 27' Outer three primaries distinctly darker than inner primaries and secondaries; mantle pearly to silver-gray. 30
- 28 Wing length >420 mm; two white spots (mirrors; see Fig. 16) or much terminal white in outer primaries; Bering Sea and Aleutians. SLATY-BACKED GULL, adult

KEY TO GULLS (Cont.)

- 28' Wing <420 mm; one white spot in outer primaries; Mexico to British Columbia. 29
- 29 Legs and feet bright yellow; Gulf of California and Salton Sea.
YELLOW-FOOTED WESTERN GULL, adult
- 29' Legs and feet pink; Pacific Coast of Baja California north to British Columbia. WESTERN GULL, adult
- NOTE: These two forms are usually indistinguishable without the leg color.
- 30 Bill plain yellow-green, sometimes with dusky subterminal mottling or dusky tip; outermost two primaries with large white spots near the tips; culmen usually <37 mm; eye dark. MEW GULL, adult
- 30' Lower mandible with red and/or black at gonydeal angle; culmen usually >37 mm. 31
- 31 Bill banded (both mandibles) with black (as in Fig. 15), no red at gonydeal angle; gray of back and wings very pale; eye and legs yellow. RING-BILLED GULL, adult
- 31' Lower mandible with red spot at angle. 32
- 32 Bill almost always with both black band and red at gonydeal angle; eye dark brown; legs bluish to greenish; gray of back and wings relatively dark. CALIFORNIA GULL, adult
- 32' Bill without black band; legs pink. 33
- 33 Upper surface of wing tips dark gray to black, under surface light gray; eye brownish often with dark flecks. THAYER'S GULL, adult
- 33' Upper surface of wing tip black, under surface dark gray to black; eye yellow without flecks. HERRING GULL, adult
- 34 Underparts uniform dark gray or brown; no mottling. 59
- 34' Underparts mostly white OR mottled with brown or gray. 35

KEY TO GULLS (Cont.)

- 35 Tail with distinct dark subterminal band (see Fig. 15). 36
- 35' Tail not distinctly banded (usually with areas of dark and light mottling). 39
- 36 Band along wing at base of secondaries (greater secondary coverts) gray; culmen usually >37 mm. 37
- 36' Band along wing at base of secondaries (greater secondary coverts) brownish; culmen usually <37 mm. 38
- 37 Upper wing (lesser and middle) coverts brownish, tipped with white; primaries more or less pointed. RING-BILLED GULL, first year
- 37' Upper wing (lesser and middle) coverts gray; primaries more or less rounded. RING-BILLED GULL, second year
- 38 Secondaries browner than mantle; primaries more or less pointed. MEW GULL, first year
- 38' Secondaries gray like mantle; primaries more or less rounded. MEW GULL, second year
- 39 Tail with gray or buffy, no dark brown. 40
- 39' Tail with dark brown or black, sometimes largely white or largely brown. 45
- 40 Back between wings brown or gray-brown, much mottled; underparts clouded and flecked with gray-brown; bill black. 41
- 40' Back between wings primarily "gull-gray"; underparts more or less white; tail with much white basally; bill with some paleness basally. 42
- 41 Bill rather large and heavy, gonyes prominent (Plate 26a-4); primaries gray on both upper and under surfaces. GLAUCOUS-WINGED GULL, first year
- 41' Bill more slender, gonyes slight (Plate 26b-2); primaries usually dark gray-brown to black on upper surface and light gray on under surface with distinct paler borders at the tips. THAYER'S GULL, first year

KEY TO GULLS (Cont.)

- 42 Back between wings "gull-gray"; wing coverts brown; bill pale at base but dark towards tip, lacking red or orange at gonydeal angle. 43
- 42' Back between wings and wing coverts mostly "gull-gray"; bill yellowish, usually with a trace of orange at angle and dusky towards tip; underparts nearly all white. 44
- 43 Bill rather large and heavy (Plate 26a-4); primaries gray on both upper and under surfaces. GLAUCOUS-WINGED GULL, second year
- 43' Bill more slender (less pronounced gonydeal angle; Plate 26b-2); primaries usually dark gray-brown to black on upper surface with distinct paler borders, pale gray on under surface. THAYER'S GULL, second year
- 44 Bill rather large and heavy (Plate 26a-4); primaries gray on both upper and under surfaces. GLAUCOUS-WINGED GULL, third year
- 44' Bill more slender (less pronounced gonydeal angle; Plate 26b-2); primaries usually dark gray-brown to black on upper surface, pale gray on under surface. THAYER'S GULL, third year
- 45 Back between wings light to dark brown, mottled. 46
- 45' Back between wings light to dark "gull-gray", not mottled. 51
- 46 Bill all black (maybe some pale areas basally in late spring). 47
- 46' Bill with pale area basally. 50
- 47 Body plumage very dark brown; outer primaries not distinctly darker than inner primaries and secondaries; tail nearly solid dark brown; bill large with a prominent gonydeal angle. 48
- 47' Plumage generally paler; outer primaries distinctly darker than inner primaries and secondaries. 49
- 48 Wing length >410 mm; body barred or finely speckled, the dusky areas usually exceeding the white; unusual north of British Columbia. WESTERN GULL, first year

KEY TO GULLS (Cont.)

- 48' Wing <410 mm; body coarsely spotted, the white areas usually exceeding the dark; not to be expected outside of the Bering Sea and Aleutian area in the eastern Pacific Ocean.
SLATY-BACKED GULL, first year
- 49 Bill rather slender (less pronounced gonydeal angle; Plate 26b-2); primaries dark brown to black on upper surface, usually with distinct pale edgings, pale gray to brown on under surface.
THAYER'S GULL, first year
- 49' Bill large with prominent gonydeal angle (Plate 26a); primaries very dark brown on both upper and under surfaces.
YELLOW-FOOTED WESTERN GULL, first year
- 50 Bill pink in basal half with clearly defined blackish tip.
CALIFORNIA GULL, first year
- 50' Bill with pink base gradually fusing into blackish tip.
HERRING GULL, first year
- 51 Back between wings "gull-gray"; wing coverts and secondaries brown; tail usually largely dark brown. 52
- 51' Back between wings, wing coverts and secondaries more or less uniform "gull-gray", sometimes with a brownish cast; tail usually with some white at the base and at very tip of the feathers. 55
- 52 Back between wings dark gray; outer three primaries not distinctly darker than inner primaries and secondaries. WESTERN GULL, second year
- 52' Back between wings light gray; outer three primaries distinctly darker than inner primaries. 53
- 53 Legs dull bluish; eye dark brown; primaries very dark brown without conspicuous edgings. CALIFORNIA GULL, second year
- 53' Legs pink; eye pale brown or yellow. 54
- 54 Primaries dark brown on both upper and under surfaces, without conspicuous pale edgings; eye pale yellow. HERRING GULL, second year

KEY TO GULLS (Cont.)

- 54' Primaries dark brown with conspicuous pale edgings; underside of primaries pale brown; eye brown. THAYER'S GULL, second year
- 55 Tail nearly all dark. YELLOW-FOOTED WESTERN GULL, second year
- 55' Tail mostly white, with dark spots on all or some tail feathers. 56
- 56 Outer three primaries not distinctly darker than inner primaries and secondaries; bill with prominent gonydeal angle (Plate 26a-2). WESTERN GULL, third year
- 56' Outer three primaries distinctly darker than inner primaries and secondaries; gonydeal angle not as prominent (Plate 26b). 57
- 57 Legs bluish-gray to greenish; iris dark brown. CALIFORNIA GULL, third year
- 57' Legs bright pink; iris yellow or brownish. 58
- 58 Iris clear yellow; under surface of primary tips black. HERRING GULL, third year
- 58' Iris brown, often flecked with dark brown; under surface of primary tips pale gray. THAYER'S GULL, third year
- 59 Bill red with black tip; mantle and adjacent wing surface dark slate-gray; tail black, tipped with white. HEERMANN'S GULL, adult
- 59' Bill pale pink at base with black tip; mantle and adjacent wing surfaces dark gray washed with brown OR these areas dark brown; tail dark blackish-brown, lacking white tip. 60
- 60 Mantle is pure dark gray; adjacent wing surfaces with some dark brown; head and underparts medium gray. HEERMANN'S GULL, second year
- 60' Plumage wholly dark chocolate brown, somewhat paler on upper wing surface. HEERMANN'S GULL, first year

KEY TO GULLS (Cont.)

- 61 Plumage marbled with pinkish-buff feather edgings; bill pink basally, with clearly defined black tip; primaries more or less pointed, tail feathers rounded at tips. GLAUCOUS GULL, first year
- 61' Plumage paler, nearly all white, sometimes with pale gray on back; primaries more rounded, tail feathers more squarish at tips. 62
- 62 Pale gray feathers present on back. 63
- 62' No pale gray on back, some individuals may approach pure white. GLAUCOUS GULL, second year
- 63 Tail pure white; bill yellow with red spot at gonydeal angle. GLAUCOUS GULL, adult
- 63' Tail often freckled with dusky or smudged terminally; bill usually with a dusky band near tip. GLAUCOUS GULL, third year

KEY TO TERNS AND SKIMMERS

- 1 Basic color of upper surface of wings, back and hind neck dark brown, black or dark charcoal-gray (tips of secondaries may be white) - close in color to back of head, but sometimes with buffy feather edgings. 2
- 1' Basic color of upper wings, back and hind neck light gray, or pearly to silver-gray; sometimes neck almost white, otherwise much lighter than cap or back of head; sometimes with buffy feather edgings. 7
- 2 Wing length <225 mm; webbing extending only half way to end of toes (Plate 37-2). 3
- 2' Wing >270 mm; toes fully webbed. 4
- 3 Brown edgings on wing coverts; belly white. BLACK TERN, immature
- 3' Wing coverts entirely charcoal-gray; belly black or white. BLACK TERN, adult
- 4 Wing length 270-300 mm; upper surface of wing entirely black or dark brown except that coverts may have buffy tips; tarsus 20-25 mm. 5
- 4' Wing 338-412 mm; secondaries broadly tipped with white; tarsus 28-37 mm. 6
- 5 Upper surface of wings entirely jet black; belly white. SOOTY TERN, adult
- 5' Wing coverts with buffy tips; belly charcoal-gray. SOOTY TERN, immature
- 6 Upper wing jet black except for white in secondaries (sometimes on inner primaries). BLACK SKIMMER, adult
- 6' Upper wing coverts with light tips, otherwise upper wing dark brown. BLACK SKIMMER, immature
- 7 Wing length >295 mm; tarsus >27 mm. 8
- 7' Wing <290 mm; tarsus <24 mm. 15

KEY TO TERNS AND SKIMMERS (Cont.)

- 8 Both webs of outer 4 primaries entirely dark; wing length 400-423 mm; tarsus 40-46 mm. 9
- 8' Outer web of outer 4 primaries dark, inner web white except for broad dark stripe next to shaft (Fig. 24a); wing <395 mm; tarsus <36 mm. 10
- 9 Wing coverts each with dark brown V bordered by white. CASPIAN TERN, immature
- 9' Wing coverts pearly gray (primaries darker). CASPIAN TERN, adult
- 10 Wing length 357-393 mm. 11
- 10' Wing <330 mm. 12
- 11 Some wing coverts with dark outer portions. ROYAL TERN, immature
- 11' Wing coverts pearly gray. ROYAL TERN, adult
- 12 Dark coloration in webbing of outer primaries very light, in primaries 7-9 white of inner web grading gradually to dark area near shaft (Fig. 24b). 13
- 12' Dark coloration in primary webbing very dark, forming a dark stripe near shaft very distinct from outer portion of inner web (Fig. 24a). 14
- 13 Brown or buffy edgings to feathers of back and wing coverts. GULL-BILLED TERN, immature
- 13' No buffy edgings on any feathers. GULL-BILLED TERN, adult
- 14 Buffy edgings to feathers on back and wing coverts. ELEGANT TERN, immature
- 14' No buffy edgings on any feathers. ELEGANT TERN, adult
- 15 Very small; wing length <180 mm. 16
- 15' Wing 230-290 mm. 17

KEY TO TERNS AND SKIMMERS (Cont.)

- 16 Tips of upper wing coverts buffy, each with a dark center within buffy area. LEAST TERN, immature
- 16' Coverts pearly gray. LEAST TERN, adult
- 17 Dark stripe along shaft on inner web (contrasting with white along outer edge) distinct only in primaries 10 and 9; inner primaries largely dusky throughout. 18
- 17' Dark stripe referred to in 17 very distinct on at least the outer 6 primaries. 19
- 18 Upper wing coverts with buffy edges. FORSTER'S TERN, immature
- 18' Upper wing coverts entirely pearly gray. FORSTER'S TERN, adult
- 19 Inner web of primary 10 colored like 9, having both a dark stripe along shaft and a dark border along outer edge from tip inward about 1/3 the way toward wing bone (Fig. 24c). 20
- 19' Inner web of primary 10 without dark border referred to in 19, OR border extending for only a few mm (Fig. 24d). 21
- 20 Greater upper wing coverts broadly tipped with white. ALEUTIAN TERN, immature
- 20' Greater wing coverts dark. ALEUTIAN TERN, adult
- 21 Viewed from above, outer web of primary 10 usually about as dark (almost black) as stripe along shaft on inner web (as in Fig. 24a); primary 10 completely dark along outer 20-33 mm of tip; tarsus 17-21 mm, longer than middle toe without claw. 22
- 21' Outer web of primary 10 usually decidedly darker than stripe on inner web (as in Fig. 24b); primary 10 dark along outer 15-25 mm; tarsus 13-16 mm, shorter than middle toe without claw. 23
- 22 Feathers of back and wing coverts with buffy tips. COMMON TERN, immature
- 22' No buffy edges on any feathers. COMMON TERN, adult

KEY TO TERNS AND SKIMMERS (cont.)

- 23 Feathers of back and wing coverts with buffy tips. ARCTIC TERN, immature
- 23' No buffy edges on any feathers. ARCTIC TERN, adult

Figure 24. Color patterns of outer primaries in terns.



KEY TO ALCIDS

- 1 Large: exposed culmen >25 mm; wing length >162 mm; tarsus usually >30 mm. 2
- 1' Small: exposed culmen <25 mm; wing <160 mm; tarsus usually <30 mm. 16
- 2 Underwing linings mostly white. 3
- 2' Underwing linings mostly dark. 8
- 3 A great deal of white in wing coverts of upper surface of wing; secondaries dark; feet may be pink to intense red. 4
- 3' Upper surface of wing dark except that secondaries are broadly tipped with white; feet black or brown. (MURRE) 5
- 4 Scapulars and back feathers checkered with black and white; upper wing coverts mottled black and white. BLACK GUILLEMOT, immature
- 4' Scapulars and back black; upper wing coverts extensively white. BLACK GUILLEMOT, adult
- 5 Throat and entire head dark. 6
- 5' Throat and lower cheeks white. 7
- 6 Cutting edge of bill at base white or yellow (giving appearance of a light mustache); depth of bill at gonydeal angle >1/3 the exposed culmen. THICK-BILLED MURRE, breeding plumage
- 6' Bill entirely dark; depth of bill at gonydeal angle <1/3 the exposed culmen. COMMON MURRE, breeding plumage
- 7 White cheeks extending upward behind eye to cap, then posteriorly to back of head (where black cap extends down neck), a distinct dark line extending from eye back to intersect most of white on side of head (as in Fig. 25); bill as in 6'. COMMON MURRE, winter adult and first year
- 7' White of cheeks posterior to eye not extending above eye level, dark line back from eye region indistinct; bill as in 6. THICK-BILLED MURRE, winter adult and first year

Figure 25. Murre chick old enough to accompany adult at sea; natural size (1/3 the size of an adult) for comparison with Figure 26.



Figure 26. Ancient Murrelet and head of Xantus' Murrelet;
natural size, for comparison with Figure 25.



KEY TO ALCIDS (Cont.)

- | | | |
|-----|-----------------------------------------------------------------------------------------------------------------------------------------------------------------------------------------------------------|-----------------------------|
| 8 | Leading edge of wing black or dark brown. | 9 |
| 8' | Thin white line running along leading edge of wing from shoulder to wrist. | 11 |
| 9 | Extensive white coloration on upper surface of wing. | 10 |
| 9' | Upper wing surface entirely dark gray. | 14 |
| 10 | Upper wing coverts extensively white except for a black bar running part way through them. | PIGEON GUILLEMOT, adult |
| 10' | Upper wing coverts mottled black and white. | PIGEON GUILLEMOT, immature |
| 11 | Belly dark. | 12 |
| 11' | Belly white. | 13 |
| 12 | Face, including forehead, usually white; upper mandible usually with 2-3 vertical grooves (Plate 32-1); except during fall, long tufts of white to yellowish feathers extending backward from above eyes. | TUFTED PUFFIN, adult |
| 12' | Face (except small area behind each eye) dark; upper mandible smooth (Plate 32-6). | TUFTED PUFFIN, immature |
| 13 | Breast dark; face same gray color as remainder of head and upper surfaces (except that white plumes are often present). | 14 |
| 13' | Breast and belly white; dark collar extending around throat; face white or very light gray; no plumes. | 15 |
| 14 | White plumes projecting backward from behind eye and from cheek. | RHINOCEROS AUKLET, adult |
| 14' | White plumes on face absent. | RHINOCEROS AUKLET, immature |
| 15 | Face white. | HORNED PUFFIN, adult |
| 15' | Face light gray. | HORNED PUFFIN, immature |

KEY TO ALCIDS (Cont.)

- 16 Underwing lining (not flight feathers) white except for feathers along leading edge (Fig. 26). 17
- 16' Underwing lining dark, mottled, or light gray. 21
- 17 Wing length <105 mm; tips of secondaries white. 18
- 17' Wing >105 mm; tips of secondaries dark. 19
- 18 Dark collar completely encircling upper breast, separating throat from belly (Fig. 12a). LEAST AUKLET, breeding plumage
- 18' Collar around breast incomplete (Fig. 12b). LEAST AUKLET, winter adult or immature
- 19 Bill yellow to ivory (upper edge dark); culmen 12-16 mm; throat almost always entirely or partly dark (Fig. 26); wing length 122-141 mm. 20
- 19' Bill entirely dark, culmen 15-22 mm; throat entirely white (Fig. 26); wing 111-128 mm. XANTUS' MURRELET
- 20 Throat dark all the way to breast; long, thin white feathers prevalent above and behind eyes (an eyebrow) and on shoulders. ANCIENT MURRELET, breeding plumage
- 20' Throat mostly white except near base of bill (Fig. 26); long white feathers above eyes and on shoulder very sparse. ANCIENT MURRELET, winter adult or immature
- 21 Underwing linings mottled, white and gray. 22
- 21' Underwing linings entirely dark. 24
- 22 Feathers of throat and around anus gray. CASSIN'S AUKLET
- 22' Feathers of throat and around anus white (under down is gray). 23
- 23 Tail and flight feathers absent or tiny (Fig. 25); length of middle toe >32 mm. THICK-BILLED or COMMON MURRE, juvenile

KEY TO ALCIDS (Cont.)

- 23' Tail and flight feathers present (as in Fig. 26); length of middle toe <26 mm. CRAVERI'S MURRELET
- 24 Wing length <90 mm; primaries absent or tiny (Fig. 25). THICK-BILLED OR COMMON MURRE, juvenile
- 24' Wing >95 mm; primaries present. 25
- 25 Wing length 97-105 mm. 26
- 25' Wing >115 mm. 27
- 26 Bill red with white tip; long curved feathers form crest on forehead; white facial plumes very prominent. WHISKERED AUKLET, adult
- 26' Bill yellowish at base, dark at tip; no crest; white facial plumes present but not prominent. WHISKERED AUKLET, immature
- 27 Secondaries and tail feathers broadly (2-3 mm wide) tipped with white. 28
- 27' Wing and tail feathers dark except some coverts on upper surface of wing may be very narrowly edged with white. 29
- 28 Belly and breast white except many feathers tipped with dark brown, giving undersurfaces a speckled appearance; remainder of head and body plumage brown, streaked with white and buffy. KITTLITZ'S MURRELET, breeding plumage
- 28' Sides of head and all undersurfaces completely white except for a dark incomplete breast collar (Fig. 12b) and a very occasional feather with a dark tip; scapular and shoulder feathers white. KITTLITZ'S MURRELET, winter or immature
- 29 Scapulars cinnamon OR white. 30
- 29' Scapulars gray, same color as remainder of wing. 31
- 30 Scapulars cinnamon; undersurfaces of body with white feathers tipped with brown giving spotted appearance; upper surfaces dark. MARBLED MURRELET, breeding plumage

KEY TO ALCIDS (Cont.)

- 30' Scapulars white; undersurfaces of body largely white except for occasional dark tipped feathers; lower face white.
MARBLED MURRELET, winter and immature
- 31 Bird entirely gray except often some elongated white feathers on face. 32
- 31' White on belly and breast; remainder of plumage gray except often some elongated white feathers on face. 33
- 32 No elongated, curved feathers on forehead forming a crest; no white plumes on face. CRESTED AUKLET, immature
- 32' Elongated feathers forming a crest on forehead; white plumes extending backward from face. CRESTED AUKLET, adult
- 33 Throat dark; bill red; elongated white plumes extending backward from behind eye. PARAKEET AUKLET, breeding plumage
- 33' Throat light; bill dark; no elongated white plumes on face. PARAKEET AUKLET, winter adult and immature

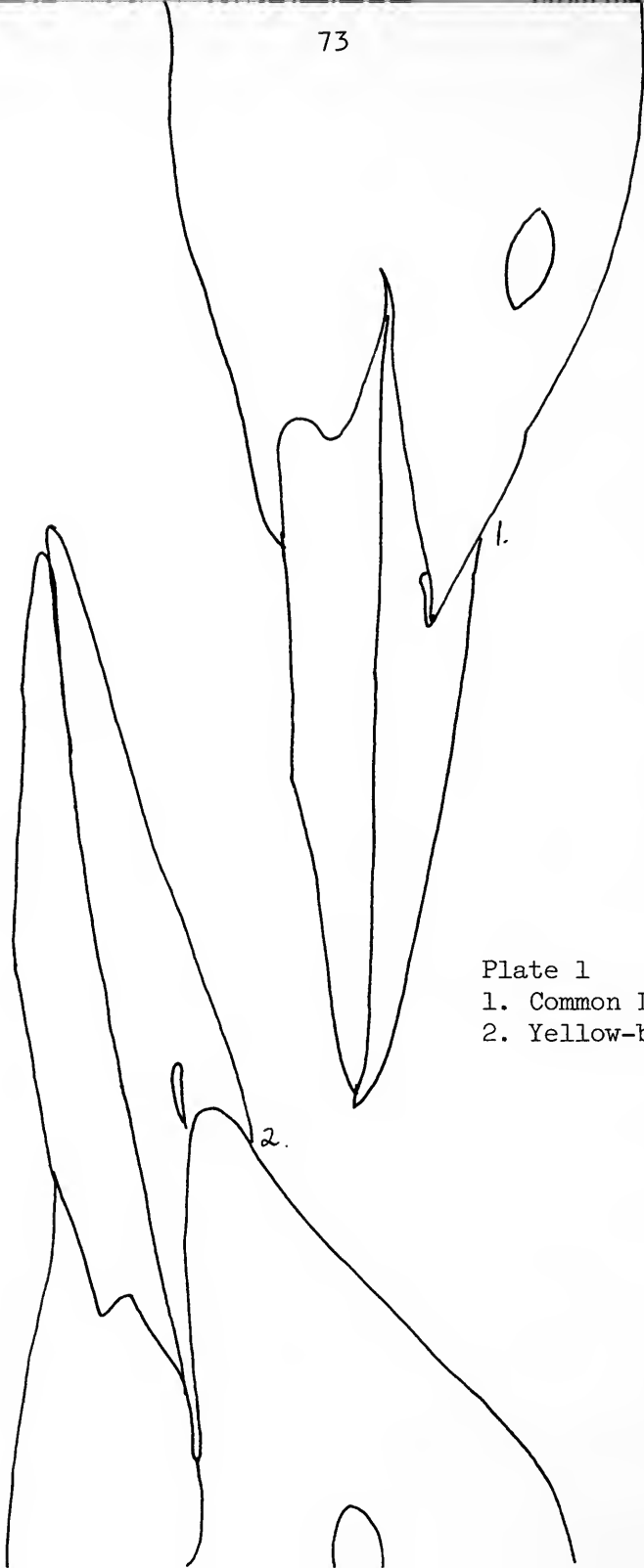

Plate 1

1. Common Loon

2. Yellow-billed Loon

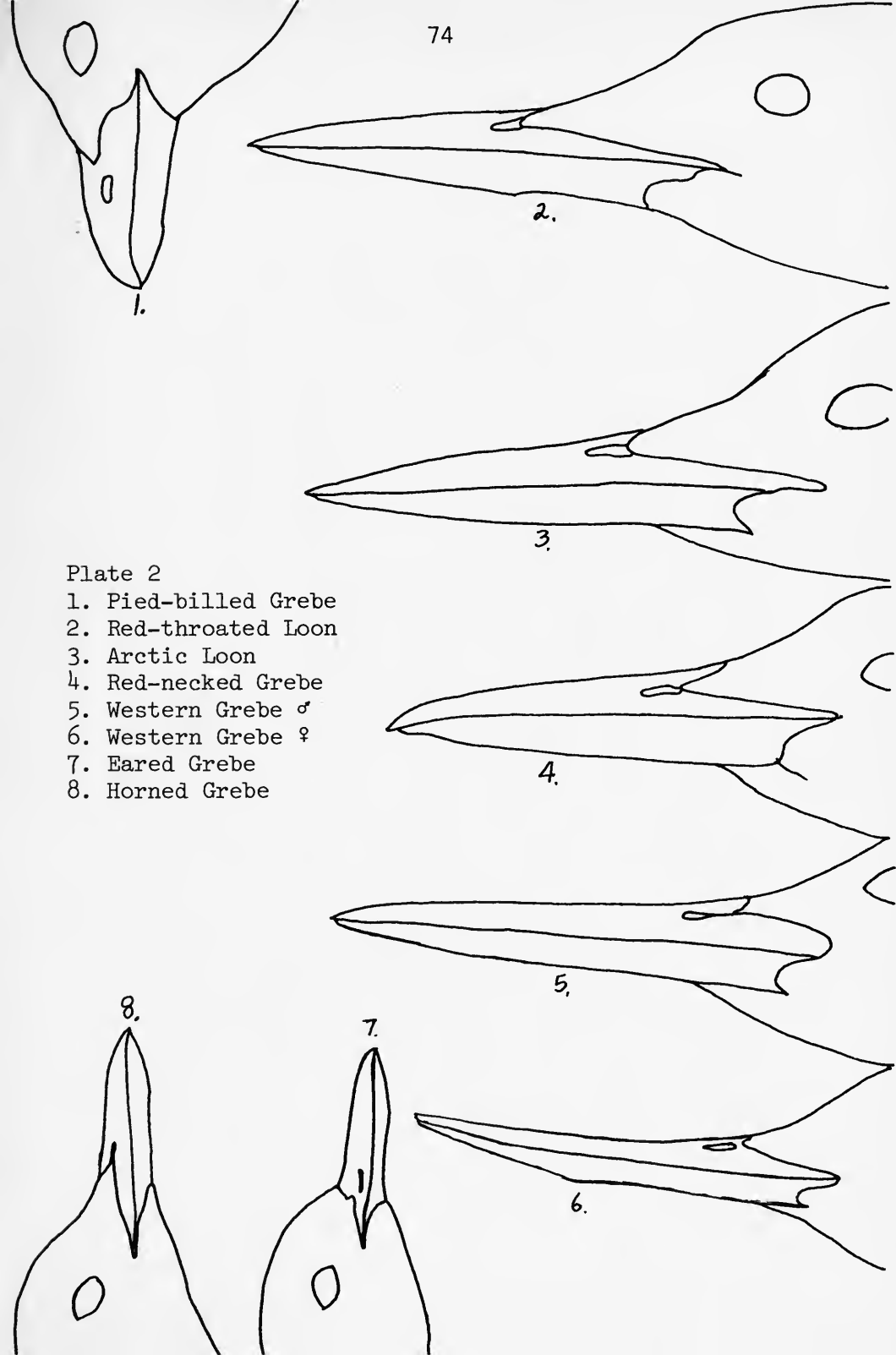

Plate 2

1. Pied-billed Grebe
2. Red-throated Loon
3. Arctic Loon
4. Red-necked Grebe
5. Western Grebe ♂
6. Western Grebe ♀
7. Eared Grebe
8. Horned Grebe

- 1. Short-tailed Albatross
- 2. Black-footed Albatross ♂
- 3. Black-footed Albatross ♀

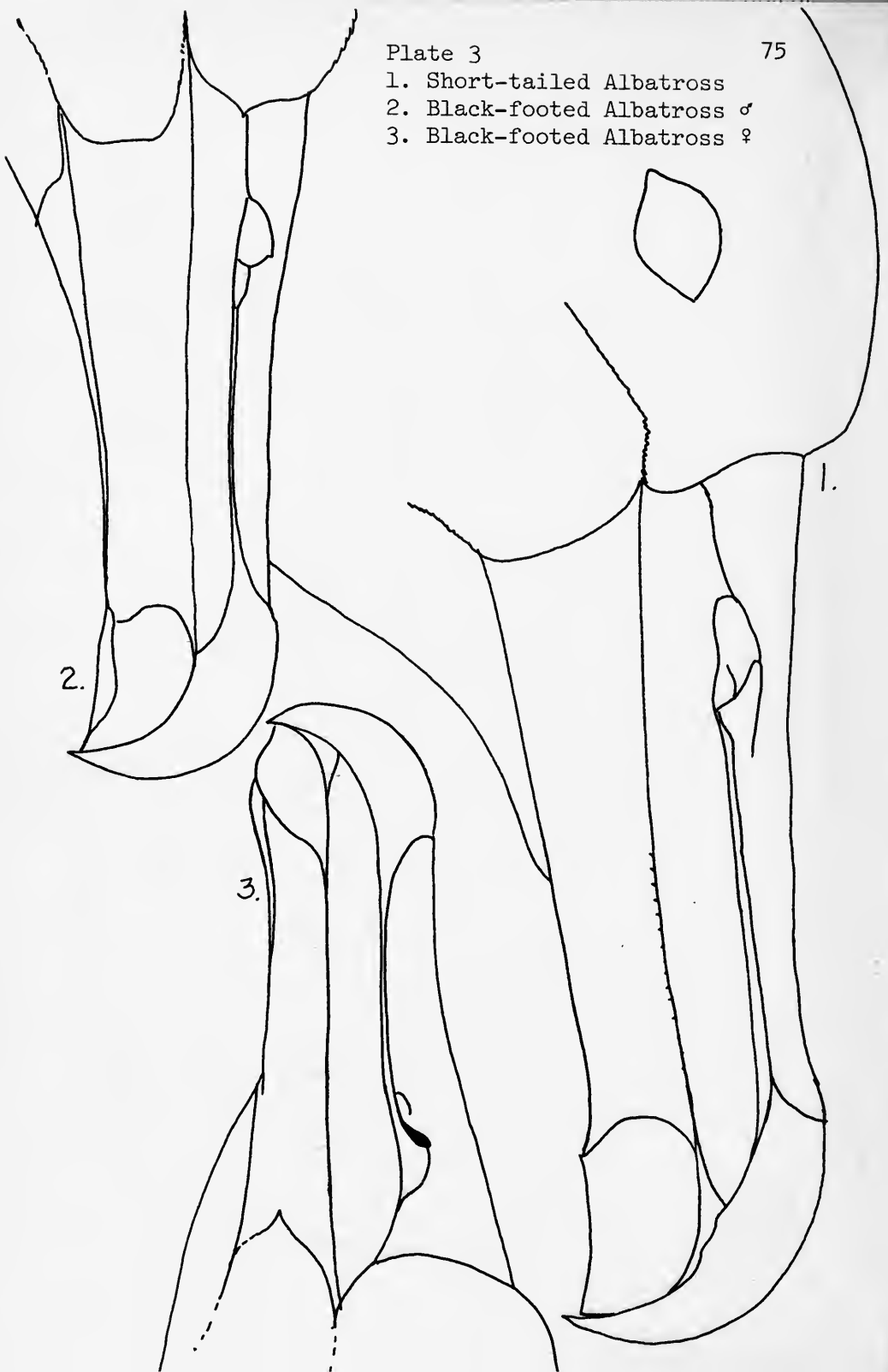

Plate 4

- 1. Frigatebird
- 2. Tropicbird
- 3. Laysan Albatross ♀
- 4. Laysan Albatross ♂

2.

1.

4.

3.

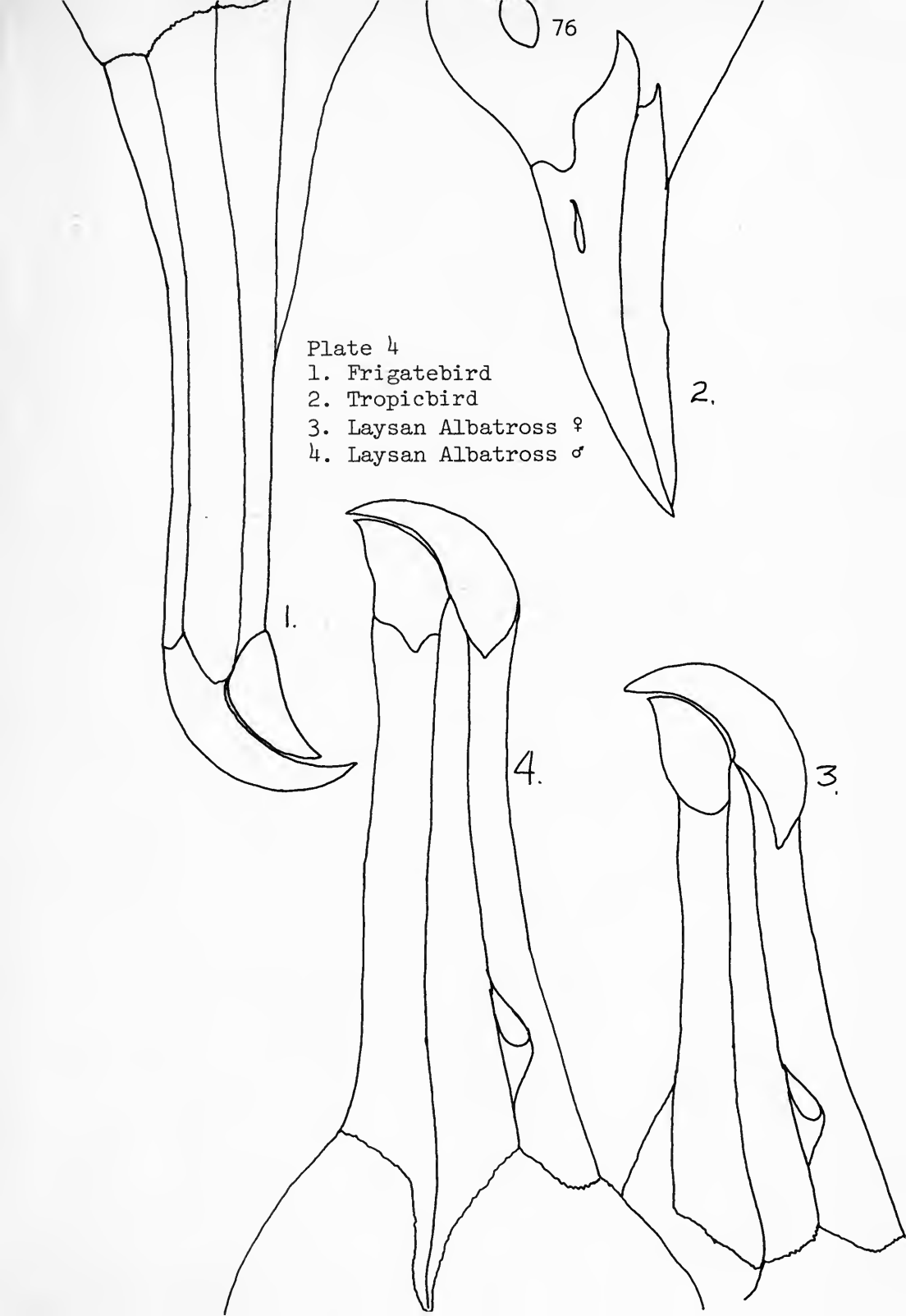
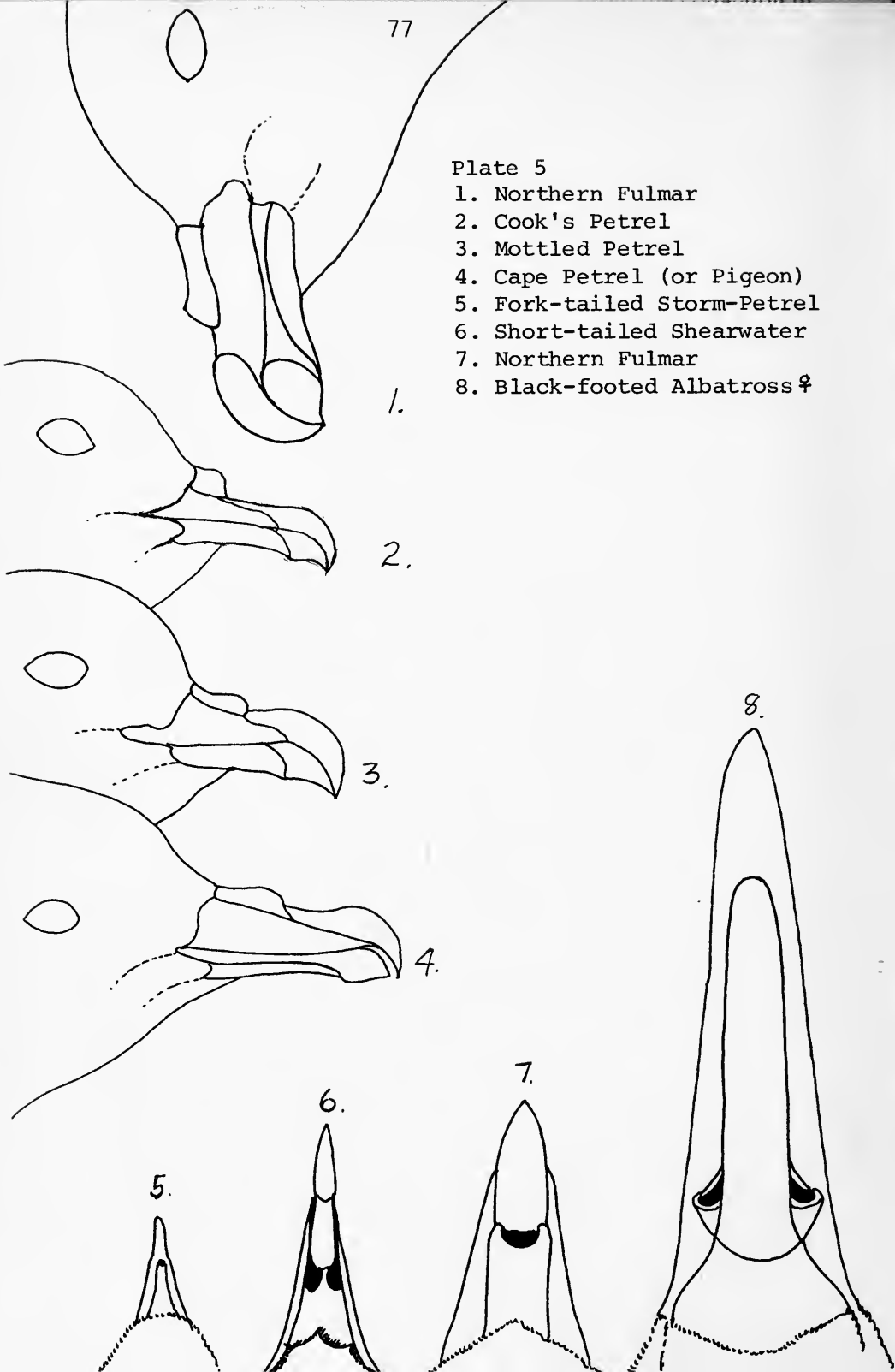

Plate 5

1. Northern Fulmar
2. Cook's Petrel
3. Mottled Petrel
4. Cape Petrel (or Pigeon)
5. Fork-tailed Storm-Petrel
6. Short-tailed Shearwater
7. Northern Fulmar
8. Black-footed Albatross ♀



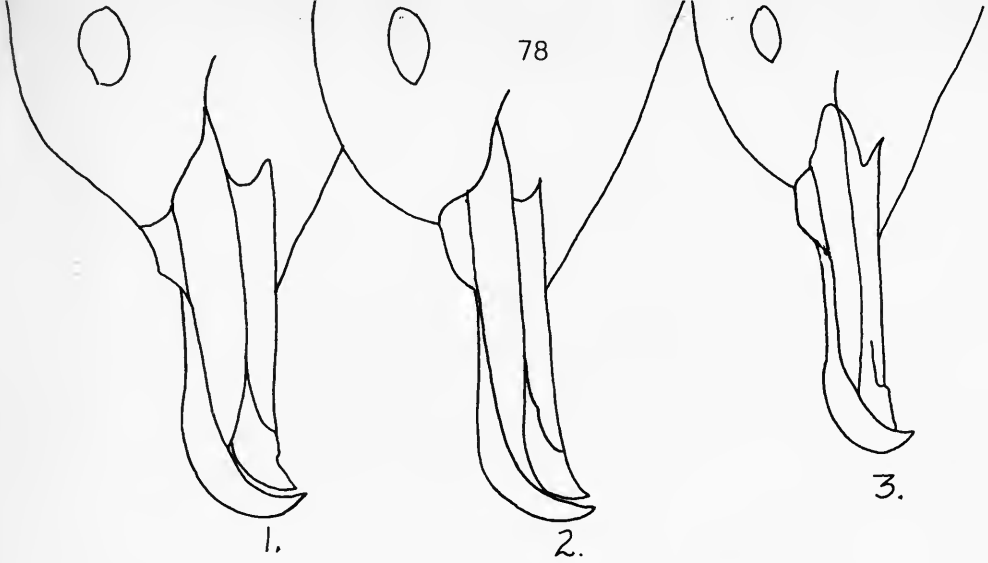

Plate 6

Light-bellied:

1. Pink-footed Shearwater
2. Buller's (New Zealand) Shearwater
3. Common (Manx) Shearwater

Dark-bellied:

4. Sooty Shearwater
5. Short-tailed Shearwater
6. Wedge-tailed Shearwater
7. Flesh-footed Shearwater

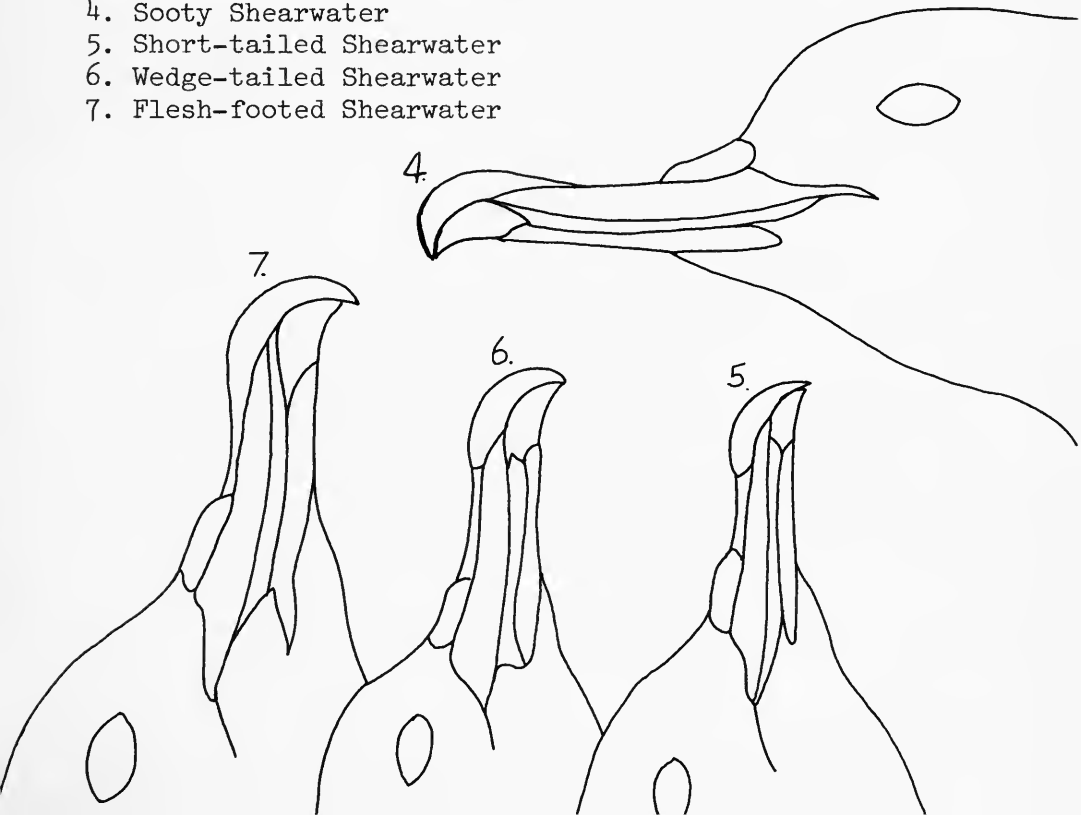

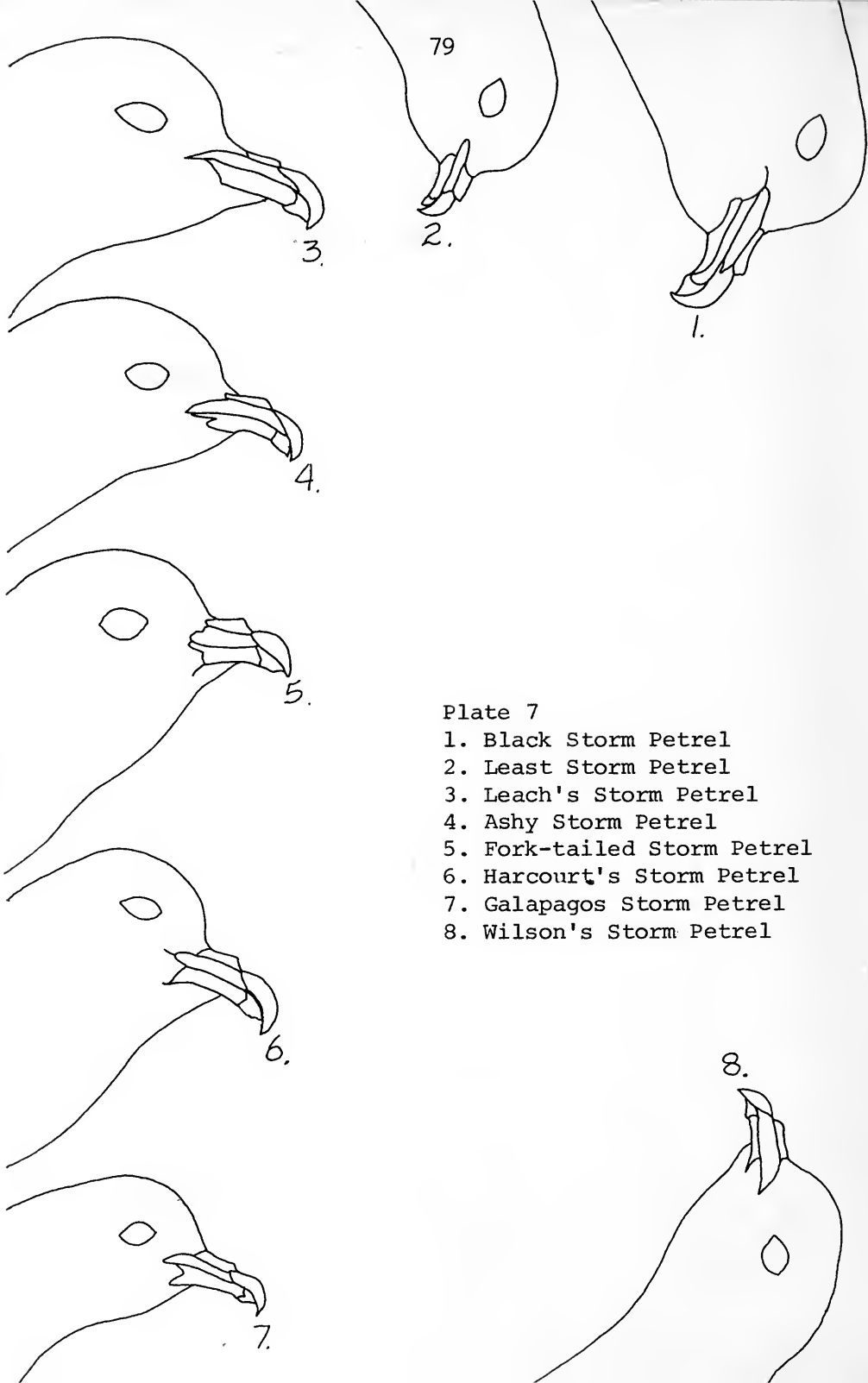

Plate 7

1. Black Storm Petrel
2. Least Storm Petrel
3. Leach's Storm Petrel
4. Ashy Storm Petrel
5. Fork-tailed Storm Petrel
6. Harcourt's Storm Petrel
7. Galapagos Storm Petrel
8. Wilson's Storm Petrel

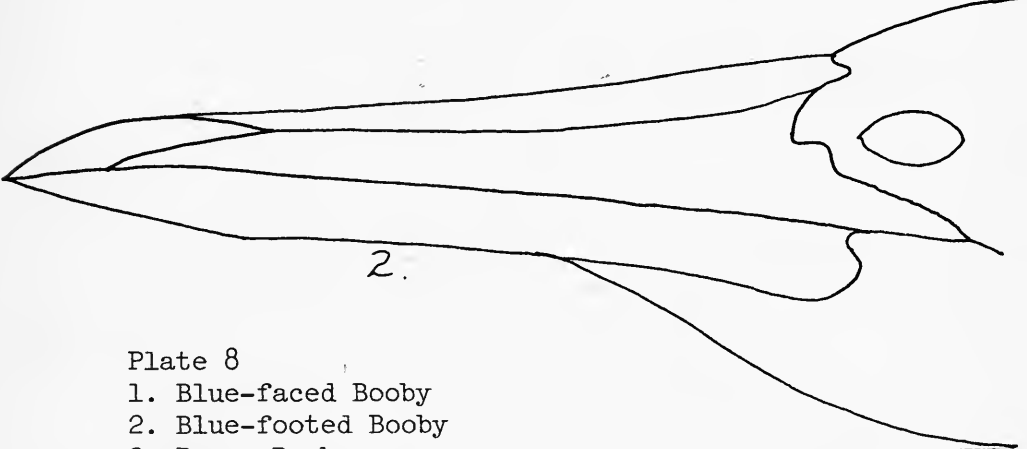
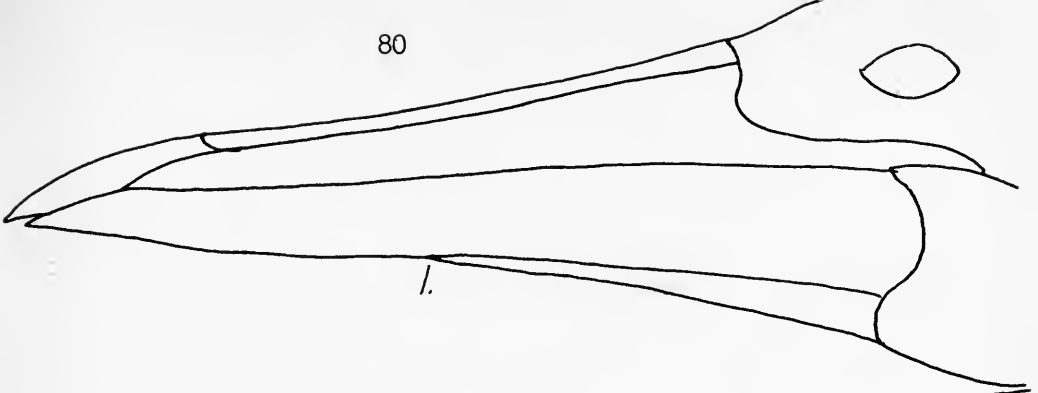
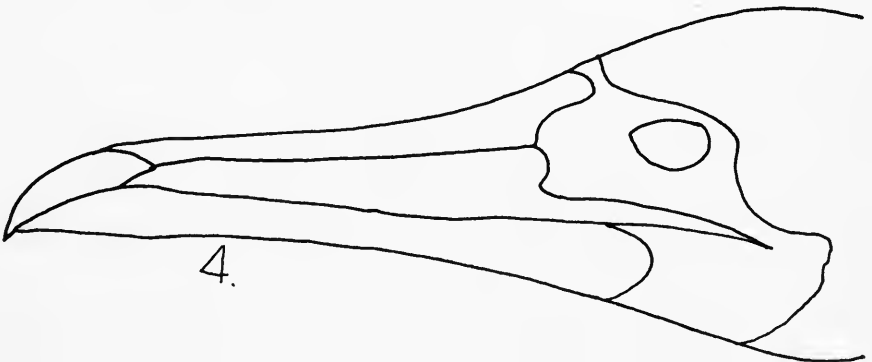
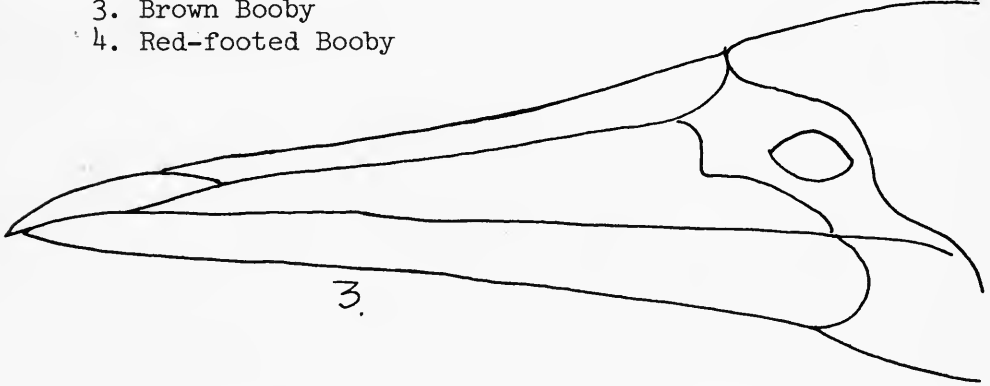

Plate 8

- 1. Blue-faced Booby
- 2. Blue-footed Booby
- 3. Brown Booby
- 4. Red-footed Booby



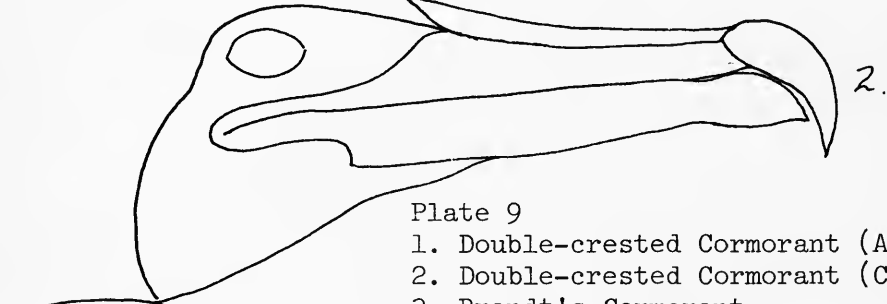
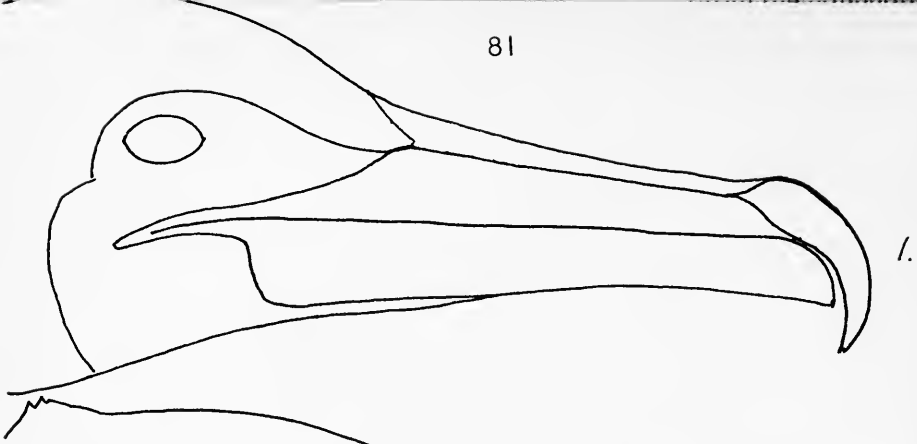
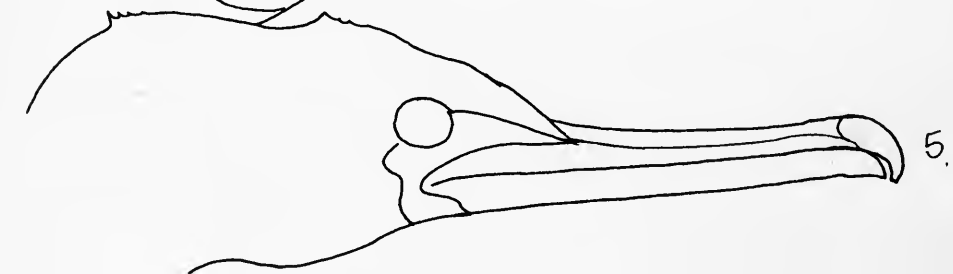
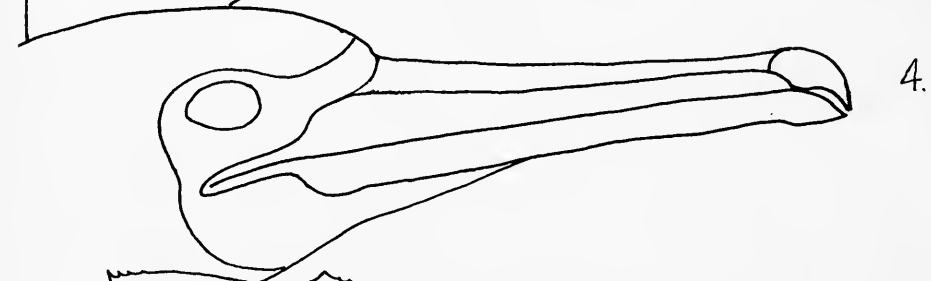
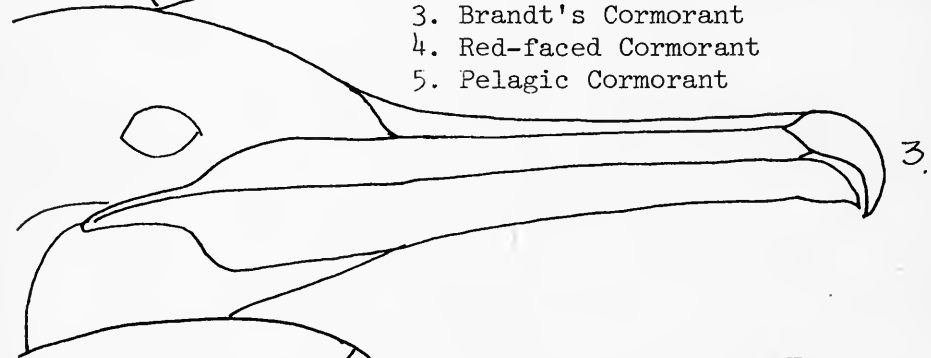

Plate 9

1. Double-crested Cormorant (Alaska)
2. Double-crested Cormorant (California)
3. Brandt's Cormorant
4. Red-faced Cormorant
5. Pelagic Cormorant



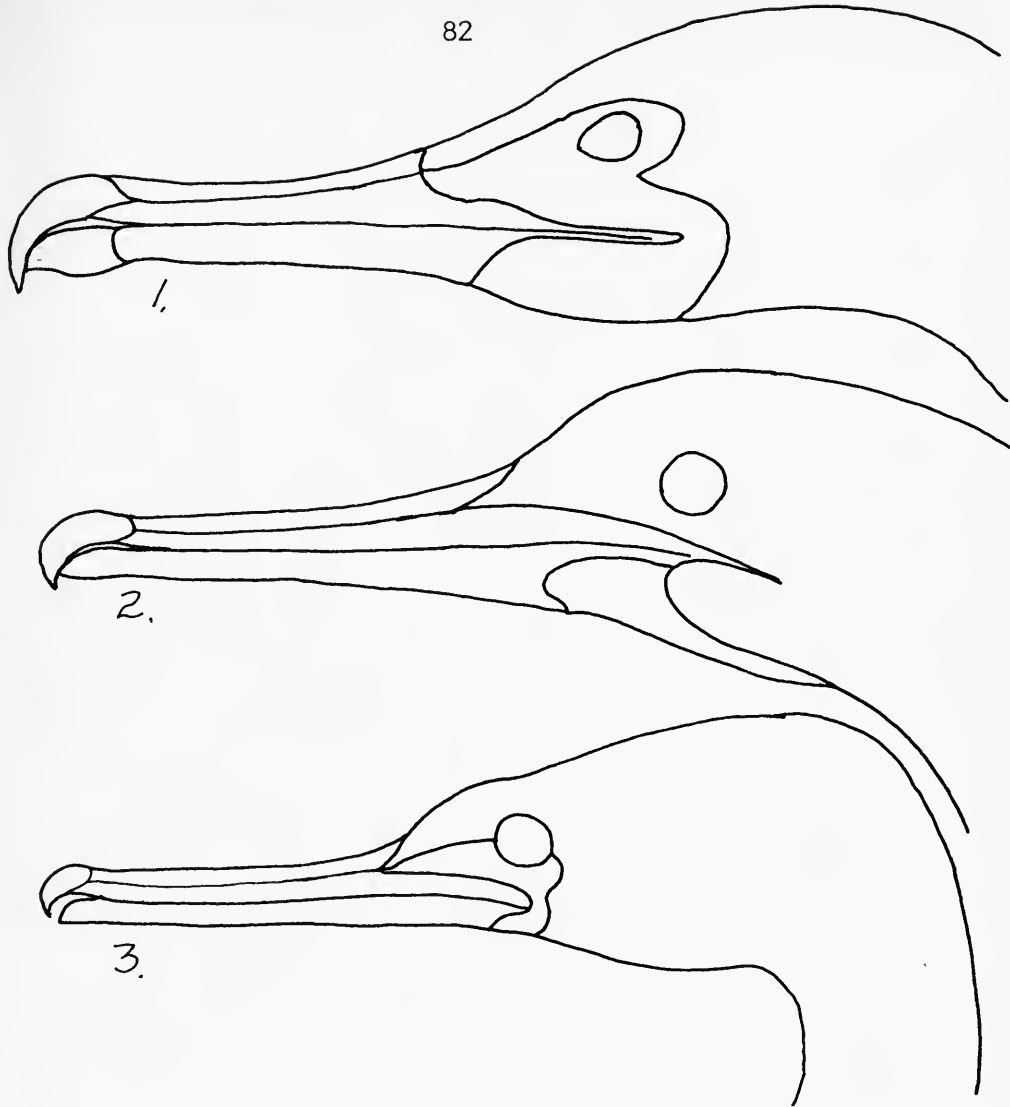
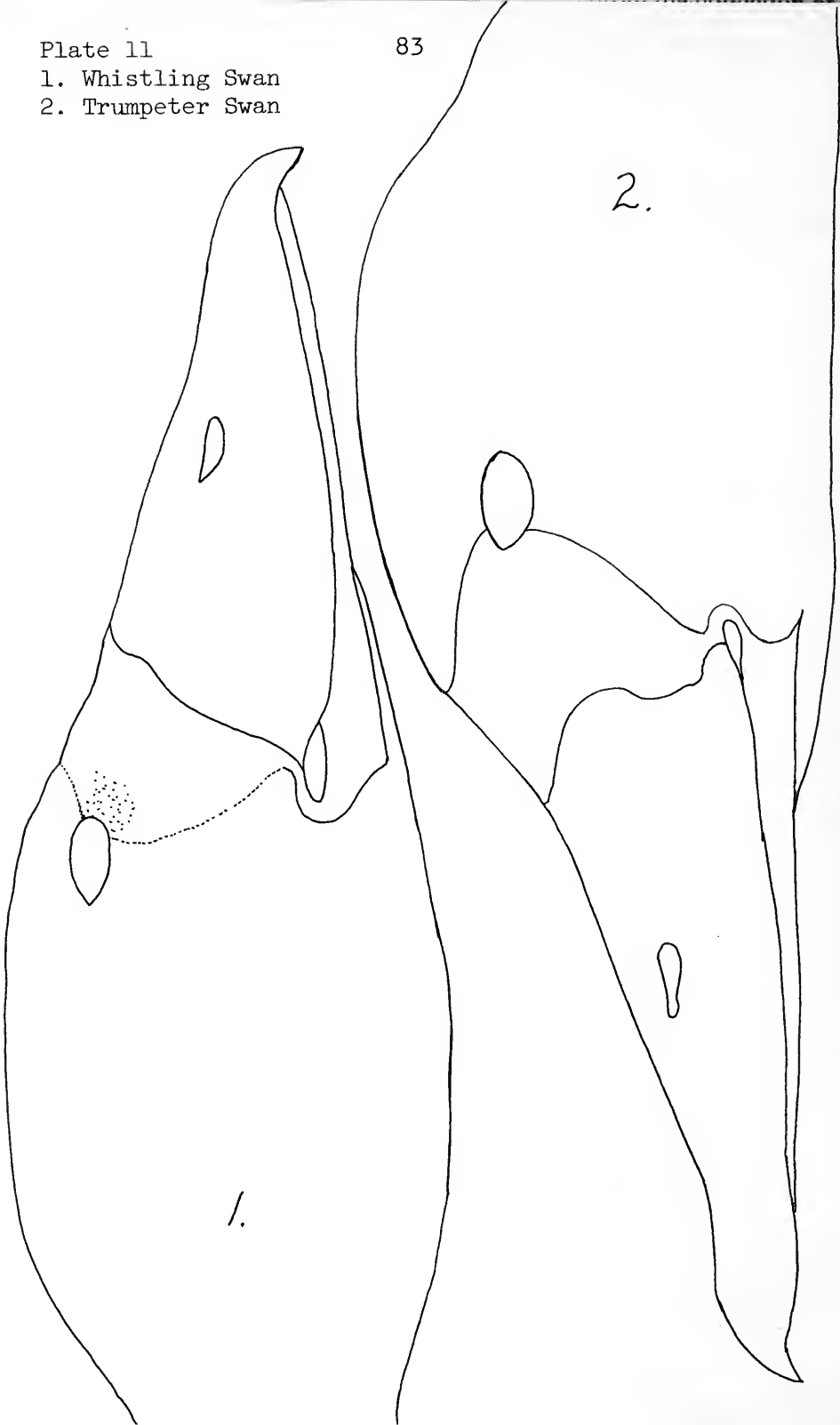

Plate 10

1. Double-crested Cormorant - first year
2. Brandt's Cormorant - first year
3. Pelagic Cormorant - first year

- 1. Whistling Swan
- 2. Trumpeter Swan



2.

1.

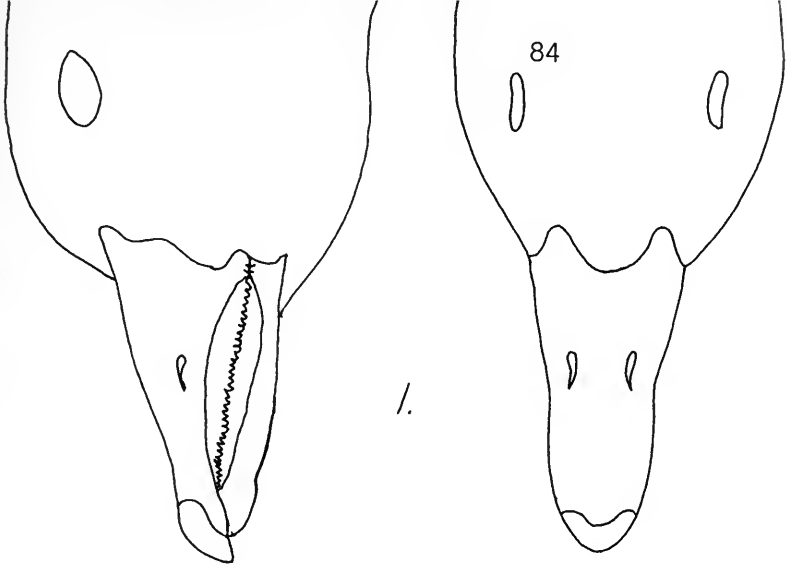
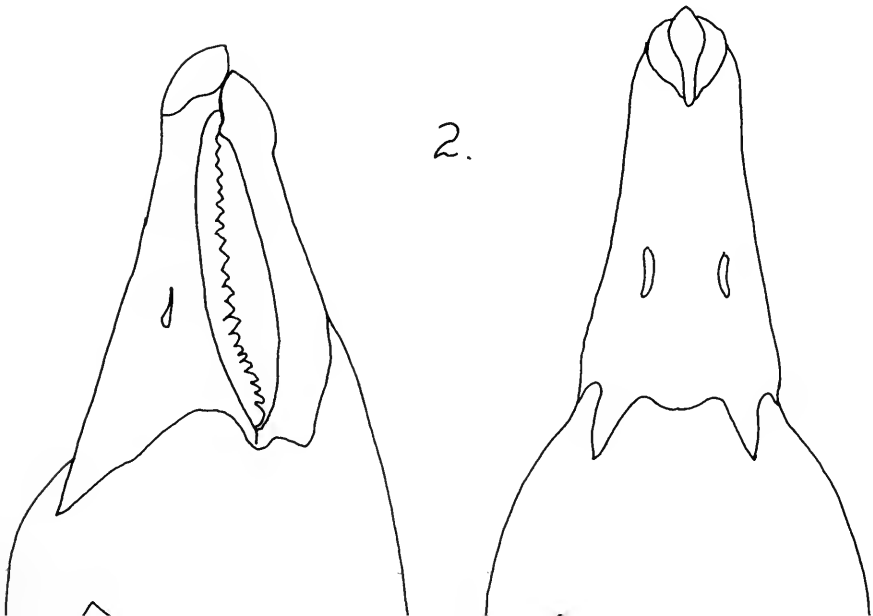

Plate 12a

1. Ross' Goose

2. Lesser Snow Goose



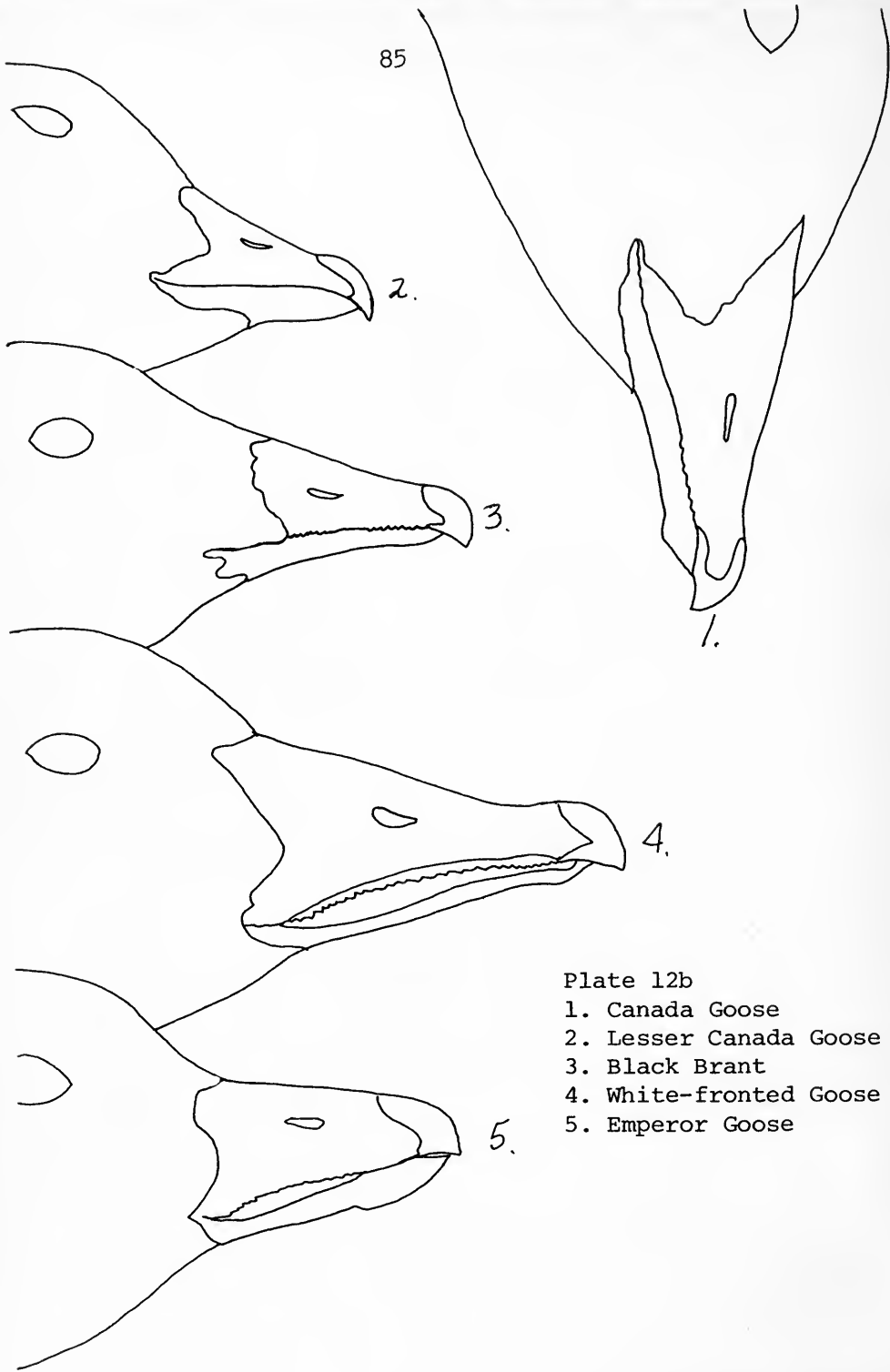

Plate 12b

- 1. Canada Goose
- 2. Lesser Canada Goose
- 3. Black Brant
- 4. White-fronted Goose
- 5. Emperor Goose

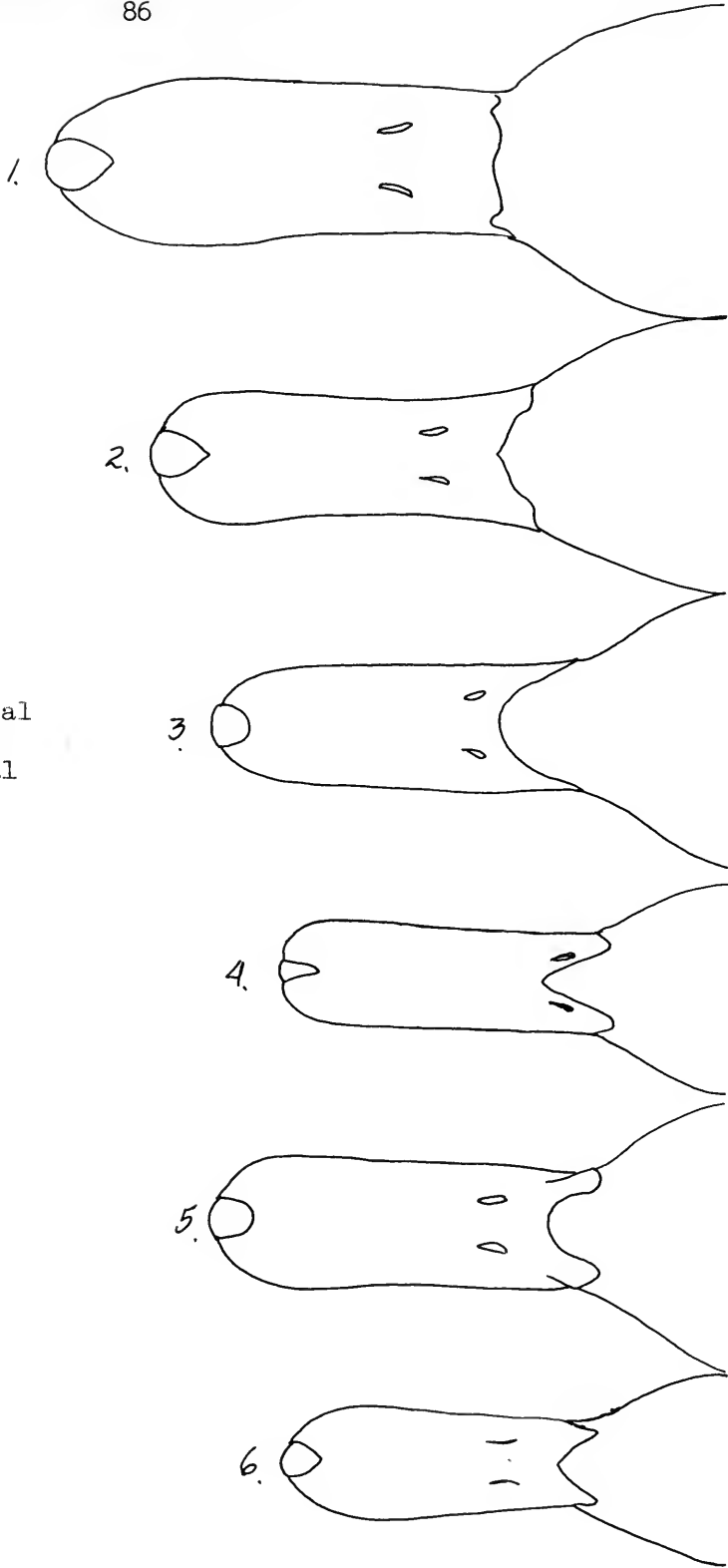

Plate 13a

1. Mallard

2. Pintail

3. Gadwall

4. Green-winged Teal

5. Cinnamon Teal

6. Blue-winged Teal

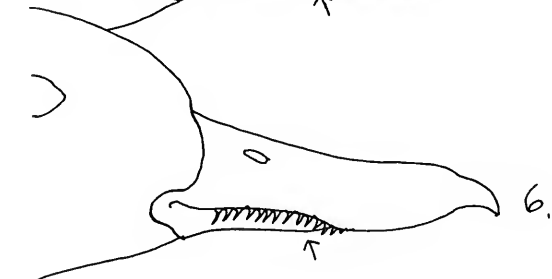
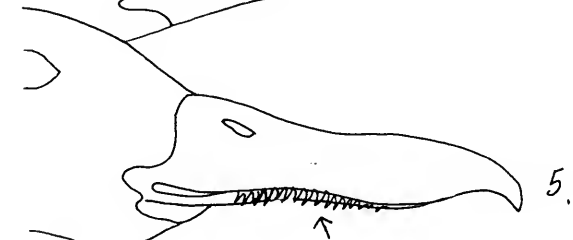
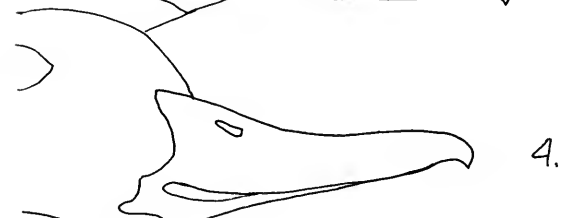
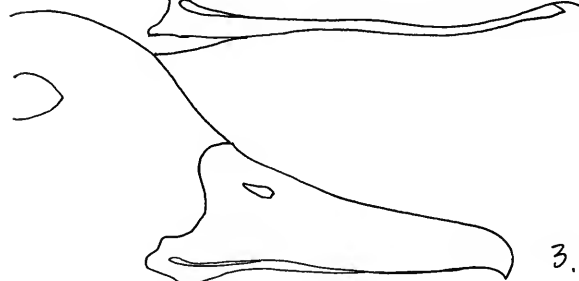
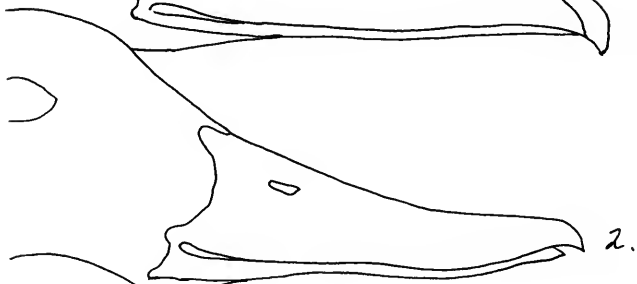
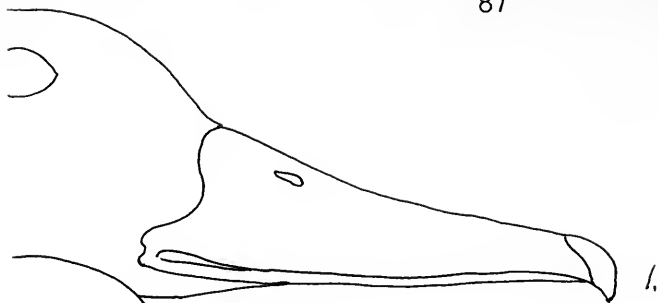
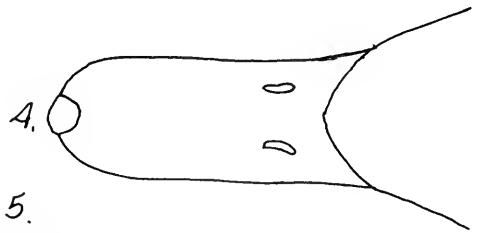
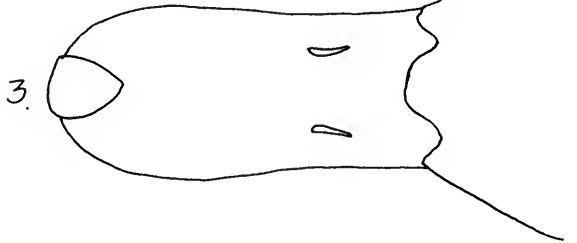
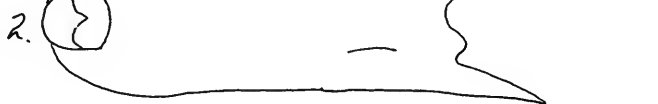
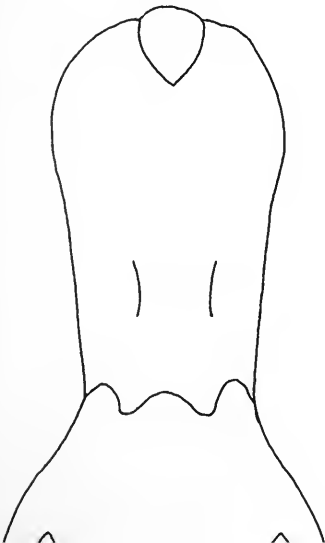

Plate 13b

1. Mallard
2. Pintail
3. Gadwall
4. Green-winged Teal
5. Cinnamon Teal
6. Blue-winged Teal



6.



5.

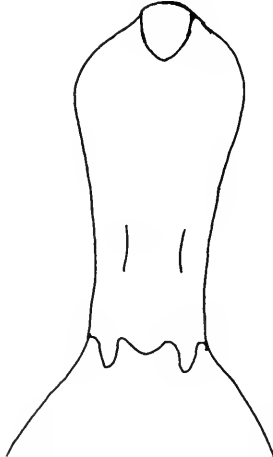
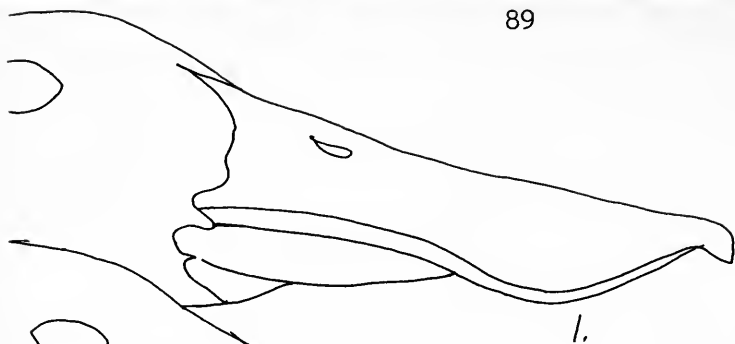
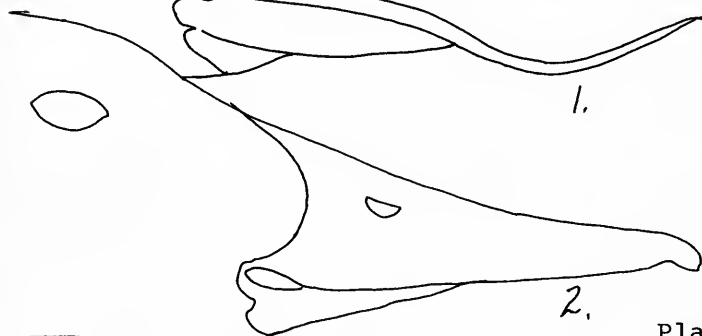

Plate 14a

1. Northern Shoveler
2. Canvasback
3. Redhead
4. American Wigeon
5. Lesser Scaup
6. Greater Scaup



1.



2.

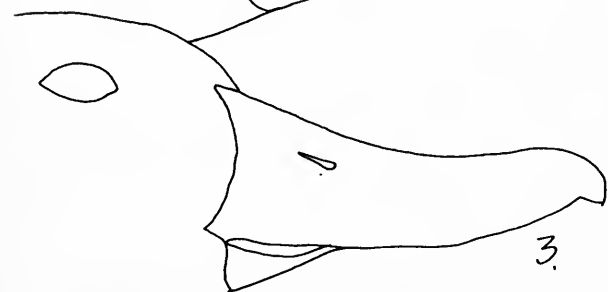

3.

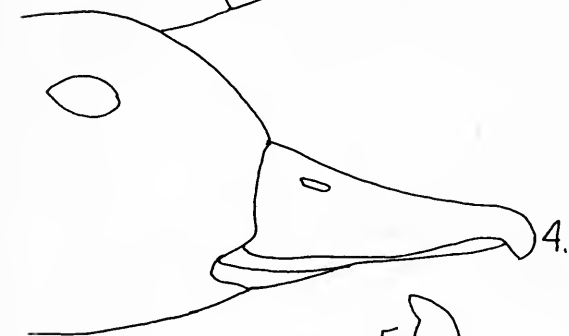

4.

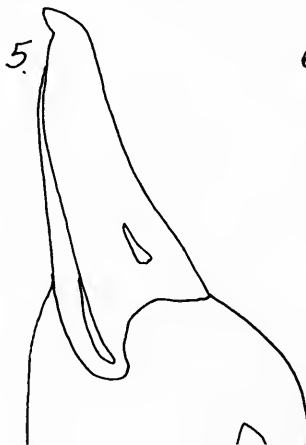

5.



6.

Plate 14b

1. Northern Shoveler
2. Canvasback
3. Redhead
4. American Wigeon
5. Lesser Scaup
6. Greater Scaup

1.

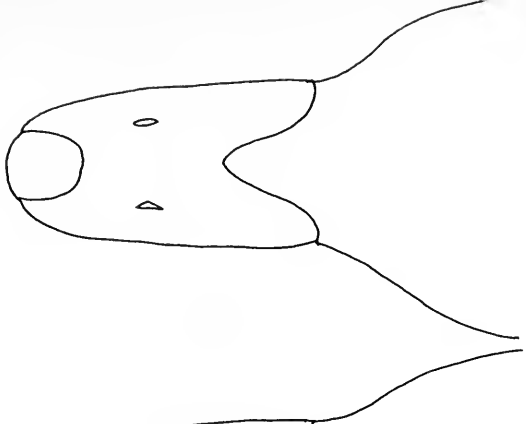

2.

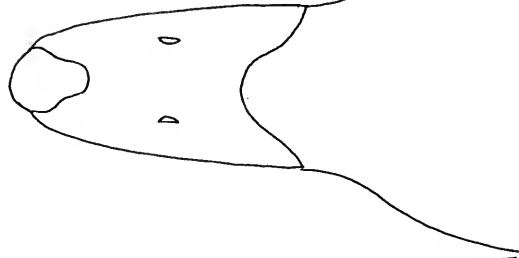

3.

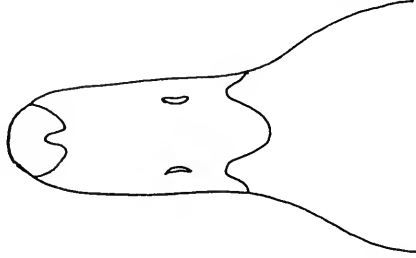

4.

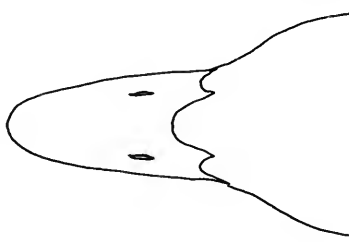

5.

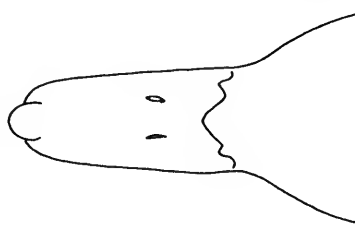

6.

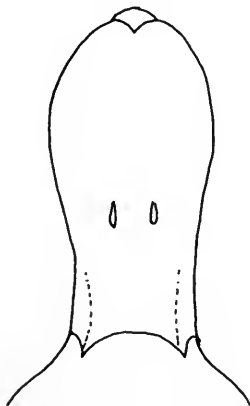
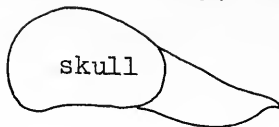
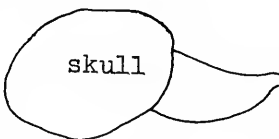
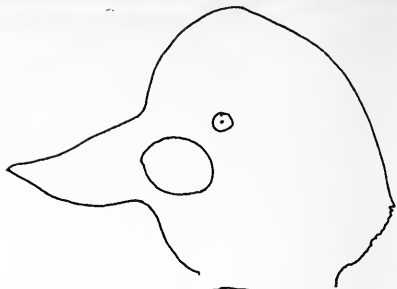

Plate 15a

1. Common Goldeneye
2. Barrow's Goldeneye
3. Oldsquaw
4. Harlequin Duck
5. Bufflehead
6. Ruddy Duck



1.



2.

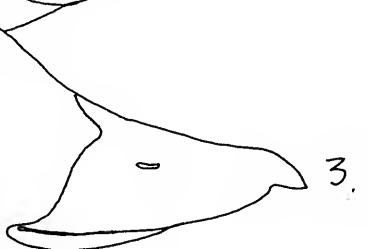
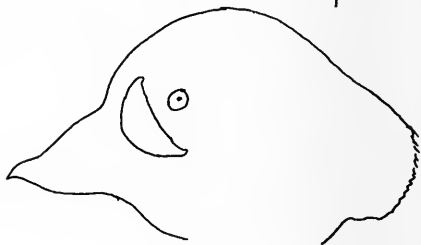

3.

Plate 15b

1. Common Goldeneye

2. Barrow's Goldeneye

3. Oldsquaw

4. Harlequin Duck

5. Bufflehead

6. Ruddy Duck

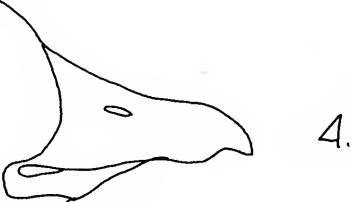

4.



5.



6.

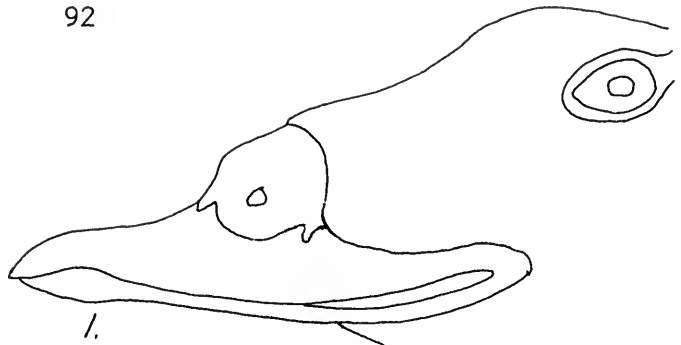

1.

Plate 16

1. White-winged Scoter ♂
2. Surf Scoter ♂
3. Surf Scoter ♀
4. Black Scoter ♂

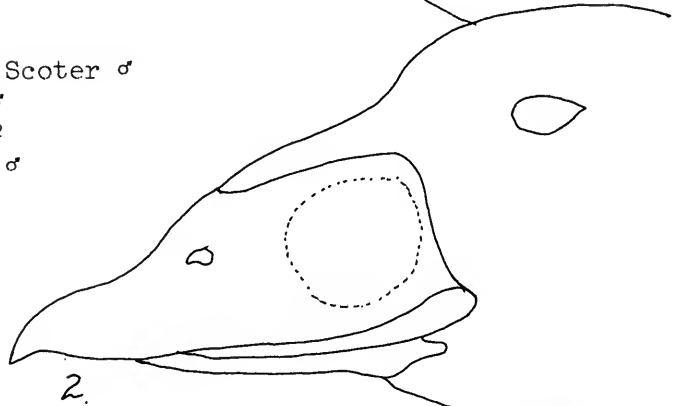

2.

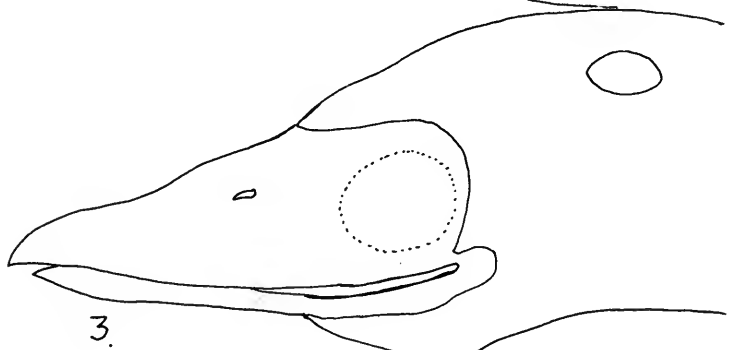

3.



4.

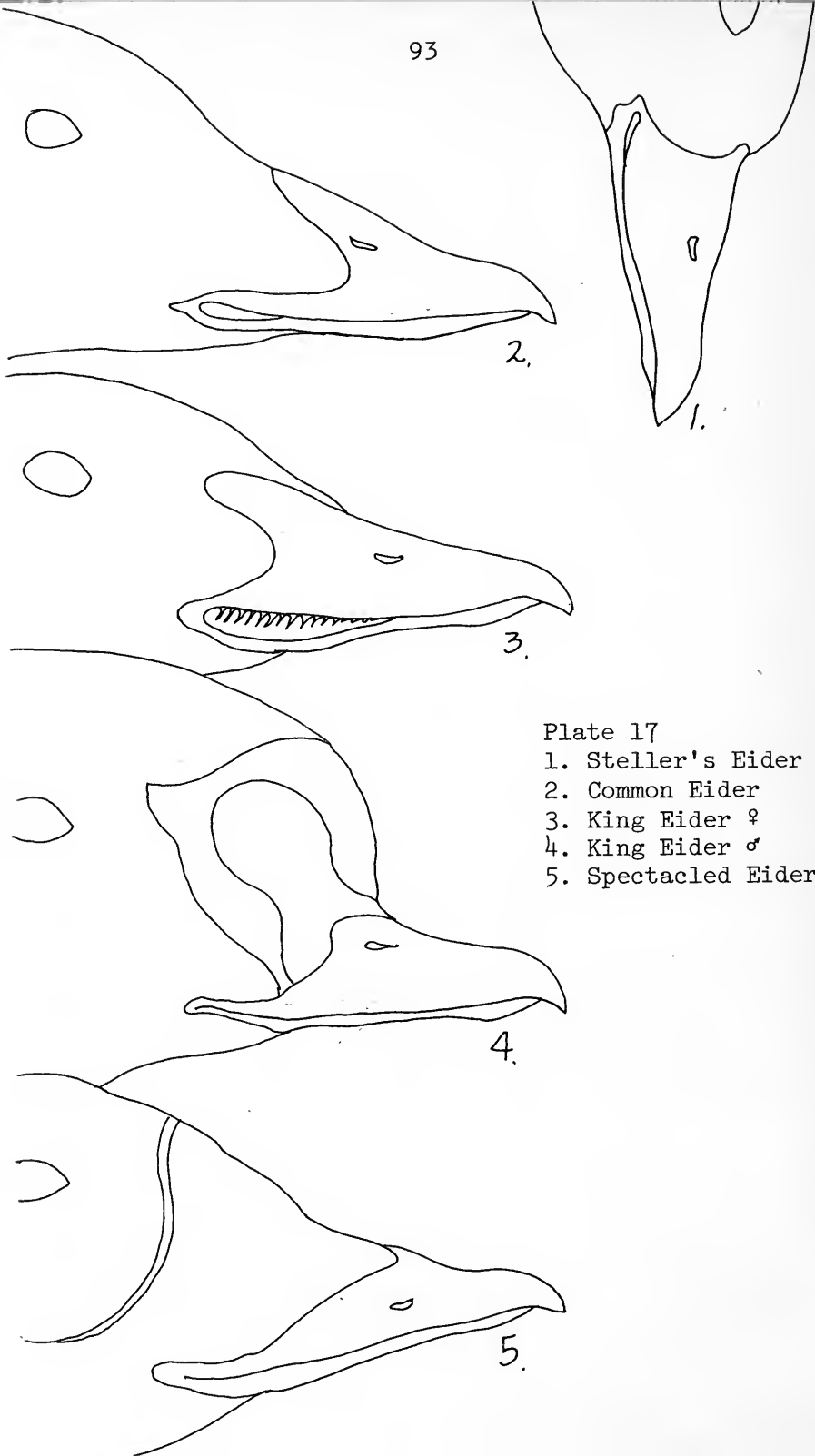

Plate 17

1. Steller's Eider
2. Common Eider
3. King Eider ♀
4. King Eider ♂
5. Spectacled Eider

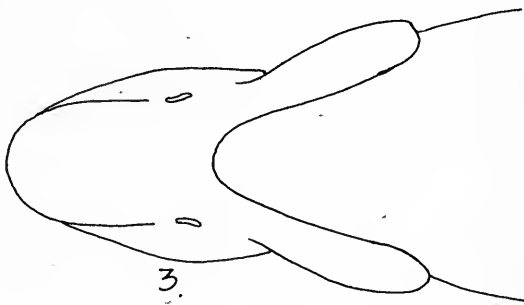
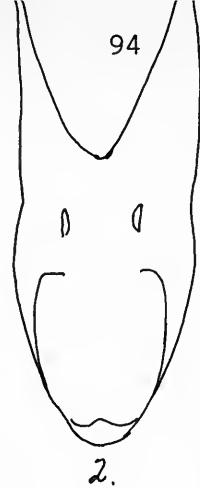
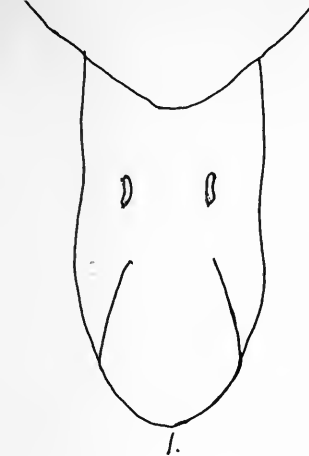
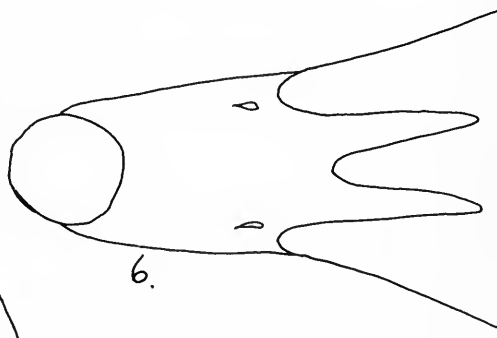
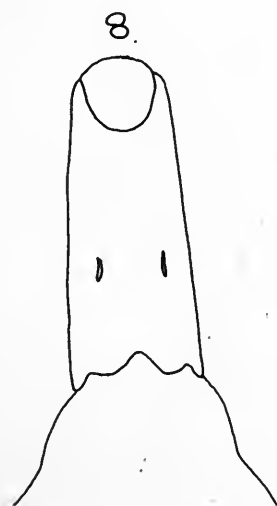
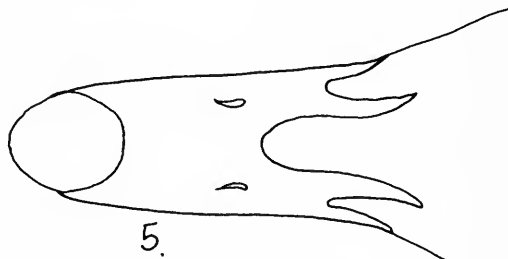
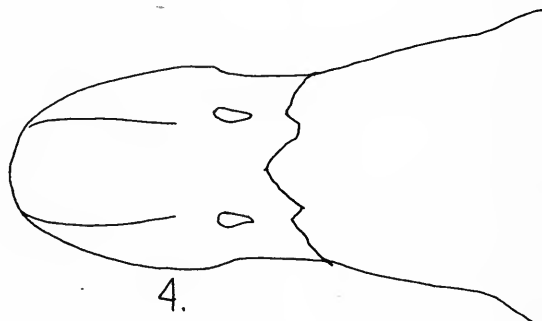

Plate 18

- 1. Black Scoter
- 2. Surf Scoter ♀
- 3. Surf Scoter ♂
- 4. White-winged Scoter
- 5. King Eider ♀
- 6. Common Eider
- 7. Spectacled Eider
- 8. Steller's Eider



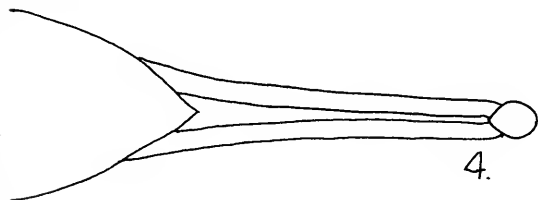
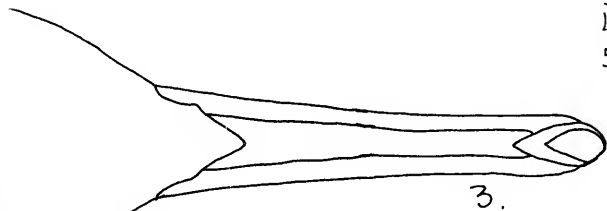
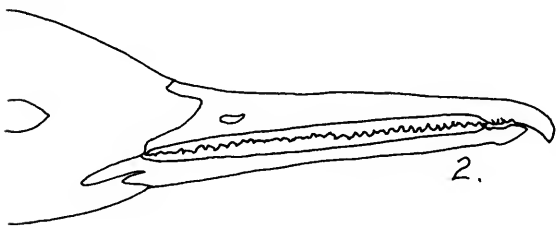
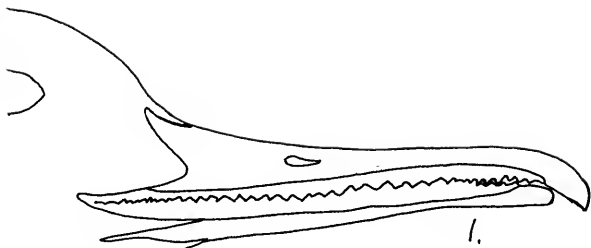
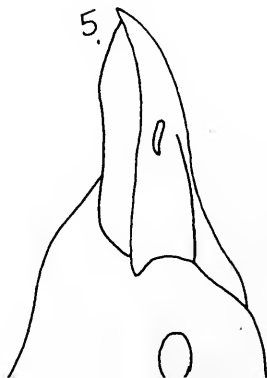
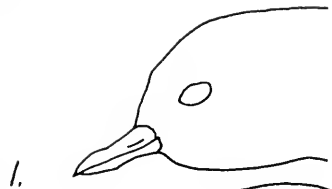

Plate 19.

1. Common Merganser
2. Red-breasted Merganser
3. Common Merganser
4. Red-breasted Merganser
5. American Coot





1.

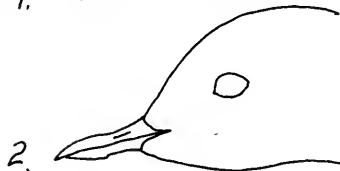

2.

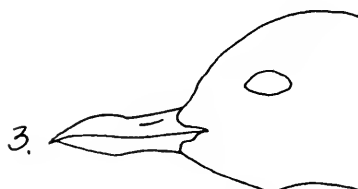

3.



4.



5.



6.

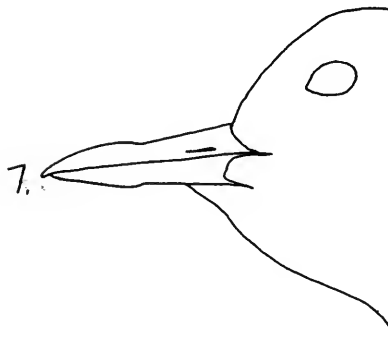

7.

Plate 20

1. Semipalmated Plover
2. Snowy Plover
3. Wilson's Plover
4. Mountain Plover
5. Killdeer
6. American Golden Plover
7. Black-bellied Plover

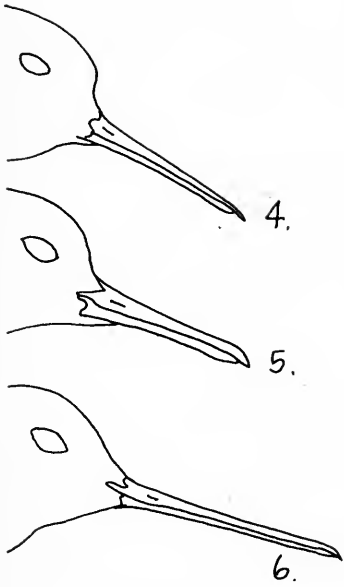
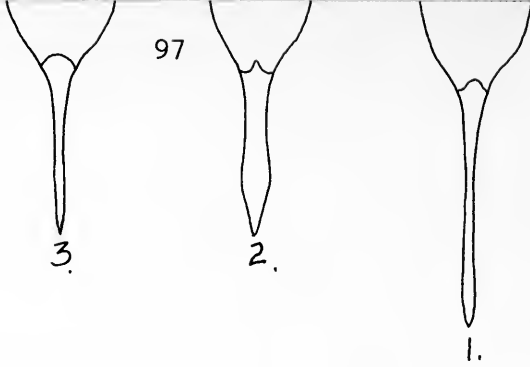
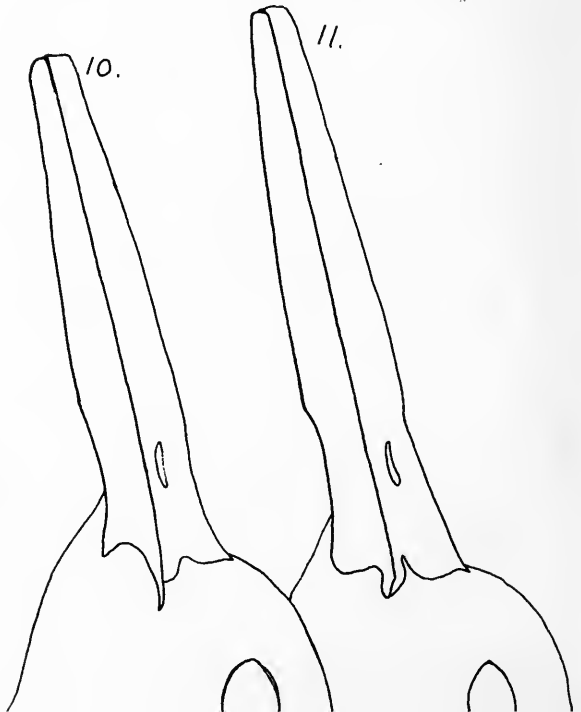
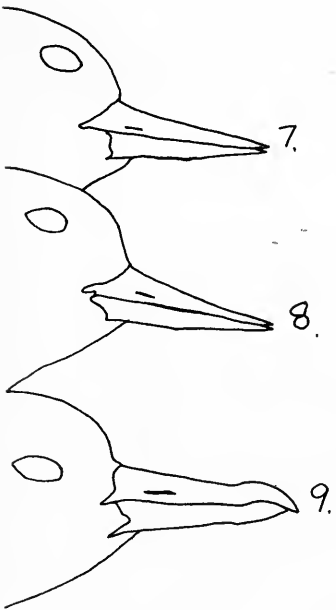

Plate 21

1. Wilson's Phalarope
2. Red Phalarope
3. Northern Phalarope
4. Northern Phalarope
5. Red Phalarope
6. Wilson's Phalarope
7. Ruddy Turnstone
8. Black Turnstone
9. Surfbird
10. American Oystercatcher
11. Black Oystercatcher



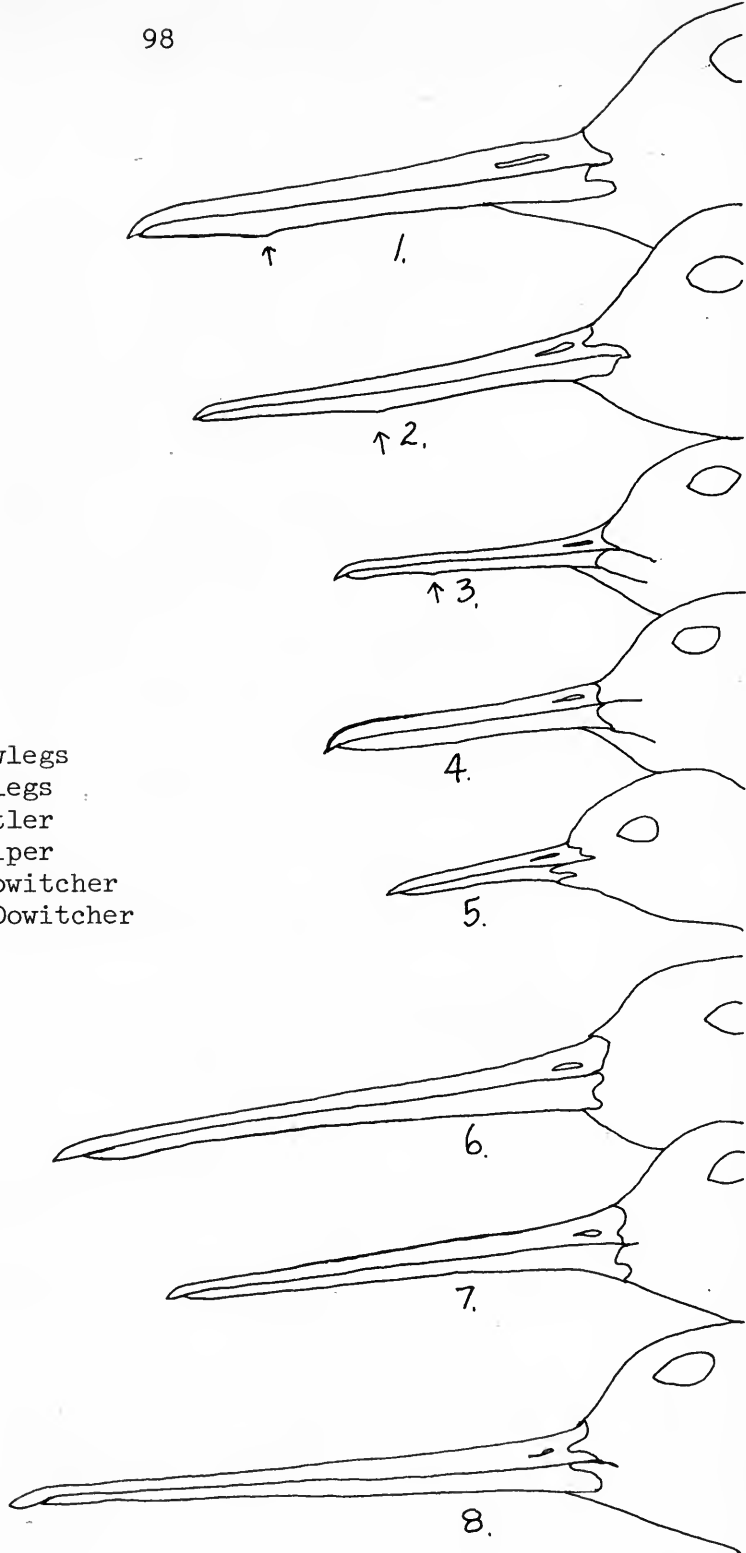

Plate 22

1. Willet
2. Greater Yellowlegs
3. Lesser Yellowlegs
4. Wandering Tattler
5. Spotted Sandpiper
6. Long-billed Dowitcher
7. Short-billed Dowitcher
8. Common Snipe

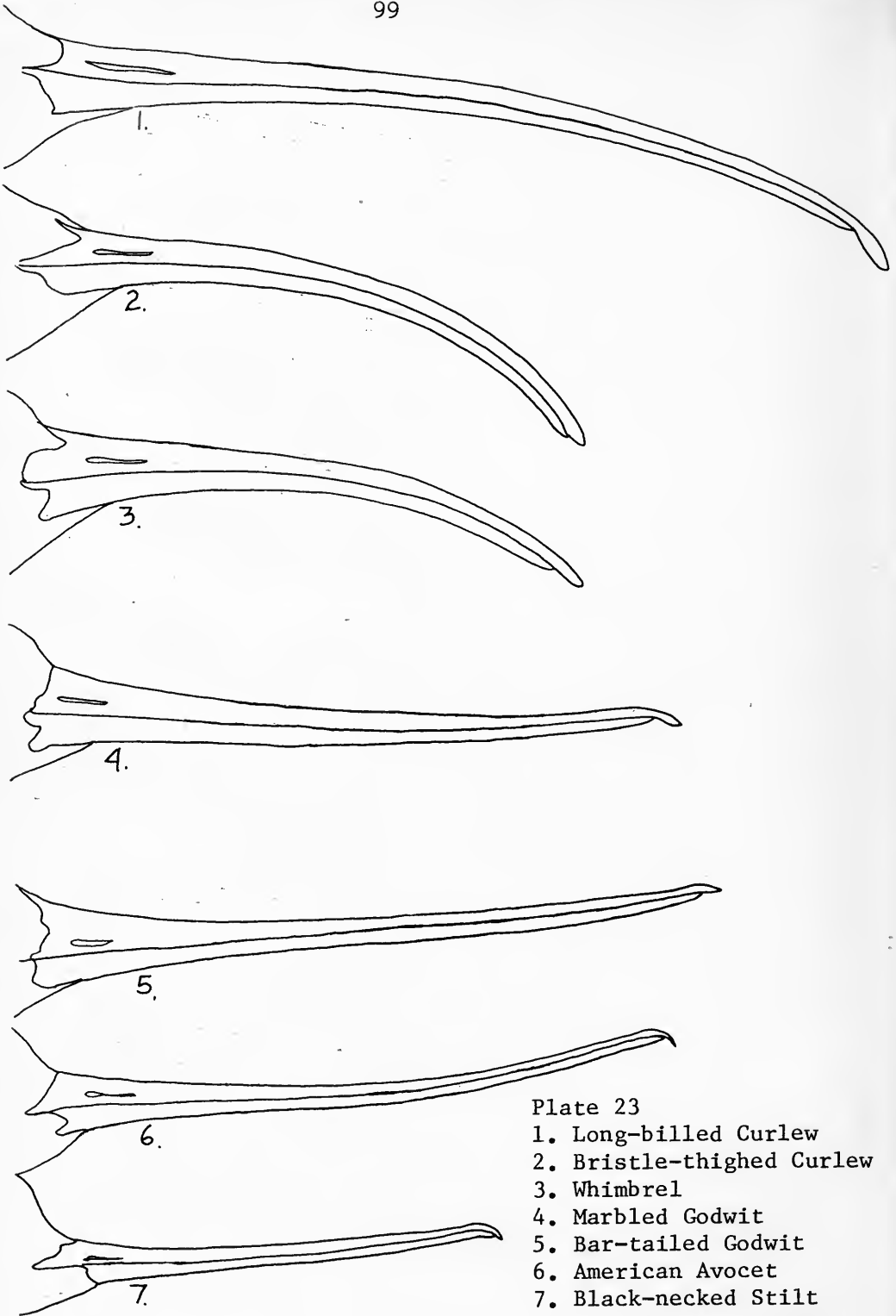

Plate 23

1. Long-billed Curlew
2. Bristle-thighed Curlew
3. Whimbrel
4. Marbled Godwit
5. Bar-tailed Godwit
6. American Avocet
7. Black-necked Stilt

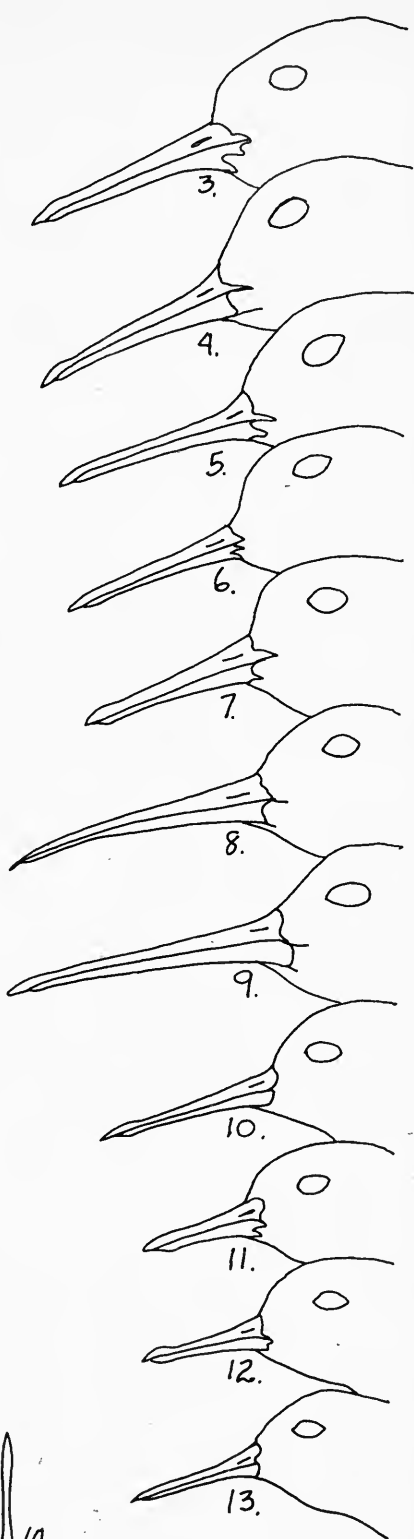
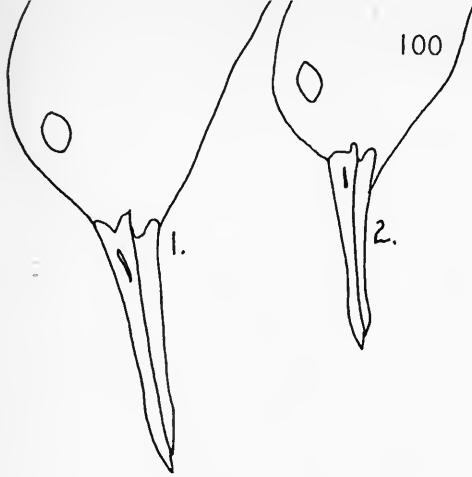
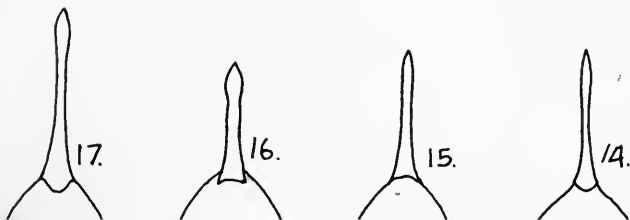

Plate 24.

1. Red Knot
2. Sanderling
3. Rock Sandpiper
4. Sharp-tailed Sandpiper
5. Pectoral Sandpiper
6. Baird's Sandpiper
7. White-rumped Sandpiper
8. Curlew Sandpiper
9. Dunlin
10. Western Sandpiper
11. Semipalmated Sandpiper
12. Rufous-necked Sandpiper
13. Least Sandpiper
14. Least Sandpiper
15. Rufous-necked Sandpiper
16. Semipalmated Sandpiper
17. Western Sandpiper



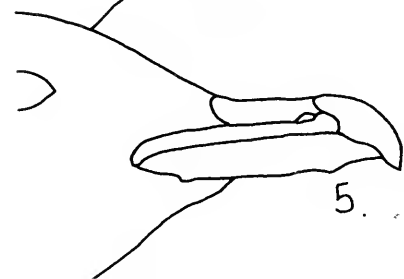
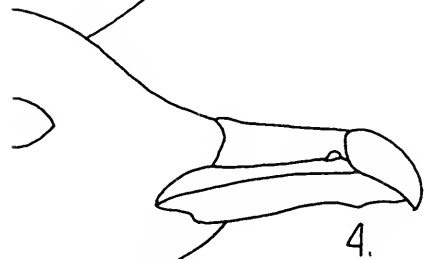
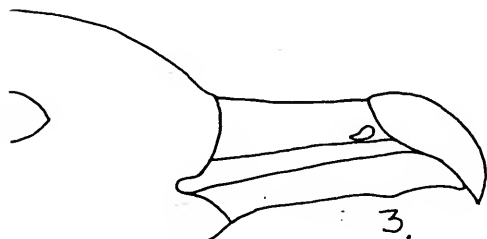
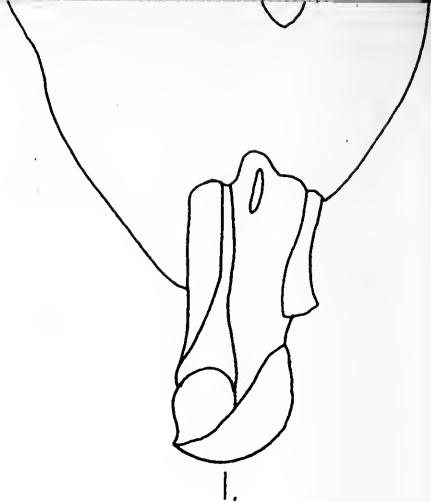
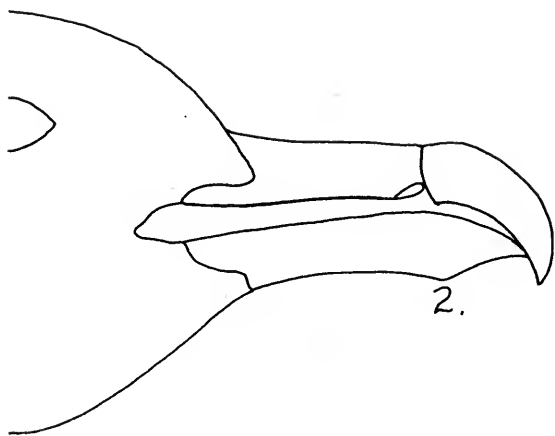
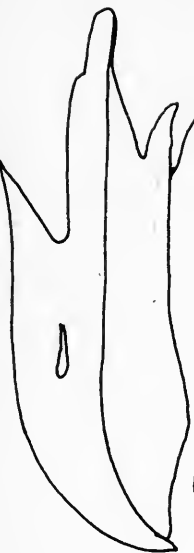

Plate 25

1. Fulmar (for comparison)
2. South Polar Skua
3. Pomarine Jaeger
4. Parasitic Jaeger
5. Long-tailed Jaeger



1.



2.



3.



4.



5.



6.

Plate 26a

1. Western Gull ♂
2. Western Gull ♀
3. Glaucous-winged Gull ♂
4. Glaucous-winged Gull ♀
5. Glaucous Gull ♂
6. Glaucous Gull ♀



3.

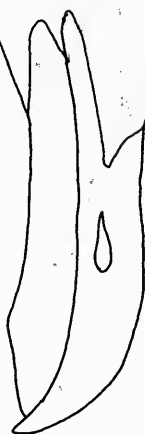

2.



1.

Plate 26b

- 1. Herring Gull ♂
- 2. Thayer's Gull ♂
- 3. Herring Gull ♀
- 4. California Gull ♂
- 5. California Gull ♀
- 6. Heermann's Gull ♀
- 7. Heermann's Gull ♂



4.



5.



6.



7.

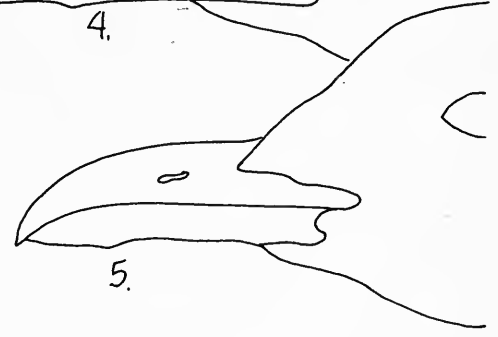
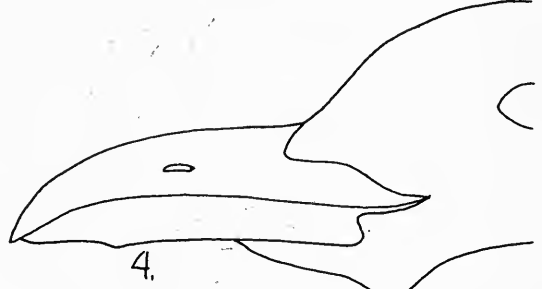
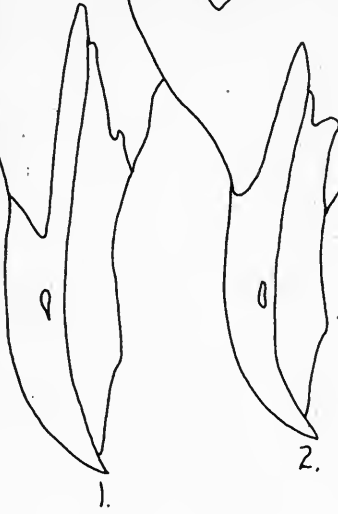
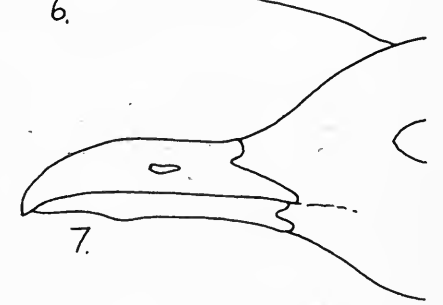
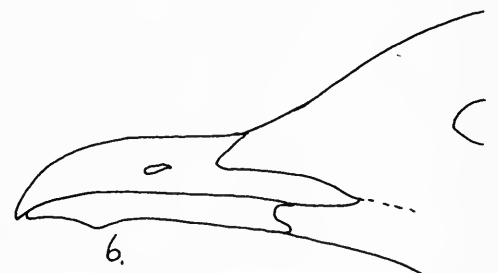
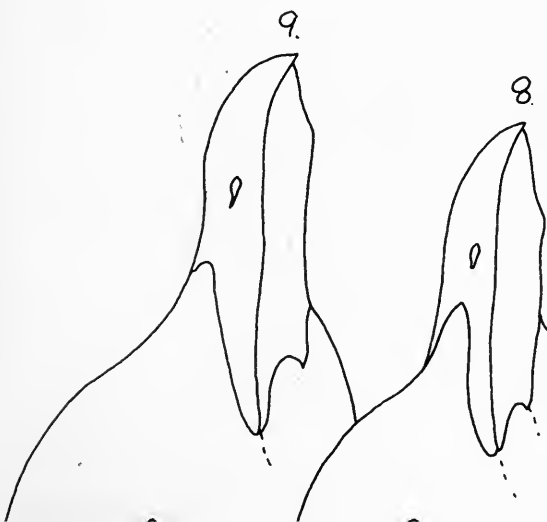

Plate 27

1. Ring-billed Gull ♂
2. Ring-billed Gull ♀
3. Red-legged Kittiwake
4. Black-legged Kittiwake ♂
5. Black-legged Kittiwake ♀
6. Mew Gull ♂
7. Mew Gull ♀
8. Ivory Gull ♀
9. Ivory Gull ♂



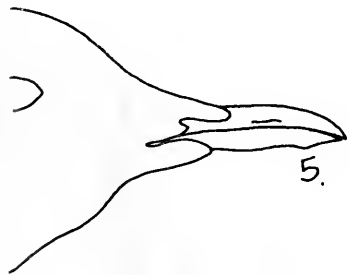
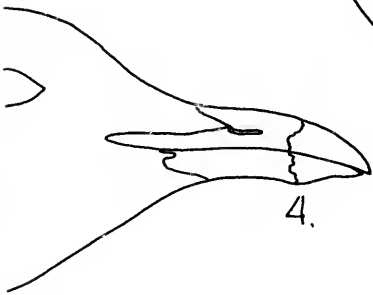
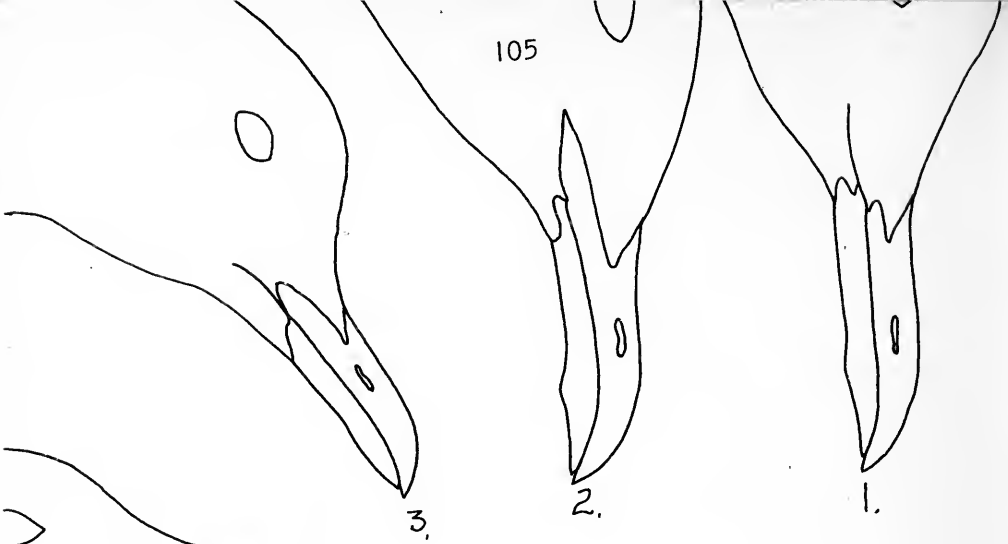
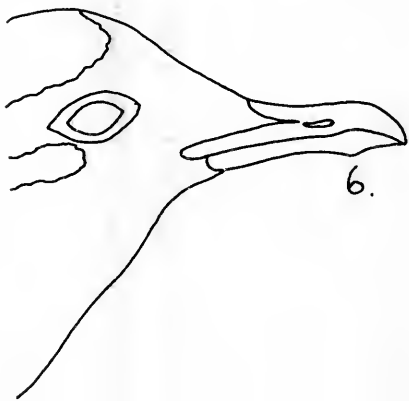

Plate 28

1. Black-headed Gull
2. Laughing Gull
3. Franklin's Gull
4. Sabine's Gull
5. Ross' Gull
6. Little Gull
7. Bonaparte's Gull



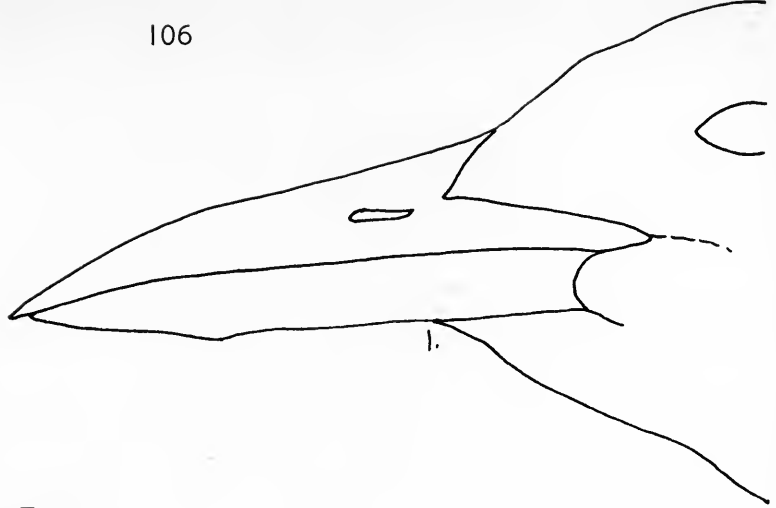
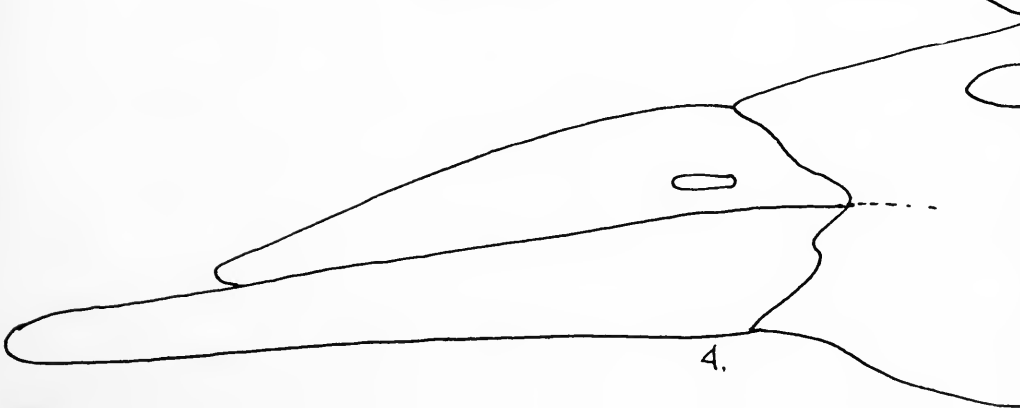
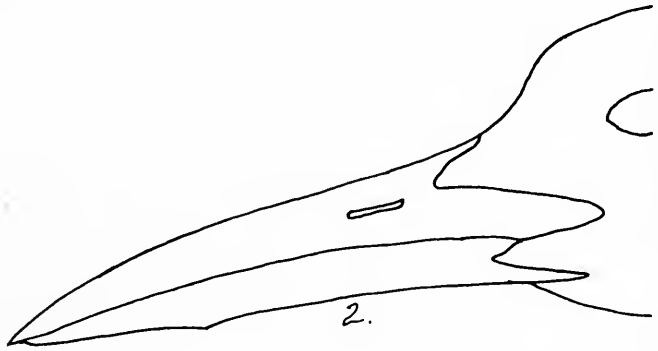
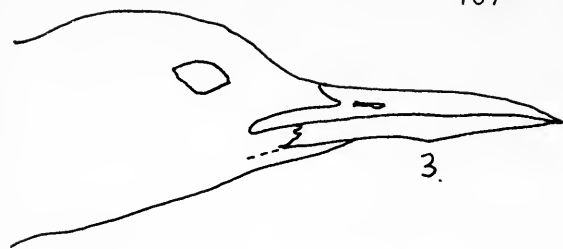

Plate 29

1. Caspian Tern
2. Royal Tern
3. Elegant Tern
4. Black Skimmer





3.

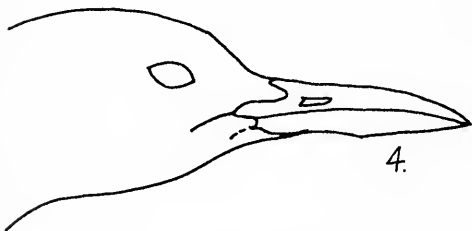

4.

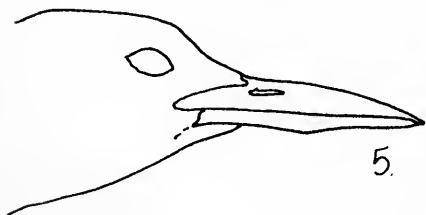

5.

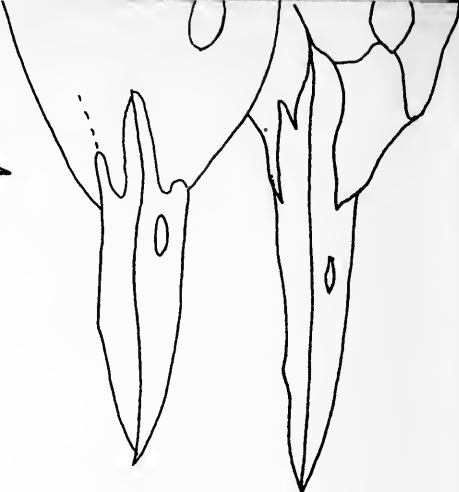

2.

1.

Plate 30

1. Sooty Tern
2. Gull-billed Tern
3. Aleutian Tern
4. Black Tern
5. Least Tern
6. Arctic Tern
7. Common Tern
8. Forster's Tern

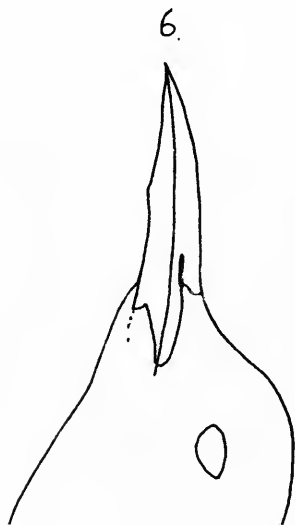

6.

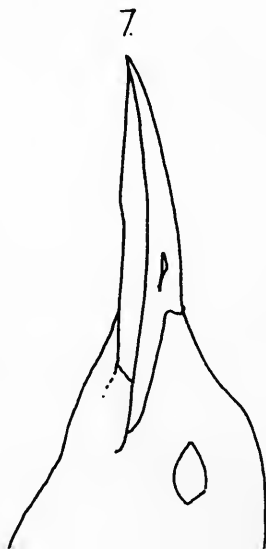

7.

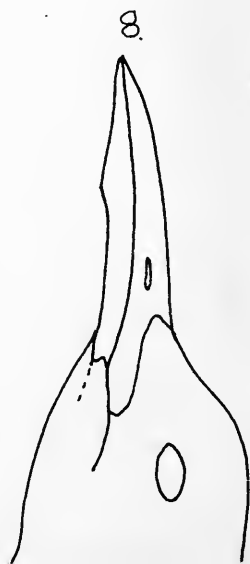

8.

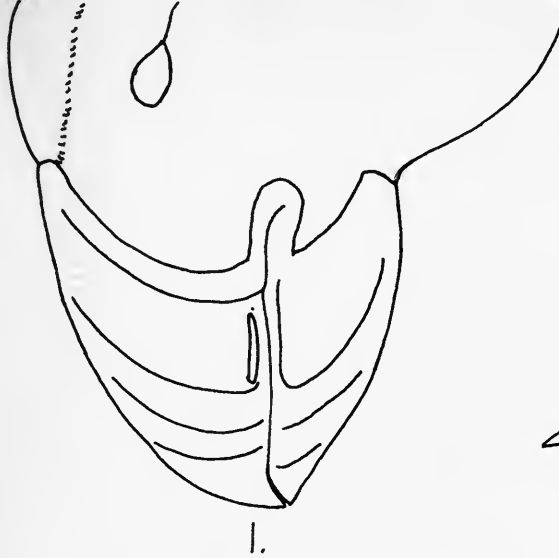

1.



2.

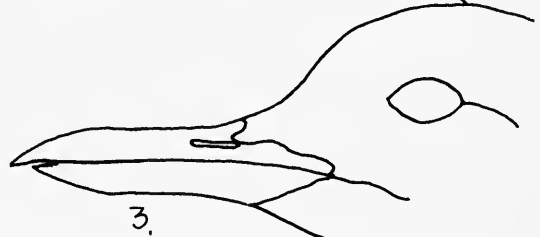

3.

Plate 31

1. Horned Puffin, breeding adult
2. Black Guillemot
3. Pigeon Guillemot
4. Common Murre, hatching year
5. Common Murre (U. aalge californicus) adult
6. Common Murre (U. aalge inornata) adult
7. Thick-billed Murre (U. lomvia) adult
8. Thick-billed Murre (U. lomvia) young



4.

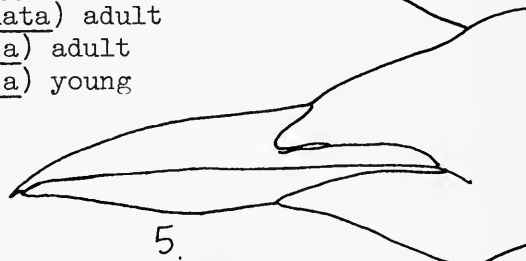

5.

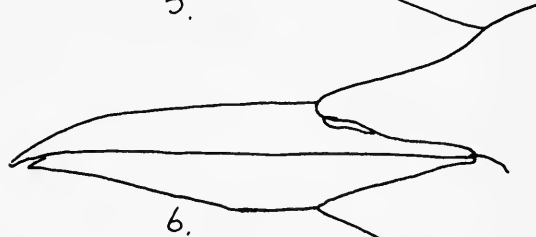

6.



7.

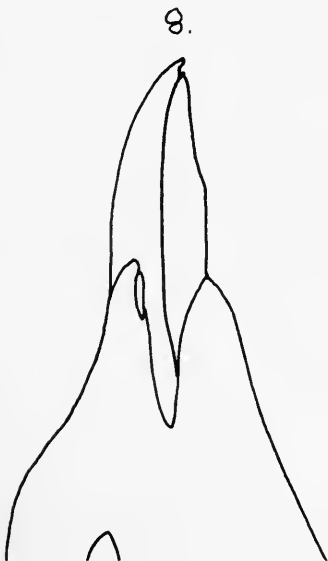

8.

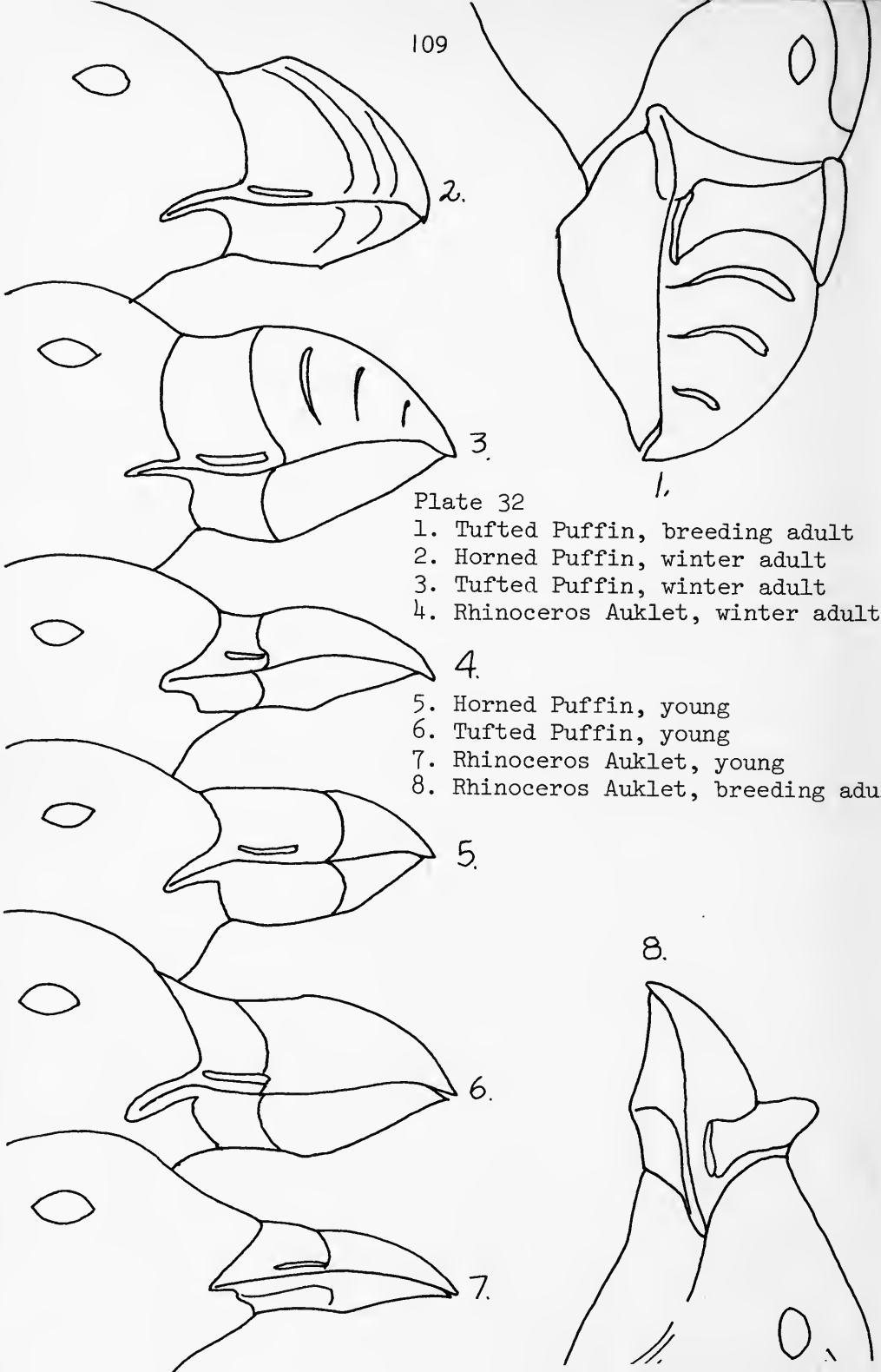

Plate 32

1. Tufted Puffin, breeding adult
2. Horned Puffin, winter adult
3. Tufted Puffin, winter adult
4. Rhinoceros Auklet, winter adult
5. Horned Puffin, young
6. Tufted Puffin, young
7. Rhinoceros Auklet, young
8. Rhinoceros Auklet, breeding adult

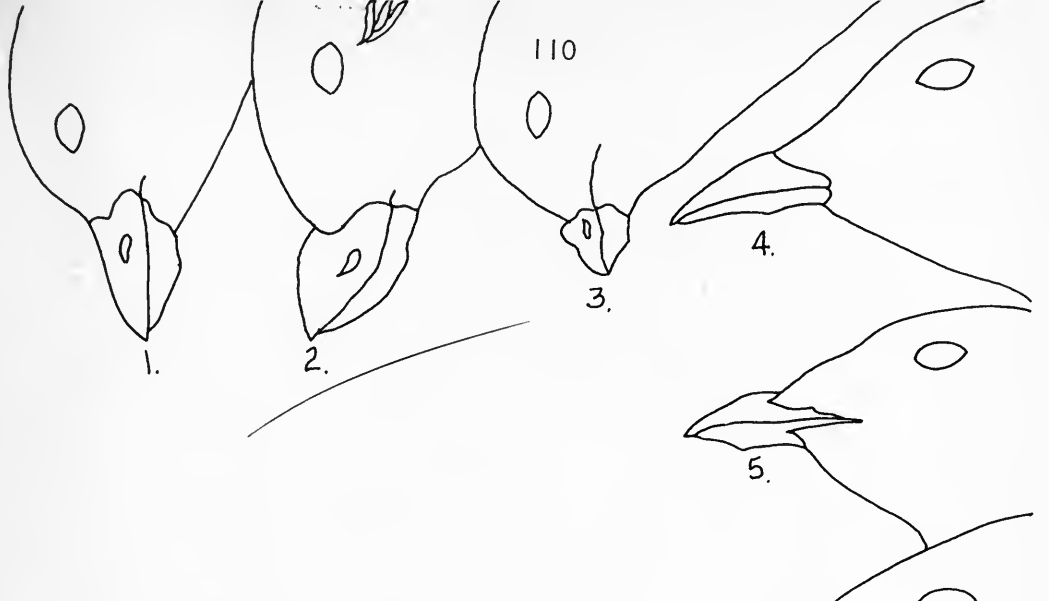
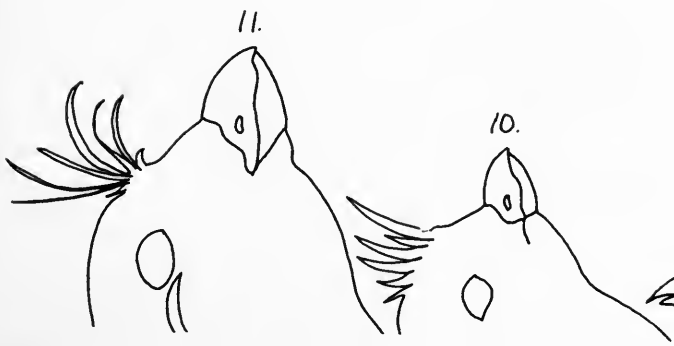
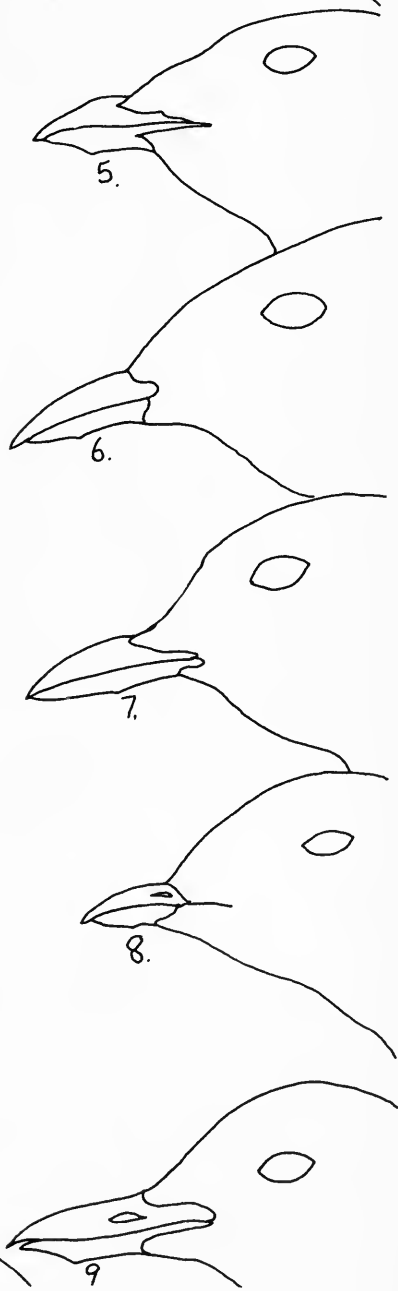

Plate 33

1. Cassin's Auklet
2. Parakeet Auklet
3. Whiskered Auklet
4. Marbled Murrelet
5. Ancient Murrelet
6. Xantus' Murrelet
7. Craveri's Murrelet
8. Kittlitz's Murrelet
9. Common Murre chick
10. Least Auklet
11. Crested Auklet



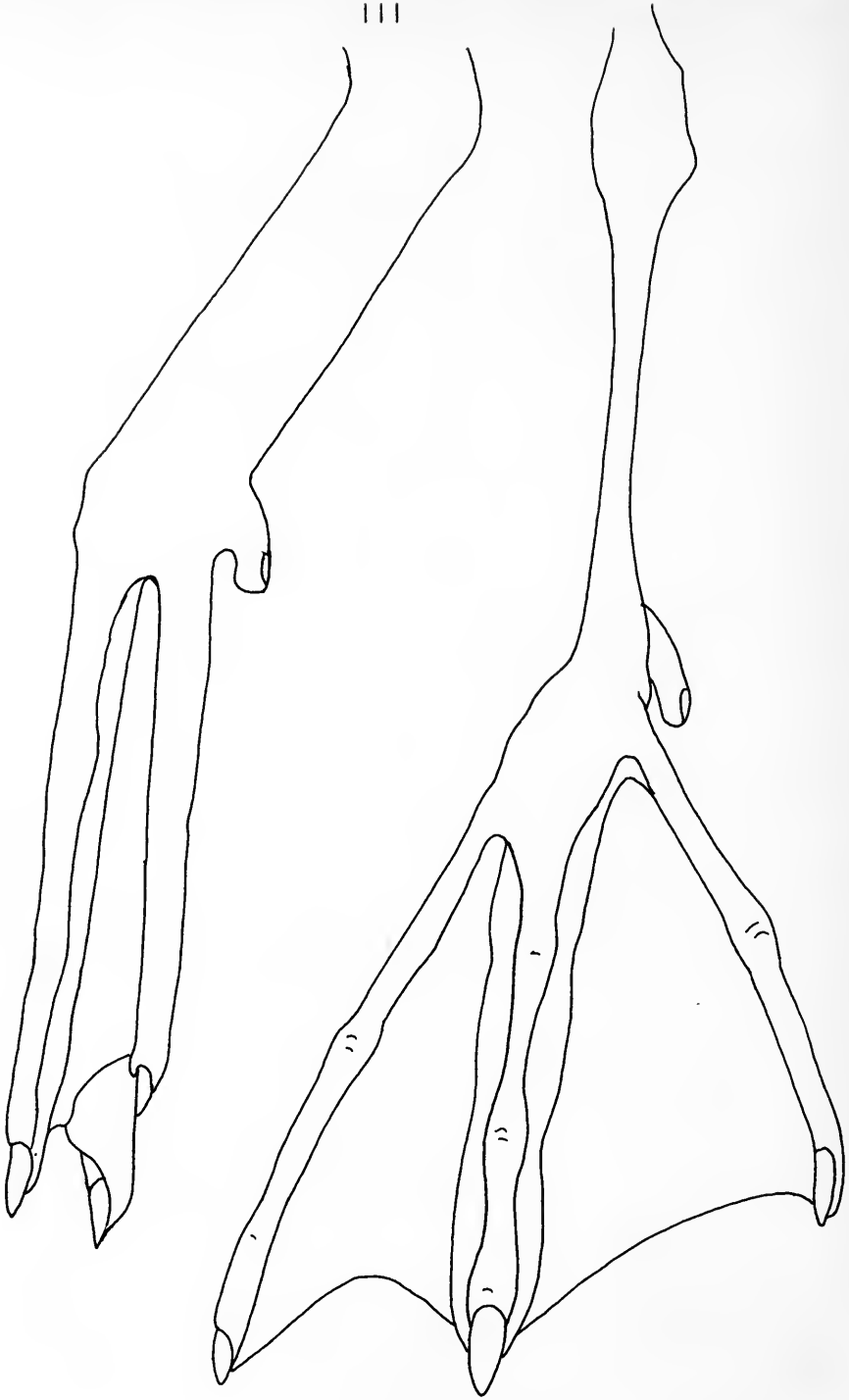

Plate 34 Webbed feet-
Arctic Loon, right foot; webbed
and long

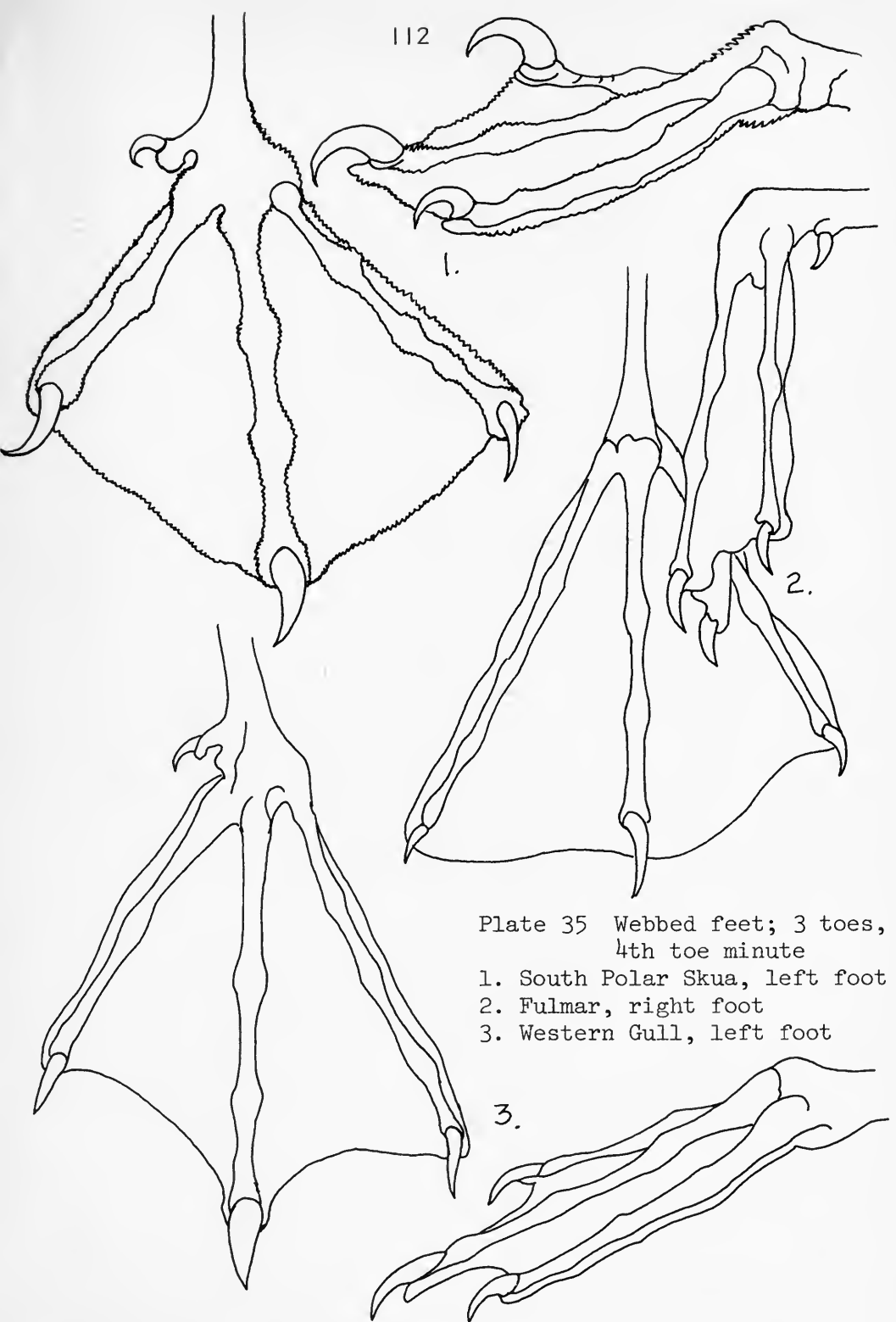

Plate 35 Webbed feet; 3 toes,
4th toe minute

1. South Polar Skua, left foot
2. Fulmar, right foot
3. Western Gull, left foot

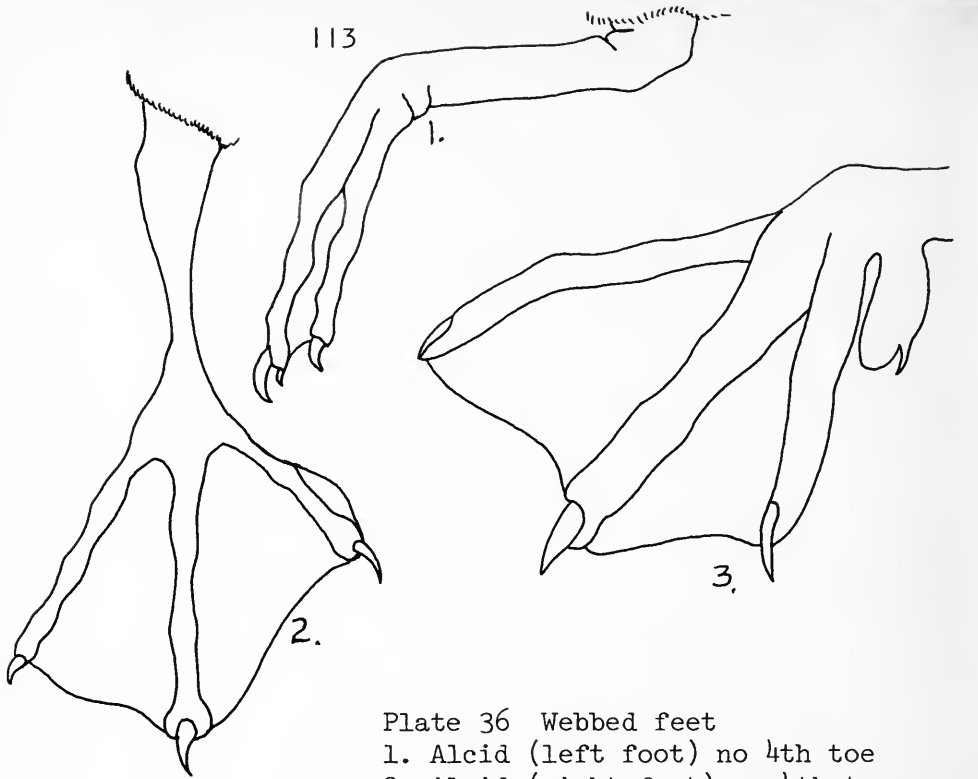
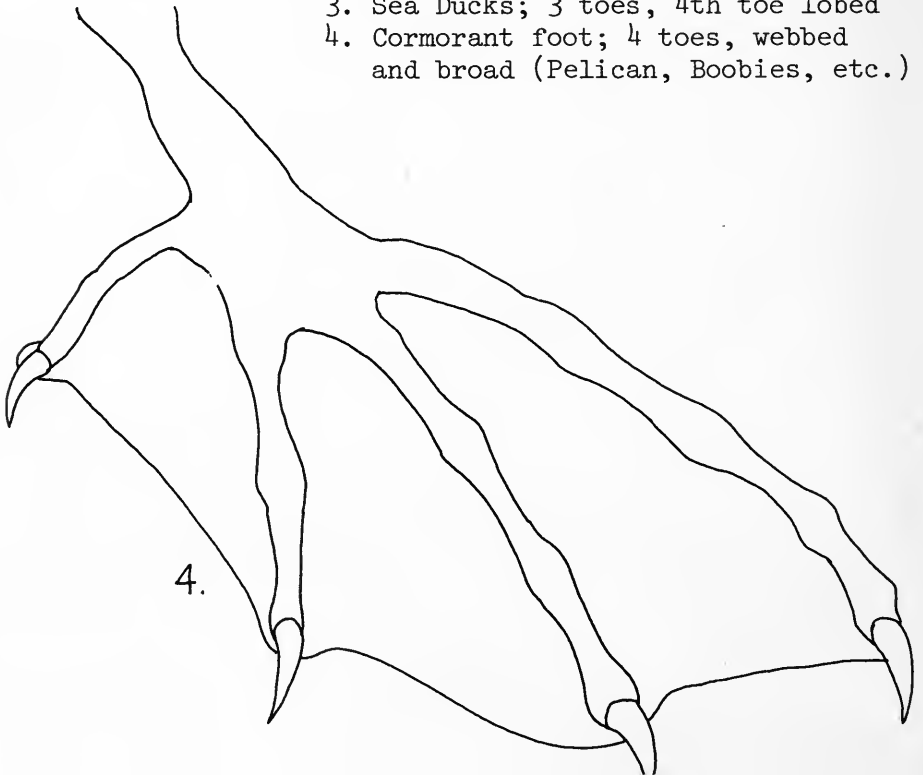

Plate 36 Webbed feet

1. Alcid (left foot) no 4th toe
2. Alcid (right foot) no 4th toe
3. Sea Ducks; 3 toes, 4th toe lobed
4. Cormorant foot; 4 toes, webbed and broad (Pelican, Boobies, etc.)



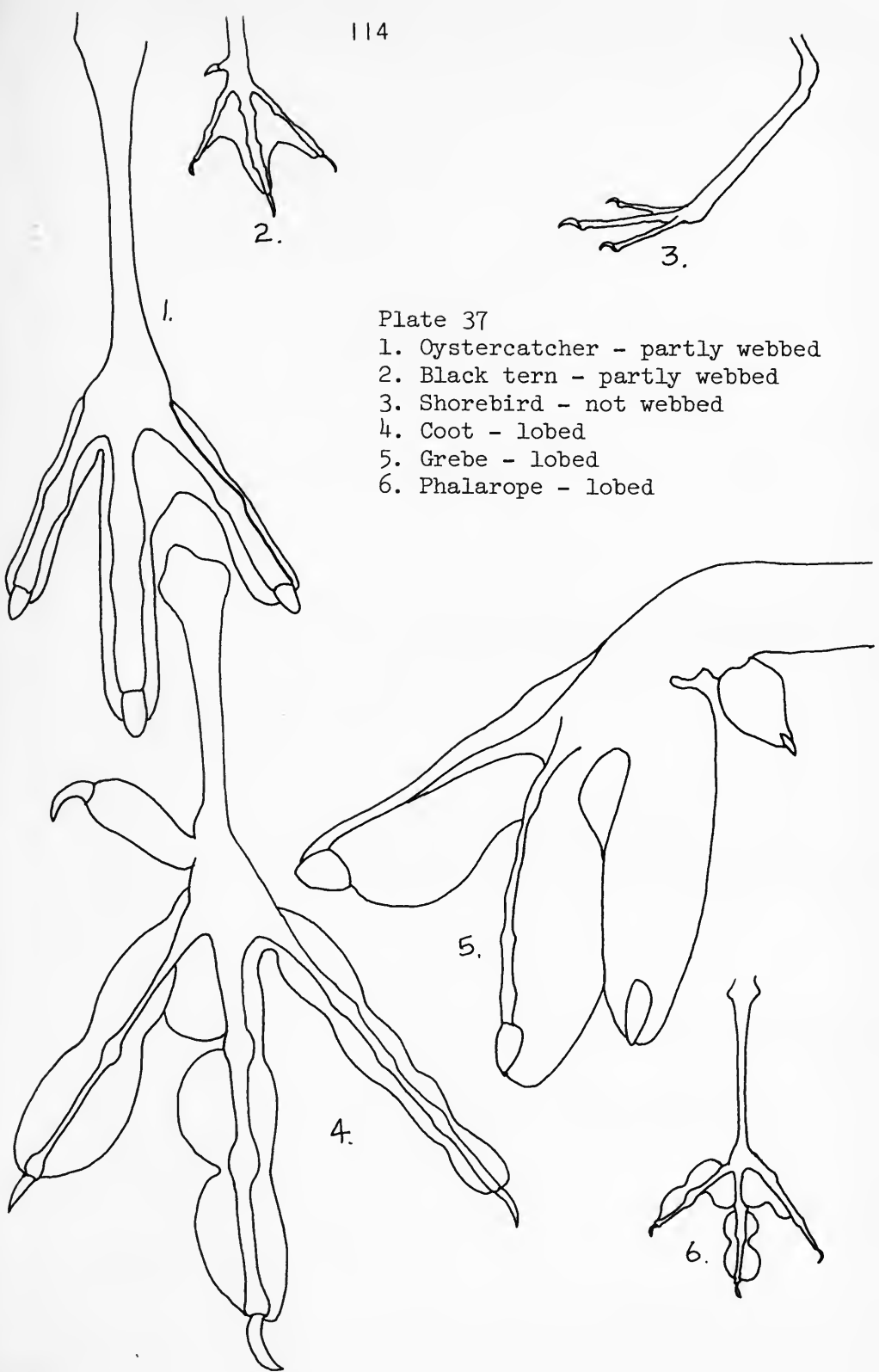

Plate 37

1. Oystercatcher - partly webbed
2. Black tern - partly webbed
3. Shorebird - not webbed
4. Coot - lobed
5. Grebe - lobed
6. Phalarope - lobed

SPECIES ACCOUNTS

In the following accounts we summarize information on geographical range and the usual period of seasonal occurrence of each species inhabiting the region covered by the manual. This information is useful for identifying the likelihood of encountering particular species at particular locations at particular times of the year. Carcasses of species found outside the region of usual occurrence should be saved and the identity of the species carefully verified. If identification is confirmed, the specimen should be donated to a major museum to insure that a permanent record of its presence in the region is kept. There is a chance that each species identified in the manual could occur almost anywhere along the section of coast covered at some time. Some species not included in the manual will also undoubtedly occur here, although very infrequently.

Species are grouped in the following accounts by family and the morphological characteristics of each family are given. Morphological characteristics, not included in the keys, are also given for each species to help the user of the manual confirm the identification of species after use of the keys. In many cases, methods of identifying a species from very similar appearing ones are given. After keying a carcass to species, read the species accounts for all species within its family to minimize the potential for incorrect identifications.

LOONS (GAVIIDAE)

Loons occur commonly in the coastal waters of western North America but mainly during the fall, winter, and early spring. During summer most are engaged in breeding activities on fresh water lakes but from southeastern Alaska south one can expect to find an occasional individual in coastal waters. Along the Bering Sea coast they are present only during summer and early fall. In winter loons occur as far south as Cabo San Lucas, Baja California.

Loons are long and heavy-bodied birds with large webbed feet set far back on their bodies. Their tarsi are flat-sided. The four members of this group all have long stiletto-shaped bills. Along the coast they mostly occur in a rather drab winter plumage but beginning about late April, just before migration to breeding areas, they begin to molt into their striking breeding dress.

COMMON LOON (*Gavia immer*; choice 3, pg. 24) is one of the largest, most heavy-bodied west coast aquatic birds, ranging in weight from 1.6 to 8 kg (3.5 to 17.5 lbs). Its large size, heavier bill (Plate 1-1), and coloration of upper parts (dark brown, each feather tipped with light gray) separate it in winter plumage from Arctic and Red-throated Loons. In breeding plumage there should be no problem in separating any of the loons, except perhaps in distinguishing a headless specimen of the Common *vs.* Yellow-billed Loon (black *vs.* yellow bill, respectively). Consult any field guide for separating breeding-plumaged loons and the keys in this manual; consult Binford and Remsen (1974) for separating winter-plumaged Common and Yellow-billed Loons.

YELLOW-BILLED LOON (*Gavia adamsii*; choice 3', pg. 24) is far less abundant than any of the other loons. One might find an occasional individual along Bering Sea and western Alaskan coasts during late spring or fall and along southeast Alaskan and British Columbian coasts during fall, winter, and early spring. It would be unusual to find one from Washington to central California during the latter period, and even more so farther south; but as they do occur in these regions, the possibility should be considered whenever a very large loon with a light-colored bill is found.

This species is *very* similar in size, color, and shape to the Common Loon, except for the head and especially the bill (see discussion under Common Loon; Plate 1). Do not attempt to distinguish it from the Common Loon if the specimen is headless. Identification should be verified through consultation with a person *very* knowledgeable in loon identification.

ARCTIC LOON (*Gavia arctica*) and RED-THROATED LOON (*G. stellata*; choices 2 and 2', pg. 24) occur along Bering Sea coasts during summer and from western Alaska south to southern Baja California during fall, winter, and spring. Occasional specimens would be encountered in the latter regions during summer.

Among the larger seabirds, they are nonetheless much smaller than the previous two loon species and range in weight from 1.5 to 2.5 kg (up to 5.75 lbs.). In addition to smaller size, they are distinguishable from the two other loons by their much smaller, thinner bills and different back coloration. In winter plumage the upper parts of Arctic Loons are largely dark except for a few scapular feathers each of which have a pair of white spots. Red-throated Loons are similar except for much more spotting all over.

GREBES (PODICIPEDIDAE)

Grebes, like the previous group, occur in coastal waters of western North America mainly during the fall, winter and early spring. During the summer, nesting takes place on fresh water lakes. They are characterized by long necks, streamlined tail-less bodies, very flat tarsi with distinctively lobed feet, white secondaries (except in the largely non-marine Pied-billed Grebe), curved primaries (making the outer wing "cupped"), and their very tight, compact body feathering. Only during late spring would specimens in breeding plumage be found in coastal areas.

WESTERN GREBE (*Aechmophorus occidentalis*; choices 3-4', pg. 25) is an abundant species occurring from southeast Alaska to southern Baja California during the non-breeding period. A specimen encountered on the coast during summer is not unheard of but is noteworthy.

The large size and long, stiletto-shaped bill (Plate 2-5,6) distinguishes most specimens from other grebe species. Headless specimens should be separated from Red-necked Grebe with great care.

RED-NECKED GREBE (*Podiceps grisegena*; choice 2', pg. 25) occurs along most Bering Sea coasts only during summer, is found year round along coasts from the southern Bering Sea to southeast Alaska, and occurs south of there mainly during the fall, winter and early spring but rarely during summer. Individuals found south of central California are worthy of note.

HORNED GREBE (*Podiceps auritus*; choice 6, pg. 25) occurs along southern Bering Sea coasts during summer and from western Alaska to northern Baja California during fall, winter, spring and, rarely, during summer.

Tarsus measurements will separate most specimens from those of Eared Grebes. For headless specimens in winter plumage whose tarsi measure 43-45 mm, separation of the two species is virtually impossible.

EARED GREBE (*Podiceps nigricollis*; choice 6', pg. 26) is found in coastal waters only rarely during the summer, but otherwise year round from British Columbia to southern Baja California. See discussion of Horned Grebe for further clues on identification.

PIED-BILLED GREBE (*Podilymbus podiceps*; choice 5, pg. 25) is not abundant in marine waters, but specimens occasionally occur from British Columbia (perhaps rarely in southeast Alaska) to southern Baja California. They could occur in this region at any time of year. The characteristic shape of the toes, the more extensive webbing between the toes, the difference in white coloration of secondaries, and the tawny color (*vs.* white in the others) of the neck and breast should distinguish specimens of this species from other grebes of its size.

ALBATROSSES (DIOMEDEIDAE)

Enormous size in conjunction with very long, narrow wings are characters that should separate an albatross from any other kind of bird one could encounter. Other large birds such as pelicans, frigatebirds, swans and the largest geese all have rather broad wings. Using the keys properly, one should have no trouble in identifying the albatross specimens unless one finds a species not represented, a very unlikely but possible event. For this reason, the following accounts discuss only the occurrence of each species.

SHORT-TAILED ALBATROSS (*Diomedea albatrus*; choices 2 and 3, pg. 26). It would be truly remarkable to find a specimen now but since the population is recovering slowly from decimation, someday, once again, it could be the most abundant albatross along this coast. If a specimen is found, regardless of its stage of decomposition it should be taken to the nearest major museum. The species could occur at any time of the year in North American waters but perhaps more likely in summer. Its range in the eastern Pacific region used to extend from the Bering Sea to southern Baja California.

BLACK-FOOTED ALBATROSS (*Diomedea nigripes*; choices 4 and 4', pg. 26) occurs from the southern Bering Sea to southern Baja California, though not as abundantly south of the California Channel Islands. Specimens could be encountered at any time of year but mostly during summer.

LAYSAN ALBATROSS (*Diomedea immutabilis*; choice 2', pg. 26). A specimen found south of Oregon would be worthy of note but the event is very possible at least as far south as the California Channel Islands. Otherwise the species mainly occurs along the North American coast from the Aleutian Islands south to Oregon. It is most likely to be encountered during fall and spring.

FULMARINE PETRELS (PROCELLARIIDAE, subfamily FULMARINAE)

These birds are characterized by their rather stout, heavy bills that have an intricate series of separate sections (as shown in the PLATES). As a person, not too familiar with birds, described to us once in referring to a fulmar, he had found a "sea gull with its bill cracked in several places". The large, single tube enclosing the nostrils on the top of the bill (Plate 5) and the tarsi that are rather round in cross-section also distinguish fulmarine petrels from similarly sized and colored shearwaters. The cigar-shaped bodies (including tail) with long, slender wings separate fulmarine petrels and shearwaters from the similarly sized but plumper, more broad-winged and generally more strikingly colored ducks. All petrels, including shearwaters, storm-petrels, etc., possess such a distinctive odor that once one is familiar with it, one can smell it even on very old carcasses.

CAPE PETREL (*Daption capense*; choice 10, pg. 28). On very rare occasions (once every ten years or so) individuals of this species (a breeder on islands in south polar seas) are reported off the western North American coast. Its striking, black and white checkered plumage make it perhaps the most unmistakable bird discussed in this manual.

NORTHERN FULMAR (*Fulmarus glacialis*; choices 13'-14', pg. 29) is one of the most commonly encountered birds along the entire length of the western North American coast during the winter and early spring. Even during summer and fall, finding an occasional individual is to be expected. They probably occur in ice-free areas of the Bering Sea year round, but otherwise occur there mostly during late spring, summer and fall.

Any specimen possessing a head, because of the bill characteristics (see keys and Plate 5-1), cannot be mistaken for any other species (except maybe the Southern Hemisphere SILVER-GRAY FULMAR, which is not known to occur in this area). A headless specimen in dark-phase plumage could be confused with one of the dark shearwaters, and one in light-phase plumage could be confused with an adult gull. The latter, however, is not likely if one is aware of the longer less-broadly proportioned wings of the Fulmar and the characteristic odor of petrels. On the other

hand, distinguishing a dark phase fulmar from a dark shearwater (particularly Sooty Shearwater) does take some experience. A rounder tarsus, and in many specimens, bluish or pale yellow-greenish feet, would identify the bird as a fulmar. Identification should be confirmed with someone experienced in identifying such specimens in the hand.

SHEARWATERS (PROCELLARIIDAE, subfamily PUFFININAE)

Except perhaps in the Bering Sea, shearwaters as a group are among the most abundant seabirds, if not *the* most abundant species, in waters off western North American coasts. Their bodies and wings are quite similar in proportion, size and shape to fulmars. Sometimes, especially in headless specimens, the all dark shearwaters are hard to distinguish from dark phase fulmars (see comments under Northern Fulmar). Otherwise their longer, much more slender bill, much smaller nasal tube which is clearly separated into two passages (Plate 5-5), and flatter-sided tarsi separate them from any fulmar. Shearwaters are about the same general size as many ducks and are smaller than the typical "sea gull".

Shearwaters are rather conservative in coloration. Except for Buller's Shearwater, those occurring here are dark brown above, and dark brown or white below. Important characters to note are size, color of bill and feet, and color of undertail and underwing coverts.

PINK-FOOTED SHEARWATER (*Puffinus creatopus*; choice 18', pg. 30). The light colored feet and bill and dark undertail coverts, in conjunction with the dark upperparts and white breast and belly would separate a specimen of this species from any other that could be encountered except the much smaller Common Shearwater. Pink-footed Shearwaters occur here mostly during summer and early fall but specimens have been found during the winter. They are most abundant south of central California but have been reported as far north as southeast Alaska, where they occur regularly but in small numbers.

FLESH-FOOTED SHEARWATER (*Puffinus carneipes*; choice 19, pg. 30) is identical to the Pink-footed Shearwater except for its completely dark underparts. Its occurrence patterns are also the same except that it is far less numerous. Any specimen encountered should be saved.

BULLER'S (NEW ZEALAND) SHEARWATER (*Puffinus bulleri*; choice 16, pg. 29) is the only strikingly colored shearwater off this coast. It is white below and pearl gray above except for a black cap and a black "W" across its wings and back. In specimens of very worn plumage, it is very similar to the Streaked Shearwater. The fact that the inner webs of primaries are extensively white in Buller's Shearwater would separate such specimens from the latter in which the inner webs are dark.

During the late summer and early fall of some years, Buller's Shearwaters are rather common in coastal waters from central California north to British Columbia. Rarely they occur north or south of there. Any specimens from the Aleutians, Bering Sea or Baja California should certainly be saved for verification. On rare occasions this species has occurred in west coast waters during the winter.

STREAKED SHEARWATER (*Puffinus leucomelas*; choice 18, pg. 30). Only a few records are known for the area, all in central California. The only difficulty in keying out a specimen, with or without a head, would arise when plumage is worn. The color of the undertail coverts and of the inner webs of primaries, and the wing length would then be critical in separating this species from Common, Pink-footed, and Buller's Shearwaters.

SOOTY SHEARWATER (*Puffinus griseus*; choice 20', pg. 30) is distinguishable from other all dark shearwaters mainly on the basis of size. It is smaller than the Flesh-footed and larger than the Short-tailed Shearwater. The light coloration to feet and bill in the first and the generally darker wing linings in the second are additional clues for separating these, respectively, from Sooty Shearwaters.

During most summers and early falls, the Sooty Shearwater ranks among the most abundant birds occurring in coastal waters of western North America, especially from southeast Alaska southward. They occur at other times of the year in low numbers but when any dark shearwater is found among the Aleutians or in the Bering Sea at any time or elsewhere during winter and early spring, the Short-tailed Shearwater should be strongly considered.

SHORT-TAILED SHEARWATER (*Puffinus tenuirostris*; choice 20, pg. 30) is a smaller, slightly more delicately proportioned version of the preceding species. It is abundant in the Bering Sea and in the vicinity of the Aleutian Islands during summer and fall; its numbers drop off rapidly to the south but it has occurred as far south as Baja California. South of Washington they are rather uncommon, and specimens south of California or even central California should be saved for verification. It is more likely that dark shearwaters encountered along the west coast after November are this species rather than the Sooty Shearwater.

MANX (COMMON) SHEARWATER (*Puffinus puffinus*; choice 17, pg. 29). This species' small size should distinguish it from other white-bellied shearwaters occurring off the North American west coast. It occurs quite regularly in Baja and southern California coastal waters during fall and winter and should be expected at other times of the year as well. During fall and winter it has occurred regularly but in small numbers north to central California. One should expect the occasional specimen as far north as southeast Alaska, but north of central California specimens should be saved for verification.

There are actually two forms of this bird that occur along the Pacific coast; controversy exists over whether they are subspecies of a bird that occurs world wide in subtropical and tropical waters ("Common" Shearwater) or whether one (Black-vented Shearwater, *P. opisthomelas* or *P.p. opisthomelas*) or the other (Townsend's Shearwater, *P. townsendi* or *P.p. townsendi*), or both, are distinct species. Little is known about the marine distribution of the Townsend's Shearwater; probably(?) it does not occur very far north along the Baja California coast. Whenever any specimen of the "Common" Shearwater is found, every attempt should be made to determine whether it is a Townsend's or a Black-vented Shearwater. If a Townsend's then without doubt the specimen should be saved, regardless of locality, and donated to a major museum.

The two shearwaters can be separated by several characters. In Townsend's, the undertail coverts are white (sometimes some are mottled brown and white), the crown is black (not a good character in an old or worn specimen), the side of the upper breast is only slightly mottled, and it is smaller (see table below). In Black-vented, the undertail coverts are brown, the crown and other upper parts are browner, the upper breast is mottled, and it is larger. The following measurements (in mm) were taken from Murphy (1952):

	<u>Townsend's</u>	<u>Black-vented</u>
Culmen	28-35	34-42
Wing	220-238	214-251
Tarsus	42-47	43-56

GADFLY PETRELS (PROCELLARIIDAE, subfamily PUFFININAE)

SCALED (MOTTLED) PETREL (*Pterodroma inexpectata*; choice 11, pg. 28). The stout and heavy bill makes this petrel superficially similar to the fulmarine petrels (Plate 5). No other petrel, or seabird, that would likely be encountered in the area has the distinctive underwing color pattern of this one (see keys). It is a strong possibility that Cook's Petrel (*Pterodroma cookii*; Plate 5) will be recorded soon in Baja California or southern California waters. Its completely white underwing linings and belly would distinguish it from the Mottled Petrel.

Mottled Petrels could be found at any time of year. Great numbers are present in summer but for some reason most beach specimens have occurred in winter and spring. They occur in small numbers in the Aleutian and southeast Alaska areas and in even smaller numbers as far south as central California along this coast. Any specimens encountered south of Alaska should be saved.

STORM PETRELS (HYDROBATIDAE)

This group includes the smallest seabird. Some are as small as sparrows and others no larger than robins. Except for one species, all are dark brown or gray with or without white rump feathers. If only a wing is found, identification will be difficult and should be confirmed by someone very familiar with these birds. For that matter, even the identification of entire specimens would best be confirmed by an experienced person.

FORK TAILED STORM-PETREL (*Oceanodroma furcata*; choice 2, pg. 27). Because these birds are pearl gray they cannot be confused with other species of storm-petrels occurring off the coast. North of central California, and into the Bering Sea, they should be expected at any time of year in ice-free areas. South of this region they are more likely to occur during winter but only on rare occasions.

LEACH'S STORM PETREL (*Oceanodroma leucorhoa*; choice 7 and 8', pg.28). This species' size and the dark central feathers in its otherwise white rump should distinguish it from other white-rumped species. Unlike other storm-petrels, from central California south, the rump color of Leach's Storm-Petrels varies tremendously from totally white to totally dark. The greatest difficulty will be in distinguishing dark-rumped Leach's from other dark-rumped species. *Careful* consideration of characters mentioned in the key should suffice in most cases.

North of central California this and the previous species are the only storm-petrels that one should expect to encounter. Leach's Storm-Petrels rarely occur in the Bering Sea even though they breed on many of the Aleutian Islands. From central California north one should find them only during the spring, summer, and early fall. To the south, as far as Baja California, they could be encountered year round.

BLACK STORM PETREL (*Oceanodroma melania*; choice 3, pg.27) is the largest of the all dark storm-petrels off this coast and size alone should distinguish it from any other species. It occurs in southern and Baja California waters mainly from spring to fall although winter occurrences would not be unusual. North to central California they occur quite regularly during late summer and fall. From there north, specimens should be saved for verification.

ASHY STORM PETREL (*Oceanodroma homochoera*; choice 9', pg.28) is the all dark species most similar to the all dark Leach's Storm-Petrel. The fact that it is ashy gray (especially at tips of tertials and secondary coverts), fading in the late summer to brown, should separate it from Leach's which is dark chocolate brown and fades to lighter brown. The underwing coverts are the best to check for these color differences, since fading does not occur very much there. The buffy bar running through the upper wing coverts is much more prominent in Leach's Storm-Petrel. Experience in distinguishing these two birds in the hand helps a great deal since it is not necessarily an easy undertaking.

Ashy Storm Petrels occur year round from northern Baja-California to central California, and in the fall sometimes occur in northern California waters.

GALAPAGOS STORM PETREL (*Oceanodroma tethys*; choice 6, pg. 27), is a very small white-rumped species that is most easily confused with small, white-rumped Leach's Storm-Petrels from Guadalupe Island, off the central Baja California coast. The size of the rump patch relative to the tail length, as described in the keys, should be checked carefully. When checking tail length be sure to note whether feathers are still growing.

On only a few occasions has this species been reported in waters off this coast and never north of central California. All specimens should definitely be saved for verification.

HARCOURT'S STORM PETREL (*Oceanodroma castro*; choice 7', pg. 28) has been reported in this region only at sea off southern Baja California. The white bases of tail feathers should separate any specimen from other white-rumped species.

LEAST STORM PETREL (*Halocyptena microsoma*; choice 9, pg. 28). The extremely small size should separate any specimen of this species from any of the other all dark storm-petrels. The square or even rounded tail is also distinctive.

Least Storm Petrels occur quite commonly from Baja California north to southern California. They have been reported as far north as northern California. Off Baja they occur during the spring to fall period, but north of there, occurrence is pretty much restricted to the fall.

WILSON'S STORM PETREL (*Oceanites oceanicus*; choice 5, pg. 27). The very long tarsi, yellow-webbed large feet, and white lower belly (as well as rump) are characteristics of this species that collectively should set it apart from any others. This visitor from the Southern Hemisphere occurs regularly but in extremely small numbers in west coast waters, mainly during the fall. It has been reported at least as far north as Washington. Any specimens should be saved for verification.

TROPICBIRDS (PHAETHONTIDAE)

RED-BILLED TROPICBIRD (*Phaethon aethereus*; choice 13, pg.21). About the size of a Western Gull, these birds are largely white all over except for fine, black barring on upper parts. Primary wing coverts are black, as is the upper surface of the outer 5 primaries. The bill is very heavy but similar in shape to that of a Caspian Tern (compare Plates 4-2 and 29-1). In adults the bill is scarlet but in juveniles it is yellow. The feet are black.

Red-billed Tropicbirds are quite rare in these waters. They are most likely to be found from San Diego south although individuals have been reported as far north as Washington. They are most likely to appear between May and October.

PELICANS (PELECANIDAE)

There are few marine birds larger than pelicans. The large, uniquely shaped bill and the fact that all four toes are joined by webs (Plate 36-4), in conjunction with the huge body should distinguish most specimens. The Great Blue Heron is bluish-gray in color and has a very long, thin neck and legs; an albatross has much longer and thinner wings (compared to the pelican's very broad wings) as well as only three of its toes joined by webs. The largest Canada Goose, if headless and footless, would be the most similar and would have to be distinguished on the basis of color pattern. The pelican would not have a black neck and tail.

WHITE PELICAN (*Pelecanus erythrorhynchos*; choice 8, pg. 17) is entirely white except for black primaries. Feet and bill are yellowish-green (except during breeding season). They are present along the coast from northern California south only from fall to early spring. The remainder of the year they spend at inland nesting areas.

BROWN PELICAN (*Pelecanus occidentalis*; choices 9 and 9', pg. 17) is mostly brown, except that immatures have white bellies and adults have a good deal of white on the head and neck. The bill is mostly brown (intensifying to reddish during breeding) and the feet blackish. Brown Pelicans occur from British Columbia south during the period from late summer to mid-winter, and occur year round from southern California south. During some years they may occur year round in low numbers as far north as northern California.

BOOBIES (SULIDAE)

Boobies are relatively large seabirds about the size of loons (but not as heavy) and the largest gulls. They have long, wedge-shaped tails, and all four toes are connected by webs (Plate 36-4). The middle toenail is flared to the side and finely cut. It appears much like a curved hair comb (Fig. 17). The bill is stout and sharply pointed with serrated, sharp edges (Plate 8). If the keys are followed closely, there should be little problem in separating the four species in this group.

BLUE-FACED (MASKED) BOOBY (*Sula dactylatra*; choices 5' and 7, pg. 31) could be encountered on rare occasions from central Baja California south.

BLUE-FOOTED BOOBY (*Sula nebouxi*; choice 6, pg. 31) is the most likely booby to be found in the area but even so it is quite rare. Specimens have been encountered as far north as Washington, but any found north of central Baja California should certainly be saved for verification. They have occurred north of there only during late summer and fall.

BROWN BOOBY (*Sula leucogaster*; choices 3, 3', 8 and 9, pp.31-32) is one of the more likely boobies to occur in the area. To find one north of southern California would be remarkable and any specimens north of central Baja California should be saved. In their area of occurrence, records exist for all seasons of the year.

RED-FOOTED BOOBY (*Sula sula*; choices 5, 7' and 9', pp. 31-32) can be quite variable in color, from mostly white to mostly brown. Only two individuals have ever been observed in this area, both during fall in central California.

CORMORANTS (PHALACROCORACIDAE)

Cormorants are relatively large seabirds about the size of the smallest loons and the largest gulls. They are quite heavy for their size. In their first year they are generally brownish all over but by their third year they are black with a bluish, purplish or greenish sheen. As with other Pelecaniformes the four toes on each foot are all joined by webs (Plate 36-4). They have very long, fan- or wedge-shaped tails.

DOUBLE-CRESTED CORMORANT (*Phalacrocorax auritus*; choices 3 and 6, pp. 32-33) is the largest cormorant on the Pacific coast. It is all too often confused with the Brandt's Cormorant which is almost as large. If there is no yellow on the *bill*, it is not a Double-crested Cormorant. People often see the light buffy chin coloration on Brandt's Cormorant specimens and incorrectly misidentify them. The back feathers of a Double-crested Cormorant have a bronze sheen and are edged with black giving a scaled appearance. All other cormorants show an even greenish or purplish sheen.

Double-crested Cormorants are very local in occurrence. They occur year round from the Alaska Peninsula to Cabo San Lucas. From southern Washington to northern Baja California they are rather uncommon compared to other cormorants.

BRANDT'S CORMORANT (*Phalacrocorax penicillatus*; choices 4 and 7, pg. 33). Characteristics of this species are discussed above. From Washington to northern Baja California it is by far the most abundant cormorant; the majority of specimens encountered will be this species. It occurs from southeast Alaska to Cabo San Lucas, and is present year round throughout this range. From British Columbia north its abundance declines rapidly. North of Vancouver Island specimens should be retained for verification.

PELAGIC CORMORANT (*Phalacrocorax pelagicus*; choice 4' and 7', pg. 33) is the smallest cormorant species and is rather more delicate than others in some of its proportions. It is most similar to the Red-faced Cormorant. These two species have white feathers on their flanks only early during the nesting season.

Pelagic Cormorants occur from the Bering Sea to northern Baja California. Except where sea ice forms in the northern Bering Sea, they are present in these areas the year round.

RED-FACED CORMORANT (*Phalacrocorax urile*; choice 3' and 6', pp. 32-33) is most difficult to separate from the Pelagic Cormorant. No more information can be added except what is contained in the keys. If the specimen is headless, identification should be verified by someone experienced in separating the two species in the hand.

Red-faced Cormorants occur mainly in the Bering Sea and among the Aleutian Islands. They also nest on islands off the south coast of the Alaska Peninsula. They are present in these areas year round except where sea ice occurs in winter.

FRIGATEBIRDS (FREGATIDAE)

MAGNIFICENT FRIGATEBIRD (*Fregata magnificens*; choices 3-4', pg. 17) is one of the largest marine birds that occurs along the Pacific coast but its *very* light weight is truly remarkable. The frigatebird's bill is rather long with a very large, sharp hook at the end (Plate 4-1). Except for the white breast of females and the white head, throat and breast of immature birds, their feathers are entirely black. Almost all frigatebirds that occur in this area are immatures.

Frigatebirds occur year round from central Baja California south and quite regularly but in very low numbers during the summer and fall as far north as southern California. They occur north of there, and very rarely as far as Oregon, only during years when waters are unusually warm. North of southern California specimens should be saved for verification.

SWANS AND GEESE (ANATIDAE)

WHISTLING SWAN (*Olor columbianus*; choice 3, pg. 34) and TRUMPETER SWAN (*Olor buccinator*; choice 3', pg. 34) are very large, long necked, white- (juveniles may be washed with gray) bodied, dark-legged birds. Care should be taken separating Whistling from Trumpeter Swans; the important differences are given in the key. Whistling Swans occur between April and September at breeding sites on the western Alaskan coast. During the remainder of the year they may occur at coastal sites from the Aleutian Islands to Morro Bay, California, although most winter between Puget Sound and San Francisco Bay. Trumpeter Swans breed at a few coastal locations in southern Alaska and winter from the Alaska Peninsula south to the Columbia River mouth in northern Oregon.

CANADA GEESE (*Branta canadensis*; choice 7, pg. 34) vary in color and in size depending on the race. Individuals of some races are almost duck-sized; others are much larger. This range in size can be seen in the bill, as well as other parts (Plate 12b-1,2). Canada Geese are basically dark, distinguished by a white chin, white V-bar on the rump and white undertail coverts. Legs, feet and bill are black. Canada Geese breed in coastal areas from western Alaska to Vancouver Island, British Columbia. By late December most have reached wintering areas, which on the coast extend from Vancouver Island to Mexico.

BRANT (*Branta bernicla*; choice 7', pg. 35) are the most marine of the west coast geese. They are slightly larger than a Mallard in size. A white neck collar, sides and undertail coverts contrasts with their otherwise dark plumage. The bill, feet and legs are black. Brant reach their western Alaskan breeding grounds in May and remain until August. They winter from southern Alaska to Baja California from October to April or May. Stragglers have been found in the winter range in June or July.

EMPEROR GOOSE (*Phalacrocorax auritus*; choice 9, pg. 35) is a large, primarily gray bird. It is the only goose on the west coast with dark undertail coverts. The head and neck of adults are white, legs are orange and bill is pink. Bill, head, neck and legs are dark in the immature. Emperor Geese breed along the coast of western Alaska and winter primarily on the Aleutian Islands. Rarely, small numbers may winter as far south as California.

WHITE-FRONTED GOOSE (*Anser albifrons*; choice 9', pg. 35) is a large, brown bird with a white lower belly and undertail coverts, and a white crescent on the rump. Adults have white on the face, pink bills and orange legs. Immatures lack the white face and have yellow bills and legs. Adults have conspicuous dark patches on the belly. White-fronts occur in breeding areas on the coast in western Alaska from about mid-April until August. Most White-fronts winter at inland locations but they occur along the coast between Alaska and California during migrations.

LESSER SNOW GOOSE (*Anser caerulescens*; white phase, choice 4, pg. 34, dark phase, choice 8, pg. 35) and ROSS' GOOSE (*Chen rossii*, choice 4', pg. 34). The white phase of the Lesser Snow Goose and the Ross' Goose are whitish birds with black wing tips (black primaries). Juveniles of both species are washed with drab gray and have dark bills whereas adults lack the gray wash and have pink bills. Adult Ross' Geese may have warty protuberances on the upper bill. Adult Snow Geese may have black lip marks. The Blue Goose, a color phase of the Lesser Snow Goose, is dark bodied and white headed. Blue and Ross' Geese are rare on the west coast. The white phase of the Lesser Snow Goose occurs on the coast during migrations and during the winter at some coastal locations between San Francisco Bay and southern British Columbia.

DUCKS (ANATINAE)

Many species of ducks in male eclipse (worn for a short period after breeding), female, and juvenile plumages are similar in appearance; their body feathering is patterned with various shades of brown, gray and buff and black and white. Individuals in these plumages are best identified to species by size, head and bill shape, and the color pattern of the wing. In almost all cases males in breeding plumage are very distinctive and can readily be identified from the color patterns of the body plumage. The book by Bellrose (1976) has plates showing the wing patterns of all species. Determining the sex of many species in the late summer and early fall may be difficult since adult males in eclipse plumage and females and juveniles may all be drab in color and similar in appearance. Sexing and aging some species during this period may be done from wing characteristics as described in Carney (1964).

MALLARD (*Anas platyrhynchos*; choice 54 and 54', pg. 41) is identified by a violet-blue speculum bordered fore and aft by a white stripe. The wing of the female Steller's Eider is generally similar except that the blue coloration extends well into the tertials whereas it does not in the Mallard. Mallard bills are yellow to orange and black; their legs are orange. Domestic ducks have been bred from the Mallard stock. They vary considerably in coloration; the extreme is pure white. Be on the lookout for these birds. Mallards breed near the coast from western Alaska to California; they winter from western Alaska south.

GADWALL (*Anas strepera*; choices 47 and 47', pg. 40). The male in breeding plumage is brown headed, gray and brown backed and black rumped. The bill is blackish, the legs are orange. In other plumages the species is best identified from the wing characteristics described in the key. Except for the wing, female Gadwalls and Mallards are similar. The Gadwall's bill is distinctly smaller than the Mallard's (Plate 13). Gadwalls occur along the coast from British Columbia south, except during summer.

PINTAIL (*Anas acuta*; choices 56 and 56', pg. 41). Males in breeding plumage have a very distinctive brown and white head and central tail feathers much longer than the outer ones. Birds in other plumages are mottled brown. Pintails are the most common duck on the Pacific flyway. They breed from Alaska to California but not along the coast south of central British Columbia. They winter from the Aleutian Islands south.

GREEN-WINGED TEAL (*Anas crecca*; choices 58 and 58', pg. 41) is the smallest duck; its wing pattern and bill (Plate 13-4) distinguishes it from Cinnamon and Blue-winged Teals in all plumages. Green-wings breed from northern Alaska to central California, although from British Columbia south they are primarily inland. The winter range extends from southern Alaska to Mexico.

BLUE-WINGED TEAL (*Anas discors*; choices 51 and 52, p. 40) and CINNAMON TEAL (*Anas cyanoptera*; choices 51 and 52', pp. 40-41) are pigeon-sized ducks. Except for breeding-plumaged males these species are indistinguishable in coloration from one another. On the west coast Cinnamon Teal are far more common than Blue-winged Teal. The latter species is rare to uncommon on the coast from Alaska south. Cinnamon Teal breed near the coast from British Columbia to Baja California and winter from central California south.

AMERICAN WIGEON (*Anas americana*; choices 59 and 59', pg. 41). Wigeons are characterized by their white to gray upper wing coverts and greenish secondaries; their bills are bluish and black tipped; their dark flanks contrast sharply with their white belly. The EUROPEAN WIGEON (*Anas penelope*) occurs rarely with American Wigeons on the coast. It has dusky "wing-pits"; the American's are white. Male European Wigeons in breeding plumage have a mostly cinnamon head; the American's is gray, white and green. The American Wigeon's breeding range extends from Alaska to southern British Columbia but is primarily inland. During migration it occurs coastally from Alaska south and during winter from Puget Sound south.

NORTHERN SHOVELER (*Anas clypeata*; choices 50 and 50', pg. 40) has a wing similar in appearance but larger (see key) than those of Blue-winged and Cinnamon Teals. Shovelers have a distinctive spoon-shaped bill (Plate 14-1) and bright orange legs and feet. They breed from Alaska south to central California but except in Alaska occur inland. They winter from British Columbia south.

REDHEAD (*Aythya americana*; choices 27 and 27', pg. 37) is most similar in appearance to the Canvasback, Ring-necked Duck and scaups. Head shape and bill length separate it from the Canvasback (see key and Plates 14a,b), lack of white secondaries from scaups and lack of a white base to the upper mandible from the Ring-necked Duck. Redheads are uncommon along the west coast; they winter in bays from Puget Sound to Baja California. Very small numbers may breed in isolated locations near the coast in Alaska.

CANVASBACK (*Aythya valisineria*; choices 26 and 26', pg. 37) is distinguished by its long sloping forehead and bill (well illustrated in field guides) in all plumages. Its bill is black in contrast to the bluish bill of the Redhead and scaups. Canvasbacks breed near the coast in some Alaskan locations; they winter from British Columbia south.

GREATER SCAUP (*Aythya marila*; choices 34 and 34', pg. 38) and LESSER SCAUP (*Aythya affinis*; choices 35 and 35', pg. 38) have distinctive white speculums bordered by dark brown or black on the trailing edge. The two species are difficult to separate; the wing characteristics offer the best clues (see key). Both species breed in Alaska. Greater Scaups winter from British Columbia to southern California, Lesser Scaups from British Columbia to Baja California.

COMMON GOLDENEYE (*Bucephala clangula*; choices 43' and 44', pp. 39-40) and BARROW'S GOLDENEYE (*Bucephala islandica*; choice 43' and 44, pg. 39) have dark wings with white speculums, white on some secondary coverts, small bills (Plate 15a-1,2) and yellow or orangish legs. Breeding plumaged males have a white patch between the eye and bill. This patch is lacking in goldeneyes in other plumages. The shape of the white patch on the face of breeding-plumaged males is important to consider (see key and Plate 15b-1,2). The two species can be difficult to separate when not in male breeding plumage. The shape of the trachea and syrinx ("voice box") should then be noted (see Bellrose 1976). Common Goldeneyes breed in Alaska. They winter from the Aleutian Islands to Baja California, but sparsely south of California. Barrow's Goldeneyes also breed in Alaska. They winter from the Aleutian Islands to San Francisco Bay but are much less common than Common Goldeneyes south of British Columbia.

BUFFLEHEAD (*Bucephala albeola*; choices 45 and 45', pg. 40) has dark wings, a white speculum, a small flattened bill (Plate 15b-5), and a white patch on the head behind the eye. It breeds near the coast in Alaska; it winters from the Aleutian Islands to Baja California.

OLDSQUAW (*Clangula hyemalis*; choices 14 and 14', pp. 35-36) vary considerably in plumage but all have white on the head, a dark colored speculum, white sides, bluish legs and feet, and small bills (Plate 15a-3). Males often have very long central tail feathers. Oldsquaws breed along the coast of western Alaska. They winter from St. Lawrence Island, Alaska, south to California but become rare at the southern end of their range.

HARLEQUIN DUCK (*Histrionicus histrionicus*; choices 21 and 21', pp. 36-37) has three white patches on the head. The brightly colored male in breeding plumage has two patches behind the eye and one between the eye and bill; in other plumages it has white patches above, below and behind the eye. The bill is small (Plate 15a-4). The species nests near the coast from western Alaska to northern Washington. It winters from the Aleutian Islands to central California but is most abundant in Alaska.

STELLER'S EIDER (*Polysticta stelleri*; choices 20 and 20', pg. 36) has a blue and white speculum similar to the Mallard's but unlike the Mallard it has much blue in the tertials. The male's secondary coverts are white in breeding plumage. The bill is shaped differently from other eiders (Plates 17, 18). In summer it occurs from west to south-central Alaska, in winter from the Alaska Peninsula west through the Aleutian Islands.

COMMON EIDER (*Somateria mollissima*; choices 29 and 31', pp. 37-38). Males in breeding plumage have distinctive white, black and green heads and a distinctive sloping forehead and bill (Plate 17-2). In other plumages birds may be separated from King Eiders which have U- and V-shaped markings on the flanks, whereas the Common Eider's markings are wavy. Bill shape and lack of a spectacle separates Common from Spectacled Eiders. Common Eiders breed from southeast Alaska north. They winter primarily in the Bering Sea, but occasionally from Alaska to Washington.

KING EIDER (*Somateria spectabilis*; choices 23 and 31, pp. 37-38). Breeding plumaged males have a distinctive orange bill (Plate 17-4) and a black, white, green and bluish head. In other plumages it lacks the spectacles of the Spectacled Eider and the dark wavy bars on the flanks of the Common Eider. It occurs primarily in Alaska, rarely south to California.

SPECTACLED EIDER (*Somateria fischeri*; choices 23' and 30, pp. 37-38) has a pale circular patch around the eye giving it the appearance of wearing goggles and a distinctive shaped bill with feathers extending to the nostril (Plates 17, 18). It breeds along the Alaskan coast south to the Kuskokwim River. There are a few winter records from southwestern Alaska. They are extremely rare farther south.

WHITE-WINGED SCOTER (*Melanitta fusca*; choices 41 and 41', pg. 39) has brown to black wings contrasted with a white speculum. Legs and feet are pink or orangish. Breeding plumaged males have white feathering around the eye; females have a white patch between the eye and bill and another behind the eye. Immature males may have no white on the head. It winters from southwest Alaska to Baja California and can occasionally be found overwintering in this area.

SURF SCOTER (*Melanitta perspicillata*; choice 16 and 16', pg. 36) and BLACK SCOTER (*Melanitta nigra*; choices 17 and 17', pg. 36) have uniformly dark wings and backs. Males in breeding plumage are dark ventrally; females and juveniles are whitish ventrally. Surf Scoters have orangish legs. Males have a white patch on the back of the head and females and juveniles a white patch between the bill and eye and another behind the eye. Black Scoters are black-legged. Males have no white on the back of the head or on the bill; the sides of the head are largely whitish in females and juveniles. Surf Scoters winter from southwestern Alaska to Baja California and to some degree overwinter in their winter range. Black Scoters breed along the coast of western Alaska and winter from the Aleutian Islands to southern California.

RUDDY DUCK (*Oxyura jamaicensis*; choice 12', pg. 35) is a small brown or black-capped duck with a large whitish patch on the side of the head, uniformly dark wings, and bluish legs and feet. Breeding-plumaged males have striking blue bills and ruddy back coloration. Small numbers of Ruddy Ducks breed near the coast from Vancouver Island to Baja California. Much larger numbers winter along the coast in that area.

COMMON MERGANSER (*Mergus merganser*; choices 38 and 38', pg. 39) and RED-BREASTED MERGANSER (*Mergus serrator*; choices 39 and 39', pg. 39) are narrow-billed ducks (Plate 19). Bills and legs are orangish. The wings have white patches. Breeding-plumaged males have green heads; in other plumages the head is brownish. The two species are best identified by characteristics given in the key. Red-breasted Mergansers breed near the coast through much of Alaska and northern British Columbia. They winter from southeast Alaska to Baja California. Common Mergansers breed near the coast from south-central Alaska to northern California. They winter from southeast Alaska to Puget Sound and less commonly to southern California.

RAILS, GALLINULES, AND COOTS (RALLIDAE)

AMERICAN COOT (*Fulica americana*; choice 7, pg. 20) is a slaty to black-bodied bird with white under the tail. An entire carcass, with its chicken-like bill (Plate 19-5) and lobed toes (Plate 37-4), is unmistakable. Wings of a coot might be confused with those of a murre because both have black secondaries with white tips. However, the outer edge of the outer primaries are white on the coot but not on the murre, and the coot's wings are much broader and less pointed. American Coots may be found from British Columbia to Baja California year round.

OYSTERCATCHERS (HAEMATOPODIDAE)

AMERICAN OYSTERCATCHER (*Haematopus palliatus*; choice 3, pg. 42) and BLACK OYSTERCATCHER (*Haematopus bachmani*; choice 6', pg. 42) are moderate sized, heavy-set birds with a long laterally-compressed bill, red in adults and brown in juveniles. Bill size is not a good character for separating the two species. Adults of both species are pink-legged. The two species are easily distinguished. The Black Oystercatcher's plumage is entirely black-brown, but that of the American Oystercatcher is white ventrally. Both species are year round residents in their ranges. American Oystercatchers have only rarely been found north of Baja California. Black Oystercatchers occur from the Aleutian Islands to northern Baja California but become relatively uncommon on the mainland coast south of central California.

AVOCETS AND STILTS (RECURVIROSTRIDAE)

BLACK-NECKED STILT (*Himantopus mexicanus*; choice 6, pg. 42) is a slender moderate-sized, black and white shorebird with long, pink legs and a straight, slender bill (Plate 23-7). Breeding, winter, and juvenile plumages are very similar. It can be found from the San Francisco Bay area to Baja California year round.

AMERICAN AVOCET (*Recurvirostra americana*; choice 7, pg. 44) is a slender, moderate-sized, long-legged bird with a distinctive, thin, upturned bill (Plate 23-6). In breeding plumage, worn from about February to August, their heads and necks are cinnamon; in winter plumage, worn from about August to February, heads and necks are light gray. Body feathering is black and white. Avocets occur along the coast from the San Francisco Bay area to Baja California year round and in northern California from late summer to spring. They are rare on the Oregon and Washington coasts.

PLOVERS (CHARADRIIDAE)

Plovers are small to moderate-sized shorebirds with short necks, large eyes and short bills that are swollen slightly at the tip (Plate 20).

AMERICAN GOLDEN PLOVER (*Pluvialis dominica*; choice 16, pg. 45) and BLACK-BELLIED PLOVER (*Pluvialis squatarola*; choices 4' and 25, pp. 42 and 46). These two medium-sized birds superficially resemble each other in both winter and breeding plumages. Breeding plumage, possible from March to October, is mostly black ventrally; winter plumage is mostly white and gray-brown ventrally. Both species have dark dorsal feathering with white to golden spotting. Black-bellies have short hind toes which Golden's lack. The white rump and wing stripe of the Black-belly are also lacking in the Golden. Black-bellies have black axillar ("wing pit") feathers; the Golden's axillaries are light. Black-bellied Plovers can be found year round from British Columbia to Baja California and in Alaska from April to October. Golden Plovers occur in Alaska from May through October. They occur as spring and fall migrants from British Columbia to California. A few Golden Plovers winter in California, from November through February. American Golden Plovers are much less common than Black-bellied Plovers along the coast south of Alaska.

SEMIPALMATED PLOVER (*Charadrius semipalmatus*; choice 28, pg. 47) is small (about half a Killdeer's size) with dark brown dorsal and white ventral plumage. A single dark ring extends around the neck. Breeding-plumaged birds have an orange bill with a black tip, juvenal- and winter-plumaged birds have all black bills. Legs and feet are orange to yellow. It occurs in Baja California from July to May, in California year round, and from Oregon to Alaska from April to October.

WILSON'S PLOVER (*Charadrius wilsonia*; choice 37, pg. 49) is slightly larger, has a longer bill (see Plate 20-3) and a wider breast band than the superficially similar Semipalmated Plover. Wilson's Plover have black bills and pinkish legs. They occur year round from central Baja California southward.

KILLDEER (*Charadrius vociferus*; choice 27, pg. 47) are small plovers with brown dorsal and white ventral feathering. They are distinguished by an orange rump and two dark breast bands. Killdeers occur sparingly in Alaska from April to August, and commonly from British Columbia south year round.

SNOWY PLOVER (*Charadrius alexandrinus*; choice 30', pg. 48) is a small, light grayish-brown backed, white-bellied bird. The neck markings do not form a complete ring as in other small plovers but appear as shoulder patches. Bill and legs are blackish. Snowy Plovers occur from Oregon to Baja California, and sparingly in Washington, year round.

MOUNTAIN PLOVER (*Charadrius montanus*; choice 30, pg. 48) has a golden brown back, white underparts, an all black bill, and light colored legs. They lack a neck ring and a shoulder patch. Breeding plumaged adults have a black forehead mark. They occur in Baja California and uncommonly along the coast to northern California from September to March.

SANDPIPERS (SCOLOPACIDAE)

Sandpipers vary markedly in size, leg and bill length, and bill shape (Plates 21-24). They range in size from the 20 gram Least Sandpiper to the 900 gram Long-billed Curlew. Sandpipers are generally longer-billed, longer-necked and smaller-eyed than the plovers.

BAR-TAILED GODWIT (*Limosa lapponica*; choice 12, pg. 44) is moderate sized and has a long, straight to slightly upturned bill (Plate 23-5). The tail is whitish to light tan with dark crossbars. Breeding plumage, possible from April to October, is reddish-chestnut to buffy-tan below and dark brown and cinnamon above. The winter and juvenal plumages are gray-brown above and white to buffy-tan below. It occurs along the south coast of Alaska from May to September; it is very rare further south.

MARBLED GODWIT (*Limosa fedoa*; choice 10, pg. 44) is similarly shaped but slightly larger than the Bar-tailed Godwit. Marbled Godwits are marbled pinkish-tan and dark brown above and cinnamon below in all plumages; their tails are barred cinnamon and dark brown. They are common from California south year round and are increasingly less common during spring and fall migration as far north as southern Alaska.

WHIMBREL (*Numenius phaeopus*; choice 11', pg. 44) is moderate-sized with a long, decurved bill (Plate 23-3), dark and light brown body feathering, and two dark brown crown stripes in all plumages. The rump and tail are barred, light and dark brown, and do not contrast with the back. Whimbrels occur in Baja California and California year round, from Oregon to British Columbia from about March to November, and in Alaska from April to October.

BRISTLE - THIGHED CURLEW (*Numenius tahitiensis*; choice 11, pg. 44) differs from the very similar Whimbrel in having tawnier dorsal and ventral body feathering, an unbarred reddish brown rump, and sometimes long bristle-like feather shafts on the belly and thigh. It is found along the coast of western Alaska near the Yukon River delta from May through August.

LONG-BILLED CURLEW (*Numenius americanus*; choice 10', pg. 44) is a moderate-sized, cinnamon colored bird with a long slender bill. It is the largest North American shorebird. It is more cinnamon in color and has less distinct dark head stripes than the other curlews. These curlews can be found year round in California and Baja California and during migration may be found along the Oregon and Washington coasts.

GREATER YELLOWLEGS (*Tringa melanoleuca*; choice 12' and 17, pp. 44-45) and LESSER YELLOWLEGS (*Tringa flavipes*; choice 17', pg. 45) are moderate sized with straight, slender bills (the Greater's may be slightly up-turned)(Plate 22-2) and long, bright yellow legs that extend beyond the tail. Both species are slaty- to brown-backed and ventrally white with some dark streaking on the throat, sides and breast. Size, described in the key, is the best criterion for separating the two species. Both species may occur in Alaska from April to September, in Washington and Oregon between April and November, and in California and Baja California from July to May.

WILLET (*Catoptrophorus semipalmatus*; choices 4 and 24, pp. 42 and 46) is a moderate-sized, gray or brown-backed bird with bluish-gray legs and a straight black bill (Plate 22-1). The extended wing shows a conspicuous whitelongitudinal bar on the dorsal and ventral surface. Breeding plumage, possible between March and August, is dorsally brown and heavily streaked and barred. Back feathers of juveniles are brownish with pinkish edges (from July to September); back feathers of winter birds are uniformly gray. Willets occur along the Washington and Oregon coasts as migrants between April and October. On the California and Baja California coasts they occur year round.

SPOTTED SANDPIPER (*Actitis macularia*; choice 26, pg. 46) is small and straight-billed. It has light-colored legs, a grayish-brown back and white underparts which are black-spotted in breeding plumage. It occurs on the Ataskan coast from May to October and on the coast from Washington south year round.

WANDERING TATTLER (*Heteroscelus incanum*; choice 18, pg. 45) is robin-sized, straight-billed, yellow-legged and ashy-colored dorsally. Winter plumage (about August to March) is white ventrally; breeding plumage (about March to August) ventrally is white, streaked with ashy on the throat and barred ashy on the belly. It occurs from Alaska to Oregon between April and September and may be found from California south at any time of year.

RUDDY TURNSTONE (*Arenaria interpres*; choice 23', pg. 46) and BLACK TURNSTONE (*Arenaria melanocephala*; choice 23, pg. 46) are stocky, robin-sized birds with stout, slightly upturned bills that taper to a point (Plate 21-7,8). Leg color varies from orange to black.

The Ruddy Turnstone has a harlequin facial pattern, which is subdued in winter and juvenal plumage, a light and dark chest pattern, and a white throat. Breeding plumaged birds have rusty backs. In contrast, the Black Turnstone has a uniformly dark brown to blackish head, throat and chest, and no rusty dorsal feathering.

Ruddy Turnstones occur from Alaska to Oregon from May to October and from California south year round. Black Turnstones occur in northwestern Alaska from May to September and from southeastern Alaska south year round.

WILSON'S PHALAROPE (*Steganopus tricolor*; choice 20, pg. 45) is robin-sized and is the largest of the three phalaropes. It is yellow-legged. Its toes are not as distinctively lobed as in the other phalaropes. Breeding females are patterned gray, chestnut, black and white dorsally. These colors are subdued in breeding males. In other plumages both sexes are gray or brown dorsally and white ventrally. They occur locally on the coast from Washington south between April and November but are much less likely to be encountered on the outer coast than the other two phalaropes.

NORTHERN PHALAROPE (*Lobipes lobatus*; choice 34, pg. 48) and RED PHALAROPE (*Phalaropus fulicarius*; choice 34', pg. 48). Carcasses of both these species are common at times on beaches. Both species have lobed toes and straight bills. Red Phalaropes have yellowish and Northern Phalaropes have black legs. In winter plumage both species are gray above and white below but in breeding plumage Northern Phalaropes are strikingly patterned with black, brown, chestnut-buff and white, while Red Phalaropes are more uniformly colored deep chestnut ventrally and blackish-brown dorsally. Breeding plumage in males is much more subdued than in females. The bill of the Red Phalarope often shows yellow basally, that of the Northern Phalarope is entirely black. The Northern Phalarope's bill is more needle-like than the Red's (see Plate 21-2,3).

Northern Phalaropes occur in Alaska from April to September, in Washington to October, and in California to November. Red Phalaropes occur in Alaska from May through October and in Washington through November. From Oregon south they may be found between March and December.

COMMON SNIPE (*Capella gallinago*; choice 14, pg. 45) is between the size of a sparrow and a robin. Its bill is straight and very long (Plate 22-8). Its tail is mostly orange. In all plumages the snipe is various shades of brown and buff dorsally, has blackish crown stripes, and a white belly. It occurs in Alaska mainly between April and October and from coastal British Columbia south mainly between September and May. Because of its preference for freshwater marshes, snipes are likely to be very rare on beaches.

SHORT-BILLED DOWITCHER (*Limnodromus griseus*) and LONG-BILLED DOWITCHER (*Limnodromus scolopaceus*; choice 19, pg. 45) are slightly larger than a robin. Their straight bills are very long (Plate 22-6,7). The legs are yellowish. They have a distinctive patch of white extending from the middle of the back to the rump. The tail is barred black and white. In breeding plumage they are rusty to salmon ventrally but in winter plumage they are drab gray-brown dorsally and white and gray-brown ventrally. The two species are very difficult to separate; only experienced observers should attempt to do so. See Pitelka (1950) for the best criteria to separate the two species. In Alaska dowitchers may occur between April and October, from British Columbia to northern California between mid-March and November and from northern California south year round.

SURFBIRD (*Aphriza virgata*; choice 32, pg. 48) is slightly larger than a robin. Its bill is short and stout, and its yellowish legs are heavy-set. A triangle of black on its tail points toward its white rump. Dorsal feathering is variegated chestnut and blackish in summer but sooty-gray in winter. The breast is heavily marked with black chevrons in summer but is sooty-gray in winter. Surfbirds may occur on the coast from Alaska to Baja California year round.

RED KNOT (*Calidris canutus*; choice 35, pg. 48), slightly larger than a robin, has a straight bill about the same length as the head (Plate 24-1). In breeding plumage, worn from about March to September, the bird is black, gray and rusty dorsally; ventrally it is rusty except for white under the tail. In winter plumage (about August to May) and juvenal plumage dorsal feathering is gray, and ventral feathering white. Knots can be found along the Alaskan coast from about April to August, along the Washington coast from about February to November and from California south year round.

SANDERLING (*Calidris alba*; choice 33, pg. 48) is slightly smaller than a robin, has a fairly short, straight bill, and black legs. In contrast to other sandpipers, this species lacks a hind toe. Breeding plumage (May to August) is accentuated with rust on the back, head, throat and breast. Winter plumage is gray above and white below. Juveniles have black dorsal feathers that are edged with gray. Sanderlings occur on the Alaskan coast between May and September and south of there from July through May.

SEMIPALMATED SANDPIPER (*Calidris pusilla*; choice 44, pg. 50), WESTERN SANDPIPER (*Calidris mauri*; choice 44', pg. 50), RUFIOUS-NECKED SANDPIPER (*Calidris ruficollis*; choice 43', pg. 50), and LEAST SANDPIPER (*Calidris minutilla*; choice 43, pg. 50) are sparrow-sized, brown- to grayish-backed, white-bellied sandpipers that are difficult to separate. Their bill shapes and lengths differ somewhat (see Plate 24) and are important in identification. Rusty coloration is prominent on the top of the head in the scapulars of breeding-plumaged Western Sandpipers (April-August) and on the throat and sides of the head of breeding-plumaged Rufous-necked

Sandpipers. Breeding-plumaged Least Sandpipers (April to August) have dark brown streaking over a light brown wash on the breast which is distinctive. The winter and juvenal plumages of the four species are very similar; field guides should be used to verify the identification of Least and Western Sandpipers and comparison with museum specimens to verify the identification of Rufous-necked and Semipalmated Sandpipers. Semipalmated Sandpipers are rare and Rufous-necked Sandpipers very rare on the west coast. Least and Western Sandpipers in comparison are abundant.

Semipalmated Sandpipers occur on the west coast between May and September. Western Sandpipers occur in Alaska between April and September, from British Columbia to Oregon from March through November and from California south year round. The Rufous-necked Sandpiper occurs in Alaska from June to August and has been found only rarely as far south as California between May and August. Least Sandpipers occur in Alaska from April to September, in Washington from April to December, and from Oregon south year round.

WHITE-RUMPED SANDPIPER (*Calidris fuscicollis*; choice 41', pg. 49) is slightly larger than a sparrow, has black legs, wings that extend beyond the tail and a straight bill about the same length as the head. It has a white rump. The only other shorebird of similar size with a white rump is the Curlew Sandpiper. These two species can be separated by bill shape (see Plate 24-7,8). White-rumped Sandpipers are very rare on the west coast.

BAIRD'S SANDPIPER (*Calidris bairdi*; choice 40, pg. 49) is similar in size and shape to the White-rumped Sandpiper but it does not have a white rump. The bill and legs are black. Adults are dark brown and buff dorsally, sandy-gray and dusky-streaked on the breast and white on the belly. Juveniles are more salmon than buffy colored dorsally. It occurs in limited numbers along the west coast in fall and rarely in spring.

PECTORAL SANDPIPER (*Calidris melanotos*; choice 21', pg. 46) is variable in size, between that of a sparrow and a robin. The bill is straight and black, and is slightly longer than the length of the head. The legs are yellow-green. The breast is very heavily streaked with dark brown, but the streaking ends abruptly in a straight line where it meets the white belly. It occurs in limited numbers along the west coast in fall and rarely in spring.

SHARP-TAILED SANDPIPER (*Calidris acuminata*; choice 21, pg. 46) is generally similar in size and coloration to the Pectoral Sandpiper. Juveniles, which are more likely than adults to occur on our coast, have breasts that are not streaked centrally but are washed with an orange-brown. The crown has considerable rufous coloration. Juveniles of this species occur rarely on the west coast as far south as California from August to November.

ROCK SANDPIPER (*Calidris ptilocnemis*; choice 39', pg. 49) is somewhat smaller than a robin and has a slender, tapered bill with a yellowish base, and dull yellowish to greenish legs. In breeding plumage back feathers are black with rufous, ochre, and white edges; the white under surface has a large dusky patch on the lower breast and belly. In winter and juvenal plumage, birds are medium gray dorsally. They have heavy gray streaking on the neck and breast, but the belly is white. Rock Sandpipers may be found in Alaska year round and farther south from October to May.

DUNLIN (*Calidris alpina*; choice 39, pg. 49) is between a sparrow and a robin in size. Its legs are black, as is its long, slightly downcurved, tapered bill. In breeding plumage (April to September) they have much rufous coloration dorsally and a black belly patch. Winter plumage is gray-brown dorsally and white ventrally. In juvenal plumage (July to September) dorsal feathering is edged with rufous; the throat and breast have diffuse streaking. Dunlins occur in Alaska from April to October and farther south from September to May.

CURLEW SANDPIPER (*Calidris ferruginea*; choice 41, pg. 49) is a white-rumped bird between a robin and sparrow in size. The black bill is fairly long and curved downwards (sometimes only slightly) at the tip (Plate 24-8). Legs are black. In breeding plumage the ventral feathering is brick red, a color lacking in winter and juvenal plumages. Curlew Sandpipers are rare on the west coast; they are most likely to be found between April and September.

SKUAS AND JAEGER (STERCORARIIDAE)

This group is closely related to gulls. Once a specimen has been identified as a skua or jaeger the key will suffice in identifying it to species. Without doubt, though, one's initial inclination will be to almost always consider a specimen from this group to be a gull in immature plumage. Owing to the brown coloration and general shape such a choice is not surprising. Closer inspection will reveal long sickle-shaped and sharp claws (Plate 35-1), reticulate rather than scutellate scales on the legs (Fig. 13), white shafts and bases to the otherwise dark outer primaries, and a saddle-shaped plate on the upper bill (Plate 25). None of these characters are possessed by gulls. The jet black or black and blue feet and legs, in conjunction with the mostly dark plumage, is a combination that should arouse one's suspicions that the specimen is not a gull. Since most specimens found on beaches are immatures or are molting, do not rely on length of the central two tail feathers, a feature often discussed in field guides, to confirm species identification. None of these species are very abundant. Any specimens south of Alaska should be saved.

SKUAS cf. SOUTH POLAR SKUA (*Catharacta maccormicki*; choice 1, pg. 50) occurs throughout our area in the summer and fall but is virtually absent at other times. All specimens should be saved.

POMARINE JAEGER (*Stercorarius pomarinus*; choice 2, pg. 50), because of its large size, might be initially confused with the skua. This species, though, is actually much smaller. They breed in Alaska and winter in tropical waters. Occurrence in the Bering Sea and in eastern North Pacific coastal waters is restricted to migratory periods, mainly the fall and less so in spring.

PARASITIC JAEGER (*Stercorarius parasiticus*; choice 3, pg. 50) and LONG-TAILED JAEGER (*Stercorarius longicaudus*; choice 3', pg. 50) are not separable on the basis of overall size, a character that will distinguish them from the previous two species. Consult the key and also Willett and Howard (1934) for identification. Occurrence is the same as for the Pomarine Jaeger. The Long-tailed Jaeger is probably more common (relative to other jaegers) in North American coastal waters than presently suspected.

GULLS (LARIDAE, subfamily LARINAE)

Gulls are a well-known group of birds. Within their group, however, they can be very difficult to tell apart. Most species have two or three immature plumages which compounds the problem. These immature plumages are sometimes very similar between species; often individual specimens can only be identified by consulting experts, and some specimens even then remain unidentified. Nonetheless, much useful information can be obtained by the identification of the various species and age classes. Wings of badly decomposed specimens or specimens lacking heads can usually be identified by experts and are often worth saving. The only complete reference describing the plumages of gulls is Dwight's 1925 technical monograph of the group.

GLAUCOUS GULL (*Larus hyperboreus*; choices 61-63, pg. 61) is a very large, white-primaried gull common only in Alaska. Small numbers can be found as far south as the California-Mexico border in winter. Most birds south of Canada are immatures. Caution must be exercised in dealing with individuals of other species that are albinistic or have very worn feathers. Glaucous Gulls are rarely pure white. Some individuals may appear pure white but most immatures will show buffy marbling at the base of the central tail feathers and adults show a pale gray mantle.

GLAUCOUS-WINGED GULL (*Larus glaucescens*; choices 26, 41, 43 and 44, pp. 55, 57, 58) is a large pale gull found commonly from Alaska to southern California. This species characteristically has wing tips that are the same color as the inner primaries and secondaries. Extensive hybridization with the Western Gull in Oregon and Washington provides numerous individuals whose specific identity is difficult or impossible to determine. Most hybrids show darker outer primaries than typical Glaucous-winged Gulls and have paler gray mantles than Western Gulls. These individuals may be confused most readily with Herring and Thayer's Gulls, although these species have smaller, more slender bills than the hybrids. Also, Herring Gulls and most Thayer's Gulls have a distinct demarcation between the dark wing tips and the mantle while the Glaucous-winged X Western hybrids (as well as the northern race of the Western Gull) show the black of the wing-tips merging gradually with the gray or brown of the mantle area. Only familiarity with the variation in these gulls will allow identification of many specimens. For more information on these hybrids see Hoffman et al. (1978).

SLATY-BACKED GULL (*Larus schistisagus*; choices 28 and 48', pp. 55 and 58) is a large dark-backed gull that occurs along the coast of the western Pacific. This species is a straggler in western Alaskan waters and accidental at best elsewhere along the North American coast. Any beached birds thought to be this species should be saved for comparison with existing specimens and for deposit in museum collections. Adults are similar to the Western Gull but are larger with a darker mantle and more white in the wing tips. First year birds are paler than other large dark-backed gulls, have a distinctive drab wing bar at the base of the secondaries, and a white chin.

WESTERN GULL (*Larus occidentalis*; choices 29', 48, 52 and 56, pp. 56, 58, 59 and 60) is another large dark-backed gull more or less resident from Washington to the tip of Baja California. Specimens north of southern British Columbia should be saved. The dark mantle and large bill should separate this species from all but the preceding species. First year birds are much darker than other large gulls in the same plumage. Hybridization with the Glaucous-winged Gull in Oregon and Washington causes considerable identification problems which are discussed in the Glaucous-winged Gull account. This species occurs rarely in the Gulf of California where separation from adult Yellow-footed Western Gulls requires fresh specimens in which the leg color has not faded. Immature specimens can be impossible to separate from the Yellow-footed Western Gull. Any suspected Western Gulls from Gulf of California beaches should be saved. Specimens of the paler northern populations of the Western Gull (north of northern California) can be confused with Herring Gulls but the black of the wing tip merges gradually with the gray of the mantle in the Western Gull and is sharply demarcated in the Herring Gull. Usually the large thick bill will identify the Western Gull.

YELLOW-FOOTED WESTERN GULL (*Larus occidentalis livens*; choices 29, 49' and 55, pp.56, 59 & 60) is a large gull essentially confined to the Gulf of California. It is similar to the Western Gull except for the bright yellow legs and feet of the adult, and in the sequence of immature plumages. This form may be a separate species. Any specimens found outside the Gulf of California should be deposited in a museum.

LESSER BLACK-BACKED GULL (*Larus fuscus*; not in key) has been recorded only once on the west coast south of Alaska. Any specimen of this gull should be saved. It is the only gull occurring in this region with a *black* mantle. Its immature plumages and measurements are similar to the Herring Gull and separation is difficult. The adult with yellow legs might be confused with the Yellow-footed Western Gull but the Lesser Black-backed Gull is smaller with a more slender bill and a darker mantle.

HERRING GULL (*Larus argentatus*; choices 33', 50', 54 and 58, pp.56, 59, 60) may be found in coastal waters throughout the area treated by this manual. It is often considered to be the typical "sea gull". The characters in the key should identify most individuals. Herring Gulls are most likely to be confused with Thayer's Gull or Western X Glaucous-winged hybrids. Thayer's Gulls generally have more slender bills (Plate 26b, 1, 2) and the underside of the outer primaries are pale, while the Herring Gull has dark underwing tips. See the Glaucous-winged Gull account for hints concerning the Western X Glaucous-winged intergrades.

THAYER'S GULL (*Larus thayeri*; choices 33, 41', 43', 44', 49, 54' and 58', pp.56-60) occurs along the Pacific coast in winter, from southern British Columbia to southern California and less commonly in Alaska and Baja California. It is a medium-sized gull closely related to the Herring Gull. The combination of dark wing tips above and pale wing tips below is common to most individuals of all plumages. Only some of the much larger Western X Glaucous-winged intergrades share this characteristic. Adults can be further separated from the Herring Gull by the brownish eye and slender bill and from the California Gull by the pink legs. Immatures are more difficult but with practice can be identified by the characters used in the key.

CALIFORNIA GULL (*Larus californicus*; choices 32, 50, 53 and 57, pp. 56, 59, 60), a medium-sized gull, is common along the coast from southern Washington to Baja California. It is rare in British Columbia, and coastal Alaskan specimens should probably be saved. This species is quite similar to the Herring Gull but the gray of the mantle is distinctly darker, the legs of 3rd year and adult birds are gray to greenish-yellow and the eye is dark brown. First year birds are difficult to separate from the Herring Gull but typically the sharp demarcation between the pink base and black tip of the bill is distinctive.

RING-BILLED GULL (*Larus delawarensis*; choices 31, 37 and 37', pp. 56-57) a small to medium-sized gull, is found commonly in winter from Oregon to Baja California and rarely north to southern British Columbia. Specimens north of the latter area should be saved. The very pale gray mantle and ringed bill should identify all adult specimens. Immatures could be confused with immature Mew or California Gulls but characteristics in the key should clinch identification.

MEW GULL (*Larus canus*; choices 30, 38 and 38', pp. 56-57) is a small gull easily identified in adult plumage by the short, unmarked yellow bill. Immatures can be confused with immature Ring-billed Gulls but the small bill and the characteristics in the key should identify most specimens. The Mew Gull is a common winter visitor from Alaska to southern California and a common breeder throughout much of Alaska.

BLACK-HEADED GULL (*Larus ridibundus*; choices 17 and 17', pg. 54) is accidental in western North America and any specimens should be saved. The extensive amount of white in the wings, and the small size of the bill and wing should separate this species from all other gulls.

LAUGHING GULL (*Larus atricilla*; choices 16-16', pg. 53) is the largest of the black-headed gulls. It breeds rarely in the Gulf of California and is accidental north to Oregon. Specimens outside the Gulf of California are worth saving.

FRANKLIN'S GULL (*Larus pipixcan*; choices 11' and 22, pp. 52 and 54) is another small, black-headed gull occurring in this region. This species is rare along the coast from Washington south. Specimens could occur in nearly any month although northern regions would tend to accumulate winter records and southern regions summer records. The characteristics in the key should serve to identify this gull.

BONAPARTE'S GULL (*Larus philadelphia*; choices 13' and 14', pp. 52-53), a small gull that nests in the western and central regions of Alaska and winters along the coast from central Washington through Baja California. The extensive white in the primaries is a character shared only by Black-headed and Little Gulls, both of which can be separated from the Bonaparte's by size characters alone.

LITTLE GULL (*Larus minutus*; choices 20 and 20', pg. 54) is a small gull, accidental along the Pacific coast of North America. Only a few records exist so any beached specimen is worth saving. Its small size will eliminate confusion with any other gulls, but its size might initially lead one to think it is a tern.

HEERMANN'S GULL (*Larus heermanni*; choices 59-60', pg. 60) breeds on Baja California islands, particularly those in the Gulf of California. In the summer and fall they migrate north along the Pacific coast at least as far as southern British Columbia. This species is normally absent north of northern California in the winter and spring months. Specimens found north of southern British Columbia should be saved. First year specimens share plumage characteristics with the Flesh-footed Shearwater but lack the overall shape and the "tube nostrils" of the shearwater. The orange bill of the 2nd year bird and red bill of the adult distinguish this species from other gulls.

IVORY GULL (*Pagophila eburnea*; choices 2 and 23, pp. 51 and 55) occurs regularly in our area only along the north coast of Alaska in summer. It is accidental elsewhere in Alaska. Any specimens of this gull away from the Arctic coast of Alaska should be saved. Ivory Gulls should be identified easily using the characters in the key.

BLACK-LEGGED KITTIWAKE (*Rissa tridactyla*; choices 19 and 19', pg. 54) is a small gull common along the Pacific coast from Alaska to Baja California. It occurs rarely in the Gulf of California. Numbers south of Alaska vary tremendously from year to year. The small hind toe and short tarsus will separate a kittiwake from other gulls and the longer bill (Plate 27-4) and paler gray mantle will separate this species from the Red-legged Kittiwake. Ring-billed Gulls in their 2nd year plumage have all black wing tips and are sometimes confused with Kittiwakes but their longer tarsus should prevent confusion.

RED-LEGGED KITTIWAKE (*Rissa brevirostris*; choices 18 and 18', pg. 54) is common only near the Pribilof Islands, in the Bering Sea, and among some of the Aleutian Islands, where they breed. They occur in the waters near those islands in the winter. Specimens away from these areas should definitely be salvaged. This species can be told from the Black-legged Kittiwake by the darker gray of the mantle, the dark wing linings of the adult, and by the shorter bill (Plate 27-3).

ROSS' GULL (*Rhodostethia rosea*; choices 10 and 14, pp. 52-53) occurs regularly along the north coast of Alaska in the fall and rarely at other seasons. It is very rare in the Bering Sea. Any beached specimens of this species anywhere are probably worth saving. The wedge-shaped tail is unique among gulls.

SABINE'S GULL (*Xema sabini*; choices 21 and 21', pg. 54) breeds along the Arctic and Bering Sea coasts of Alaska and migrates to the Southern Hemisphere so could be conceivably found on any beach in our region. Most Sabine's Gulls migrate far out to sea so beached specimens are rare. The bold triangular wing pattern is distinctive in all plumages.

TERNS (LARIDAE, subfamily STERNINAE)

Although in the gull family, terns really bear little resemblance to gulls except that some have a color pattern, i.e., "gull gray" above and white below, similar to some of the larger gulls. The combination of a slender, sharply pointed bill (no hook; Plates 29-30), short legs, a long tail that is usually forked, and, especially, long, narrow and pointed wings is characteristic of species in this group. The petrels also have long, narrow wings. Whereas the latter achieve greater wing length by a relative extension of proportions from shoulder to wrist, terns do so by having very long primary feathers. Thus, the wrist outward is the major portion of a tern's wing. We can really not add much more to what has been presented in the keys in the way of additional identification characteristics. One should be aware, however, that it is perhaps more likely to find a dead pigeon (ROCK DOVE) on the beach than it is to find a tern in many areas along the Pacific coast, and should only the wings of a pigeon be found, it will probably "key" to terns in the Key to Keys. A pigeon's wings are much broader than a tern's.

Most terns are tropical or subtropical in distribution. In general, they occur either in estuarine or very protected waters, or they occur far at sea. As a result, they are infrequently encountered as beached specimens.

GULL-BILLED TERN (*Gelochelidon nilotica*; choices 13 and 13', pg. 63) If a specimen still has its head and one has decided it is a tern, then the heavily proportioned bill (Plate 30) (somewhat like that of a Bonaparte's Gull) should confirm its identity. It is very unlikely that this species will be encountered in the area covered by this manual. Gull-billed Terns occur inland in southern California (Salton Sea) and from there south along the Sonora, Mexico coast (to Ecuador). Thus, if they are to be found anywhere along the Pacific coast, it would be most possible in the Baja California segment. Any specimen found should be saved for verification.

FORSTER'S TERN (*Sterna forsteri*; choices 18 and 18', pg. 64), COMMON TERN (*S. hirundo*; choices 22 and 22', pg. 64) and ARCTIC TERN (*S. paradisaea*; choices 23 and 23', pg. 65). These species are quite similar in size and in other characteristics. Characters mentioned in the key should usually suffice in distinguishing them but some others may at times help. Although outer tail feathers are subject to a great deal of wear, in the outer tail feathers of the Forster's Tern the inner and outer vanes should be gray and white, respectively. In the other two species the outer web should be gray. The bill of an Arctic Tern is usually entirely a deep, blood red (sometimes dark at tip); in the other two it has a good deal of black at the tip and the red, if present (in summer quite extensively so), is more orange.

Forster's and Common Terns occur in coastal waters from Washington southward from late summer to early spring. Their greatest abundance in Pacific coastal waters occurs during spring and fall migrations. From Washington to northern California their occurrence is especially infrequent.

Arctic Terns, from Washington southwards, are present only during migration periods, late July to early October and May. North of Washington and especially from the Aleutian Islands north, they are present during the summer as well.

ALEUTIAN TERN (*Sterna aleutica*; choices 20 and 20', pg. 64). Since this species occurs rather locally on coastal islands of the Bering Sea and off the Alaska Peninsula, one would have to distinguish it only from Arctic Terns. Besides the characters in the key, the Aleutian Tern's white forehead, black bill and gray back coloration, that is much darker than in the other species, should help in identification.

Aleutian Terns nest on islands from Norton Sound (Bering Sea) south as far as Kodiak Island and in the eastern Aleutians. They migrate to Asia during non-breeding periods.

SOOTY TERN (*Sterna fuscata*; choices 5 and 5', pg. 62). This species' very large size and the black coloration of upper parts set it apart from most other seabirds except perhaps the Black Skimmer; the white in the secondary feathers and large size of the secondaries would be sufficient to identify specimens without heads. A juvenile Sooty Tern is much different from the adult. It is dark brown all over with buffy feather tips, its wings are not as long and pointed and its tail is only slightly forked compared to the adult.

Sooty Terns could occasionally be encountered near the southernmost coasts of Baja California. Any specimen found should be saved for verification.

LEAST TERN (*Sterna albifrons*; choices 16 and 16', pg. 64). Its very small size sets this species apart from other terns. If one found only a wing, without consideration of color, one might consider it to belong to a medium-sized shorebird.

This species occurs from the spring to fall from San Francisco Bay southwards.

ROYAL TERN (*Sterna maxima*; choices 11 and 11', pg. 63) and ELEGANT TERN (*S. elegans*; choices 14 and 14', pg. 63). No difficulty should be encountered in distinguishing these from one another or from other tern species. Both occur year round south of northern Baja California. During the fall and winter the Elegant Tern occurs as far north as Humboldt Bay. Royal Tern specimens found north of Point Conception should be saved for verification.

CASPIAN TERN (*Sterna caspia*; choices 9 and 9', pg. 63). Like the latter two, this species is quite distinctive from other terns, particularly because of its size. If one picked up a Red-billed Tropicbird, until a closer look was made, the Caspian Tern would probably be the first name to come to mind. They both are very light in coloration, are of similar size, and have large heavily proportioned red bills; compare Plates 4 and 29. It is, of course, far more likely to find a Caspian Tern in North American coastal waters than it is a tropicbird.

This species can be found year round in coastal waters from southern California southward, but more so during fall and winter. It occurs rather rarely along the Pacific coasts of Oregon and Washington during spring and fall migrations.

BLACK TERN (*Chlidonias nigra*; choices 3 and 3', pg. 62). An adult of this species is superficially similar to a juvenile Sooty Tern, but the larger size and buffy feather margins of the latter would readily separate the two species.

Black Terns wander a good deal and thus one might conceivably encounter one in coastal waters as far north as Washington. Finding one is much more likely from California southward. The species breeds inland and winters from Panama southward. Thus it would occur off here mainly during migration, and especially the fall.

SKIMMERS (RYNCHOPIDAE)

BLACK SKIMMER (*Rynchops niger*; choices 6 and 6', pg. 62). Except for its very distinctive bill (Plate 29), this bird is similar in morphology to terns. There should be no problem in distinguishing a specimen of this species.

Black Skimmers breed coastally in southern California on San Diego Bay. In the region covered by this manual, one is most likely to find them from southern California southward and very rarely as far north as central California. Any specimen found should be saved for verification.

ALCIDS or AUKS (ALCIDAE)

Auks are compact and, compared to their wing size, rather heavy-bodied birds. Their wings are surprisingly narrow, as in a petrel, but are rounded rather than pointed. Many auk species have a brightly colored bill, mouth lining and feet (colors include yellow, orange, bright red and blue). They can offer some of the most difficult problems in identification for two reasons. First, the young of larger species are superficially similar in size and shape to adults of smaller species. The young of most seabirds leave the nest or nesting island when "adult-sized" but the young of some alcids leave nesting islands when very small and in some cases when just a few days old. Many times young murrelets have been identified as murrelets. Second, most morphological variation among auks is confined to differences in size and in head characteristics. Thus in a headless specimen only size and some subtle color differences can offer clues to identification.

COMMON MURRE (*Uria aalge*; choices 6', 7, 23 and 24, pp. 66, 70-71) and THICK-BILLED MURRE (*U. lomvia*; choices 6, 7', 23 and 24, pp. 60, 70-71). If the specimen has a head, one should have little difficulty in separating these two species. If it has no head then the task is not as easy.

Both species breed abundantly from the Bering Straits to western Alaska, and the Common Murre from there to central California. During the non-breeding period, Common Murres occur from ice free Bering Sea waters to northern Baja California. Thick-billed Murres winter as far south as southeast Alaska and regularly but very rarely to central California. Any Thick-billed Murre specimen encountered south of southeast Alaska should be saved for verification. Young murres begin their sea-lives when only a quarter the size of adults.

BLACK GUILLEMOT (*Cepphus grylle*; choices 4 and 4', pg. 66) and PIGEON GUILLEMOT (*C. columba*; choices 10 and 10', pg. 69). Wing color is the major character by which these two species can be separated. Size measurements can also be useful, as the following table shows (from Storer, R. W., 1952) for specimens from the Bering Sea, where the two overlap in distribution (measurements in mm):

	<u>BLACK GUILLEMOT</u>	<u>PIGEON GUILLEMOT</u>
Wing	165-175	174-195
Tarsus	27-34	31-38
Culmen	27-35	31-37

The two species occur year round as far north as ice free waters exist. The Black Guillemot does not occur south of the Bering Sea but the Pigeon Guillemot occurs as far south as southern California. During the late fall and winter, Pigeon Guillemots are uncommon in coastal waters south of British Columbia.

MARbled MURRELET (*Brachyramphus marmoratus*; choices 30 and 30', pp.71-72), KITTLITZ'S MURRELET (*B. brevirostris*; choices 28 and 28', pg. 71), and ANCIENT MURRELET (*Synthliboramphus antiquum* choices 20 and 20', pg. 70). One should have no difficulty in distinguishing these species from one another, or from other murrelets, unless only part of a specimen is available. The following table (based on Sealy, 1972; Jehl and Bond, 1976; Bedard, 1969; and Ridgeway, 1919) may be useful (measurements in mm):

	<u>MURRELETS</u>				
	<u>Marbled</u>	<u>Kittlitz's</u> ^{1/}	<u>Ancient</u>	<u>Xantus'</u>	<u>Craveri's</u>
Wing	120-140	127-141	132-149	111-128	107-124
Tarsus	13.9-17.6	15.5-16.5	24.6-28.0	21.2-27.5	21.0-24.5
Exposed Culmen	13.2-17.6	9.5-10.5	12.2-15.1	15.6-21.4	18.0-22.5
Bill Depth	5.3-7.0	5.1	6.4-8.5	6.2-6.5	4.6-5.9

^{1/} Based on few specimens, range in measurements may be slightly greater; bill depth is an average.

Marbled Murrelets occur year round from southeast Alaska to central California and during fall and winter to southern California. Kittlitz's Murrelets occur year round, where ice free waters exist, from the Bering Strait to southeast Alaska (one extralimital record from San Diego). Ancient Murrelets occur year round from the southern Bering Sea to British Columbia, and during the winter to northern Baja California. Any specimens of Marbled Murrelet south of the Channel Islands, or of Kittlitz's Murrelet south of southeast Alaska, should be saved for verification.

XANTUS' MURRELET (*Endomychura hypoleuca*; choice 19', pg. 70) and CRAVERI'S MURRELET (*E. craveri*; choice 23', pg. 71). Of the five murrelets these two are the most plainly marked. They closely resemble the murrees, except in size; compare Figs. 25 and 26. Chicks accompany adults to sea when only a few days old and when feathered only in down. The above table of measurements may aid in identification, but be wary of the fact that only adults are included.

The Xantus' Murrelet may be found year round in Baja California and southern California waters. During early spring and late summer they occur as far north as Washington but in any abundance only as far north as central California. The occurrence of Craveri's Murrelet is quite similar to the Xantus' but the Craveri's Murrelet is less abundant along the Pacific coast than the other. Any specimen of Xantus' Murrelet north of central California and of Craveri's Murrelet north of Pt. Conception should certainly be saved for verification.

CASSIN'S AUKLET (*Ptychoramphus aleuticus*; choice 22, pg. 70). Little more can be added than what is in the keys to aid in distinguishing the five auklets. One should have little difficulty in doing so, unless the specimen is headless. The following table (based mostly on Ridgway, 1919) may at times be useful (measurements in mm), but consider the fact that first year auklets (measurements not in table) are slightly smaller than adults:

	AUKLETS				
	<u>Cassin's</u>	<u>Parakeet</u>	<u>Crested</u>	<u>Least</u>	<u>Whiskered</u>
Wing	109-129	140-156	125-145	88-98	103-118
Tarsus	23-25	26-31	24-30	16-20	19-24
Exposed					
Culmen	18-20	13-17	10-14	7-10	7-10

Cassin's Auklet is the most widely distributed of the five auklets. It occurs year round from islands off the Alaska Peninsula south to central Baja California. Any specimens from the Bering Sea should be saved for verification.

PARAKEET AUKLET (*Cyclorhynchus psittacula*; choices 33 and 33', pg. 72), CRESTED AUKLET (*Aethia cristatella*; choices 32 and 32', pg. 72) LEAST AUKLET (*A. pusilla*; choices 18 and 18', pg. 70) and WHISKERED AUKLET (*A. pygmaea*; choices 26 and 26', pg. 71). See comments regarding identification under Cassin's Auklet. These four species are largely restricted to ice free areas of the Bering Sea, waters around the Aleutians and eastward almost to Kodiak, Alaska. Parakeet Auklets on rare occasions have occurred as far south as central California. Specimens of any of these species encountered south of southeast Alaska, or even Kodiak, should be saved for verification.

RHINOCEROS AUKLET (*Cerorhinca monocerata*; choices 14 and 14', pg. 69) This species is most similar to the first year Tufted Puffin, but characters in the key, the darker belly and deeper bill of the latter should distinguish them (Plates 31-1, 32). See table under Horned Puffin.

Rhinoceros Auklets occur year round from southeast Alaska to central California, and during winter to southern California.

HORNED PUFFIN (*Fratercula corniculata*; choices 15 and 15', pg. 69) This species cannot be easily confused with the Rhinoceros Auklet or the Tufted Puffin, the species to which it is most similar. The following table (from Ridgway, 1919) may be of use (measurements in mm):

	<u>Rhinoceros</u> <u>Auklet</u>	<u>Horned</u> <u>Puffin</u>	<u>Tufted</u> <u>Puffin</u>
Wing	169-190	182-222	189-236
Tarsus	25-30	25-38	29-36
Exposed Culmen	32-39	45-56	53-65

Horned Puffins occur year round, in ice free waters, from the Bering Strait south to British Columbia. They occur infrequently as far south as southern California, but regularly to central California, during the period from late winter to early summer.

TUFTED PUFFIN (*Lunda cirrhata*; choices 12 and 12', pg. 69). For comments on identification see the above two species. Tufted Puffins occur year round, in ice free waters, from the Bering Strait south to central California; south of British Columbia they are rather uncommon. On rare occasions they occur in southern California waters although not long ago they bred in very low numbers on the northern Channel Islands.

BOOKS AND ARTICLES FOR ADDITIONAL INFORMATION ON AQUATIC BIRDS

- American Ornithologists' Union. 1957. Check-list of North American Birds, 5th Ed. A.O.U., Baltimore.
- Bedard, J. 1969. Adaptive radiation in Alcidae. *Ibis* 111:189-198.
- Bellrose, F.C. 1976. Ducks, Geese and Swans of North America. 2nd Ed. Wildl. Manage. Inst., Stackpole Books, Harrisburg. 544 pp.
- Binford, L.C., and J.V. Remsen. 1974. Identification of the Yellow-billed Loon. *Western Birds* 5:111-126.
- Carney, S.M. 1964. Preliminary Keys to Waterfowl Age and Sex Identification by Means of Wing Plumage. Dept. Interior, Special Scientific Rept. - Wildl. 82.
- Cogswell, H.L. 1977. Water Birds of California. Calif. Nat. Hist. Guides, No. 40. Univ. California Press, Berkeley.
- Coues, E. 1903. Key to North American Birds. 5th Ed. Estes and Lauriat, Boston. 1151 pp.
- Devillers, P. 1972. The juvenal plumage of Kittlitz's Murrelet. *Calif. Birds* 3:33-38.
- Devillers, P. 1977. The skuas of the North American Pacific coast. *Auk* 94:417-429.
- Dwight, J. 1925. The gulls (Laridae) of the world; their plumages, moults, variations, relationships and distribution. *Amer. Mus. Nat. Hist., Bull.* 52 (3):63-401.
- Flahaut, M.R. 1946. Identification of Red-billed Tropicbird taken in Washington state. *Murrelet* 28:22.
- Godfrey, W.E. 1966. The Birds of Canada. *Natl. Mus. Canada, Bull.* 203. 428 pp.
- Harper, P.C., and F.C. Kinsky. 1978. Southern Albatrosses and Petrels: An Identification Guide. Victoria Univ. Press, Wellington. 116 pp.
- Hoffman, W., J.A. Wiens, and J.M. Scott. 1978. Hybridization between gulls (*Larus glaucescens* and *L. occidentalis*) in the Pacific northwest. *Auk* 95:441-458.
- Jehl, J.R., Jr., and S.I. Bond. 1976. Morphological variation and species limits in murrelets of the genus *Endomychura*. *San Diego Soc. Nat. Hist., Trans.* 18(2):9-24.

- King, W.B. 1967. Seabirds of the Tropical Pacific. Prelim. Smithsonian Identification Manual. Smithsonian Inst., Washington, D.C. 126 pp.
- Koslova, E.V. 1957. Charadriiformes, suborder Alcae, *in* Fauna of the U.S.S.R., Vol. II (No. 3). Israel Prog. for Scientific Transl., Jerusalem (1961), Natl. Tech. Inf. Service, Washington, D.C.
- Kuroda, N., 1954. On the Classification and Phylogeny of the Order Tubinares, Particularly the Shearwaters (*Puffinus*). Herald Co., Tokyo. 179 pp.
- Loomis, L.M. 1918. A review of the albatrosses, petrels, and diving petrels. Calif. Acad. Sci., Proc. II, pt. 11, No. 12:1-187.
- Murphy, R.C. 1952. The Manx Shearwater, *Puffinus puffinus*, as a species of world-wide distribution. Amer. Mus. Novitates No. 1586, 21 pp.
- Palmer, R.D. (ed.). Handbook of North American Birds, Vol. I (1962), Loons-Flamingoes; Vol. 2 and 3 (1976), Waterfowl. Yale Univ. Press, New Haven.
- Pitelka, F.A. 1950. Geographic variation and the species problem in the shore-bird genus *Limnodromus*. Univ. Calif. Publ. Zool. 50:1-108.
- Prater, A.J., J.H. Marchant and J. Vuorinen. 1977. Guide to the Identification and Aging of Holarctic Waders. British Trust for Ornithology Guide 17. Tring.
- Ridgway, R. 1919. Birds of North and Middle America, Vol. VIII. U.S. Natl. Mus., Bull. 50. 852 pp.
- Robbins, C.S., B. Bruun, and H.S. Zim. 1966. Birds of North America, A Guide to Field Identification. Golden Press, N.Y. 340 pp.
- Sealy, S.G. 1972. Adaptive Differences in Breeding Biology in the Marine Bird Family Alcidae. PhD Dissertation, Univ. Michigan, Ann Arbor.
- Storer, R.W. 1952. A comparison of variation, behavior and evolution in the sea bird genera *Uria* and *Cephus*. Univ. Calif. Publ. Zool. 52:121-222.
- Taverner, P.A. 1928. Birds of Western Canada. Natl. Mus. Canada, Bull. 41. 379 pp.
- Willett, G. and H. Howard. 1934. Characters differentiating certain species of *Stercorarius*. Condor 36:158-160.

MARINE MAMMALS

Presented here are keys to marine mammals of the North American west coast. These are preceded by a glossary and are followed by species accounts that refer to geographical and seasonal occurrence. Invaluable aids to us were the information and keys in Scheffer (1958) and Tomilin (1957); we hereby acknowledge the work of those authors. The bibliography, after the species accounts, contains complete citations of these books. Following the bibliography is a list of agencies interested in reports of marine mammals found dead on beaches.

Marine mammal carcasses are often difficult to distinguish, especially if they are not very fresh. Compared to marine birds, they are rather limited in their variety of sizes, shapes and colors and thus differences among them are less distinct. Therefore, the mammal species accounts offer few additional identifying morphological characteristics. Also, in several instances the mammal keys lead only to a group of similar species because further identification is exceedingly difficult. One should at least attempt to identify a carcass to a major group; for example, it is usually relatively easy to distinguish between a fur seal, seal and sea lion. Beyond that, identification becomes increasingly difficult; for instance, in dolphins and even seals you will likely have to consider the shape, placement and number of teeth in each side of the upper and lower jaws. Some species within certain groups of seals and dolphins cannot be readily distinguished unless the skull is examined. Key out mammals as far as you can. If you wish to know more, then refer to other publications listed further on and contact one of the agencies listed at the end of this section. Make it clear that if they inspect or collect the carcass (and often someone will) you would like to know more about it. Whatever you do, leave the carcass on the beach; it is against the law to remove it without a permit.

MEASUREMENTS AND GLOSSARY OF MARINE MAMMAL TERMS

- Baculum - a slender bone within the penis of some mammals. It lies well beneath the skin, between the penile opening and the anus, and can be used in the identification of sea otters, seals, sea lions, and walrus (Plate 38a and b).
- Baleen - the horny fringed plates hanging from the roof of the mouth of some cetaceans (Fig. 27).
- Beak - the forward portion of the head of some cetaceans in front of the forehead. It is constricted relative to the forehead (Fig. 28; see snout and rostrum).
- Blowhole slit - the external opening of the breathing apparatus when the opening is closed (Figs. 27,28).
- Canine - (canine tooth) the large teeth just behind the incisors. There is one such tooth in each side of upper and lower jaws (Fig. 29).
- Cetacean - a member of the order Cetacea: a whale, dolphin, or porpoise.
- Cusps - the bumps or projections on the biting surface of teeth (see "molar" in Fig. 29).
- Dorsal - the upper surface (Fig. 28).
- Flukes - the horizontally broadened portion of a cetacean's tail (Fig. 28).
- Guard Hairs - longest, stiffest and most apparent hairs in a mammal's coat. This contrasts with the short, velvety fur beneath the guard hairs.
- Longitudinal - a line along the anterior-posterior axis; in marine mammals, along the length of the body.
- Palate - the roof of the mouth (Figs. 34, 36).
- Pelage - fur.
- Pinna - the external ear.
- Pinniped - a member of the order Pinnipedia: a seal, sea lion, or walrus; literally, "feather-foot".
- Plate - a single sheet of baleen (Fig. 27).
- Postcanine - one of those teeth posterior to the canines; the premolars and molars (Fig. 29).

Rostrum - forward extension of the skull.

Snout - nose; frequently synonymous with beak (Fig. 28).

Symphysis - a line of junction or articulation, for example, where the two premaxillary bones meet at the front of the upper jaw (Fig. 29).

Total length (or maximum length) - the straight line distance between the tip of the snout and the tip of the tail (pinnipeds) or the notch of the flukes (cetaceans).

Transverse - a line across the body, from one side to the other.

Umbilicus - the navel, or depression on the middle of the abdomen indicating the point of attachment of the umbilical cord (Figs.32, 37).

Ventral - the under surface (Fig. 28).

Figure 27. Some baleen whale terms used in the keys.

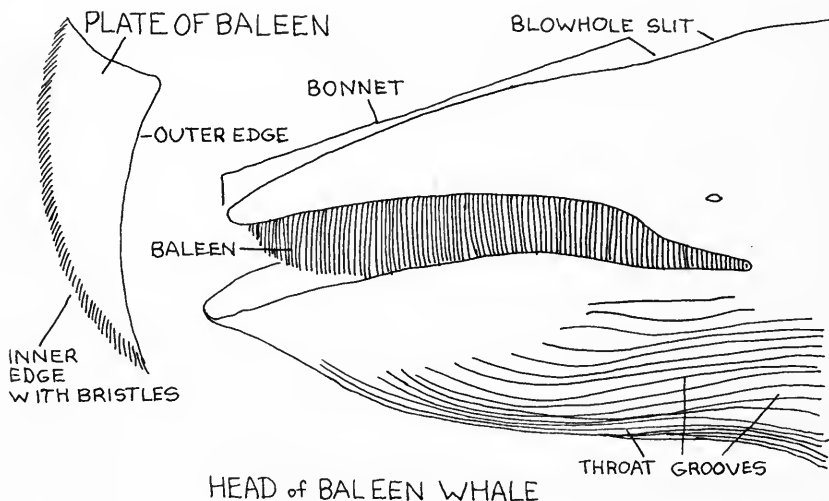

Figure 28. Some cetacean terms used in the key with a shark for comparison.

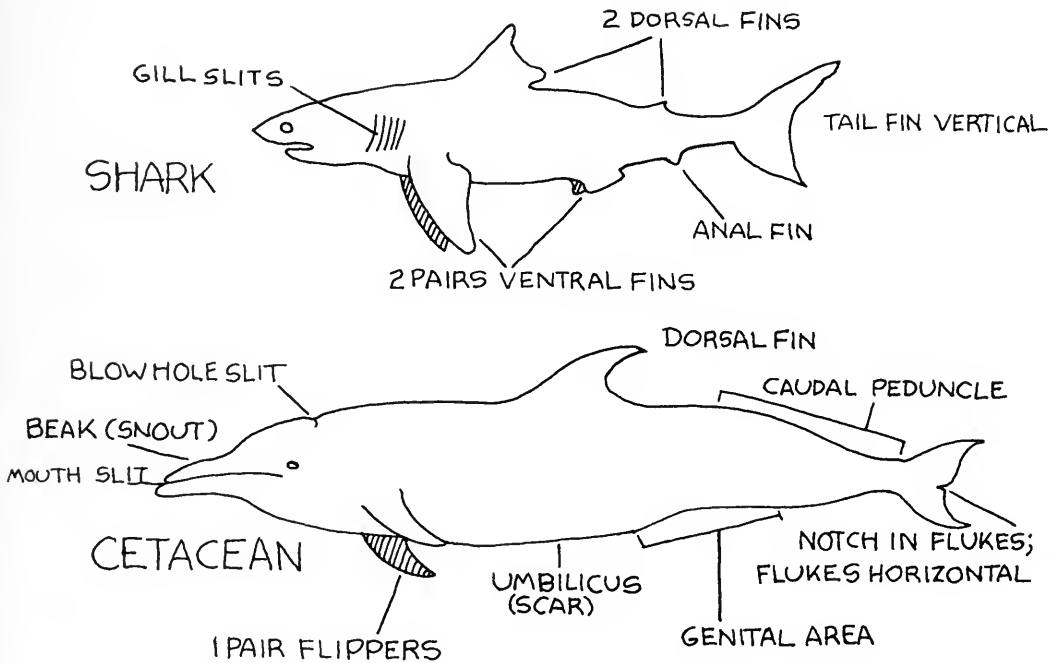
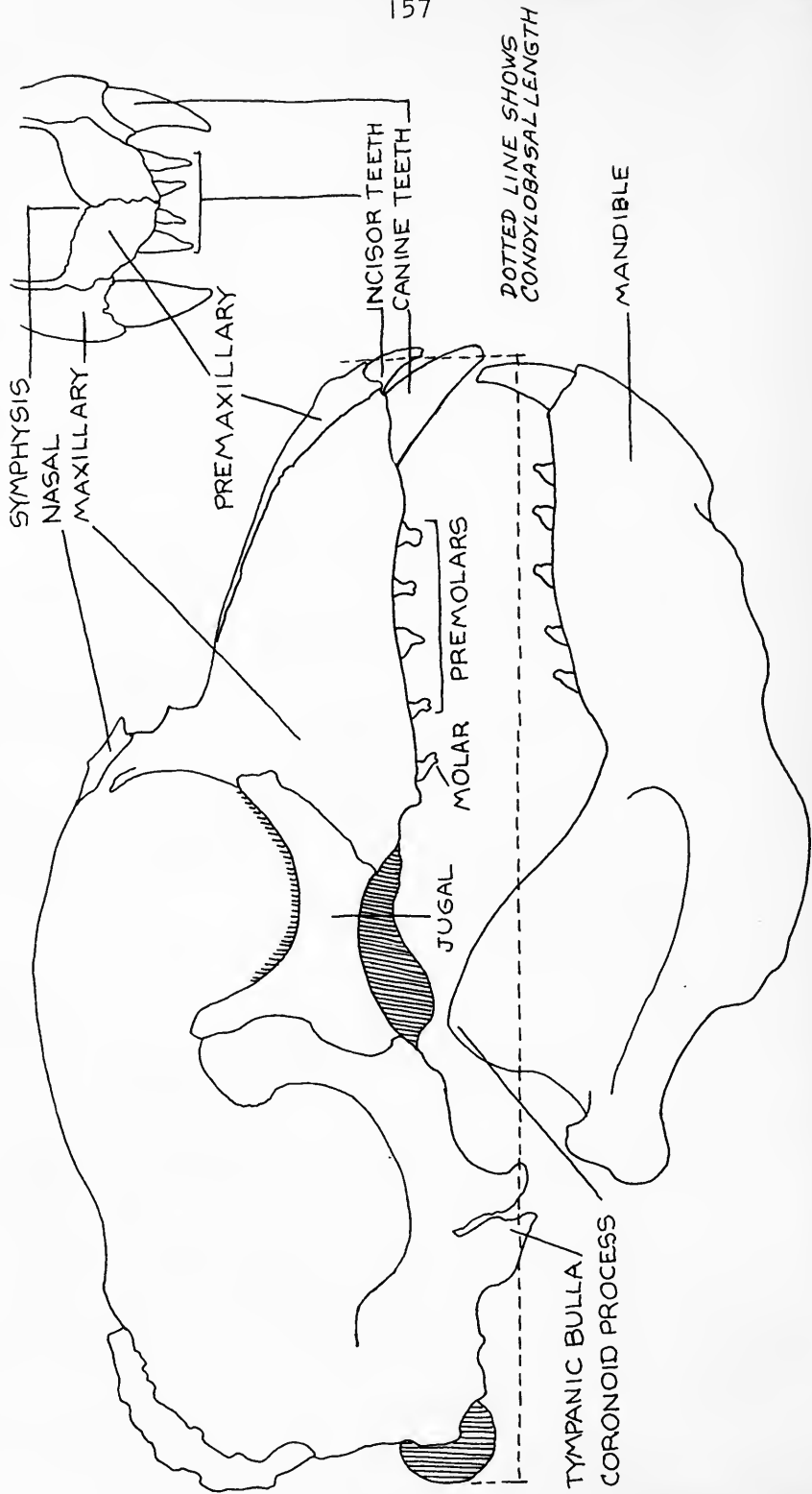
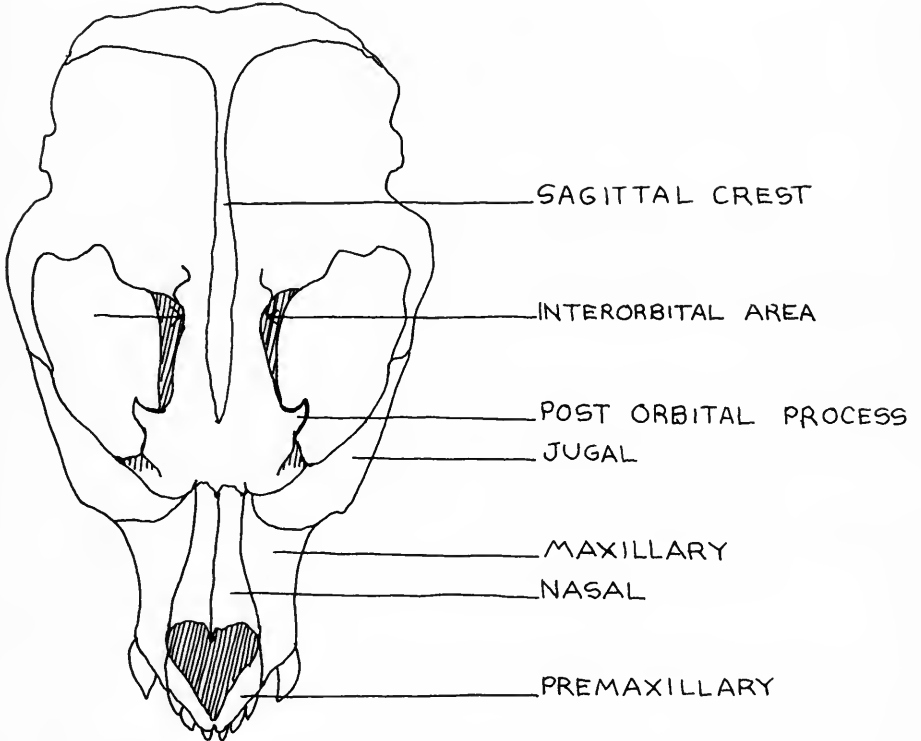

Figure 29. Some parts of a pinniped skull.



MALE NORTHERN ELEPHANT SEAL

Figure 30. Dorsal view of a pinniped skull.



MALE CALIFORNIA SEA LION

KEY TO MARINE MAMMALS

- 1 Two limbs, located in the front half of the body; posterior end of body modified into a single horizontal fluke (Figs. 28, 37); a fin sometimes present on back (Fig. 28); no fur (some specimens have single, widely spaced hairs or hair follicles on their snouts). 16
- 1' Four limbs, two forward and two aft; posterior limbs modified into two flippers (Fig. 31); never a dorsal fin; fur (hair) present (some specimens have extensive areas where fur may be lost secondarily giving the appearance of no fur). 2

Figure 31. Some morphological differences between eared seals (sea lions, fur seals) and earless seals ("true" seals).

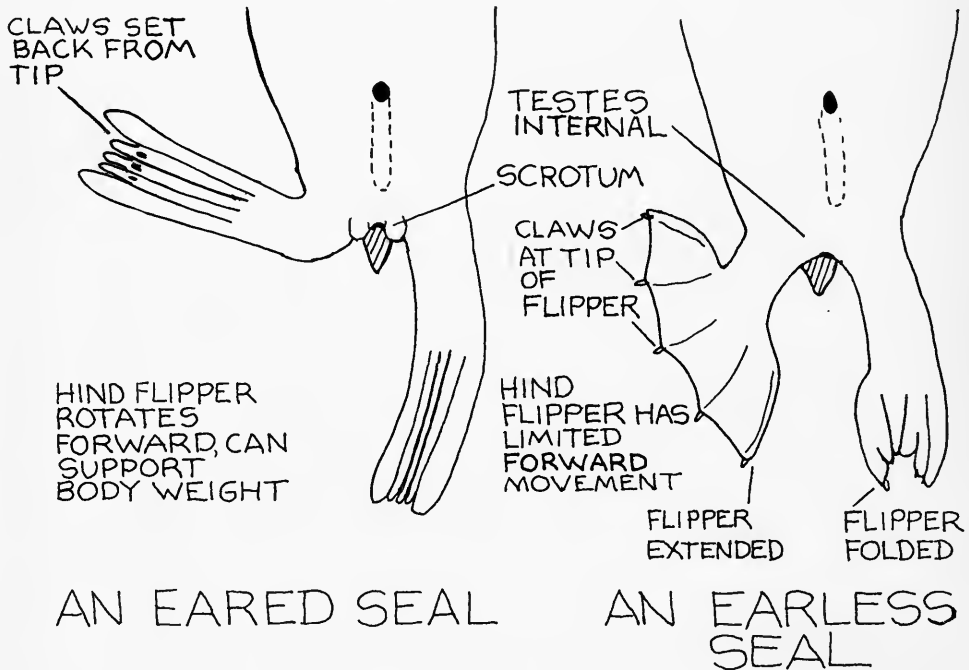

KEY TO MARINE MAMMALS (Cont.)

- 2 Foot-pads present (as on the bottom of a dog's foot); fore-feet not modified into flippers; tail extending beyond out-stretched hind foot; fur medium brown to grayish to blackish, sometimes whitish about muzzle (pups sometimes rufous); underfur (growth of dense velvety fur beneath the long guard hairs) present and obvious; guard hair sparse. (SEA OTTER) 15
- 2' No foot pads; all feet modified into flippers; tail extremely short or absent; fur gray, tan, brown, white, black, yellow, or combination of these; underfur absent except in fur seals.
PINNIPEDS (SEALS, SEA LIONS, AND WALRUSES) 3
- 3 External ears nearly absent or completely hidden in fur; whiskers beaded (bumpy when slipped through thumb and forefinger) except in Bearded Seal; claws set near ends of flippers or extending beyond them (Fig. 31); five claws on hind foot of most species, although sometimes rudimentary; both surfaces of flippers with fur, babies of most species with woolly fur. PHOCIDS (EARLESS SEALS) 10
- 3' External ears present, about 2-3 cm long; whiskers smooth (when slipped between thumb and forefinger); claws set far back from ends of flippers (Fig. 31); distinct claws on all three middle digits of hind feet, claws on outside toes rudimentary (Fig. 31); ventral surface of flippers without fur, dorsal surface without fur except in walrus and Guadalupe fur seal; babies have hair, not woolly fur.
ODOBENIDS (WALRUS) AND OTARIDS (EARED SEALS AND SEA LIONS) 4
- 4 Body form thick; fur scanty; no external tail; external ears without cartilage; tip of tongue rounded; testes internal; first and second upper incisors (present in young only) not grooved on biting edge; all postcanineteeth single-rooted and peg-like; canines frequently enlarged to form tusks. WALRUS
- 4' Body form elongated; fur abundant except in some rotted individuals; tail present, very short (7-14 cm); external ear with cartilage; tip of tongue notched; testes external; first and second upper incisors with transverse groove on biting edge except in extremely worn teeth; most postcanines with more than one root; no tusks. (OTARIDS) 5
- 5 Underfur not present; pelage consists of short, stiff hairs; fore-flippers with first digit (same position and analogous to human thumb) longer than second; outermost and innermost digits of hind flippers longer than middle three; short hind flippers, half or less than distance from base of hind flipper to armpit; usually five teeth behind long canines on upper jaw; nose not particularly pointed. (SEA LIONS) 6

KEY TO MARINE MAMMALS (Cont.)

- 5' Underfur present (guard hair hides underfur so that hair must be parted to reveal this thick growth of velvety fur); foreflippers with first digit shorter than second; all digits on hind flippers about equal in length; long hind flippers, about three-quarters the distance from base of hind flipper to armpit; usually six teeth behind canines on upper jaw; nose pointed. (FUR SEALS) 9
- 6 Male (Fig. 32) 7
- 6' Female (Fig. 32) 8

Figure 32. Some morphological differences between male and female pinnipeds.

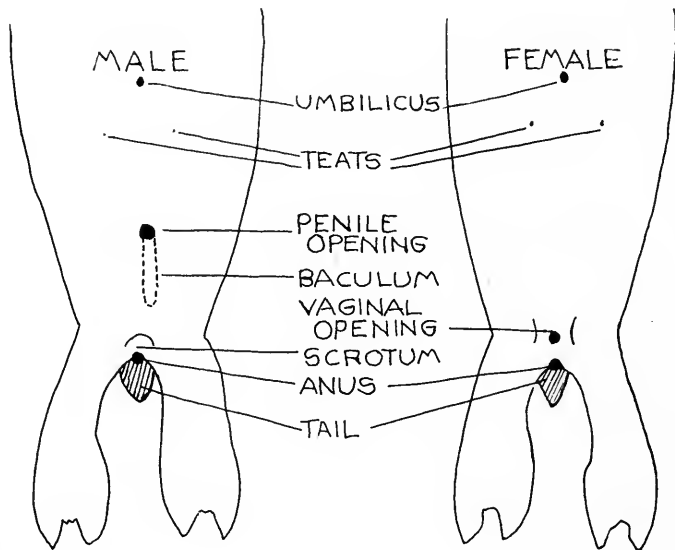
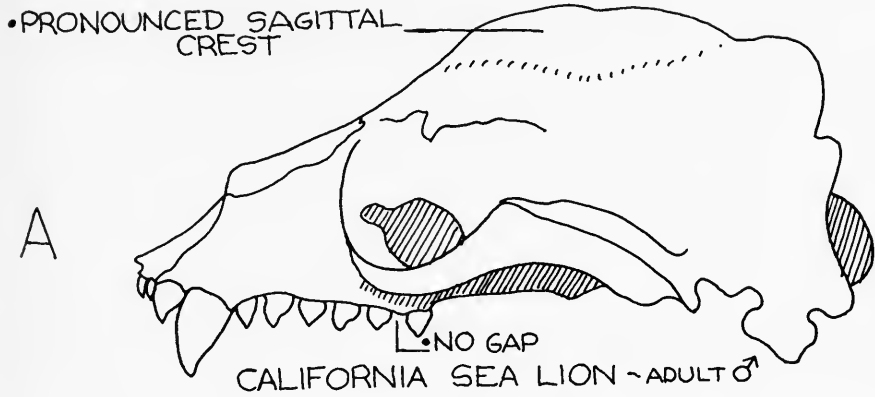

Figure 33. Sea lion skull comparisons.



• SKULL BROAD AND FLATTER - CREST LESS PRONOUNCED

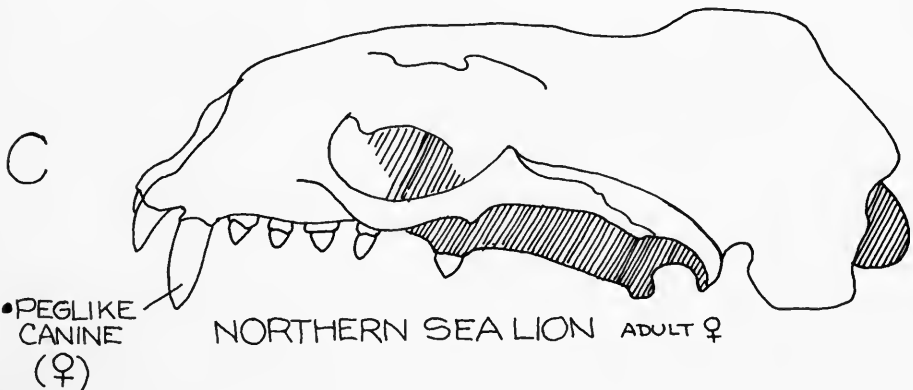
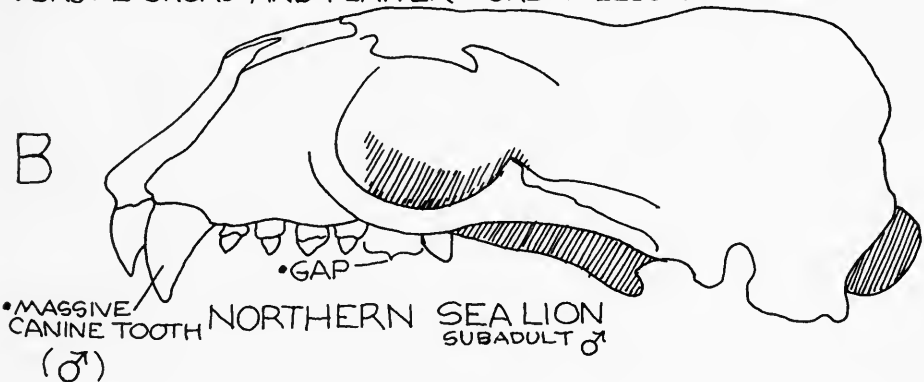
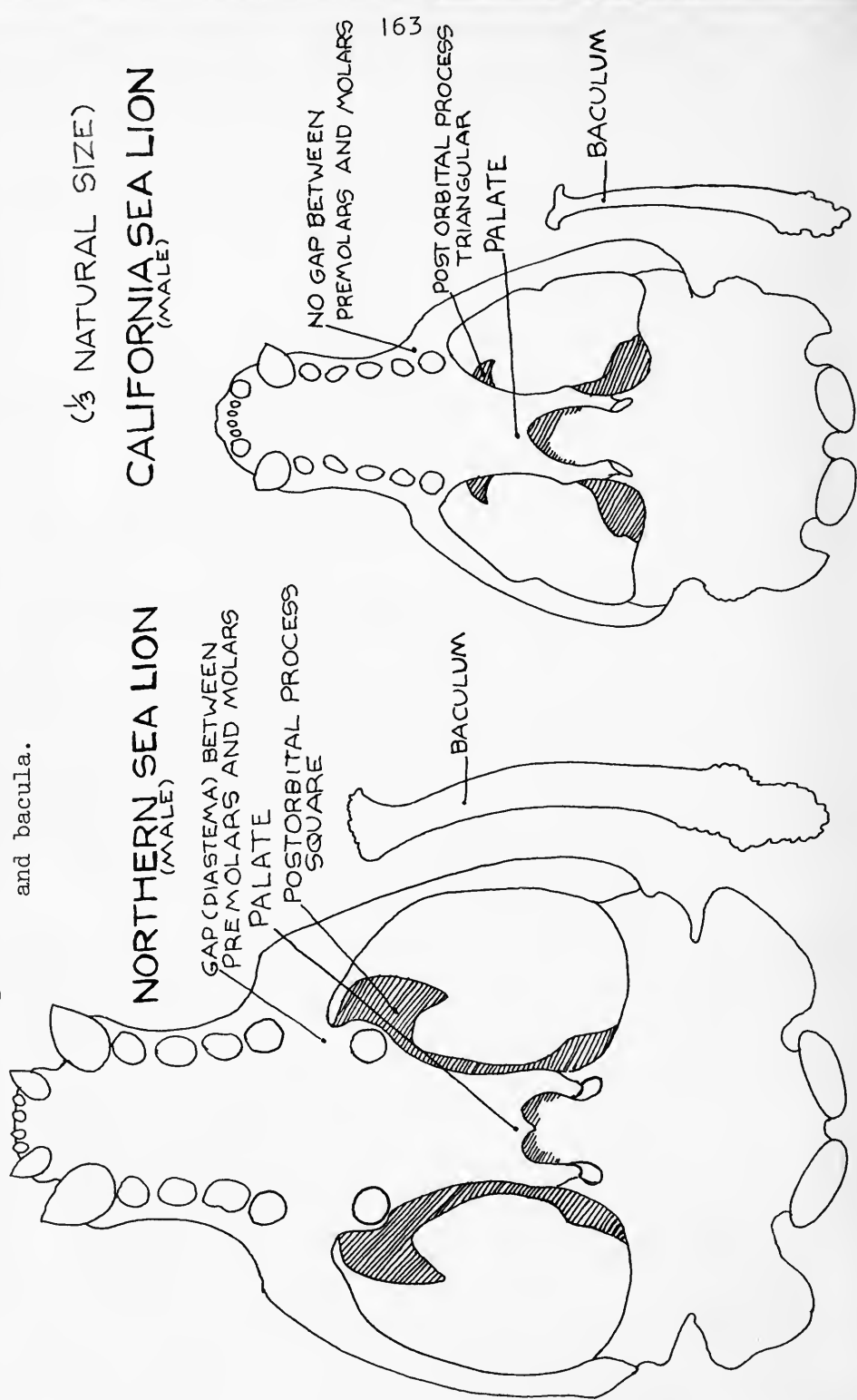

Figure 34. Differences between California and Northern sea lion skulls and bacula.



($\frac{1}{3}$ NATURAL SIZE)

CALIFORNIA SEA LION
(MALE)

NORTHERN SEA LION
(MALE)

GAP (DIASTEMA) BETWEEN
PREMOLARS AND MOLARS
PALATE

POSTORBITAL PROCESS
SQUARE

BACULUM

NO GAP BETWEEN
PREMOLARS AND MOLARS

POST ORBITAL PROCESS
TRIANGULAR
PALATE

BACULUM

KEY TO MARINE MAMMALS (Cont.)

- 7 A longitudinal ridge of bone (sagittal crest) on top of skull, very prominent in older animals, but in individuals less than 185 cm from tip of tail to snout (+ 5 years old) the crest is no more than 5 mm high and may not be felt through the muscle and fur (Figs. 30, 33); color dark brown to light tan; no gap between upper molar (last tooth) and premolars (Fig. 33); if skull is exposed, postorbital process triangular (Fig. 34); distal end of baculum has two knobs (Plate 38); baculum length to 137 mm; animal never more than 2.4 m total length.
CALIFORNIA SEA LION
- 7' No noticeable ridge of bone on top of skull (Fig. 33); adult color brown to yellowish, occasionally almost white; gap between upper molar (innermost tooth) and premolars as wide or much wider than a premolar (Fig. 33); in exposed skull, postorbital process square (Fig. 34) distal end of baculum flared into a more or less disc (Plate 38); baculum length to 192 mm; animal can be longer than 2.4 m total length.
NORTHERN SEA LION
- 8 No gap between upper molar (innermost tooth) and premolars (Fig. 33); color usually dark brown; in exposed skull, postorbital process triangular (Fig. 34); animal never more than 1.9 m total length.
CALIFORNIA SEA LION
- 8' Gap between upper molar (innermost tooth) and premolars as wide or much wider than a premolar (Fig. 33); color brown to yellowish; in exposed skull, postorbital process square (Fig. 34); animal can be longer than 1.9 m total length.
NORTHERN SEA LION
- 9 Muzzle narrow and pointed (as in a collie dog; Fig. 35); fur on forelimb extends onto upper surface of flipper; six teeth behind each of the long, pointed canine teeth; in exposed skull (refer to Figs. 29, 30), interorbital area short, usually less than 20 percent of condylobasal length; tympanic bullae convex; nasal bones long and slender; combined anterior width about 40-50 percent of length; sides of palate parallel between first and third postcanine.
GUADALUPE FUR SEAL
- 9' Muzzle not conspicuously long and pointed (Fig. 35); fur on forelimb stops in abrupt line at wrist; five postcanine teeth (rarely six); in exposed skull, interorbital area longer, usually greater than 20 percent of condylobasal length; tympanic bullae concave; nasals short and wide, combined anterior width about 80-90 percent of length; sides of palate not parallel between first and third postcanine.
NORTHERN FUR SEAL

KEY TO MARINE MAMMALS (Cont.)

Figure 35. Fur seal head comparisons.

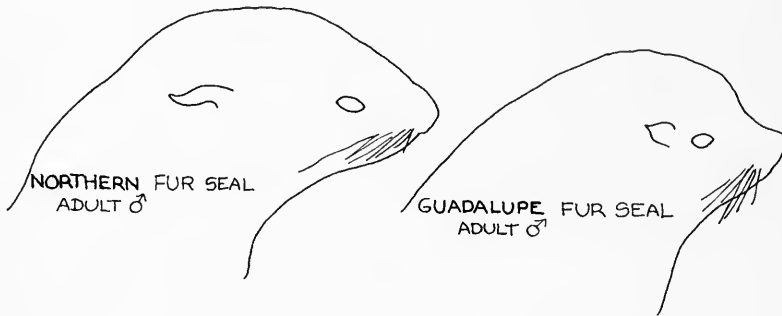

- 10 Six incisors at front of upper jaw (Fig. 29); hind toes nearly equal in length. 11
- 10' Four incisors at front of upper jaw; inner and outer hind toes clearly longer than middle three; color grayish to brownish (pups very dark, black), not spotted or banded; when molting, large patches of fur appear to drop off, giving a (false) diseased appearance. NORTHERN ELEPHANT SEAL
- 11 Whiskers smooth, thick, straight, conspicuously bushy; third digit of foreflipper longest, the flipper being broad and blunt with all claws near tip; no longitudinal ridge of bone on top of skull; mammary teats four; teeth of adults loosely rooted, often worn down to surface of jaw or lost entirely; spaces between teeth behind canines almost tooth wide. BEARDED SEAL
- 11' Whiskers beaded, slender, curled, not bushy; third digit of foreflipper shorter than first and second; the flipper tapered with digits decreasing in length from first ("thumb") to last; sagittal crest present in some species; mammary teats two, teeth of adult firmly rooted; spaces between postcanine teeth less than tooth wide. 12
- 12 Posterior margin of palate distinctly notched or incised (Fig. 36); adult pelage may be spotted. 13

KEY TO MARINE MAMMALS (Cont.)

- 12' Posterior margin of palate not notched, nearly a straight line (Fig. 36); adult pelage not spotted except in some females that have just reached maturity; adult female pale grayish with obscure narrow whitish bands running transversely across lower back; adult male dark brown with conspicuous broad light-colored bands, one around neck and dorsal part of head and one around hind portions of body, with branches directed anteriorly. RIBBON SEAL

Figure 36. Seal skull comparisons; ventral view.

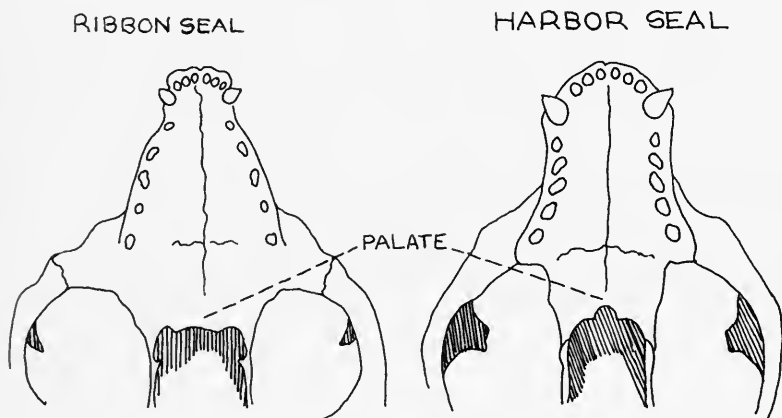

- 13 Claws more or less triangular in cross section, with distinct dorsal ridge; pelage on back harsh to the touch, hairs coarse, tips pointing directly backward; spots large and ring-shaped. For positive identification, skull is needed (see Fig. 29): skull of old individuals without sagittal crest; mandibular teeth always aligned with jaw, never crowded; first postcanines of lower jaw usually with three cusps, the middle cusp largest; inner side of lower jaw between middle postcanine teeth concave. RINGED SEAL
- 13' Claws nearly semicircular in cross section, without distinct dorsal ridge or growth rings, pelage on back smooth to the touch, hairs finer, tips curved downward; spots small. For positive identification, skull is needed (see Fig. 29): skull of old individuals with low sagittal crest; mandibular teeth may be crowded out of line and overlapping; first postcanine teeth of lower jaw usually with four cusps, the second cusp from the anterior end largest; inner side of lower jaw between middle postcanine teeth convex. 14

KEY TO MARINE MAMMALS (Cont.)

- 14 Color variable, with at least two basic phases; 1) light background with dark spots and blotches and 2) dark or black background with small spots or rings. For positive identification, skull is needed (see Fig. 29): nasal-premaxillary contact mostly less than 3 mm; upper premolar teeth of adults mostly set obliquely; shape of posterior margin of jugal in adults mostly angular; bullae angular, not greatly inflated. Virtually the only small seal south of Alaska (except young elephant seals). HARBOR SEAL
- 14' Background color pale silvery with darker steel-gray "saddle" on dorsal surface of nose, head, and body; color usually broken by small, fine rings or blotches, superimposed on dappling of oval to oblong spots, brownish gray to black and about 2x1 cm in diameter, whose long axis usually parallels that of body. For positive identification the skull is needed (see Fig. 29): nasal-premaxillary contact mostly more than 3 mm; upper premolar teeth of adults mostly set straight; shape of posterior margin of jugal in adults mostly rounded; bullae rounded, greatly inflated. LARGHA SEAL
- For subspecific identification of sea otters, characteristics of the skull must be considered:
- 15 Coronoid process (highest lobe of lower jaw) not projecting backward, its posterior edge (as viewed from the side) straight or slightly convex; nasal length usually less than 18 mm; skull viewed from above, with notch or suggestion of notch at narrowest part (between the eyes). Color very dark. NORTHERN SEA OTTER
- 15' Coronoid process projecting backward, its posterior edge concave; nasal length usually greater than 18 mm; skull without notch at narrowest part, the bones flaring smoothly to the front and back. Color usually medium brown. SOUTHERN SEA OTTER
- 16 Baleen present (Fig. 27); teeth absent; mouth slit extends back at least as far as the eyes (as in Fig. 27); blowhole with double opening; each half of the lower jaw curved outward, connected in front by ligaments (thus mobile with respect to each other). (BALEEN WHALES) 17
- 16' Baleen absent; teeth present, although sometimes hidden in folds of gums and sometimes absent in old individuals; mouth slit does not extend back as far as eyes (as in Fig. 28); blowhole with single opening; each half of lower jaw straight or bent inwards and rigidly connected at the front. (TOOTHED WHALES) 25

KEY TO MARINE MAMMALS (Cont.)

- 17 Throat and belly smooth, without longitudinal grooves; no dorsal fin. (RIGHT WHALES) 18
- 17' Longitudinal grooves present on belly and throat, or only on throat (Fig. 27); fin or at least a bumpy ridge present on back. (GRAY WHALES) 19
- 18 Skull narrow and long, a regular semicircular arch; head about one-third of total body length; mouth slit arch-shaped; upper margin of lower lip bordered by a smooth curved line, without scallop like outgrowths; no outgrowth on upper side of snout, between its tip and the blowhole; average number of baleen plates 330 per side, length in the middle of the jaw up to 3.5 m, black in color. BOWHEAD
- 18' Skull narrow and long, an arch with the posterior region noticeably steeper than the anterior; head about one-fourth the total length; mouth slit S-shaped; upper margin of lower lip scalloped; a thick outgrowth (bonnet, see Fig. 27) on top of snout between its tip and the blowhole; average number of baleen plates 250 per side, length up to 2 m, usually black in color. NORTHERN RIGHT WHALE
- 19 Two to four longitudinal grooves on throat, slightly diverging posteriorly; no dorsal fin but only a low hump on the back, followed by a ridge of bumps extending nearly to the flukes; about 180 baleen plates per side, each plate yellowish, up to 20-40 cm in length, and with coarse bristles; baleen on left and right sides do not meet in front; outer edges of baleen rounded; body color, mottled gray even in young. CALIFORNIA GRAY WHALE
- 19' More than 11-12 parallel grooves on the belly and throat (count grooves between flippers; do not include grooves on sides above flippers, or on side of head); dorsal fin well developed; more than 220 baleen plates per side, connected in front of jaw by shaft-like formations; outer edges of baleen sharp. (RORQUALS) 20
- 20 Flippers very long and with scalloped rear edges, greater than one-fourth the animal's total length; longitudinal grooves on belly and throat deep and broad (8-10 cm), totalling less than 40 (usually 12-36); dorsal fin relatively low and thick, usually increasing in size toward the rear in a step-like configuration; numerous knobs, resembling orange (the fruit) halves in size and shape, on head and lower jaws; baleen short, less than 61 cm long, blackish to olive brown, with 10-35 grayish white bristles per cm, 270-400 plates per side. HUMPBACK WHALE

KEY TO MARINE MAMMALS (Cont.)

- 20' Flippers with smooth rear edges and not more than one-fifth the total length; longitudinal grooves on belly and throat fine and narrow (1-4 cm) numbering over 40; dorsal fin thin, slender, usually smooth; head without knobs. 21
- 21 Ventral grooves end before navel; one ridge on head, from blowholes forward. 22
- 21' Ventral grooves extend to or beyond navel; one or three ridges on head. 23
- 22 Ventral grooves number 50-70, longest ones often end between flippers; yellowish baleen, <21 cm long, with 15-25 yellowish-white bristles per cm, 300-325 plates per side; large white patch on dorsal surface of flipper. MINKE WHALE
- 22' Ventral grooves number 38-56, longest ones end posterior to flippers though well before navel; baleen <78 cm long, grayish-black with 35-60 fine grayish-white bristles per cm (some anterior plates may be partly white), 318-340 plates per side. SEI WHALE
- 23 Three prominent ridges on head: one from the blowholes forward, with another on each side; 40-50 ventral grooves; 250-300 slate-gray baleen plates with 15-35 gray bristles per cm. BRYDE'S WHALE
- 23' Only one prominent ridge on head (blue whale has faint lateral ridges) from blowholes forward; 55-100 ventral grooves; over 310 baleen plates per side. 24
- 24 Head broad and U-shaped, as viewed from above; dorsal fin less than 33 cm tall, usually triangular, and set very far back toward tail; baleen all black with 10-30 black bristles per cm, plates extremely broad relative to length, about 318-328 plates per side. BLUE WHALE
- 24' Head broad at back of mouth slit but sharply pointed at snout; dorsal fin to 61 cm high, curved slightly to moderately backward, and located slightly more than one-third forward from tail to snout; one-fifth to one-third of baleen on right front ivory to yellowish-white, remainder grayish streaked with yellowish-white, plates have 10-15 gray or white bristles per cm and are narrow relative to length, about 356-365 plates per side. FIN WHALE

KEY TO MARINE MAMMALS (Cont.)

- 25 Mouth situated entirely on extreme lower side of head, upper part of head extending well past tip of lower jaw; lower jaw much narrower than upper; convexity of the blowhole directed sideways and not straight to the rear, OR blowhole S-shaped. 26
- 25' Mouth situated at the fore-end of the snout; lower jaw extending as far or almost as far as front of the head, almost as wide as the snout; convexity of the blowhole directed straight to the rear. 28
- 26 Head very large, up to one-third the animal's total length, squarish in front, and sides very flat in the anterior part; blowhole S-shaped, located at the left front corner of the head; dorsal fin low, shaped as a hump or series of humps on the posterior half of the body; no teeth in upper jaw, tooth sockets present which act as receptacles for teeth of lower jaw when mouth closed. SPERM WHALE
- 26' Head about one-fifth the animal's total length, evenly rounded in front; blowhole horseshoe-shaped, situated on top of head, slightly displaced to the left and approximately even with the eyes; dorsal fin slender. 27
- 27 No creases on throat; dorsal fin small, located well behind midpoint of total body length; 12-16 teeth (rarely 10-11) in each side of lower jaw. PYGMY SPERM WHALE
- 27' Inconspicuous creases on throat; dorsal fin tall and slender, located nearer the middle of the back (the anterior portion of the fin is near the midpoint of the body); 8-11 (rarely 13) sharp teeth in each side of lower jaw, rarely 1-3 teeth in each side of upper jaw. DWARF SPERM WHALE
- 28 Conspicuous grooves on outer surface of throat, converging anteriorly median notch in rear edge of tail flukes absent or inconspicuous; teeth very few and only in lower jaw, sometimes not visible. (BEAKED WHALES) 29
- 28' No conspicuous grooves on throat; deep median notch on rear margin of flukes; teeth usually numerous in upper and lower jaws, but in exceptional cases upper teeth are absent (Risso's Dolphin) or number only one or two (Narwhal). 31

KEY TO MARINE MAMMALS (Cont.)

- 29 Rostrum straight, long and slender, transverse width in the middle of the rostrum not more than one-seventh of its length; one tooth on each side of lower jaw, erupted or hidden beneath the gum, set quite far to the rear of the fore-end of the lower jaw, usually behind the tip of the rostrum when the mouth is closed; teeth laterally compressed, their anterior-posterior axis at least twice as long as transverse axis.
BEAKED WHALES (4 species; skull needed for identification)
- 29' Rostrum not as above, width in middle not less than one-sixth of its length; one or two teeth in each side of the lower jaw (erupted or hidden beneath the gum), usually set at tip and in front of the upper jaw tip when mouth closed; teeth nearly round in cross section, if flattened, then anterior-posterior axis not more than 1.5 times the transverse axis. 30
- 30 Two teeth in each side of lower jaw; well developed grooves in front of eyes (preorbital), sharply defining rear margin of rostrum; rostrum in dorsal view, narrow at base, the length being 2.0-2.2 times the width between the grooves; forehead not concave in front of blowhole; distinct beak and bulging forehead present; beak flattened dorso-ventrally, its margins parallel to one another.
BOTTLENOSE WHALES (skull needed for species identification)
- 30' One tooth in each side of lower jaw; preorbital grooves not sharply defined; rostrum in dorsal view relatively shorter and wider than above, forming more closely an equilateral triangle; forehead slightly concave in front of blowhole, increasing in concavity with increasing size; no distinct beak or bulging forehead; beak not flattened dorso-ventrally, its margins not parallel. GOOSE-BEAKED WHALE
- 31 No dorsal fin, but rather a low, narrow ridge near midpoint of back; either one pair of teeth in upper jaw (in females (Fig. 37), usually concealed beneath gums and sometimes a tusk; in males, a tusk up to 3 m in length), OR up to 44 teeth (8-11 pairs above and below), the upper teeth markedly inclined forward and usually having an egg-shaped cavity on the lower edge of the crown, produced from friction with the anterior lower teeth. 32
- 31' Dorsal fin present or absent (if absent, then total tooth count not less than 60); lower jaws always with teeth. 33
- 32 Same color all over (adults white or yellowish; young 1.5-2 m long, slate gray or brownish); 32-44 teeth (8-11 pairs above and below), teeth set widely apart, inclined markedly forward in upper jaw; distinct neck constriction behind head. BELUGA OR WHITE WHALE

Figure 37. Some morphological differences between male and female cetaceans.

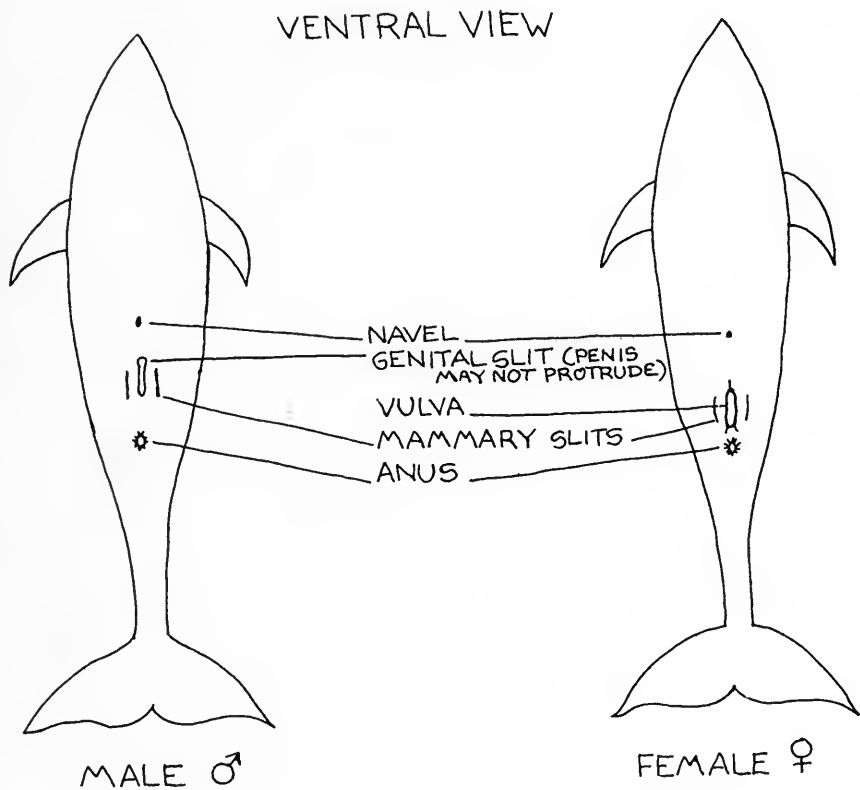

THE DISTANCE BETWEEN THE ANUS AND THE GENITALS IS GREATER IN MALES; OTHERWISE THE SEXES APPEAR SIMILAR BECAUSE MALES HAVE EXTERNAL TESTES, AND FEMALES HAVE ENLARGED CLITORI. IF POSSIBLE, TAKE A PHOTOGRAPH OR MAKE A DRAWING, OR GO INSIDE AND MEASURE GONADS IF YOU HAVE PERMISSION TO DO SO.

KEY TO MARINE MAMMALS (Cont.)

- 32' Adults spotted, but young (1 m in length) are not (shale-blue all over); no teeth in lower jaw, but one pair in upper jaw, usually not showing in females; in males and sometimes females one or both of these teeth may grow into a tusk up to 3 m in length. NARWHAL
- 33 No dorsal fin; color very dark except for thin white stripe on belly that widens between flippers to form a large patch; tip of lower jaw and ventral side of flukes usually white. NORTHERN RIGHT WHALE DOLPHIN
- 33' Dorsal fin present; color not as in 33. 34
- 34 Tooth crowns flattened, oval in cross section, usually more than 2.5-2.8 cm in diameter (in the middle of the jaw); an ovate white spot on side of the head, but if absent, then dorsal fin distinctly higher than long; a white band on middle of the abdomen, with a branch directed to the rear on each side of the anal region; flippers ovate (less than twice as long as wide). KILLER WHALE
- 34' Tooth crowns more or less round in cross section near the gum, not more than 2.5-2.8 cm in diameter; no ovate spot on the temple; dorsal fin not distinctly higher than long; coloration of the abdomen different than in 34; total body length less than 4 m, OR if longer (4-6.5 m), then flippers pointed and long (length of flippers more than 2.5 times the width). 35
- 35 No teeth, or rarely 1-2 pairs of teeth, in upper jaws; 2-7 pairs of teeth in the anterior part of the lower jaw; forehead almost vertical, with a central longitudinal crease. RISSO'S DOLPHIN
- 35' More than 6 pairs of teeth each in upper and lower jaws; forehead usually rising gradually from snout, but if steep then no crease in forehead. 36
- 36 Head rounded, beakless, the forehead rising almost vertically from snout; not more than 8-13 pairs of teeth in each jaw; total length 6.5 m. 37
- 36' Beak well defined, or if absent, the forehead low, not rising vertically from the snout; more than 15 pairs of teeth in each jaw; total length up to 4 m. 38

KEY TO MARINE MAMMALS (Cont.)

- 37 Dorsal fin low and thick, located 1/3 the distance from snout to tail; length of dorsal fin two or more times its height; flipper length equal to or greater than one-sixth of body length; teeth relatively slender, not more than 1.3 cm in diameter, located in the anterior portion of the jaw (thus the length from the first to last tooth is markedly shorter than the length of the jaw); mouth directed downwards, at an angle of 30-45° to the horizontal body axis; prominent hump on anterior edge of flipper. SHORT-FINNED PILOT WHALE
- 37' Dorsal fin thin, situated in the middle of the body, or somewhat more towards the head; basal length of fin less than twice its height; flipper length one-seventh or less of total body length; teeth relatively thick, 2.7 cm in diameter; teeth extend along entire jaw; mouth less oblique to body axis; anterior edge of flipper smoothly curved (no prominent hump). FALSE KILLER WHALE
- 38 Beak distinct (though may be short), with or without a sharp demarcation between beak and forehead; teeth cone-shaped, not flattened at tip. 39
- 38' Beak inconspicuous; teeth not conical, the crowns broadened and flattened laterally, or chisel-shaped, slender, and almost totally buried in gums. 40
- 39 The long slender beak smoothly joins forehead; 20-27 teeth in each side of both upper and lower jaws; each tooth has a series of fine vertical grooves on the crown (may be difficult to detect, if worn); the halves of lower jaws joined along one-fourth their length. ROUGH-TOOTHED DOLPHIN
- 39' Beak separated from the forehead by a transverse groove, teeth are without grooves and have smooth crowns. 41
- 40 Pointed head and moderately stout body; dorsal fin shaped as a low equal-sided triangle somewhat lower than long at the base (but not less than half as high as long); fore and rear edges of the fin forming equal angles with the back; a large white area extending high into the flanks, sharply delineated from the dusky dorsal and anterior areas; a distinct, humped ridge runs from the flukes up the middle of the back; teeth chisel-shaped, very slender, not exceeding 1 mm in thickness, more or less embedded in gums; vertebrae number about 98. DALL'S PORPOISE

KEY TO MARINE MAMMALS (Cont.)

- 40' Blunt snout and short thick body; dorsal fin usually triangular but posterior margin nearly perpendicular to the back, while anterior margin not so steep; dark above, light below; no sharply delimited white area on flanks; no prominent ridge running forward from flukes; teeth usually with broad crown (flattened laterally, spatula-shaped), not buried in gums; diameter of teeth in the middle of the jaw >1 mm at the gum line; vertebrae number about 68.
HARBOR PORPOISE
- 41 Beak long, the distance from its tip to the eye center is less than 2.6 times the beak length (from tip to beginning of forehead); beak length is greater than one-twentieth the total body length. 42
- 41' Beak moderate to short, the distance from beak tip to the eye center greater than 2.7 times the beak length; beak length is less than one twenty-fifth the total body length. 43
- 42 A dark streak running from the flipper base toward chin; roof of mouth (palate) with two longitudinal grooves. COMMON DOLPHIN
- 42' A dark streak (often indistinct) running from flipper to corner of mouth area or to base of eye, and frequently circling eye (variable); roof of mouth without grooves; up to 2.7 m in length.
SPOTTED AND STRIPED DOLPHINS (*Stenella* spp;
skull required for positive identification)
- 43 Each side of upper jaw has 19-26 teeth, 19-25 teeth on each side of lower jaw; diameter of a tooth from the middle of the jaw 6-11 mm; beak not white, up to 7 cm long in adults; no ridge on back from flukes forward; gray or dark blackish, belly lighter. BOTTLENOSE DOLPHIN
- 43' Each side of upper and lower jaws has 27-40 teeth; diameter of a tooth from center of jaw, 4-5 mm; if teeth fewer (up to 22 per side of jaw) and their diameter is greater (up to 6-7 mm), then beak white; beak from tip to forehead is up to 5 cm long in adults; sides of body flattened just before flukes with a distinct ridge along top; black back, striking light gray sides and white belly.
PACIFIC WHITE-SIDED DOLPHIN

Plate 38a Pinniped bacula.

NATURAL SIZE, WITH
END VIEWS

NORTHERN
SEA LION

NORTHERN
ELEPHANT SEAL

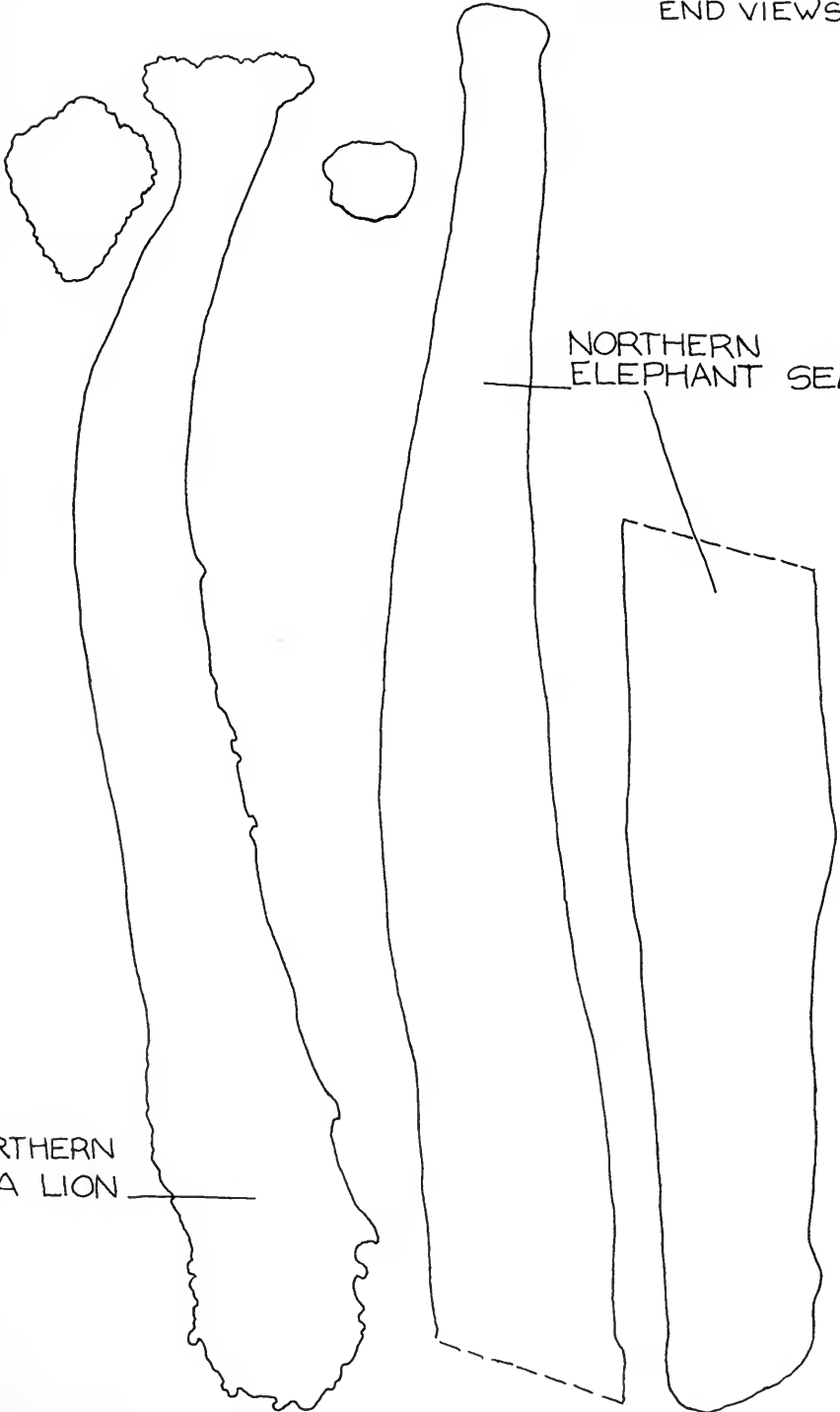
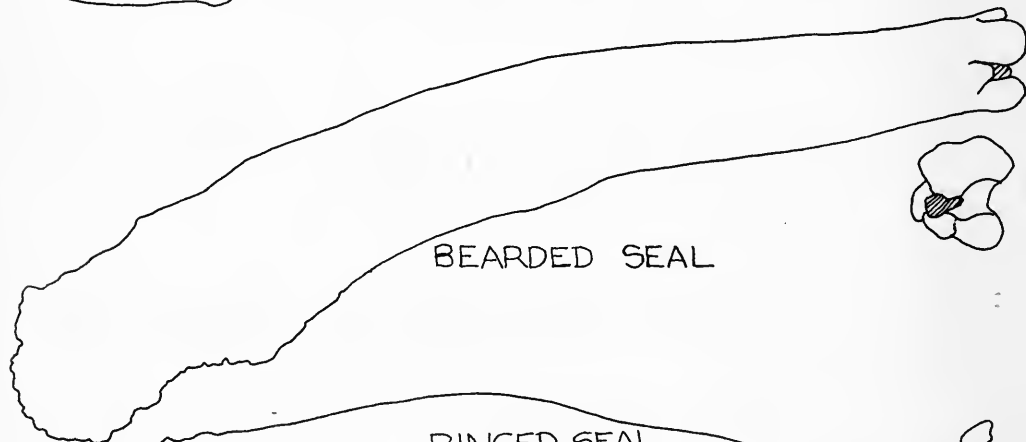

Plate 38b Pinniped bacula.



MAMMAL SPECIES ACCOUNTS

Information on range and the maximum sizes of the animals are given in the following species accounts. Such information was excluded from the keys because unless considered carefully, it can be very misleading. If the animal you are keying out is say, 10 m long, then you can rule out those species in which maximum length is much less than that. You *can not* rule out animals that attain a greater maximum length because, and often quite likely, you may be trying to identify a juvenile or subadult. In some instances we can offer information on minimum lengths (at birth). Another difficulty with size in marine mammals, especially pinnipeds, is that males and females can be greatly different in size. Information on size comes from Scheffer (1958) and Leatherwood et al. (1972).

SEA LIONS AND FUR SEALS (OTARIIDAE)

NORTHERN (or STELLER) SEA LION (*Eumetopias jubatus*; choices 7' and 8', pg. 164) occurs from southern California north to the Bering Strait. Males reach a length of 3.2 m and a weight of 1000 kg; females reach 2.3 m and 275 kg. At birth, pups are about a meter long and weight about 18 kg.

CALIFORNIA SEA LION (*Zalophus californianus*; choices 7 and 8, pg. 164) occurs from Cabo San Lucas north to British Columbia; females rarely move north of central California. Males reach a length of 2.4 m and a weight of 280 kg; females reach 1.8 m and 95 kg. At birth pups are less than a meter long.

GUADALUPE FUR SEAL (*Arctocephalus townsendi*; choice 9, pg. 164) occurs principally off central Baja California and less so north to southern California. Individuals have occasionally been sighted north to central California. Its population is exceedingly small compared to those of the sea lions or the Northern Fur Seal. Males reach a length of 2.6 m and a weight of 300 kg; females reach 1.8 m and 125 kg. Pups are less than a meter long.

NORTHERN FUR SEAL (*Callorhinus ursinus*; choice 9', pg. 164) occurs from the Bering Sea south to southern California. Males reach a length of 2.2 m and a weight of 280 kg; females reach 1.5 m and 65 kg. Pups are less than a meter long.

WALRUS (ODOBENIDAE)

WALRUS (*Odobenus rosmarus*; choice 4, pg. 160) occurs principally in the Bering Sea although very rarely individuals have been reported as far south as British Columbia. Males reach a length of 3.7 m and a weight of 1300 kg; females reach 3 m and 850 kg. Pups are about a meter in length.

SEALS (PHOCIDAE)

BEARDED SEAL (*Erignathus barbatus*; choice 11, pg. 165) occurs around sea ice, and moves with the ice seasonally from the Arctic Ocean to the southern Bering Sea. Males reach a length of 2.9 m and a weight of 400 kg; females reach 2.6 m in length.

RINGED SEAL (*Phoca hispida*; choice 13, pg.166) is associated with sea ice, and seasonally moves to the southeastern Bering Sea from the Arctic Ocean. Males and females reach a length of 1.4 m and a weight of 90 kg. Newborn pups are less than 0.75 m long.

RIBBON SEAL (*Phoca fasciata*; choice 12', pg. 166) like the previous two species, is associated with sea ice. It moves seasonally with the ice in the Bering Sea, its usual southern limit being the Alaska Peninsula. On very rare occasions, they have been encountered south of Alaska, as far south, in fact, as California. Males and females reach a length of 1.7 m and a weight of 100 kg and 80 kg respectively.

HARBOR SEAL (*Phoca vitulina*; choice 14, pg. 167) is widely distributed in coastal waters from the southeastern Bering Sea to central Baja California. Males reach a length of 1.8 m and a weight of 120 kg; females reach 1.6 m and 110 kg. Newborn pups are about 0.75 m long.

LARGHA or SPOTTED SEAL (*Phoca largha*; choice 14', pg. 167) is the Asian counterpart of the Harbor Seal and occurs in North American waters largely only in the vicinity of the Bering Strait. Specimens are also known from the vicinity of the Pribilof Islands. This species averages slightly larger than the Harbor Seal, but there is great overlap in size.

NORTHERN ELEPHANT SEAL (*Mirounga angustirostris*; choice 10', pg. 165) occurs from central Baja California north to British Columbia, and rarely to southeast Alaska. Males reach a length of 6.5 m and a weight of 3700 kg; females reach 3.6 m and 910 kg. Newborn pups are about 1.3 m in length.

SEA OTTERS (MUSTELIDAE)

NORTHERN and SOUTHERN SEA OTTER (*Enhydra lutris lutris* and *E. l. nereis*; choices 15 and 15', pg. 167). The Northern Sea Otter occurs from the Aleutians south to Washington and the Southern Sea Otter occurs from Baja California north to southeast Alaska. Their ranges thus overlap. The northern form reaches a maximum size of about 1 m and the southern form reaches 1.4 m in length.

RIGHT WHALES (BALAENIDAE)

BOWHEAD (*Balaena mysticetus*; choice 18, pg. 168) occurs in association with sea ice in the Arctic Ocean and Bering Sea. It reaches a maximum length of 21 m.

NORTHERN RIGHT WHALE (*Eubalaena glacialis*; choice 18', pg. 168) occurs from western Alaska, and perhaps the Bering Sea, south to central Baja California. It reaches a maximum length of 17 m.

GRAY WHALES (ESCHRICHTIIDAE)

CALIFORNIA GRAY WHALE (*Eschrichtius robustus*; choice 19, pg. 168) migrates from Baja California in winter to as far north as the Bering Sea in spring and summer. Maximum length is 15 m.

RORQUALS (BALAENOPTERIDAE)

HUMPBACK (*Megaptera novaeangliae*; choice 20, pg. 168) occurs throughout the area covered by this manual, migrating south in the fall to tropical seas and north in the spring to the Arctic. Maximum length is 16 m.

MINKE WHALE (*Balaenoptera acutorostrata*; choice 22, pg. 169) occurs from the Bering Sea to Baja California and is apparently in the latter area during the winter. Maximum length is 10 m.

SEI WHALE (*Balaenoptera borealis*; choice 22', pg. 169) spends its summers from California north to the Gulf of Alaska, and at other times occurs farther south. Maximum length is 19 m.

BRYDE'S WHALE (*Balaenoptera edeni*; choice 23, pg. 169) occurs from central Baja California south. Maximum length is 15 m.

BLUE WHALE (*Balaenoptera musculus*; choice 24, pg. 169) occurs from the Aleutian Islands to central California in summer, and from Baja California to the south in winter. Maximum length is 26 m.

FIN WHALE (*Balaenoptera physalus*; choice 24', pg. 169) occurs from the central Bering Sea to Baja California. Maximum length is 22 m.

SPERM WHALES (PHYSETERIDAE)

SPERM WHALE (*Physeter catodon*; choice 26, pg. 170) occurs off California and Baja California during the winter and during the summer occurs from California to as far north as the Bering Sea. Maximum length is 18 m.

PYGMY SPERM WHALE (*Yogia breviceps*; choice 27, pg. 170) occurs in this area largely off California and Baja California, but also occasionally as far north as Washington. Maximum length is about 4 m.

DWARF SPERM WHALE (*Yogia simus*; choice 27', pg. 170) occurs from Baja California north to central California. Maximum length is slightly more than 3 m.

BEAKED WHALES (ZIPHIIDAE)

BEAKED WHALES (*Mesoplodon* spp; choice 29, pg. 171). At least four species are possible and although their ranges (poorly known) may not be entirely overlapping, one or the other could occur anywhere in the area covered by this manual. They reach a length of about 6.5 m.

BOTTLENOSE WHALES (*Mesoplodon* spp.; choice 30, pg. 171) occur from the Bering Sea to at least southern California. They reach a length of about 14 m.

GOOSE-BEAKED WHALE (*Ziphius cavirostris*; choice 30', pg. 171) occurs from the Bering Sea to Baja California. Maximum length is about 10 m.

MONODONTS (MONODONTIDAE)

BELUGA (*Delphinapterus leucas*; choice 32, pg. 171) occurs from the Arctic Ocean south to southeast Alaska. Maximum length is 6 m.

NARWHAL (*Monodon monoceros*; choice 32', pg. 173) occurs in the Arctic Ocean and on very rare occasions has been reported in the vicinity of the Bering Strait. Maximum length is 6 m.

DOLPHINS AND PORPOISES (DELPHINIDAE)

NORTHERN RIGHT WHALE DOLPHIN (*Lissodelphis borealis*; choice 33, pg. 173) occurs from southeast Alaska to as far south as southern California. Maximum length is about 2.5 m.

KILLER WHALE (*Orcinus orca*; choice 34, pg.173) occurs throughout the region covered in this manual. Maximum length up to 10 m.

RISSO'S DOLPHIN (*Grampus griseus*; choice 35, pg. 173) occurs largely from California south to the tropics, but has been reported as far north as British Columbia. Maximum length is 4 m.

SHORT-FINNED PILOT WHALE (*Globicephala macrorhynchus*; choice 37, pg. 174) occurs largely from central California south, although on occasion it has been reported as far north as the Alaska Peninsula. Maximum length is about 6.5 m.

FALSE KILLER WHALE (*Pseudorca crassidens*; choice 37', pg. 174) occurs from Washington south. Maximum length is about 5.5 m.

ROUGH-TOOTHED DOLPHIN (*Steno bredanensis*; choice 39, pg. 174) is most likely to be found in waters off southern Baja California, although specimens have occurred rarely as far north as central California. Maximum length is about 2.5 m.

COMMON DOLPHIN (*Delphinus delphis*; choice 42, pg. 175) occurs normally in warmer waters, from central California south, but on rare occasions has been reported as far north as British Columbia. Maximum length is about 2.5 m.

SPOTTED and STRIPED DOLPHINS (*Stenella* spp; choice 42', pg.175) occur from central Baja California south but on rare occasions have been reported as far north as southern California. Maximum length is about 3 m.

BOTTLENOSE DOLPHIN (*Tursiops truncatus*; choice 43, pg. 175) occurs largely from southern California south, but on rare occasions has been reported as far north as Oregon. Maximum length is about 3.5 m.

PACIFIC WHITE-SIDED DOLPHIN (*Lagenorhynchus obliquidens*; choice 43', pg. 175) occurs from southeast Alaska to central Baja California. Maximum length is about 2.5 m.

DALL'S PORPOISE (*Phocoenoides dalli*; choice 40, pg. 174) occurs principally from the Aleutian Islands to southern California, and infrequently as far south as central Baja California. Maximum length is about 2.5 m.

HARBOR PORPOISE (*Phocoena phocoena*; choice 40', pg. 175) occurs from the Bering Strait to southern California. Maximum length is about 1.7 m.

BOOKS AND ARTICLES FOR ADDITIONAL INFORMATION ON MARINE MAMMALS

- Allen, J.A. 1880. History of North American Pinnipeds. Government Printing Office, Misc. Publ. No. 12. Washington. 785 pp.
- Barnard, K.H. 1954. A Guide Book to South African Whales and Dolphins. South African Mus., Guide No. 4. Cape Town. 33 pp.
- Bee, J.W., and E.R. Hall. 1956. Mammals of northern Alaska, on the Arctic Slope. Univ. Kansas, Mus. Nat. Hist., Misc. Publ. No. 8. 309 pp.
- Davis, J., and W.Z. Lidicker. 1975. The taxonomic status of the southern sea otter. Calif. Acad. Sci., Proc. II (14):429-437.
- Daugherty, A.E. 1972. Marine Mammals of California. Second ed. Dept. Fish and Game, Sacramento. 86 pp.
- Fraser, F.C., and H.W. Parker. 1966. Guide for the Identification and Reporting of Stranded Whales, Dolphins, Porpoises and Turtles on the British Coasts. Brit. Mus. Nat. Hist. London. 42 pp.
- Caskin, D.E. 1968. The New Zealand Cetacea. Fish. Res. Bull. No. 1 (new series). 92 pp.
- Harmer, S.F. 1909. Guide to the Whales, Porpoises, and Dolphins Exhibited in the Department of Zoology, British Museum (Natural History). London. 47 pp.
- Hershkovitz, P. 1966. Catalog of Living Whales. U.S. Natl. Mus., Bull. 246. 259 pp.
- Kellogg, R. 1940. Whales, giants of the sea. Natl. Geogr. Mag. 77: 35-90.
- Kenyon, K.W., and V.B. Scheffer. 1955. The seals, sea-lions, and sea otter of the Pacific coast. Fish and Wildl. Ser., Cir. 32. 34 pp.

- Kenyon, K.W. 1969. The sea otter in the eastern Pacific Ocean. North Amer. Fauna, No. 68. 352 pp.
- Leatherwood, S., W.E. Evans and D.W. Rice. 1972. The Whales, Dolphins and Porpoises of the Eastern North Pacific, A Guide to Their Identification in the Water. Naval Undersea Center, Tech. Publ. 282. 175 pp.
- Leatherwood, S., D.K. Caldwell, and H.E. Winn. 1976. Whales, Dolphins, and Porpoises of the Western North Atlantic, a Guide to Their Identification. NOAA Tech. Rept., NMFS Circ. 396. 176 pp.
- Mansfield, A.W. 1964. Seals of Arctic and Eastern Canada. Fish Res. Bd., Canada, Bull. No. 137. 30 pp.
- Marine Mammal Commission. 1976. Marine Mammal Names. Marine Mammal Comm. Washington, D.C. 8 pp.
- Mitchell, E.D. 1973. The status of the world's whales. Nat. Canada 2:9-25.
- Norris, K.S. (ed.) 1961. Standardized methods for measuring and recording data on the smaller cetaceans. J. Mammal. 42:471-476.
- Norris, K.S. 1966. Whales, Dolphins and Porpoises. Univ. Calif. Press, Berkeley. 789 pp.
- Peterson, R.S., C.L. Hubbs, R.L. Gentry and R.L. DeLong. 1968. The Guadalupe fur seal; habitat, behavior, population size, and field identification. J. Mammal. 49:665-675.
- Perrin, W.F. 1972. Color patterns of spinner porpoises (*Stenella cf. S. longirostris*) of the eastern Pacific and Hawaii, with comments on delphinid pigmentation. Fish. Bull. 70:983-1003.
- Pike, G.C. 1956. Guide to the Whales, Porpoises and Dolphins of the Northeast Pacific and Arctic Waters of Canada and Alaska. Fish Res. Bd. Canada. Circ. 32. 14 pp.
- Pike, G.C. and L.B. McCaskie. 1969. Marine mammals of British Columbia. Fish. Res. Bd. Canada. Bull. 171. 54 pp.
- Repenning, C.A., R.S. Peterson and C.L. Hubbs. 1969. Classification of fur seals. Sixth Annual Conf. Biol. Sonar and Diving Mammals. Stanford Res. Inst., Menlo Park. 8 pp.
- Repenning, C.A., R.S. Peterson and C.L. Hubbs. 1971. Contributions to the systematics of the southern fur seals, with particular reference to the Juan Fernandez and Guadalupe species. In Antarctic Pinnipedia. Antarctic Res. Ser. 18:1-34. Amer. Geophys. Union, Wash. D.C.

- Rice, D.W. 1967. Cetaceans, pp. 291-324. *In* Recent Mammals of the World. Ronald Press, New York.
- Rice, D.W., and V.B. Scheffer. 1968. A list of the marine mammals of the world. U.S. Fish Wild. Serv., Spec. Sci. Rep. Fish. 579. 16 pp.
- Robinette, H.R., and H.J. Stains. 1970. Comparative study of the calcanea of the Pinnipedia. *J. Mammal.* 51:527-541.
- Roest, A.I. 1973. Subspecies of the sea otter, *Enhydra lutris*. Los Angeles Co. Mus. Nat. Hist., Contr. Sci. No. 252. 17 pp.
- Ronald, K., and A.W. Mansfield. 1975. Biology of the seal. Rapp. P.-v Reun. Cons. int. Explor. Mer. 169. 557 pp.
- Sergeant, D.E. 1961. Whales and dolphins of the Canadian east coast. Fish. Res. Bd. Canada, Cir. No. 7. 17 pp.
- Sergeant, D.E., and H.D. Fisher. 1957. The smaller cetacea of eastern Canadian waters. *J. Fish. Res. Bd. Canada*, 14:83-115.
- Scheffer, V.B. 1958. Seals, sea lions, and walruses., a review of the pinnipedia. Stanford Univ. Press, Stanford. 179 pp.
- Scheffer, V.B. (ed.) 1967. Committee on marine mammals. Standard measurements of seals. *J. Mammal.* 48:459-462.
- Scheffer, V.B., and J.W. Slipp. 1948. The whales and dolphins of Washington state with a key to the cetaceans of the west coast of North America. *Amer. Mid. Nat.* 39:257-337.
- Scheffer, V.B., and F. Wilke. 1950. Validity of the subspecies of *Enhydra lutris nereis*, the southern sea otter. *J. Wash. Acad. Sci.* 40:269-272.
- Shaughnessy, P.D., and F.H. Fay. 1977. A review of the taxonomy and nomenclature of North Pacific harbour seals. *J. Zool., London* 182:385-419.
- Starks, E.C. 1922. Records of the capture of fur seals on land in California. *Calif. Fish and Game.* 8:155-160.
- Tomilin, A.G. 1957. Mammals of the U.S.S.R. and adjacent countries, Vol. IX. Israel Program Sci. Transl., Wash. D.C. 717 pp.
- True, F.W. 1889. Contributions to the natural history of the cetaceans, a review of the family Delphinidae. U.S. Natl. Mus. Bull. 36. 192 pp.
- Walker, E.P. 1964. Mammals of the World. Johns Hopkins Press, Baltimore.

AGENCIES TO NOTIFY CONCERNING BEACHED MARINE MAMMALS

You may report beached (live or dead) marine mammals to one or more of these organizations.

a) National Marine Fisheries Service Offices

Main Office Washington, D.C.
202 - 343-4543; 634-7265

Alaska

Alaska Region - 632 W. 6th Ave, Suite 408, Anchorage, AK 99501
907 - 265-4422

Kodiak - P.O. Box 1036, Kodiak, AK 99615
907 - 486-3298

Juneau - P.O. Box 1668, Juneau, AK 99801
907 - 586-7221

Washington

Northwest Region - 1700 Westlake Ave, N., Seattle, WA 98109
206 - 399-7676

Research Center - 2725 Montlake Blvd E., Seattle, WA 98112

Oregon

District Enforcement - P.O. Box 27, Astoria, OR 97103

Coos Bay - P.O. Box 1096, Rm. 212, Post Office Bldg., Coos Bay,
503 - 269-1861 OR 97420

Portland - 811 N.E. Oregon St., Portland, OR 97208

California

Southwest Region - 300 S. Ferry St, Rm. 2016,
Terminal Island, CA 90731
213 - 548-2518

- 525 Market St., San Francisco, CA
415 - 556-8636

b) U.S. Fish and Wildlife Service

1 - Main Office Washington, D.C., Marine Mammals Coordinator
202 - 343-9442

2 - Los Angeles
213 - 262-6611

3 - Burlingame
415 - 344-5900

Mexico

Instituto Nacional de Investigaciones Biología Pesquera,
 Division de Vertebrados Marinos; Mexico 7, D.F.

Inst. Del Mar, U.A.B.C., km 105 Carretera Tijuana La Paz,
 Ensenada, Baja California, Mexico

Canada

Fisheries Research Board of Canada, Ste. Anne de Bellevue,
 Quebec

Biological Section, F.R.B.C., Nanaimo, B.C., Canada V9R5K6

c) State Fish and Game Departments

Alaska

Dept of Fish and Game, 1300 College Rd, Fairbanks, AK 99701

Washington

Dept of Game, N. Capitol Way, Olympia, WA 98501

Oregon

State Game Commission, P.O. Box 3505, Portland, OR 97208

California

Dept Fish and Game, Marine Resources, 411 Burgess St,
 Menlo Park, CA
 415 - 326-0324

Dept Fish and Game, 350 Golden Shore, Terminal Island, CA
 213 - 435-7741

d) Local college or university, and/or natural history museum.

e) Local or state police, coast guard, marine patrol or sheriff.

ACKNOWLEDGEMENTS

This manual is based on the experience gained in conducting a large and successful beached bird census program, that of the Point Reyes Bird Observatory. Early on in this effort, the need for an identification manual became apparent. The beach censuses themselves have been conducted by about 200 volunteers over the last eight years. It is through interactions with them that we have learned about the circumstances that make various species difficult to identify in the hand. Many of these people also used, and tested for us, a preliminary draft of the manual. Their efforts have been indispensable. We would especially like to thank the following persons for their valuable criticisms of the earlier draft:

Stephen Bailey, Joan Breece, Jane Church, Roger Clapp, David Clark, Deborah Clark, Patrice Daley, William Eastman, Joseph Gnagey, Janet Hamber, Bill Harrington-Tweit, Dorothy Hunt, Joseph Jehl, Bernadene Logan, Flora Maclise, Mary Mayer, Dave Shuford, David M. Smith, Nancy Spear, David W. Vollmer, Edna Vollmer, Terry Wahl, Jay Watson.

An invaluable aid in the preparation of the keys were the bird skin collections at the Museum of Vertebrate Zoology, Berkeley, the California Academy of Sciences, and the U.S. National Museum of Natural History. We appreciate the help of V.M. Dziadosz, N.K. Johnson, L.C. Binford and S.L. Olson, from those institutions.

We gratefully thank Judith Bausor Ingram, Bernadene L. Logan and Marilyn C. Smith, who typed the drafts of this manual.

The actual writing and preparation of the manual was funded by a contract from the Office of Biological Services, U.S. Fish and Wildlife Service. Dr. Jay F. Watson of that office worked closely with us and provided much encouragement and assistance.

The manual constitutes the final report of the Pacific Seabird Group's Working Group on Beached Bird Surveys. It is contribution No. 187 of the Point Reyes Bird Observatory.

INDEX TO SPECIES

- Actitis macularia* see SPOTTED SANDPIPER
- Aechmophorus occidentalis* see WESTERN GREBE
- Aethia cristatella* see CRESTED AUKLET
- A. pusilla* see LEAST AUKLET
- A. pygmaea* see WHISKERED AUKLET
- ALBATROSS, BLACK-FOOTED 26, 75, 118
- LAYSAN 26, 76, 118
- SHORT-TAILED 26, 75, 117
- Anas acuta* see PINTAIL
- A. americana* see AMERICAN WIGEON
- A. clypeata* see NORTHERN SHOVELER
- A. crecca* see GREEN-WINGED TEAL
- A. cyanoptera* see CINNAMON TEAL
- A. discors* see BLUE-WINGED TEAL
- A. penelope* see EUROPEAN WIGEON
- A. platyrhynchos* see MALLARD
- A. strepera* see GADWALL
- Anser albifrons* see WHITE-FRONTED GOOSE
- A. caerulescens* see LESSER SNOW GOOSE
- Aphriza virgata* see SURFBIRD
- Arctocephalus townsendi* see GUADALUPE FUR SEAL
- Arenaria interpres* see RUDDY TURNSTONE
- A. melanocephala* see BLACK TURNSTONE

INDEX TO SPECIES (Cont.)

- AUKLET, CASSIN'S 70, 110, 149
 CRESTED 72, 110, 150
 LEAST 70, 110, 150
 PARAKEET 72, 110, 150
 RHINOCEROS 69, 109, 150
 WHISKERED 71, 110, 150
- AVOCET, AMERICAN 44, 99, 133
- Aythya affinis* see LESSER SCAUP
- A. americana* see REDHEAD
- A. marila* see GREATER SCAUP
- A. valisineria* see CANVASBACK
- Balaena mysticetus* see BOWHEAD
- Balaenoptera acutorostrata* see MINKE WHALE
- B. borealis* see SEI WHALE
- B. edeni* see BRYDE'S WHALE
- B. musculus* see BLUE WHALE
- B. physalus* see FIN WHALE
- BELUGA 171, 181
- BOOBY, BLUE-FACED 31, 80, 124-125
 BLUE-FOOTED 31, 80, 125
 BROWN 31-32, 80, 125
 MASKED 31, 124-125
 RED-FOOTED 31-32, 80, 125
- BOWHEAD 168, 180
- Brachyramphus brevirostre* see KITTLITZ'S MURRELET

INDEX TO SPECIES (Cont.)

- B. marmoratus* see MARBLED MURRELET
- BRANT (BLACK) 34, 85, 127
- Branta bernicla* see BRANT
- B. canadensis* see CANADA GOOSE
- Bucephala albeola* see BUFFLEHEAD
- B. clangula* see COMMON GOLDENEYE
- B. islandica* see BARROW'S GOLDENEYE
- BUFFLEHEAD 40, 90, 91, 130
- Calidris acuminata* see SHARP-TAILED SANDPIPER
- C. alba* see SANDERLING
- C. alpina* see DUNLIN
- C. bairdii* see BAIRD'S SANDPIPER
- C. canutus* see RED KNOT
- C. ferruginea* see CURLEW SANDPIPER
- C. fuscicollis* see WHITE-RUMPED SANDPIPER
- C. mauri* see WESTERN SANDPIPER
- C. melanotos* see PECTORAL SANDPIPER
- C. minutilla* see LEAST SANDPIPER
- C. pusilla* see SEMIPALMATED SANDPIPER
- C. ptilocnemis* see ROCK SANDPIPER
- C. ruficollis* see RUFIOUS-NECKED SANDPIPER
- Callorhinus ursinus* see NORTHERN FUR SEAL
- CANVASBACK 37, 88, 89, 129
- Capella gallinago* see COMMON SNIPE
- Catharacta maccormicki* see SKUA (cf.) SOUTH POLAR SKUA

INDEX TO SPECIES (Cont.)

- Catoptrophorus semipalmatus* see WILLET
- Cephus columba* see PIGEON GUILLEMOT
- C. grulle* see BLACK GUILLEMOT
- Cerorhinca monocerata* see RHINOCEROS AUKLET
- Charadrius alexandrinus* see SNOWY PLOVER
- C. montanus* see MOUNTAIN PLOVER
- C. semipalmatus* see SEMIPALMATED PLOVER
- C. vociferus* see KILLDEER
- C. wilsonia* see WILSON'S PLOVER
- Chen rossii* see ROSS' GOOSE
- Chlidonias nigra* see BLACK TERN
- Clangula hyemalis* see OLDSQUAW
- COOT, AMERICAN 4, 20, 95, 114, 132
- CORMORANT, BRANDT'S 33, 81, 82, 113, 125
- DOUBLE-CRESTED 32, 33, 81, 82, 125
- PELAGIC 33, 81, 82, 126
- RED-FACED 32, 33, 81, 126
- CURLEW, BRISTLE-THIGHED 44, 99, 135
- LONG-BILLED 44, 99, 135
- Cyclorhynchus psittacula* see PARAKEET AUKLET
- Daption capense* see CAPE PETREL
- Delphinapterus leucas* see BELUGA
- Delphinus delphis* see COMMON DOLPHIN
- Diomedea albatrus* see SHORT-TAILED ALBATROSS
- D. immutabilis* see LAYSAN ALBATROSS

INDEX TO SPECIES (Cont.)

D. nigripes see BLACK-FOOTED ALBATROSS

DOLPHIN, BOTTLENOSE 175, 182

COMMON 175, 182

NORTHERN RIGHT WHALE 173, 182

PACIFIC WHITE-SIDED 175, 182

RISSE'S 173, 182

ROUGH-TOOTHED 174, 182

SPOTTED 175, 182

STRIPED 175, 182

DOVER, ROCK 4, 125

DOWITCHER, LONG-BILLED 45, 98, 137

SHORT-BILLED 45, 98, 137

DUCK, HARLEQUIN 36, 37, 90, 91, 130

RUDDY 35, 90, 91, 132

DUNLIN 43, 49, 100, 139

EGRETS 4

EIDER, COMMON 37, 38, 93, 94, 131

KING 37, 38, 93, 94, 131

SPECTACLED 37, 38, 93, 94, 131

STELLER'S 36, 93, 94, 130

Endomychura craveri see CRAVERI'S MURRELET

E. hypoleuca see XANTUS' MURRELET

Enhydra lutris lutris see NORTHERN SEA OTTER

E. l. nereis see SOUTHERN SEA OTTER

Erignathus barbatus see BEARDED SEAL

Eschrichtius robustus see CALIFORNIA GRAY WHALE

INDEX TO SPECIES (Cont.)

- Eubalaena glacialis* see NORTHERN RIGHT WHALE
- Eumetopias jubatus* see NORTHERN SEA LION
- FLAMINGOES 4
- Fratercula corniculata* see HORNED PUFFIN
- Fregata magnificens* see MAGNIFICENT FRIGATEBIRD
- FRIGATEBIRD, MAGNIFICENT 17, 76, 126
- Fulica americana* see AMERICAN COOT
- FULMAR, NORTHERN 29, 77, 101, 112, 118-119
- SILVER-GRAY 118
- Fulmarus glacialis* see NORTHERN FULMAR
- FUR SEAL, GUADALUPE 164, 165, 177, 178
- NORTHERN 164, 165, 177, 178
- GADWALL 40, 86, 87, 128
- Gavia adamsii* see YELLOW-BILLED LOON
- G. arctica* see ARCTIC LOON
- G. immer* see COMMON LOON
- G. stellata* see RED-THROATED LOON
- Gelochelidon nilotica* see GULL-BILLED TERN
- Globicephala macrorhynchus* see SHORT-FINNED PILOT WHALE
- GODWIT, BAR-TAILED 44, 99, 134
- MARBLED 44, 99, 134
- GOLDENEYE, BARROW'S 39, 90, 91, 130
- COMMON 39, 40, 90, 91, 130
- GOOSE, BLUE 35, 127
- CANADA 34, 85, 127
- EMPEROR 35, 85, 127

INDEX TO SPECIES (Cont.)

- LESSER CANADA 85
 LESSER SNOW 34, 84, 127
 ROSS' 34, 84, 127
 WHITE-FRONTED 35, 85, 127
Grampus griseus see RISSO'S DOLPHIN
 GREBE, EARED 26, 74, 117
 HORNED 25, 74, 117
 PIED-BILLED 25, 74, 117
 RED-NECKED 25, 74, 117
 WESTERN 25, 74, 114, 116
 GUILLEMOT, BLACK 66, 108, 148
 PIGEON 69, 108, 113, 148
 GULL, BLACK-HEADED 51, 54, 105, 143
 BONAPARTE'S 52, 53, 105, 143
 CALIFORNIA 56, 59, 60, 103, 142
 FRANKLIN'S 52, 54, 105, 143
 GLAUCOUS 4, 61, 102, 140
 GLAUCOUS-WINGED 4, 55, 57, 58, 102, 141
 HEERMAN'S 60, 103, 144
 HERRING 4, 56, 59, 60, 103, 142
 IVORY 51, 55, 104, 144
 LAUGHING 53, 105, 143
 LESSER BLACK-BACKED 142
 LITTLE 54, 105, 143
 MEW 56, 57, 104, 143
 RING-BILLED 56, 57, 104, 143

INDEX TO SPECIES (Cont.)

- ROSS' 52, 53, 105, 144
- SABINE'S 53, 54, 105, 144
- SLATY-BACKED 55, 59, 141
- THAYER'S 4, 56-60, 103, 142
- WESTERN 4, 56, 58-60, 102, 112, 141
- YELLOW-FOOTED WESTERN 56, 59, 60, 142
- Haematopus bachmani* see BLACK OYSTERCATCHER
- H. palliatus* see AMERICAN OYSTERCATCHER
- Halocyptena microsoma* see LEAST STORM PETREL
- HERONS 4
- Heteroscelus incanum* see WANDERING TATTLER
- Himantopus mexicanus* see BLACK-NECKED STILT
- Histrionicus histrionicus* see HARLEQUIN DUCK
- HUMPBACK 168, 180
- JAEGER, LONG-TAILED 50, 101, 139-140
- PARASITIC 50, 101, 139-140
- POMARINE 50, 101, 139-140
- KILLDEER 47, 96, 134
- KITTAWAKE, BLACK-LEGGED 53, 54, 104, 144
- RED-LEGGED 54, 104, 144
- KNOT, RED 48, 100, 137
- Kogia breviceps* see PYGMY SPERM WHALE
- K. simus* see DWARF SPERM WHALE
- Lagenorhynchus obliquidens* see PACIFIC WHITE-SIDED DOLPHIN
- Larus argentatus* see HERRING GULL
- L. atricilla* see LAUGHING GULL

INDEX TO SPECIES (Cont.)

- L. californicus* see CALIFORNIA GULL
- L. canus* see MEW GULL
- L. delawarensis* see RING-BILLED GULL
- L. fuscus* see LESSER BLACK-BACKED GULL
- L. glaucescens* see GLAUCOUS-WINGED GULL
- L. heermanni* see HEERMAN'S GULL
- L. pipixcan* see FRANKLIN'S GULL
- Larus hyperboreus* see GLAUCOUS GULL
- L. minutus* see LITTLE GULL
- L. occidentalis* see WESTERN GULL
- L. o. livens* see YELLOW-FOOTED WESTERN GULL
- L. philadelphia* see BONAPARTE'S GULL
- L. ridibundus* see BLACK-HEADED GULL
- L. schistisagus* see SLATY-BACKED GULL
- L. thayeri* see THAYER'S GULL
- Limnodromus griseus* see SHORT-BILLED DOWITCHER
- L. scolopaceus* see LONG-BILLED DOWITCHER
- Limosa fedoa* see MARBLED GODWIT
- L. lapponica* see BAR-TAILED GODWIT
- Lissodelphis borealis* see NORTHERN RIGHT WHALE DOLPHIN
- Lobipes lobatus* see NORTHERN PHALAROPE
- LOON, ARCTIC 24, 74, 111, 116
- COMMON 24, 73, 115
- RED-THROATED 24, 74, 116
- YELLOW-BILLED 24, 73, 116

INDEX TO SPECIES (Cont.)

Lunda cirrhata see TUFTED PUFFIN

MALLARD 41, 86, 87, 128

Megaptera novaeangliae see HUMPBACK

Melanitta deglandi see WHITE-WINGED SCOTER

M. nigra see BLACK SCOTER

M. perspicillata see SURF SCOTER

MERGANSER, COMMON 39, 95, 132

RED-BREASTED 39, 95, 132

Mergus merganser see COMMON MERGANSER

M. serrator see RED-BREASTED MERGANSER

Mesoplodon spp. see BEAKED WHALES and BOTTLENOSE WHALES

Mirounga angustirostris see NORTHERN ELEPHANT SEAL

Monodon monoceros see NARWHAL

MURRE, COMMON 66, 67, 70-71, 108, 110, 148

THICK-BILLED 66, 70-71, 108, 148

MURRELET, ANCIENT 68, 70, 110, 148-149

CRAVERI'S 71, 110, 148-149

KITTLITZ'S 71, 110, 148-149

MARbled 71-72, 110, 148-149

XANTUS' 68, 70, 110, 148-149

NARWHAL 173, 181

Numenius americanus see LONG-BILLED CURLEW

N. phaeopus see WHIMBREL

N. tahitiensis see BRISTLE-THIGHED CURLEW

Oceanites oceanicus see WILSON'S STORM PETREL

Oceanodroma castro see HARCOURT'S STORM PETREL

O. furcata see FORK-TAILED STORM PETREL

INDEX TO SPECIES (Cont.)

- O. homochroa* see ASHY STORM PETREL
- O. leucorhoa* see LEACH'S STORM PETREL
- O. melania* see BLACK STORM PETREL
- O. tethys* see GALAPAGOS STORM PETREL
- Odobenus rosmarus* see WALRUS
- OLDSQUAW 35, 36, 90, 91, 130
- Olor buccinator* see TRUMPETER SWAN
- O. columbianus* see WHISTLING SWAN
- Orcinus orca* see KILLER WHALE
- Oxyura jamaicensis* see RUDDY DUCK
- OYSTERCATCHER, AMERICAN 42, 97, 132
- BLACK 42, 97, 114, 132
- Pagophila eburnea* see IVORY GULL
- Pelecanus erythrorhynchos* see WHITE PELICAN
- P. occidentalis* see BROWN PELICAN
- PELICAN, BROWN 17, 124
- WHITE 17, 124
- PETREL, CAPE 28, 77, 118
- COOK'S 77, 121
- SCALED (MOTTLED) 28, 77, 121
- Phaethon aethereus* see RED-BILLED TROPICBIRD
- Phalacrocorax auritus* see DOUBLE-CRESTED CORMORANT
- P. pelagicus* see PELAGIC CORMORANT
- P. penicillatus* see BRANDT'S CORMORANT
- P. urile* see RED-FACED CORMORANT

INDEX TO SPECIES (Cont.)

PHALAROPE, NORTHERN 47, 48, 97, 136

RED 47, 48, 97, 114, 136

WILSON'S 45, 97, 136

Phalaropus fulicarius see RED PHALAROPE

Philacte canagica see EMPEROR GOOSE

Phoca fasciata see RIBBON SEAL

P. hispida see RINGED SEAL

P. largha see LARGHA SEAL

P. vitulina see HARBOR SEAL

Phocoenoides dalli see DALL'S PORPOISE

Phocoena phocoena see HARBOR PORPOISE

Physeter catodon see SPERM WHALE

PIGEONS 4, 145

PILOT WHALE, SHORT-FINNED 174, 182

PINTAIL 41, 86, 87, 128

PLOVER, AMERICAN GOLDEN 45, 96, 133

BLACK-BELLIED 42, 46, 96, 133

MOUNTAIN 48, 96, 134

SEMIPALMATED 47, 96, 133

SNOWY 48, 96, 134

WILSON'S 49, 96, 134

Pluvialis dominica see AMERICAN GOLDEN PLOVER

P. squatarola see BLACK-BELLIED PLOVER

Podiceps auritus see HORNED GREBE

P. grisegena see RED-NECKED GREBE

P. nigricollis see EARED GREBE

INDEX TO SPECIES (Cont.)

- Podilymbus podiceps* see PIED-BILLED GREBE
- Polystiata stelleri* see STELLER'S EIDER
- PORPOISE, DALL'S 174, 183
HARBOR 175, 183
- Pseudorca crassidens* see FALSE KILLER WHALE
- Pterodroma cookii* see COOK'S PETREL
- P. inexpectata* see SCALED (MOTTLED) PETREL
- Ptychoramphus aleuticus* see CASSIN'S AUKLET
- PUFFIN, HORNED 69, 108, 109, 150
TUFTED 69, 109, 150
- Puffinus bulleri* see BULLER'S SHEARWATER
- P. carneipes* see FLESH-FOOTED SHEARWATER
- P. creatopus* see PINK-SHEARWATER
- P. griseus* see SOOTY SHEARWATER
- Puffinus leucomelas* see STREAKED SHEARWATER
- P. puffinus* see COMMON (MANX) SHEARWATER
- P. p. opisthomelas* see BLACK-VENTED SHEARWATER
- P. p. townsendi* see TOWNSEND'S SHEARWATER
- P. tenuirostris* see SHORT-TAILED SHEARWATER
- RAILS 4
- Recurvirostra americana* see AMERICAN AVOCET
- REDHEAD 37, 88, 89, 129
- Rhodostethia rosea* see ROSS' GULL
- Rissa brevirostris* see RED-LEGGED KITTIWAKE
- R. tridactyla* see BLACK-LEGGED KITTIWAKE

INDEX TO SPECIES (Cont.)

- Rynchops nigra* see BLACK SKIMMER
- SANDERLING 47, 48, 100, 137
- SANDPIPER, BAIRD'S 49, 100, 138
- CURLEW 49, 100, 139
- LEAST 50, 100, 137-138
- PECTORAL 43, 46, 100, 138
- ROCK 49, 100, 139
- RUFOUS-NECKED 50, 100, 137-138
- SEMIPALMATED 50, 100, 137-138
- SHARP-TAILED 46, 100, 138
- SPOTTED 46, 98, 135
- WESTERN 50, 100, 137-138
- WHITE-RUMPED 49, 100, 138
- SCAUP, GREATER 38, 88, 89, 129
- LESSER 38, 88, 89, 129
- SCOTER, BLACK 36, 92, 94, 131
- SURF 36, 92, 94, 113, 131
- WHITE-WINGED 39, 92, 94, 131
- SEA LION, CALIFORNIA 158, 162, 163, 164, 177, 178
- NORTHERN 162, 163, 164, 176, 178
- STELLER 162, 163, 164, 176, 178
- SEA OTTER, NORTHERN 167, 179
- SOUTHERN 167, 177, 179
- SEAL, BEARDED 165, 177, 179
- GUADALUPE FUR 164, 165, 177, 178
- HARBOR 166, 167, 177, 179

INDEX TO SPECIES (Cont.)

- LARGHA 167, 179
- NORTHERN ELEPHANT 157, 165, 176, 179
- NORTHERN FUR 164, 165, 177, 178
- RIBBON 166, 179
- RINGED 166, 177, 179
- SPOTTED 179
- SHEARWATER, BLACK-VENTED 121
- BULLER'S 29, 78, 119
- COMMON 29, 78, 120
- FLESH-FOOTED 30, 78, 119
- MANX (COMMON) 29, 78, 120
- NEW ZEALAND 29, 78, 119
- PINK-FOOTED 30, 78, 119
- SHORT-TAILED 30, 77, 78, 120
- SOOTY 30, 78, 120
- STREAKED 30, 120
- TOWNSEND'S 121
- SHOVELER, NORTHERN 40, 88, 89, 129
- SKIMMER, BLACK 62, 106, 147
- SKUA (SOUTH POLAR) 7, 50, 101, 112, 139-140
- SNIPE, COMMON 45, 98, 136
- Somateria fischeri* see SPECTACLED EIDER
- S. mollissima* see COMMON EIDER
- S. spectabilis* see KING EIDER
- Steganopus tricolor* see WILSON'S PHALAROPE
- Stenella* spp. see SPOTTED and STRIPED DOLPHINS
- Steno bredanensis* see ROUGH-TOOTHED DOLPHIN

INDEX TO SPECIES (Cont.)

Stercorarius longicaudus see LONG-TAILED JAEGER

S. parasiticus see PARASITIC JAEGER

S. pomarinus see POMARINE JAEGER

Sterna albifrons see LEAST TERN

S. aleutica see ALEUTIAN TERN

S. caspia see CASPIAN TERN

S. elegans see ELEGANT TERN

S. forsteri see FORSTER'S TERN

S. fuscata see SOOTY TERN

S. hirundo see COMMON TERN

S. maxima see ROYAL TERN

S. paradisaea see ARCTIC TERN

STILT, BLACK-NECKED 42, 99, 133

STORKS 4

STORM PETREL, ASHY 28, 79, 122-123

BLACK 27, 79, 122

FORK-TAILED 27, 77, 79, 122

GALAPAGOS 27, 79, 123

HARCOURT'S 28, 79, 123

LEACH'S 28, 79, 123

LEAST 28, 79, 123

WILSON'S 27, 79, 123

Sula dactylatra see BLUE-FACED BOOBY

S. leucogaster see BROWN BOOBY

S. nebouxi see BLUE-FOOTED BOOBY

S. sula see RED-FOOTED BOOBY

INDEX TO SPECIES (Cont.)

SURFBIRD 48, 97, 137

SWAN, TRUMPETER 34, 83, 126

WHISTLING 34, 83, 126

Synthliboramphus antiquum see ANCIENT MURRELET

TATTLER, WANDERING 45, 98, 136

TEAL, BLUE-WINGED 40, 86, 87, 129

CINNAMON 40, 41, 86, 87, 129

GREEN-WINGED 41, 86, 87, 128

TERN, ALEUTIAN 64, 107, 146

ARCTIC 65, 107, 145-146

BLACK 62, 107, 114, 147

CASPIAN 63, 106, 147

COMMON 64, 107, 145-146

ELEGANT 63, 106, 146

FORSTER'S 64, 107, 145-146

GULL-BILLED 63, 107, 145

LEAST 64, 107, 146

ROYAL 63, 106, 146

SOOTY 62, 107, 146

Tringa flavipes see LESSER YELLOWLEGS

T. melanoleuca see GREATER YELLOWLEGS

TROPICBIRD, RED-BILLED 21, 76, 123-124, 147

TURNSTONE, BLACK 46, 97, 136

RUDDY 43, 46, 97, 136

Tursiops truncatus see BOTTLENOSE DOLPHIN

INDEX TO SPECIES (Cont.)

- Uria aalge* see COMMON MURRE
U. lomvia see THICK-BILLED MURRE
WALRUS 160, 178
WHALE, BEAKED 170-171, 181
 (BELUGA) 171, 181
 BLUE 169, 180
 BOTTLENOSE 171, 181
 (BOWHEAD) 168, 180
 BRYDE'S 169, 180
 CALIFORNIA GRAY 168, 180
 DWARF SPERM 170, 181
 FALSE KILLER 174, 182
 FIN 169, 180
 GOOSE-BEAKED 171, 181
 (HUMPBACK) 168, 180
 KILLER 173, 182
 MINKE 169, 180
 (NARWHAL) 173, 181
 NORTHERN RIGHT 168, 180
 PYGMY SPERM 170, 181
 SEI 169, 180
 SHORT-FINNED PILOT 174, 182
 SPERM 170, 181
WHIMBREL 44, 99, 135

INDEX TO SPECIES (Cont.)

WIGEON, AMERICAN 41, 88, 89, 129

EUROPEAN 129

WILLET 42, 46, 98, 135

Xema sabini see SABINE'S GULL

YELLOWLEGS, GREATER 44, 45, 98, 135

LESSER 45, 98, 135

Zalophus californianus see CALIFORNIA SEA LION

Ziphius cavirostris see GOOSE-BEAKED WHALE





1
2
3
4
5
6
7
8
9
10
11
12
13
14
15
16
17
18
19
20
21