



THE
Bee-Keepers' Guide;

OR

MANUAL OF THE APIARY,

BY

A. J. COOK,

Professor of Entomology

IN THE

MICHIGAN STATE AGRICULTURAL COLLEGE.

EIGHTH EDITION,

REVISED, ENLARGED, MOSTLY RE-WRITTEN AND
BEAUTIFULLY ILLUSTRATED.

TENTH THOUSAND.

LANSING, MICHIGAN,

1883.

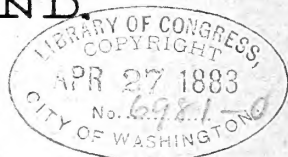

SF523
.C77

Entered according to Act of Congress, in the year 1883, by
ALBERT J. COOK,
In the Office of the Librarian of Congress, at Washington, D. C.

PRINTED BY MYERS BROS., COLUMBUS, OHIO.

TO THE
REVEREND L. L. LANGSTROTH,
THE
INVENTOR OF THE MOVABLE FRAME HIVE,
THE
HUBER OF AMERICA, AND ONE OF THE GREATEST
MASTERS OF PURE AND APPLIED SCIENCE, AS
RELATING TO APICULTURE, IN THE WORLD;
THIS MANUAL IS GRATEFULLY DEDICATED
BY
THE AUTHOR.



PREFACE.

In 1876, in response to a desire frequently expressed by my apiarian friends, principally my students, I published an edition of 3,000 copies of the little unpretending "Manual of the Apiary." This was little more than the course of lectures which I gave annually at the College. In less than two years this was exhausted, and the second edition, enlarged, revised, and much more fully illustrated, was issued. So great was the sale that in less than a year this was followed by the third and fourth editions, and, in less than two years, the fifth edition (seventh thousand) was issued.

In each of the two following years, another edition was demanded. In each of these editions the book has been enlarged, changes made and illustrations added, that the work might keep pace with our rapidly advancing art.

So great has been the demand for this work, not only at home and in Europe, but even in more distant lands, and so great has been the progress of apiculture—so changed the views and methods of our best bee-keepers, that the author

feels warranted in thoroughly revising and entirely recasting this eighth edition (tenth thousand). Not only is the work re-written, but much new matter, and many new and costly illustrations are added.

In this edition, the author also assumes the duties of publisher. In bidding adieu to the old publisher, I wish publicly to express my high appreciation, and deep sense of obligation for the able manner in which Mr. Newman has performed his share of the work. I shall still hope for his wise counsel and advice, from which I shall surely profit in the future as in the past. For this, as also for the able opinions of many other of the first apiarists of America and Europe, I wish to express most grateful acknowledgments.

It is the desire and determination of the author that this work shall continue to be the exponent of the most improved apiculture; and no pains will be spared, that each succeeding edition may embody the latest improvements and discoveries wrought out by the practical man and the scientist, as gleaned from the excellent home and foreign apiarian and scientific periodicals.

A. J. COOK.

State Agricultural College, Lansing, Mich., April, 1883.

CONTENTS.

INTRODUCTION.

	PAGE
Who May Keep Bees	1
Specialists.....	1
Amateurs.....	1
Who are Specially Interdicted.....	2
Inducements to Bee-Keeping	2
Recreation	2
Profits	3
Excellence as an Amateur Pursuit	3
Adaptation to Women	5
Improves the Mind and the Observation	7
Yields Delicious Food.....	7
Adds to the Nation's Wealth.....	8
What Successful Bee-keeping Requires.....	8
Mental Effort	8
Experience Necessary.....	8
Learn from Others.....	9
Aid From Conventions	9
Aid from Bee Publications	9
American Bee Journal.....	9
Gleanings in Bee Culture.....	10
Bee-Keepers' Magazine.....	11
Bee-Keepers' Exchange.....	11
Bee-Keepers' Guide.....	11
Kansas Bee-Keeper.....	11
The California Apiarist	11
Books for the Apiarist	11
Langstroth on the Honey-Bee.....	11
Quinby's Mysteries of Bee-Keeping.....	12
King's Text-Book.....	12
A B C of Bee Culture.....	12

	PAGE
Character of the Hive.....	122
The Bottom Board.....	125
The Alighting Board.....	126
The Cover of the Hive.....	127
The Frames.....	130
How to Construct the Frames.....	132
A Block for making Frames.....	134
Cover for Frames.....	135
Division Board.....	136
The Huber Hive.....	137
Observing Hive.....	141
Apparatus for Procuring Comb Honey.....	141
Surplus Comb Honey in Sections.....	142
Requisites of Good Sections.....	142
Description.....	142
How to place Sections in Position.....	145
Sections in Frames.....	145
Foot Power Saw.....	150
CHAPTER VI.	
Position and Arrangement of Apiary.....	152
Position.....	152
Arrangement of Grounds.....	152
Preparation for each Colony.....	153
CHAPTER VII.	
To Transfer Bees.....	158
The Old Method.....	159
Hunting Bee-Trees.....	162
CHAPTER VIII.	
Feeding and Feeders.....	163
How much to Feed.....	163
What to Feed.....	164
How to Feed.....	164
Smith Feeder.....	167
CHAPTER IX.	
Queen Rearing.....	169
How to Rear Queens.....	169
Nuclei.....	172
Queen Lamp Nursery.....	176

	PAGE
Shall we Clip the Queen's Wing?.....	177
Fertile Workers.....	179
Queen Register, or Apiary Register.....	180

CHAPTER X.

Increase of Colonies.....	182
Swarming.....	182
Hiving Swarms.....	185
To Prevent Second Swarms.....	188
To Prevent Swarming.....	188
How to Multiply Colonies with the best Results.....	189
Divide.....	190
How to Divide.....	192

CHAPTER XI.

Italians and Italianizing.....	192
The new Races of Bees.....	196
What Bees shall we Keep?.....	196
How to Italianize.....	196
How to Introduce a Queen.....	196
Valentine's Comb Stand.....	200
To get our Italian Queens.....	201
To Ship Queens.....	202
Viallon Candy.....	203
The Good Candy.....	203
Preparations to Ship.....	204
To Move Colonies.....	204

CHAPTER XII.

Extracting, and the Extractor.....	205
Honey Extractor.....	205
Use of Extractor.....	208
When to use the Extractor.....	209
How to Extract.....	211
To Keep Extracted Honey.....	212

CHAPTER XIII.

Working for Comb Honey.....	214
Points to Consider.....	214
To Secure Strong Colonies.....	214
To avoid the Swarming Fever.....	215

	PAGE
Adjustment of Sections	216
Getting Bees into Sections.....	216
Removal of Sections.....	217
CHAPTER XIV.	
Handling Bees.....	218
The Best Bee-Veil.....	219
To quiet Bees.....	220
Bellows Smoker	221
The Quinby Smoker	222
Chloroform	223
To Cure Stings.....	223
The Sweat Theory.....	224
The Bee-Tent.....	224
CHAPTER XV.	
Comb Foundation.....	226
History	226
American Foundation.....	227
The Press for Foundation.....	229
How Foundation is Made.....	230
To Secure Wax	230
Use of Foundation.....	231
To fasten the Foundation	233
Wired Frames.....	235
Methods	236
CHAPTER XVI.	
Marketing Honey.....	239
How to invigorate the Market.....	239
Preparation for Market.....	240
Extracted Honey.....	240
How to Tempt the Consumer.....	241
Comb-Honey.....	243
Rules to be Observed.....	243
Marketing Bees.....	245
Selling Queens.....	245
Selling Bees by the Pound.....	246
Vinegar from Honey.....	246
Fairs and the Market.....	246
What Should we Have?	247
Effects of Such Exhibits.....	248

CHAPTER XVII.

	PAGE
Honey Plants.....	249
Real Honey Dew.....	252
Sweet Sap and Juices.....	253
What are the Valuable Honey Plants?	254
Description with Practical Remarks.....	258
March Plants.....	259
April Plants.....	259
May Plants.....	261
June Plants.....	266
July Plants.....	278
August and September Plants.....	288
Books on Botany.....	291
Practical Conclusions.....	291

CHAPTER XVIII.

Wintering Bees.....	293
The causes of Disastrous Wintering.....	293
The Requisite to Safe Wintering—Good Food.....	294
Secure Late Breeding.....	295
To Secure and Maintain the Proper Temperature.....	296
Box for Packing.....	296
Chaff Hives.....	298
Rules for Their Use	299
Wintering in Bee House.....	300
Wintering in Cellar.....	301
Burying Bees, or Clamps.....	303
Spring Dwindling.....	304

CHAPTER XIX.

The House Apiary and Bee House.....	305
Bee Houses	305

CHAPTER XX.

Evils That Confront the Apiarist.....	308
Robbing.....	308
Disease.....	309
Foul Brood.....	309
Remedies	311
Enemies of Bees.....	312
The Bee Moth.....	312
History.....	315
Remedies.....	316

	PAGE
Two Destructive Beetles.....	317
Robber Flies.....	317
The Stinging Bug.....	321
Bee-Hawk.....	324
Tachina Fly.....	325
Bee-Louse.....	325
Ants.....	327
The Cow-Killer.....	328
The Praying Mantis.....	328
• Blister Beetles.....	329
Wasps.....	330
Spiders.....	330
The King Bird.....	330
The Toads.....	331
Mice.....	331
Shrews.....	332

CHAPTER XXI.

Calendar and Axioms.....	333
Work for Different Months.....	333
January.....	333
February.....	333
March.....	333
April.....	334
May.....	334
June.....	334
July.....	334
August.....	334
September.....	335
October.....	335
November.....	335
December.....	335
Axioms.....	336

INTRODUCTION.

WHO MAY KEEP BEES.

SPECIALISTS.

Any person who is cautious, observing, and prompt to do whatever the needs of his business require, with no thought of delay, may make apiculture a specialty with almost certain prospects of success. He must also be willing to work with Spartan energy during the busy season, and must persist, though sore discouragement, and even dire misfortune, essay to thwart his plans and rob him of his coveted gains. I make no mention of capital to begin with, or territory on which to locate; for men of true metal—men whose energy of mind and body bespeak success in advance—will solve these questions long before their experience and knowledge warrant their assuming the charge of large apiaries.

AMATEURS.

Apiculture, as an avocation, may be safely recommended to those of any business or profession who possess the above named qualities and control a little space for their bees, either a yard a few rods from street and neighbor, or a flat roof where hives may securely rest (C. F. Muth, of Cincinnati, keeps his bees very successfully on the top of his store, in the very heart of the city), and who are able to devote a little time, when required, to the care of their bees. The amount of time will of course vary with the number of colonies kept, but with proper management this time may be given at any period of the day or week, and thus not interfere with regular business. Thus residents of country, village, or city, male or female, who may wish to associate with and study natural objects, and add to

their income and pleasure, will find here an ever waiting opportunity. To ladies, shut out from fresh air and sunshine till pallor and languor point sadly to departing health and vigor, and to men whose business precludes air and exercise, apiculture cannot be too highly recommended as an avocation.

WHO ARE SPECIALLY INTERDICTED.

There are a few people whose systems seem to be specially susceptible to the poison intruded with the bee's sting. Sometimes such persons, if even stung on the foot, will be so thoroughly poisoned that their eyes will swell so they cannot see, and they will suffer with fever for days, and, very rarely, individuals are so sensitive to this poison that a bee-sting proves fatal. I hardly need say that such people should never keep bees. Many persons, among whom were the noted Klein and Gunther, are at first very susceptible to the poison, but if spurred on by their enthusiasm they persist they will soon become so inoculated that they experience no serious injury from the stings. It is a well-recognized fact that each succeeding sting is less powerful to work harm. Every bee-keeper is almost sure to receive an occasional sting, though with the experienced these are very rare and occasion neither fear nor anxiety.

INDUCEMENTS TO BEE-KEEPING.

RECREATION.

Among the attractive features of apiculture, I mention the pleasure which it offers its votaries. There is a fascination about the apiary which is indescribable. Nature is always presenting the most pleasurable surprises to those on the alert to receive them, and among the insect hosts, especially bees, the instincts and habits are so inexplicable and marvelous that the student of this department of nature never ceases to meet with exhibitions that move him, not less with wonder than with admiration. Thus bee-keeping affords most wholesome recreation, especially to any who love to look upon the book of nature and study the marvelous pages she is ever waiting to present. To such, the very fascination of their pursuit is of itself a rich reward for the time and labor expended. I doubt if there is any other class of manual laborers who engage in

their business, and dwell upon it, with the same fondness as do bee-keepers. Indeed, to meet a scientific bee-keeper is to meet an enthusiast. A thorough study of the wonderful economy of the hive must, from its very nature, go hand-in-hand with delight and admiration. I once asked an extensive apiarist, who was also a farmer, why he kept bees. The answer was characteristic: "Even if I could not make a good deal the most money with my bees, I should still keep them for the real pleasure they bring me." But yesterday I asked the same question of Prof. Daniels, President of the Grand Rapids schools, whose official duties are very severe. Said he: "For the restful pleasure which I receive in their management." I am very sure that were there no other inducement than that of pleasure, I should be slow to part with these models of industry whose marvelous instincts and wondrous life-habits are ever ministering to my delight and astonishment.

Some years since I received a visit from my old friend and college class-mate, O. Clute. We visited the apiary, with which he was much pleased. He took the "Manual" home with him and at once purchased several colonies of bees. This new work brought great pleasure and recreation, which culminated in that most fascinating book, "Blessed Bees." Though a work of fiction, this can but be read with great pleasure and profit, by every person, whether apiarist or not.

PROFITS.

The profits of apiculture urge its adoption as a pursuit. When we consider the comparatively small amount of capital invested and the relatively small amount of labor and expense attending its operations, we are surprised at the abundant reward that is sure to wait upon its intelligent practice. I do not wish to be understood here as claiming that labor—yes, real, hard, back-aching labor—is not required in the apiary. The specialist, with his hundred or more colonies, will have, at certain seasons, hard and vigorous work, but this will be both pleasant and healthful, and will go hand-in-hand with thought, so that brain and muscle will work together. Yet this time of hard, physical labor will only continue for five or six months, and for the balance of the year the apiarist has, or may have, comparative leisure. Nor do I think that all will succeed. The fickle, careless, indolent, heedless man will

as surely fail in apiculture as in any other calling. But I repeat, in the light of many years of experience, where accurate weight, measure, and counting of change exclude all conjecture, that there is no manual labor pursuit where the returns are so large when compared with the labor and expense involved.

An intelligent apiarist may invest in bees any spring, in Michigan, with the absolute certainty of more than doubling his investment the first season; while a net gain of 400 per cent. brings no surprise to the experienced apiarists of our state. This of course applies only to a limited number of colonies. Nor is Michigan superior to other states as a location for the apiarist. During the past season, the poorest I ever knew, our fifteen colonies of bees in the College apiary have netted us over \$200. In 1876, each colony gave a net return of \$24.04, while in 1875, our bees gave a profit, above all expense, of over 400 per cent. of their entire value in the spring. Mr. Fisk Bangs, who graduated at our College one year since, purchased last spring seven colonies of bees. The proceeds of these seven colonies have more than paid all expenses, including first cost of bees, in honey sold, while there are now sixteen colonies as clear gain, if we do not count the labor, and we need hardly do so as it has in no wise interfered with the regular duties of the owner. Several farmers of our state who possess good apiaries and good improved farms, have told me that their apiaries were more profitable than their farms. Who will doubt the profits of apiculture in the face of friend Doolittle's experience? He has realized \$6,000 in five years, simply from the honey taken from fifty colonies. This \$6,000 is in excess of all expenses except his own time. Add to this the increase of stocks, and then remember that one man can easily care for one hundred colonies, and we have a graphic picture of apiarian profits. Bee-keeping made Adam Grimm a wealthy man. It brought to Capt. Hetherington over \$10,000 as the cash receipts of a single year's honey crop. It enabled Mr. Harbison, so it is reported, to ship from his own apiary eleven car-loads of comb-honey as the product of a single season. What greater recommendation has any pursuit? Opportunity for money making, even with hardships and privations, is attractive and seldom disregarded; such opportunity with labor that brings, *in itself*, constant delight, is surely *worthy* of attention.

EXCELLENCE AS AN AMATEUR PURSUIT.

Again, there is no business, and I speak from experience, that serves so well as an avocation. It offers additional funds to the poorly paid, out-door air to the clerk and office-hand, healthful exercise to the person of sedentary habits, and superb recreation to the student or professional man, and especially to him whose life-work is of that dull, hum-drum, routine order that seems to rob life of all zest. The labor required in keeping bees can, with a little thought and management, be so planned, if but few colonies are kept, as not to infringe upon the time demanded by the regular occupation. Indeed, I have never been more heartily thanked than by such persons as named above, because I had called them to consider—which usually means to adopt—the pleasing duties of the apiary.

ADAPTATION TO WOMEN.

Apiculture may also bring succor to those whom society has not been over-ready to favor—our women. Widowed mothers, dependent girls, the weak and the feeble, all may find a blessing in the easy, pleasant and profitable labors of the apiary. Of course, women who lack vigor and health can care for but very few colonies, and must have sufficient strength to bend over and lift the small-sized frames of comb when loaded with honey, and to carry empty hives. With the proper thought and management, full colonies need never be lifted, nor work done in the hot sunshine. Yet right here let me add, and emphasize the truth, *that only those who will let energetic thought and skillful plan, and above all promptitude and persistence, make up for physical weakness, should enlist as apiarists.* Usually a stronger body and improved health, the results of pure air, sunshine and exercise, will make each successive day's labor more easy, and will permit a corresponding growth in the size of the apiary for each successive season. One of the most noted apiarists, not only in America but in the world, sought in bee-keeping her lost health, and found not only health but reputation and influence. Some of the most successful apiarists in our country are women. Of these, many were led to adopt the pursuit because of waning health, grasping at this as the last and successful weapon with which to vanquish the grim monster.

That able apiarist, and terse writer on apiculture, Mrs. L. Harrison, states that the physicians told her that she could not live; but apiculture did for her what the physicians could not do, restored her to health, and gave her such vigor that she has been able to work a large apiary for years.

Said "Cyula Linswik"—whose excellent and beautifully written articles have so often charmed the readers of the bee publications, and who has had five years of successful experience as an apiarist—in a paper read before our Michigan Convention of March, 1877: "I would gladly purchase exemption from in-door work, on washing-day, by two days' labor among the bees, and I find two hours labor at the ironing-table more fatiguing than two hours of the severest toil the apiary can exact." I repeat, that apiculture offers to many women not only pleasure but profit.

Mrs. L. B. Baker, of Lansing, Michigan, who has kept bees very successfully for four years, read an admirable paper before the same Convention, in which she said: "But I can say, having tried both, (keeping boarding-house and apiculture,) I give bee-keeping the preference, as more profitable, healthful, independent and enjoyable. * * * I find the labors of the apiary more endurable than working over a cook-stove in-doors, and more pleasant and conducive to health. * * * I believe that many of our delicate and invalid ladies would find renewed vigor of body and mind in the labors and recreations of the apiary. * * * By beginning in the early spring, when the weather was cool and the work light, I became gradually accustomed to out-door labor, and by midsummer found myself as well able to endure the heat of the sun as my husband, who has been accustomed to it all his life. Previously, to attend an open-air picnic was to return with a head-ache. * * * My own experience in the apiary has been a source of interest and enjoyment far exceeding my anticipations." Although Mrs. Baker commenced with but two colonies of bees, her net profits the first season were over \$100; the second year but a few cents less than \$300; and the third year about \$250. "The proof of the pudding is in the eating;" and such words as those above show that apiculture offers special inducements to our sisters to become either amateur or professional apiarists.

IMPROVES THE MIND AND THE OBSERVATION.

Successful apiculture demands close and accurate observation, and hard, continuous thought and study, and this too, in the wondrous realm of nature. In all this, the apiarist receives manifold and substantial advantages. In the cultivation of the habit of observation, a person becomes constantly more able, useful, and susceptible to pleasure—results which also follow as surely on the habit of thought and study. It is hardly conceivable that the wide-awake apiarist, who is so frequently busy with his wonder-working comrades of the hive, can ever be lonely, or feel time hanging heavily on his hands. The mind is occupied, and there is no chance for *ennui*. The whole tendency of such thought and study, where nature is the subject, is to refine the taste, elevate the desires, and ennoble manhood. Once get our youth, with their susceptible natures, engaged in such wholesome study, and we shall have less reason to fear the vicious tendencies of the street, or the luring vices and damning influences of the saloon. Thus apiculture spreads an intellectual feast that even the old philosophers would have coveted; furnishes the rarest food for the observing faculties, and best of all, by keeping its votaries face to face with the matchless creations of the *All Father*, must draw them toward Him “who went about doing good,” and “in whom there was no guile.”

YIELDS DELICIOUS FOOD.

A last inducement to apiculture, certainly not unworthy of mention, is the offerings it brings to our tables. Health, yea, our very lives, demand that we should eat sweets. It is a truth that our sugars, and especially our commercial syrups, are so adulterated as to be often poisonous. The apiary, in lieu of these, gives us one of the most delicious and wholesome of sweets, which has received merited praise, as food fit for the gods, from the most ancient time till the present day. To ever have within reach the beautiful, immaculate comb, or the equally grateful nectar, right from the extractor, is certainly a blessing of no mean order. We may thus supply our families and friends with a most necessary and desirable food element, and this with no cloud of fear from vile, poisonous adulterations.

ADDS TO THE NATION'S WEALTH.

An excellent authority places the number of colonies of bees in the United States, in 1881, at 3,000,000, and the honey production, for the year, at more than 200,000,000 lbs. The production for that year was not up to the average, and yet the cash value of the year's honey crop exceeds \$30,000,000. We may safely add as much more as the value of the increase of colonies, and we have a grand total of \$60,000,000, nearly enough to pay the interest on the national debt, were the bonds all refunded. And yet all this is but gathered nectar, which would go to waste were it not for the apiarist and his bees. We thus save to the country that which would otherwise be a total loss. Apiculture then, in adding so immensely to the productive capital of the country, is worthy, as an art, to receive the encouragement and fostering care of the State. And the thought that he is performing substantial service to the State, may well add to the pleasure of the apiarist, as he performs his daily round of labor.

WHAT SUCCESSFUL BEE-KEEPING REQUIRES.

MENTAL EFFORT.

No one should commence this business who is not willing to read, think, and study. To be sure, the ignorant and unthinking may stumble on success for a time, but sooner or later failure will set her seal upon their efforts. Those of our apiarists who have studied the hardest, observed the closest, and thought the deepest, have even passed the late terrible winters with but slight loss.

Of course the novice will ask, "How and what shall I study?"

EXPERIENCE NECESSARY.

Nothing will take the place of real experience. Commence with a few colonies, even one or two is best, and make the bees your companions at every possible opportunity. Note every change, whether of the bees, their development, or work, and then by earnest thought strive to divine the cause.

LEARN FROM OTHERS.

Great good will also come from visiting other apiarists. Note their methods and apiarian apparatus. Strive by conversation to gain new and valuable ideas, and gratefully adopt whatever is found, by comparison, to be an improvement upon your own past system and practice.

AID FROM CONVENTIONS.

Attend conventions whenever distance and means render this possible. Here you will not only be made better by social intercourse with those whose occupation and study make them sympathetic and congenial, but you will find a real conservatory of scientific truths, valuable hints, and improved instruments and methods. And the apt attention—rendered possible by your own experience—which you will give to essays, discussions, and private conversations, will so enrich your mind that you will return to your home encouraged and able to do better work, and to achieve higher success. I have attended nearly all the meetings of the Michigan Convention, and never yet when I was not well paid for all trouble and expense by the many, often very valuable, suggestions which I received.

AID FROM BEE PUBLICATIONS.

Every apiarist should take and read at least one of the many excellent bee publications that are issued in our country. It has been suggested that Francis Huber's blindness was an advantage to him, as he thus had the assistance of two pairs of eyes, his wife's and servant's, instead of one. So, too, of the apiarist who reads the bee publications. He has the aid of the eyes, and the brains, of hundreds of intelligent and observing bee-keepers. Who is it that squanders his money on worse than useless patents and fixtures? He who "*cannot afford*" to take a bee-journal.

It would be invidious and uncalled for to recommend any one of these valuable papers to the exclusion of the others. Each has its peculiar excellences, and all who can may well secure all of them to aid and direct their ways.

American Bee Journal.—This, the oldest bee paper, and the only weekly publication devoted exclusively to apiculture in

the world, is not only peculiar for its age, but for the ability with which it has been managed, with almost no exception, even from its first appearance. Samuel Wagner, its founder and long its editor, had few superiors in breadth of culture, strength of judgment, and practical and historic knowledge of apiculture. With what pleasure I remember the elegant, really classic, diction of the editorials, the dignified bearing and freedom from asperities which marked the old *American Bee Journal* as it made its monthly visits fresh from the editorial supervision of Mr. Samuel Wagner. Some one has said that there is something in the very atmosphere of a scholarly gentleman that impresses all who approach him. I have often thought, as memory reverted to the old *Journal*, or as I have re-read the numbers which bear the impress of Mr. Wagner's superior learning, that, though the man is gone, the stamp of his noble character and classical culture is still on these pages, aiding, instructing, elevating, all who are so fortunate as to possess the early volumes of this periodical. I am also happy to state that the *Journal* is again in good hands. Mr. Newman is an experienced editor, and a man of excellent judgment. As an editor he has fought adulteration with great energy, has done much to exalt the honey market, and has given powerful aid in the work of organizing bee-keepers' conventions. He has an active mind and is quick to lay hold of that which will aid the bee-keeper; and when I add that he brings to his editorial aid the most able, experienced, and educated apiarists of the world, I surely have spoken high but just praise of the *American Bee Journal*, whose enviable reputation extends even to distant lands. It is edited by Thomas G. Newman, at Chicago.

Gleanings in Bee Culture.—This periodical makes up for its brief history of six years by the vigor and energy which have characterized it from the first. Its editor is an active apiarist, who is constantly experimenting; a terse, able writer, and brimful of good nature and enthusiasm. I am free to say that in practical apiculture I am more indebted to Mr. Root than to any other one person, except Rev. L. L. Langstroth. I also think that, with few exceptions, he has done more for the recent advancement of practical apiculture than any other person in our country. This sprightly journal is edited by A. I. Root, Medina, Ohio.

Bee-Keepers' Magazine.—I have read this periodical less than the others, and hence know less of it. It is well edited, and certainly has many very able contributors. It is edited by A. J. King, New York City.

Bee-Keepers' Exchange.—The *Exchange* is an able journal. The four years of its life, and the vigor with which it is conducted, give promise not only of permanence, but of influence as one of the moving forces in the future of apicultural progress in this country. It is edited by Houck & Peet, Canajoharie, New York.

Bee-Keepers' Guide.—This paper has been one of the motive powers in the advancement of apiculture for the last few years. It is edited by an experienced bee-keeper, and is doing its part as one of the auxiliaries to apiarian progress in our country. It is edited by A. G. Hill, Kendallville, Indiana.

Kansas Bee-Keeper.—The ability with which this paper is edited, and the able contributions to its pages from many of the first bee-keepers in the country, have given it more than a state circulation, and entitle it justly to a broader name. It is edited by Scovell & Anderson, Columbus, Kansas.

The California Apiarist.—This, though the youngest of our bee-papers, shows the vigor of manhood. It is edited by an experienced bee-keeper, and an able writer, and will certainly meet a felt need among the bee-keepers of the Golden State. Its ability has already pushed it beyond the limits of its own state, and it is exerting a wholesome and valuable influence among the bee-keepers of the East. It is published by the California Apicultural Publishing Co., Oakland, California.

BOOKS FOR THE APIARIST.

Having read very many of the books treating of apiculture, both American and foreign, I can freely recommend such a course to others. Each book has peculiar excellences, and may be read with interest and profit.

Langstroth on the Honey Bee.—This treatise will ever remain a classic in bee-literature. I cannot over-estimate the benefits which I have received from the study of its pages. It was a high, but deserved, encomium, which J. Hunter, of England, in his "Manual of Bee-Keeping," paid to this work: "It is unquestionably the best bee-book in the English language."

The style of this work is so admirable, the subject matter so replete with interest, and the entire book so entertaining, that it is a desirable addition to any library, and no thoughtful, studious apiarist can well be without it. It is especially happy in detailing the methods of experimentation, and in showing with what caution the true scientist establishes principles or deduces conclusions. The work is wonderfully free from errors, and, had the science and practice of apiculture remained stationary, there would have been little need of another work; but as some of the most important improvements in apiculture are not mentioned, the book would be a very unsatisfactory guide to the apiarist of to-day.

Quinby's Mysteries of Bee-Keeping.—This is a plain, sensible treatise, written by one of America's most successful bee-keepers. The work has just been revised by L. C. Root, who has fully maintained its excellent character. The admirable style and eminent practicality of this work have lost nothing in the revision. Mr. Root is the son-in-law of the late Mr. Quinby, and was fully advised of the latest views and discoveries of the great bee-keeper. To these he has added the rich results of his own experience, as well as the latest discoveries and methods of the most progressive apiarists.

King's Text-book.—This work is plain, explicit, fresh, and, partly owing to its cheapness, has had, certainly, next to Langstroth's work, the largest sale of any book of its kind in the country. It has been, therefore, especially in former years, one of the very first agencies in developing and furthering the interests of bee-keepers. It is not so full as my own work, Langstroth's, Quinby's, or the "A B C of Bee Culture," but it is an excellent compendium of the art of bee-keeping.

A B C of Bee-Culture.—This work is by the editor of *Gleanings in Bee Culture*. It is arranged in the convenient form of our cyclopedias, is printed in fine style, on beautiful paper, and is well illustrated. I need hardly say that the style is pleasing and vigorous. The subject matter is fresh, and embodies the most recent discoveries and inventions pertaining to bee-keeping. That it may be kept abreast of apiarian progress, the type is to be kept in position, so that each new discovery may be added as soon as made.

Bees and Honey.—This work is by the editor of the *American Bee Journal*. It is smaller than others, but contains an epitome

of the science and art of bee-culture. Like all of the other works it has its peculiar excellences, and may well find a place in the library of every progressive apiarist.

Blessed Bees.—This fascinating romance is full of practical information, and contagious enthusiasm.

FOREIGN PUBLICATIONS.

The *British Bee Journal*, as the exponent of apiarian methods and practices, is interesting and valuable to American bee-keepers. It shows that in many things, as in the method of organizing and conducting conventions, so as to make them highly conducive to apicultural progress, we have much to learn from our brothers in Britain.

FOREIGN BOOKS.

Bevan, revised, though but little changed, by Munn, is exceedingly interesting, and shows by its able historical chapters, admirable scientific disquisitions, and frequent quotations and references to practical and scientific writers on bees and bee-keeping, both ancient and modern, that the writers were men of extensive reading and great scientific ability. The book is of no practical value to us, but by the student it will be read with great interest. "*The Apiary, or Bees, Bee-Hives, and Bee Culture,*" by Alfred Neighbour, London, is a fresh, sprightly little work, and as the third edition has just appeared, is, of course, up with the times. The book is in nice dress, concise, and very readable, and I am glad to commend it. A less interesting work, though by no means without merit, is the "*Manual of Bee-Keeping,*" by the late John Hunter, London. This is also recent. The "*Bee-Keeper's Guide Book,*" by Tho. Wm. Cowen, is a small book of considerable merit. A still smaller work, styled "*Modern Bee-Keeping,*" is published under the control of the British Bee-Keepers' Association. This is one of the latest books, and would be valued by every bee-keeper. The work that will find the largest sale with us of any of the foreign books, is Dzierzon's "*Rational Bee-Keeping,*" which has just been translated into English. As presenting to American readers the practices and methods of German bee-keepers, and as the work of one of the great masters, the Langstroth of Germany, it can but find a warm welcome on this side the Atlantic.

As practical guides, I think these foreign works would receive little favor among American apiarists. They are the exponents of foreign apiculture, which in method would seem clumsy to Americans. In fact, I think I may say that in implements, and perhaps I may add methods, the English, French, Germans, and Italians, are behind our American apiarists, and hence their text-books and journals compare illy with ours. I believe the many intelligent foreign apiarists who have come to this country and are now honored members of our own fraternity, will sustain this position. *Foreign scientists* are ahead of American, but we glean and utilize their facts and discoveries as soon as made known. Salicylic acid is discovered by a German to be a remedy for foul brood, yet ten times as many American as foreign apiarists know of this and profit by the knowledge. In practical fields, on the other hand, as also in skill and delicacy of invention, we are, I think, in advance. So our apiarists have little need to go abroad for either books or papers.

PROMPTITUDE.

Another absolute requirement of successful bee-keeping, is prompt attention to all its varied duties. Neglect is the rock on which many bee-keepers, especially farmers, find too often that they have wrecked their success. I have no doubt that more colonies die from starvation than from all the bee maladies known to the bee-keeper. And why is this? Neglect is the apicide. I feel sure that the loss each season by absconding colonies is almost incalculable, and what must we blame? Neglect. The loss every summer by enforced idleness of queen and workers, just because room is denied them, is very great. Who is the guilty party? Plainly, neglect. If we would be successful, promptitude must be our motto. Each colony of bees requires but very little care and attention. Our every interest demands that this be not denied, nor even granted grudgingly. The very fact that this attention is slight, renders it more liable to be neglected; but this neglect always involves loss—often disaster.

ENTHUSIASM.

Enthusiasm, or an ardent love of its duties, is a very desirable, if not an absolute, requisite to successful apiculture.

To be sure, this is a quality whose growth, with even slight opportunity, is almost sure. It only demands perseverance. The beginner, without either experience or knowledge, may meet with discouragements—unquestionably will. Swarms will be lost, colonies will fail to winter, and the young apiarist will become nervous, which fact will be noted by the bees with great disfavor, and, if opportunity permits, will meet reproof more sharp than pleasant. Yet, with PERSISTENCE, all these difficulties quickly vanish. Every contingency will be foreseen and provided against, and the myriad of little workers will become as manageable and may be fondled as safely as a pet dog or cat, and the apiarist will minister to their needs with the same fearlessness and self-possession that he does to his gentlest cow or favorite horse. *Persistence in the face of all those discouragements which are so sure to confront inexperience, will surely triumph.* In sooth, he who appreciates the beautiful and marvelous, will soon grow to love his companions of the hive, and the labor attendant upon their care and management. Nor will this love abate till it has kindled into enthusiasm.

True, there may be successful apiarists who are impelled by no warmth of feeling, whose superior intelligence, system, and promptitude, stand in lieu of and make amends for absence of enthusiasm. Yet I believe such are rare, and certainly they work at great disadvantage.

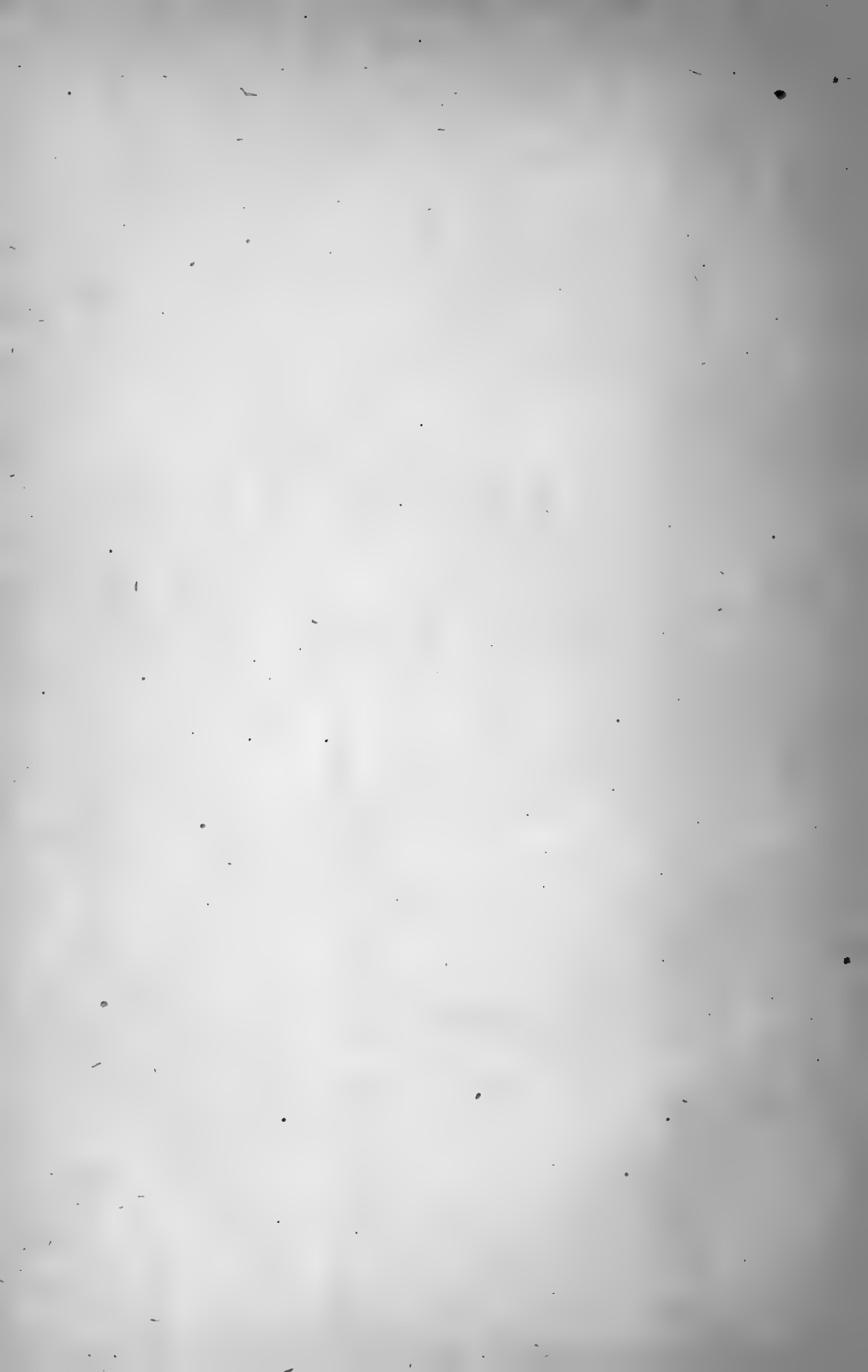

PART FIRST.



NATURAL HISTORY

OF

THE HONEY BEE.



NATURAL HISTORY OF THE HONEY-BEE.

CHAPTER I.

THE BEE'S PLACE IN THE ANIMAL KINGDOM.

It is estimated by Heer and other eminent naturalists, that there are more than 250,000 species of living animals. It will be both interesting and profitable to look in upon this vast host, that we may know the position and relationship of the bee to all this mighty concourse of life.

BRANCH OF THE HONEY-BEE.

The great French naturalist, Cuvier, a friend of Napoleon I., grouped all animals which exhibit a ring structure into one branch, appropriately named *Articulates*, as this term indicates the jointed or articulated structure which so obviously characterizes most of the members of this group.

The terms *joint* and *articulation*, as used here, have a technical meaning. They refer not only to the hinge or place of union of two parts, but also to the parts themselves. Thus, the parts of an insect's legs, as well as the surfaces of union, are styled *joints* or *articulations*. All the apiarists who have examined carefully the structure of a bee, will at once pronounce it an *Articulate*. Not only is its body, even from head to sting, composed of joints, but by close inspection we find the legs, the antennæ, and even the mouth-parts, likewise jointed.

In this branch we also place the *Crustacea*—which include the rollicking cray-fish or lobster, so indifferent as to whether he moves forward, backward or sidewise, the shorter crab, the sow-bug, lively and plump, even in its dark, damp home under old boards, and the barnacles, which fasten to the bottom of ships, so that vessels are often freighted with life without as well as within.

The worms, too, are *Articulates*, though in some of these, as the leech, the joints are very obscure. The bee, then,

which gives us food, is related to the dreaded tape-worm, with its hundreds of joints, which, mayhaps, robs us of the same food after we have eaten it, and to the terrible pork-worm, or trichina, which may consume the very muscles we have developed in caring for our pets of the apiary.

In classifying animals, the zoologist has regard not only to the morphology—the gross anatomy—but also to the embryology, or style of development before birth or hatching. On both embryological and morphological grounds, Huxley and other recent authors are more than warranted in separating the Vermes, or worms, from the Articulates of Cuvier, as a separate branch. The remaining classes are now included in the branch Arthropoda. This term, which means jointed feet, is most appropriate, as all of the Insecta and Crustacea have jointed feet while the worms are without such members.

The body-rings of these animals form a skeleton, firm, as in the bee and lobster, or more or less soft, as in most larvæ. This skeleton, unlike that of Vertebrates or back-bone animals, to which man belongs, is outside, and thus serves to protect the inner, softer, parts, as well as to give them attachment, and to give strength and solidity to the animal.

This ring-structure, so beautifully marked in our golden-banded Italians, usually makes it easy to separate, at sight, animals of this branch from the Vertebrates, with their usually bony skeleton; from the less active Molluscan branch, with their soft, sack-like bodies, familiar to us in the snail, the clam, the oyster, and the wonderful cuttle-fish—the devil-fish of Victor Hugo—with its long, clammy arms, strange ink-bag, and often prodigious size; from the Radiate branch, with its elegant star-fish, delicate but gaudy jelly-fish, and coral animals, the tiny architects of islands and even continents; and from the lowest, simplest, Protozoan branch, which includes animals often so minute that we owe our very knowledge of them to the microscope, and so simple that they have been regarded as the bond which unites plants with animals.

THE CLASS OF THE HONEY-BEE.

Our subject belongs to the class Insecta, which is mainly characterized by breathing air usually through a very complicated system of air tubes. These tubes (Fig. 1), which are constantly branching, and almost infinite in number, are very

FIG. 1.

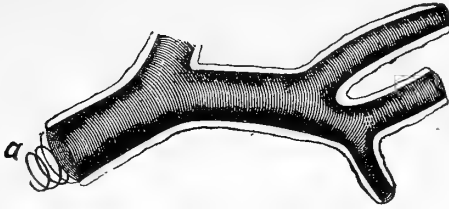

A Trachea, magnified.

peculiar in their structure. They are formed of a spiral thread, and thus resemble a hollow cylinder formed by closely winding a fine wire spirally about a rod, so as to cover it, and then

FIG. 2.

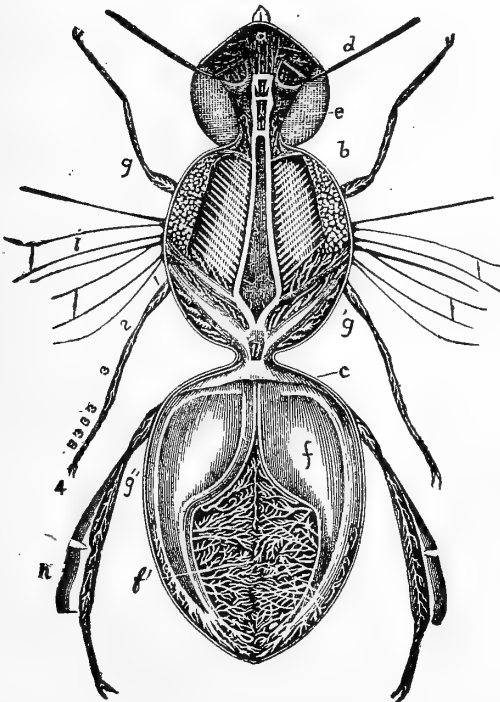

Respiratory Apparatus of Bee, magnified.—After Duncan.

withdrawing the latter, leaving the wire unmoved. Nothing is more surprising and interesting than this labyrinth of beautiful tubes, as seen in dissecting a bee under the microscope. I have frequently detected myself taking long pauses, in making dissections of the honey-bee, as my attention would be fixed in admiration of this beautiful breathing apparatus. In the bee these tubes expand into large lung-like sacks (Fig. 2, *f*), one on each side of the body. Doubtless some of my readers have associated the quick movements and surprising activity of birds and most mammals with their well-developed lungs, so in such animals as the bees, we see the relation between this intricate system of air tubes—their lungs—and the quick, busy life which has been proverbial of them since the earliest time. The class *Insecta* also includes the spiders, scorpions, with their caudal sting so venomous, and mites, all of which have, in lieu of the tubes, lung-like sacks, and the myriapods, or thousand-legged worms—those dreadful creatures, whose bite, in case of the tropical centipeds, or flat species, has a well-earned reputation of being poisonous and deadly.

SUB-CLASS OF THE HONEY-BEE.

The honey-bee belongs to the sub-class *Hexapoda*, or true *Insects*. The first term is appropriate, as all have in the imago, or last stage, six legs. Nor is the second term less applicable, as the word *insect* comes from the Latin, and means to cut in, and in no other articulates does the ring structure appear so marked upon merely a superficial examination. More than this, the true insects when fully developed have, unlike all other articulates, three well-marked divisions of the body (Fig. 2), namely: the head (Fig. 2, *a*), which contains the antennæ (Fig. 2, *d*), the horn-like appendages common to all insects; eyes (Fig. 2, *e*) and mouth organs; the thorax (Fig. 2, *b*), which bears the legs (Fig. 2, *g*), and wings, when they are present; and lastly, the abdomen (Fig. 2, *c*) which, though usually memberless, contains the ovipositor, and, when present, the sting. Insects undergo a more striking metamorphosis than do most other animals. When first hatched they are worm-like and called *larvæ* (Fig. 14), which means masked; afterward they are frequently quiescent, and would hardly be supposed to be animals at all. They are then known as *pupæ*, or, as in case of bees, *nymphs* (Fig. 15, *g*). At last there comes forth

the imago with compound eyes, antennæ and wings. In some insects the transformations are said to be incomplete; that is, the larva, pupa, and imago differ little except in size, and that the latter possesses wings. We see in our bugs, lice, locusts and grasshoppers, illustrations of insects with incomplete transformations. In such cases there is a marked resemblance from the egg to the adult.

As will be seen by the above description, the spiders, which have only two divisions to their bodies, only simple eyes, no antennæ, eight legs, and no transformations (if we except the partial transformations of the mites), and also the myriapods, which have no marked divisions of the body, and no compound eyes—which are always present in the mature insect—many legs and no transformations, do not belong to this sub-class.

ORDER OF THE HONEY-BEE.

The honey bee belongs to the order Hymenoptera (from two Greek words meaning membrane and wings), which also includes the wasps, ants, ichneumon-flies, and saw-flies. This group contains insects which possess a tongue by which they may suck (Fig. 22, *t*), and strong jaws (Fig. 24) for biting. Thus the bees can sip the honeyed sweets of flowers, and also gnaw away mutilated comb. They have, besides, four wings, and undergo complete transformations.

There are among insects strange resemblances. Insects of one order will show a marked likeness to those of another. This is known as mimicry, and sometimes is wonderfully striking between very distant groups. Darwin and Wallace suppose it is a developed peculiarity, not always possessed by the ancestors of the animal, and that it comes through the laws of variation and natural selection to serve the purpose of protection. Right here we have a fine illustration of this mimicry. Just the other day I received, through Mr. A. I. Root, an insect which he and the person sending it to him supposed to be a bee, and he desired to know whether it was a mal-formed honey-bee or some other species. This insect, though looking in a general way much like a bee, had only two wings, had no jaws, and its antennæ were closer together in front and mere stubs. In fact, it was no bee at all, but belonged to the order Diptera, or two-wing flies. I have received several similar insects, with like inquiries. Among Diptera there are several families, as

the Estridæ, or bot-flies, the Syrphidæ—a very useful family, as the larvæ or maggots live on plant-lice—whose members are often seen sipping sweets from flowers, or trying to rob honey and other bees—the one referred to above belonged to this family—and the Bombyliidæ, which in color, form, and hairy covering are strikingly like wild and domesticated bees. The maggots of these feed on the larvæ of various of our wild bees, and of course the mother fly must steal into the nests of the latter to lay her eggs. So in these cases there is seeming evidence that the mimicry may serve to protect these fly-tramps, as they steal in to pilfer the coveted sweets or lay the fatal eggs. Possibly, too, they may have a protective scent, as I have seen them enter a hive in safety, though a bumble-bee essaying to do the same found the way barricaded with myriad cimeters each with a poisoned tip.

Some authors have placed Coleoptera, or beetles, as the highest of insects, others claim for Lepidoptera, or butterflies and moths, a first place, while others, and with the best of reasons, claim for Hymenoptera the highest position. The moth is admired for the glory of its coloring and elegance of its form, and the beetle for the luster and brilliancy of its elytra, or wing-covers; but these insects only revel in nature's wealth, and live and die without labor or purpose. Hymenoptera, usually less gaudy, generally quite plain and unattractive in color, are yet the most highly endowed among insects. They live with a purpose in view, and are the best models of industry to be found among animals. Our bees practice a division of labor; the ants are still better political economists, as they have a specially endowed class in the community who are the soldiers, and thus are the defenders of each ant-kingdom. Ants also conquer other communities, take their inhabitants captive, and reduce them to abject slavery—requiring them to perform a large portion, and sometimes the whole of the labor of the community. Ants tunnel under streams, and in the tropics some leaf-eating species have been observed to show no mean order of intelligence, as some ascend trees to cut off the leafy twigs, while others remain below and carry these branches through their tunnels to their under-ground homes.

The parasitic Hymenoptera are so called because they lay their eggs in other insects, that their offspring may have fresh meat not only at birth, but so long as they need food, as the

insect fed upon generally lives till the young parasite, which is working to disembowel it, is full-grown. Thus this steak is ever fresh as life itself. These parasitic insects show wondrous intelligence, or sense development, in discovering their prey. I have caught ichneumon-flies—a family of these parasites—boring through an eighth or quarter-inch of solid beech or maple wood, and upon examination I found the prospective victim further on in direct line with the insect auger, which was to intrude the fatal egg. I have also watched ichneumon-flies depositing eggs in leaf-rolling caterpillars, so surrounded with tough hickory leaves that the fly had to pierce several thicknesses to place the egg in its snugly-ensconced victim. Upon putting these leaf-rolling caterpillars in a box, I reared, of course, the ichneumon-fly and not the moth. And is it instinct or reason that enables these flies to gauge the number of their eggs to the size of the larva which is to receive them, so that there may be no danger of famine and starvation, for true it is that while small caterpillars will receive but one egg, large ones may receive several. How strange, too, the habits of the saw-fly, with its wondrous instruments, more perfect than any saws of human workmanship, and the gall-flies, whose poisonous stings, as they fasten their eggs to the oak, willow, or other leaves, cause the abnormal growth of food for the still unhatched young. The providing and caring for their young, which are at first helpless, is peculiar among insects, with slight exception, to the Hymenoptera, and among all animals is considered a mark of high rank. Such marvels of instinct, if we may not call it intelligence, such acumen of sense perception, such habits—that *must* go hand-in-hand with the most harmonious of communities known among animals, of whatever branch—all these, no less than the compact structure, small size and specialized organs of nicest finish, more than warrant that grand trio of American naturalists, Agassiz, Dana, and Packard, in placing Hymenoptera first in rank among insects. As we shall detail the structure and habits of the *highest* of the high—the bees—in the following pages, I am sure no one will think to degrade the rank of these wonders of the animal kingdom.

FAMILY OF THE HONEY-BEE.

The honey-bee belongs to the family Apidæ, of Leach, which includes not only the hive bee but all insects which feed

their helpless young, or larvæ, entirely on pollen, or honey and pollen.

The insects of this family have broad heads, elbowed antennæ (Fig. 2, *d*) which are usually thirteen-jointed in the males, and only twelve-jointed in the females. The jaws or mandibles (Fig. 24) are very strong, and often toothed; the tongue or ligula (Fig. 22, *t*), as also the second jaws or maxillæ (Fig. 22, *mx*), one each side of the tongue, are long, though in some cases much shorter than in others, and frequently the tongue when not in use is folded back, once or more, under the head. All the insects of this family have a stiff spine on all four of the anterior legs, at the end of the tibia, or the third joint from the body, called the tibial spur, and all, except the genus *Apis*, which includes the honey-bee, in which the posterior legs have no tibial spurs, have two tibial spurs on the posterior legs. All of this family, except one parasitic genus, have the first joint or tarsus of the posterior foot much widened, and this together with the broad tibia (Fig. 2, *h*) is hollowed out (Fig. 25, *p*), forming quite a basin or basket on the outer side, in nearly all the species; and generally this basket is made deeper by a rim of stiff hairs. These receptacles or pollen baskets are only found of course on such individuals of each community as gather pollen. A few of the *Apidæ*—thieves by nature—cuckoo-like, steal unbidden into the nests of others, usually bumble-bees, and here lay their eggs. As their young are fed and fostered by another, they gather no pollen, and hence like drone bees need not, and have not, pollen baskets. The young of these lazy tramps starve out the real insect babies of these homes, by eating their food, and in some cases, it is said, being unable like the young cuckoos to hurl these rightful children from the nest, they show an equal if not a greater depravity by eating them, not waiting for starvation to get them out of the way. These parasites illustrate mimicry, already described, as they look so like the foster mothers of their own young, that unscientific eyes would often fail to distinguish them. Probably the bumble-bees are no sharper, or they would refuse ingress to these merciless vagrants.

The larvæ (Fig. 14) of all insects of this family are maggot-like—wrinkled, footless, tapering at both ends, and, as before stated, feed upon pollen and honey. They are helpless, and

thus, all during their babyhood—the larva state—the time when all insects are most ravenous, and the only time when many insects take food, the time when all growth in size, except such enlargement as is required by egg-development, occurs, these infant bees have to be fed by their mothers or elder sisters. They have a mouth with soft lips, and weak jaws, yet it is doubtful if all or much of their food is taken in at this opening. There is some reason to believe that they, like many maggots—such as the Hessian-fly larvæ—absorb much of their food through the body walls. From the mouth leads the intestine, which has no anal opening. So there are no excreta other than gas and vapor. What commendation for their food, *all* capable of nourishment, and thus all assimilated!

To this family belongs the genus of stingless bees, *Melipona*, of Mexico and South America, which store honey not only in the hexagonal brood-cells but in great wax reservoirs. They, like the unkept hive-bee, build in hollow logs. They are exceedingly numerous in each colony, and it has thus been thought that there was more than one queen. They are also very prodigal of wax, and thus may possess a prospective commercial importance in these days of artificial comb-foundation. In this genus the basal joint of the tarsus is triangular, and they have two submarginal cells, not three, to the front wings. They are also smaller than our common bees, and have wings that do not reach the tip of their abdomens.

Another genus of stingless bees, the genus *Trigona*, have the wings longer than the abdomens, and their jaws toothed. These, unlike the *Melipona*, are not confined to the New World, but are met with in Africa, India, and Australasia. These build their combs in tall trees, fastening them to the branches much as does the *Apis dorsata*, soon to be mentioned.

Of course insects of the genus *Bombus*—our common bumble-bees—belong to this family. Here the tongue is very long, the bee large, and the sting curved, with the barbs very short and few. Only the queen survives the winter. In spring she forms her nest under some sod or board, hollowing out a basin in the earth, and after storing a mass of bee-bread—probably a mixture of honey and pollen—she deposits several eggs in the mass. The larvæ, as soon as hatched out, eat out thimble-shaped spaces, which in time become even larger, and not un-

like in form the queen-cells of our hive-bees. When the bees issue from these cells the same are strengthened by wax. Later in the season these coarse wax cells become very numerous. Some may be made as cells and not formed as above. The wax is dark, and doubtless contains much pollen, as do the cappings and queen-cells of the honey-bees. At first the bees are all workers, later queens appear, and still later males. All, or nearly all, entomologists speak of two sizes of queen bumble-bees, the large and the small. The small appear early in the season, and the large late. A student of our College, Mr. N. P. Graham, who last year had a colony of bumble-bees in his room the whole season, thinks this an error. He believes that the individuals of the *Bombus* nest exactly correspond with those of the *Apis*. The queens, like those of bees, are smaller before mating and active laying. May not this be another case like that of the two kinds of worker-bees which deceived even Huber, an error consequent upon lack of careful and prolonged observation?

In *Xylocopa*, or the carpenter-bees, which much resemble the bumble-bees, we have a fine example of a boring insect. With its strong mandibles or jaws it cuts long tunnels, often one or two feet long, in the hardest wood. These burrows are divided by chip partitions into cells, and in each cell is left the bee-bread and an egg. Species of *Xylocopa* often do no slight damage by boring into the cornices, window casings, etc., of our houses and other buildings. I have also seen them slit long tubular flowers like those of the wild bergamont. I have often seen honey-bees visiting these slitted flowers, the nectar of which was thus made accessible to them.

The mason-bee—well named—constructs cells of earth and gravel, which by aid of its spittle it has power to cement, so that they are harder than brick.

The tailor, or leaf-cutting bees, of the genus *Megachile*, make wonderful cells from variously shaped pieces of leaves. These are always mathematical in form, usually circular and oblong, are cut—the insect making scissors of its jaws—from various leaves, the rose being a favorite. I have found these cells made almost wholly of the petals or flower leaves of the rose. The cells are made by gluing these leaf-sections in concentric layers, letting them over-lap. The oblong sections form the walls of the cylinder, while the circular pieces are

crowded as we press circular wads into our shot-guns, and are used at the ends or for partitions where several cells are placed together. When complete, the single cells are in form and size much like a revolver cartridge. When several are placed together, which is usually the case, they are arranged end to end, and in size and form are quite like a small stick of candy, though not more than one-third as long. These cells I have found in the grass, partially buried in the earth, in crevices, and in one case knew of their being built in the folds of a partially-knit sock, which a good house-wife had chanced to leave stationary for some days. These leaf-cutters have rows of yellow hairs underneath their bodies which aid them in carrying pollen. I have noticed them each summer for some years swarming on the Virginia creeper, often called woodbine, while in blossom, in quest of pollen, though I never saw a single hive-bee on these vines. The tailor-bees often cut the foliage of the same vines quite badly.

I have often reared beautiful bees of the genus *Osmia*, which are also called mason-bees. Their glistening colors of blue and green possess a luster and reflection unsurpassed even by the metals themselves. These rear their young in cells of mud, in mud-cells lining hollow weeds and shrubs, and in burrows which they dig in the hard earth. In early summer, during warm days, these glistening gems of life are frequently seen in walks and drives intent on gathering earth for mortar, or digging holes, and will hardly escape identification by the observing apiarist, as their form is so much like that of our honey-bees. They are smaller; yet their broad head, prominent eyes, and general form, are very like those of the equally quick and active, yet more soberly attired, workers of the apiary.

Other bees—the numerous species of the genus *Nomada*, and of *Apathus*, are the black sheep in the family *Apidæ*. These tramps, already referred to, like the English cuckoo and our American cow-blackbird, steal in upon the unwary, and, though all unbidden, lay their eggs; in this way appropriating food and lodgings for their own yet unborn. Thus these insect vagabonds impose upon the unsuspecting foster-mothers in these violated homes, and these same foster-mothers show by their tender care of these merciless intruders, that they are miserably fooled, for they carefully guard and feed infant bees, which with age will in turn practice this same nefarious trickery.

I reluctantly withhold further particulars of this wonderful bee family. When first I visited Messrs. Townley and Davis, of this State, I was struck with the fine collection of wild bees which each had made. Yet, unknowingly, they had incorporated many that were not bees. Of course, many apiarists will wish to make such collections and also to study our wild bees. I hope the above will prove efficient aid. I hope, too, that it will stimulate others, especially youth, to the valuable and intensely interesting study of these wonders of nature. I am glad to open to the reader a page from the book of nature so replete with attractions as is the above. Nor do I think I have taken too much space in revealing the strange and marvelous instincts, and wonderfully varied habits, of this highest of insect families, at the head of which stand our own fellow-laborers and companions of the apiary.

THE GENUS OF THE HONEY-BEE.

The genus *Apis* includes all bees that have no tibial spurs on the posterior legs. They have three cubital or sub-costal cells (1, 2, 3, Fig. 3)—the second row from the costal or an-

FIG. 3.

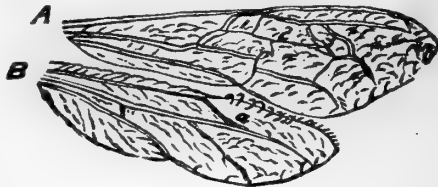

A.—Anterior Wing of a Bee. 1, 2, 3.—Sub-costal or Cubital Cells.

B.—Secondary or Posterior Wing; a, hooks to attach to Primary Wing.

terior edge—on the front or primary wings. On the inner side of the posterior basal tarsus, opposite the pollen baskets, in the neuters or workers, are rows of hairs (Fig. 26, *e*) which are probably used in collecting pollen. In the males, which do no work except to fertilize the queens, the large compound eyes meet above, crowding the three simple eyes below (Fig. 4), while in the workers (Fig. 5) and queens these simple eyes, called ocelli, are above, and the compound eyes wide apart. The drones and queens have weak jaws, with a rudimentary

FIG. 4.

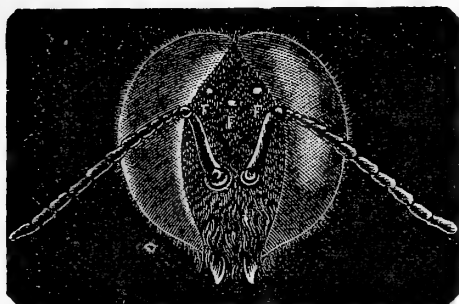

Head of Drone, magnified.
Antennæ. Compound Eyes. Simple Eyes.

FIG. 5.

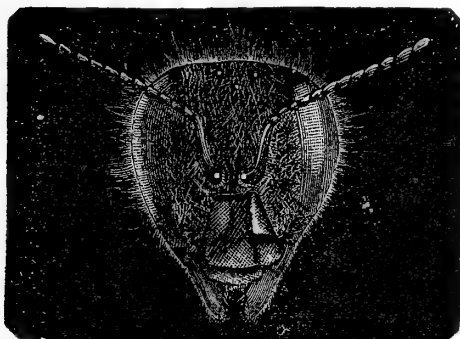

Head of Worker, Magnified.
Antennæ. Compound Eyes. Simple Eyes.

tooth (Fig. 24, *a, b*), short tongues, and no pollen baskets, though they have the broad tibia and wide basal tarsus (Fig. 20, *p*).

There is some doubt as to the number of species of this genus. It is certain that the *Apis Ligustica* of Spinola, or Italian bee, the *Apis fasciata* of Latreille, or Egyptian bee, are only varieties of the *Apis mellifica*, which also includes the German or black bee.

Mr. F. Smith, an able entomologist, considers *Apis dorsata* of India and the East Indies, *Apis zonata* of the same islands, *Apis Indica* of India and China, and *Apis florea* of India,

Ceylon, China, and Borneo, as distinct species. He thinks, also, that *Apis Adansoni* and *Apis nigrocincta* are distinct, but states that they may be varieties of *Apis Indica*. Some regard *Apis unicolor* as a distinct species, but it is probably a variety of *Apis dorsata*. As *Apis mellifica* has not been found in India, and is a native of Europe, Western Asia, and Africa, it seems quite possible though not probable that several of the above may turn out to be only varieties of *Apis mellifica*. If there are only color and size to distinguish them, and, indeed, one may add habits, then we may suspect, with good reason, the validity of the above arrangement. If there is structural difference, as Mr. Wallace says there is, in the male *dorsata*, then we may call them different species. The Italian certainly has a longer tongue than the German, yet that is not sufficient to separate them as species. *Apis zonata* and *Apis unicolor*, both of the East Indies, are said to be very black.

In the Autumn of 1879, Mr. D. A. Jones, of Beeton, Ontario, Canada, inaugurated the grandest enterprise ever undertaken in the interests of apiculture. This was nothing less than to visit Cyprus, Syria, and the more distant India and the East Indies, for the purpose of securing and introducing into America such species and races of bees as gave promise of superior excellence. Mr. Jones procured the services of Mr. Frank Benton, a graduate of Michigan Agricultural College, a fine linguist and skilled apiarist, to aid in this great undertaking. After visiting the principal apiaries of Europe, these gentlemen located at Larnica, in the Island of Cyprus, where they established a large apiary composed of Cyprian and Syrian bees. The Cyprian bees were purchased on the Island, while the Syrians were procured personally by Mr. Jones in Syria. The following June, Mr. Jones returned to America with several hundred queens of these two races. Mr. Benton remained at Larnica to rear and ship more queens to Europe and America. The following winter Mr. Benton visited Ceylon, Farther India, and Java, as Mr. Jones was determined to ascertain if there were better bees than those we already had, and if so to secure them. *Apis dorsata* was the special object of the quest, and as this bee was known as the "great bee of Java", Mr. Benton visited that island, in hopes to procure these bees. But to the sore disappointment not only of those who had the enterprise in charge, but of all progressive apiar-

ists, the bees in question were not to be found on that island. Mr. Benton learned at great cost that this bee is rare in Java, but common in the jungles of Ceylon, Hindoostan, Farther India, Sumatra, Borneo, and Timor. In Ceylon, Mr. Benton saw many colonies, most of which were in inaccessible places, though he secured, after great labor and hardship, four colonies.

These bees usually suspend their great combs, which are often six feet long and four feet wide, to overhanging rocks, or to horizontal branches of trees. In one case, Mr. Benton found them in the crevice of a rock, nearly surrounded by the same. This indicates that they may be kept in hives. The combs hang side by side as do those of our common bees, but are one half inch apart. Mr. Benton found the tops of the combs, which contain the honey, from three to six inches thick, while those where brood is reared are one and one half inches thick. The drones and workers are all reared in the same cells, which are about the size of the drone-brood cells of our honey-comb. The worker bees, some specimens of which I have received from Mr. Jones, in size and general appearance much resemble our Italian queens. They have blue black wings, black bodies, which are ringed very much as are our Italians, only the yellow largely predominates. Mr. Benton writes me that in form and style of flight they much resemble wasps. They are the same size as the drones, varying from three-fourths to seven-eighths of an inch in length. They are easily handled by aid of smoke, and are very clumsy in their attempts to sting. Their sting is no larger than that of our common bees, while the pain from their sting, Mr. Benton says, is not so great. The drones are dark brown, marked with yellow. Strangely enough, they only fly, unless disturbed, after sundown. This is unfortunate, as with the same habits we might hope to mate them with our common bees, and thus procure a valuable cross. This may be a developed peculiarity, to protect them from birds, and so might very likely disappear with domestication. The queens are leather colored, and smaller, as compared with the workers, than are our common queens. The queens are more restless than are the workers while being handled. While procuring these bees, Mr. Benton was prostrated with a fever, and so the bees, during their long voyage to Syria, were neglected. Strange to say, one colony survived the long confinement, but perished soon after reach-

ing Syria. We can not call this journey a failure, as we now have the information that will render a second attempt surely successful. What has been learned will make the enterprising bee-keeper more desirous than ever to secure these bees. Their large size, long tongue, and immense capabilities in the way of wax secretion, as well as honey storing, give us great reason to hope for substantial benefits from their importation. We can but rejoice that the characteristic energy and enterprise of Mr. Jones are still apparent, as he does not propose to rest till *Apis dorsata* is in the possession of American apiarists.

Mr. Benton also found *A. Indica* and *A. florea* on the Island of Ceylon. I have received some of the bees and comb of the former species. The comb is very delicate, the cells being only one-sixth of an inch in diameter. The workers are less than one half of an inch long, brown in color, and their entire abdomens are beautifully ringed with brown and yellow. The drones are black, and very small. The one I have measures an eighth of an inch less in length than does the worker. The queens are leather colored, and very large as compared with the workers. They are as large as are our common queens. These bees are very quick and are domesticated on the Island of Ceylon. The workers of *A. florea* are also banded, and are more beautiful even than those of *A. Indica*. From Mr. Benton's description it must be a sort of "albino." The sting of these two species is very small. From the small amount of stores which they gather, the tendency which they have to swarm out, and their inability to stand the cold, these two species promise little of value except from a scientific point of view. One colony of *A. florea* was brought by Mr. Benton to Cyprus, but it swarmed out and was lost.

It seems strange that the genus *Apis* should not have been native to the American continent. Without doubt there were no bees of this genus here till introduced by the Caucasian race. It seems more strange, as we find that all the continents and islands of the Eastern hemisphere abound with representatives. It is one more illustration of the strange, inextricable puzzles connected with the geographical distribution of animals.

SPECIES OF OUR HONEY-BEES.

The bees at present domesticated unquestionably belong to the *Apis mellifica*. The character of this species will appear

in the next chapter, as we proceed with their anatomy and physiology. As before stated, this species is native exclusively to the Eastern hemisphere, though it has been introduced wherever civilized man has taken up his abode.

VARIETIES OF THE HONEY-BEE.

German or Black Bee.

The German or black bee is the variety best known, as through all the ages it has been most widely distributed. The name German refers to locality, while the name black is a misnomer, as the bee is a gray-black. The queen, and, in a less degree, the drones, are darker, while the legs and under-surface of the former are brown, or copper colored, and of the latter light-gray. The tongue of the black worker I have found, by repeated dissections and comparisons made both by myself and by my pupils, is shorter than that of the Italian worker, and generally less hairy. The black bees have been known no longer than the Italians, as we find the latter were known both to Aristotle, the fourth century B.C., and to Virgil, the great Roman poet, who sung of the variegated golden bee, the first century B.C.; and we can only account for the wider distribution of the German bee by considering the more vigorous pushing habits of the Germanic races, who not only over-ran and infused life into Southern Europe, but have vitalized all Christendom.

Ligurian or Italian Bee.

The Italian bee is characterized as a variety, not only by difference of color, habits, and activity, but also by possessing a little longer tongue. These bees were first described as distinct from the German race by Spinola, in 1805, who gave the name Ligurian bee, which name prevails in Europe. The name comes from a province of Northern Italy, north of the Ligurian Gulf, or Gulf of Genoa. This region is shut off from Northern Europe by the Alps, and thus these bees were kept apart from the German bees, and in warmer, more genial Italy, was developed a distinct race, our beautiful Italians.

In 1843, Von Baldenstein procured a colony of these bees, which he had previously observed as peculiar, while stationed as a military captain in Italy. He published his experience

in 1848, which was read by Dzierzon, who became interested, and through him the Italian became generally introduced into Germany. In 1859, six years after Dzierzon's first importation, the Italian variety was introduced into England by Neighbour, the author of the valuable treatise already referred to. The same year, Messrs. Wagner and Colvin imported the Italians from Dzierzon's apiary into America; and in 1860, Mr. S. P. Parsons brought the first colonies that were imported direct from Italy.

The Italian worker is quickly distinguished by the bright-yellow rings at the base of the abdomen. If the colony is

FIG. 6.

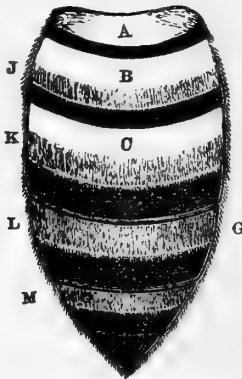
*Abdomen of Italian Worker.*

pure, every bee will show three of these golden girdles. The two first segments or rings of the abdomen, except at their posterior border, and also the base or anterior border of the third, will be of this orange-yellow hue. The rest of the back or dorsal surface will be much as in the German race. Underneath, the abdomen, except for a greater or less distance at the tip, will also be yellow, while the same color appears more or less strongly marked on the legs. The workers have longer ligulæ or tongues (Fig. 22, *t*) than the German race, and their tongues are also a little more hairy. They are also more active, and less inclined to sting. The queen has the entire base of her abdomen, and sometimes nearly the whole of it, orange-yellow. The variation as to amount of color in the queens is

quite striking. Sometimes very dark queens are imported right from the Ligurian hills, yet all the workers will wear the badge of purity—the three golden bands.

The drones are quite variable. Sometimes the rings and patches of yellow will be very prominent, then, again, quite indistinct. But the under side of the body is always, so far as I have observed, mainly yellow.

A variety of our Italian bees which has the rows of white hairs (Fig. 6, J, K, L, M) unusually distinct is being sold in the United States under the name of Albinos. They are not a distinct race. In fact, I have often noticed among Italians the so-called Albinos.

THE SYRIAN AND CYPRIAN RACES.

Through the enterprise of Messrs. D. A. Jones and Frank Benton, we now have these races in our country, and have proved the truth of the assertion of noted European apiarists, that the Cyprian is a distinct race of bees.

Mr. Benton, than whom no one is better fitted to express a correct opinion, thinks that the Cyprian bees are the offspring of the Syrian. This opinion is strengthened by the close resemblance of the three races, and by the fact that migrations of all kinds have gone westward. A similar argument would make it presumable that the Cyprians gave rise to the Italians.

The Cyprian bees resemble the Italians very closely. They may be distinguished by the bright leather-colored lunule which tips their thorax posteriorly, and by the fact that the under side of their bodies is yellow to the tip. They are more active than are the Italians, and the queens are more prolific.

The good qualities of the Italians seem all to be exaggerated in the Cyprian, except the trait of amiability. The Cyprian bees are second only to the Egyptian in irritability. That they will become less cross with handling is to be expected.

The Syrian bees are a very well marked race. The Syrian queens are remarkably uniform. Their abdomens above are, like the little *A. Indica*, beautifully banded with yellow and black. They are very quick and remarkably prolific. They do not cease laying even when the honey flow ceases. The workers closely resemble those of the Italian race, only that they are more yellow beneath, and when first from the cells, or newly hatched, they are very dark, owing to the fact that the

body rings seem pushed together. From the admirable way in which they defend their hives against robbers, the ease with which they are shaken from the combs, their great activity, their great tendency to remain in the hive on very windy days, the wonderful fecundity of the queen, her persistence in laying during a dearth of nectar secretion, and their great superiority for queen rearing, I feel sure that these bees are a very great acquisition to American apiculture, and I believe are the best bees that have as yet been domesticated.

I have now tried these Syrian bees for three years, and have found them gentle and easy to handle. My thirty students went among them freely last summer, handling them with no protection, and one of our students, who had never handled bees before in his life, took all of the honey away from them in the fall, and received almost no stings. The comb-honey of Syrians is said to have very thin capping, and so not to be salable. I have not observed this peculiarity.

OTHER RACES.

The Egyptian bees are very yellow, intensely cross, and frequently have fertile workers. These are probably the bees which are famous in history, as having been moved up and down the Nile, in rude boats or rafts, as the varying periods of nectar-secreting bloom seemed to demand.

The heath bees of Northern Germany are much like the common German bees, of which they are a variety, except that they are far more inclined to swarm.

The Carniolan bees of South-western Austria are like the heath variety, but are specially noted for their very gentle dispositions. Some European bee-keepers claim that this race or variety is much superior to the common German bees. The Hungarian bees are longer than the typical German race, and are covered with gray hairs. During the poor season of 1875 in Europe, these bees, like the Carniolans, were found superior even to the Italians. The beautiful Dalmatian bees are slim, wasp-like, and very black. The rings of their abdomens are banded with lightish yellow. Their honey is even more white and beautiful than that of the German race. Some of the best European bee-keepers claim that they are superior to the Italian bees. Akin to the Dalmatian bees are the Herzegovinian variety, which comes from the mountainous region of Eu-

ropean Turkey bordering on the Adriatic Sea. A better marked variety—the Smyrnian bees—from Western Asia, are also much praised by some of the noted Austrian bee-keepers, as are also the Caucasian, from the Caucasus Mountains, which are said to be very active and amiable. It is quite likely that some of these varieties might be found to endure our severe winters better than the pure German type or the Italians.

BIBLIOGRAPHY.

It would be a pleasing duty, and not an unprofitable one, to give in this connection a complete history of entomology so far as it relates to *Apis mellifica*. But this would take much space, and as there is quite a full history in books that I shall recommend to those who are eager to know more of this interesting department of natural history, I will not go into details.

Aristotle wrote of bees more than three hundred years B. C. About three hundred years later, Virgil, in his fourth Georgic, gave to the world the views then extant on this subject, gathered largely from the writings of Aristotle. The poetry will ever be remarkable for its beauty and elegance—would that as much could be said for the subject matter, which, though full of interest, is also full of errors. A little later, Columella, though usually careful and accurate in his observations, still gave voice to the prevailing errors, though much that he wrote was valuable, and more was curious. As Mr. Langstroth once said to me, Columella wrote as one who had handled the things of which he wrote; and not like Virgil, as one who was dealing with second hand wares. Pliny the elder, who wrote in the first century, A. D., helped to continue the erroneous opinions which previous authors had given, and not content with this, he added opinions of his own, which were not only without foundation but were often the perfection of absurdity.

After this, nearly two thousand years passed with no progress in natural history; even for two centuries after the revival of learning, we find nothing worthy of note. Swammerdam, a Dutch entomologist, in the middle of the 17th century, wrote a general history of insects; also, "The Natural History of Bees." He and his English contemporary, Ray, showed their ability as naturalists by founding their systems on the insect transformations. They also revived the study and practice of anatomy, which had slept since its first introduc-

- tion by Aristotle, as the great stepping-stone in zoological progress. I never open the grand work of Swammerdam, with its admirable illustrations, without feelings of the most profound respect and admiration. Though a very pioneer in anatomy, and one of the founders of Natural Science, and possessed of lenses of very inferior quality, yet he wrote with an accuracy, and illustrated even minute tissues with a correctness and elegance that well might put to the blush many a modern writer.

Ray also gave special attention to Hymenoptera, and was much aided by Willoughby and Lister. At this time Harvey, so justly noted for his discovery of the circulation of the blood, announced his celebrated dictum, "Omnia ex ovo"—all life from eggs—which was completely established by the noted Italians, Redi and Malpighi. Toward the middle of the 18th century, the great Linnæus—"the brilliant Star of the North"—published his "System Naturæ," and threw a flood of light on the whole subject of natural history. His division of insects was founded upon presence, or absence, and characteristics, of wings. This, like Swammerdam's basis, was too narrow, yet his conclusions were remarkably correct. Linnæus is noted for his accurate descriptions, and especially for his gift of the binomial method of naming plants and animals, giving in the name, the genus and species, as, *Apis mellifica*. He was also the first to introduce classes and orders, as we now understand them. When we consider the amount and character of the work of the great Swede, we can but place him among the first, if not as the first, of naturalists. Contemporary with Linnæus (also written Linné) was Geoffry, who did valuable work in defining new genera. In the last half of the century appeared the great work of a master in entomology, DeGeer, who based his arrangement of insects on the character of wings and jaws, and thus discovered another of nature's keys to aid him in unlocking her mysteries. Kirby well says: "He united in himself the highest merit of almost every department of entomology." As a scientist, an anatomist, a physiologist, and as the observant historian of the habits and economy of insects, he is above all praise. What a spring of self-improvement, enjoyment and public usefulness, is such an ability to observe as was possessed by the great DeGeer.

Contemporary with Linnæus and DeGeer, was Réaumur, of

France, whose experiments and researches are of special interest to the apiarists. Perhaps no entomologist has done more to reveal the natural history of bees. Especially to be commended are his method of experimenting, his patience in investigation, the elegance and felicity of his word pictures, and, above all, *his devotion to truth*. We shall have occasion to speak of this conscientious and indefatigable worker in the great field of insect life frequently in the following pages. Bonnet, of Geneva, the able correspondent of Réaumur, also did valuable work, in which the lover of bees has a special interest. Bonnet is specially noted for his discovery and elucidation of parthenogenesis—that anomalous mode of reproduction—as it occurs among the Aphides, or plant-lice, though he did not discover that our bees, in the production of drones, illustrate the same doctrine. Though the author of no system, he gave much aid to Réaumur in his systematic labor.

At this same period systematic entomology received great aid from Lyonnet's valuable work. This author dissected and explained the development of a caterpillar. His descriptions and illustrations are wonderful, and will proclaim his ability as long as entomology is studied, and they, to quote Bonnet, "demonstrate the existence of God."

We have next to speak of the great Dane, Fabricius—a student of Linnæus—who published his works from 1775 to 1798, and thus was revolutionizing systematic entomology at the same time that we of America were revolutionizing government. He made the mouth organs the basis of his classification, and thus followed in the path which DeGeer had marked out; though it was scarcely beaten by the latter, while Fabricius left it wide and deep. His classes and orders are no improvement on, in fact, are not nearly as correct as his old master's. In his description of genera—where he pretended to follow nature—he has rendered valuable service. In leading scientists to study parts, before little regarded, and thus to better establish affinities, he did a most valuable work. His work is a standard, and should be thoroughly studied by all entomologists.

Just at the close of the last century, appeared the "greatest Roman of them all," the great Latreille, of France, whose name we have so frequently used in the classification

of the honey-bee. His is called the Elective System, as he used wings, mouth-parts, transformations, in fact, all the organs—the entire structure. He gave us our Family Apidæ, our genus Apis, and, as will be remembered, he described several of the species of this genus. In our study of this great man's work, we constantly marvel at his extensive researches and remarkable talents. Lamarck, of this time, except that he could see no God in nature, did very admirable work. So, too, did Cuvier, of Napoleon's time, and the learned Dr. Leach, of England. Since then we have had hosts of workers in this field, and many worthy of not only mention but praise; yet the work has been to rub up and garnish, rather than to create.

I will close this brief history with a notice of authors who are very serviceable to such as may desire to glean farther of the treasures of systematic entomology; only remarking that at the end of the next chapter I shall refer to those who have been particularly serviceable in developing the anatomy and physiology of insects, especially of bees.

VALUABLE BOOKS FOR THE STUDENT OF ENTOMOLOGY.

For mere classification, no work is equal to Westwood on Insects—two volumes. In this the descriptions and illustrations are very full and perfect, making it easy to study the families, and even genera, of all the orders. This work and the following are out of print, but can be got with little trouble at second-hand book-stores. Kirby and Spence—Introduction to Entomology—is a very complete work. It treats of the classification, structure, habits, general economy of insects, and gives a history of the subject. It is an invaluable work, and a great acquisition to any library. Dr. Packard's Guide to the Study of Insects is a valuable work, and being American is specially to be recommended. "Injurious Insects" is the title of two valuable books, one by Dr. T. Harris, the other by Mary Treat. The Reports of Dr. T. Harris, Dr. A. Fitch, and Dr. C. V. Riley, the Illinois Entomological Reports, and the Entomological Reports of the Departments of the Interior, and of Agriculture, will also be found of great value and interest.

CHAPTER II.

ANATOMY AND PHYSIOLOGY.

In this chapter I shall give first the general anatomy of insects; then the anatomy, and still more wonderful physiology, of the honey-bee.

ANATOMY OF INSECTS.

In all insects the body is divided into three well-marked portions (Fig. 2.); the head (Figs. 4 and 5), which contains the mouth-organs, the eyes, both the compound and when present the simple, and the antennæ; the thorax, which is composed of three rings, and gives support to the one or two pairs of wings when present, and to the three pairs of legs; and the abdomen, which is composed of a variable number of rings, and gives support to the external sex-organs, and when present to the sting. Within the thorax there are little more than muscles, as the concentrated strength of insects, which enables them to fly with such rapidity, dwells in this confined space. Within the abdomen, on the other hand, are the sex-organs, by far the greater and more important portions of the alimentary canal, and other important organs.

ORGANS OF THE HEAD.

Of these the mouth organs (Fig. 7) are most prominent. These consist of an upper lip—labrum, and under lip—labium, and two pairs of jaws which move sidewise; the stronger, horny jaws are called mandibles, and the more membranous, but usually longer, maxillæ. The labrum (Fig. 7, *b*) is well described in the name upper lip. It is attached, usually, by a movable joint to a similarly shaped piece above it, called the clypeus (Fig. 7, *c*), and this latter to the broad epicranium (Fig. 7, *o*), which contains the antennæ, the compound, and, when present, the simple eyes.

The labium (Fig. 17) is not described by the name underlip, as its base forms the floor of the mouth and its tip the tongue. The base is usually broad, and is called the mentum, and from this extends the tongue (Fig. 17, *a*) or ligula.

On either side, near the junction of the ligula and mentum, arises a jointed organ, rarely absent, called the labial palpus (Fig. 7, *k k*), or, together, the labial palpi. Just within the angle formed by these latter and the ligula arise the paraglossæ (Fig. 17, *d*), one on either side. These are often wanting.

FIG. 7.

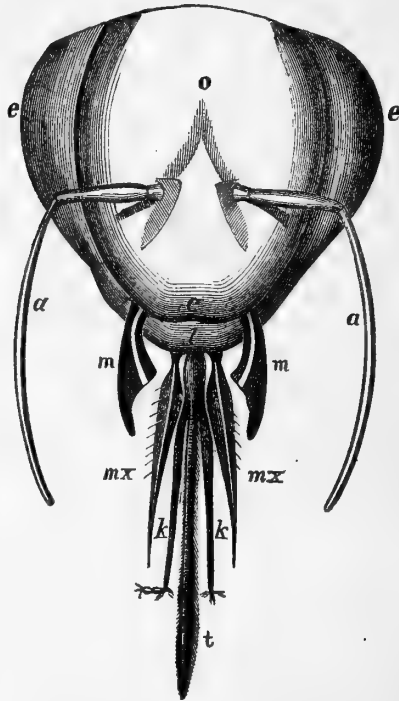

Head of Bee much magnified.

o—Epicranium.
e e—Compound eyes.
a a—Antennæ.
c—Clypeus.
l—Labrum.

m—Jaws.
m x—2d Jaws.
k k—Labial palpi.
t—Ligula.

The jaws or mandibles (Fig. 7, *m, m*) arise one on either side just below and at the side of the labrum, or upper lip. These work sidewise instead of up and down as in higher animals, are frequently very hard and sharp, and sometimes armed with one

or more teeth. A rudimentary tooth (Fig. 24, *a, b*) is visible on the jaws of drone and queen bees.

Beneath the jaws or mandibles, and inserted a little farther back, are the second jaws, or maxillæ (Fig. 7, *mx*), less dense and firm than the mandibles, but far more complex. They arise by a small joint, the *cardo*; next this is a larger joint, the *stipes*; from this extends on the inside the broad *lacinia* (Fig. 22, *c*) or blade, usually fringed with hairs on its inner edge, towards the mouth; while on the outside of the *stipe*, are inserted the—from one to several jointed—maxillary palpi. In bees these are very small and consist of two joints, and in some insects are wholly wanting. Sometimes, as in some of the beetles, there is a third member running from the *stipes* between the palpus and *lacinia* called the *galea*. The maxillæ also move sidewise, and probably aid in holding and turning the food while it is crushed by the harder jaws, though in some cases they, too, aid in triturating the food.

These mouth parts are very variable in form in different insects. In butterflies and moths, two wing flies and bugs, they are transformed into a tube, which in the last two groups forms a hard, strong beak or piercer, well exemplified in the mosquito and bed-bug. In all the other insects we find them much as in the bees, with the separate parts varying greatly in form, to agree with the habits and character of their possessors. No wonder De Geer and Fabricius detected these varying forms as strongly indicative of the nature of the insect, and no wonder that by their use they were so successful in forming a natural classification.

If, as is more than probable, the "Doctrine of Selection" is well founded, then a change in habit is the precursor of a change in structure. But what organs are so intimately related to the habits of animals, as the mouth and other organs that have to do with digestion?

Every apiarist will receive great benefit by dissecting these parts and studying their form and relations for himself. By getting his children interested in the same, he will have conferred upon them one of the rarest of blessings.

To dissect these parts, first remove the head and carefully pin it to a cork, passing the pin through, well back between the eyes. Now separate the parts by two needle points, made by inserting a needle for half its length into a wooden pen-holder,

leaving the point projecting for an inch or more. With one of these in each hand commence operations. The head may be either side up. Much may be learned in dissecting large insects even with no glass; but in all cases, and especially in small insects, a good lens will be of great value. The best lens is one of Tolles', sold by Mr. Stoddard of the Boston optical works. These are very excellent and thus high priced, costing \$14.00 a lens.

The Coddington lens, mounted in German silver, is nearly as good. These are imported from England. They can be procured of any optician, and only cost \$2.00. These lenses can be mounted in a convenient stand (Fig. 8) which may be

FIG. 8.

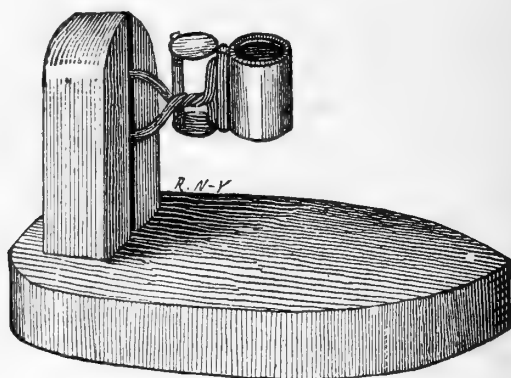
*Microscope mounted for Dissecting.*

made in twenty minutes. I think one of these more valuable than a large compound microscope, which costs many times as much. Were I obliged to part with either, the latter would go.

I require my students to do a great deal of dissecting, which they enjoy very much and find very valuable. I would much rather that my boy should become interested in such study, than to have him possessor of infinite gold rings, or even a huge gold watch, with a tremendous charm. Let such pleasing recreation gain the attention of our boys, and they will ever contribute to our delight and not sadden us with anxiety and fear.

The antennæ (Fig. 7, *a, a*) are the horn-like jointed organs situated between or below and in front of the large compound

eyes of all insects. They are sometimes short, as in the house-fly, and sometimes very long, as in the grasshoppers. They are either straight, curved, or elbowed. In form they are very various, as thread-like, tapering, toothed, knobbed, fringed, feathered, etc. It is known that a nerve passes into the antennæ, but their exact function is little understood. That they serve as most delicate touch organs no apiarist can doubt. That they serve as organs of smell or hearing is not proved. That insects are conscious of sounds I think no observing person can doubt. It is proved by the call of the katy-did, the cicada, and the cricket. No apiarist has failed to notice the effect of various sounds made by the bees upon their comrades of the hive, and how contagious the sharp note of anger, the low hum of fear, and the pleasant tone of a new swarm as they commence to enter their new home. Now, whether insects take note of these vibrations, as we recognize pitch, or whether they just distinguish the tremor, I think no one knows. There is some reason to believe that their delicate touch organs may enable them to discriminate between vibrations, even more acutely than can we by use of our ears. A slight jar will quickly awaken a colony of hybrids, while a loud noise will pass unnoticed. If insects can appreciate with great delicacy the different vibratory conditions of the air by an excessive development of the sense of touch, then undoubtedly the antennæ may be great aids. Dr. Clemens thought that insects could only detect atmospheric vibrations. So, too, thought Linnæus and Bonnet. Siebold thinks, as the antennæ receive but one nerve, and are plainly touch organs, they can not be organs of hearing. Kirby has noticed that some moths turn their antennæ towards the direction from which noise proceeds, and thus argues that antennæ are organs of hearing. Grote, for a similar reason, thinks that the densely feathered antennæ of the males of various night moths, serve for both smell and hearing. Prof. A. M. Mayer and Mr. C. Johnson (see *American Naturalist*, vol. 8, p. 574) have by various ingenious experiments proved conclusively that the delicate, beautifully feathered antennæ of the male mosquito are organs of hearing.

Sir John Lubbock, in that interesting work, "Ants, Bees, and Wasps," says he has never succeeded in satisfying himself that ants, bees, or wasps heard any of the sounds with which he tried them. He refers to certain structures on the antennæ

of ants, and on the tibiæ of ants and other insects, which are possibly auditory organs.

That insects have a very refined sense of smell is beyond question. The carrion-fly quickly finds the carcass, the scavenger the filth, and the bee the nectar.

I have reared female moths in my study, and have been greatly surprised, on the day of their leaving their cocoons, to find my room swarming with males. These bridegrooms entered an open window in the second-story of a brick building. How delicate must have been the sense by which they were led to make the visit, and thus made to grace my cabinet. Male moths have been known to come down chimney to reach the females. Bees have been known to dash against a shutter behind which were flowers, thus showing the superiority of their perception of odors, as also their poor vision. But odors are carried by the air, and must reach the insect through this medium. Is it not probable that the various breathing mouths of insects are also so many noses, and that their delicate lining membranes abounding with nerve filaments, are the great odor sentinels? This view was maintained by both Lehman and Cuvier, and explains this delicate perception of scents, as the breathing mouths are large and numerous, and most so in insects like bees and moths which are most sensitive to odors. Bees quickly notice the scent of a strange bee or queen, or the peculiar odor of the venom. I have known a bee to sting a glove, and in a trice the glove would be as a pin-cushion, with stings in lieu of pins. Sometimes the bees will dart for many feet, guided by this odor. Yet the odor is very pungent, as I have frequently smelt the poison before I felt the sting. Sir John Lubbock's experiments with ants show that with them as with bees, the sense of smell is highly developed. I have tried the experiments of Huber and Lubbock, and know that such insects as bees and ants will take no note of food after the loss of their antennæ. But we must remember that this is a capital operation. With loss of antennæ, insects lose control of their motions, and in many ways show great disturbance. Is it not probable that removing the antennæ destroys the desire for food, as does amputation with ourselves? Kirby believes, with Huber, that there is a scent organ. Huber's experiments on which he based this opinion are, as usual, very interesting. He presented a coarse hair dipped in oil of tur-

entine—a substance very repugnant to bees—to various parts of a bee engrossed in sipping honey. The bee made no objection, even though it touched the ligula, until it approached the mouth above the mentum, when she became much disturbed. He also filled a bee's mouth with paste, which soon hardened, after which the bee paid no heed to honey placed near it. This was not so conclusive, as the bee may have been so disturbed as to lose its appetite. I have experimented a good deal, and am inclined to the following opinion: The antennæ are very delicate touch-organs or feelers, and are so important in their function and connection that removal produces a severe shock, but further we know but little about their function, if they have other, and from the very nature of the problem we will find it very difficult of solution.

The eyes are of two kinds, the compound, which are always present in mature insects, and the ocelli or simple eyes, which may or may not be present. When present there are usually three, which, if joined by lines, will describe a triangle, in the vertices of whose angles are the ocelli. Rarely there are but two ocelli, and very rarely but one.

The simple eyes (Fig. 4, *fff*) are circular, and possess a cornea, lens, and retina, which receives the nerve of sight.

From the experiments of Reaumur and Swammerdam, which consisted in covering the eyes with varnish, they concluded that vision with these simple eyes is very indistinct, though by them the insect can distinguish light. Some have thought that these simple eyes were for vision at slight distances. Larvæ, like spiders and myriapods, have only simple eyes. The compound eyes (Fig. 2, *e*) are simply a cluster of simple eyes, are situated one on either side of the head, and vary much in form and size. Between or below these are inserted the antennæ. Sometimes these last are inserted in a notch of the eyes, and in a few cases actually divide each eye into two eyes.

The eyes may meet above, as in drones (Fig. 4) and most two-wing flies and dragon-flies, or they may be considerably separated, as in the worker-bees (Fig. 5). The separate facets or simple eyes, of each compound eye, are hexagonal, or six-sided, and in the microscope look not unlike a section of honey-comb. The number of these is prodigious—Leeuwenhoek actually counted 12,000 in the eye of a dragon-fly, while some

butterflies have over 17,000. The compound eyes are motionless, but from their size and sub-spherical shape give quite a range of vision. It is not likely that they are capable of adjustment to accord with different distances, and it has been supposed, from the direct darting flight of bees to their hives, and the awkward work they make in finding a hive when moved only a short distance, that their eyes are best suited to long vision.

Sir John Lubbock has proved, by some interesting experiments with strips of colored paper, that bees can distinguish colors. Honey was placed on a blue strip, beside several others of various colors. In the absence of the bees he changed the position of this strip, and upon their return the bees went to the blue strip rather than to the old position. Our practical apiarists have long been aware of this fact, and have conformed their practice to this knowledge, in giving a variety of colors to their hives. Apiarists have frequently noted that bees have a rare faculty of marking positions, but, for slight distances, their sense of color will correct mistakes which would occur if position alone were their guide. Lubbock's experiments prove that ants and wasps also distinguish colors. This is doubtless true of all insects that love sweets and are attracted by flowers.

APPENDAGES OF THE THORAX.

The organs of flight are the most noticeable appendages of the thorax. The wings are usually four, though the Diptera have but two, and some insects—as the worker ants—have none. The front or primary wings (Fig. 3, *A*) are usually larger than the secondary or hind wings (Fig. 3, *B*), and thus the mesothoracic or middle ring of the thorax, to which they are attached, is usually larger than the metathorax or third ring. The wings consist of a broad frame-work of veins (Fig. 3), covered by a thin, tough membrane. The main ribs or veins are variable in number, while towards the extremity of the wing are more or less cross-veins, dividing this portion of the wings into more or less cells. In the higher groups these cells are few, and quite important in classifying. Especially useful are the cells in the second row, from the frontal or costal edge of the front wings, called the sub-costal cells. Thus in the genus *Apis* there are three such cells (Fig. 3, *A*,

1, 2, 3), while in the *Melipona* there are only two. The ribs or veins consist of a tube within a tube, the inner one form-

FIG. 9.

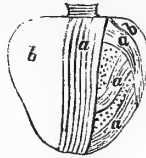

Thorax of Bee magnified three times.

a, a, a—Muscles.

b, b—Crust.

ing an air tube, the outer one carrying blood. On the costal edge of the secondary wings we often find hooks, to attach them to the front wings (Fig. 3, *B, a*).

The wings are moved by powerful muscles, compactly located in the thorax (Fig. 9, *a, a, a*), the strength of which is very great. The rapidity of the vibrations of the wings when flight is rapid, is really beyond computation. Think of a tiny fly outstripping the fleetest horse in the chase, and then marvel at this wondrous mechanism.

The legs (Fig. 2, *g, g, g*) are six in number in all mature insects, two on the lower side of each ring of the thorax. These are long or short, weak or strong, according to the habit of the insect. Each leg consists of the following joints or parts: The coxa, which moves like a ball and socket joint in the close-fitting coxal cavities of the body-rings. Next to this follow in order the broad trochanter, the large, broad femur (Fig. 2, *g, 1*), the long, slim tibia (Fig. 2, *g, 2*), frequently bearing strong spines at or near its end, called tibial spurs, and followed by the from one to five-jointed tarsi (Fig. 2, *g, 3, 3, 3, 3, 3*). All these parts move freely upon each other, and will vary in form to agree with their use. At the end of the last tarsal joint are two hooked claws (Fig. 2, *g, 4*), between which are the pulvilli, which are not air-pumps as usually described, but rather glands, which secrete a sticky substance which enables insects to stick to a smooth wall, even though it be above them. The legs, in fact the whole crust, are more or less dense and hard, owing to the deposit within the structure of a hard substance known as chitine.

INTERNAL ANATOMY OF INSECTS.

The muscles of insects are usually whitish. Sometimes I have noticed quite a pinkish hue about the muscles of the thorax. They vary in form and position to accord with their use. The mechanism of contraction is the same as in higher animals. The ultimate fibers of the voluntary muscles, when highly magnified, show the striæ or cross-lines the same as do the voluntary muscles of vertebrates, and are very beautiful as microscopic objects. The separate muscles are not bound together by a membrane as in higher animals. In insects the muscles are widely distributed, though, as we should expect, they are concentrated in the thorax and head. In insects of swiftest flight, like the bee, the thorax (Fig. 9, *a, a a*) is almost entirely composed of muscles; the esophagus, which carries the food to the stomach, being very small. At the base of the jaws the muscles are large and firm. The number of muscles is astounding. Lyonnet counted over 3,000 in a single caterpillar, nearly eight times as many as are found in the human body. The strength, too, of insects is prodigious. There must be quality in muscles, for muscles as large as those of the elephant, and as strong as those of the flea, would hardly need the fulcrum which the old philosopher demanded, in order to move the world. Fleas have been made to draw miniature cannon, chains and wagons, many hundred times heavier than themselves.

The nerves of insects are in no wise peculiar so far as known, except in position. As in our bodies, some are knotted, or have ganglia, and some are not.

The main nervous cord runs along the under or ventral side of the body (Fig. 10), separates near the head, and after passing around the esophagus, enlarges to form the largest of the ganglia, which serves as a brain. From the brain many nerves extend on each side to the compound eyes. The minute nerves extend everywhere, and in squeezing out the viscera of an insect are easily visible.

The organs of circulation in insects are quite insignificant. The heart is a long tube situated along the back, and receives the blood at valvular openings along its sides which only permit the fluid to pass in, when by contraction it is forced towards the head and emptied into the general cavity. Thus the heart only serves to keep the blood in motion. According

to the best authorities, there are no special vessels to carry the blood to various organs. Nor are they necessary, as this nutritive fluid everywhere bathes the alimentary canal, and

FIG. 10.

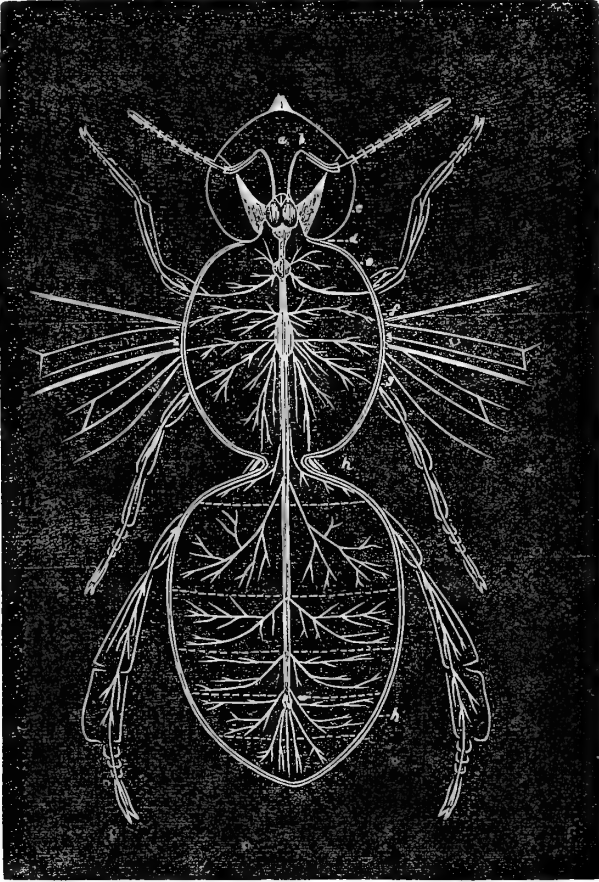

Nerrous system of the Drone magnified four times.

thus easily receives nutriment, or gives waste by osmosis, everywhere surrounds the tracheæ or air-tubes—the insect's lungs—and thus receives that most needful of all food, oxygen, and gives the baneful carbonic acid, everywhere touches the

various organs, and gives and takes as the vital operations of the animal require.

The blood is light colored, and almost destitute of discs or corpuscles, which are so numerous in the blood of higher animals, and which give our blood its red color. The function of these discs is to carry oxygen, and as oxygen is carried everywhere through the body by the ubiquitous air-tubes of insects, we see the discs are not needed. Except these semi-fluid discs, which are real organs, and nourished as are other organs, the blood of higher animals is entirely fluid, in all normal conditions, and contains not the organs themselves or any part of them, but only the elements, which are absorbed by the tissue and converted into the organs, or, to be scientific, are assimilated. As the blood of insects is nearly destitute of these discs, it is almost wholly fluid, and is almost wholly made up of nutritious matter.

The respiratory or breathing system of insects has already been referred to. Along the sides of the body are the spiracles or breathing mouths, which vary in number. These are armed with a complex valvular arrangement which excludes dust or other noxious particles. These spiracles are lined with a delicate membrane which abounds with nerves, which were referred to in speaking of them as smelling organs. From these extends the labyrinth of air-tubes (Fig. 2, *f, f*), which carries vitalizing oxygen into every part of the insect organism. In the more active insects—as in bees—the main tracheæ, one on each side of the abdomen, are expanded into large air-sacks (Fig. 2, *f*). Insects often show a respiratory motion, which in bees is often very marked. Newport has shown that in bees the rapidity of the respiration gauges the heat in the hive, and thus we see why bees, in times of severe cold, which they essay to keep at bay by forced respiration, consume much food, exhale much foul air and moisture, and are liable to disease. Newport found that in cases of severe cold there would be quite a rise of mercury in a thermometer which he suspended in the hive amidst the cluster. In the larval state, many insects breathe by fringe-like gills. The larval mosquito has gills in form of hairy tufts, while in the larval dragon-fly the gills are inside the rectum, or last part of the intestine. This insect, by a muscular effort, draws the water slowly in at the anus, where it bathes these singularly-

placed branchiæ, and then makes it serve a further turn by forcibly expelling it, when the insect is sent darting ahead. Thus this curious apparatus not only furnishes oxygen, but also aids in locomotion. In the pupæ of insects there is little or no motion, yet important organic changes are taking place—the worm-like, ignoble, creeping, often repulsive larva, is soon to appear as the airy, beautiful, active, almost ethereal imago. So oxygen, the most essential—the *sine qua non*—of all animal food, is still needed. The bees are too wise to seal

FIG. 11.

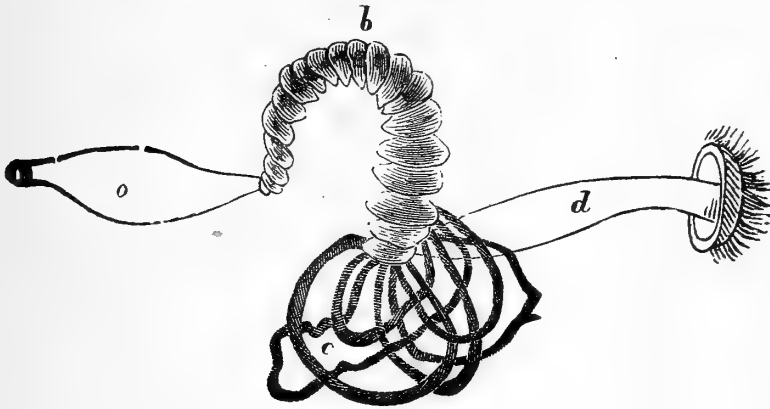

Alimentary Canal.

o—Honey stomach.
c—Urinary tubes.

b—True stomach.
d—Intestine.

the brood-cell with impervious wax, but rather add the porous capping, made of wax and pollen. The pupæ no less than the larvæ of some two-wing flies which live in water, have long tubes which reach far out for the vivifying air, and are thus called rat-tailed. Even the pupa of the mosquito, awaiting in its liquid home the glad time when it shall unfold its tiny wings and pipe its war-note, has a similar arrangement to secure the gaseous pabulum.

The digestive apparatus of insects is very interesting, and, as in our own class of animals, varies very much in length and complexity, as the hosts of insects vary in their habits. As in mammals and birds, the length, with some striking excep-

tions, varies with the food. Carnivorous or flesh-eating insects have a short alimentary canal, while in those that feed on vegetable food it is much longer.

The mouth I have already described. Following this is the throat or pharynx, then the esophagus or gullet, which may expand, as in the bee, to form a honey or sucking stomach (Fig. 11, *o*,) may have an attached crop like the chicken, or may run as a uniform tube, as in the human body, to the true stomach (Fig. 11, *b*). Following this is the intestine—separated by some authors into an ileum and a rectum—which ends in the vent or anus. Connected with the mouth are salivary glands, (Fig. 23) which are structurally like those in higher animals, and in those larvæ that form cocoons are the source of silk. In the glands this is a viscid fluid, but as it leaves the duct it changes instantly into the gossamer thread. Bees and wasps use this saliva in building their structures. With it and mud some wasps make mortar; with it and wood, others their paper cells; with it and wax, the bee fashions the ribbons that are to form the beautiful comb.

Lining the entire alimentary canal are mucous glands which secrete a viscid fluid that keeps the tube soft and promotes the passage of food.

The true stomach (Fig. 11, *b*) is very muscular, and often a gizzard, as in the crickets, where its interior is lined with teeth. The interior of the stomach is glandular, for secreting the gastric juice which is to liquify the food, that it may be absorbed, or pass through the walls of the canal into the blood. Attached to the lower portion of the stomach are numerous urinary tubes (Fig. 11, *c*), though Cuvier, and even Kirby, called these bile tubes. Siebold thinks some of the mucous glands secrete bile, and others act as a pancreas.

The intestine when short, as in larvæ and most carnivora, is straight and but little if any longer than the abdomen, while in most plant-eaters it is long and thus zig-zag in its course. Strange as it may seem, the fecal pellets of some insects are beautiful in form, and of others pleasant to the taste. In some caterpillars they are barrel-shaped, artistically fluted, of brilliant hue, and if fossilized, would be greatly admired, as have been the coprolites—fossil feces of higher animals—if set as gems in jewelry. As it is, they would form no mean parlor ornament. In other insects, as the Aphides or plant-

lice, the excrement, as well as the fluid that escapes in some species from special tubes called the nectaries, is very sweet, and in absence of floral nectar will often be appropriated by bees and conveyed to the hives. In those insects that suck their food, as bees, butterflies, moths, two-wing flies and bugs, the feces are liquid, while in case of solid food the excrement is nearly solid.

SECRETORY ORGANS OF INSECTS.

I have already spoken of the salivary glands, which Kirby gives as distinct from the true silk-secreting tubes, though Newport gives them as one and the same. In many insects these seem absent. I have also spoken of the mucous glands, the urinary tubules, etc. Besides these, there are other secretions which serve for purposes of defense. In the queen and workers of bees, and in ants and wasps, the poison intruded with the sting is an example. This is secreted by glands at the posterior of the abdomen, stored in sacks (Fig. 28, c), and extruded through the sting, as occasion requires. I know of no insects that poison while they bite, except it be mosquitoes, gnats, etc., and in these cases no special secreting organ has been discovered. Perhaps the beak itself secretes an irritating substance. A few exceedingly beautiful caterpillars are covered with branching spines, which sting about like a nettle. We have two such species. They are green, and of rare attraction, so that to capture them is worth the slight inconvenience arising from their irritating punctures. Some insects, like bugs, secrete a disgusting fluid or gas which affords protection, as by its stench it renders these filthy bugs so offensive that even a hungry bird or half-famished insect passes them by on the other side. Some insects secrete a gas which is stored in a sack at the posterior end of the body, and shot forth with an explosion in case danger threatens; thus by noise and smoke it startles its enemy, which beats a retreat. I have heard the little bombardier beetle at such times, even at considerable distances. The frightful reports about the terrible horn of the tomato-worm larva are mere nonsense; a more harmless animal does not exist. My little boy of four years, and girl of only two, used to bring them to me last summer, and regard them as admiringly as would their father upon receiving them from the delighted children.

If we except bees and wasps, there are no true insects that need be feared; nor need we except them, for with fair usage even they are seldom provoked to use their cruel weapon.

SEX ORGANS OF INSECTS.

The male organs consist of the testes (Fig. 12, *a*), which are double. There may be from one, as in the drone bee, to

FIG. 12.

*Male Organs of Drone, much magnified.**a*—Testes.*b, b*—Vasa deferentia.*c, c*—Seminal sacs.*d*—Glandular sacs.*e*—Common duct.*f, g*—Ejaculatory sack.*h*—Penis.*i*—Yellow saccules.

several, as in some beetles, on each side the abdominal cavity. In these vesicles grow the sperm cells or spermatozoa, which, when liberated, pass through a long convoluted tube, the vas deferens (Fig. 12, *b, b*), into the seminal sack (Fig. 12, *c, c*)

where, in connection with mucus, they are stored. In most insects there are glandular sacks (Fig. 12, *d*) joined to these seminal receptacles, which in the male bee are very large. The sperm cells mingled with these viscid secretions, as they

FIG. 13.

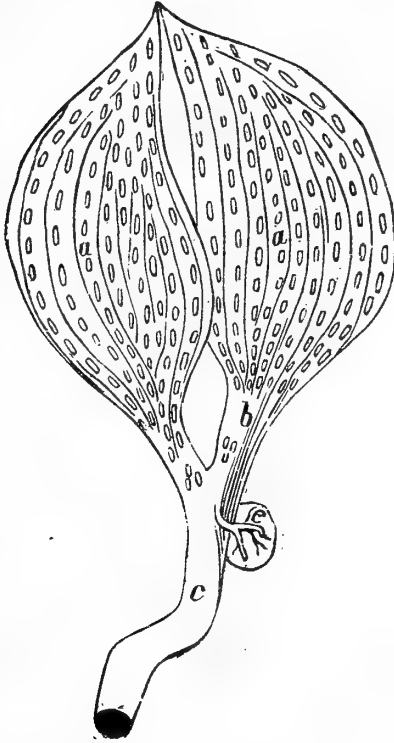

Queen Organs, greatly magnified.

a, a—Ovaries.
b—Oviducts.

c—Oviduct.
e—Spermatheca.

appear in the seminal receptacle ready for use, form the seminal fluid. Extending from these seminal receptacles is the ejaculatory duct (Fig. 12, *e, f, g*), which in copulation carries the male fluid to the penis (Fig. 12, *h*), through which it passes

to the spermatheca of the female. Beside this latter organ are the sheath, the claspers when present, and in the male bee those large yellow glandular sacks (Fig. 12, *i*), which are often seen to dart forth as the drone is held in the warm hand.

The female organs (Fig. 13) consist of the ovaries (Fig. 13, *a, a*), which are situated one on either side of the abdominal cavity. From these extend the two oviducts (Fig. 13, *b*), which unite into the common oviduct (Fig. 13, *c*) through which the eggs pass in deposition. In many insects there is beside this oviduct, and connected with it, a sack (Fig. 13, *e*) called the spermatheca, which receives the male fluid in copulation, and which, by extruding its contents, must ever after do the work of impregnation.

This sack was discovered and its use suggested by Malpighi as early as 1686, but its function was not fully demonstrated till 1792, when the great anatomist, John Hunter, showed that in copulation this was filled. The ovaries are multitubular organs. In some insects, as fertile workers, there are but very few tubes—two or three; while in the queen bee there are more than one hundred. In these tubes the ova or eggs grow, as do the sperm cells in the vesicles of the testes. The number of eggs is variable. Some insects, as the mud-wasps, produce very few, while the queen white-ant extrudes millions. The end of the oviduct, called the ovipositor, is wonderful in its variation. Sometimes it consists of concentric rings, like a spy-glass, which may be pushed out or drawn in; sometimes of a long tube armed with augers or saws of wonderful finish, to prepare for eggs; or again of a tube which may also serve as a sting.

Most authors state that insects copulate only once, or at least that the female meets the male but once. My pupil, Clement S. Strang, who made a special study of the structure and habits of bugs during the past season, noticed that the squash-bugs mated many times. It would be interesting to know whether these females possess the spermatheca. In some cases, as we shall see in the sequel, the male is killed by the copulatory act. I think this curious fatality is limited to few species.

To study viscera, which of course requires very careful dissection, we need more apparatus than has been yet described. Here a good lens is indispensable. A small dissecting knife, a delicate pair of forceps, and some small sharp-pointed dis-

secting scissors—those of the renowned Swammerdam were so fine at the point that it required a lens to sharpen them—which may also serve to clip the wings of queens, are requisite to satisfactory work. Specimens put in alcohol will be improved, as the oil will be dissolved out and the muscles hardened. Placing them in hot water will do nearly as well, in which case oil of turpentine will dissolve off the fat. This may be applied with a camel's-hair brush. By dissecting under water the loose portions will float off, and render effective work more easy. Swammerdam, who had that most valuable requisite to a naturalist, unlimited patience, not only dissected out the parts, but with small glass tubes, fine as a hair, he injected the various tubes, as the alimentary canal and air-tubes. My reader, why may not you look in upon those wondrous beauties and marvels of God's own handiwork—nature's grand exposition? Father, why would not a set of dissecting instruments be a most suitable gift to your son? You might thus sow the seed which would germinate into a Swammerdam, and that on your own hearth-stone. Messrs. Editors, why do not you, among your apiarian supplies, keep boxes of these instruments, and thus aid to light the torch of genius and hasten apiarian research?

TRANSFORMATIONS OF INSECTS.

What in all the realm of nature is so worthy to awaken delight and admiration as the astonishing changes which insects undergo? Just think of the sluggish, repulsive caterpillar, dragging its heavy form over clod or bush, or mining in dirt and filth, changed, by the wand of nature's great magician, first into the motionless chrysalis, decked with green and gold, and beautiful as the gem that glitters on the finger of beauty, then bursting forth as the graceful, gorgeous butterfly; which, by its brilliant tints and elegant poise, outrivals even the birds among the life-jewels of nature, and is made fit to revel in all her decorative wealth. The little fly, too, with wings dyed in rainbow-hues; flitting like a fairy from leaf to flower, was but yesterday the repulsive maggot, reveling in the veriest filth of decaying nature. The grub to-day drags its slimy shape through the slums of earth, on which it fattens; to-morrow it will glitter as the brilliant setting in the bracelet and ear-drops of the gay and thoughtless belle.

There are four separate stages in the development of insects: The egg, the larva, the pupa, and the imago.

THE EGG.

This is not unlike the same in higher animals. It has its yolk and its surrounding white or albumin, like the eggs of all mammals, and farther, the delicate shell, which is familiar in the eggs of birds and reptiles. Eggs of insects are often beautiful in form and color, and not infrequently ribbed and fluted as by a master hand. The form of eggs is very various—spherical, oval, cylindrical, oblong, straight, and curved (Fig. 15, *b*). All insects seem to be guided by a wonderful knowledge, or instinct, or intelligence, in the placing of eggs on or near the peculiar food of the larva, even though in many cases such food is no part of the aliment of the imago. The fly has the refined habits of the epicure, from whose cup it daintily sips, yet its eggs are placed in the horse-droppings of stable and pasture.

Inside the egg wonderful changes soon commence, and their consummation is a tiny larva. Somewhat similar changes can be easily and most profitably studied by breaking and examining a hen's egg each successive day of incubation. As with the eggs of our own species and of all higher animals, the egg of insects, or the yolk, the essential part—the white is only food, so to speak—soon segments or divides into a great many cells which soon unite into a membrane, the blastoderm, which is the initial animal. This blastoderm soon forms a single sack, and not a double sack, one above the other, as in our own vertebrate branch. This sack, looking like a miniature bag of grain, grows by absorption, becomes articulated, and by budding out is soon provided with the various members. As in higher animals, these changes are consequent upon heat, and usually, not always, upon the incorporation within the eggs of the sperm cells from the male, which enter the eggs at openings called micropyles. The time it takes the embryo inside the egg to develop is gauged by heat, and will, therefore, vary with the season and temperature, though in different species it varies from days to months. The number of eggs which an insect may produce, is subject to wide variation.

THE LARVA OF INSECTS.

From the egg comes the larva, also called grub, maggot, caterpillar, and very erroneously worm. These are worm-shaped (Fig. 14), usually have strong jaws, simple eyes, and the body plainly marked into ring divisions. Often, as in case

FIG. 14.

*Larva of Bee.*

of some grubs, larval bees, and maggots, there are no legs. In most grubs there are six legs, two to each of the three rings succeeding the head. Besides these, caterpillars have usually ten prop-legs farther back on the body, though a few—the loopers or measuring caterpillars—have only four or six, while the larvæ of the saw-flies have from twelve to sixteen of the false or prop-legs. The alimentary canal of larval insects is usually short, direct, and quite simple, while the sex-organs are slightly if at all developed. The larvæ of insects are voracious eaters—indeed, their only work seems to be to eat and grow fat. As the entire growth occurs at this stage, their gormandizing habits are the more excusable. I have often been astonished at the amount of food that the insects in my breeding cases would consume. The length of time which insects remain as larvæ is very variable. The maggot revels in decaying meat but two or three days; the larval bee eats its rich pabulum for nearly a week; the apple-tree borer gnaws away for three years; while the seventeen-year cicada remains a larva for more than sixteen years, groping in darkness and feeding on roots, only to come forth for a few days of hilarity, sunshine, and courtship. Surely, here is patience exceeding even that of Swammerdam. The name larva, meaning masked, was given to this stage by Linnæus, as the mature form of the insect is hidden, and cannot be even divined by the unlearned.

THE PUPA OF INSECTS.

In this stage the insect is in profound repose, as if resting after its meal, the better to enjoy its active, sportive days—the

joyous honey-moon—soon to come. At this time the insect may look like a seed, as in the coarctate pupa of diptera, so familiar in the “flax-seed” state of the Hessian-fly, or in the pupa of the cheese-maggot, or the meat-fly. This same form, with more or less modification, prevails in butterfly pupæ, called, because of their golden spots, chrysalids, and in the pupæ of moths. Other pupæ, as in the case of bees (Fig. 15, *g*) and beetles, look not unlike the mature insect with its

FIG. 15.

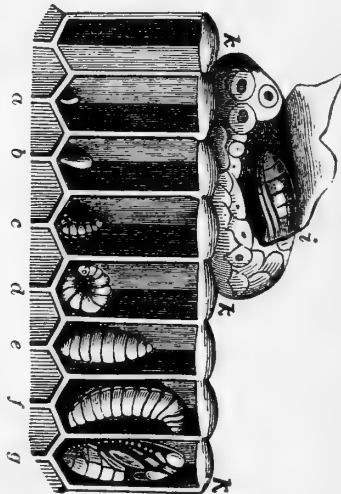
*Development of the Bee.*

antennæ, legs, and wings closely bound to the body by a thin membrane, hence the name pupa which Linne gave—referring to this condition—as the insect looks as if wrapped in swaddling clothes, the old cruel way of torturing the infant, as if it needed holding together. Aristotle called pupæ “nymphs”—a name now given to this stage in bees—which name was adopted by many entomologists of the seventeenth and eighteenth centuries. Inside the pupa skin great changes are in progress, for either by modifying the larval organs or developing parts entirely new, by use of the accumulated material stored by the larva during its prolonged banquet, the wonderful transformation from the sluggish, worm-like larva to the active, bird-like

imago is accomplished. Sometimes the pupa is surrounded by a silken cocoon, either thick, as the cocoon of some moths, or thin, as the cocoon of bees. These cocoons are spun by the larvæ as their last toil before assuming the restful pupa state. The length of time in the pupa-stage varies from a few days to as many months. Sometimes insects which are two-brooded remain as pupæ but a few days in summer, while in winter they are months passing the quiescent period. Our cabbage-butterfly illustrates this peculiarity. Others, like the Hessian-fly and codling-moth, remain through the long, cold months as larvæ. How wonderful is this! The first brood of larvæ change to pupæ at once, the last brood, though the weather be just as hot, wait over inside the cocoon till the warm days of coming spring.

THE IMAGO STAGE.

This term refers to the last or winged form, and was given by Linnæus because the image of the insect is now real and not masked as when in the larva state. Now the insect has its full-formed legs and wings, its compound eyes, complex mouth-parts, and the fully developed sex-organs. In fact, the whole purpose of the insect now seems to be to reproduce itself. Many insects do not even eat, only flit in merry marriage mood for a brief space, when the male flees this life to be quickly followed by the female, she only waiting to place her eggs where the prospective infants may find suitable food. Some insects not only place their eggs, but feed and care for their young, as do ants, wasps and bees. Again, as in case of some species of ants and bees, abortive females perform all, or most, of the labor in caring for the young. The life of the imago also varies much as to duration. Some live but for a day, others make merry for several days, while a few species live for months. Very few imagos survive the whole year.

INCOMPLETE TRANSFORMATION.

Some insects, like the bugs, lice, grasshoppers, and locusts, are quite alike at all stages of growth, after leaving the egg. The only apparent difference is the smaller size and the absence or incomplete development of the wings in the larvæ and pupæ. The habits and structure from first to last seem to be much the same. Here, as before, the full development of the sex-organs occurs only in the imago.

ANATOMY AND PHYSIOLOGY OF THE HONEY-BEE.

With a knowledge of the anatomy and some glimpses of the physiology of insects in general, we shall now find it easy to learn the special anatomy and physiology of the highest insects of the order.

THREE KINDS OF BEES IN EACH FAMILY.

As we have already seen, a very remarkable feature in the economy of the honey-bee, described even by Aristotle, which is true of many other bees, and also of ants and many wasps, is the presence in each family of three distinct kinds, which differ in form, color, structure, size, habits and function. Thus we have the queen (Lubbock has shown that there are several queens in an ant colony), a number of drones, and a far greater number of workers. Huber, Bevan, Munn, and Kirby also speak of a fourth kind, blacker than the usual workers. These are accidental, and are, as conclusively shown by Von Berlepsch, ordinary workers, more deeply colored by age, loss of hair, dampness, or some other atmospheric condition. American apiarists are too familiar with these black bees, for after our severe winters, they prevail in the colony, and, as remarked by the noted Baron, "They quickly disappear." Munn also tells of a fifth kind, with a top-knot, which appears at swarming seasons. I am at a great loss to know what he refers to, unless it be the pollen masses of the *asclepias*, or milk-weed, which sometimes fasten to our bees and become a severe burden.

THE QUEEN' BEE.

The queen (Fig. 16), although referred to as the mother bee, was called the king by Virgil, Pliny, and by writers as late as the last century, though in the ancient "Bee Master's Farewell," by John Keys, published in London in 1796, I find an admirable description of the queen bee, with her function correctly stated. Réaumur, as quoted by "Wildman on Bees," published in London in 1770, says "this third sort has a grave and sedate walk, is armed with a sting, and is mother of all the others."

Huber, to whom every apiarist owes so much, and who,

though blind, through the aid of his devoted wife and intelligent servant, Frances Burnens, developed so many interesting truths, demonstrated the fact of the queen's maternity. This author's work, second edition, published in Edinburgh in 1808, gives a full history of his wonderful observations and experiments, and must ever rank with Langstroth as a classic, worthy of study by all.

The queen, then, is the mother bee ; in other words, a fully developed female. Her ovaries (Fig. 13, *a, a*) are very large, nearly filling her long abdomen. The tubes already described as composing them are very numerous, while the spermatheca (Fig. 13, *e*) is plainly visible. This is muscular, receives abundant nerves, and thus, without doubt, may or may not be compressed to force the sperm cells into contact with the eggs as they pass by the duct. Leukart estimates that the spermatheca will hold more than 25,000,000 spermatozoa.

FIG. 18.

FIG. 17.

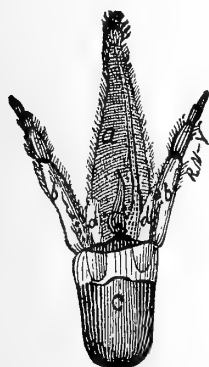

Labium of Queen.

a—Ligula.
d, d—Paraglossæ.
b—Labial palpi.



Part of Leg of Queen, magnified.

t—Tibia.
t, s—Tarsal joints. *p*—Broadened tibia and basal tarsus.

FIG. 16.



Queen Bee, magnified.

The possession of the ovaries and attendant organs, is the

chief structural peculiarity which marks the queen, as these are the characteristic marks of females among all animals. But she has other peculiarities worthy of mention: She is longer than either drones or workers, being more than seven-eighths of an inch in length, and, with her long tapering abdomen, is not without real grace and beauty. The queen's mouth organs are developed to a less degree than are those of the worker bees. Her jaws (Fig. 24, *b*) or mandibles are weaker, with a rudimentary tooth, and her tongue or ligula (Fig. 17, *a*), as also the labial palpi (Fig. 17, *b*) and maxillæ, are considerably shorter. Her eyes, like the same in the worker-bee (Fig. 5), are smaller than those of the drones, and do not meet above. So the three ocelli are situated above and between the compound eyes. The queen's wings (Fig. 16) are relatively shorter than those of either the workers or drones, for instead of attaining to the end of the body, they reach but little beyond the third joint of the abdomen. The queen, though she has the characteristic posterior tibia and basal tarsus (Fig. 18, *p*), in respect to breadth, has not the cavity and surrounding hairs which form the pollen baskets of the workers. The queen possesses a sting which is longer than that of the workers, and resembles that of the bumble-bees in being curved, and that of bumble-bees and wasps in having few and short barbs—the little projections which point back like the barb of a fish-hook, and which, in case of the workers, prevent the withdrawing of the instrument, when once fairly inserted. While there are seven quite prominent barbs on each shaft of the worker's sting, there are only three on those of the queen, and these are very short, and, as in a worker's sting, are successively shorter as we recede from the point of the weapon. Aristotle says that the queen will seldom use her sting, which I have found true. I have often tried to provoke a queen's anger, but never with any evidence of success. Neighbour (page 14, note) gives three cases where queens used their stings, in one of which cases she was disabled from farther egg-laying. She stings with slight effect.

The queen, like the neuters, is developed from an impregnated egg, which, of course, could only come from a queen that had previously mated. These eggs are not placed in a horizontal cell, but in one specially prepared for their reception (Fig. 15, *i*). The queen cells are usually built on the

edge of the comb, or around an opening in it, which is necessitated from their size and form, as usually the combs are too close together to permit their location elsewhere. These cells extend either vertically or diagonally downward, are composed of wax mixed with pollen, and in size and form much resemble a pea-nut. The eggs must be placed in these cells, either by the queen or workers. Huber, who though blind had wondrous eyes, witnessed the act. I have frequently seen eggs in these cells, and without exception in the exact position in which the queen always places her eggs in the other cells. John Keys, in the old work already referred to, whose descriptions, though penned so long ago, are wonderfully accurate and indicate great care, candor, and conscientious truthfulness, asserts that the queen is five times as long laying a royal egg as she is the others. From the character of his work, and its early publication, I can but think that he had witnessed this rare sight. Some candid apiarists of our own time and country—E. Gallup among the rest—claim to have witnessed the act. The eggs are so well glued, and are so delicate, that, with Neighbour, I should doubt the possibility of a removal except that some persons assert that they have positive proof that it is sometimes done. Possibly the young larvæ may at times be removed from one cell to another. The opponents to this view base their belief on a supposed discord between the queen and neuters. This antagonism is inferred, and I have but little faith in the inference, or the argument from it. I know that when royal cells are to be torn down, and inchoate queens destroyed, the workers aid the queen in this destruction. I have also seen queens pass by unguarded queen-cells, and yet respect them. I have also seen several young queens dwelling amicably together in the same hive. Is it not probable that the bees are united in whatever is to be accomplished, and that when queens are to be destroyed all spring to the work, and when they are to live all regard them as sacred? It is true that the actions of bees are controlled and influenced by the surrounding conditions or circumstances, but I have yet to see satisfactory proof of the old theory that these conditions impress differently the queen and the workers. The conditions which lead to the building of queen-cells and the peopling of the same are: Loss of queen, when a worker larva from one to four days old will be surrounded by a cell;

inability of a queen to lay impregnated eggs, her spermatheca having become emptied; great number of worker-bees in the hive; restricted quarters; the queen not having place to deposit eggs, or the workers little or no room to store honey; or lack of ventilation, so that the hive becomes too close. These last three conditions are most likely to occur at times of great honey secretion.

A queen may be developed from an egg, or, as first shown by Schirach, from a worker larva less than three days old. (Mr. Doolittle has known queens to be reared from worker larvæ taken at four-and-a-half days from hatching.) In the latter case, the cells adjacent to the one containing the selected larva are removed, and the larva surrounded by a royal cell. The development of the queen larva is much like that of the worker, soon to be detailed, except that it is more rapid, and the queen larva is fed richer and more plenteous food, called royal jelly. This peculiar food, as also its use and abundance in the cell, was first described by Schirach, a Saxon clergyman, who wrote a work on bees in 1771. According to Hunter, this royal pabulum is richer in nitrogen than that of the common larvæ. It is thick, like rich cream; slightly yellow, and so abundant that the queen larva not only floats in it during all its period of growth, but quite a large amount remains after her queenship vacates the cell. We often find this royal jelly in incomplete queen-cells, without larvæ. Mr. Quinby suggested that this is stored for future use.

What a mysterious circumstance is this: These royal scions simply receive a more abundant and sumptuous diet, and occupy a more ample habitation—for I have more than once confirmed the statement of Mr. Quinby, that the direction of the cell is immaterial—and yet what a marvelous transformation. Not only are the ovaries developed and filled with eggs, but the mouth-organs, the wings, the legs, the sting, eye, even the size, form, and habits, are all wondrously changed. That the development of parts should be accelerated, and the size increased, is not so surprising—as in breeding other insects I have frequently found that kind and amount of food would hasten or retard growth, and might even cause a dwarfed imagó—but that food should so essentially modify the structure, is certainly a rare and unique circumstance, hardly to be found except here and in related animals. Bevan has sug-

gested that fertile workers, while larvæ, have received some of this royal jelly, from their position near a developing queen. Langstroth supposes that they receive some royal jelly, purposely given by the workers, and I had previously thought this reasonable and probably true. But these pests of the apiarist, and especially of the breeder, almost always, so far as I have observed, make their appearance in colonies long queenless, and I have noticed a case similar to that given by Quinby, where these occurred in a nucleus where no queen had been developed. May it not be true that a desire for eggs stimulates the growth of the ovaries, growth of eggs in the ovarian tubes, and consequent ability to deposit? The common high-holder, *Colaptes auratus*—a bird belonging to the wood-pecker family, usually lays five eggs, and only five; but let cruel hands rob her of these promises of future loved ones, and, wondrous to relate, she continues to lay more than a score. One thus treated, here on the College campus, actually laid more than thirty eggs. So we see that animal desires may influence and move organs that are generally independent of the will.

The larval queen is longer, and more rapid of development than the other larvæ. When developed from the egg—as in case of normal swarming—the larva feeds for five days, when the cell is capped by the workers. The infant queen then spins her cocoon, which occupies about one day. The end of the cocoon is left open. Some one has suggested that this is an act of thoughtful generosity on the part of the queen larva, thus to render her own destruction more easy, should the welfare of the colony demand it, as now a sister queen may safely give the fatal sting. The queen now spends nearly three days in absolute repose. Such rest is common to all cocoon-spinning larvæ. The spinning, which is done by a rapid motion to-and-fro of the head, always carrying the delicate thread, much like the moving shuttle of the weaver, seems to bring exhaustion and need of repose. She now assumes the nymph, or pupa, state (Fig. 15, *i*). At the end of the sixteenth day she comes forth a queen. Huber states that when a queen emerges the bees are thrown into a joyous excitement, so that he noticed a rise in temperature in the hive from 92° F. to 104° F. I have never tested this matter accurately, but I have failed to notice any marked demonstration on the natal

day of her lady-ship the queen, or extra respect paid her as a virgin. When queens are started from worker larvæ, they will issue as imagos in ten or twelve days from the date of their new prospects. Mr. Doolittle writes me that he has known them to issue in eight and one-half days. My own observations sustain the assertion of Mr. P. L. Viallon that the minimum time is nine and one-half days.

As the queen's development is probably due to superior quality and increased quantity of food, it would stand to reason that queens started from eggs are preferable; the more so as, under normal circumstances, I believe they are almost always thus started. The best experience sustains this position. As the proper food and temperature can best be secured in a full colony—and here again the natural economy of the hive adds to our argument—we should infer that the best queens would be reared in strong colonies, or at least kept in such colonies till the cells were capped. Experience also confirms this view. As the quantity and quality of food and the general activity of the bees are directly connected with the full nourishment of the queen-larva, and as these are only at the maximum in times of active gathering—the time when queen-rearing is naturally started by the bees—we should also conclude that queens reared at such seasons are superior. My experience—and I have carefully observed in this connection—most emphatically sustains this view.

Five or six days after issuing from the cell—Neighbour says the third day—if the day is pleasant the queen goes forth on her “marriage flight;” otherwise she will improve the first pleasant day thereafter for this purpose. Huber was the first to prove that impregnation always takes place on the wing. Bonnet also proved that the same is true of ants, though in this case millions of queens and drones often swarm out at once. I have myself witnessed several of these wholesale matrimonial excursions among ants. I have also frequently taken bumble-bees that were copulating while on the wing. I have also seen both ants and bumble-bees fall while united, probably borne down by the expiring males. That butterflies, moths, dragon-flies, etc., mate on the wing is a matter of common observation. It has generally been thought impossible for queens in confinement to be impregnated. Prof. Leuckart believes that successful mating demands that the

large air-sacks (Fig. 2, *f*) of the drones shall be filled, which he thinks is only possible during flight. The demeanor of the drones suggests that the excitement of flight, like the warmth of the hand, is necessary to induce the sexual impulse.

Many others with myself have followed Huber in clipping the virgin queen's wing, only to produce a sterile, or drone laying queen. One queen, however, the past season, whose wing was clipped just as she came from the cell, and the entrance to whose hive was guarded by perforated zinc so the queen could not get out, was impregnated, and proved an excellent queen. So it seems more than possible that mating in confinement may yet become practicable.

If the queen fails to find an admirer the first day, she will go forth again and again till she succeeds. Huber states that after twenty-one days the case is hopeless. Bevan states that if impregnated from the fifteenth to the twenty-first she will be largely a drone laying queen. That such absolute dates can be fixed in either of the above cases is very questionable. Yet all experienced breeders know that queens kept through the winter as virgins are sure to remain so. It is quite likely that the long inactivity of the spermatheca wholly or in part paralyzes it, so that queens that are late in mating cannot impregnate the eggs as they desire. This would accord with what we know of other muscular organs. Berlepsch believed that a queen that commenced laying as a virgin could never lay impregnated eggs, even though she afterwards mated. Langstroth thought that he had observed to the contrary.

If the queen be observed after a successful "wedding tour," she will be seen, as first pointed out by Huber, to bear the marks of success in the pendant drone appendages, consisting of the penis, the yellow cul-de-sacks, and the hanging thread-like ducts (Fig. 12), which are still held in the vulva of the queen.

It is not at all likely that a queen, after she has met a drone, ever leaves the hive again except when she leaves with a swarm. Some of the observing apiarists think that an old queen may be again impregnated. The fact that queens, with clipped wings, are fertile as long as others, makes me think that cases which have led to such conclusions are capable of other explanation.

If the queen lays eggs before meeting the drone, or if for

any reason she fails to mate, her eggs will only produce male bees. This strange anomaly—development of the eggs without impregnation—was discovered and proved by Dzierzon, in 1845. Dr. Dzierzon, who, as a student of practical and scientific apiculture, must rank with the great Huber, is a Roman Catholic priest of Carlsmarkt, Germany. This doctrine—called parthenogenesis, which means produced from a virgin—is still doubted by some quite able bee-keepers, though the proofs are irrefragable: 1st. Unmated queens will lay eggs that will develop, but drones always result. 2d. Old queens often become drone-layers, but examination shows that the spermatheca is void of seminal fluid. Such an examination was first made by Prof. Siebold, the great German anatomist, in 1843, and later by Leuckart and Leidy. I have myself made several such examinations. The spermatheca can easily be seen by the unaided vision, and by crushing it on a glass slide, by compressing with a thin glass cover, the difference between the contained fluid in the virgin and in the impregnated queen is very patent, even with a low power. In the latter it is more viscid and yellow, and the vesicle more distended. By use of a high power, the active spermatozoa or sperm-cells become visible. 3d. Eggs in drone-cells are found by the microscopist to be void of the sperm-cells, which are always found in all other fresh-laid eggs. This most convincing and interesting observation was first made by Von Siebold, at the suggestion of Berlepsch. It is quite difficult to show this. Leuckart tried before Von Siebold, at Berlepsch's apiary, but failed. I have also tried to discover these sperm-cells in worker-eggs, but as yet have been unsuccessful. Siebold has noted the same facts in eggs of wasps. 4th. Dr. Dönhoff, of Germany, in 1855, took an egg from a drone-cell, and by artificial impregnation produced a worker-bee. Such an operation, to be successful, must be performed as soon as the egg is laid.

Parthenogenesis, in the production of males, has also been found by Siebold to be true of other bees and wasps, and of some of the lower moths in the production of both males and females. Adler has shown that this agamic reproduction prevails among the Chalcididæ, a family of parasitic Hymenoptera, and it has long been known to characterize the cynips or gall-flies; while the great Bonnet first discovered what may be

noticed on any summer day all about us, even on the house-plants at our very windows, that parthenogenesis is best illustrated by the aphides, or plant lice. In the fall males and females appear which mate, when the females lay eggs which in the spring produce only females; these again produce only females, and thus on for several generations, till with the cold of autumn come again the males and females. Bonnet observed seven successive generations of productive virgins. Duval noted nine generations in seven months, while Kyber observed production exclusively by parthenogenesis in a heated room for four years. So, we see that this strange and almost incredible method of increase is not rare in the great insect world.

About two days after she is impregnated, the queen, under normal circumstances, commences to lay, usually worker-eggs, and if the condition of the hive impels to no further swarming that season, no drones will be required and so only worker-eggs will be laid. In many localities and in certain favorable years in all localities, however, further swarming will occur.

It is frequently noticed that the young queen at first lays quite a number of drone-eggs. Queen-breeders often observe this in their nuclei. This continues for only a few days. This does not seem strange. The act of forcing the sperm-cells from the spermatheca is muscular and voluntary, and that these muscles should not always act promptly at first, is not strange, nor is it unprecedented. Mr. Wagner suggested that the size of the cell determined the sex, as in the small cells the pressure on the abdomen forced the fluid from the spermatheca. Mr. Quinby also favored this view. I greatly question this theory. All observing apiarists have known eggs to be laid in worker-cells, ere the cell was hardly commenced, when there could be no pressure. In case of queen-cells, too, if the queen does lay the eggs—as I believe—these would be unimpregnated, as the cell is very large. I know the queen sometimes passes from drone to worker-cells very abruptly while laying, as I have witnessed such a procedure—the same that so greatly rejoiced the late Baron of Berlepsch, after weary hours of watching—but that she can thus control at the instant this process of adding or withholding the sperm-cells certainly seems not so strange as that the spermatheca, hardly bigger than a pin-head, could supply these cells for months, yes,

and for years. Who that has seen the bot-fly dart against the horse's legs, and as surely leave the tiny yellow egg, can doubt but that insects possess very sensitive oviducts, and can extrude the minute eggs *just* at pleasure. That a queen may force single eggs, at will, past the mouth of the spermatheca, and at the same time add or withhold the sperm-cells, is, I think, without question, true. What gives added force to this view is the fact that other bees, wasps and ants exercise the same volition, and can have no aid from cell-pressure, as all the eggs are laid in receptacles of the same size. As already remarked, the males and workers of *Apis dorsata* are developed in the same sized cells, while the males of *A. Indica* are smaller than the workers. The Baron of Berlepsch, worthy to be a friend of Dzierzon, has fully decided the matter. He has shown that old drone cells are as small as new worker-cells, and yet each harbors its own brood. Very small queens, too, make no mistakes. With no drone-cells, the queen will sometimes lay drone-eggs in worker-cells, in which drones will then be reared, and she will, if she must, though with great reluctance, lay worker-eggs in drone-cells.

Before laying an egg, the queen takes a look into the cell, probably to see if all is right. If the cell contains any honey, pollen, or an egg, she usually passes it by, though when crowded, a queen will sometimes, especially if young, insert two or three eggs in a cell, and sometimes, when in such cases she drops them, the bees show their dislike of waste, and appreciation of good living, by making a breakfast of them. If the queen find the cell to her liking, she turns about, inserts her abdomen, and in an instant the tiny egg is glued in position (Fig. 15, *b*) to the bottom of the cell.

The queen, when considered in relation to the other bees of the colony, possesses a surprising longevity. It is not uncommon for her to attain the age of three years in the full possession of her powers, while queens have been known to do good work for five years. Lubbock has queen ants in his nests that are eight years old, and still they are vigorous layers. Queens, often at the expiration of one, two, three or four years, depending on their vigor and excellence, either cease to be fertile, or else become impotent to lay impregnated eggs—the spermatheca having become emptied of its sperm cells. In such cases the workers usually supersede the queen, that is,

they rear a new queen, before all the worker-eggs are gone, and then destroy the old one.

It sometimes happens, though rarely, that a fine-looking queen, with full-formed ovaries and large spermatheca well-filled with male fluid, will deposit freely, but none of the eggs will hatch. Readers of bee-papers know that I have frequently received such for dissection. The first I ever got was a remarkably fine looking Italian, received from the late Dr. Hamlin, of Tennessee. All such queens that I have examined seem perfect, even though scrutinized with a high power objective. We can only say that the egg is at fault, as frequently transpires with higher animals, even to the highest. These females are barren; through some fault with the ovaries, the eggs grown therein are sterile. To detect just what is the trouble with the egg is a very difficult problem, if it is capable of solution at all. I have tried to determine the ultimate cause, but without success.

The function of the queen is simply to lay eggs, and thus keep the colony populous, and this she does with an energy that is fairly startling. A good queen in her best estate will lay two or three thousand eggs a day. I have seen a queen in my observing hive lay for some time at the rate of four eggs per minute, and have proved by actual computation of brood cells that a queen may lay over three thousand eggs in a day. Langstroth and Berlepsch both saw queens lay at the rate of six eggs a minute. The latter had a queen that laid three thousand and twenty-one eggs in twenty-four hours, by actual count, and in twenty days she laid fifty-seven thousand. This queen continued prolific for five years, and must have laid, says the Baron, at a low estimate more than 1,300,000 eggs. Dzierzon says queens may lay 1,000,000 eggs, and I think these authors have not exaggerated. Yet, with even these figures as an advertisement, the queen bee cannot boast of superlative fecundity, as the queen white-ant—an insect closely related to the bees in habits, though not in structure, as the white-ants are lace-wings and belong to the sub-order Neuroptera, which includes our day-flies, dragon-flies, etc.—is known to lay over 80,000 eggs daily. Yet this poor helpless thing, whose abdomen is the size of a man's thumb and composed almost wholly of eggs, while the rest of her body is not larger than the same in our common ants, has no other

amusement; she cannot walk; she cannot even feed herself, or care for her eggs. What wonder then that she should attempt big things in the way of egg-laying? She has nothing else to do, or to feel proud of.

Different queens vary as much in fecundity as do different breeds of fowls. Some queens are so prolific that they fairly demand hives of India rubber to accommodate them, keeping their hives gushing with bees and profitable activity; while others are so inferior that the colonies make a poor, sickly effort to survive at all, and usually succumb early, before those adverse circumstances which are ever waiting to confront all life on the globe. The activity of the queen is governed largely by the activity of the workers. The queen will either lay sparingly, or stop altogether, in the interims of storing honey, while, on the other hand, she is stimulated to lay to her utmost capacity when all is life and activity in the hive. This refusal to lay when nectar is wanting does not hold true, apparently, with the Cyprian and the Syrian bees.

It would seem that the queen either reasons from conditions, is taught by instinct, or else that without her volition the general activity of the worker-bees stimulates the ovaries, how we know not, to grow more eggs. We know that such a stimulus is born of desire, in case of the high-holder already referred to. That the queen may have control of the activity of her ovaries, either directly or indirectly, through reflex nervous action induced by the general excitement of the bees, which always follows active storing, is not only possible but is quite likely.

The old poetical notion that the queen is the revered and admired sovereign of the colony, whose pathway is ever lined by obsequious courtiers, whose person is ever the recipient of loving caresses, and whose will is law in this bee-hive kingdom, controlling all the activities inside the hive and leading the colony whithersoever it may go, is unquestionably mere fiction. In the hive, as in the world, individuals are valued for what they are worth. The queen, as the most important individual, is regarded with solicitude, and her removal or loss is noted with consternation, as the welfare of the colony is threatened; yet, let the queen become useless, and she is despatched with the same absence of emotion that characterizes the destruction of the drones when they have become

supernumeraries. It is very doubtful if emotion and sentimentality are ever moving forces among the lower animals. There are probably certain natural principles that govern in the economy of the hive, and anything that conspires against, or tends to intercept, the action of these principles, becomes an enemy to the bees. All are interested, and doubtless more united than is generally believed, in a desire to promote the free action of these principles. No doubt the principle of antagonism among the various bees has been overrated. Even the drones, when they are being killed off in the autumn, make a sickly show of defense, as much as to say, the welfare of the colony demands that such worthless vagrants should be exterminated. The statement that there is often serious antagonism between the queen and workers, as to the destruction or preservation of inchoate queens, yet in the cell, is a matter which may well be investigated. It is most probable that what tends most for the prosperity of the colony is well understood by all, and without doubt there is harmonious action among all the denizens of the hive to foster that which will advance the general welfare, or to make war on whatever may tend to interfere with it. If the course of any of the bees seems wavering and inconsistent, we may rest assured that circumstances have changed, and that could we perceive the bearing of all the surrounding conditions, all would appear consistent and harmonious.

THE DRONES.

These are the male bees, and are generally found in the hive only from May to November; though they may remain all winter, and are not infrequently absent during the summer. Their presence or absence depends on the present and prospective condition of the colony. If they are needed, or likely to be needed, then they are present. There are in nature several hundred in each colony. The number may and should be greatly reduced by the apiarist. The drones (Fig. 19) are shorter than the queen, being less than three-fourths of an inch in length, are more robust and bulky than either the queen or workers, and are easily recognized when flying by their loud, startling hum. As in other societies, the least useful make the most noise. This loud hum is caused by the less rapid vibration of their large, heavy wings. Their

flight is more heavy and lumbering than that of the workers. Their ligula, labial palpi and maxillæ—like the same in the queen bee—are short, while their jaws (Fig. 24, *a*) possess the rudimentary tooth, and are much the same in form as those of the queen, but are heavier, though not so strong as those of the workers. Their eyes (Fig. 4) are very prominent, meet above, and thus the simple eyes are thrown forward. Their posterior legs are convex on the outside (Fig. 20), so, like the queens, they have no pollen baskets. The drones are without the defensive organ, having no sting, while their special sex-organs (Fig. 12) are not unlike those of other insects; and have already been sufficiently described.

FIG. 19.

*Drone Bee, magnified.*

FIG. 20.

*Part of Leg of Drone, magnified.*

t—Tibia.
p—Broadened tibia and basal tarsus.
ts—Joints of Tarsus.
c—Claws.

It was discovered by Dzierzon, in 1845, that the drones hatch from unimpregnated eggs. This strange phenomenon,

seemingly so incredible, is, as has been shown in speaking of the queen, easily proved and beyond question. These eggs may come from an unimpregnated queen, a fertile worker—which will soon be described—or an impregnated queen who may voluntarily prevent impregnation. It is asserted by some that the workers can change a worker egg to a drone egg at will. When the workers are able to abstract the sperm cells, which are so small that we can only see them by using a high power microscope, then we may expect to see wheat turn to chess. Such eggs will usually be placed in the larger horizontal cells (Fig. 31, *a*), in manner already described. As stated by Bevan, the drone feeds six and a half days as a larva, before the cell is capped. The capping of the drone-cells is very convex, and projects beyond the plane of the same in worker-cells, so that the drone brood is easily distinguished from worker, and from the darker color—the wax being thicker and less pure—the capping of both drone and worker brood-cells enables us easily to distinguish them from honey-cells. In twenty-four days from the laying of the eggs, the drones come forth from the cells. Of course, variation of temperature and other conditions, as variable amount of diet, may slightly retard or advance the development of any brood, in the different stages. The drones—in fact all bees—when they first emerge from the cells, are gray, soft, and appear generally unsophisticated.

Just what the longevity of the male bee is, I am unable to state. It is probable, judging from analogy, that they live till accident, the worker bees, or the performance of their natural function causes their death. The worker-bees may kill off the drones at any time, which they do by constantly biting and worrying them. They may also destroy the drone-brood. It is not very rare to see workers carrying out immature drones even in mid-summer. At the same time they may destroy inchoate queens. Such action is prompted by a sudden check in the yield of honey, and in case of drones is only common at the close of the season. The bees seem very cautious and far-sighted. If the signs of the times presage a famine, they stay all proceedings looking to the increase of colonies. On the other hand, unlimited honey, rapid increase of brood, crowded quarters—whatever the age of the queen—are sure to bring many of the male bees, while any circumstances that

indicate a need of drones in the near future, will prevent their destruction even in late autumn.

The function of the drones is solely to impregnate the queen, though when present they may add animal heat. That their nutrition is active, is suggested by the fact that, upon dissection, we always find their capacious stomachs filled with honey.

Impregnation of the queen always takes place, as before stated, while on the wing, outside the hive, usually during the heat of a warm sunshiny day. After mating, the drone organs adhere to the queen, and may be seen hanging to her for some hours. The copulatory act is fatal to the drone. By holding a drone in the hand, the ejection of the sex-organs is often produced, and is always followed by immediate death. As the queen only meets a single drone, and that only once, it might be asked why nature was so improvident as to decree hundreds of drones to an apiary or colony, whereas a score would suffice as well. Nature takes cognizance of the importance of the queen, and as she goes forth amidst the myriad dangers of the outer world, it is safest and best that her stay abroad be not protracted, that the experience be not repeated, and, especially, that her meeting a drone be *not delayed*. Hence the superabundance of drones—especially under natural conditions, isolated in forest homes, where ravenous birds are ever on the alert for insect game—is most wise and provident. Nature is never “penny wise and pound foolish.” In our apiaries the need is wanting, and the condition, as it exists in nature, is not enforced.

The fact that parthenogenesis prevails in the production of the drones, has led to the theory that from a pure queen, however mated, must ever come a pure drone. My own experience and observation, which I believe are those of all apiarists, have confirmed this theory. Yet, if the impure mating of our cows, horses, and fowls, renders the females of mixed blood ever afterward, as is believed and taught by many who would seem most competent to judge—though I must say I am somewhat skeptical in the matter, then we must look closely as to our bees, for certainly, if a mammal, and especially a fowl, is tainted by impure mating, then we may expect the same of insects. In fowls such influence, if it exists, must come simply from the presence in the female generative organs of the sperm-cells, or spermatozoa, and in

mammals, too, there is little more than this, for though they are viviparous, so that the union and contact of the offspring and mother seem very intimate during fetal development, yet there is no intermingling of blood, for a membrane ever separates that of the mother from that of the fetus, and only the nutritious and waste elements pass from one to the other. To claim that the mother is tainted through the circulation, is like claiming that the same result would follow her inhaling the breath of her progeny after birth. If such taint is produced, it probably comes through the power of a cell to change those cells contiguous to it. That cells have such power is proved every day in case of wounds, and the spread of any disease. I can only say, that I believe this whole matter is still involved in doubt, and still needs more careful, scientific and prolonged observation.

THE NEUTERS, OR WORKER-BEES.

These, called "the bees" by Aristotle, and even by Wildman and Bevan, are by far the most numerous individuals of the hive—there being from 15,000 to 40,000 in every good colony. It is possible for a colony to be even much more populous than this. (Lubbock says that there are often 50,000 worker-ants in a nest.) These are also the smallest bees of the colony, as they measure but little more than one-half of an inch in length (Fig. 21).

FIG. 21.

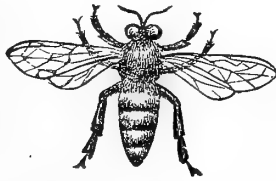

Worker-Bee, magnified.

The workers—as taught by Schirach, and proved by Mlle. Jurine, of Geneva, Switzerland, who, at the request of Huber, sought for and found, by aid of her microscope, the abortive ovaries—are undeveloped females. Rarely, and probably very rarely except when a colony is long or often queenless, as is frequently true of our nuclei, these bees are so far developed

as to produce eggs, which, of course, would always be drone eggs. Such workers—known as “fertile”—were first noticed by Riem, while Huber saw one in the act of egg-laying. Paul L. Viallon and others have seen the same thing often. Several fertile workers, sent me by Mr. Viallon, were examined and the eggs and ovaries were plainly visible, though no spermatheca was to be seen. Except in the power to produce eggs, they seem not unlike the other workers. Huber supposed that these were reared in cells contiguous to royal cells, and thus received royal food by accident. The fact, as stated by Mr. Quinby, that these occur in colonies where queen-larvæ were never reared is fatal to the above theory. Langstroth and Berlepsch thought that these bees, while larvæ, were fed, though too sparingly, with the royal aliment, by bees in need of a queen, and hence the accelerated development. Such may be the true explanation. Yet if, as some apiarists aver, these appear where no brood has been fed, and so must be common workers, changed after leaving the cell, as the result of a felt need, then we must conclude that development and growth—as with the high-holder—spring from desire. The generative organs are very sensitive, and exceedingly susceptible to impressions, and we may yet have much to learn as to the delicate forces which will move them to growth and activity. Though these fertile workers are a poor substitute for a queen, as they are incapable of producing any bees but drones, and are surely the harbingers of death and extinction to the colony, yet they seem to satisfy the workers, for usually the workers will not brook the presence of a queen when a fertile worker is in the hive, nor will they suffer the existence in the hive of a queen-cell, even though capped. They seem to be satisfied, though they have very slight reason to be so. These fertile workers lay indifferently in large or small cells—often place several eggs in a single cell, and show their incapacity in various ways. Fertile workers seem to appear more quickly and in greater abundance in colonies of Cyprian and Syrian bees, after they become hopelessly queenless, than in Italian colonies.

The maxillæ and labium of the worker bee are much elongated (Fig. 22). The maxillæ (Fig. 22, *A, mx, mx*) are deeply grooved, and are hinged to the head by strong chitinous rods (Fig. 22, *A, c, c, St, St*), to which are attached the

muscles which move these parts. The gutter-like extremities (Fig. 22, *A*, *l*, *l*) are stiffened with chitine, and, when approp-

FIG. 22.

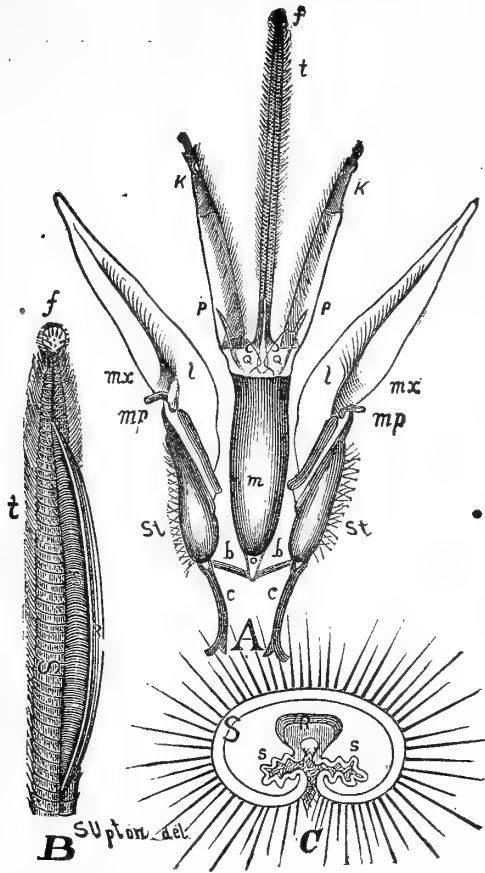

Tongue of a Worker-Bee, much magnified.

- | | | |
|-------------------------------|--|----------------------------------|
| <i>mx, mx</i> —Maxillæ. | <i>A</i> —Maxillæ and labium. | <i>k, k</i> —Labia palpi. |
| <i>c, c</i> —Cardos. | <i>mp, mp</i> —Max. palpi. | <i>t</i> —Tongue. |
| <i>St, St</i> —Stipes. | <i>o</i> —Sub mentum. | <i>f</i> —Funnel. |
| <i>l, l</i> —Lacinix. | <i>m</i> —Mentum. | |
| <i>s</i> —Colorless membrane. | <i>p, p</i> —Paraglossæ. | |
| <i>S</i> —Sheath. | <i>B</i> —Ligula, with sack distended. | <i>R</i> —Tubular rod. |
| | <i>f</i> —Funnel. | <i>s, s</i> —Colorless membrane. |
| | <i>C</i> —Cross-section of ligula. | |
| | <i>R</i> —Tubular rod. | |

(The above fig. is drawn to same scale as Fig. 17.)

imated, form a tube which is continued by a membrane to the mouth opening of the pharynx, just between the bases of the jaws. This tube forms the largest channel through which nectar passes to the pharynx. The labium varies in length from .23 to .27 of an inch. By the sub-mentum (Fig. 22 *A, o*) and two chitinous rods (Fig. 22, *A, b, b*) it is hinged to the maxillæ. The base or mentum (Fig. 22 *A, m*) is tubular. The lower part of the tube is thick with chitine, the upper part membranous. This tube opens into the pharynx and extends into the tongue. From the mentum extend the tongue or ligula (Figure 22, *A, t*), the paraglossæ (Fig. 22, *A, p, p*), whose sack-like bases connect with the tube of the mentum, and the labial palpi (Fig. 22, *k, k*), which, in arrangement, form and function, resemble the maxillæ. The tongue consists of an annulated sheath (Fig. 22, *B* and *C, S*) which is slitted along its under side to near the end. This is very hairy. Within this is a tubular rod (Fig. 22, *B*, and *C, R*) which is also slitted along its under surface. This extends beyond the sheath, where it becomes an imperfect funnel (Fig. 22, *f*). A thin colorless membrane (Fig. 22, *C, s, s*) connects the slitted margins of the rod with those of the sheath. This, with the sheath, forms a sack which may be distended (Fig. 22, *B*) with nectar, as it has connection with the tube of the mentum, though it is closed anteriorly. The tubular rod connects with the sack and with the tube of the mentum at the base of the ligula.

While the bee is sipping liquid food, the tongue alternately pushes out and draws back for a short distance, which motion is effected by muscles at its base. This may be analogous to swallowing. When not in use the tongue is partially drawn into the mentum, and with the labial palpi and maxillæ is bent under the head.

When bees can get at nectar in quantity, they suck it through the extemporized tubes formed by approximating the maxillæ and labial palpi. Deep down in flowers they only sip through the funnel and tubular rod. When a liquid is spread out thin, I think they lap or wipe it up, when it passes through the slit into the tubular rod, and thence to the pharynx.

Connected with the tube in the mentum, and thus with the mouth, is a tube which leads to two pairs of glands

FIG. 23.

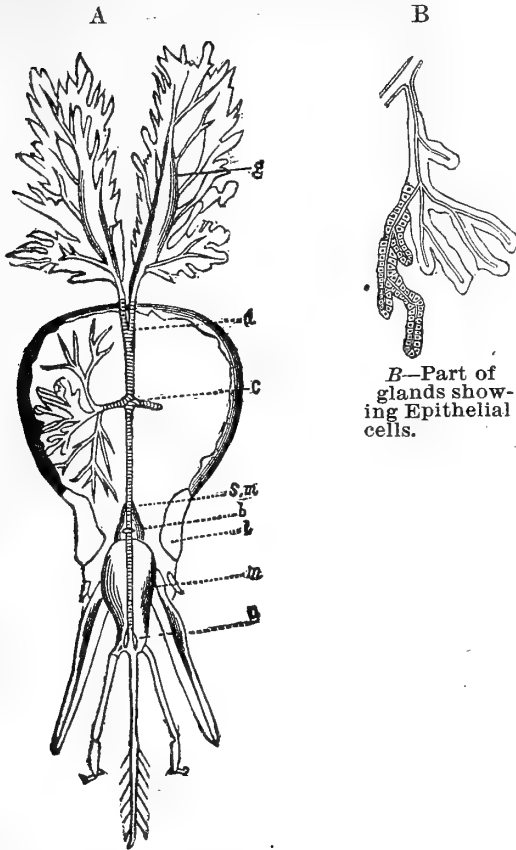

B—Part of glands showing Epithelial cells.

A—Glands.
 g—Thoracic glands.
 a—Duct of thoracic glands.
 c—Ducts of cephalic glands.
 sm—Sub mentum.
 b—Opening to mouth.
 m—Mentum.
 a—Opening to paraglossæ.

(Fig. 23, A), one pair in the head, the other in the thorax. These glands are compound, and are lined with epithelium (Fig. 23 B). This apparatus was first discovered by Mr. Justin Spaulding, from whose article I get my diagram. From these glands comes the so-called salivary juice, which

aids in kneading wax, etc., as already described. It also probably aids in modifying the sugar while the nectar is in the bee's stomach, and, as I have shown elsewhere, in pushing out the tongue. This is done by crowding the liquid into the closed tubular sheath (Fig. 22, *C, S*).

The jaws (Fig. 24, *c*) are very strong, without the rudimentary tooth, while the cutting edge is semi-conical, so that when the jaws are closed they form an imperfect cone. Thus these are well formed to cut comb, knead wax, and perform their various functions. Their eyes (Fig. 5) are like those of the queen, while their wings, like those of the drones, attain the end of the body. These organs (Fig. 3), as in all insects with rapid flight, are slim and strong, and, by their more or less rapid vibrations, give the variety of tone which characterizes their hum. Thus we have the rapid movements and high pitch of anger, and the slow motion and mellow note of content and joy.

FIG. 24.

*a*—Jaw of drone.*b*—Jaw of queen.*c*—Jaw of worker.

On the outside of the posterior tibia and basal tarsus is a cavity, made more deep by its rim of hairs, known as the pollen basket (Fig. 25, *p*). In these pollen baskets is compacted the pollen, which is gathered by the mouth organs, and carried back by the four anterior legs. Opposite the pollen baskets are regular rows of golden hairs (Fig. 26, *e*), which probably aid in storing and compacting the pollen balls.

On the anterior legs of the workers, between the femur and tibia, is a curious notch (Fig. 27, *C*) covered by a spur (Fig. 27, *B*). For several years this has caused speculation among my students, and has attracted the attention of observing apiarists. Some have supposed that it aided bees in reaching deeper down into tubular flowers; others, that it was used in scraping off pollen, and still others, that it enabled bees to hold on

FIG. 25.
Outside.



FIG. 26.
Inside.

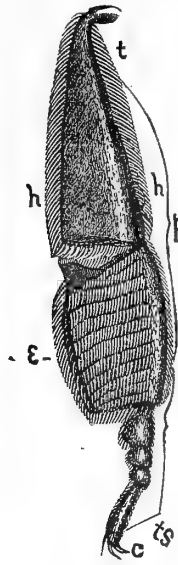

Part of Posterior Leg of Worker, much magnified.

t—Tibia. h—Rim of hairs. p—Pollen basket. ts—Joint of tarsi.
c—Claws. e—Rows of hairs.

when clustering. The first two suggestions may be correct, though other honey and pollen-gathering bees do not possess it. The latter function is performed by the claws at the end of the tarsi.

The worker bees possess an organ of defense, which they

FIG. 27.



Anterior Leg of Worker, magnified.

are quick to use if occasion demands. This organ is straight, not curved as is the sting of the queen. The poison, which is emitted in stinging and which causes the severe pain, is an

acid fluid, which is secreted by a double gland, and stored in a muscular sack (Fig. 28, C), which is about the size of a flaxseed. This sack is connected by a tube (Fig. 28, M) with the reservoir of the sting. The sting is a triple organ consisting of three sharp hollow spears, which are very smooth and of exquisite polish. If we magnify the most beautifully wrought

FIG. 28.

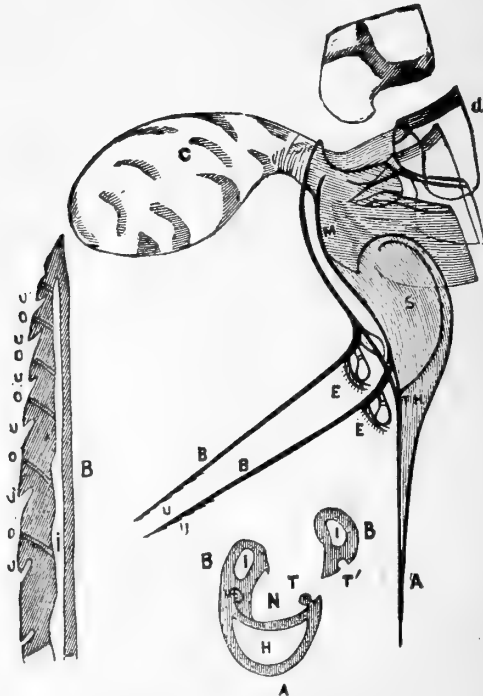

Sting with Lancets drawn one side, cross-section of Sting, and a Lancet, much magnified.

- | | | |
|--------------------------|---------------------------------------|---------------------|
| C—Poison sack. | M—Tube from sack to reservoir. | S—Reservoir. |
| A—Awl. | B, B—Lancets. | E, E—Valves. |
| U, U—Barbs. | O, O—Openings from hollow in lancets. | H—Hollow in awl. |
| I, I—Hollows in lancets. | | T, T—Ridges in awl. |
| T—Groove in lancet. | | |

steel instrument, it looks rough and unfinished; while the parts of the sting, however highly magnified, are smooth and perfect. The true relation of the three parts of the sting was accurately described by Mr. J. R. Bledsoe, in the *American*

Bee Journal, vol. 6, page 29. The action in stinging and the method of extruding the poison, are well described in a beautifully illustrated article by Mr. J. D. Hyatt, in Vol. I, No. 1, of *American Quarterly Microscopical Journal*. The larger of the three awls (Fig. 28, *A*) usually, though incorrectly, styled a sheath, has a large cylindrical reservoir at its base (Fig. 28, *S*) which is entirely shut off from the hollow (Fig. 28, *H*) in the more slender part of the awl, which latter serves no purpose whatever, except to give strength and lightness.

The reservoir connects at its base with the poison sack, and below, by a slit, with the opening (Fig. 28, *N*) made by the approximation of the three awls. The other two awls (Fig. 28, *B, B*), which we will call lancets, are also hollow (Fig. 28, *I, I*). They are barbed (Fig. 28, *U, U*) much like a fish-hook, except that there are eight or ten barbs, instead of one. Five of the barbs are large and strong. These barbs catch hold and cause the extraction of the sting when the organ is used. Near the base of each lancet is a beautiful valvular organ (Fig. 28, *E, E*). The hollow inside the lancets (Fig. 28, *I, I*), unlike that of the awl, is useful. It opens anteriorly in front of the first six barbs (Fig. 28, *o, o*), as shown by Mr. Hyatt, and posteriorly just back of the valves into the central tube (Fig. 28, *N*), and through it into the reservoir (Fig. 28, *S*). The poison then can pass either through the hollow lancets (Fig. 28, *I, I*) or through the central tubes (Fig. 28, *N*), between the three spears.

The lancets are held to the central piece by projections (Fig. 28, *T, T*) from the latter, which fit into corresponding grooves (Fig. 28, *T'*) of the lancets. In the figure the lancets are moved one side to show the barbs and valves; normally they are held close together, and thus form the tube (Fig. 28, *N*).

The parts of the sting are moved by muscles connecting the basis of the parts and extending from the parts to the large chitinous supports (Fig. 28, *d*). The fact that muscles connect the various parts, and the muscular character of the sack, explain how a sting may act, even after the bee is apparently lifeless, or, what is even more wonderful, after it has been extracted from the bee. The barbs hold one lancet as a fulcrum for the other, and so long as the muscles are excitable, so long is a thrust possible. Thus I have known

a bee, dead for hours, to sting. A wasp, dead more than a day, with the abdomen cut off, made a painful thrust, and stings extracted for several minutes could still bring tears by their entering the flesh. In stinging, the awl first pierces, then the lancets follow. As the lancets push in, the valves close the central tube, when the poison is driven through the lancets themselves and comes out by the openings near the barbs (Fig. 28, *o, o*). The drop of poison which we see on the sting when the bee is slightly irritated, as by jarring the hive on a cold day, is pushed through the central opening by the muscular contraction of the sack attendant upon the elevation of the abdomen and extrusion of the sting. The young microscopist will find it difficult to see the barbs, as it is not easy to turn the lancets so that they will show. Patience and persistence, however, will bring success.

The honey-stomach, or crop, in the workers (Fig. 11, *o*) is well developed, though no larger than that of drones. Whether it is more complex in structure or not, I cannot state.

The workers hatch from impregnated eggs, which can only come from a queen that has met a drone, and are always laid in the small, horizontal cells (Fig. 31, *c*). These eggs are in no wise different, so far as we can see, from those which are laid in the drone or queen-cells. All are cylindrical and slightly curved (Fig. 29, *a, b*) and are fastened by one end to the bottom of the cell, and a little to one side of the centre. As in other animals, the eggs from different queens vary perceptibly in size. As already shown, these are voluntarily fertilized by the queen as she extrudes them, preparatory to fastening them in the cells. These eggs, though small—one-sixteenth of an inch long, may be easily seen by holding the comb so that the light will shine into the cells. With experience they are detected almost at once, but I have often found it quite difficult to make the novice see them, though very plainly visible to my experienced eye.

The egg hatches in three days. The larva (Fig. 29, *d, e, f*), incorrectly called grub, maggot—and even caterpillar, by Hunter—is white, footless, and lies coiled up in the cell till near maturity. It is fed a whitish fluid, though this seems to be given grudgingly, as the larva never seems to have more than it wishes to eat, so it is fed quite frequently by the mature workers. It would seem that the workers fear an

FIG. 29.

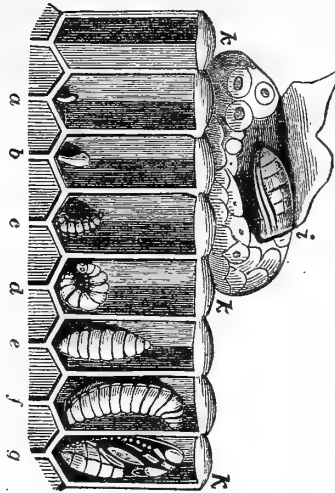
*Development of the Bee.*

excessive development, which, as we have seen, is most mischievous and ruinous, and work to prevent the same by a mean and meager diet. The food is composed of pollen and honey. Certainly of pollen, for, as I have repeatedly proved, without pollen no brood will be reared. Probably some honey is incorporated, as sugar is an essential in the nutrition of all animals, and we could hardly account for the excessive amount of honey consumed, while breeding, by the extra amount consumed by the bees consequent upon the added exercise required in caring for the brood. M. Quinby, Doolittle, and others, say water is also an element of this food. But bees often breed very rapidly when they do not leave the hive at all, and so water, other than that contained in the honey, etc., cannot be added. The time when bees seem to need water, and so repair to the rill and the pond, is during the heat of spring and summer, when they are most busy. May this not be quaffed for the most part to slake their own thirst?

In eight days from the laying of the egg, the worker cell, like the queen cell, is capped over by the worker-bees. This cap is composed of pollen and wax, so it is darker, more

porous, and more easily broken than the caps of the honey-cells; it is also more convex (Fig. 29, *k*). The larva, now full grown, having lapped up all the food placed before it, surrounds itself with a silken cocoon, so excessively thin that it requires a great number to appreciably reduce the size of the cells. These always remain in the cells after the bees escape, and give to old comb its dark color and great strength. Yet they are so thin that cells used even for a dozen years, seem to serve as well for brood as when first used. In three days the insect assumes the pupa state (Fig. 29, *g*). In all insects the spinning of the cocoon seems an exhaustive process, for so far as I have observed, and that is quite at length, this act is succeeded by a variable period of repose. The pupa is also called a nymph. By cutting open cells it is easy to determine just the date of forming the cocoon, and of changing to the pupa state. The pupa looks like the mature bee with all its appendages bound close about it, though the color is still whitish.

In twenty-one days the bees emerge from the cells. The old writers were quite mistaken in thinking that the advent of these was an occasion of joy and excitement among the bees. All apiarists have noticed how utterly unmoved the bees are, as they push over and crowd by these new-comers in the most heedless and discourteous manner imaginable. Wildman tells of seeing the workers gathering pollen and honey the same day that they came forth from the cells. This idea is quickly disproved if we Italianize black bees. We know that for some days these young bees do not leave the hive at all, except in case of swarming, when bees even too young to fly will attempt to go with the crowd. These young bees, like young drones and queens, are much lighter colored when they first leave the cell.

The worker-bees never attain a great age. Those reared in autumn may live for eight or nine months, and if in queenless stocks, where little labor is performed, even longer; while those reared in spring will wear out in three months, and when most busy will often die in from thirty to forty-five days. None of these bees survive the year through, so there is a limit to the number which may exist in a colony. As a good queen will lay, when in her best estate, three thousand eggs daily, and as the workers live from one to three months, it might

seem that forty thousand was too small a figure for the number of workers. Without doubt a greater number is possible. That it is rare is not surprising, when we remember the numerous accidents and vicissitudes that must ever attend the individuals of these populous communities.

The function of the worker-bees is to do all the manual labor of the hives. They secrete the wax, which forms in small scales (Fig. 30, *w*) under the over-lapping rings under the abdomen. I have found these wax-scales on both old and young. According to Fritz Müller, the admirable German observer, so long a traveler in South America, the bees of the genus *Melipona* secrete the wax on the back.

The young bees build the comb, ventilate the hive, feed the larvæ and cap the cells. The older bees—for, as readily seen in Italianizing, the young bees do not go forth for the first two weeks—gather the honey, collect the pollen, or bee-bread as it is generally called, bring in the propolis or bee-glue, which is used to close openings and as a cement, supply the hive with water (?), defend the hive from all improper intrusion, destroy drones when their day of grace is past, kill and arrange for replacing worthless queens, destroy inchoate queens, drones, or even workers, if circumstances demand it, and lead forth a portion of the bees when the conditions impel them to swarm.

When there are no young bees, the old bees will act as house-keepers and nurses, which they otherwise refuse to do. The young bees, on the other hand, will not go forth to glean, even though there be no old bees to do this necessary part of bee-duties. An indirect function of all the bees is to supply animal heat, as the very life of the bees requires that the temperature inside the hive be maintained at a rate considerably above freezing. In the chemical processes attendant upon nutrition, much heat is generated, which, as first shown by Newport, may be considerably augmented at the pleasure of the bees, by forced respiration. The bees, by a rapid vibration of their wings, have the power to ventilate their hives and reduce the temperature when the weather is hot. Thus they are able to moderate the heat of summer, and temper the cold of winter.

CHAPTER III.

SWARMING, OR NATURAL METHODS OF INCREASE.

The natural method by which an increase of colonies among bees is secured, is of great interest, and though it has been closely observed, and assiduously studied for a long period, and has given rise to theories as often absurd as sound, yet, even now, it is a fertile field for investigation, and will repay any who may come with the true spirit of inquiry, for there is much concerning it which is involved in mystery. Why do bees swarm at unseemingly times? Why is the swarming spirit so excessive at times and so restrained at other seasons? These and other questions we are too apt to refer to erratic tendencies of the bees, when there is no question but that they follow naturally upon certain conditions, perhaps intricate and obscure, which it is the province of the investigator to discover. Who shall be first to unfold the principles which govern these, as all other actions of the bees?

In the spring or early summer, when the hive has become populous, and storing very active, the queen, as if conscious that a home could be overcrowded, and foreseeing such danger, commences to deposit drone-eggs in drone-cells, which the worker-bees, perhaps moved by like considerations, begin to construct, if they are not already in existence. In fact, drone comb is almost sure of construction at such times. No sooner is the drone brood well under way, than the large, awkward queen-cells are commenced, often to the number of ten or fifteen, though there may be not more than three or four. The Cyprian and Syrian bees often start from fifty to one hundred queen-cells. In these, eggs are placed, and the rich royal jelly added, and soon, often before the cells are even capped—and *very rarely* before a cell is built, if the bees are crowded, the hives unshaded, the ventilation insufficient, or the honey-yield very bountiful—some bright day, usually about ten o'clock, after an unusual disquiet both inside and outside the hive, a large part of the worker-bees—being off duty for the day, and having previously loaded their honey-sacks—rush forth from the hive as if alarmed by the cry of fire, the queen among

the number, though she is by no means among the first, and frequently is quite late in her exit. It is often asserted that bees do no gathering on the day they swarm, previous to leaving the hive. This is not true. Mr. Doolittle thinks they are just as active as on other days. The assertion that bees always cluster on the outside preliminary to swarming, is not true. The crowded hive makes this common, though in a well managed apiary it is very infrequent. The bees, once started on their quest for a new home, after many uproarious gyrations about the old one, dart forth to alight upon some bush, limb, or fence, though in one case I knew the first swarm of bees to leave at once for parts unknown, without even waiting to cluster. After thus meditating for the space of from one to three hours, upon a future course, they again take wing and leave for their new home, which they have probably already sought out.

Some suppose the bees look up a home before leaving the hive, while others claim that scouts are in search of one while the bees are clustered. The fact that bees take a right-line to their new home, and fly too rapidly to look as they go, would argue that a home is preëmpted, at least, before the cluster is dissolved. The fact that the cluster remains sometimes for hours—even over night—and at other times for a brief period, would lead us to infer that the bees cluster while waiting for a new home to be found. Yet, why do bees sometimes alight after flying a long distance, as did a first swarm the past season upon our College grounds? Was their journey long, so that they must needs stop to rest, or were they flying at random, not knowing whither they were going?

If for any reason the queen should fail to join the bees, and perhaps rarely when she is among them, they will, after having clustered, (they rarely fail to cluster) return to their old home. The youngest bees will remain in the old hive, to which those bees which are abroad in quest of stores will return. The presence of young bees on the ground immediately after a swarm has issued—those with flight too feeble to join the rovers—will always mark the previous home of the emigrants.

Soon, in seven or eight days, often later, if Italians, the first queen will come forth from her cell, and in two or three days she will, or may, lead a new colony forth; but before she does this, the peculiar note, known as the piping of the queen,

may be heard. This piping sounds like "peep," "peep," is shrill and clear, and can be plainly heard by placing the ear to the hive, nor would it be mistaken. It is followed by a lower, hoarser note, made by a queen still within the cell. This piping is best heard by placing the ear to the hive in the evening or early morning. If heard, we may surely expect a swarm the day following, unless the weather is too unpleasant.

Some have supposed that the cry of the liberated queen was that of hate, while that by the queen still imprisoned was either of enmity or fear. Never will an after-swarm leave, unless preceded by this peculiar note.

At successive periods of one or two days, one, two, or even three more colonies may issue from the old home. Mr. Langstroth knew five after-swarms to issue, and others have reported eight and ten. These last swarms will all be heralded by the piping of the queen. They will be less particular as to the time of day when they issue, as they have been known to leave before sun-rise, and even after sun-set. The well-known apiarist, Mr. A. F. Moon, once knew a swarm to issue by moon-light. They will, as a rule, cluster farther from the hive. The after-swarms are accompanied by the queen, and in case swarming is delayed may be attended by a plurality of queens. Berlepsch and Langstroth each saw eight queens issue with a swarm, while others report even more. These virgin queens fly very rapidly, so the swarm will seem more active and definite in its course than will first swarms.

The cutting short of swarming preparations before the second, third, or even the first swarm issues, is by no means a rare occurrence. This is effected by the bees destroying the queen-cells, and sometimes by a general extermination of the drones, and is generally to be explained by a cessation of the honey yield. It is commonly observed that while a moderate yield of honey is very provocative of swarming, a heavy flow seems frequently to absorb the entire attention of the bees, and so destroy the swarming impulse entirely. Cells thus destroyed are easily recognized, as they are torn open from the side and not cut back from the end.

Swarming out at other times, especially in late winter and spring, is sometimes noticed by apiarists. This is due to famine, mice, or some other disturbing circumstance which makes the hive intolerable to the bees.

CHAPTER IV.

PRODUCTS OF BEES; THEIR ORIGIN AND FUNCTION.

Among all insects, bees stand first in the variety of the useful products which they give us, and, next to the silkmoths, in the importance of these products. They seem the more remarkable and important, in that so few insects yield articles of commercial value. True, the cochineal insect, a species of bark-louse, gives us an important coloring material; the lac insect, of the same family, gives us the important element of our best glue—shellac; the blister-beetles afford an article prized by the physician, while we are indebted to one of the gall-flies for a valuable element of ink: but the honey-bee affords not only a delicious article of food, but also another article of no mean commercial rank, namely, wax. We will proceed to examine the various products which come from bees.

HONEY.

Of course the first product of bees, not only to attract attention but also in importance, is honey. And what is honey? We can only say that it is a sweet substance gathered from flowers and other sources, by the bees. We cannot, therefore, give its chemical composition which would be as varied as the sources from which it comes. We cannot even call it a sugar, for it may be, and always is, composed of various sugars, and thus it is easy to understand why honey varies so much in richness, color, flavor, and effects on digestion.

Nectar of flowers and honey are quite different. The former contains more water, is neutral instead of acid, and the sugars taken from the flowers are much modified while in the alimentary canal of the bee in transit from flower to comb. Nectar consists of sucrose or cane sugar from twelve to fifteen per cent., and mellose, or uncrystallizable sugar ten per cent. The remainder is mostly water, though there is always a small amount of nitrogenous material.

In honey the cane sugar is largely changed to a substance chemically like glucose: the mellose seems also somewhat modified. There is a little mannite, probably the result of chemi-

cal change in the bee's stomach. The acid condition of honey is plainly recognizable by the taste, as all lovers of honey know.

I have fed bees pure cane sugar, and when stored the late Prof. R. F. Kedzie found that much of this sugar was transformed in much the same way that the nectar is changed which is taken from the flowers.

It is probable that the large compound racemose glands in the head and thorax of the bees (Fig. 23, *a*) secrete an abundant ferment which hastens these transformations which the sugars undergo while in the stomach of the bee. Probably the stomach juices also aid in these changes. Much of the water escapes after the honey is stored.

The method of collecting honey has already been described. The principles of lapping and suction are both involved in the operation.

When the stomach is full, the bee repairs to the hive and regurgitates its precious load, either giving it to the bees or storing it in the cells. Mr. Doolittle claims that the bees that gather give all their honey to the other bees, which latter store it in the cells. This honey remains for sometime uncapped that it may ripen, in which process the water is partially evaporated and the honey rendered thicker. If the honey remains uncapped, or is removed from the cells, it will generally granulate, if the temperature be reduced below 70°. Like many other substances, honey, if heated and sealed while hot, will not crystallize till it is unsealed. In case of granulation the sucrose and glucose crystallize in the mellose. Some honey, as that from the South and some from California, seems to remain liquid indefinitely. Some kinds of our own honey crystallize much more readily than others. The only sure test of the purity of honey is that of the polariscope. This is not practical except in the hands of the physicist. The most practical test is that of granulation, though this is not wholly reliable. Granulated honey is almost certainly pure. Occasionally genuine honey refuses, even in a zero atmosphere, to crystallize.

When there are no flowers, or when the flowers yield no sweets, the bees, ever desirous to add to their stores, frequently essay to rob other colonies, and often visit the refuse of cider mills, or suck up the oozing sweets of various plants or bark-lice, thus adding, may be, unwholesome food to their usually delicious and refined stores. It is a curious fact that the

queen never lays her maximum number of eggs except when storing is going on. In fact, in the interims of honey-gathering, egg-laying not infrequently ceases altogether. The queen seems discreet, gauging the size of her family by the probable means of support.

Again, in times of extraordinary yields of honey the storing is very rapid and the hive becomes so filled that the queen is unable to lay her full quota of eggs; in fact, I have seen the brood very much reduced in this way, which, of course, greatly depletes the colony. This might be called ruinous prosperity.

The natural use of the honey is to furnish the mature bees with food and, when mixed with pollen, to form the diet of the young bees.

WAX.

The product of the bees second in importance, is wax. This is a solid, unctious substance, and is, as shown by its chemical composition, a fat-like material, though not, as some authors assert, the fat of bees. As already observed, this is a secretion formed in scales, the shape of an irregular pentagon

FIG. 30.

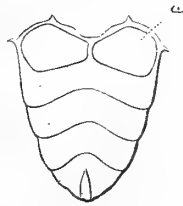
*Wax Scales in situ, magnified.**w*—Wax-scale.

(Fig. 30, *w*), underneath the abdomen. These scales are light-colored, very thin and fragile, and are secreted by and molded upon the membrane towards the body from the wax-pockets. Neighbour speaks of the wax oozing through pores from the stomach. This is not the case, but, like the synovial fluid about our own joints, it is formed by the secreting membrane, and does not pass through holes, as water through a sieve. There are four of these wax-pockets on each side, and thus there may be eight wax-scales on a bee at one time. This wax can be secreted by the bees when fed on pure sugar, as shown

by Huber, whose experiment I have verified. I removed all honey and comb from my observing-hive, left the bees for twenty-four hours to digest all food which might be in their stomachs, and then fed pure sugar, which was better than honey, as Prof. R. F. Kedzie has shown by analysis that not only filtered honey, but even the nectar which he collected right from the flowers themselves, contains nitrogen. The bees commenced at once to build comb, and continued for several days, so long as I kept them confined. This is as we should suppose; sugar contains hydrogen and oxygen in proportion to form water, while the third element, carbon, is in the same or about the same proportion as the oxygen. Now, the fats usually contain little oxygen and a good deal of carbon and hydrogen. Thus the sugar by losing some of its oxygen would contain the requisite elements for fat. It was found true in the days of slavery in the South that the negroes of Louisiana, during the gathering of the cane, would become very fat. They ate much sugar; they gained much fat. Now, wax is a fat-like substance, not that it is the animal fat of bees, as often asserted—in fact it contains much less hydrogen, as will be seen by the following formula from Hess:

Oxygen.....	7.50
Carbon.....	79.30
Hydrogen.....	13.20

—but it is a special secretion for a special purpose, and from its composition we should conclude that it might be secreted from a purely saccharine diet, and experiment confirms the conclusion. It has been found that bees require about twenty pounds of honey to secrete one of wax. The experiments of Mr. P. L. Viallon show this estimate of Huber to be too great. My own experiments would sustain Huber's statement. In these experiments the bees are confined, and so the conclusions are to be received with caution. We cannot know how much the results are changed by the abnormal condition in which the bees are placed.

That nitrogenous food is necessary, as claimed by Langstroth and Neighbour, is not true. Yet, in the active season, when muscular exertion is great, nitrogenous food must be imperatively necessary to supply the waste and give tone to the body. Secretion of wax demands a healthy condition of the bee, and so indirectly requires some nitrogenous food.

It is asserted that to secrete wax, bees need to hang in compact clusters or festoons, in absolute repose. Such quiet would certainly seem conducive to most active secretion. The same food could not go to form wax, and at the same time supply the waste of tissue which ever follows upon muscular activity. The cow, put to hard toil, could not give so much milk. But I find, upon examination, that the bees, even the most aged, while gathering in the honey season, yield up the wax-scales the same as those within the hive. During the active storing of the past season, especially when comb-building was in rapid progress, I found that nearly every bee taken from the flowers contained the wax-scales of varying sizes in the wax-pockets. By the activity of the bees, these are not infrequently loosened from their position and fall to the bottom of the hive.

It is probable that wax secretion is not forced upon the bees, but only takes place as required. So the bees, unless wax is demanded, may perform other duties. Whether this secretion is a matter of the bee's will, or whether it is excited by the surrounding conditions without any thought, are questions yet to be settled.

These wax-scales are loosened by the claws and carried to the mouth by the feet, where they are mixed with saliva, and after the proper kneading by the jaws are fashioned into that wonderful and exquisite structure, the comb. In this transformation to comb, the wax may become much darker in color. It is almost sure to do this if the new comb is formed adjacent to old, dark colored comb.

Honey-comb is wonderfully delicate, the wall of a new cell being only about 1-180 of an inch in thickness, and so formed as to combine the greatest strength with the least expense of material and room. It has been a subject of admiration since the earliest time. That the form is a matter of necessity, as some claim, the result of pressure and not of bee-skill, is not true. The hexagonal form is assumed at the very start of the cells, when there can be no pressure. The wasp builds the same form, though unaided. The assertion that the cells, even the drone and worker-cells, are absolutely uniform and perfect, is also untrue, as a little inspection will convince any one. The late Prof. Wymän proved that an exact hexagonal cell does not exist. He showed that the size varies, so that in a distance of ten worker-cells there may be a variation of one

diameter, and this in natural, not distorted cells. This variation of one-fifth of an inch in ten cells is extreme, but a variation of one-tenth of an inch is common. The sides, as also the angles, are not constant. The rhombic faces forming the bases of the cells also vary.

The bees change from worker (Fig. 31, *c*) to drone-cells (Fig. 31, *a*), which are one-fifth larger, and *vice versa*, not by any system (Fig. 31, *b*), but simply by enlarging or contracting. It usually takes about four rows to complete the transformation, though the number of deformed cells varies from two to eight.

FIG. 31.

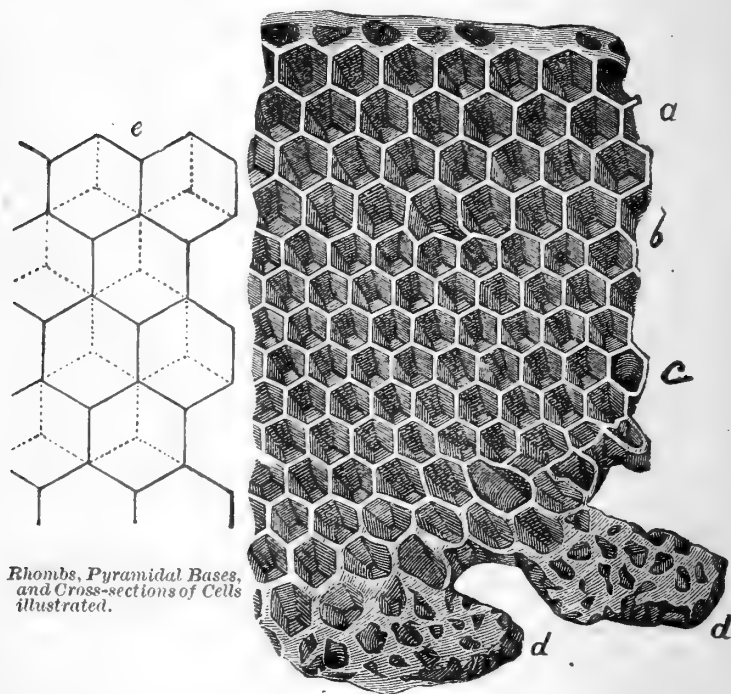

Rhombs, Pyramidal Bases,
and Cross-sections of Cells
illustrated.

a—Drone-cells.
b—Deformed cells.

c—Worker-cells.
d—Queen-cells.

The structure of each cell is quite complex, yet full of interest. The base is a triangular pyramid (Fig. 31, *e*) whose three faces are rhombs, and whose apex forms the very centre

of the floor of the cell. From the six free or non-adjacent edges of the three rhombs extend the lateral walls or faces of the cell. The apex of this basal pyramid is a point where the contiguous faces of three cells on the opposite side meet, and form the angles of the bases of three cells on the opposite side of the comb. Thus the base of each cell forms one-third of the base of each of three opposite cells. One side thus braces the other and adds much to the strength of the comb. Each cell, then, is in the form of a hexagonal prism, terminating in a flattened triangular pyramid.

The bees usually build several combs at once, and carry forward several cells on each side of each comb, constantly adding to the number, by additions to the edge. Huber first observed the process of comb-building, noticing the bees abstract the wax-scales, carry them to the mouth, add the frothy saliva, and then knead and draw out the yellow ribbons which were fastened to the top of the hive, or added to the comb already commenced.

The diameter of the worker-cells (Fig. 31, *c*) averages little more than one-fifth of an inch—Reaumur says two and three-fifths lines, or twelfths of an inch, while the drone-cells (Fig. 31, *a*) are a little more than one-fourth of an inch, or, according to Reaumur, three and one-third lines. But this distinguished author was quite wrong when he said: "These are the invariable dimensions of all cells that ever were or ever will be made." The depth of the worker-cells is a little less than half an inch; the drone-cells are slightly extended so as to be a little more than half an inch deep. These cells are often drawn out so as to be an inch long, when used solely as honey receptacles. The capping of the brood-cells is dark, porous, and convex, while that of the honey-cells is white and concave. This capping of honey-cells is made thicker by black bees than by the other races, and so their comb honey is more beautiful.

The character of the cells, as to size, that is, whether they are drone or worker, seems to be determined by the relative abundance of bees and honey. If the bees are abundant and honey needed, or if there is no queen to lay eggs, drone-comb (Fig. 31, *a*) is invariably built, while if there are few bees, and of course little honey needed, then worker-comb (Fig. 31, *c*) is almost as invariably formed.

All comb when first formed is clear and translucent. The fact that it is often dark and opaque implies that it has been long used as brood-comb, and the opacity is due to the innumerable thin cocoons which line the cells. These may be separated by dissolving the wax; which may be done by putting it in boiling alcohol. Such comb need not be discarded, for if composed of worker-cells it is still very valuable for breeding purposes, and should not be destroyed till the cells are too small for longer service, which will not occur till after many years of use. The function, then, of the wax, is to make comb and caps for the honey-cells, and, combined with pollen, to form queen-cells (Fig. 31, *d*) and caps for the brood-cells.

A very common fossil found in many parts of the Eastern and Northern United States, is, from its appearance, often called petrified honey-comb. We have many such specimens in our museum. In some cases the cells are hardly larger than a pin-head; in others a quarter of an inch in diameter.

FIG. 32.

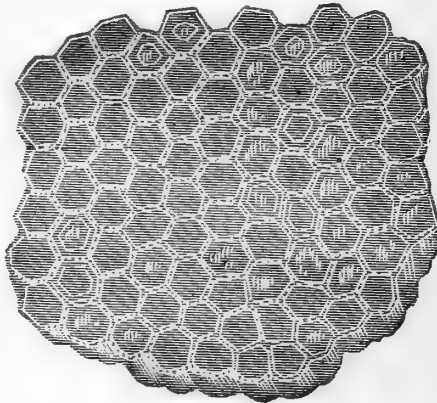
*Honey-stone Coral.*

These (Figs. 32, 33) are not fossil honey-comb as many are led to believe, though the resemblance is so striking that no wonder the public generally are deceived. These specimens are fossil coral, which the paleontologist places in the genus *Favosites*; *favosus* being a common species in our State. They are very abundant in the lime rock in northern Michigan, and are very properly denominated honey-stone coral.

The animals of which these were once the skeletons, so to speak, are not insects at all, though often called so by men of considerable information.

The species of the genus *Favosites* first appeared in the Upper Silurian rocks, culminated in the Devonian, and disappeared in the early Carboniferous. No insects appeared till the Devonian age, and no Hymenoptera—bees, wasps, etc.—till after the Carboniferous. So the old-time *Favosites* reared its limestone columns and helped to build islands and continents untold ages—millions upon millions of years—before any flower bloomed, or any bee sipped the precious nectar. In some specimens of this honey-stone coral (Fig. 33), there

FIG. 33.

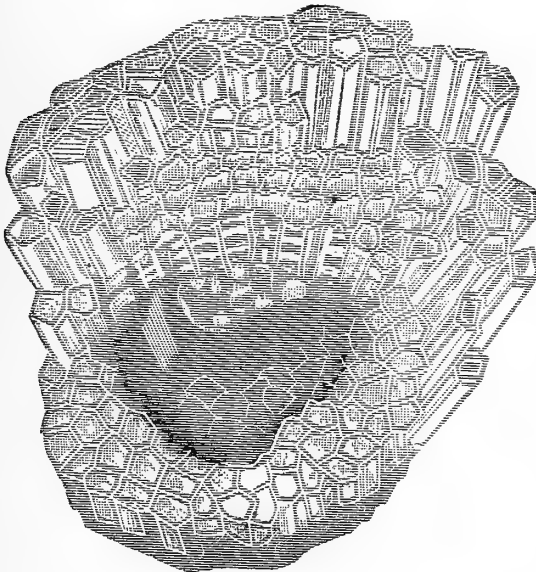
*Honey-stone Coral.*

are to be seen banks of cells, much resembling the paper cells of some of our wasps. This might be called wasp-stone coral, except that both styles were wrought by the self-same animals.

POLLEN, OR BEE-BREAD.

An ancient Greek author states that in *Hymettus* the bees tied little pebbles to their legs to hold them down. This

fanciful conjecture probably arose from seeing the pollen balls on the bees' legs.

Even such scientists as Reaumur, Bonnet, Swammerdam, and many apiarists of the last century, thought they saw in these pollen-balls the source of wax. But Huber, John Hunter, Duchet, Wildman, and others, noticed the presence and function of the wax-scales already described, and were aware that the pollen served a different purpose.

This substance, like nectar, is not secreted nor manufactured by the bees, only collected. The bees usually obtain it from the stamens of flowers; but if they gain access to flour when there is no bloom, they will take this in lieu of pollen, in which case the former term used above becomes a misnomer, though usually the bee-bread consists almost wholly of pollen.

As already intimated, the pollen is conveyed in the pollen-baskets (Fig. 25, *p*) of the posterior legs, to which it is conveyed by the other legs, and compressed into little oval masses. The motions in this conveyance are exceedingly rapid. The bees not infrequently come to the hives not only with replete pollen-baskets but with their whole under surface thoroughly dusted. Dissection will also show that the same bee may have her sucking stomach distended with honey. Thus the bees make the most of their opportunities. It is a curious fact, noticed even by Aristotle, that the bees, during any trip, almost always gather only a single kind of pollen, or only gather from one species of bloom. Hence, while different bees may have different colors of pollen, the pellets of bee-bread on any single bee will be uniform in color throughout. It is possible that the material is more easily collected and compacted when homogeneous. It seems more probable that they prefer the pollen of certain plants, and work on such species so long as they yield the desired food. From this fact we see why bees cause no intercrossing of species of plants; they only intermix the pollen of different plants of the same species.

The pollen is usually deposited in the small or worker cells, and is unloaded by a scraping motion of the posterior legs, the pollen baskets being first lowered into the cells. The bee thus freed, leaves the wheat-like masses to be packed by other bees. The cells, which may or may not have the same color of pollen throughout, are never filled quite to the top, and not

infrequently the same cell may contain both pollen and honey. Such a condition is easily ascertained by holding the comb between the eye and the sun. If there is no pollen it will be wholly translucent; otherwise there will be opaque patches. A little experience will make this determination easy, even if the comb is old. It is often stated that queenless colonies gather no pollen, but this is not true, though they gather less than they otherwise would. It is probable that pollen, at least when honey is added, contains all the essential elements of animal food. It certainly contains the very important principle which is not found in honey—nitrogenous material.

The function of bee-bread is to help furnish the brood with proper food. In fact, brood-rearing would be impossible without it. And though it is certainly not essential to the nourishment of the bees when in repose, it still may be so, and unquestionably is, in time of active labor. This point is clearly proved from the fact that pollen husks are always found in the intestines of bees.

PROPOLIS.

This substance, also called bee-glue, is collected as the bees collect pollen, and not made nor secreted. It is the product of various resinous buds, and may be seen to glisten on the opening buds of the hickory and horse-chestnut, where it frequently serves the entomologist by capturing small insects. From such sources, from the oozing gum of various trees, from varnished furniture, and from old propolis about unused hives that have previously seen service, do the bees secure their glue. Probably the gathering of bees about coffins to collect their glue from the varnish, led to the custom of rapping on the hives to inform the bees, in case of a death in the family, that they might join as mourners. This custom still prevails, as I understand, in some parts of the South. Propolis has great adhesive force, and though soft and pliable when warm becomes very hard and unyielding when cold.

The use of bee glue is to cement the combs to their supports, to fill up all rough places inside the hive, to seal up all crevices except the place of exit, which they often contract, and even to cover any foreign substance that cannot be removed. Intruding snails have thus been imprisoned inside the hive. Réaumur found a snail thus encased; Maraldi.

a slug similarly entombed; while I have myself observed a bombus, which had been stripped by the bees of wings, hair, etc., in their vain attempts at removal, also encased in this unique style of a sarcophagus, fashioned by the bees. Alcohol, ether, and chloroform are all ready solvents of bee glue, and will quickly remove it from the hands, clothes, etc.

BIBLIOGRAPHY.

For those who wish to pursue these interesting subjects more at length, I would recommend the following authors as specially desirable: Kirby and Spence, *Introduction to Entomology*; Duncan's *Transformations of Insects*; Packard's *Guide to the Study of Insects (American)*; F. Huber's *New Observations on the Natural History of Bees*; Bevan on the Honey bee; Langstroth on the Honey Bee (American); Neighbour on *The Apiary*; and the other books already referred to on page eleven.

I have often been asked to recommend such treatises, and I heartily commend all of the above. The first and fourth are now out of print, but can be had by leaving orders at second-hand book-stores.

PART SECOND.

THE APIARY,

ITS CARE AND MANAGEMENT.

MOTTO:—“KEEP ALL COLONIES STRONG!”

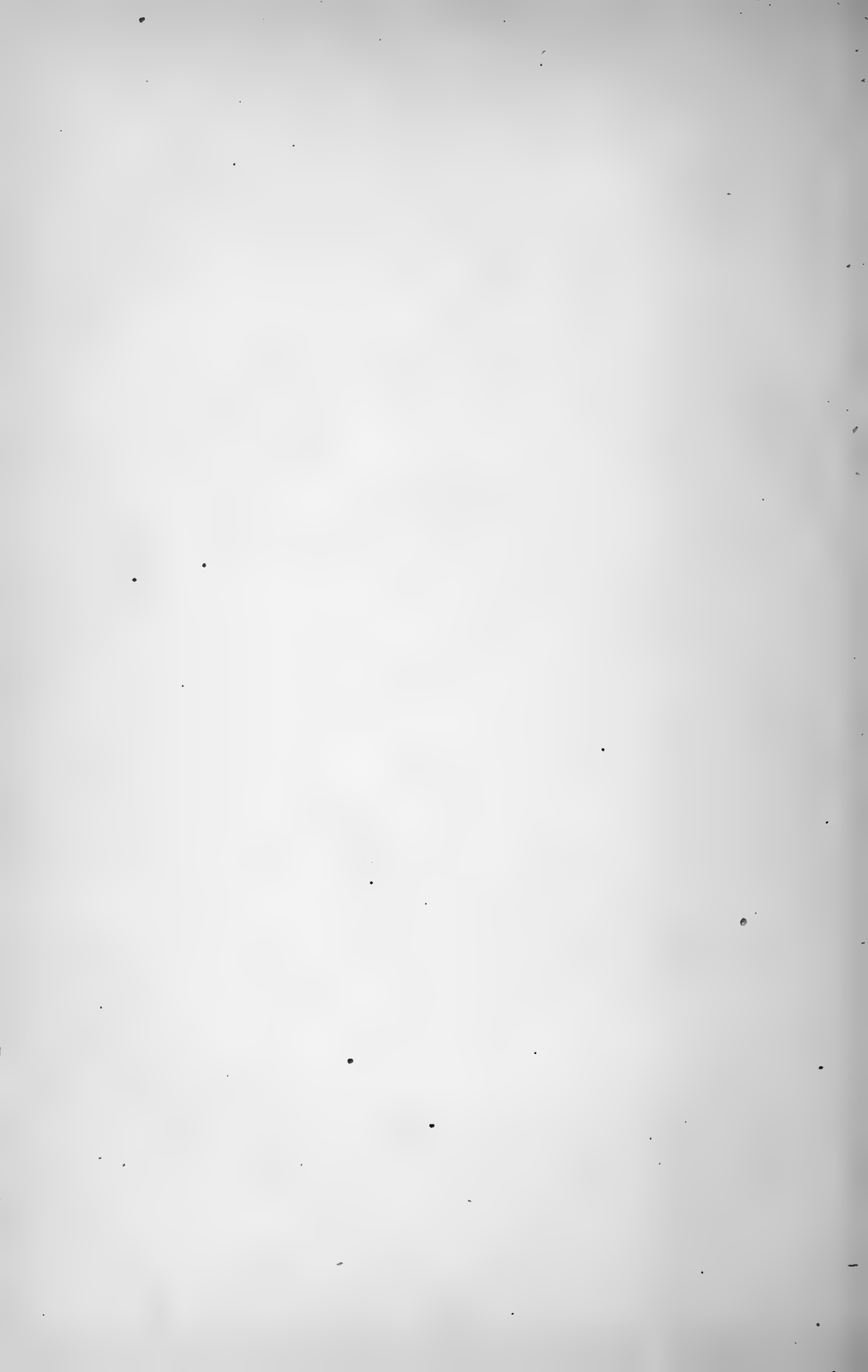

INTRODUCTION TO PART II.

STARTING AN APIARY.

In apiculture, as in all other pursuits, it is all-important to make a good beginning. This demands preparation on the part of the apiarist, the procuring of bees, and location of the apiary.

PREPARATION.

Before starting in the business, the prospective bee-keeper should inform himself in the art.

READ A GOOD MANUAL.

To do this, he should procure some good manual, and thoroughly study, especially that portion which treats of the practical part of the business. If accustomed to read, think and study, he should carefully read the whole work, but, otherwise, he will avoid confusion by only studying the methods of practice, leaving the principles and science to strengthen, and be strengthened by, his experience. Unless a student, he had better not take a journal till he begins the actual work, as so much unclassified information, without any experience to correct, arrange, and select, will but mystify. For the same reason, he may well be content with reading a single work, till experience, and a thorough study of this one, make him more able to discriminate; and the same reasoning will preclude his taking more than one bee-periodical, until he has had at least a year's actual experience.

VISIT SOME APIARIST.

In this work of self-preparation, he will find great aid in visiting the nearest successful and intelligent apiarist. If successful, such a one will have a reputation; if intelligent, he will take the journals, and will show by his conversation that he knows the methods and views of his brother apiarists, and,

above all, he will not think *he knows it all*, and that his is the only way to success. Learn all you can of such a one, but always let your own judgment and common sense sit as umpire, that you may make no plans or decisions that your judgment does not fully sustain.

TAKE A COLLEGE COURSE.

It will be *most wise* to take a course in some College, if age makes this practicable, where apiculture is thoroughly discussed. Here you will not only get the best training in your chosen business, as you will study, see and handle, and thus will have the very best aids to decide as to methods, system and apparatus, but you will also receive that general culture, which will greatly enhance life's pleasures and usefulness, and which ever proves the best capital in any vocation.

DECIDE ON A PLAN.

After such a course as suggested above, it will be easy to decide as to location, hives, style of honey to raise, and general system of management. But here, as in all the arts, all our work should be preceded by a well-digested plan of operations. As with the farmer and the gardener, only he who works to a plan can hope for the best success. Of course, such plans will vary as we grow in wisdom and experience. A good maxim to govern all plans is, "go slow." A good rule, which will insure the above, "Pay as you go." Make the apiary pay for all improvements in advance. Demand that each year's credits exceed its debits; and that you may surely accomplish this, keep an accurate account of all your receipts and expenses. This will be a great aid in arranging the plans for each successive year's operations.

Above all, avoid hobbies, and be slow to adopt sweeping changes. "Prove all things, and hold fast that which is good."

HOW TO PROCURE FIRST COLONIES.

To procure colonies from which to form an apiary, it is always best to get them near at hand. We thus avoid the shock of transportation, can see the bees before we purchase, and in case there is any seeming mistake can easily gain a personal explanation and secure a speedy adjustment of any real wrong.

KIND OF BEES TO PURCHASE.

At the same price always take Italians, as certainly they are best for the beginner. If black bees can be secured for three, or even for two dollars less per colony, by all means take them, as they can be Italianized at a profit for the difference in cost, and, in the operation, the young apiarist will gain valuable experience.

Our motto will demand that we only purchase strong colonies. If, as recommended, the purchaser sees the colonies before the bargain is closed, it will be easy to know that the colonies are strong. If the bees, as they come rushing out, remind you of Vesuvius at her best, or bring to mind the gush and rush at the nozzle of the fireman's hose, then buy. In the hives of such colonies, all combs will be covered with bees, and in the honey season, brood will be abundant. It is always wisest to begin with few bees. He will generally succeed best who commences with not more than four or five colonies.

IN WHAT KIND OF HIVES.

As plans are already made, of course it is settled as to the style of hive to be used. If bees can be procured in such hives, they will be worth just as much more than though in any other hive, as it costs to make the hive and transfer the bees. This will be certainly as much as two or three dollars. *No apiarist will tolerate, unless for experiment, two styles of hives in his apiary.* Therefore, unless you find bees in such hives as you are to use, it will be best to buy them in box hives and transfer (see Chapter VII.) to your own hives, as bees in box hives can always be bought at reduced rates. In case the person from whom you purchase will take the hives back at a fair rate, after you have transferred the bees to your own hives, then purchase in any style of movable comb hive, as it is easier to transfer from a movable comb hive, than from a box hive.

WHEN TO PURCHASE.

It is safe to purchase any time in the summer. In April or May (of course you only purchase strong stocks) if in the latitude of New York or Chicago—it will be earlier further south—you can afford to pay more, as you will secure the in-

crease both of honey and bees. If you desire to purchase in autumn, that you may gain by the experience of wintering, either demand that the one of whom you purchase insure the safe wintering of the bees, or else that he reduce the selling price, at least one-third, from his rates the next April. Otherwise, the novice had better wait and purchase in the spring. If you are to transfer at once, it is almost imperative that you buy in spring, as it is vexatious, especially for the novice, to transfer when the hives are crowded with brood and honey.

HOW MUCH TO PAY.

Of course the market, which will ever be governed by supply and demand, must guide you. But to aid you, I will append what at present would be a reasonable schedule of spring prices almost anywhere in the United States: For box hives, crowded with black bees—Italians would rarely be found in such hives—five dollars per colony is a fair price. For black bees in hives such as you desire to use, eight dollars would be reasonable. For pure Italians in such hives, ten dollars is not too much.

If the person of whom you purchase will take back the movable hives after you transfer the bees, you can afford to pay five dollars for black bees, and seven dollars for pure Italians. If you purchase in the fall, require $33\frac{1}{3}$ per cent. discount on these rates.

WHERE TO LOCATE.

If apiculture is an avocation, then your location will be fixed by your principal business or profession. And here I may state that, if we may judge from reports which come from nearly every section of the United States, from Maine to Texas, and from Florida to Oregon, you can hardly go amiss anywhere in our goodly land.

If you are to engage as a specialist, then you can select first with reference to society and climate, after which it will be well to secure a succession of natural honey-plants (Chap. XVII.), by virtue of your locality. It will also be well to look for reasonable prospects of a good home market, as good home markets are, and must ever be, the most desirable. It will be desirable, too, that your neighborhood is not overstocked

with bees. It is a well-established fact, that apiarists with few colonies receive relatively larger profits than those with large apiaries. While this may be owing in part to better care, much doubtless depends on the fact that there is not an undue proportion of bees to the number of honey-plants, and consequent secretion of nectar. To have the undisputed monopoly of an area reaching at least four miles in every direction from your apiary, is unquestionably a great advantage.

If you desire to begin two kinds of business, so that your dangers from possible misfortune may be lessened, then a small farm—especially a fruit farm—in some locality where fruit-raising is successfully practiced, will be very desirable. You thus add others of the luxuries of life to the products of your business, and at the same time may create additional pasturage for your bees by simply attending to your other business. In this case, your location becomes a more complex matter, and will demand still greater thought and attention. Some of Michigan's most successful apiarists are also noted as successful pomologists.

For position and arrangement of apiary see Chapter VI.

CHAPTER V.

HIVES AND SECTIONS.

An early choice among the innumerable hives is of course demanded; and here let me state with emphasis, *that none of the standard hives are now covered by patents, so let no one buy rights.* Success by the skillful apiarist with almost any hive is possible. Yet, without question, some hives are far superior to others, and for certain uses, and with certain persons, some hives are far preferable to others, though all may be meritorious. As a change in hives, after one is once engaged in apiculture, involves much time, labor, and expense, this becomes an important question, and one worthy of earnest consideration by the prospective apiarist. I shall give it a first place, and a thorough consideration, in this discussion of practical apiculture.

BOX-HIVES.

I feel free to say that no person who reads, thinks, and studies—and success in apiculture can be promised to no other—will ever be content to use the old box-hives. In fact, thought and intelligence, which imply an eagerness to investigate, are essential elements in the apiarist's character, and to such a one a box-hive would be valued just in proportion to the amount of kindling-wood it contained. I shall entirely ignore box-hives in the following discussions, for I believe no sensible, intelligent apiarists, such as read books, will tolerate them, and that, supposing they would, it would be an expensive mistake which I have no right to encourage, in fact am bound to discourage, not only for the benefit of individuals but also for the art itself.

To be sure of success, the apiarist must be able to inspect the whole interior of the hive at his pleasure, must be able to exchange combs from one hive to another, and to regulate the movements of the bees—by destroying queen-cells, by giving or withholding drone-comb, by extracting the honey, by introducing queens, and by many other manipulations to be explained, which are only practicable with a movable comb hive.

MOVABLE COMB HIVES.

There are, at present, two types of the movable comb hive in use among us, each of which is unquestionably valuable, as each

has advocates among our most intelligent, successful, and extensive apiarists. Each, too, has been superseded by the other, to the satisfaction of the person making the change. The kind most used consists of a box, in which hang the frames which hold the combs. The adjacent frames are so far separated that the combs, which just fill them, shall be the proper distance apart. In the other kind, the frames are wider than the comb, and when in position are close together, and of themselves form two sides of a box. When in use, these frames are surrounded by a second box, without a bottom, which, with them, rests on a bottom board. Each of these kinds is represented by various forms, sizes, etc., where the details are varied to suit the apiarist's notion. Yet, I believe that all hives in present use, worthy of recommendation, fall within one or the other of the above named types.

EARLY FRAME HIVES.

In 1843, Mr. Augustus Munn, of England, invented a movable comb hive (Fig. 34), which I need hardly say was not the

FIG. 34.

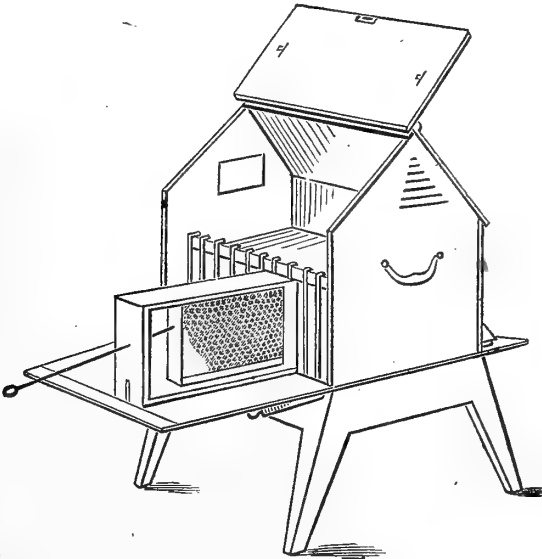

The Munn Hive.

Langstroth hive nor a practical one. In 1851 this hive (Fig. 35) was improved (?). Well does Neighbour say in his valuable hand-book, "This invention was of no avail to apiarists."

FIG. 35.

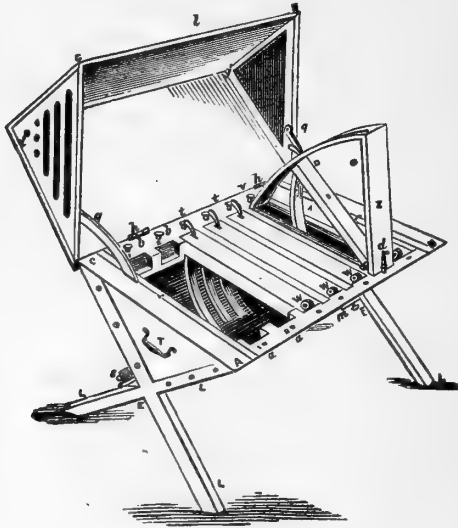
*Munn's Improved Hive.*

M. DeBeauvoys, of France, in 1847, and Schmidt, of Germany, in 1851, invented movable-comb hives. The frames were tight-fitting, and, of course, not practical. Dzierzon adopted the bar hive in 1838. In this hive each comb had to be cut loose as it was removed.

THE LANGSTROTH HIVE.

In 1851, our own Langstroth, without any knowledge of what foreign apiarian inventors had done, save what he could find in Huber, and edition 1838 of Bevan, invented the hive (Fig. 36) now in common use among the advanced apiarists of America. It is this hive, the greatest apiarian invention ever made, that has placed American apiculture in advance of that of all other countries. What practical bee-keeper of America could agree with H. Hamet, edition 1861, p. 166, who, in speaking of the DeBeauvoys' hive, says that the im-

proved hives were without value except to the amateur, and inferior for practical purposes? Our apiarists not native to our shores, like the late Adam Grimm and Mr. Charles Dant, always conceded that Mr. Langstroth was the inventor of this hive, and always proclaimed its usefulness. Well did the late Mr. S. Wagner, the honest, fearless, scholarly, and truth-loving editor of the early volumes of the *American Bee Journal*, himself of German origin, says: "When Mr. Langstroth took up this subject, he well knew what Huber had done, and saw wherein he had failed—failing, possibly, only because he aimed at nothing more than constructing an observing hive suitable for his purposes. Mr. Langstroth's object was other and *higher*. He aimed at making frames movable, interchangeable, and *practically* serviceable in bee culture." And how true what follows: "*Nobody* before Mr. Langstroth ever succeeded in devising a mode of making and using a movable frame that was of any practical value in bee culture." No man in the world, beside Mr. Langstroth, was so conversant with this whole subject as was Mr. Wagner. His extensive library and thorough knowledge made him a competent judge.

Mr. Langstroth, though he knew of no previous invention of frames contained in a case, when he made his invention, in 1851, does not profess to have been the first to have invented them. Every page of his book shows his transparent honesty, and his desire to give all due credit to other writers and inventors. He does claim, and very justly, to have invented the first practical frame hive, the one described in his patent, applied for in January, 1851, and in all three editions of his book.

For this great invention, as well as his able researches in apiculture, as given in his invaluable book, "The Honey-Bee," he has conferred a benefit upon our art which cannot be over-estimated, and for which we, as apiarists, cannot be too grateful. It was his book—one of my old teachers, for which I have no word of chiding—that led me to some of the most delightful investigations of my life. It was his invention—the Langstroth hive—that enabled me to make those investigations. For one, I shall always revere the name of Langstroth, as a great leader in scientific apiculture, both in America and throughout the world. His name must ever stand beside those of Dzierzon and the elder Huber. Surely this hive, which left the hands of the great master in so perfect

a form that even the details remain unchanged by many of our first bee-keepers, should ever bear his name. Thus, though I prefer and use the size of frame first used, I believe, by Mr. Gallup, still I use the Langstroth hive.

CHARACTER OF THE HIVE.

The main feature of the hive should be simplicity, which would exclude doors, drawers, and traps of all kinds. The body should be made of good pine or white-wood lumber, one inch thick, thoroughly seasoned, and planed on both sides. It should be simply a plain box (Fig. 41, *c.*), without top or bottom, and of a size and form to suit the apiarist.

To prevent warping, the heart surface of the board should be on the outside. In case a single board forms the top of the hive, this suggestion is even more valuable.

FIG. 36.

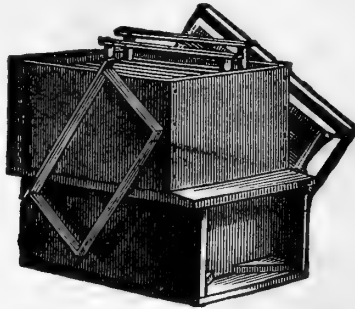

At present our leading apiarists prefer a large hive. The hive preferred by Mr. Heddon—an eight-frame Langstroth, (Fig. 36)—contains about 2,000 cubic inches. While the

FIG. 37.

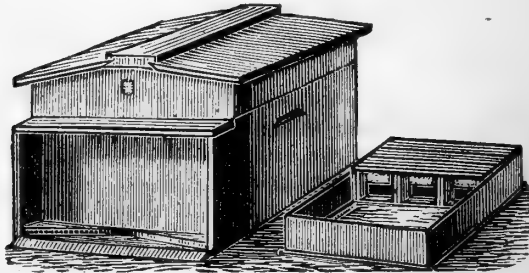

ten-frame Langstroth (Fig. 37), the one recommended by Mr. A. I. Root, contains more than 2,500 cubic inches. Were I to use a two-story hive (Fig. 41), I should prefer about 2,500 cubic inches. If the one-and-one-half story is used (Fig. 38), then I prefer upwards of 3,400 cubic inches. This is the size preferred by Mr. Doolittle. Messrs. Hetherington, L. C. Root and Nellis use a hive larger still.

If the hive is to be a two-story one—that is, one hive above a similar hive below (Fig. 41)—I prefer that it should be eighteen inches long, twelve inches wide, and twelve inches deep, inside measure. If simply small frames or sections are to be used above (Fig. 38), I would have the hive at least

FIG. 38.

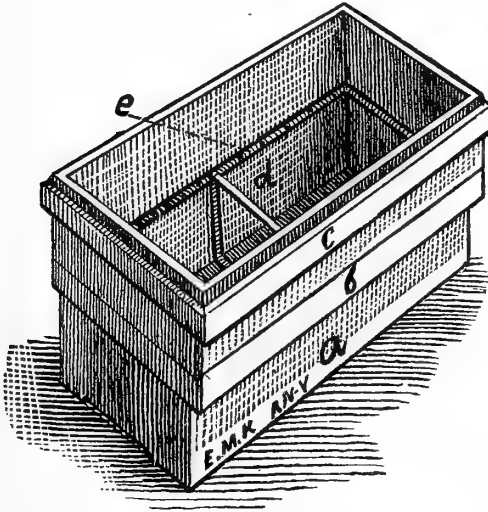

Story and One-Half Hive.

a—Body.
d—Frame.

b, c—Shoulders.
e—Tin.

two feet long. A three-fourths inch rabbet should be cut from the top of the sides or ends, as the apiarist prefers, on the inside (Fig. 41). The rabbet may equal a little more than one-half the thickness of the board. My late hives are without this rabbet (Fig. 38). These are simpler, and with many others I think I prefer them. Then the hive is only eleven

and one-fourth inches deep, instead of twelve. Heavy tin strips (Fig. 41), three-fourths of an inch wide, should be tacked to the side below the rabbet, so as to reach one-fourth of an inch above the shoulder. In case there is no rabbet (Fig. 38, *e*), these tins are nailed to the side of the hive so as to project one-fourth inch above the side. These are to bear the frames, and are convenient as they prevent the frames from becoming glued to the hive. We are thus able to loosen the frames without jarring the bees. I would not have hives without such tins, though some apiarists, among whom is Mr. James Heddon, of this State, whose rank as a successful apiarist is very high, do not like them. The objection to them is cost, and the liability of the frames to move when the hive is moved. But with their use we are not compelled to pry the frames loose, and are not so likely to irritate the bees while making an examination of the contents of the hive, which arguments are conclusive with me.

Any one who is not a skilled mechanic, especially if he has not a buzz-saw, had better join the sides of his hives after the style of making common dry-goods boxes. In this case, the sides not rabbeted should project by (Fig. 36), else the corners will have to be stopped up where they were rabbeted. In case we do not rabbet, either the ends or sides may project by. In such cases many rabbet the corners so as to make a stronger joint.

The mechanic may prefer to bevel the ends of the boards, and unite them by a mitre-joint (Fig. 41). This looks a little better, otherwise is not superior to the other method. It is difficult to form accurate joints, *and as everything about the hive should be ACCURATE and UNIFORM*, this style is not to be recommended to the general apiarist. To mitre with a hand-saw, unless one is very skillful, requires a perfect mitre-box, and, even then, much care is required to secure perfect joints. With a buzz-saw this is easier. We have only to make a carrier as follows: Take two boards (Fig. 39, *a*, *b*), each one foot in length, and dove-tail them together, as though with two others you meant to make a square box. Be sure that they form a perfect right angle. Then bevel the ends opposite the angle, and unite these with a third board (Fig. 39, *c*), firmly nailed to the others. We thus have a triangular pyramid. Through one of the shorter faces make

longitudinal slits (Fig. 39, *d*), so that this can be bolted firmly to the saw-table. In use, the longer face will reach the saw, and from thence will slant up and back. Along the back edge of this a narrow board (Fig. 39, *e*) should be nailed, which will project an inch above it. This will keep the board to be beveled in line with the carrier, and will retain the right angles. Of course the boards for the hive must be perfect rectangles, and of just the right length and width, before the bevels are cut.

FIG. 39.

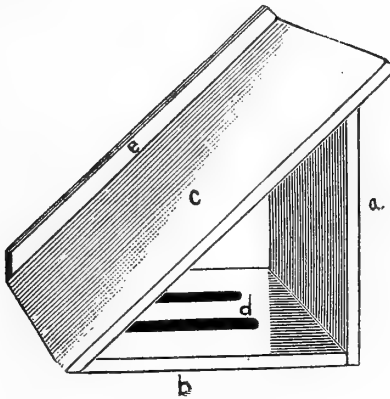
*Bevel-Gauge.*

Such a carrier (Fig 39) I ordered for my Barnes' saw, from a cabinet-maker. It was made of hard wood, all three joints dove-tailed, and nicely finished, at a cost of \$1.50.

In sawing the ends and sides of the hive, whether by hand or with a buzz-saw, use should be made of a guide, so that *perfect uniformity* will be secured.

THE BOTTOM BOARD.

For a bottom board or stand (Fig. 40), we should have a single one-inch board (Fig. 40, *a*) just as wide as the hive, and four inches longer, if the bees are to enter at the end of the hive, and as long, and four inches wider, if the bees are to enter at the side. This is nailed to two pieces of two-by-four scantling (Fig. 40, *b, b*). Thus the hive rests four inches from the ground. A bottom board no wider than the hive, which shall be simply a bottomless box four inches high, has

decided advantage. Bees can never cluster under it while being manipulated in summer, and in winter by simply turning it over and partially filling with chaff, or saw-dust, we help to protect against cold and damp and give more room below the frames.

THE ALIGHTING BOARD.

This should be separate from the bottom board (Fig. 40, *c*). It is made by sawing a piece of two-by-four scantling, eight inches long, diagonally across from two of the shortest edges. These two pieces (Fig. 40, *d*) thus formed become rests for a

FIG. 40.

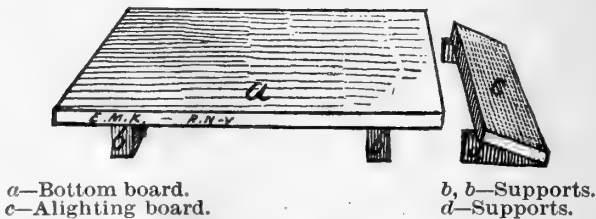

a—Bottom board.
c—Alighting board.

b, b—Supports.
d—Supports.

board eight inches square (Fig. 40, *c*), it may be longer as in the cut, which is nailed on to the sawed surfaces. We thus have a slanting alighting-board separate from the hive.

Should the apiarist desire his bees to enter at the side of the hive, the alighting-board (Fig. 40, *c*) should be changed to the side (Fig. 41). I have tried both, and see no difference, so the matter may be controlled by the taste of the apiarist.

For an opening to the hive (Fig. 41), we may bevel the middle of the edge of the bottom board, next to the inclined board. At the edge, this bevel should be three-quarters of an inch deep and four inches wide. It may decrease in both width and depth as it runs back, until at a distance of four inches it is one-half of an inch wide and five thirty-seconds of an inch deep. This may terminate the opening, though the shoulder at the end may be beveled off if desired.

With this bottom board the bees are near the ground, and with the slanting-board in front even the most tired and heavily-laden will not fail to gain the hive, as they come in with their load of stores. In the spring, too, many bees are saved, as they come in on windy days, by low hives and an

alighting-board. No hive should be more than four inches from the ground, except in very damp regions where it may be raised somewhat higher, and no hive should be without the slanting alighting-board. With this opening the entrance can be contracted in case of robbing, or entirely closed when desired, by simply moving the hive back.

Some apiarists cut an opening in the side of the hive, and regulate the size by tin slides or triangular blocks (Fig. 36); others form an opening by sliding the hive forward beyond the bottom board—which I would do with the above (Fig. 41) in hot weather when storing was very rapid.

I strongly urge that only one opening be used. Auger holes about the hive, and entrances on two sides, are worse than useless. By enlarging this opening, we secure ample ventilation, even in sultry August, and when we contract the entrance no bees are lost by finding the usual door closed.

Some of our best bee-keepers, as Messrs. Heddon, Jones, Baldrige, and others, prefer that the bottom board be nailed to the hive (Fig. 36). Such hives will not permit a quick clearing of the bottom board, when we give a cleansing flight in winter, or when we commence operations in spring, and with their use we cannot contract the opening in cold weather, or to stop robbing, without the blocks or tins. *Simplicity should be the motto in hive-making.* The arguments in favor of such fastening are: Convenience in moving colonies and in feeding, as we have not to fasten the bottoms when we desire to ship our bees, and to feed we have only to pour liquids into the hives. It is probable that the fastened bottom boards have substantial advantage in large apiaries where colonies are often moved, or where sales of bees are frequent.

Of course, such points are not essential—only matters of convenience. Let each one decide for himself, which experience will enable him to do.

THE COVER OF THE HIVE.

The cover (Fig. 41, *a*) should be about six inches high, and like the lid of a trunk. The length and breadth may be the same as the body of the hive, and fit on with beveled edges (Fig. 41, *a*) the body having the outer edge beveled, and the cover the inner. If we thus join the cover and hive with a mitered-joint, we must not be satisfied with anything less

than perfection, else in case of storms the rain will beat into our hives, which should never be permitted. Such covers can be fastened to the hives with hinges, or by hooks and staples. But unless the apiarist is skilled in the use of tools, or hires a mechanic to make his hives, it will be more satisfactory to

FIG. 41.

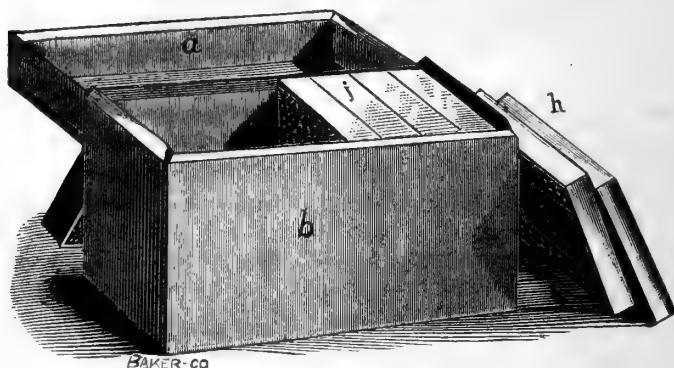
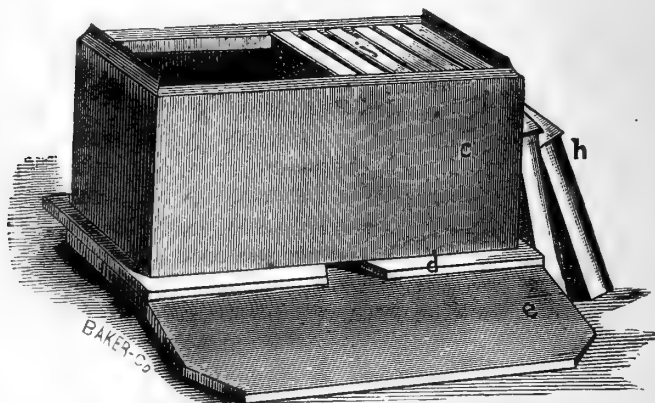
*Two Story Hive.*

c—Lower story.

b—Upper story.

make the cover just large enough (Fig. 36) to shut over and rest on shoulders formed either by nailing inch strips around the body of the hive (Fig. 38, *c*), one inch from the top, or else inside the cover (Fig. 36). If it is preferred to have a

two-story hive, with the upper story (Fig. 41, *b*) just like the lower (Fig. 41, *c*), this may join the lower by a miter-joint, while a cover (Fig. 41, *a*), two inches high, may join this with a similar joint.

If the upper story shuts over the lower and rests on a shoulder (Fig. 38, *f*) it may still be made to take the same sized frame, by nailing pieces one-half an inch square to the corners, whose length shall equal the distance from the rabbet in the lower story to the bottom board. We then nail to these upright pieces, parallel to the rabbeted faces below, a three-eighths inch board as wide as the pieces are long. The top of these thin boards will take the place of the rabbet in the lower story. This style, which is adopted in the two-story hives as made by Mr. Langstroth (Fig. 36), will permit in the upper story the same frames as used in the lower story, while two more can be inserted. Upon this upper story a shallow cover will rest. Such covers, if desired, may be made roof-like

FIG. 42.

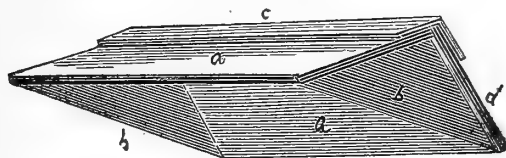

(Fig. 42), by cutting end pieces (Fig. 42, *b*) in form of the gable of a house. In this case there will be two slanting boards (Fig. 42, *a, a'*), instead of one that is horizontal, to carry off the rain. The slanting boards should project at the ends (Fig. 42, *d*), for convenience in handling. In such covers we need thin, narrow ridge-boards (Fig. 42, *c*), to keep all perfectly dry. These covers look neat, are not so apt to check, and will dry much quicker after a rain.

If we secure comb-honey in crates, and winter out-doors—in which case we shall need to protect in the Northern States—it will be convenient to have a box (Fig. 38) of the same general form as the main body of the hive, from six to eight inches deep, just large enough to set over the body of the hive and rest on shoulder-strips, and without top or bottom; this to have such a cover as just described. Such is the arrangement of the noted apiarist James Heddon, Southard and Ranney, of Kala-

māzoo, and many others, which, on the score of simplicity and convenience, has much to recommend it. Mr. Heddon makes his crate serve this purpose, and has his hives well shaded.

In the above I have said nothing about porticos (Fig. 36). If hives are shaded as they should be, these are useless, and I believe that in no case will they pay. To be sure, they are nice for spider-webs, and a shady place in which bees may cluster; but such are inconvenient places to study the wondrous fabrics of the spider, even were he a friend of the bees, and the most successful apiarist will not force his bees to hang in idle clusters about the hive. Mr. George Grimm, however, thinks much of the portico. He practices moving his bees frequently, and in cool weather has to give no other ventilation than that secured by nailing wire gauze over the portico.

THE FRAMES.

The form and size of frames, though not quite as various as

FIG. 43.

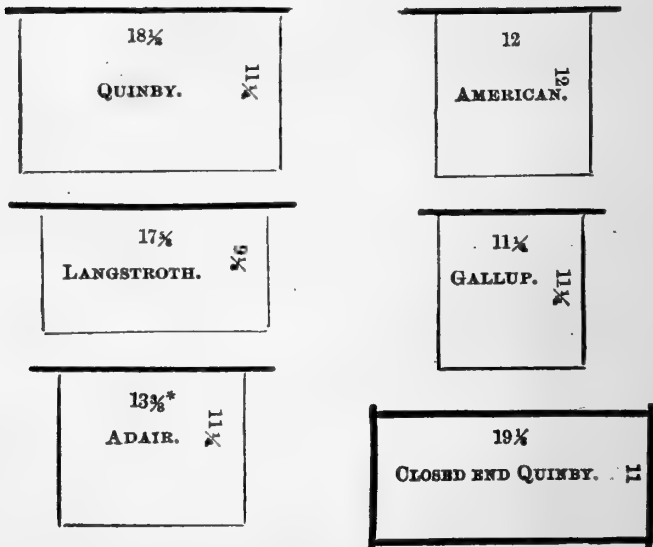

the persons who use them, are still very different (Fig. 43). Some prefer large frames. I first used the Quinby frame, and

afterward the Langstroth (Fig. 43). The advantage claimed for large frames is that there are less to handle, and time is saved; yet may not smaller frames be handled so much more dexterously, especially if they are to be handled through all the long day, as to compensate, in part at least, for the number? The advantage of the shallow frame is, as claimed, that the bees will go into boxes more readily; yet they are not considered so safe for out-door wintering. This is the style recommended and used by Mr. Langstroth, which fact may account for its popularity in the United States. Another frame in common use, is one about one foot square. I use one eleven and one-fourth inches square. The reasons that I prefer this form are, that the comb seldom breaks from the frame, the frames are convenient for nuclei and save the expense of constructing extra nucleus hives, and these frames permit the most compact arrangement for winter and spring, and thus enable us to economize heat. By use of a division board, we can, by using eight of these frames, occupy just a cubic foot of space in spring, and by repeated experiments I have found that a hive so constructed that the bees always cover the combs during the early cold weather, always gives the best results. Dr. Tinker, of Ohio, showed by ample statistics, that in the severe winter of 1882-3 the Gallup frame did prove by far the best. As the honey season comes on more can be added, till we have reached twelve, as many, I think, as will ever be needed for brood. This was the size of frame preferred by Mr. Gallup, and is the one used by Messrs. Davis and Doolittle, Dr. Tinker, and many others of our most successful apiarists. That this size is imperative is, of course, not true; that it combines as many desirable points as any other, I think is true. For apiarists who are not very strong, especially for ladies, it is beyond question superior to all others.

That we shall ever have a uniform frame used by all apiarists, though exceedingly desirable, is too much to expect or even hope. I do not think that there is sufficient advantage in any form to warrant us to hold to it, if by yielding we could secure this uniformity. As will be seen in the *British Bee Journal*, 1882, p. 243, our British brothers are striving for this, and have adopted a frame eight and one-half by fourteen inches. Our North American Association might move in the same direction. Nor do I think the form and size so material

to success as to make it generally desirable for the apiarist to change all his hives to secure a different style of frame.

HOW TO CONSTRUCT THE FRAMES.

In this description, I shall suppose that the frames desired are of the form and size (Fig. 44) which I use. It will be easy, for any who may desire, to change the form at pleasure.

FIG. 44.

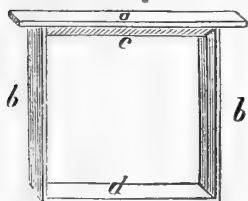
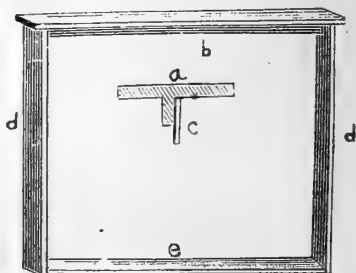

FIG. 45.



Frame, also Cross-Section of Top-Bar.

For the top bar (Fig. 44, *a*) of the frame, use a triangular strip twelve and one-half inches long, with each face of the triangle one inch across. Seven-eighths of an inch from each end of this, form a shoulder, by sawing from one angle to within three-eighths of an inch of the opposite face, so that when the piece is split out from the end, these projections shall be just three-eighths of an inch thick throughout. The top bar of the frame should be large and strong so as never to break or even bend when in use. For the side pieces (Fig. 44, *b, b*), take strips ten and three-fourths inches long, seven-eighths of an inch wide, and one-fourth of an inch thick. Tack with small brads the end of two of these strips firmly to the shoulder of the top-bar, taking pains that the end touches squarely against the projection. Now tack to the opposite ends or bottoms, the ends of a similar strip (Fig. 44, *d*), eleven and a-fourth inches long and one eighth of an inch thick. We shall thus have a frame eleven and one-fourth inches square, outside measure.

If comb-foundation is to be used, and certainly it will be by the enterprising apiarist, then the top bar (Fig. 45, *a*) should be twelve and one-half inches by three-eighths by one

inch, with a rectangular, instead of a triangular, projection below (Fig. 45, *b*), which should be one-fourth by one-eighth inch, the longer diameter up and down. This should be entirely to one side of the center (Fig. 45, *c*), so that when the foundation is pressed against this piece it will hang exactly from the center of the top-bar. If preferred, the bottom of the frame (Fig. 45, *e*) need not be more than half as wide or thick as described above. Very soon all will use wire frames, for foundation, and the top bar will be a plain rectangle.

Mr. D. A. Jones, with many others, prefers that the end bars of the frames project downward (Fig. 46) and that the bottom bar project at each end. It is thought that this saves the lives of bees, when the frames are being rapidly handled.

FIG. 46.

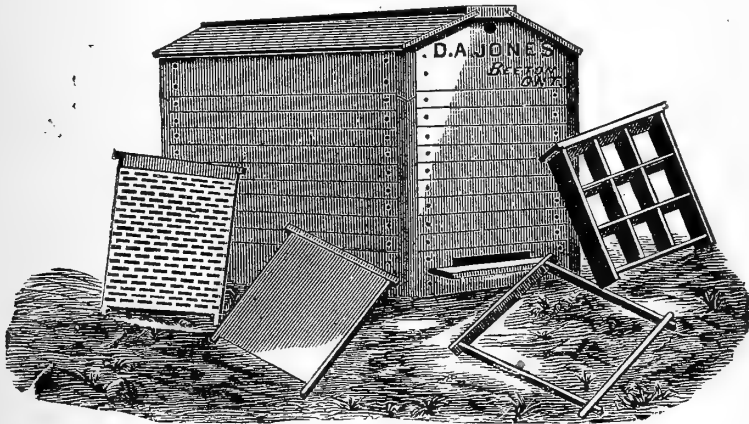

Jones' Chaff Hive, Frame, Frame for Sections, Division Board and Perforated Zinc Division Board.

It is now quite the fashion to wire the frames (Fig. 110). This insures perfect safety if we wish to ship our bees, and secures against sagging or bulging of the foundation. If the foundation is put on with a press, No. 36 wire is used; if pressed on by hand No. 30 wire is better. The timber for frame should be thoroughly seasoned, and of the best pine or white-wood. Care should be taken that the frame be made so as to hang vertically, when suspended on the rabbets of the hive. To secure this *very important* point—true frames that will always hang true—they should always be made around a guide.

A BLOCK FOR MAKING FRAMES.

This may be made as follows: Take a rectangular board (Fig. 47) eleven and one-eighth by thirteen and a-quarter inches. On both ends of one face of this, nail hard-wood pieces (Fig. 47, *e, e*) one inch square and ten and three-fourth inches long, so that one end (Fig. 47, *g, g*) shall lack three-eighths inch of reaching the edge of the board. On the other face of the board, nail a strip (Fig. 47, *c*) four inches wide and eleven and three-eighths inches long, at right angles to it, and in such position that the ends shall just reach to the edges of the board. Midway between the one inch square pieces, screw on another hard-wood strip (Fig. 47, *d*) one inch square and four inches long, parallel with and three-fourths of an inch from the edge. To the bottom of this, screw a semi-oval piece of hoop-steel (Fig. 47, *b, b*), which shall bend around and press against the square strips. The ends of this should not reach quite to the bottom of the board. Near the ends of this spring fasten, by rivets, a leather strap an inch wide (Fig. 47, *a*), which shall be straight when thus riveted. These dimensions are for frames eleven and one-fourth inches square, outside measure, and must be varied for other sizes. Instead of the iron and strap, some use two pieces of wood with a central pivot. The upper ends of these levers are united by a strong elastic cord, so that the lower ends are constantly pressed against the side pieces of the block.

To use this block, we crowd the end-bars of our frames between the steel springs (Fig. 47, *b, b*), and the square strips (Fig. 47, *e, e*); then lay on our top-bar and nail, after which we invert the block and nail the bottom-bar, as we did the top-bar. Now press down on the strap (Fig. 47, *a*), which will loosen the frame, when it may be removed, all complete and true. Such a gauge not only insures perfect frames, but demands that every piece shall be cut with great accuracy, and some such arrangement should always be used in making the frames.

The projecting ends of the top-bar will rest on the tins (Fig. 41), and thus the frame can be easily loosened at any time without jarring the bees, for it will not be glued fast, as it would be in case it rested on the wooden rabbets. The danger of killing bees is also abolished by use of the tins.

When the frames are in the hive there should be a three-eighths inch space between the sides and bottom of the frames, and the sides and bottom of the hive. A much wider space would very likely receive the comb, and be troublesome. Frames that fit close in the hive, or that reach to the bottom, are very inconvenient and undesirable. To secure against this, our lumber must be thoroughly seasoned, else when shrinkage takes place our frames may touch the bottom-board.

FIG. 47.

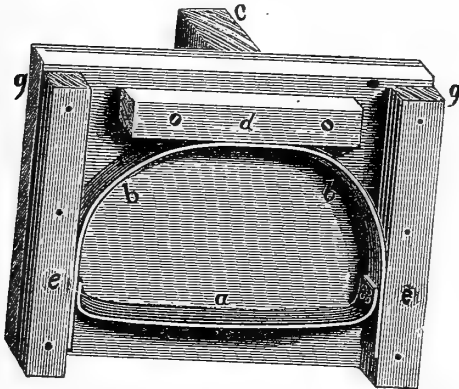

The distance between the frames may be one-half of an inch, though a slight variation either way does no harm. Some men, of very precise habits, prefer nails or wire staples in the side of the frames (as already stated, Mr. Jones prolongs the sides and bottom of the frame for the same purpose) at top and bottom, which project just a quarter of an inch, so as to maintain this unvarying distance; or staples in the bottom of the hive to secure the same end. Mr. Langstroth so arranged his frames, and Mr. Palmer, of Hart, Michigan, whose neatness is only surpassed by his success, does the same thing. I have had hives with these extra attachments, but found in them no special advantage. I think we can regulate the distance with the eye, so as to meet every practical demand, and thus save the expense and trouble which the above attachments cost.

COVER FOR FRAMES.

In summer I prefer oil-cloth to cover the frames. This is used with the glazed or enameled side down, and should be

just the size of the hive. This is durable, is not covered so quickly with propolis, and is easily cleaned. Some keep this on in winter, but I prefer a porous cover. From the cold days of fall to the warm spring days, I replace the enamel-cloth covers with those made of the best factory cloth. As these are just the size of the hive when once properly on, the bees can never get above them. By cutting on three sides of a square, one inch on a side, we form a flap which, when we desire to feed, may be turned back and the hole of the feeder placed right above it.

Mr. Langstroth used a board which he called the Honey Board, above the frames, which Mr. Heddon uses even now. This has long narrow openings in it, through which the bees can pass to the sections above. Perhaps Mr. Heddon never used cloth covers. Perhaps his love of order and neatness caused him to discard them. Still, I feel grateful towards Mr. A. I. Root for calling my attention to these warm, soft, flexible covers.

DIVISION BOARD. .

A close-fitting division board (Fig. 48) for contracting the brood chamber, is very important, and though unappreciated by many excellent apiarists, yet I think no hive is complete without it.

FIG. 48.

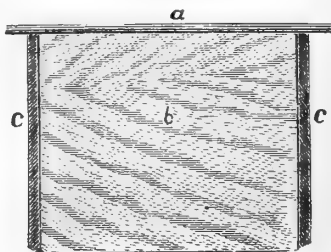

I find it especially valuable in winter and spring, and useful at all seasons. It is made of the same form as the frames, though all below the top-bar—which consists of a strip thirteen inches, by one inch, by three-eighths, nailed firmly to the board below—is a solid inch board (Fig. 48, *b*), which is exactly one foot square, so that it fits closely to the inside of the hive. If

desired, the edges (Fig. 48, *c, c*) can be beveled, as seen in the figure. When this is inserted in the hive it entirely separates the chamber into two chambers, so that an insect much smaller than a bee could not pass from the one to the other. Mr. A. I. Root makes one of cloth, chaff, etc. Yet, I think few apiarists would bother with so much machinery. Mr. W. L. Porter, once Secretary of the Michigan Association, makes the board a little loose, and then inserts a rubber strip in a groove sawed in the edges. This keeps the board snug, and makes its insertion easy, even though heat may shrink or damp may swell either the board or hive. I have not tried this, but like the suggestion. Mr. D. A. Jones prefers that the division-board should not reach quite to the bottom of the hive (Fig. 46).

The use of the division board is to contract the chamber in winter, *to vary it so as to keep combs covered in Spring*, to convert the hive into a nucleus hive, and to contract the chamber in the upper-story of a two-story hive, when first adding frames to secure surplus comb honey.

THE HUBER HIVE.

The other type of hives originated when Huber hinged several of his leaf or unicomb hives together so that the frames would open like the leaves of a book. In August, 1779, Huber wrote to Bonnet as follows: "I took several small fir boxes, a foot square and fifteen lines wide, and joined them together by hinges, so that they could be opened and shut like the leaves of a book. When using a hive of this description, we took care to fix a comb in each frame, and then introduced all the bees." (Edinburgh edition of Huber, p. 4.) Although Morlot and others attempted to improve this hive, it never gained favor with practical apiarists.

In 1866, Mr. T. F. Bingham, then of New York, improved upon the Huber hive, securing a patent on his triangular frame hive. This, so far as I can judge, was the Huber hive made practical. Mr. Bingham now uses a modification of this hive (Fig. 50).

In 1868, Mr. M. S. Snow, then of New York, now of Minnesota, procured a patent on his hive, which was essentially the same as the hives now known as the Quinby and Bingham hives.

Soon after, the late Mr. Quinby brought forth his hive, which is essentially the same as the above, only differing in details. No patent was obtained by Mr. Quinby, whose great heart and boundless generosity endeared him to all acquaintances. Those who knew him best, never tire of praising the unselfish acts and life of this noble man. If we except Mr. Langstroth, no other man has probably done so much to promote the interest and growth of improved apiculture in the United States. His hive, his book, his views of wintering, his introduction of the bellows-smoker—a gift to apiarists—all speak his praise as a man and an apiarist.

The facts that the Bingham hive, as now made, is a great favorite with those that have used it, that Mr. Quinby preferred this style or type of hive, that the Quinby form is used by the Hetherington brothers, Captain J. E., the prince of American apiarists, and O. J., whose neatness, precision, and mechanical skill are enough to awaken envy, are surely sufficient to excite curiosity and bespeak a description.

The Quinby hive (Fig. 49), as used by the Hetherington brothers, consists of a series of rectangular frames (Fig. 49) twelve by seventeen inches, outside measure. The ends of these frames are one and a half inches wide and half an inch

FIG. 49.

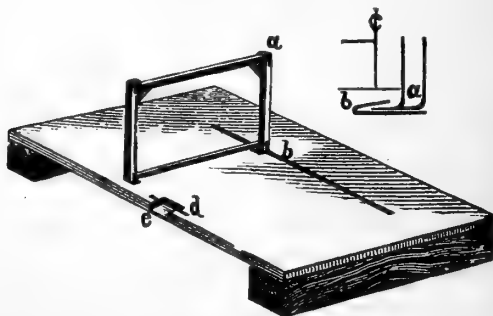

Frame, Bottom-Board and Frame-Support of Quinby Hive.

thick. The top and bottom one inch wide and half an inch thick. The outer half of the end bars projects one-fourth of an inch beyond the top and bottom bars. This projection is lined on the inside with sheet iron, which is inserted in a groove which runs one inch into each end of the end-pieces and is

tacked by the same nails that fasten the end-bars to the top and bottom-bars. This iron at the end of the bar bends in at right-angles (Fig. 49, *a*), and extends one-fourth of an inch parallel with the top and bottom-bars. Thus, when these frames stand side by side, the ends are close, while half-inch openings extend between the top and bottom-bars of adjacent frames. The bottom-bars, too, are one-fourth of an inch from the bottom-board. Tacked to the bottom-board, in line with the position of the back end-bars of the frames, is an inch strip of sheet-iron (Fig. 49, *b, b*) sixteen inches in length. One-third of this strip, from the front edge back, is bent over so it lies not quite in contact with the second third, while the posterior third receives the tacks which hold it to the bottom-board. Now, when in use this iron flange receives the hooks on the corners of the frames, so that the frames are held firmly, and can only be moved back and side-wise. In looking at the bees we can separate the combs at once, at any place. The chamber can be enlarged or diminished simply by adding or withdrawing frames. As the hooks are on all four corners of the frames, the frames can be either end back, or either side up. This arrangement, which permits the inversion of the frames, is greatly praised by those who have tried it. It is claimed, that by turning a frame bottom up the comb will be fastened above and below, and the bees, in their haste to carry the honey from the bottom of the frames, will rush at once into the sections. Boards with iron hooks close the side of the brood cavity, while a cloth covers the frames.

The entrance (Fig 49, *e*) is cut in the bottom-board as already explained, except that the lateral edges are kept parallel. A strip of sheet-iron (Fig. 49, *d*) is tacked across this, on which rest the ends of the front end-bars of the frames which stand above, and underneath which pass the bees as they come to and go from the hive. A box, without bottom and with movable top, covers all, leaving a space from four to six inches above and on all sides between it and the frames. This gives chance to pack with chaff in winter, and for side and top storing in sections in summer.

The Bingham hive (Fig. 50) is not only remarkably simple, but is as remarkable for its shallow depth; the frames being only five inches high. These have no bottom-bar. The end-bars are one and a half inches wide, and the top-bar square.

The nails that hold the end-bars pass into the end of the top bar, which is usually placed diagonally, so that an edge, not a face, is below; though some are made with a face below (Fig. 50, *f*), to be used when comb is transferred. The frames are held together by two wires, one at each end. Each wire (Fig. 50, *a*) is a little longer than twice the width of the hive when the maximum number of frames are used. The

FIG. 50.

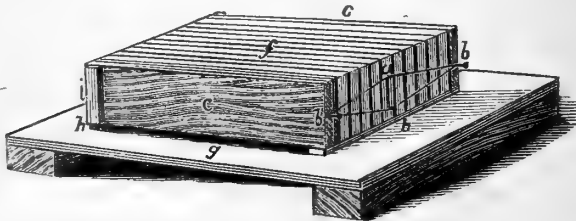
*Frames and Bottom-Board of the Bingham Hive.*

ends of each wire are united and placed about nails (Fig. 50, *b, b*) in the ends of the boards (Fig. 50, *c, c*) which form the sides of the brood-chamber. A small stick (Fig. 50, *a*) spreads these wires, and brings the frames close together. A box without bottom and with movable cover, is placed about the frames. This is large and high enough to permit of chaff packing in winter and spring. The bottom board may be made like the one already described. Mr. Bingham does not bevel the bottom-board, but places lath under three sides of the brood-chamber, the lath being nailed to the bottom-board. He uses the Langstroth blocks to contract the entrance (Fig. 50, *g*).

The advantages of this hive are, simplicity, great space above for surplus frames or boxes, capability of being placed one hive above another to any height desired, while the frames may be reversed, end for end, or bottom for top, or the whole brood-chamber turned up-side down. Thus, by doubling, we may have a depth of ten inches for winter.

The objection which I have found in the use of such hives, is danger of killing bees in rapid handling. They can be manipulated with rapidity if we care not how many bees we crush. It hurts me to kill a bee, and so I find the Langstroth style more quickly manipulated. Mr. Snow, too, who was

the first to make the above style of hive, has discarded it in favor of the Langstroth. His objection to the above, is the fact that the various combs are not sure to be so built as to be interchangeable. Yet that such apiarists as those above named prefer these Huber hives, after long use of the other style, is certainly not without significance.

OBSERVING HIVE.

To study bees while they are at work, requires a hive so constructed that we can look in upon all the bees of the hive at pleasure. For this purpose, I have used a small Langstroth hive (Fig. 51), containing one frame. Glass is used

FIG. 51.

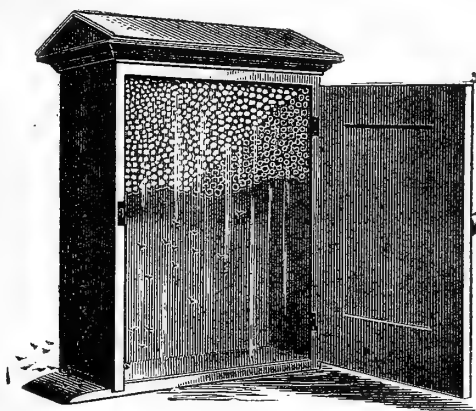
*Observing Hive.*

each side of the frame and this is shaded by doors, hung on hinges. We are able to look at the bees or make all dark inside at pleasure. To prevent the hive from becoming too crowded, we must every twenty-three or four days shake the bees from the frame and replace the latter with another frame, which shall contain no brood. From such a hive in my study window, I have received much pleasure and information.

APPARATUS FOR PROCURING COMB-HONEY.

Although I feel sure that extracted honey will grow more and more in favor, yet it will never supersede the beautiful comb, which, from its exquisite flavor and attractive appear-

ance, has always been, and always will be, admired and desired. So, no hive is complete without its arrangement of section-frames and crates, all constructed with the view of securing this delectable comb-honey in the form that will be most tempting to the eye and palate.

SURPLUS COMB-HONEY IN SECTIONS.

Honey in several-pound boxes is no longer marketable, and is now almost wholly replaced by comb-honey in sections. In fact, there is no apparatus for securing comb-honey that promises so well as these sections. That they are just the thing to enable us to tickle the market is shown by their rapid growth in popular favor. Some years ago I predicted, at one of our State Conventions, that they would soon replace boxes, and was laughed at. Nearly all who then laughed, now use these sections. They are cheap, and with their use we can get more honey, and in a form that will make it irresistible.

REQUISITES OF GOOD SECTIONS.

The wood should be white, the size just such as the market demands, the form such as is convenient to use with our hives, so made that they may be glassed, not too much cut off from brood-chamber, cheap, easily made, and so arranged as to be put on or taken off the hive *en masse*.

DESCRIPTION.

Since 1877, I have made neat, cheap sections, using clean white veneer, such as is used to make berry boxes. The veneer can be procured at the factories, of any width, and

FIG. 52.

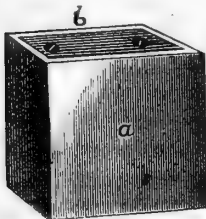

FIG. 53.



Cutting Edge of Chisel.

with a cross cut, so when they are bent they will be of any desired form and size. I have bent them around a block (Fig. 52), let them lap above the iron (Fig. 52, *b*), and tacked them with wrought tacks. To cut out spaces, I use a

chisel (Fig. 53), to cut out the space, so that the bees may enter the sections. These sections are awkward to glass, and only good for home market, as they are too frail to ship. They are cheap and easily made. They cost about two mills each.

The Hetherington brothers make a very neat section, as follows: The top and bottom are each two inches wide, of one-quarter inch white pine. These receive a groove one-eighth inch from the ends, which receives the sides, one inch wide and one-eighth inch thick, which are pressed through to a central position and glued. This section is five and a half inches square. They use wooden dividers (Fig. 54, *a*), one-eighth of an inch thick, as long as the section, but one inch

FIG. 54.

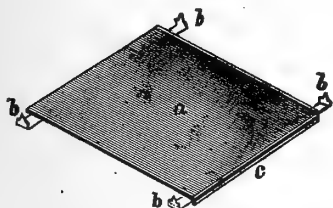

Separator.

FIG. 55.

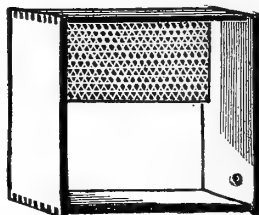

Dove-Tailed Section.

less in height, so that below and above is a half-inch space, which permits the bees to pass readily from one section to another. These are held by a half-inch strip of tin (Fig. 54, *b, b*), which passes through a groove (Fig. 54, *c*), in the ends of the dividers, and reaches half an inch farther; then turns at right-angles and ends in a point (Fig. 54, *b*), which, when in use, sticks into the top or bottom pieces; and so the four points hold the divider in place. When ready to sell, they insert half-inch glass in the grooves each side the narrow side-pieces, and with tins fasten glass on the faces, and have a very handsome section. It will be noticed that we have a half-inch space between the sections. It ought to be at least three-eighths of an inch. This makes inspection easy, aids in getting the bees out when the sections are removed, facilitates the passage of the bees, and the handling of the sections. -

Dr. C. C. Miller prefers sections made as are children's toy blocks, the sides fastened by a sort of mortise and tennon

arrangement (Fig. 55). I have received from Mr. James Heddon a similar section, very neat and beautifully finished, which is made in Vermont.

The Phelps-Wheeler-Betsinger sections (Fig. 56) are essentially the same. The top and bottom are three-eighths narrower than the sides, and are nailed to them. The Wheeler

FIG. 56.

*Nailed Section.*

FIG. 57.

*One Pound Section.*

FIG. 58.

*Prize Section.*

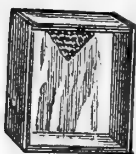
section—invented and patented by Mr. Geo. T. Wheeler, Mexico, New York, in 1870—is remarkable for being the first (Fig. 64, *K*) to be used with tin separators (Fig. 64, *M*). Instead of making the bottoms narrower for a passage, Mr. Wheeler made an opening in the bottom.

Another style of section, termed the one-piece-section (Fig. 57), is, as its name implies, made of a single piece of wood, with three cross cuts so that it can be easily bent into a square. The fourth angle unites by notches and projections as before described (Fig. 55). This is now patented by a Mr. Farncrook, of Wisconsin; but as I made and used essentially the same thing at least four years before the patent was granted, I do not see how it can be valid. Still I am no lawyer; much less a patent-right attorney. These one-piece sections are now, I think, the favorites among bee-keepers.

Heretofore there have been two prevailing sizes of sections in use in the United States; the prize section (Fig. 58) which is five and one-fourth by six and one-fourth inches, and the one pound section, (Fig. 57) which is four and one-fourth inches square. The latter is coming rapidly to the front, as honey in it sells more readily than if in a larger section. Even half pound sections have taken the lead in the Boston and Chicago markets the past season. It is quite possible that these small sections will rule in the markets of the future.

They would often sell more readily, and are far better to ship, as the combs would seldom ever break from the sections. If, in arranging our sections, we desire to have them oblong, we better make them so that they will be longest up and down. Mr. D. A. Jones finds that if so made, they are filled and capped much sooner. In the depth of the section, which fixes the thickness of the comb, a change from the common style seems to be desirable. Heretofore they have been generally made two inches deep. With such sections we must use separators to secure perfect combs. By reducing the depth to from one and three-eighths to one and three-fourth inches, the expense of separators is said to be unnecessary. We secure nicer comb for the table, and more bees are able to work on a crate or frame of sections, so that the foundation is more speedily drawn out. Of course any decided change in the form and size of our sections involves no small expense, as it requires that the crates or frames for holding the sections should also be changed. Often, however, by a little planning we can vary the form so as to reduce the size, without necessitating this expense.

HOW TO PLACE SECTIONS IN POSITION.

There are two methods, each of which is excellent and has, as it well may, earnest advocates—one by use of frames, the other by crates.

SECTIONS IN FRAMES.

Frames for holding sections (Fig. 59) are made the same size as the frames in the brood chamber. The depth of the frame, however, is the same as the depth of the sections. The bottom bar is three-eighths of an inch narrower than the remainder of the frame, so that when two frames are side by side, there is three-eighths of an inch space between the bottom bars, though the top and side pieces are close together. The sections are of such a size (Fig. 61, *K*) that four, or six, or nine, etc., will just fill one of the large frames. Nailed to one side of each large frame are two tin, or thin wooden strips (Fig. 61, *t, t*) in case separators are to be used, as long as the frame, and as wide into one inch as are the sections. These are tacked half an inch from the top and the bottom of the large frames, and so are opposite the sections, thus permitting the bees to pass readily

from one tier of sections to another, as do the narrower top and bottom-bars of the sections, from those below to those above. Captain Hetherington tells me that Mr. Quinby used these

FIG. 59.

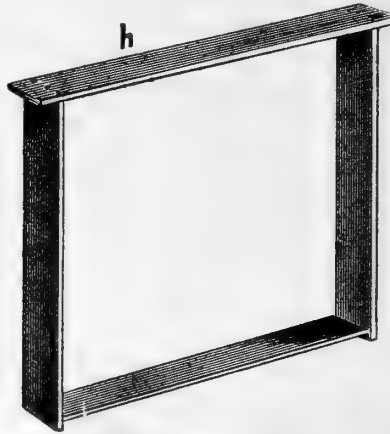
*Gallup Section-Front.*

years ago. The tin arrangement, though unlike Mr. Wheeler's (Fig. 64, *M*), would be readily suggested by it. It is more trouble to make these frames if we have the tins set in so as

FIG. 60.

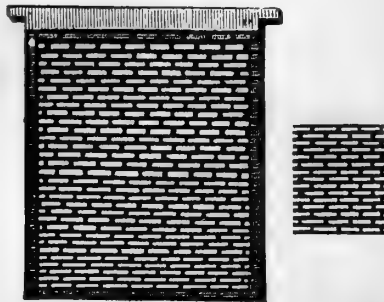
*Perforated Zinc Division-Board.*

just to come flush with the edge of the end-bars of the frames, but then the frames would hang close together, and would not be so stuck together with propolis. These may be hung in the

second story of a two-story hive, and just so many as to fill the same—my hives will take nine—or they can be put below, beside the brood-combs. Mr. Doolittle, in case he hangs these below, inserts a perforated division-board, so that the queen will not enter the sections and lay eggs.

The perforated zinc division-board (Fig. 60) would serve admirably for this purpose. A honey-board of the same material keeps sections, either in crates or frames, that are above the hive, neat, and also keeps the queen from entering them. The workers enter just as freely.

In long hives, the "New Idea"—which I find very satisfactory, after several years' trial, especially for extracted honey—I have used these frames of sections, and with the best success. The Italians enter them at once, and fill them even more quickly than other bees fill the sections in the upper

FIG. 61.

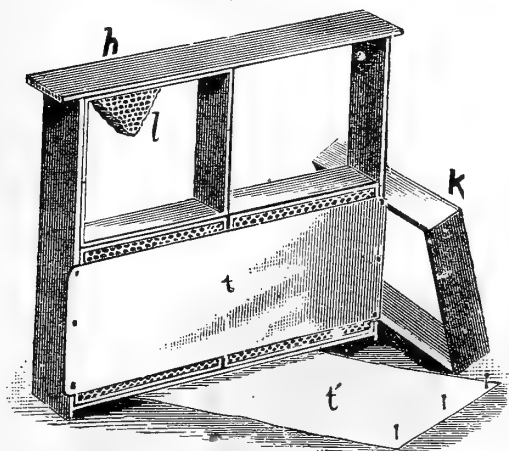
*Gallup Frame with Sections.*

story. In fact, one great advantage of these sections in the frames is the obvious and ample passage-ways, inviting the bees to enter them. But in our desire to make ample and inviting openings, caution is required that we do not over-do the matter, and invite the queen to injurious intrusion. So we have Charybdis and Scylla, and must, by study, learn to so steer between as to avoid both dangers.

Mr. Jones finds that by using the division-board made of perforated zinc (Fig. 60), the queen is kept from the sections, and they can be safely placed in one end of the body of the hive.

The coming summer I shall use six sections in the Gallup frame, each one, five and one-fourth by three and one-half

FIG. 62.

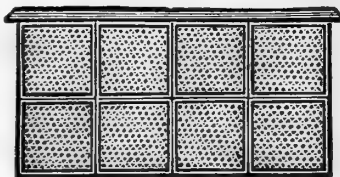
*Langstroth Frame with One Pound Sections.*

inches, and shall try some no thicker than one and three-eighths inches. Figure 62 shows a Langstroth frame full of one pound sections.

CRATES OR RACKS.

These (Fig. 37) are to use in lieu of large frames, to hold sections, and are very convenient when we wish to set the sections only one deep above the brood-chamber. Though, if desired, we can place one rack above another, as practiced by Mr. James Heddon, and so have sections two, and even three deep.

FIG. 63.

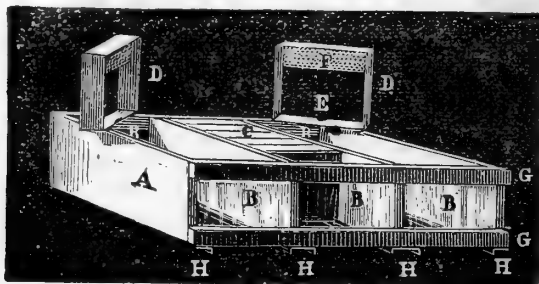
*Crate for Sections.*

Southard and Raney, of Kalamazoo, use a very neat rack (Fig. 63), in which they use the thin veneer sections. The

sheet-iron rests (Fig. 63, *H, H, H*), with their bent edges, just raise the rack one-fourth of an inch from the brood frames. Mr. Heddon uses a similar crate without the iron strips.

The Wheeler rack (Fig. 64) simply holds the sections, while each section is glassed separately.

FIG. 64.

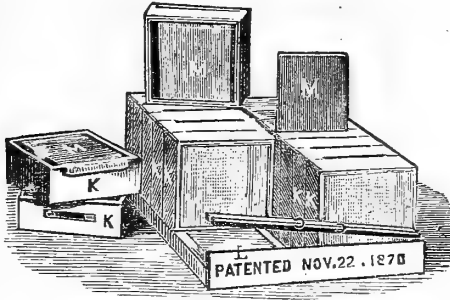
*Wheeler Rack.*

The most common crate now in use (Fig. 65) is simple and cheap. Long tins (Fig. 65, *b, b*) extend between the rows of sections, though these may be wood, the outside sections

FIG. 65.

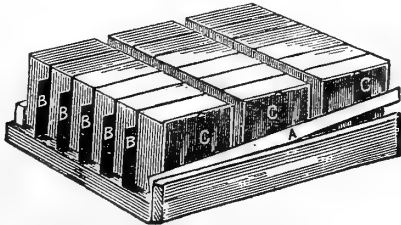
*Sections in Crate.*

receive glass (Fig. 65, *c, c*), while a clamp (Fig. 65, *a*) wedges the sections firmly in position.

Captain Hetherington sets a rack of sections above the frames, and stands sections one above the other on the side for side storing. Mr. Doolittle makes a rack by placing frames, such as I have described—except they are only half as high,

and hold but two sections—side by side, where they are held by tacking a stick on top across each end of the row. He also places two tiers, two deep, at each end of the brood-chamber, if he desires to give so much room.

Mr. Adam Grimm once wrote that boxes above the hive should not be closely covered. As already stated, Mr. Heddon puts no close cover over his sections. Mr. Hasty is pleased with simply a cloth, cheap muslin, about his sections and a board cover to protect from rains. Such ventilation of the sections is scientific as well as practical.

All apiarists who desire to work for comb honey that will sell, will certainly use the sections, and adjust them by use of either frames or crates. Each method has its friends, though I think crates are taking the lead.

FOOT POWER SAW.

Every apiarist, who keeps only a few bees, will find, if he makes his own hives, a foot power saw very valuable. I have used, with great satisfaction, the admirably combined foot power saw of W. F. & John Barnes. It permits rapid work, insures uniformity, and enables the apiarist to give a finish to his work that would rival that of the cabinet-maker.

Those who procure such a machine should learn to file and set the saw, and should *never* run the machine when not in perfect order.

When just beginning the business it will generally be wise to secure a fully equipped hive of some bee-keeper or dealer in supplies. If there is a hive factory near at hand, it may pay to buy all hives ready made; otherwise high freights make this unprofitable. If a person wishes to manufacture hives by the score, either for himself or others, even the foot power saw will soon become too slow and wearying. In this case some use wind power, which is too uncertain to give full satisfaction; others use horse-power, and still others procure a small steam engine.

Mr. M. H. Hunt, a very thoughtful apiarist, uses a very convenient horse power (Fig. 66). The large wheel is fifteen feet in diameter, the horse is inside the rim, and the band consists of a chain, that it may not slip. To get the horse in position, the wheel is lowered.

FIG. 66.



Horse Power.

In case we use other than foot or hand power, our saw table

FIG. 67.

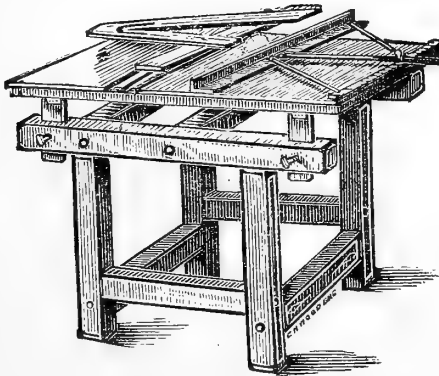

Saw Table.

must be firm and heavy. The one illustrated here (Fig. 67) is recommended by Mr. A. I. Root.

CHAPTER VI.

POSITION AND ARRANGEMENT OF APIARY.

As it is desirable to have our apiary grounds so fixed as to give the best results, and as this costs some money and more labor, it should be done once for all. As plan and execution in this direction must needs precede even the purchase of bees, this subject deserves an early consideration. Hence we will proceed to consider position, arrangement of grounds, and preparation for each individual colony.

POSITION.

Of course, it is of the first importance that the apiary be near at hand. In city or village this is imperative. In the country, or at suburban homes, we have more choice, but close proximity to the house is of much importance. In a city, it may be necessary to follow friend Muth's example, and locate on the house-tops, where, despite the inconvenience, we may achieve success. The lay of the ground is not important, though if a hill, it should not be very steep. It may slope in any direction, but better any way than toward the north.

ARRANGEMENT OF GROUNDS.

Unless sandy, these should be well drained. If a grove offers inviting shade, accept it, but trim high to avoid damp. Such a grove could soon be formed of bass-wood and tulip trees, which, as we shall see, are very desirable, as their bloom offers plenteous and most delicious honey. Even Virgil urged shade of palm and olive, also that we screen the bees from winds. Wind-screens are very desirable, especially on the windward side. Such a screen may be formed of a tall board fence, which, if it surrounds the grounds, will also serve to protect against thieves. Yet these are gloomy and forbidding, and will be eschewed by the apiarist who has an eye to esthetics. Ever-green screens, either of Norway spruce, Austrian or other pine, or arbor vitæ, each or all, are not only very effective, but are quickly grown, inexpensive, and add greatly to the beauty of the grounds. If the apiary is large,

a small, neat, inexpensive house, in the centre of the apiary grounds; is indispensable. This will serve in winter as a shop for making hives, frames, etc., and as a store-house for honey, while in summer it will be used for extracting, transferring, storing, bottling, etc. In building this, it will be well to construct a frost-proof, *thoroughly drained*, dark, and well-ventilated cellar. To secure the thorough ventilation, pass a tube, which may be made of tile, from near the bottom, through the earth to the surface; and another, from near the bottom, to the chimney or stove-pipe above (see chapters XVIII and XIX).

PREPARATION FOR EACH COLONY.

Virgil was right in recommending shade for each colony. Bees are forced to cluster outside the hive, if the hives are subjected to the full force of the sun's rays. By the intense heat, the temperature inside becomes like that of an oven, and the wonder is that they do not desert entirely. I have known hives, thus unprotected, to be covered with bees, idling outside, when by simply shading the hives, all would go merrily to work. The combs, too, and foundation especially, are liable, in unshaded hives, to melt and fall down, which is very damaging to the bees, and very vexatious to the apiarist. The remedy for all this is to always have the hives so situated that they will be entirely shaded all through the heat of the day. This might be done by constructing a shed or house, but these are expensive and inconvenient, and, therefore, to be discarded.

If the apiarist has a convenient grove, this may be trimmed high, so as not to be damp, and will fulfill every requirement. So arrange the hives that while they are shaded through all the heat of the day, they will receive the sun's rays early and late, and thus the bees will work more hours. I always face my hives to the east. If no grove is at command, the hives may be placed on the north of a Concord grape-vine (Fig. 68), or other vigorous variety, as the apiarist may prefer. This should be trained to a trellis, which may be made by setting two posts, either of cedar or oak. Let these extend four or five feet above the ground, and be three or four feet apart. Connect them at intervals of eighteen inches with three galvanized wires, the last one being at the top of the posts. Thus we can

have shade and grapes, and can see for ourselves that bees do not injure grapes. If preferred we may use evergreens for this purpose, which can be kept low, and trimmed square and close on the north. These can be got at once, and are super-

FIG. 68.

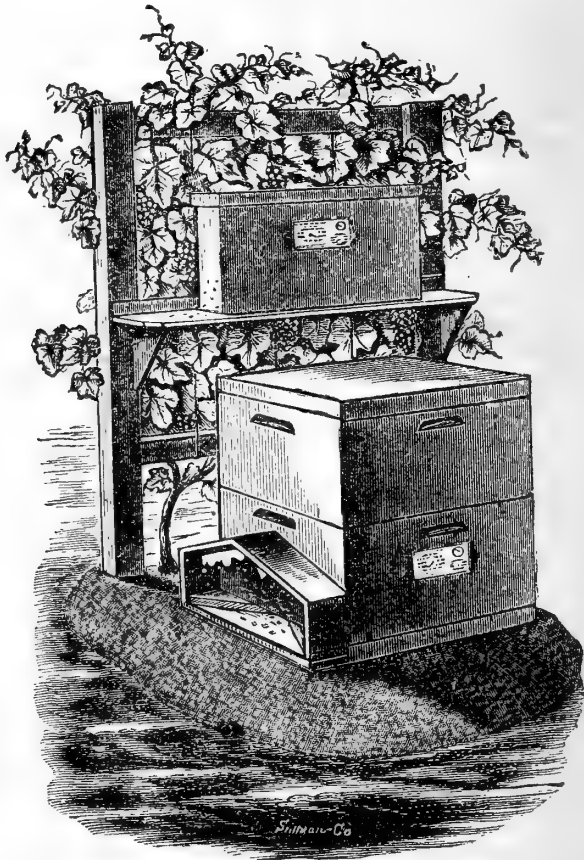

Nucleus and Simplicity Hive Shaded by Grape-vine.

ior in that they furnish ample shade at all seasons. Norway spruce is the best. These should be at least six feet apart. A. I. Root's idea of having the vine of each succeeding row divide the spaces of the previous row, in quincunx order (Fig.

FIG. 69.

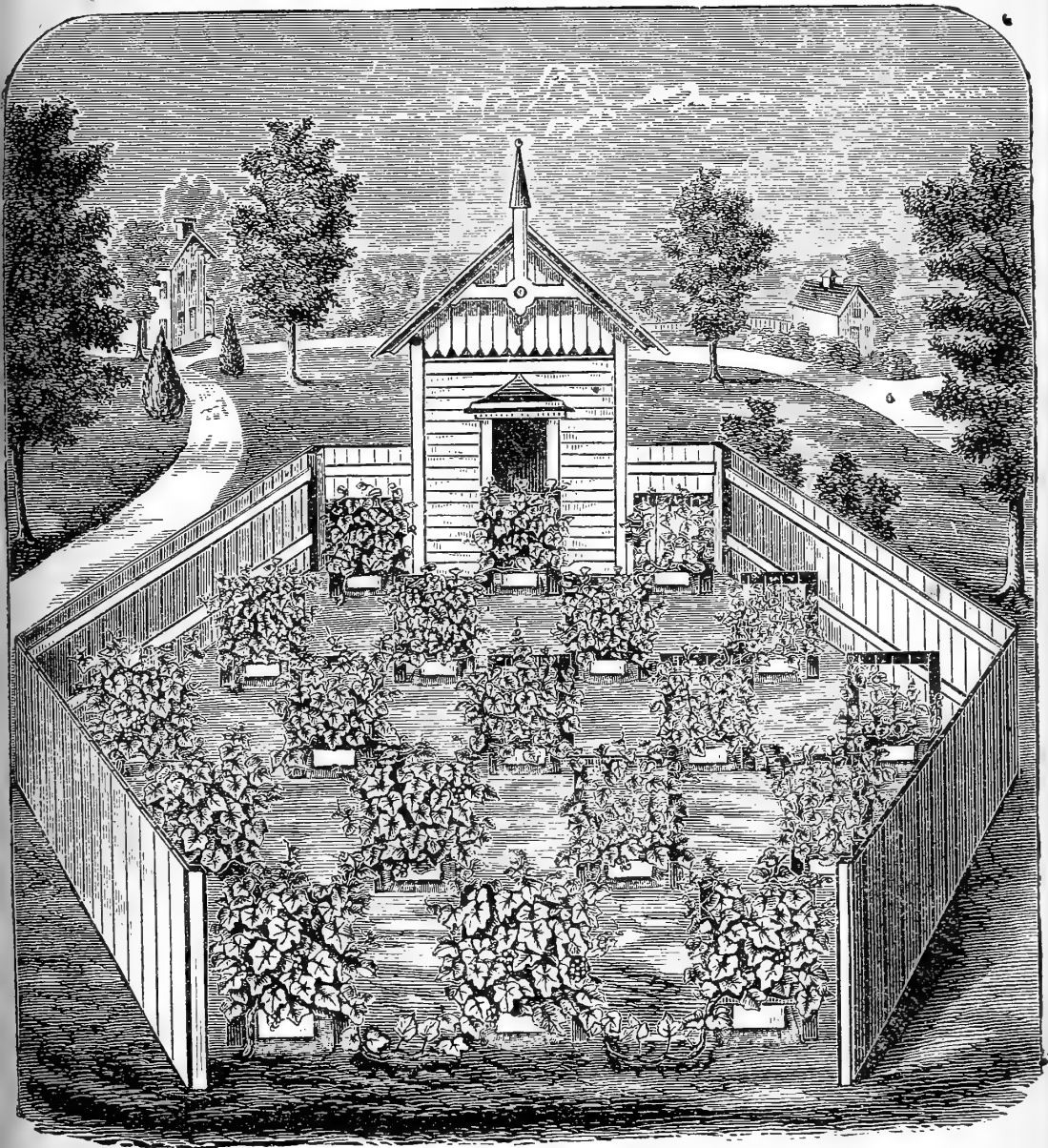

Grape-vine Apiary.

69), is very good; though I should prefer the rows in this case to be four, instead of three feet apart, especially with ever-greens. Until protecting shade can be thus permanently secured, boards or tent cloth covers should be arranged for temporary protection. Many apiarists economize by using fruit trees for this purpose, which from their spreading tops answer very well.

Mr. A. I. Root's idea of having sawdust under and about the hives is, I think, a good one. The hives of the Michigan Agricultural College (Fig. 70) are protected by evergreens, trimmed close on the north side. In the figure the artist has made a deciduous tree, and so it appears too spreading. A space four feet by six, north of the shrubs, was then dug out to a depth of four inches, and filled with sawdust (Fig. 70, *f*), underlying which were old bricks, so that nothing would grow up through the sawdust. The sawdust thus extends one foot back, or west of the hive, three feet north, and the same distance to the east or front side of the hive. This makes it neat about the hive, and largely removes the danger of losing the queen in handling the bees; as should she fall outside the hive, the sharp-sighted apiarist would be very likely indeed to see her.

Mr. J. H. Nellis, long the able Secretary of the North-Eastern Bee-Keepers' Association, objects to sawdust, as he thinks it rots too quickly, may take fire, and blows about badly. He would use sand or gravel instead. I have found another objection to the above plan. The grass comes up too freely. Having to change our apiary grounds, I dug the hole as above described, and covered the bottom with a thin layer of coal tar, upon which I placed a layer of brick, which I covered with concrete, and all with a thin layer of gravel. This work can be done after the busy season is over. The cost is very light, and we have a neat and permanent foundation for each hive. After the evergreens are well started, all the space between the sawdust areas should be in grass, and kept neatly mown. This takes but little time, and makes the apiary always pleasant and inviting.

FIG. 70.

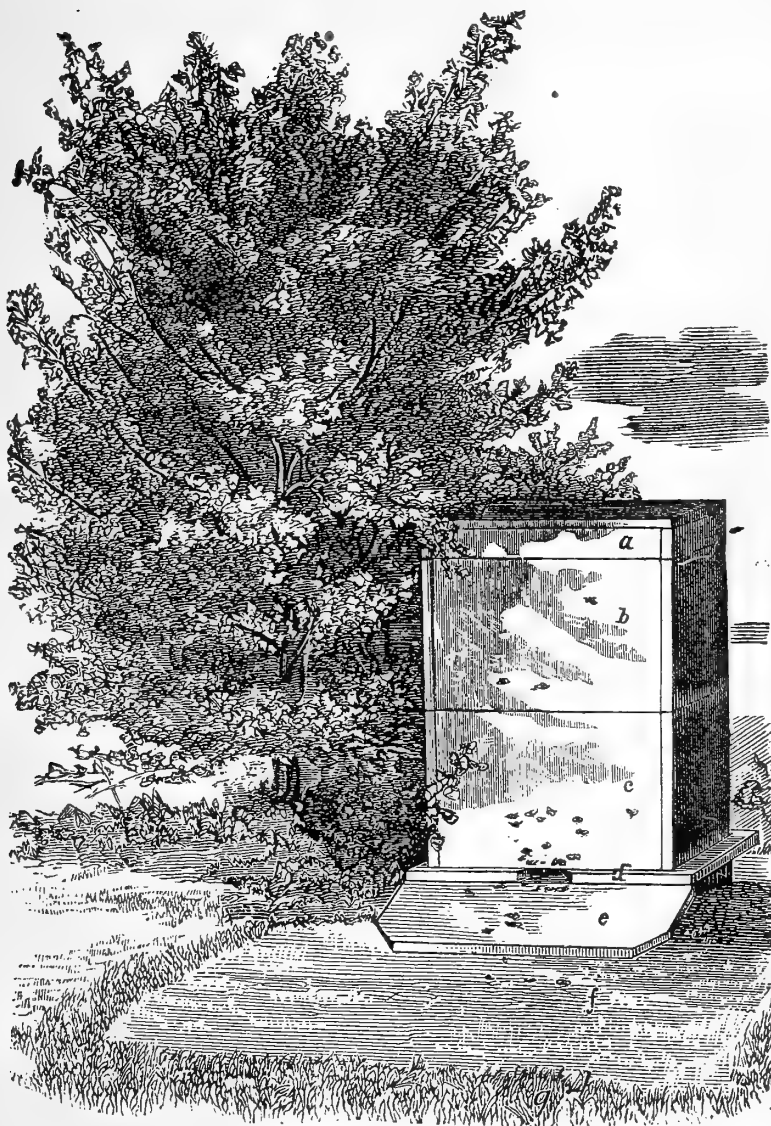

Two Story Hive Shaded by Evergreen.

CHAPTER VII.

TO TRANSFER BEES.

As you may have purchased your bees in box hives, barrels, or hollow logs, and so, of course, will desire to transfer them immediately into movable-frame hives, or, as already suggested, you may wish to transfer from one movable-frame to another, I will now proceed to describe the process.

Among the many valuable methods which Mr. Heddon has given to the bee-keeping public not the least valuable is that of transferring. By his method the work may be done at any season whenever the bees are on the wing. After blowing a little smoke into the hive; sufficient to alarm the bees, we set it a little aside, and put in its place our new hive full of wired foundation. We now turn the old hive, whatever it may be, bottom side up, and place a box over it. If the bees are sufficiently smoked, it will make no difference even if the box is not close fitting to the old hive. We then with a stick or hammer rap on the hive for from ten to twenty minutes. The bees will fill with honey and go with the queen into the upper box and cluster. If towards the last we carefully set the box off once or twice, and vigorously shake the hive, and then replace the box, we will hasten the emigration of the bees, and make it more complete. I got this suggestion from Mr. Baldridge. A few young bees will still remain in the old hive, but these will do no harm.

We next take the box which contains the queen and nearly all the bees, and shake the bees all out in front of the hive, already placed on the old stand. The bees will at once take possession, draw out the foundation in a surprisingly short time, and will give us a set of combs which will surpass in beauty those procured in any other way. Should the bees be unable to gather any honey for some days, of course we must feed them, but as we shall see in the sequel, this will pay, even were it unnecessary.

We set the old hive aside for twenty-one days, when the young bees will all come from the cells. Should the weather be cold, we might have to put this in a warm room, so the

brood will not chill. We now drum out these bees as before, kill the queen, which has been reared, and unite the bees with the others, or form a separate colony as before—except that we supply them with a queen—as the number of bees determines. We can now split out the corners of the old hive, split the gum, or separate the staves of the barrel, so as not to break the comb. This should be carefully cut loose, and the honey extracted by use of the wire comb-holder (Fig. 92) and the comb melted into wax for foundation. The only loss in this method is the time which the bees require to draw out the foundation, and this is far more than made up in the superior combs which are secured. I think the time expended in melting up the combs, etc., is more than made up by the time saved in transferring.

THE OLD METHOD.

If one has no foundation, or desires to give the bees the comb and honey at once, even at the cost of unshapely combs, he then should drum the bees out as before, and put the box containing the bees on the old stand, leaving the edge raised so that the bees which are out may enter, and so all the bees can get air. This method is difficult, except in spring, and is best done about noon when the bees are busy on the fruit bloom. If other bees do not trouble, as they usually will not if busily gathering, we can proceed in the open air. If they do, we must go into some room. I have frequently transferred the comb in my kitchen, and often in a barn. Now knock the old hive apart, as already described, cut the combs from the sides, and get the combs out of the old hive with just as little breakage as possible. Mr. Baldrige, if transferring in spring, saws the combs and cross-sticks loose from the sides, turns the hive into the natural position, then strikes against the top of the hive with a hammer till the fastenings are broken loose, when he lifts the hive, and the combs are all free and in convenient shape for rapid work.

We now need a barrel, set on end, on which we place a board fifteen to twenty inches square, covered with several thicknesses of cloth. Some apiarists think the cloth useless, but it serves, I think, to prevent injury to comb, brood, or honey. We now place a comb on this cloth, and a frame on the comb, and cut out the comb the size of the inside of the

frame, taking pains to save all the worker brood. Now crowd the frame over the comb, so that the latter will be in the same position that it was when in the old hive; that is, so the honey will be above—the position is not very important—then fasten the comb in the frame, by winding about all one or two small wires or pieces of wrapping twine. To raise the frame and comb before fastening, raise the board beneath till the frame is vertical. Set this frame in the new hive, and proceed with the others in the same way till we have all the worker-comb—that with small cells—fastened in. To secure the pieces, which we shall find abundant at the end, take thin pieces of wood, one-half inch wide and a trifle longer than the frame is deep, place these in pairs either side the comb, extending up and down, and enough to hold the pieces secure till the bees shall fasten them (Fig. 71), and secure the strips by winding

FIG. 71.

*Transferred Comb.*

FIG. 72.

*Transferring Clasp.*

with small wire, just below the frame (Fig. 72), or by use of small rubber rings, or else tack them to the frame with small tacks. Some bee-keepers use U-shaped pieces of wire or tin to hold the comb in the frame.

Captain Hetherington has invented and practices a very neat method of fastening comb into frames. In constructing his frames, he bores small holes through the top, side, and bottom-bars of his frames, about two inches apart; these holes are just large enough to permit the passage of the long spines of the hawthorn. Now, in transferring comb, he has but to stick these thorns through into the comb to hold it securely. He can also use all the pieces, and still make a neat and secure frame of comb. He finds this arrangement convenient, too, in strengthening insecure combs. In answer to my

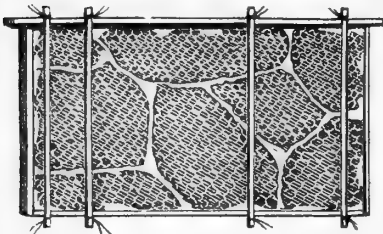
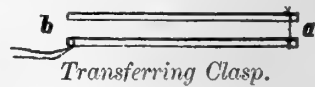
inquiry, this gentleman said it paid well to bore such holes in all his frames, which are eleven by sixteen inches, inside measure. I discarded such frames because of the liability of the comb to fall out.

Having fastened all the nice worker comb into the frames—of course all other comb will be melted into wax—we place all the frames containing brood together in the centre of our new hive, especially if the colony is weak, or the weather cool, and confine the space by use of the division board, adding the other frames as the bees may need them. We now place our new hive on the stand, pushing it forward so that the bees can enter anywhere along the alighting board, and then shake all the bees from the box, and any young bees that may have clustered on any part of the old hive, or on the floor, or ground, where we transferred the comb; immediately in front. They will enter at once and soon be at work, all the busier for having passed “from the old house into the new.” In two or three days, remove the wires, or strings and sticks, when we shall find the combs all fastened and smoothed off, and the bees as busily engaged as though their present home had always been the seat of their labors.

In practicing this method, many proceed at once to transfer without drumming out the bees. In this case the bees should be well smoked, should be driven away from the side of the old hive where the combs are being cut loose, by use of the smoker, and may be brushed direct from the old combs into the new hive. This method will be preferred by the experienced, though I think the beginner will find it more easy and pleasant to first drum out all the bees before he commences to cut out the combs.

Of course, in transferring from one frame to another, the matter is much simplified. In this case, after thoroughly smoking the bees, we have but to lift the frames and shake or brush the bees into the new hive. For a brush, a chicken or turkey wing, a large wing or tail feather from a turkey, goose, or peacock, or a twig of pine or bunch of asparagus twigs, serves admirably. Now cut out the comb in the best form to accommodate the new frames, and fasten as already suggested. After the combs are all transferred, shake all remaining bees in front of the new hive, which has already been placed on the stand previously occupied by the old hive.

Sometimes bees from trees in the forest are transferred to hives and the apiary.

HUNTING BEE TREES.

Except for recreation, this is seldom profitable. It is slow and uncertain work. The tree when found is not our own, and though the owner may consent to our cutting it, he may dislike to do so. The bees, when found, are difficult to get alive; it is even more difficult to get the honey in good condition, and when secured, the honey and bees are often almost worthless.

The principle upon which bees are "lined" is this; that after filling with honey, a bee always takes a direct course—"a bee-line"—to its hive. To hunt the bee trees we need a bottle of sweetened water, a little honey-comb, unless the bees are gathering freely from forest flowers, and a small bottomless box with a sliding glass cover, and a small shelf attached to the middle of one side on the inside of the box. A shallow tray or piece of honey-comb is to be fastened to this shelf. If the bees are not found on flowers, we can attract them by burning a piece of honey-comb. If on a flower, set the box over them after turning a little of the sweetened water in the comb or tray on the shelf. It is easy to get them to sipping this sweet. Then slide the glass, and when they fly, watch closely and see the direction they take. By following this line, we come to the bee tree, or more likely to some neighbor's apiary. By getting two lines, if the bees are from the same tree, where the lines meet, there the tree will be. We should be careful not to be led to apiaries, and should look very closely when the bees fly, to be sure of the line. Experience makes a person quite skillful. When a tree is found, we must use all possible ingenuity to get the combs whole if we wish to transfer the bees.

CHAPTER VIII.

FEEDING AND FEEDERS.

As already stated, it is only when the worker-bees are storing that the queen deposits to the full extent of her capability, and that brood-rearing is at its height. In fact, when storing ceases, general indolence characterizes the hive. This is peculiarly true of the German and Italian races of bees. Hence, if we would achieve the best success, we must keep the workers active, even before gathering commences, as also in the interims of honey secretion by the flowers; and to do this we must feed sparingly before the advent of bloom in the spring, and whenever the workers are forced to idleness during any part of the season, by the absence of honey-producing flowers. For a number of years, I have tried experiments in this direction by feeding a portion of my colonies early in the season, and in the intervals of honey-gathering, and always with marked results in favor of the practice.

Mr. D. A. Jones has truly said, that if feeding in the autumn be deferred too long, till the queen ceases laying, it often takes much time to get her to resume, and not infrequently we fail entirely.

Every apiarist, whether novice or veteran, will receive ample reward by practicing stimulative feeding early in the season; then his hive at the dawn of the white clover era will be redundant with bees, well filled with brood, and in just the trim to receive a bountiful harvest of this most delicious nectar.

Feeding, too, is often necessary to secure sufficient stores for winter—for no apiarist, worthy of the name, will suffer his faithful, willing subjects to starve, when so little care and expense will prevent it.

HOW MUCH TO FEED.

If we only wish to stimulate, the amount fed need not be great. A half pound a day, or even less, will be all that is necessary to encourage the bees to active preparation for the good time coming. For information in regard to supplying stores for winter see Chapter XVIII.

WHAT TO FEED.

For this purpose I would feed granulated sugar, reduced to the consistency of honey, or else extracted honey kept over from the previous year. The price of the latter will decide which is the more profitable. Honey, too, that has been drained or forced out of cappings, etc., is good, and only good, to feed. To make the syrup, I use one quart of water to two of sugar, and heat till the sugar is dissolved.

Many advise feeding the poorer grades of sugar in spring. My own experience makes me question the policy of ever using such feed for bees. The feeding of glucose or grape sugar is even worse policy. It is bad food for the bees, and its use is dangerous to the bee-keeper's reputation, and injurious to our brother bee-keepers. Glucose is so coupled with fraud and adulteration that he who would "avoid the appearance of evil" must let it severely alone.

In all feeding, unless extracted honey is what we are using, we cannot exercise too great care that such feed is not carried to the surplus boxes. Only let our customers once taste sugar in their comb-honey, and not only is our own reputation gone, but the whole fraternity is injured. In case we wish to have our combs in the sections filled or capped, we must feed extracted honey, which may often be done with great advantage.

HOW TO FEED.

The requisites of a good feeder are: Cheapness, a form to admit quick feeding, to permit no loss of heat, and so arranged that we can feed at all seasons without in any way disturbing the bees. The feeder (Fig. 73) which I have used with good satisfaction, is a modified division-board, the top-bar of which (Fig. 73, *b*) is two inches wide. From the upper central portion, beneath the top-bar, a rectangular piece, the size of an oyster-can, is replaced with an oyster-can (Fig. 73, *g*), after the top of the latter has been removed. A vertical piece of wood (Fig. 73, *d*) is fitted into the can so as to separate a space about one inch square, on one side, from the balance of the chamber. This piece does not reach quite to the bottom of the can, there being a one-eighth inch space beneath. In the top-bar there is an opening (Fig. 73, *e*) just above the smaller space below. In the larger space is a wooden float (Fig. 73, *f*) full of holes. On one side, opposite the larger chamber of the

can, a half-inch piece of the top (Fig. 73, *e*) is cut off, so that the bees can pass between the can and top-bar on to the float, where they can sip the feed. The feed is turned into the hole in the top-bar (Fig. 73, *e*), and without touching a bee, passes down under the vertical strip (Fig. 73, *d*) and raises the float (Fig. 73, *f*). The can may be tacked to the board at the ends near the top. Two or three tacks through the can into the vertical piece (Fig. 73, *d*) will hold the latter firmly in place; or the top-bar may press on the vertical piece so that it cannot move. Crowding a narrow piece of woolen cloth between the can and board, and nailing a similar strip around the beveled edge of the division-board, makes all snug. The objection to

FIG. 73.

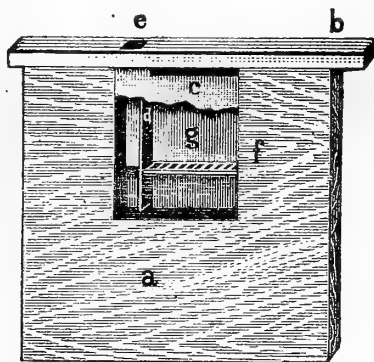
*Division-Board Feeder.*

Lower part of the face of the can removed, to show float, etc.

this feeder is that it can not be placed just above the cluster of bees. On very cold days in spring the bees can not reach their food in any other position. The feeder is placed at the end of the brood-chamber, and the top-bar covered by the quilt. To feed, we have only to fold the quilt over, when with a tea-pot we pour the feed into the hole in the top-bar. If a honey-board is used, there must be a hole in this just above the hole in the division-board feeder. In either case, no bees can escape, the heat is confined, and our division-board feeder is but little more expensive than a division-board alone.

Some apiarists prefer a quart can with finely perforated cover. This is filled with liquid, the cover put on, and the

whole quickly inverted and set above a hole in the cover just above the bees. Owing to the pressure of the air, the liquid will not descend so rapidly that the bees cannot sip it up. The objections to this feeder are, that it is awkward, raises the cushions so as to permit the escape of heat, and must be removed to receive the feed.

The Simplicity feeder (Fig. 74), invented by Mr. A. I. Root, is shown on its side in the illustration. This is used at the entrance, and so is not good for cold weather. As the feed is exposed it can only be used at night, when the bees are not flying.

FIG. 74.

*Simplicity Bee-Feeder.*

FIG. 75.

*Shuck's Boss Bee-Feeder.*

The Shuck feeder (Fig. 75) is a modification of the Simplicity, and a great improvement. This is used at the entrance of the hive or by nailing two together so that the sides marked *D* will face each other. We can use it above the bees. We then would place the opening *D*, above a hole in the cloth cover, or honey board, turn the feed in at *C*, and the bees would come up at *D*, pass under the cover, and down into the saw-cuts (Fig. 75, *A, A*) when they would sip the

feed, and then crawl up on the partitions. This feeder works admirably, but it is patented, costs too much, and is improved in the

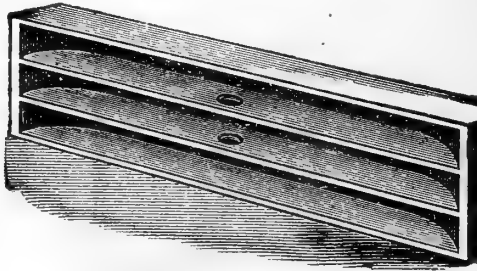
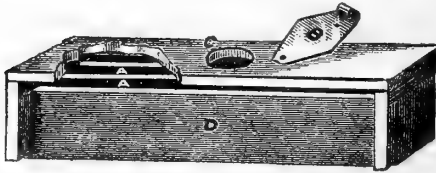
SMITH FEEDER.

This feeder was sent me by my friend, John Smith, of Massachusetts. I have used it two years, and think it fills every requirement of a perfect feeder.

This feeder (Fig. 76) is larger than the Shuck, and is covered all over with wire gauze (Fig. 76, *a*), which is raised by the wooden rim, so that the bees can pass readily over the partitions, (Fig. 76). The central saw-cuts (Fig. 76) do

FIG 76.

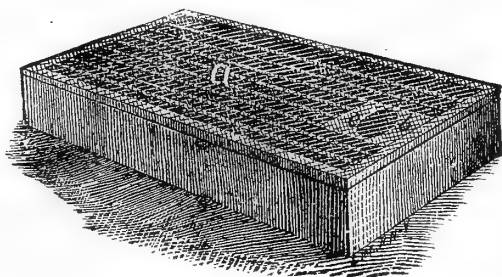

Smith Feeder.

not reach the end of the feeder, so there is a platform left (Fig. 76, *b*) through which a hole (Fig. 76, *c*) is made. This rests above a hole in the cloth below, and is the door through which the bees reach the feed. When in position just above the bees, it may be covered by a shingle or piece of paste-board, and all by the chaff cushion. To feed, we have only to raise the cushion and the paste-board, and turn the food through the gauze. No bees can get out, there is no disturbance, no danger from the robbers, and we can feed at any time, and can feed very rapidly if desired.

Mr. D. A. Jones and many others with tight bottom boards use no feeder, but turn the feed right into the hive. Even had I such hives I think I should still prefer to use such a feeder as that just described.

The best time to feed is just at night-fall. In this case the

feed will be carried away before the next day, and the danger to weak colonies from robbing is not so great.

In feeding during the cold days of April, all should be close above the bees to economize the heat. In all feeding, care is requisite that we may not spill the feed about the apiary, as this may, and very generally will, induce robbing.

If, through neglect, the bees are found to be destitute of stores in mid-winter, it is not best to feed liquid food, but solid food, like the Viallon candy or the Good mixture of honey and sugar, which will be described under the head of shipping queens. Cakes of either of these should be placed on the frames above the cluster of bees.

CHAPTER IX.

QUEEN REARING.

Suppose the queen is laying two thousand eggs a day, and that the full number of bees is forty thousand, or even more—though as the bees are liable to many accidents, and as the queen does not always lay to her full capacity, it is quite probable that this is about an average number—it will be seen that each day that a colony is without a queen there is a loss equal to about one-twentieth of the working force of the colony, and this is a compound loss, as the aggregate loss of any day is its special loss, augmented by the several losses of the previous days. Now, as queens are liable to die, or to become impotent, and as the work of increasing colonies demands the absence of queens, unless the apiarist has extra ones at his command, it is imperative, would we secure the best results, to ever have at hand extra queens. So the young apiarist must early learn

HOW TO REAR QUEENS.

As queens may be needed early in the spring, preparations looking to the rearing of queens must commence early. As soon as the bees are able to fly regularly, we must see that they have a supply of bee-bread. If there is not a supply from the past season, and the locality of the bee-keeper does not furnish an early supply, then place unbolted flour, that of rye or oats is best, in shallow troughs near the hives. It may be well to give the whole apiary the benefit of such feeding before the flowers yield pollen. Yet, I have found that here in Central Michigan, bees can usually gather pollen by the first week of April, which I think is as early as they should be allowed to fly, and in fact as early as they will fly with sufficient regularity to make it pay to feed the meal. I much question, after some years of experiment, if it ever pays at this place to give the bees a substitute for pollen. If one's locality demands this early feeding of meal, the bees can be induced to work readily at storing the material by dropping a little honey on it.

The best colony in the apiary—or, if there are several colonies of equal merit, one of these—should be stimulated to the utmost, by daily feeding, and by increase of brood taken from other colonies. As this colony becomes strong, a comb containing drone cells should be placed in the centre of the brood nest. Very soon drone eggs will be laid. I have often had drones flying in early May. As soon as the drones commence to hatch out, remove the queen and all eggs and uncapped brood from some good, strong colony, and replace it with eggs or brood just hatched from the colony containing the queen, from which it is desired to breed. By having placed one or two bright, new, empty combs in the midst of the brood nest of this colony, four days beforehand, we shall have in these combs just such eggs and newly hatching brood as we desire, with no brood that is too old.

If we have more than one colony whose excellence warrants their use to breed from, then these eggs should be taken from some other than the one which has produced our drones. This will prevent the close in-breeding which would of necessity occur if both queens and drones were reared in the same colony; and which, though regarded as deleterious in the breeding of all animals, should be practiced in case one single queen is of decided superiority to all others of the apiary. The queen and the brood that have been removed may be used in making a new colony, in a manner soon to be described under “dividing or increasing the number of colonies.” This queenless colony will immediately commence forming queen-cells (Fig. 78). Sometimes these are formed to the number of fifteen or twenty, and in case of the Syrian and Cyprian races, fifty or sixty, and they are started in a full, vigorous colony; in fact, under the most favorable conditions. Cutting off edges of the comb, or cutting holes in the same where there are eggs or larvæ just hatched, will almost always insure the starting of queen-cells in such places. It will be noticed that our queens are started from eggs, or from larvæ but just hatched; as we have given the bees no other, and so are fed the royal pabulum from the first. Thus, we have met every possible requisite to secure the most superior queens. By removal of the queen we also secure a large number of cells, while if we waited for the bees to start the cells preparatory to natural swarming, in which case we secure the two

desirable conditions named above, we shall probably fail to secure so many cells, and may have to wait longer than we can afford.

Even the apiarist who keeps black bees and desires no others, or who has only pure Italians, will still find that it pays to practice this selection, for, as with the poultry fancier, or the breeder of our larger domestic animals, the apiarist is ever observing some individuals of marked superiority, and he who carefully selects such queens to breed from, will be the one whose profits will make him rejoice, and whose apiary will be worthy of all commendation. As will be patent to all, by the above process we exercise a care in breeding which is not surpassed by the best breeders of horses and cattle, and which no wise apiarist will ever neglect.

It is often urged, and I think with some truth, that we shall secure better queens if we wait for the queen-cells to be started naturally by the bees, under the swarming impulse; and by early feeding and adding brood from other colonies we can hasten this period; yet, if we feed to stimulate, whenever the bees are not storing, and keep the colony redundant in bees of all ages by adding plenty of capped brood from other colonies, we shall find that our queens are little, if any, inferior, even if their production is hastened by removal of a queen from the hive. If these directions are closely followed, there will be little brood for the bees to feed, and the queen-cells will not suffer neglect. Mr. Quinby not only advised this course, but he recommended starting queen cells in nuclei; but he emphasized the importance of giving but very little brood, so nearly all the strength of the nurse bees would be expended on the queen-cells.

After we have removed all the queen-cells, in manner soon to be described, we can again supply eggs, or newly-hatched larvæ—always from those queens which close observation has shown to be the most vigorous and prolific in the apiary—and thus keep the same queenless colony, or colonies, engaged in starting queen-cells till we have all we desire. Yet we must not fail to keep this colony strong by the addition of *capped* brood, which we may take from any hive as most convenient. We must be cautious that our cells are started from only such brood as we take from the choicest queen. I have good reason to believe that queen-cells should not be started after

the first of September, as I have observed that late queens are not only less prolific, but shorter lived. In nature, late queens are rarely produced, and if it is true that they are inferior, it might be explained in the fact that their ovaries remain so long inactive. As queens that are long unmated are utterly worthless, so, too, freshly mated queens long inactive may become enfeebled. However, some of our best queen-breeders think late queens just as good. Possibly they may be if reared with the proper cautions.

In eight or ten days the cells are capped, and the apiarist is ready to form his

NUCLEI.

A nucleus is simply a miniature colony of bees—a hive and colony on a small scale, for the purpose of rearing and keeping queens. We want the queens, but can afford to each nucleus only a few bees. The nucleus hive, if we use frames not more than one foot square, need be nothing more than an ordinary hive, with chamber confined by a division-board to the capacity of three frames. If our frames are large, then it may be thought best to construct special nucleus hives. These are small hives, which need not be more than six inches each way, that is, in length, breadth, and thickness, and made to contain from four to six frames of corresponding size. These frames are filled with comb. I have for several years used the first named style of nucleus hive, and have found it advantageous to have a few long hives made, each to contain five chambers, while each chamber is entirely separate from the one next to it, is five inches wide, and is covered by a separate, close-fitting board, and the whole by a common cover. The entrance for the two end chambers is at the ends near the same side of the hive. The middle chamber has its entrance at the middle of the side near which are the end entrances, while the other two chambers open on the opposite side, as far apart as is possible. The outside might be painted different colors to correspond with the divisions, if thought necessary, especially on the side with two openings. Yet I have never taken this precaution, nor have I been troubled much by losing queens. They have almost invariably entered their own apartments when returning from their wedding tour. These hives I use to keep queens in during the summer. Except the apiarist engages in queen-

rearing extensively as a business, I doubt the propriety of building such special nucleus hives. The usual hives are good property to have in the apiary, will soon be needed, and may be economically used for all nuclei. In spring I make use of my hives which are prepared for prospective summer use, for my nuclei.

Mr. E. M. Hayhurst, one of our best queen breeders, uses the full size Langstroth frame, in full sized hives, for queen-rearing, while Mr. Root uses the same frames in small special hives which hold three frames. These (Fig. 68) he fastens high up on his grape-vine trellises, just back of his other hives, which can be used for seats as he works with the nuclei.

We now go to different hives of the apiary, and take out three frames for each nucleus, at least one of which has brood, and so on, till there are as many nuclei prepared as we have queen-cells to dispose of. The bees should be left adhering to the frames of comb, only *we must be certain that the queen is not among them*, as this would take the queen from where she is most needed, and would lead to the sure destruction of one queen-cell. To be sure of this, never take such frames till *you have seen the queen*, that you may be *sure* she is left behind. It is well to close the nucleus for at least twenty-four hours, so that enough bees will surely remain to cover the combs, and so prevent the brood from becoming chilled. If any desire the nuclei with smaller frames, these frames must of course be filled with comb, and then we can shake bees immediately into the nuclei, till they shall have sufficient to preserve a proper temperature. Such special articles about the apiary are costly and inconvenient. I believe that I should use hives even with the largest frames for nuclei. L. C. Root who uses the large Quinby frame uses the same for his nuclei. In this case we should need to give more bees. Twenty-four hours after we have formed this nucleus, we are ready to insert the queen cell. We may do it sooner, even at once, but always at the risk of having the cell destroyed. To insert the queen-cell—for we are now to give one to each nucleus, so we can never form more nuclei than we have capped queen-cells—we first cut it out, using a sharp thin-bladed knife, commencing to cut on either side the base of the cell, at least one-half inch distant, for *we must not in the least compress the cell*, then cutting up and out for two inches, then across opposite the cell. This leaves the cell

attached to a wedge-shaped piece of comb (Fig. 77), whose apex is next to the cell. A similar cut in the middle frame of the nucleus, which in case of the regular frames is the one containing brood, will furnish an opening to receive the wedge containing the cell. The comb should also be cut away beneath (Fig. 77), so that the cell cannot be compressed. Mr.

FIG. 77.

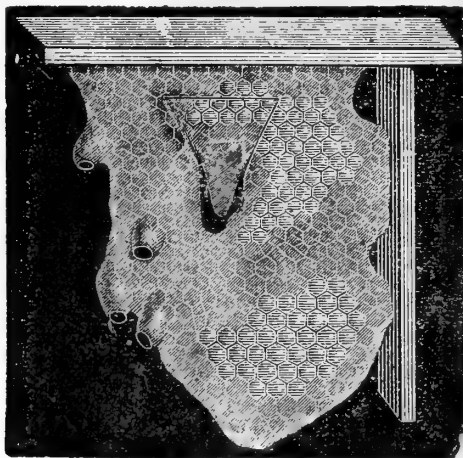

Root; advises a circular cut (Fig 78). If two or more fine cells; are so close together that separation is impossible, then all may be inserted in a nucleus. By close watching afterward we may save all the queens. If we have used bright new comb as advised above, we can see the queen move in the cell if she is ready to come out, by holding it between us and the sun, and may uncap such cells, and let the queen run in at the entrance of any queenless hive or nucleus at once. In selecting combs for queen cells, we should reject any that have drone comb. Bees sometimes start queen cells over drone larvæ. Such cells are smoother than the others, and of course are worthless. After all the nuclei have received their cells and bees, they have only to be set in a shady place and watched to see that sufficient bees remain. Should too many leave, give them more by removing the cover and shaking a frame loaded with bees over the nucleus; keep the opening

nearly closed, and cover the bees so as to preserve the heat. The main caution in this is to be sure not to get any old queen in a nucleus. In two or three days the queens will hatch, and in a week longer will have become fertilized, and that, too, in

FIG. 78.

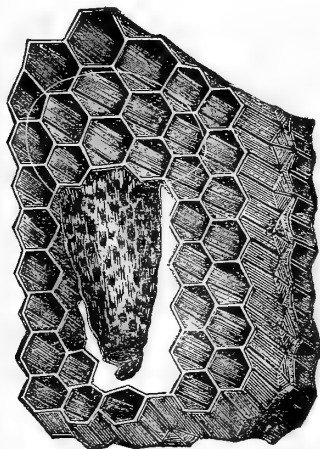
*Queen Cell with Hinged Cap.*

case of the first queens, by selected drones, for as yet there are no others in the apiary. I cannot over-estimate the advantage of always having extra queens. To secure mating from selected drones, later, we must cut all drone-comb from inferior colonies, so that they shall rear no drones. If drone larvæ are in uncapped cells, they may be killed by sprinkling the comb with cold water. By giving the jet of water some force, as may be easily done by use of a fountain pump, they may be washed out, or we may throw them out with the extractor, and then use the comb for starters in our sections. It is very important that those who rear queens to sell shall have no near neighbors who keep bees, and shall keep only very superior bees, that undesirable mating may be prevented. If drones are flying from undesirable colonies, they can be kept from leaving the hive by use of the entrance guards (Fig. 79). These are made of the perforated zinc, and while they permit the passage of the workers, they restrain the queen and drones. By shaking all the bees in front of the hive, we can, by use

of these, soon weed out all the drones. With these in front of a hive, we can keep the queen from leaving with a swarm. Occasionally a queen will crowd through. By keeping empty frames and empty cells in the nuclei, the bees may be kept

FIG. 79.

*Entrance Guard.*

active; yet with so few bees, one cannot expect very much from the nuclei. After cutting all the queen-cells from our old hive, we can again insert eggs, as above suggested, and obtain another lot of cells, or, if we have a sufficient number, we can leave a single queen-cell, and this colony will soon be the happy possessor of a queen, and just as flourishing as if the even tenor of its ways had not been disturbed. If it is preferred, the bees of this colony may be used in forming the nuclei, in which case there is no danger of getting a queen in any nucleus thus formed or of having the queen-cells destroyed. We can thus start seven or eight nuclei very quickly.

QUEEN LAMP NURSERY.

This is a tin hive, with two walls enclosing a water tight space an inch wide, which, when in use, is filled with water through a hole at the top. Each nursery may hold from six to eight frames. Some prefer to have special frames for this nursery, each of which contains several close chambers. The queen cells are cut out and put in these chambers. It is claimed that with no food the queens will not attack each other, and so several cells may be put in each chamber.

By use of a common kerosene lamp placed under this nursery, the temperature must be kept from 80° F. to 100° F. By placing the frames with capped queen-cells in this, the queens hatch as well as if in a hive or nucleus. If as soon as hatched the young queens are introduced into a queenless colony or nucleus, as first shown by Mr. Langstroth, they are usually well received. Unless one is rearing a great many queens, this lamp nursery is not desirable, as we still have to use the nucleus to get the young queens fertilized, have to watch

carefully to get the young queens as soon as hatched, must guard it carefully as moths are apt to get in, and, finally, unless great pains are taken, this method will give us inferior queens. Mr. W. Z. Hutchinson, one of our best queen breeders, thinks very highly of the lamp nursery.

Some bee-keepers use a cage (Fig. 80) with projecting pins which are pushed into the comb, so that they hold the cage. A

FIG. 80.

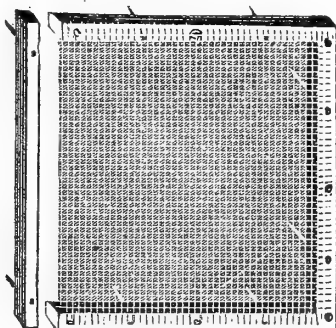

cell is put into each of these, and then they may be put into any hive. Of course the bees can not destroy the cell, as they can not get at it. Dr. Jewell Davis' queen nursery consists of a frame filled with such cages which can be hung in any hive. I have tried both and prefer this to the lamp nursery.

SHALL WE CLIP THE QUEEN'S WING?

In the above operation, as in many other manipulations of the hive, we shall often gain sight of the queen, and can, if we desire, clip her wing, *if she has met the drone; but never before*, that in no case she shall lead the colony away to parts unknown. This does not injure the queen, as some have claimed. General Adair once stated that such treatment injured the queen, as it cut off some of the air-tubes, which view was approved by so excellent a naturalist as Dr. Packard. Yet I am sure that this is all a mistake. The air-tube and blood-vessel, as we have seen, go to the wings to carry nourishment to these members. With the wing goes the necessity of nourishment and the need of the tubes. As well say that the amputation

of the human leg or arm would enfeeble the constitution, as it would cut off the supply of blood.

Many of our best apiarists have practiced this clipping of the queen's wings for years. Yet, these queens show no diminution of vigor; we should suppose they would be even more vigorous, as useless organs are always nourished at the expense of the organism, and if entirely useless, are seldom long continued by nature. The ants set us an example in this matter, as they bite the wings off their queens, after mating has transpired. They mean that the queen ant shall remain at home, *nolens volens*, and why shall not we require the same of the queen bee? Were it not for the necessity of swarming in nature, we should doubtless have been anticipated in this matter by nature herself.

Some of our first apiarists think that queens with wings clipped are not as acceptable to the other bees. I have now had experience for ten years in this practice, and have yet to see the first indication that the above is true. Still, if the queen essays to go with the swarm, and if the apiarist is not at hand, she will sometimes be lost, never regaining the hive; but in this case the bees will be saved, as *they* will return without fail. I always mean to be so watchful, keeping my hives shaded, giving ample room, and dividing or increasing, as to prevent natural swarming. Sometimes, however, with the closest vigilance swarms will issue; then we may save much labor and vexation if we have the wing of the queen clipped.

Some apiarists clip one primary wing the first year, the secondary the second year, the other primary the third, and if age of the queen permits, the remaining wing the fourth year. Yet, such data, with other matters of interest and importance, better be kept on a slate or card, and firmly attached to the hive, or else kept in a record opposite the number of the hive. The time required to find the queen is sufficient argument against the "queen-wing record." It is not an argument against the once clipping of the queen's wings, for, in the nucleus hives, queens are readily found, and even in full colonies this is not very difficult, especially if we heed the dictates of interest and keep Italians. It will be best, even though we have to look up black queens, in full colonies. The loss of one good colony, or the vexatious trouble of separating two or three swarms which had clustered together, or

the hiving of a colony perched high up on some towering tree, would soon vanquish this argument of time.

To clip the queen's wing, which we must never do until she commences to lay eggs, take hold of her wings with the right thumb and index finger—never grasp her body, *especially her abdomen*, as this will be very apt to injure her—raise her off the comb, then turn from the bees, place her gently on the left hand, and press on her feet with the left thumb sufficiently to hold her. Now with the right hand, by use of a small, delicate pair of scissors, cut off about one-half of one of the front or primary wings. This method prevents any movement of legs or wings, and is easy and quick.

Some apiarists complain that queens thus handled often receive a foreign scent, and are destroyed by the bees. I have clipped hundreds, and never lost one. I believe that the above method will not be open to this objection. Should the experience of any one prove to the contrary, the drawing on of a kid glove, or even the fingers of one, might remove the difficulty.

FERTILE WORKERS.

We have already described fertile workers. As these can only produce unimpregnated eggs, they are, of course, valueless, and unless superseded by a queen will soon cause the destruction of the colony. As their presence often prevents the acceptance of cells or a queen, by the common workers, they are a serious pest.

The absence of worker brood, and the abundant and careless deposition of eggs—some cells being skipped, while others have received several eggs—are pretty sure indications of their presence. The condition that favors these pests, is continued absence of a queen or means to produce one. They seem more common with the Cyprian and Syrian bees.

To rid a colony of these, unite it with some colony with a good queen, after which the colony may be divided if very strong. Simply exchanging places of a colony with a fertile worker, and a good strong colony, will often cause the destruction of the wrong-doer. In this case, brood should be given to the colony which had the fertile worker, that they may rear a queen; or better, a queen-cell or queen should be given them. Caging a queen in a hive, with a fertile worker, for

thirty-six hours, will almost always cause the bees to accept her. Shaking the bees off the frames two rods from the hive, will often rid them of the counterfeit queen, after which they will receive a queen-cell or a queen. But prevention is best of all. We should never have a colony or nucleus without either a queen or means to rear one. It is well to keep young brood in our nuclei at all times.

In all manipulation with the bees we need something to loosen the frames. Many use a chisel. I have found an iron scraper (Fig. 81), which I had made by a blacksmith, very

FIG. 81.



convenient. It serves to loosen the frames, draw tacks, and scrape off propolis. It would be easy to add the hammer.

QUEEN REGISTER, OR APIARY REGISTER.

With more than a half-dozen colonies it is not easy to know just the condition of each colony. Something to mark the date of each examination, and the condition of the colony at that time, is very desirable. Mr. Root furnishes the Queen Register (Fig. 82). With this it is very easy to mark the date of examination of each hive, and the condition of the colony at the time. Mr. Newman furnishes an Apiary Register which serves admirably for the same purpose. Each hive is numbered. A corresponding number in the Register gives us all desired facts. We have only to note down at the time the condition of each colony and date of examination in the Register.

Fig. 82.

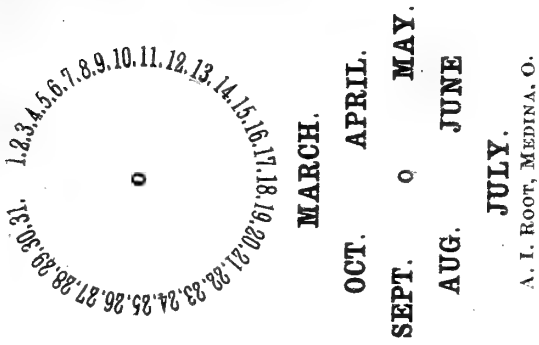

QUEEN REGISTER.
EGGS.

No. _____

MISSING. **BROOD.**

NOT APPROVED. **o** **CELL.**

APPROVED. **HATCHED.**

OCT. **APRIL.**

LAYING.

SEPT. **o** **MAY.**

AUG. **JUNE**

JULY.

A. I. ROOT, MEDINA, O.

DIRECTIONS.—Tack the card on a conspicuous part of the Hive or Nucleus; then, with a pair of pliers, force a common pin into the center of each circle, after it is bent in such a manner that the head will press securely on any figure or word. These Cards mailed free, at 6c. per doz. or 40c. per hundred.
 Use tinned or galvanized tacks; they will stand rain, &c.

CHAPTER X.

INCREASE OF COLONIES.

No subject will be of more interest to the beginner, than that of increasing stocks. He has one or two, he desires as many score, or, if very aspiring, as many hundred, and if a Jones, a Hetherington, or a Harbison, as many thousand. This is a subject, too, that may well engage the thought and study of men of no inconsiderable experience. I believe that many veterans are not practicing the best methods in obtaining an increase of stocks.

Before proceeding to name the ways, or to detail the methods, let me state and enforce that it is always safest, and generally wisest, especially for the beginner, to be content with doubling, or certainly with tripling, his number of colonies each season. Especially let all remember the motto, "Keep all colonies strong."

There are two ways to increase: The natural, known as swarming, already described under natural history of the bee; and the artificial, improperly styled artificial swarming. This is also called, and very properly too, "dividing."

SWARMING.

To prevent anxiety and constant watching, and to secure a more equable division of bees, and, as I believe, more honey, it is better to provide against swarming entirely by use of means which will appear in the sequel. But as this requires some experience, and, as often, through neglect, either necessary or culpable, swarms may issue, the apiarist should be always ready with both means and knowledge for immediate action. Of course, necessary hives were all secured the previous winter, *and will never be wanting*. Neglect to provide hives before the swarming season is convincing proof that the wrong pursuit has been chosen.

If, as I have advised, the queen has her wing clipped, the matter becomes very simple, in fact, so much simplified that were there no other argument, this would be sufficient to recommend the practice of clipping the queen's wing. Now,

if several swarms cluster together, we have not to separate them; they will separate of themselves and return to their old homes. To migrate without the queen means death, and life is sweet even to bees, and is not to be willingly given up except for home and kindred. Neither has the apiarist to climb trees, to secure his bees from bushy trunks, from off the lattice-work or pickets of his fence, from the very top of a tall, slender fragile, fruit tree, or other most inconvenient places. Nor will he even be tempted to pay his money for patent non-swarmling hivers or patent swarm catchers. He knows his bees will return to their old quarters, so he is not perturbed by the fear of loss or plans to capture the unapproachable. It requires no effort "to possess his soul in patience." If he wishes no increase, he steps out, takes the queen by the remaining wings, as she emerges from the hive, soon after the bees commence their hilarious leave taking, puts her in a cage, opens the hive, destroys, or, if he wishes to use them, cuts out the queen cells as already described, gives more room—either by adding boxes or taking out some of the frames of brood, as they may well be spared, places the cage enclosing the queen under the quilt, and leaves the bees to return at their pleasure. At night-fall the queen is liberated, and very likely the swarming fever is subdued for the season.

If it is desired to hive the absconding swarm with a nucleus colony, exchange the places of the old hive containing the caged queen, and the nucleus, to which the swarm will then come. Remove queen-cells from the old hive as before, give some of the combs of brood to the nucleus, which is now a full colony, and empty frames, filled with foundation, or if you have them empty combs, to both, liberate the queen at night and all is well, and the apiarist rejoices in a new colony. If the apiarist has neglected to form nuclei, and so has no extra queens—and *this is a neglect*—and wishes to hive his swarms separately, he places his caged queen in a hive filled with frames of foundation, with which, he replaces the old hive till the bees return; then this new hive, with queen and bees, and still better, with a frame or two of brood, honey, etc., in the middle, taken from the old hive, is set on a new stand. The old hive, with all the queen-cells except the largest and finest one removed, is set back, so that the apiarist has fore-

stalled the issue of after-swarms, except as other queen-cells are afterward started, which is not likely to happen.

If it is found too hard to move the hives, we can place a sheet over the old hive, place the caged queen on this, just in front of the entrance, which is covered by the sheet, and when the bees return and have all clustered about the queen, we have only to carry them to the new hive and turn them in front of the entrance. The old queen is liberated as before, and we are in the way of soon having two good colonies. Some apiarists cage the queen and let the bees return, and then divide the colony as soon to be described.

Some extensive apiarists, who desire to prevent increase of colonies, cage the old queen, destroy cells, and exchange this hive—after taking out three or four frames of brood to strengthen nuclei—with one that recently swarmed. Thus a colony that recently sent out a swarm, but retained their queen, has probably, from the decrease of bees, loss of brood and removal of queen-cells, lost the swarming fever, and if we give them plenty of room and ventilation, they will accept the bees from a new swarm, and spend their future energies in storing honey. If the swarming fever is not broken up, we shall only have to repeat the operation again in a few days.

Still another modification, in case no increase of bees but rather comb honey is desired, is recommended by such apiarists as Doolittle, Davis, and others. We cage the queen ten days, then destroy the queen-cells in the hive, and liberate the queen, and everything is arranged for immense yields of comb honey. In this case the queen is idle, but the bees seem to have lost not one jot of their energy. Dr. C. C. Miller, instead of caging the queen, places her with a nucleus on top of the old hive, thus keeping her at work, by exchange of frames. After ten days he destroys the queen-cells in the old hive and unites the nucleus with it. Here the queen is kept at work, the swarming impulse subdued, and a mighty colony made ready for business.

If the apiary is some distance from the house, a simple diaphragm telephone will inform the bee-keeper when swarming occurs. The roar of the telephone caused by the bees striking the wire gives the warning.

Two objections are sometimes raised right here. Suppose several swarms issue at once, one of which is a second swarm,

which of course has a virgin queen, then all will go off together, and our loss is grievous indeed. I answer that second swarms are unprofitable and should never be permitted. We should be so vigilant that this fate would never befall us. If we will not give this close attention without such stimulus, then it were well to have this threatening danger hanging over us. Again, suppose we are not right at hand when the swarm issues, the queen wanders away and possibly is lost. Yes, but if unclipped the whole colony would go, now it is only the queen. Usually the queen gets back. If not, a little looking will find her within a ball of friendly workers. At night-fall, smoke these bees, and by watching we learn the hive which swarmed, as the bees about the queen will repair at once to it.

HIVING SWARMS.

But in clipping wings, some queens may be omitted, or from taste, or other motive, some bee-keepers may not desire to "deform her royal highness." Then the apiarist must possess the means to save the would-be rovers. The means are, good hives in readiness, some kind of a brush—a turkey-wing will do—and a basket with open top, which should be at least eighteen inches in diameter, and so made that it may be attached to the end of a pole, and two poles, one very long and the other of medium length.

Now, let us attend to the method: As soon as the cluster commences to form, place the hive in position where we wish the colony to remain, leaving the entrance widely open, which with our bottom-board only requires that we draw the hive forward an inch or more over the alighting-board. As soon as the bees are fully clustered, we must manage as best we can to empty the whole cluster in front of the hive. As the bees are full of honey we need have little fear of stings. Should the bees be on a twig that could be sacrificed, this might be easily cut off with either a knife or saw (Fig. 83), and so carefully as hardly to disturb the bees; then carry and shake the bees in front of the hive, when with joyful hum they will at once proceed to enter. If the twig must not be cut, shake them all into the basket, and empty before the hive. Should they be on a tree trunk, or a fence, then brush them with the wing into the basket, and proceed as before. If they are high up

on a tree, take the pole and basket, and perhaps a ladder will also be necessary. Always let ingenuity have its perfect work, not forgetting that the object to be gained is to get just as many of the bees as is possible on the alighting-board in front

FIG. 83.



of the hive. Carelessness as to the quantity might involve the loss of the queen, which would be serious. The bees *will not* remain unless the queen enters the hive. Should a cluster form where it is impossible to brush or shake them off, they can be driven into a basket, or hive, by holding it above them and blowing smoke among them. All washes for the hive are more than

useless. It is better that it be clean and pure. With such, if they are shaded, bees will generally be satisfied. But assurance will be made doubly sure by giving them a frame of brood, in all stages of growth, from an old hive. This may be inserted before the work of hiving is commenced. Mr. Betsinger thinks this will cause them to leave; but I think he will not be sustained by the experience of other apiarists. He certainly is not by mine. I never knew but one colony to leave uncapped brood; I have often known them to swarm out of an empty hive once or twice, and to be returned, after brood had been placed in the hive; when they accepted the changed conditions, and went at once to work. This seems unreasonable, too, in view of the attachment of bees for their nest of brood, as also from analogy. How eager the ant to convey her larvæ and pupæ—the so called eggs—to a place of safety, when the nest has been invaded and danger threatens. Bees doubtless have the same desire to protect their young, and as they cannot carry them away to a new home, they remain to care for them in one that may not be quite to their taste.

When a colony swarms, the impulse seems to be general, and often a half dozen colonies will be on the wing in a trice. These will very often, generally in truth, cluster together. In this case, to find the queens is well nigh impossible, and we can only divide up the bees into suitable colonies, and as soon as we find any starting queen cells, give them a queen. Of course we may loose every queen but one. In view of this trouble, and the expense of the various swarm catchers in vogue, I would say *clip the queen's wing*.

If it is not desired to increase, the bees may be given to a colony which has previously swarmed, after removing from the latter all queen-cells, and adding to the room by putting on the sections and removing some frames of brood to strengthen nuclei. We may even return the bees to their old home by taking the same precautionary measures, with a good hope that stinging and not swarming will engage their attention in future; and if we exchange their position with that of a nucleus, we shall be still more likely to succeed in overcoming the desire to swarm; though some seasons, usually when honey is being gathered each day for long intervals, but not in large quantities, the desire and determination of some

colonies to swarm is implacable. Room, ventilation, changed position of hive, each and all will fail. Then we can do no better than to gratify the propensity by giving the swarm a new home, and make an effort

TO PREVENT SECOND SWARMS.

As already stated, the wise apiarist will always have on hand extra queens. Now, if he does not desire to form nuclei (as already explained), and thus use these queen cells, he will at once cut them *all* out, and destroy them, and give the old colony a fertile queen. The method of introduction will be given hereafter, though in such cases there is very little danger incurred by giving them a queen at once, and by thoroughly smoking the bees, sprinkling with sweetened water, and daubing the new queen with honey, we may be almost sure of success. If desired, the queen-cells can be used in forming nuclei, in manner before described. In this way we prevent our colony from being virtually queenless for at least thirteen days, and that in the very height of the honey season, when time is money. If extra queens are wanting, we have only to look carefully through the old hive and remove all but one of the queen-cells. A little care will certainly make sure work, as after swarming, the old hive is so thinned of bees that only carelessness will overlook queen-cells in such a quest.

TO PREVENT SWARMING.

As yet we can only partly avert swarming. Mr. Quinby offered a large reward for a perfect non-swarming hive, and never had to make the payment. Mr. Hazen attempted it, and partially succeeded, by granting much space to the bees, so that they should not be impelled to vacate for lack of room. The Quinby hive already described, by the large capacity of the brood-chamber, and ample opportunity for top and side-storing, looks to the same end. Mr. Muth says if we always have empty cells in the brood nest, swarming will seldom occur. Yet he says, "seldom." We may safely say that a perfect non-swarming hive or system is not yet before the bee-keeping public. The best aids toward non-swarming are shade, ventilation, and roomy hives. But as we shall see in the sequel, much room in the brood-chamber, unless we work for extracted honey—by which means we may greatly repress

the swarming fever—prevents our obtaining honey in a desirable style. If we add sections, unless the connection is quite free—in which case the queen is apt to enter them and greatly vex us—we must crowd some to send the bees into the sections. Such crowding is almost sure to lead to swarming. I have, by uncapping the combs of honey in the brood-chamber, as suggested to me by Mr. M. M. Baldrige—causing the honey to run down from the combs—sent the bees crowding to the sections, and thus deferred or prevented swarming. Those who have frames that can be turned upside down, say that the same end may be gained by simple inversion of the frames. By placing our sections in the brood-chamber till the bees commence to work on them, and then removing them above, or by carrying brood up beside the sections, the bees are generally induced to commence working in the sections. The brood in this last case should be returned as soon as the bees show a willingness to accept the sections, else the comb built in the sections will be dark, especially if the brood is in dark comb. Mr. B. Walker has his section rack so made that it can be lowered, between the brood frames, and then raised above as soon as the bees begin to work in the sections.

It is possible that by extracting freely when storing is very rapid, and then by freely feeding the extracted honey in the interims of honey secretion, we might prevent swarming, secure very rapid breeding, and still get our honey in sections. My experiments, in this direction, have not been as successful as I had hoped, and I can not recommend the practice, though some apiarists claim to have succeeded.

The keeping of colonies queenless, in order to secure honey without increase, as practiced and advised by some even of our distinguished apiarists, seems to me a *very questionable practice*. Dr. C. C. Miller's method already described, accomplishes the same object, and keeps all the queens at work all the time. I would advise keeping a queen and the workers *all* at work in *every* hive, if possible, *all the time*.

HOW TO MULTIPLY COLONIES WITH THE BEST RESULTS.

We have already seen the evils of *natural* swarming, for, even though no stock is too much reduced in numbers, no colony lost by not receiving prompt attention, no Sunday quiet disturbed, and no time wasted in anxious watching; yet,

at best, the old colony is queenless for about two weeks; a *state of things which no apiarist can or should afford*. The true policy then is to practice *artificial swarming*, as just described, where we save time by cutting the queen's wing, and save loss by permitting no colony to remain queenless, or still better to

DIVIDE.

This method will secure uniform colonies, will increase our number of colonies just to our liking, will save time, and that when time is most valuable, and is in every respect safer and more desirable than swarming. I have practiced dividing ever since I have kept bees, and *never without the best results*.

HOW TO DIVIDE.

By the process already described, we have secured a goodly number of fine queens, which will be in readiness at the needed time. Now, as soon as the white clover harvest is well commenced, early in June, we may commence operations. If we have but one colony to divide, it is well to wait till they become pretty populous, but not till they swarm. Take one of our waiting hives, which now holds a nucleus with fertile queen, and place the same close along side the colony we wish to divide. This must be done on a warm day when the bees are active, and better be done while the bees are busy, in the middle of the day. Remove the division-board of the new hive, and then remove five combs well loaded with brood, and of course containing some honey, from the old colony, bees and all, to the new hive. Also take the remaining frames and shake the bees into the new hive; *only be sure that the queen still remains in the old hive*. Fill both the hives with empty frames—if the frames are filled with empty comb it will be still better, if not, it will always pay to give full frames of foundation—and return the new hive to its former position. The old bees will return to the old colony, while the young ones will remain peaceably with the new queen. The old colony will now contain at least seven frames of brood, honey, etc., the old queen, and plenty of bees, so that they will work on as though naught had transpired, though perhaps moved to a little harder effort, by the added space and five empty combs or frames of foundation. These last may be all placed at one end, or placed between the others, though not so as to

greatly divide brood. The new colony will have eight frames of brood, comb, etc., three from the nucleus and five from the old colony, a young fertile queen, plenty of bees, those of the previous nucleus and the young bees from the old colony, and will work with a surprising vigor, often even eclipsing the old colony.

If the apiarist has several colonies, it is better to make the new colony from several old colonies, as follows: Take one frame of brood-comb from each of six old colonies, or two from each of three, and carry them, bees and all, and place with the nucleus. *Be sure that no queen is removed.* Fill all the hives with empty combs, or foundation, as before. In this way we increase without in the least disturbing any of the colonies, and may add a colony every day or two, or perhaps several, depending on the size of our apiary, and can thus almost always, so my experience says, prevent swarming.

By taking only brood that is all capped, we can safely add one or two frames to each nucleus every week, without adding any bees, as there would be no danger of loss by chilling the brood. In this way, as we remove no bees, we have to spend no time in looking for the queen, and may build up our nuclei into full stocks, and keep back the swarming impulse with great facility.

These are unquestionably the best methods to divide, and so I will not complicate the subject by detailing others. The only objection that can be urged against them, and even this does not apply to the last, is that we must seek out the queen in each hive, or at least be sure that we do not remove her, though this is by no means so tedious if we have Italians or other races of yellow bees, as of course we all will. I might give other methods which would render unnecessary this caution, but they are to my mind inferior, and not to be recommended. If we proceed as above described, the bees will seldom prepare to swarm at all, and if they do they will be discovered in the act, by such frequent examinations, and the work may be cut short by at once dividing such colonies, as first explained, and destroying their queen-cells, or, if desired, using them for forming new nuclei.

CHAPTER XI.

ITALIANS AND ITALIANIZING.

The history and description of Italians have already been considered, so it only remains to discuss the subject in a practical light.

The superiority of the Italians seems no longer a mooted question. I now know of no one among the able apiarists in our country who takes the ground that a thorough balancing of qualities will make as favorable a showing for the German as for the Italian bees, though I think that the late Baron of Berlepsch held to this view.

I think I am capable of acting as judge on this subject. I have never sold a dozen queens in my life, and so have not been unconsciously influenced by self-interest. In fact, I have never had, if I except two years, any direct interest in bees at all, and all my work and experiments had only the promotion and spread of truth as the ultimatum. Again, I have kept both blacks and Italians side by side and carefully observed and noted results during eight years of my experience. I have carefully collected data as to increase of brood, rapidity of storing, early and late habits in the day and season, kinds of flowers visited, amiability, etc., and I believe that to say that they are not superior to black bees, is like saying that a Duchess among short-horns is in no wise superior to the lean, bony kine of Texas; or that our Essex and Berkshire swine are no whit better than the cadaverous, lank breeds, with infinite noses, that, happily, are now so rare among us. The Italians are *far* superior to the German bees in many respects, and though I am acquainted with all the works on apiculture printed in our language, and have an extensive acquaintance with the leading apiarists of our country from Maine to California, yet I know not a man that has had opportunity to form a correct judgment, that does not give strong preference to the Italians. The black bees are in some respects superior to the Italians, and if a bee-keeper's methods cause him to give these points undue importance, in

forming his judgments, then his conclusions may be wrong. Faulty management, too, may lead to wrong conclusions.

The Italians certainly possess the following points of superiority:

First. They possess longer tongues, and so can gather from flowers which are useless to the black bee. This point has already been sufficiently considered. How much value hangs upon this structural peculiarity I am unable to state. I have frequently seen Italians working on red clover. I never saw a black bee thus employed. It is easy to see that this might be, at certain times and certain seasons, a very material aid. How much of the superior storing qualities of the Italians is due to this lengthened ligula, I am unable to say. Mr. J. H. Martin has a very ingenious tongue measurer by which the length of the tongues of bees in the several hives can be quickly and accurately compared. I have made a very simple and convenient instrument to accomplish the same end; two rectangular pieces, one of glass and the other of wire gauze, are so set in a frame that the glass inclines to the gauze. At one end they touch; at the other they are separated three-fourths of an inch. Honey is spread on the glass and all set in the hive. The bees can only sip the honey through the gauze. The bees that clean the glass farthest from the end where it touches the gauze have the longest tongues. This gives only relative lengths, while Mr. Martin's register tells the absolute length.

Second. They are more active, and with the same opportunities will collect a good deal more honey. This is a matter of observation, which I have tested over and over again. Yet I will give the figures of another: Mr. Doolittle secured from two colonies, 309 lbs. and 301 lbs. respectively, of *comb honey*, during the past season. These surprising figures, the best he could give, were from his best Italian stocks. Similar testimony comes from Klein and Dzierzon over the sea, and from hosts of our own apiarists.

Third. They work earlier and later. This is not only true of the day, but of the season. On cool days in spring, I have seen the dandelions swarming with Italians, while not a black bee was to be seen. On May 7th, 1877, I walked less than half a mile, and counted sixty-eight bees gathering from dandelions, yet only two were black bees. This might

be considered an undesirable feature, as tending to spring dwindling. Yet, with proper management, to be described while considering the subject of wintering, I think this no objection, but a great advantage.

Fourth. They are far better to protect their hives against robbers. Robbers that attempt to plunder Italians of their hard-earned stores soon find that they have "dared to beard the lion in his den." This is so patent that even the advocates of black bees are ready to concede it.

Fifth. They are almost proof against the ravages of the bee-moth's larvæ. This is also universally conceded. This is no very great advantage, as no respectable bee-keeper would dread moths, even with the black bees.

Sixth. The queens are decidedly more prolific. This is probably in part due to the greater and more constant activity of the workers. This is observable at all seasons, but more especially when building up in the spring. No one who will take the pains to note the increase of brood will long remain in doubt on this point.

Seventh. They are less apt to breed in winter, when it is desirable to have the bees very quiet.

Eighth. The queen is more readily found, which is a great advantage. In the various manipulations of the apiary, it is frequently desirable to find the queen. In full colonies I would rather find three Italian queens than one black one. Where time is money, this becomes a matter of much importance.

Ninth. The bees are more disposed to adhere to the comb while being handled, which some might regard a doubtful compliment though I consider it a desirable quality.

Tenth. They are, in my judgment, less liable to rob other bees. They will find honey when the blacks gather none, and the time for robbing is when there is no gathering. This may explain the above peculiarity.

Eleventh. In my estimation, a sufficient ground for preference, did it stand alone, is that the Italian bees are *far more amiable*. Years ago I got rid of my black bees, because they were so cross. A few years later, I got two or three colonies, that my students might see the difference, but to my regret; for, as we removed the honey in the autumn, they seemed perfectly furious, like demons, seeking whom they might de-

vour, and this, too, despite the smoker, while the far more numerous Italians were safely handled, even without smoke. The experiment at least satisfied a large class of students as to superiority. Mr. Quinby speaks in his book of their being cross, and Captain Hetherington tells me that if not much handled they are more cross than the blacks. From my own experience, I cannot understand this. Hybrids are even more cross than are the pure black bees, but otherwise are nearly as desirable as the pure Italians.

I have kept these two races side by side for years; I have studied them most carefully, and I feel sure that none of the above eleven points of excellence are too strongly stated.

The black bees will go into close boxes more readily than Italians, but if we use the sections for comb honey and on other grounds we can not afford to do otherwise, we shall find, with the more ample connection between the brood-chamber and sections, that even here, as Mr. Doolittle and many others have shown, the Italians still give the best returns.

There is no question but that the German bees produce nicer, whiter comb honey than do the Italians. This superiority is due to thicker cappings. This, however, is too nice a point to count very greatly in their favor. The comb honey produced by Italians does not have to go begging in the markets.

I have some reason to think that the blacks are more hardy, and have found many apiarists who agree with me. Yet, others of wide experience think that there is no difference, while still others think that the Italians are more hardy.

The Italian bees are said to dwindle worse in spring, which, as they are more active, is quite probable. As I have never had a case of serious spring dwindling, I cannot speak from experience. If the bee-keeper prevents early spring flying, which is very detrimental to either black or Italian bees, this point will have no weight, even if well taken.

The advantages of the Italians, which have been considered thus fully, are more than sufficient to warrant the exclusion of the German bees from the apiary. Truly, no one needs to be urged to a course that adds to the ease, profit, and agreeableness of his vocation.

THE NEW RACES OF BEES.

All of the valuable characteristics of the Italian bees are exaggerated in the Syrian bees, except that of amiability. This feature, irritability, would not be an objection to an experienced bee-keeper. I believe, after two years' experience with the Syrians, that they will soon be as pleasant to manage and handle as are the Italians. They are not subdued with smoke, and require careful handling. They are astonishingly prolific, and keep up the brood rearing whether there are nectar-secreting flowers or not. For queen rearing they are super-excellent. The comb honey of these bees is said to be quite inferior, because of thin caps; a point I have failed to observe. The Cyprian bees are in no way superior to the Syrians, so far as I can learn, though I have had no experience with them, and they are considerably more irritable.

WHAT BEES SHALL WE KEEP?

The beginner certainly better keep Italians. If the Syrians maintain their apparent superiority, I would certainly advise the experienced bee-keeper to give them a trial.

HOW TO ITALIANIZE.

From what has been already explained regarding the natural history of bees, it will be seen that all we have to do to change our bees is to change our queens. Hence, to Italianize a colony, we have only to procure and introduce an Italian queen. The same of course is true of Cyprianizing or Syrianizing. If we change the queen we soon change the bees.

HOW TO INTRODUCE A QUEEN.

In dividing colonies, where we give our queen to a colony composed wholly of young bees, it is safe and easy to introduce a queen in the manner explained in the section on artificial swarming. To introduce a queen to a colony composed of old bees requires more care. First, we should seek out the old queen and destroy her, then cage our Italian queen in a wire cage (Fig. 84), which may be made by winding a strip of wire-cloth, three and one-half inches wide, and containing fifteen to twenty meshes to the inch, about the finger. Let it lap each way one-half inch, then cut it off. Ravel out the

half inch on each side, and weave in the ends of the wires, forming a tube the size of the finger. We now have only to put the queen in the tube and pinch the ends together, and the queen is caged. The cage containing the queen should be

FIG. 84.

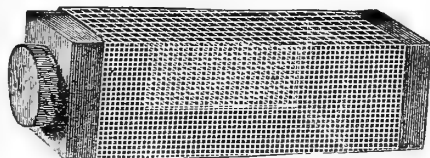

Queen Cage.

inserted between two adjacent combs containing honey, each of which will touch it. The queen can thus sip honey as she needs it. If we fear the queen may not be able to sip the honey through the meshes of the wire, we may dip a piece of clean sponge in honey and insert it in the upper end of the cage before we compress this end. This will furnish the queen with the needed food. In forty-eight hours we again open the hive, after a thorough smoking, and also the cage, which is easily done by pressing the upper end at right angles to the direction of the pressure when we closed it. In doing this do not remove the cage. Now keep watch, and if, as the bees enter the cage or as the queen emerges, the bees attack her, secure her immediately and re-cage her for another forty-eight hours. I have introduced many queens in this manner, and have very rarely been unsuccessful. At such times if the queen is not well received by the bees, then she is "balled," as it is termed. By the expression "balling the queen," we mean that the worker bees press about her in a compact cluster, so as to form a real live ball as large as a good sized peach. Here the queen is held till she dies. By smoking the ball or throwing it into water the queen may be speedily liberated. Mr. Dadant stops the cage with a plug of wood (Fig. 84), and when he goes to liberate the queen replaces the wooden stopple with one of comb, and leaves the bees to liberate the queen by eating out the comb. Mr. Betsinger uses a larger cage, open at one end, which is pressed against the comb till the mouth of the cage reaches the middle of it. If I understand him, the queen is thus held by cage and comb till the bees liberate her.

If, upon liberating the queen, we find that the bees "ball" her, that is, gather so closely about her as to form a compact cluster, we must at once smoke the bees off and re-cage the queen, else they will hold her a prisoner till she is dead.

The Peet cage (Fig. 85), which is not only an introducing but a shipping cage, is a most valuable invention. The back

FIG. 85.

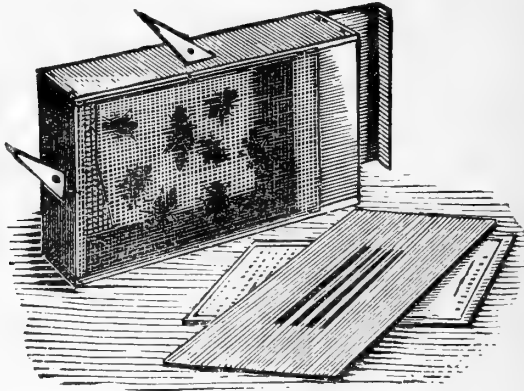
*Queen Cage.*

of the cage is tin, and as seen in the figure may be drawn out, which leaves the back of the cage entirely open. The tin points, which turn easily, are turned at right angles to the cage as shown in the figure. The cage is pressed close up to a smooth piece of comb containing both brood and honey, where it is held by the tin points, and then the tin back is withdrawn. The bees will soon liberate the queen and almost always accept her. I have had such admirable success with this cage that I heartily recommend it. The food in the cage will keep the queen, even though the bees do not feed her through the wire, and there is no honey in the comb.

Judge Andrews, of Texas, states a valuable point in this connection, which, though I have not tried, I am glad to give. The reputation of Judge Andrews and the value of the suggestion alike warrant it. He says queens will be accepted just as quickly when caged in a hive with a colony of bees, even though the old queen is still at large in the hive. Such caged queens, says the Judge, after two or three days, are

just as satisfactory to the worker bees as though "to the man-or born," and even more safe when liberated—of course the old queen is first removed—as the bees start no queen cells, if the old queen has remained in the hive until this time, and the presence of queen cells agitates the newly liberated queen, which is pretty sure to cause her destruction. Here then we may cage and keep our queens after they have been fertilized in the nuclei, and at any time can take one of these, or the old queen, at pleasure, to use elsewhere, though if the latter, we must liberate one of the caged queens, which, says the Judge, "will always be welcomed by the bees."

When bees are not storing, especially if robbers are abundant, it is more difficult to succeed, and at such times the utmost caution will occasionally fail of success if the bees are not all young. Sometimes a queen may be safely introduced into a queenless colony by simply shaking the bees all down in front of the hive, and as they pass in, letting the queen run in with them. If the queen to be introduced is in a nucleus, we can almost always introduce her safely by taking the frame containing the queen, bees and all, and setting it in the middle of the hive containing the queenless colony.

A young queen, just emerging from a cell, can almost always be safely given at once to the colony, after destroying the old queen.

A queen cell is usually received with favor. If we use a cell we must be careful to destroy all other queen-cells that may be formed; and if the one we supply is destroyed, wait twenty-four hours and introduce another. If we wait seven or eight days, and then destroy all their queen-cells, the bees are sure to accept a cell. But to save time I should always introduce a queen.

If we are to introduce an imported queen, or one of very great value, we might make a new colony, all of young bees. We simply place two or three combs of rapidly hatching brood in a hive, and the queen on them. By night-fall there will be a goodly cluster of young bees. Unless the day and night are warm the hive must be set in a warm room. The entrance should be closed in any case. This keeps the queen from leaving and robber bees from doing harm. As the number of bees warrant it, more brood may be added, and by adding capped brood alone we may very soon have a full sized colony.

By having a colony thus Italianized in the fall, we may commence the next spring, and, as described in the section explaining the formation of artificial swarms, we may control our rearing of drones, queens, and all, and ere another autumn have only the beautiful, pure, amiable, and active Italians. I have done this several times, and with the most perfect satisfaction. I think by making this change in blood, we add certainly two dollars to the value of each colony, and I know of no other way to make money so easily and pleasantly.

VALENTINE'S COMB STAND.

In the work of finding queens, and in other manipulations, it is often desirable to take out frames. If these are set down beside the hive they are liable to injury. J. M. Valentine has given us a valuable "comb stand" (Fig. 86). As will

FIG. 86.

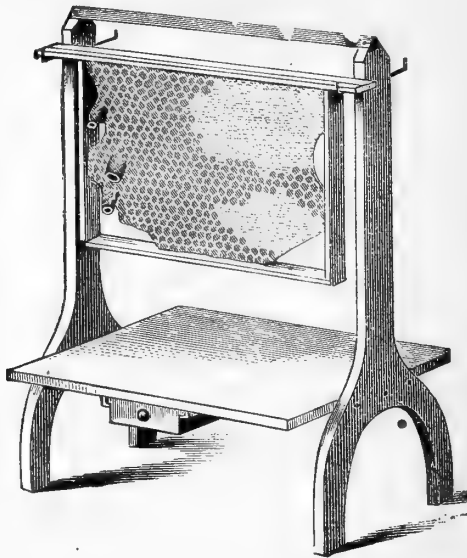

Valentine's Comb Stand.

be seen this holds two frames. The platform is handy to receive tools, and the drawer serves well to hold scissors, knife, queen cages, etc.

Mr. M. G. Young has invented an "Easel" (Fig. 87) for

the same purpose. This will hold several combs. Of course it will not do to leave combs thus exposed, except when the

FIG. 87.

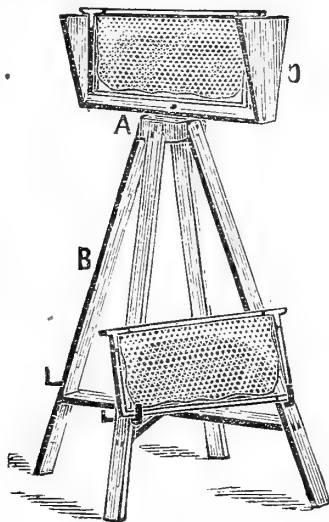
*Young's Easel.*

bees are busy in the field; or we will have great trouble with robber bees.

TO GET OUR ITALIAN QUEENS.

At present the novice, and probably the honey producer who prefers to purchase rather than rear his queens, better send to some reliable, experienced breeder, and procure "dollar queens." Unless these are impurely mated, which will rarely happen with first-class breeders, they are just as good as "tested queens." Testing only refers to the matter of pure mating.

I have felt, and I still feel, that this cheap queen traffic tends to haste, not care, in breeding, and that with "dollar queens" ruling in the market, there is lack of inducement for that careful, painstaking labor that is absolutely requisite to give us the best race of bees. It is justly claimed, however, in favor of the "Dollar Queen" business, that it has hastened the spread of Italian bees, gives those who rather buy than rear

their queens a cheap market in which to purchase, and, best of all, weeds out of the business all but the most skillful, cautious, and honest breeders. Only skillful men can make it pay. Only cautious, honest men can find a market for their stock. We know that men are making a handsome profit in the business and at the same time are giving excellent satisfaction. This is the best argument in favor of any business. I repeat, then, that the beginner better purchase "dollar queens" of some reliable breeder—one who has made queen rearing a success for years, and given general satisfaction.

I have feared that this "cheap queen" traffic would crush the hard effort, requiring study, time, money, and the most cautious experiment and observation, necessary to give us a very superior race of bees. There is reason to hope now that it will, at most, only delay it. Enterprising apiarists see in this the greatest promise for improved apiculture, and already are moving forward. Enterprising bee-keepers will purchase and pay well for the bee of the future that gives sure evidence of superior excellence. One thing is certain, "dollar queens" are in the market, and are in demand; so, whether the business tends to our good or evil, as rational men we must accept the situation and make the most of things as they exist.

Let me urge, however, upon the progressive apiarist, that there is no possible doubt but that the bees of the future will be immensely superior to those of to-day. Man can and will advance here as he has in breeding all other stock. If the obstacles in the way are greater because of the peculiar natural history of the bee, then the triumph, when it comes, will be greater, and the success more praiseworthy.

TO SHIP QUEENS.

For shipping queens the character of the shipping cage and of the food are of first importance. Nothing serves better for a cage than Peet's cage (Fig. 85), already mentioned. As will be seen the bees are covered with a double screen—one of wire, the other (removed in the figure) of wood. These are separated one-fourth of an inch. The food should never be honey. This may daub the queen and cause her death. If the food consists of hard candy, then the cage must contain a bottle of water, the cork of which has a small opening, through which is passed a small cotton string.

These bottles are not satisfactory, and so our queen breeders have discovered a moist candy which makes them unnecessary.

VIALLON CANDY.

This candy, suggested by Paul L. Viallon, keeps moist for a week or more. To make it, we take twelve ounces of powdered white sugar, four ounces of brown sugar, one tablespoonful of flour, and two of honey. Stir these well, adding enough water to make a stiff batter, then boil for a moment, and longer if we added too much water, after which we stir till it begins to thicken, when we turn it into the cage. The cage (Fig. 88) should be long enough to receive two half-inch au-

FIG. 88.

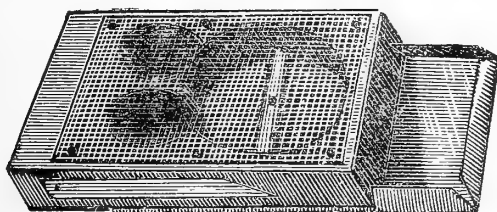

Peet Cage.

ger holes in the wood and at the end, which should be cut half way through the block, so near the chamber as to cut away an opening large enough for the bees to get at the food. The candy should be turned into these holes. The wire gauze should cover these holes, as well as the chamber for the bees.

THE GOOD CANDY.

This consists of granulated sugar moistened with extracted honey. We are indebted to Mr. I. R. Good for this cheap and excellent food. The only caution required is to get it just moist enough to keep it soft and not so moist that it will drip at all. The end of the cage (Fig. 88) to contain this should extend one and one-half inches beyond the chamber made for the bees. Through this end, lengthwise not crosswise, bore one or two three-eighth inch holes. Fill these with the candy, and insert a wooden cork into the holes at the end of the cage. The fault with this candy is that it crumbles, as the honey is sipped from it, or evaporates. With the

holes as suggested above, we find this is obviated. With this candy I have had queens on the road two weeks without the loss of a single bee.

PREPARATIONS TO SHIP.

The tin on the back of the cage has one corner cut off a little, so if we draw it back slightly we make a small opening. We now hold the cage in the left hand with the thumb over the hole, to keep the bees in, and with the right hand pick up the queen and eight or ten worker bees—bright ones, neither very young nor old—by grasping the wings with thumb and index finger, and put them into the cage. Close the opening by pushing in the tin slide, nail on the wooden screen (Fig. 85) and our queen is ready to mail. In this work we can make good use of the comb stand (Fig. 86).

We should send queens by mail. They go as safely as by express and it costs but a cent or two. *No one should presume, on any account, to send a queen by mail, unless the queen-cage is covered by this double screen and is provisioned as directed above, instead of with honey.* If shippers neglect these precautions, so that the mails become daubed, or the mail agents stung, we shall again lose the privilege of sending queens by mail. An order excluding bees from the mails will in the future be beyond recall, hence any carelessness that endangers this privilege will be virtually criminal.

TO MOVE COLONIES.

Should we desire to purchase Italians or other colonies, the only requisites to safe transport are: A wire-cloth cover for ventilation, secure fastening of the frames so they cannot possibly move, and combs so old that they shall not break down and fall out. If the colony is very large, and the weather very warm, there should be an opening in the bottom of the hive covered with gauze, or the bees may smother. The entrance ought to be covered with gauze. If combs are built from wired foundation they will not break down even if new. Bees thus shut up should never be left where the sun can shine on them. In the cars the frames should extend lengthwise of the cars. I would never advise moving bees in winter, though it has often been done with entire safety. I should wish the bees to have a flight very soon after such disturbance.

CHAPTER XII.

EXTRACTING, AND THE EXTRACTOR.

The brood-chamber is often so filled with honey that the queen has no room to lay her eggs, especially if there is any neglect to give other room for storing. Honey in brood-combs is unsalable, because the combs are dark, and the size undesirable. Comb is very valuable, and should never be taken from the bees, except when desired to render the honey more marketable. Hence, the apiarist finds a very efficient auxiliary in the

HONEY EXTRACTOR.

No doubt some have expected and claimed too much for this machine. It is equally true that some have blundered quite as seriously in an opposite direction. For, since Mr. Langstroth gave the movable frame to the world, the apiarist has not been so deeply indebted to any inventor as to him who gave us the Mel Extractor, Herr von Hruschka, of Germany. Even if there was no sale for extracted honey—aye, more, even if it must be thrown away, which will never be necessary, as it may always be fed to the bees with profit, even then I would pronounce the extractor an invaluable aid to every bee-keeper.

The principle which makes this machine effective is that of centrifugal force, and it was suggested to Major von Hruschka by noticing that a piece of comb which was twirled by his boy at the end of a string, was emptied of its honey. Herr von Hruschka's machine was essentially like those now so common, though in lightness and convenience there has been a marked improvement. His machine consisted of a wooden tub, with a vertical axle in the centre, which revolved in a socket fastened to the bottom of the vessel, while from the top of the tub fastenings extended to the axle, which projected for a distance above. The axle was thus held exactly in the center of the tub. Attached to the axle was a frame or rack to hold the comb, whose outer face rested against a wire-cloth. The axle with its attached frame, which latter held the uncapped comb, was made to revolve by rapidly unwinding a string

which had been previously wound about the top of the axle, after the manner of top-spinning. Replace the wooden tub with one of tin, and the string with gearing, and it will be seen that we have essentially the neat extractor of to-day. The machine is of foreign invention, is not covered by a patent, and so may be made by any one who desires to do so.

FIG. 89.

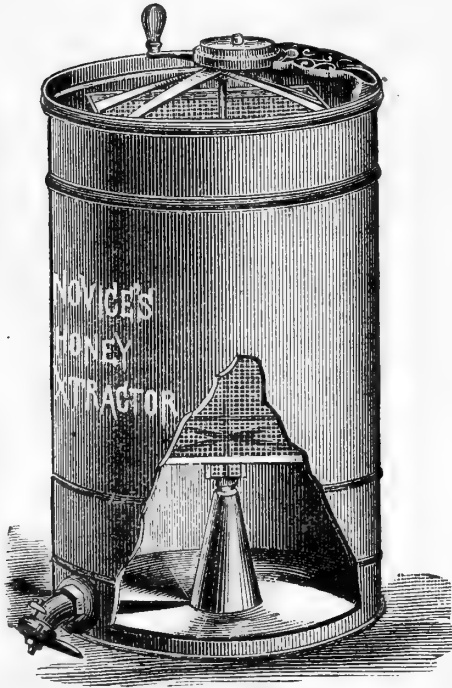

FIG. 90.



FIG. 91.



The first American honey extractor was that made by Mr. Peabody. This was without gearing, and served admirably in its day, but has since been greatly improved, till now we have several machines, each with its special excellencies, and all effecting the desired results with more or less ease and rapidity.

DESIRABLE POINTS IN AN EXTRACTOR.

The machine (Fig. 89) should be as light as is consistent with strength. It is desirable that the can be made of tin, as

it will be neater and more easily kept sweet and clean. The can should be stationary, so that only a light frame (Fig. 90) shall revolve with the comb. In some of the extractors (Fig. 90) the walls of this frame incline. This keeps the frames from falling in when the machine is at rest, but varies the centrifugal force at the top and bottom of the comb, which is urged as an objection. Of course this difference in force is very slight.

It is desirable that the machine should run with gearing, not only for ease, but also to insure or allow an even motion, so that we need not throw even drone larvæ from the brood-cells, while in the act of extracting. In some machines the crank runs in a horizontal plane (Fig. 89), in others in a vertical plane (Fig. 91). Both styles have their friends. I think there is little choice between them. The arrangement for exit of the honey should permit a speedy and perfect shut-off. A molasses gate is excellent to serve for a faucet. I also prefer that the can should hold 30 or 40 pounds of honey before it would be necessary to let the honey flow from it.

In case of small frames, like the ones I have described as most desirable to my mind, I should prefer that the comb basket might hold four frames. The comb basket should be placed so low in the can that no honey will be thrown over the top to daub the person using the extractor. I think that

FIG. 92.

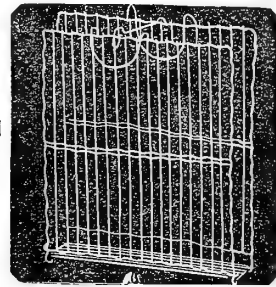
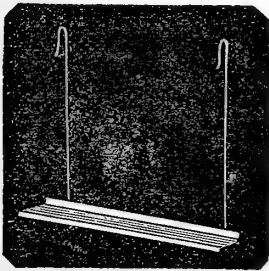

a wire attachment with a tin bottom (Fig. 92, a, b) and made to hook on to the comb basket, which will hold pieces of comb not in frames, is a desirable addition to an extractor.

The can, if metal, which is lighter and to be preferred to wood, as it does not sour nor absorb the honey, should be of tin, so

as not to rust. A cover (Fig. 91) to protect the honey from dust, when not in use, is very desirable. The cloth cover, gathered around the edge by a rubber, as made by Mr. A. I. Root, is excellent for this purpose. As no capped honey can be extracted, it is necessary to uncap it, which is done by shaving off the thin caps. To do this, nothing is better than

FIG. 93.



the Bingham & Hetherington honey knife (Fig. 93). After a thorough trial of this knife, here at the College, we pronounce it decidedly superior to any other that we have used, though we have several of the principal knives made in the United States. This knife is peculiar for its thick blade which

FIG. 94.



is beveled to the edge. It is, perhaps, sometimes desirable to have a curved point (Fig. 94), though this is not at all essential.

USE OF THE EXTRACTOR.

Although some of our most experienced apiarists say nay, it is nevertheless a fact, that the queen often remains idle, or extrudes her eggs only to be lost, simply because there are no empty cells. The honey yield is so great that the workers occupy every available space, and sometimes even they become unwilling idlers, simply because of necessity. Seldom a year has passed but that I have noticed some of my most prolific queens thus checked in duty. It is probable that just the proper arrangement and best management of frames for surplus would make such occasions rare; yet, I have seen the brood-chamber in two-story hives, with common frames above—the very best arrangement to promote storing above the brood-chamber—so crowded as to force the queen either to idleness or to egg-laying in the upper frames. This fact, as

also the redundant brood, and excessive storing that follows upon extracting from the brood-chamber, makes me emphatic upon this point, notwithstanding the fact that some men of wide experience and great intelligence think me wrong.

The extractor also enables the apiarist to secure honey—extracted honey—in poor seasons, when he could get very little, if any, in sections or boxes. By use of the extractor we can avoid swarming, and thus work for honey instead of increase of colonies.

By use of the extractor, at any time or season, the apiarist can secure nearly if not quite double the amount of honey that he could get in combs. It requires much more skill to succeed in procuring comb honey than is required to secure extracted. The beginner will usually succeed far better if he work for extracted honey.

The extractor enables us to remove uncapped honey in the fall, which, if left in the hive, may cause disease and death.

By use of the extractor, too, we can throw the honey from our surplus brood-combs in the fall, and thus have a salable article, and have the empty combs, which are invaluable for use the next spring.

If the revolving racks of the extractor have a wire basket attachment (Fig. 92) as I have suggested, the uncapped sections can be emptied in the fall, if desired, and pieces of drone-comb cut from the brood-chamber, which are so admirable for starters in the sections, can be emptied of their honey at any season.

By use of the extractor, we can furnish, at one-half the price we ask for comb-honey, an article which is equal, if not superior, to the best comb-honey, and which, were it not for appearance alone, would soon drive the latter from the market.

Indeed, extracted honey is gaining so rapidly in public favor that even now its production is far in excess of that of comb-honey.

WHEN TO USE THE EXTRACTOR.

If extracted honey can be sold for fifteen cents, or even for ten or twelve, the extractor may be used profitably the summer through; otherwise use it sufficiently often that there may always be empty worker-cells in the brood-chamber.

It is often required with us during the three great honey

harvests—the white clover, basswood, and that of fall flowers. I have always extracted the honey so frequently as to avoid much uncapping. If the honey is thin, I would keep it in a dry warm room, or apply a mild heat, that it might thicken, and escape danger from fermentation.

Many have sustained loss by extracting prematurely, so perhaps the beginner better not extract till after the bees have commenced to seal the honey. The labor of uncapping, with the excellent honey knives now at our command, is so light that we can afford to run no risk that the honey produced at our apiaries shall sour and become worthless.

If the honey granulates, it can be reduced to the fluid state with no injury, by heating, though the temperature should never rise above 200° F. This can best be done by placing the vessel containing the honey in another containing water, though if the second vessel be set on a stove, a tin basin or pieces of wood should prevent the honey vessel from touching the bottom, else the honey will burn. As before stated, the best honey is always sure to crystallize, but it may be prevented by keeping it in a temperature which is constantly above 80° F. If canned honey is set on top of a furnace in which a fire is kept burning, it will remain liquid indefinitely.

The fact that honey granulates is the best test of its purity. To be sure, some honey does not crystallize, but it is so rare that we may pretty safely decide that granulated honey is unadulterated.

To render the honey free from small pieces of comb, or other impurities, it should either be passed through a cloth or wire sieve—I purposely refrain from the use of the word strainer, as we should neither use the word strained, nor allow it to be used, in connection with extracted honey—or else draw it off into a barrel, with a faucet or molasses gate near the lower end, and after all particles of solid matter have risen to the top, draw off the clear honey from the bottom. In case of very thick honey, this method is not so satisfactory as the first. I hardly need say that honey, when heated, is thinner, and will of course pass more readily through common toweling or fine wire cloth.

Never allow the queen to be forced to idleness for want of empty cells. Extract all uncapped honey in the fall, and the honey from all the brood-combs not needed for winter. The

honey should also be thrown from pieces of drone-comb which are cut from the brood-frames, and from the uncapped comb in sections at the close of the season.

HOW TO EXTRACT.

The apiarist should possess one or two light comb boxes or baskets (Fig. 95), of sufficient size to hold all the frames from a single hive. These should have convenient handles, and a close-fitting cover, which will slide either way. Now, go to

FIG. 95.

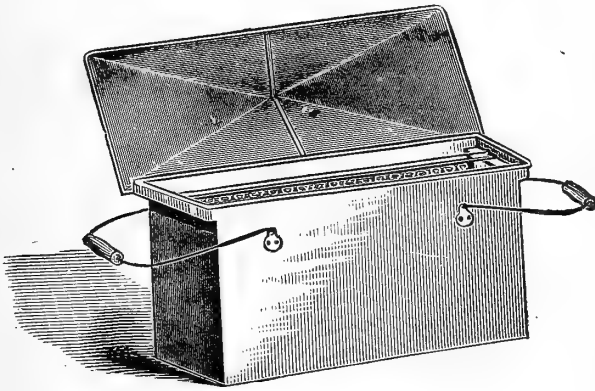

Comb Box.

two or three colonies, and take enough combs, and of the right kind, for a colony. The bees may be shaken off or brushed off with a large feather, pine twig, or other brush. If the bees are troublesome, close the box as soon as each comb is placed inside. Extract the honey from these, using care not to turn so hard as to throw out the brood. If necessary, with a thin knife pare off the caps, and after throwing the honey from one side, turn the comb around, and extract it from the other. If the combs are of very different weights, it will be better for the extractor to use those of nearly equal weights on opposite sides, as the strain will be much less. Now take these combs to another colony, whose combs shall be replaced by them. Then close the hive, extract this second set of combs, and thus proceed till all the honey has been extracted. At the close,

the one or two colonies from which the first combs were taken shall receive pay from the last set extracted, and thus, with much saving of time, little disturbance of bees, and the least invitation to robbing, in case there is no gathering, we have gone rapidly through the apiary.

Some apiarists take the first set of combs from a single colony and leave that colony without combs till they are through for the day.

In case the bees are not gathering, we shall escape robbing and stings by use of the tent (Fig. 96). This covers the hive

FIG. 96.

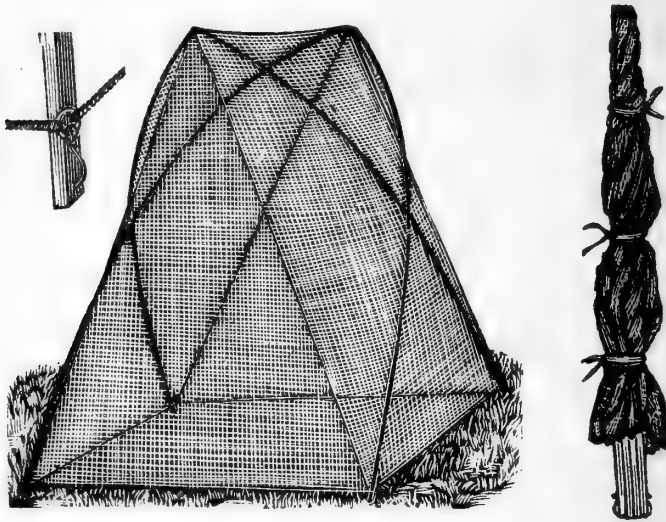
*Bee Tent.*

and operator. The one figured is very ingenious in its construction, is light and cheap. Mr. Root sells it all made for use for one dollar.

TO KEEP EXTRACTED HONEY.

Extracted honey, if to be sold in cans or bottles, may be run into them from the extractor. The honey should be thick, and the vessels may be sealed or corked, and boxed at once.

If large quantities of honey are extracted, it may be most conveniently kept in barrels. These should be first-class, and

ought to be waxed before using them, to make assurance doubly sure against any leakage. To wax the barrels, we may use beeswax, but paraffine is cheaper, and just as efficient. Three or four quarts of the hot paraffine or wax should be turned into the barrel, the bung driven in tight, the barrel twirled in every position, after which the bung is loosened by a blow with the hammer, and the residue of the wax turned out. Economy requires that the barrels be warm when waxed, so that only a thin coat will be appropriated.

Large tin cans, waxed and soldered at the openings after being filled, are cheap, and may be the most desirable receptacles for extracted honey.

Extracted honey should always be kept in dry apartments. If thin when extracted, it should be kept in open barrels or cans in a warm dry room till it has thoroughly ripened.

CHAPTER XIII.

WORKING FOR COMB-HONEY.

While extracted honey has so much to recommend it, and is rapidly growing in favor with American apiarists, still such reports as that of Dr. C. C. Miller, who the past season increased his 174 colonies to 202, and took 16,000 pounds of comb honey in one pound sections, which netted him very nearly \$3,000, and that of Mr. Doolittle, who has secured nearly 100 pounds of comb-honey per colony for a long series of years, may well lead us not to ignore this branch of our business. The showy horse, or the red short-horn, may not be intrinsically superior to the less attractive animals; but they will always win in the market. So comb-honey, in the beautiful one pound sections, will always attract buyers and secure the highest price. As more embark in the production of extracted honey, higher will be the price of the irresistible, incomparable comb-honey. Well then may we study how to secure the most of this exquisite product of the bees, in a form that shall rival in attractiveness that of the product itself, for very likely the state of the market in some localities will make its production the most profitable feature of apiculture.

POINTS TO CONSIDER.

To secure abundance of comb-honey the colonies must be very strong, and the brood combs full of brood at the dawn of the honey harvest. The swarming fever must be kept at bay or cured, before the rapid storing commences, and the honey should be secured in the most attractive form.

TO SECURE STRONG COLONIES.

By feeding daily, whenever the bees are not storing, commencing as soon as the bees commence to store pollen, we shall almost certainly secure this result. We should also use the division board, and keep the bees crowded, especially if weak in the spring. Only give them the number of combs that they can cover. Keep them warmly covered above and on

the sides. True, Mr. Heddon objects to this work of feeding and manipulating division boards, and makes much honey and money. I have often wondered what his genius and skill would accomplish should he vary his method in this respect. Instead of feeding by use of the Smith (Fig. 76) or other feeder, we may uncap a comb of honey and with it separate combs of brood as the bees get two or three full frames of the latter. This will stimulate the bees, and as they will carry the honey from the uncapped cells the queen will be impelled to most rapid laying. By turning around the brood combs, or separating them by adding combs with empty cells as the colonies gain in strength, we hasten brood rearing to the utmost.

TO AVOID THE SWARMING FEVER.

This is not always possible by any method, and has been the obstacle in the way of successful comb-honey production. The swarming impulse and great yields of this delectable product are entirely antagonistic. Mr. James Heddon, Davis, and others let the bees swarm. They hive these swarms on foundation, and hope to have this all done, and both colonies strong, in time for the honey harvest. Some of our best Michigan and New York bee-keepers, with Dr. Miller, let the bees swarm, and return them, either caging the queen or placing her in a nucleus for nine days, then return her to the bees, after cutting out the queen cells. This takes nothing from the energy of the bees, and will doubtless work best of all methods in the hands of the beginner. If increase is desired, however, then Mr. Heddon's method should be followed. The yield of comb-honey in this last case will not usually be so great, though in excellent seasons it may be greater.

Some very able bee-keepers manipulate so skillfully, by adding empty combs to the hives, as to keep this swarming impulse in check, and still keep the bees increasing most rapidly. Others divide the colonies, and so hold at bay the swarming fever. All must practice as their own experience proves best, as the same method will not have equal value with different persons. We must work as best we can to secure strong colonies, and check or retard the swarming fever, and while learning by experience to do this, may well work the most of our bees for extracted honey, which is more easily secured,

and is sure to be in demand, even though the price is less. The quantity may more than compensate for lower price.

ADJUSTMENT OF SECTIONS.

As before suggested, a wide space between bottom-bars of sections—three-eighths inch—is desirable. The sections should be on at the very dawn of each honey harvest, as white clover, bass-wood, etc. At first the full set of sections better not be added, but as soon as the bees commence to work well in them, then all should be added, on side and top, if side storing is practiced, and if we wish to tier up, the crate of sections first added should be raised and others added below. As already stated it is best not to have the sections too closely shut in. Slight ventilation is desirable.

If the queen troubles by entering the sections, use may be made of the perforated zinc (Fig. 60) to keep her from them. As already suggested, we must arrange the form and size of sections as the market and our hives and apparatus make most desirable. We may vary the size and form of our sections so as to make them smaller and yet use the same crates or frames that we used with larger sections. Small sections are most ready of sale, and safest to ship; yet with their use, we secure less honey.

If we can get nice straight combs by having them less thick without using separators in the sections, so that these latter can be readily placed side by side in shipping crates, then we, by all means, better omit the separators. If we use separators, we can use wood or tin. Wood is cheapest, and I find that in practice it serves as well as tin.

GETTING BEES INTO SECTIONS.

The crowded hive or brood-chamber, with no intent to swarm, the wide spaces between sections, and a rich harvest of nectar, will usually send the bees into the sections with a rush. If they refuse to go, a little drone brood, or the exchange of sections temporarily from above to the brood-nest, or the moving of a brood-frame up beside the sections for a short time, as before described, will frequently start the bees into the sections: Some apiarists have their crates with sections so made that they can be placed between the brood frames till the bees commence to work in the sections; others accomplish the same end by in-

verting the frames. With experience will come the skill which can accomplish this, simply by management of the bees without resort to such measures as just described.

REMOVAL OF SECTIONS.

The three-eighths inch space between the upper as well as the lower bars of the sections enables us to see quickly the condition of each section just by removal of the cover. Each section should be removed as soon as capped, if we would have it very nice. Any delay will make it dark and hurt its sale. During the harvest we should add other sections to take the place of those removed. Towards the close of the harvest we should not add other sections, for, by contracting the space, the last sections will be more surely filled and quickly capped. To remove the bees from single sections taken from frame or crate, we have only to brush them off. If we take a full crate at once, we can set it in a dark box or room, with some small opening for the bees to escape. If the hole is at one side and is covered by wire cloth, which should be separated from the box three-eighths of an inch, by placing lath between it and the box, and made to extend three inches above the opening, outside bees will fail to enter while those within will readily pass out. I have used a box with no cover, and by spreading a sheet on this the bees would collect on the sheet. I would occasionally turn the sheet over. With the old boxes, such arrangements were more necessary. Now, with smoke and brush we can often dispense with other aids.

As comb-honey is in better condition for market if it is stored for a few days where the air can circulate freely about it, it is always well to fumigate it by burning sulphur in a close room or box. It is well to do this, even though the honey is to be immediately shipped.

CHAPTER XIV. HANDLING BEES.

But some one asks the question, shall we not receive those merciless stings, or be introduced to what "Josh" calls the "business end of the bee?" Perhaps there is no more causeless or more common dread in existence than this of bees' stings. When bees are gathering, they will never sting unless provoked. When at the hives—especially if Italians—they will rarely make an attack. The common belief, too, that some persons are more liable to attack than others, is, I think, erroneous. With the best opportunity to judge, with our hundreds of students, I think I may safely say that one is almost always as liable to attack as another, except that he is more quiet, or does not greet the usually amiable passer-by with those terrific thrusts, which would vanquish even a practiced pugilist. Occasionally a person *may* have a peculiar odor about his person that angers bees and invites their darting tilts, with drawn swords, venom-tipped, yet, though I take my large classes each season, at frequent intervals, to see and handle the bees, each for himself, I still await the first proof of the fact that one person is more liable to be stung than another, providing each carries himself with that composed and dignified bearing that is so pleasing to the bees. True, some people, filled with dread, and the belief that bees regard them with special hate and malice, are so ready for the battle that they commence the strife with nervous head-shakes and beating of the air, and thus force the bees to battle, *nolentes volentes*. I believe that only such are regarded with special aversion by the bees. Hence, I believe that *no one* need be stung.

Bees should never be jarred, nor irritated by quick motions. Those with nervous temperaments—and I plead very guilty on this point—need not give up, but at first better protect their faces, and perhaps even their hands, till time and experience show them that fear is vain; then they will divest themselves of all such useless encumbrances. Bees are more cross when they are gathering no honey, and at such times, black bees and hybrids especially, are so irritable that even the experienced apiarist will wish a veil.

THE BEST BEE-VEIL.

This should be made of black tarlatan, sewed up like a bag, a half yard long, without top or bottom, and with a diameter of the rim of a common straw-hat. Gather the top with braid, so that it will just slip over the crown of the hat—else, sew it to the edge of the rim of some cheap, cool hat, in fact, I prefer this style—and gather the bottom with rubber cord or rubber tape, so that it may be drawn over the hat rim, and then over the head, as we adjust the hat.

Some prefer to dispense with the rubber cord at the bottom (Fig. 97), and have the veil long so as to be gathered in by the coat or dress. If the black tarlatan troubles by coloring

FIG. 97.



the shirt or collar, the lower part may be made of white netting. When in use, the rubber cord draws the lower part close about the neck, or the lower part tucks within the coat or vest (Fig. 97), and we are safe. This kind of a veil is cool, does not impede vision at all, and can be made by any woman at a cost of less than twenty cents. Common buck-skin or sheep-skin gloves can be used, as it will scarcely pay to get special gloves for the purpose, for the most timid person—I speak from experience—will soon consider gloves an unnecessary nuisance.

Special rubber gloves are sold by those who keep on hand apiarian supplies. It is reported that heavily starched linen

is proof against the bees' sting, and so may be used for gloves or other clothing. Some apiarists think that dark clothing is specially obnoxious to bees. It is certainly true that fuzzy woolen, and even hairs on one's hands are very irritating to bees. Clothes with a heavy nap should be rejected by the bee-keeper, and the Esaus should singe the hair from their hands.

For ladies, my friend, Mrs. Baker, recommends a dress which, by use of the rubber skirt-lift or other device, can be instantly raised or lowered. This will be convenient in the apiary, and tidy anywhere. The Gabrielle style is preferred, and of a length just to reach the floor. It should be belted at the waist, and cut down from the neck in front, one-third the length of the waist, to permit the tucking in of the veil. The under-waist should fasten close about the neck. The sleeves should be quite long to allow free use of the arms, and gathered in with a rubber cord at the wrist, which will hug the rubber gauntlets or arm, and prevent bees from crawling up the sleeves. The pantalets should be straight and full, and should also have the rubber cord in the hem to draw them close about the top of the shoes.

Mrs. Baker also places great stress on the wet "head-cap," which she believes the men even would find a great comfort. This is a simple, close-fitting cap, made of two thicknesses of coarse toweling. The head is wet with cold water, and the cap wet in the same, wrung out, and placed on the head.

Mrs. Baker would have the dress neat and clean, and so trimmed that the lady apiarist would ever be ready to greet her brother or sister apiarists. In such a dress there is no danger of stings, and with it there is that show of neatness and taste, without which no pursuit could attract the attention, or at least the patronage, of our refined women.

TO QUIET BEES.

In harvest seasons, the bees, especially if Italians, can almost always be handled without their showing resentment. But at other times, and whenever they object to necessary familiarity, we have only to cause them to fill with honey to render them harmless, unless we pinch them. This can be done by closing the hive so that the bees cannot get out, and then rapping on the hive for four or five minutes. Those within will fill with honey, those without will be tamed by surprise, and all

will be quiet. Sprinkling the bees with sweetened water will also tend to render them amiable, and will make them more ready to unite, to receive a queen, and less apt to sting. Still another method, more convenient, is to smoke the bees. A little smoke blown among the bees will scarcely ever fail to quiet them, though I have known black bees, in autumn, to be very slow to yield.

The Syrian bees are maddened rather than quieted by use of smoke. I find, however, that with handling they soon become more like Italians. Deliberation is specially desirable when we first open the hive of Syrian bees.

Dry cotton cloth, closely wound and sewed or tied, or, better, pieces of dry, rotten wood are excellent for the purpose of smoking. These are easily handled, and will burn for a long time. But best of all is a

BELLOWS-SMOKER.

This is a tin tube attached to a bellows. Cloth, corn-cobs, or rotten wood (that which has been attacked by dry rot is the

FIG. 99.



a

FIG. 98.

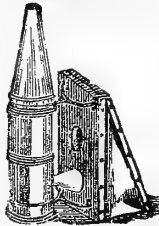

b

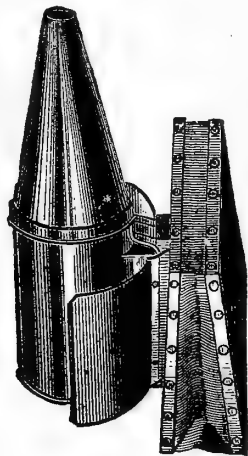

best) can be burned in the tube, and will remain burning a long time. The smoke can be directed at pleasure, the bellows easily worked, and the smoker used without any disagreeable effects or danger from fire.

THE QUINBY SMOKER.

This smoker (Fig. 98, *a*) was a gift to bee-keepers by the late Mr. Quinby, and not patented; though I supposed it was, and so stated in a former edition of this work. Though a similar device had been previously used in Europe, without doubt Mr. Quinby was not aware of the fact, and as he was the person to bring it to the notice of bee-keepers, and to make it so perfect as to challenge the attention and win the favor of apiarists *instantly*, he is certainly worthy of great praise, and deserving of hearty gratitude.

This first smoker has been improved (Fig. 98, *b*) in what is now sold as the Improved Quinby.

Mr. Bingham was the first to improve the old Quinby smoker in establishing a direct draft (Fig. 99). Mr. Clark next added the cold draft (Fig. 100).

FIG. 100.

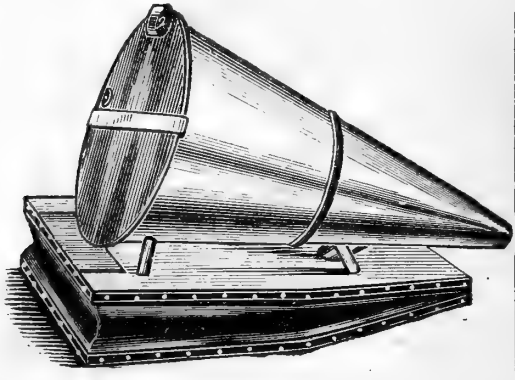

There are now several smokers on the market, each of which has its merits and its friends. No person who keeps even a single colony of bees, can afford to do without some one of them.

TO SMOKE BEES.

Approach the hive, blow a little smoke in at the entrance, then open from above, and blow in smoke as required. If, at any time, the bees seem irritable, a few puffs from the smoker will subdue them. Thus, any person may handle his bees with perfect freedom and safety. If, at any time, the

fire-chamber and escape-pipe of the smoker become filled with soot, they can easily be cleaned by revolving an iron or hardwood stick inside of them.

CHLOROFORM.

Mr. Jones finds that chloroform is very useful in quieting bees. He puts a dry sponge in the tube of the smoker, then a sponge wet in chloroform—it takes but a few drops—then puts in another dry sponge. These dry sponges prevent the escape of the chloroform, except when the bellows is worked. Mr. Jones finds that bees partially stupified with chloroform receive queens without any show of ill-will. As soon as the bees begin to fall, the queen is put into the hive, and no more of the vapor added. I tried this last summer with perfect success. This was recommended years ago in Germany, but its use seems to have been abandoned. It is more than likely that Mr. Jones' method of applying the anesthetic is what makes it more valuable. The smoker diffuses the vapor so that all bees receive it, and none get too much. I should use ether instead of chloroform, as with higher animals it is a little more mild and safe.

TO CURE STINGS.

In case a person is stung, he should step back a little for a moment, as the pungent odor of the venom is likely to anger the bees and induce further stinging. By forcing a little smoke from the smoker onto the part stung, we will obscure this odor. The sting should be rubbed off at once. I say rubbed, for we should not grasp it with the finger-nails, as that crowds more poison into the wound. If the pain is such as to prove troublesome, apply a little ammonia. The venom is an acid, and is neutralized by the alkali. A strong solution of saltpetre I have found nearly as good to relieve pain as the ammonia. Ice cold water drives the blood from any part of our body to which it is applied, and so it often gives relief to quickly immerse the part stung in very cold water. In case horses are badly stung; as sometimes happens, they should be taken as speedily as possible into a barn (a man, too, may escape angry bees by entering a building), where the bees will seldom follow, then wash the horses in soda water, and cover with blankets wet in cold water.

THE SWEAT THEORY.

It is often stated that sweaty horses and people are obnoxious to the bees, and hence almost sure targets for their barbed arrows. In warm weather I perspire most profusely, yet am scarcely ever stung, since I have learned to control my nerves. I once kept my bees in the front yard—they looked beautiful on the green lawn—within two rods of a main thoroughfare, and not infrequently let my horse, covered with sweat upon my return from a drive, crop the grass, while cooling off, right in the same yard. Of course, there was some danger, but I never knew my horse to get stung. Why, then, the theory? May not the more frequent stings be consequent upon the warm, nervous condition of the individual? The man is more ready to strike and jerk, the horse to stamp and switch. The switching of the horse's tail, like the whisker trap of a full beard, will anger even a good-natured bee. I should dread the motions more than the sweat, though it may be true that there is a peculiarity in the odor from either the sensible or insensible perspiration of some persons, that angers the bees and provokes the use of their terrible weapons.

Often when there is no honey to gather, as when we take the last honey in autumn, or prepare the bees for winter, the bees are inordinately cross. This is especially true of black bees and hybrids. At such times I have found an invaluable aid in

THE BEE TENT.

This also keeps all robbers from mischief. It is simply a tent which entirely covers the hive, bees, bee-keeper and all. The one I use (Fig. 101) is light, large, and easily moved, or folded up if we wish to put it in the house. The sides are rectangular frames made of light pine strips, well placed (Fig. 101, *b, b*), and covered with wire cloth. The top and ends are covered with factory cloth, except at one end, where it is fastened at will by rings which hook over screws. The sides have no permanent connection of wood except at the ends (Fig. 101, *c, c*). The small strips which connect at these places are double, and hinged to the side frames, and the two parts of each hinged together. Thus these may drop, and so permit the side frames to come close together when we wish to "fold our tent." The sides are kept apart by center cross-

strips at the ends (Fig. 101, *a, a*), from which braces (Fig. 101, *i, i*) extend to the double cross-strips above. These

FIG. 101.

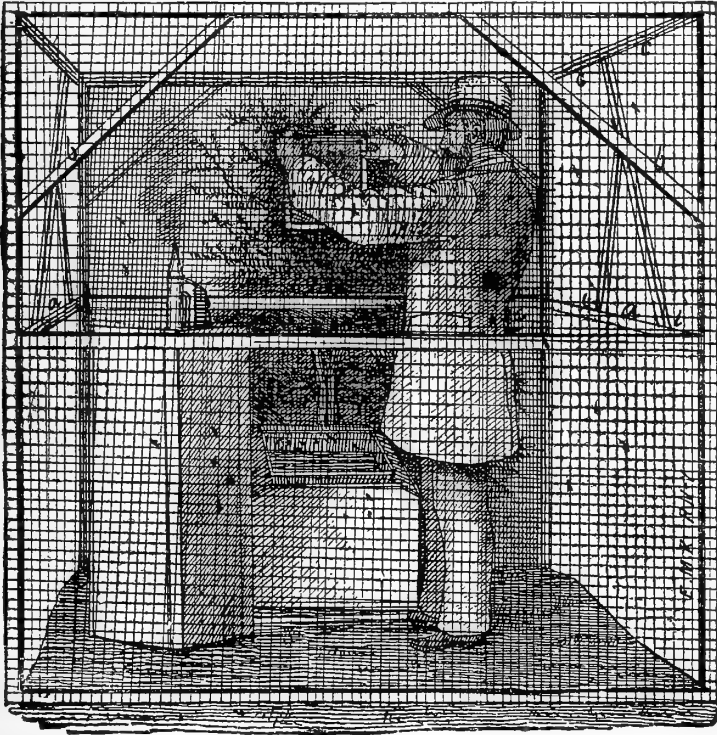
*Bee Tent.*

center strips, with their braces hinged to them, are separate from the rest of the frame except when hooked on, as we spread the tent.

After use of this tent one season, I can not praise it too highly. I have already referred to a cheap tent made by Mr. A. I. Root (Fig. 96).

CHAPTER XV.

COMB FOUNDATION.

Every apiarist of experience knows that empty combs in frames, comb-guides in the sections, to tempt the bees and to insure the proper position of the full combs, in fact, combs of almost any kind or shape, are of great importance. So every skillful apiarist is very careful to save all drone-comb that is cut out of the brood-chamber—where it is worse than useless, as it brings with it myriads of those useless gormands, the drones—to kill the eggs, remove the brood, or extract the honey, and transfer it to the sections. He is equally careful to keep all his worker-comb, so long as the cells are of proper size to domicile full-sized larvæ, and never to sell any comb, or even comb-honey, unless a much greater price makes it desirable.

No wonder, then, if comb is so desirable, that German thought and Yankee ingenuity have devised means of giving the bees at least a start in this important, yet expensive work

FIG. 102.

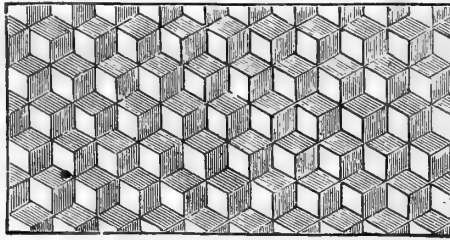

of comb-building, and hence the origin of another great aid to the apiarist—comb foundation (Fig. 102).

HISTORY.

For more than twenty-five years the Germans have used impressed sheets of wax as a foundation for comb, as it was first made by Herr Mehring, in 1857. These sheets are four or five times as thick as the partition at the center of natural comb, which is very thin, only 1-180 of an inch thick. This

is pressed between metal plates so accurately formed that the wax receives rhomboidal impressions which are a *fac simile* of the basal wall or partition between the opposite cells of natural comb. The thickness of this sheet is no objection, as it is found that the bees almost always thin it down to the natural thickness, and use the shavings to form the walls.

AMERICAN FOUNDATION.

Mr. Wagner secured a patent on foundation in 1861, but as the article was already in use in Germany, the patent was, as we understand, of no legal value, and certainly, as it did nothing to bring this desirable article into use, it had no virtual value. Mr. Wagner was also the first to suggest the idea of rollers. In Langstroth's work, edition of 1859, p. 373, occurs the following, in reference to printing or stamping combs: "Mr. Wagner suggests forming these outlines with a simple instrument somewhat like a wheel cake cutter. When a large number are to be made, a machine might easily be constructed which would stamp them with great rapidity." In 1866, the King Brothers, of New York, in accordance with the above suggestion, made the first machine with rollers, the *product* of which they tried to get patented but failed. These stamped rollers were less than two inches long. This machine was useless, and failed to bring foundation into general use.

In 1874, Mr. Frederick Weiss, a poor German, invented the machine which brought the foundation into general use. His machine had lengthened rollers—they being six inches long—and shallow grooves between the pyramidal projections, so that there was a very shallow cell raised from the basal impression as left by the German plates. This was the machine on which was made the beautiful and practical foundation sent out by "John Long," in 1874 and 1875, and which proved to the American apiarists that foundation machines, and foundation, were to be a success. I used some of this early foundation, and have been no more successful with that made by the machines of to-day. To Frederick Weiss, then, are Americans and the world indebted for this invaluable aid to the apiarist.

In 1876, Mr. A. I. Root commenced in his energetic, enthusiastic way, and soon brought the roller machine and foundation into general use. These machines, though a great aid to api-

culture, were still imperfect, and though sold at an extravagantly high price—through no fault of Mr. Root, as he informs me—were in great demand. Next, Mrs. F. Dunham greatly improved the machine by so making the rolls (Fig. 103) that

FIG. 103.

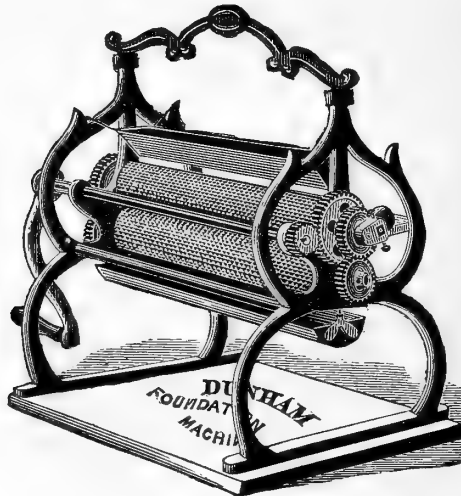

the foundation would have a very thin base and high thick walls which, in the manufacture, were not greatly pressed. These three points are very desirable in all foundation—thin base and thick, high walls, which shall not be compactly pressed.

Mrs. Dunham is not only entitled to gratitude for the superior excellence of the machines she manufactured, but by putting so excellent a machine onto the market at a lower price, all roller machines had to be sold more reasonably. Mr. Vandervort also improved the rollers, so that his machine secures the same results as does Mrs. Dunham's, while the form of the foundation is somewhat more natural, though not preferred by the bees I think. Another form of foundation—that with flat bottom—is made by the VanDeusen mill. This has a very thin base, and is very handsome. It was made to use with wires. In my experience this flat bottom foundation is not as acceptable to the bees as the other kinds. Mr. Root has kept his machine abreast with the latest improvements. Mr. Pelham has invented rolls that are made in rings or sections,

each ring the width of a cell. Such rolls, if they work well, and I see no reason why they should not, will reduce the price of machines so that all—even small apiarists—can afford to own them.

THE PRESS FOR FOUNDATION.

Mr. D. A. Given, of Illinois, has given a press (Fig. 104) that stamps the sheets by plates and not by rolls, which, at

FIG. 104.

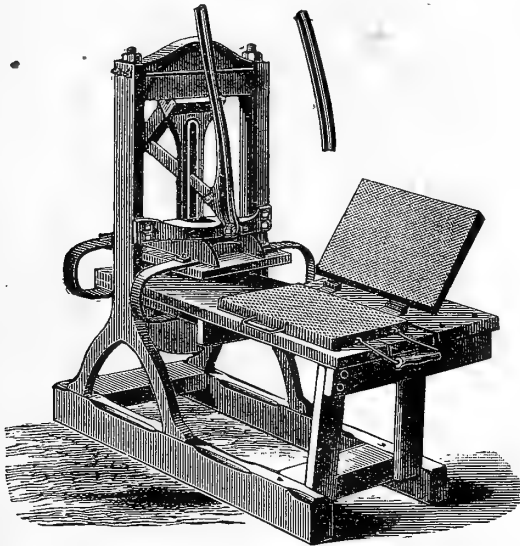

present, is giving better satisfaction than even the improved roller machines. This shuts up like a book and the wax sheets, instead of passing between carved metal rollers, are stamped by a press after being placed in position. The advantages of this press as claimed by its friends—which seem to number all who have used it—are that the foundation has the requisites already referred to, par excellence, that it is easily and rapidly worked, and that foundation can at once be pressed into the wired frames. Rubber plates have also been made but as yet have not won general favor or acceptance. All of these improved machines give us foundation of exquisite mold and with such rapidity that it can be made cheap and

practical. As Mr. Heddon says, the bees in two days, with foundation, will do more than they would in eight days without it. Every one who wishes the best success must use foundation not only in the brood chamber but in sections. Whoever has 100 colonies of bees may well own a machine for himself.

HOW FOUNDATION IS MADE.

The process of making the foundation is very simple. Thin sheets of wax, of the desired thickness, are pressed between the plates or passed between the rolls, which are made so as to stamp either drone or worker foundation as desired. Worker is best I think even for sections. The only difficulty in the way of very rapid work is that from sticking of the wax sheets to the dies. Mr. Heddon finds that by wetting the dies with concentrated lye the wax is not injured and sticking is prevented. Mr. Jones uses soap suds with excellent success for the same purpose. Think of two men running through fifty pounds of foundation in an hour! That is what I saw two men do at Mr. Jones', with a Dunham machine by use of soap suds. The man who put in the wax sheets was not delayed at all. The kind of soap should be selected with care. Mr. Root prefers common starch to either lye or soap-suds. New machines are more liable to trouble with sticking than are those that have been used for some time.

TO SECURE THE WAX SHEETS.

The wax should be melted in a double walled tin vessel, with water between the walls, so that in no case would it be burned or over heated.

To form the sheets a dipping board of the width and length of the desired sheets, is the best. It should be made of pine, and should be true and very smooth. This is first dipped into cold water, then one end is dipped quickly into the melted wax, then raised till dripping ceases—only a second—this end dipped into the cold water, grasped by means of a dextrous toss with the hands and the other end treated the same way. The thing is repeated if necessary till the sheet is thick enough. Twice dipping is enough for brood combs, once for sections. We now only have to shave the edges with a sharp knife, and we can peel off two fine sheets of wax. This is Mr. Jones' plan and is better than to dip only one end of the board, as in that case the wax runs down the board and the sheets are

thickest at one end. With the device of Mr. Jones the wax runs to the ends, and to make the middle as thick, the board is lowered in the melted wax below the centre. At Mr. Jones' I saw one man dip the sheets as fast as two men could run them through the machine. Mr. Heddon, who has used nearly all of the roller machines, thinks Given's press can be used more easily and rapidly than any of them. This seems to me hardly possible, yet we must remember that the press puts the foundation right into the wired frames. Surely Mr. Jones' accomplishment with the Dunham Mill leaves little to be desired.

For cutting foundation, nothing is so admirable as the Carlin cutter (Fig. 105, *a*), which is like the wheel glass-cutters

FIG. 105.

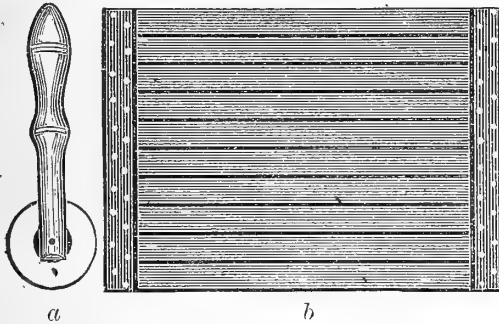
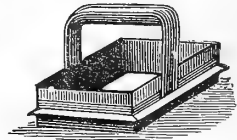

FIG. 106.



sold in the shops, except that a larger wheel of tin takes the place of the one of hardened steel. Mr. A. I. Root has suggested a grooved board (Fig. 105, *b*) to go with the above, the distance between the grooves being equal to the desired width of the strips of comb foundation to be cut.

For cutting smaller sheets for the sections the same device may be used. I saw Mr. Jones cut these as fast as a boy would cut circular wads for his shot-gun, by use of a sort of modified cake cutter (Fig. 106).

USE OF FOUNDATION.

An empty frame should never be put in the brood chamber. Even if foundation was one dollar a pound it still would pay richly to use it. It is astonishing to see how rapidly the bees will extend the cells, and how readily the queen will stock them with eggs if of the right size, five cells to the inch.

The foundation should always be the right size either for worker or drone-comb. Of course the latter size would never be used in the brood-chamber. I much doubt if it is wise to use it at all. The advantage of foundation is, first, to insure worker-comb, and thus worker-brood, and second, to furnish wax, so that the bees may be free to gather honey. We have proved in our apiary repeatedly, that by use of foundation, and a little care in pruning out the drone-comb, we could limit or even exclude drones from our hives, and we have but to examine the capacious and constantly crowded stomachs of these idlers to appreciate the advantage of such a course. Bees may occasionally tear down worker-cells, and build drone-cells in their place; but such action, I believe, is not sufficiently extensive to ever cause anxiety. I am also certain that bees that have to secrete wax to form comb, do much less gathering. Wax secretion seems voluntary, and when rapid seems to require quiet and great consumption of food. If we make two artificial colonies equally strong, supply the one with combs, and withhold them from the other, we will find that this last sends far less bees to the fields, while all the bees are more or less engaged in wax secretion. Thus the other colony gains much more rapidly in honey, first, because more bees are storing; second, because less food is consumed. This is undoubtedly the reason why extracted honey can be secured in far greater abundance than can comb-honey.

Unless the frames are wired, the foundation should only touch the top of the frame where it is securely fastened. If wired, the frames should be full.

It also pays remarkably well to use foundation in the sections. With proper care, all talk about "the fish bone" need not frighten any one. Foundation for the sections should be about seven feet to the pound, while that for the brood-chamber is better at five feet. The foundation should fill the sections. Of course, foundation for the sections—in fact all foundation—should only be made of nicest, cleanest wax. *Only pure, clean, unbleached wax should be used in making foundation.* We should be *very careful* not to put on the market any comb-honey where the foundation has not been properly thinned by the bees. Perhaps a very fine needle would enable one to determine this point without injury to the honey. With our present foundation there is little danger.

TO FASTEN THE FOUNDATION.

In the thin sections, the foundation can best be fastened by use of the melted wax. To accomplish this, I have used a block made thus: Saw a board that is one-half of an inch thinner than half the depth of the section, so that it will just exactly fit in the section. Screw this to a second board, which is one-half inch broader each way, so that the larger under board will project one-quarter of an inch each side the top board. Now set the section over the top board, place the foundation, cut a trifle shorter than the inside of the section, within, close to the top and one side of the section, and cause it to adhere by running on a little of the melted wax, which, by use of a kerosene lamp or stove, may be kept melted. If the basin is double-walled, with water in the outer chamber and wax in the inner, it is much safer, as then the wax will never burn. A warm iron run on the foundation just at the edge, will also glue it to the section.

If the tops of the sections are thick, they may be grooved, and by crowding the foundation into the groove, and, if necessary, pressing it with a thin wedge, it will be securely held.

This last method will work nicely in case of fastening into the brood-frames. But I have found that I could fasten them rapidly and very securely by simply pressing them against the rectangular projection from the top-bar already described. In this case a block (Fig. 107, *a*) should reach up into the frame from the side which is nearest to the rectangular projection—it will be remembered that the projection (Fig. 45) is a little to one side of the center of the top-bar, so that the foundation shall hang exactly in the center—so far that its upper surface would be exactly level with the upper surface of the rectangular projection. This block, like the one described above, has shoulders (Fig. 107, *c*), so that it will always reach just the proper distance into the frame. It is also rabbeted at the edge where the projection of the top-bar of the frame will rest (Fig. 107, *b*), so that the projection has a solid support, and will not split off with pressure. We now set our frame on this block, lay on our foundation, cut the size we desire, which, unless strengthened, will be as long as the frame, and nearly as wide. The foundation will rest firmly on the projection and block, and touch the top-bar at every point. We now take a board as thick as the projection is deep, and as wide

(Fig. 108, *d*) as the frame is long, which may be trimmed off, so as to have a convenient handle (Fig. 108, *e*), and by wetting the edge of this (Fig. 108, *d*) either in water, or, better, starch-water, and pressing with it on the foundation

FIG. 107.

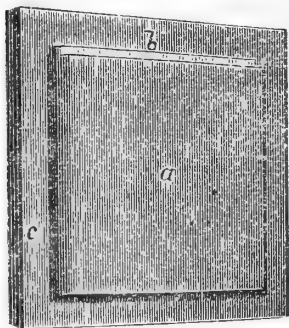
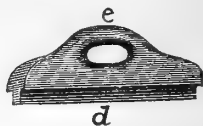

FIG. 108.



above the projection, the foundation will be made to adhere firmly to the latter, when the frame may be raised *with the block*, taken off, and another fastened as before. I have practiced this plan for years, and have had admirable success. I have very rarely known the foundation to drop if made of good wax, though it must be remembered that our hives are shaded, and our frames small.

The above methods are successful, but probably will receive valuable modifications at the hands of the ingenious apiarists

FIG. 109.

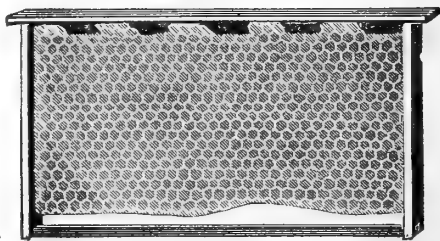

of our land. If we have frames with the V shaped top-bar (Fig. 44), we may easily break the foundation and press it on, as shown in Fig. 109.

WIRED FRAMES.

But as foundation does sometimes fall or sag, so that many cells are changed to drone-cells, or warp into awkward shapes, especially if the hive is unshaded, or receives a full colony of bees with all its frames full of foundation, and as the wax is sometimes so brittle that it will not hold together, however well fastened, wired frames (Fig. 110) are rapidly coming into

FIG. 110.

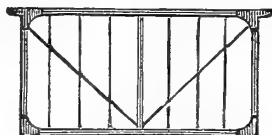

use. Another point strongly in favor of such frames is, that they can be handled or shipped, and there is not the least danger of their combs falling from the frames. The wires should be two inches apart, and the extreme wires not more than one-half inch from the side of the frame. They may be fastened by passing through holes in the top and bottom bars of the frames, which must be exactly in the center, or they may be hooked over little hooks, such as may be made by driving a staple into the frame after we have cut one limb of the staple off near the curve. If holes are to be made through the top bars of the frame, they can be easily formed by use of sharp awls. If these are set in a strong block like an iron rake, each bar can be pierced at one stroke by use of a lever press. If the foundation is to be stamped in the frame by the Given Press, then the wire should be No. 36; if it is to be put on by hand, then No. 30 must be used. Tinned wire should be used. Some, even with the Given Press, prefer to put the foundation onto the wires by hand. In this case the foundation should be warmed till quite soft, then laid on the wires, and by use of a shoe-buttoner, with a longitudinal groove cut into the convex side of the curve, pressed onto the wires. This work is easily and rapidly performed.

SAVE THE WAX.

As foundation is becoming so popular, it behooves us all to be very careful that no old comb goes to waste. Even now

the supply of wax in the country is scarce equal to the demand. Soiled drone-comb, old, worthless worker-comb, all the comb in the old hives if we use Mr. Heddon's method of transferring, and all fragments that cannot be used in the hives, together with cappings, after the honey is drained out through a coarse bag or colander—which process may be hastened by a moderate heat, not sufficient to melt the wax, and frequent stirring—should be melted, cleansed, and molded into cakes of wax, soon to be again stamped, not by the bees, but by wondrous art.

METHODS.

A slow and wasteful method is to melt in a vessel of heated water, and to purify by turning off the top, or allowing to cool, when the impurities at the bottom are scraped off, and the process repeated till all impurities are eliminated.

A better method to separate the wax is to put it into a strong, rather coarse bag, then sink this in water and boil. At intervals the comb in the bag should be pressed and stirred. The wax will collect on top of the water.

To prevent the wax from burning, the bag should be kept from touching the bottom of the vessel by inverting a basin in the bottom of the latter, or else by using a double-walled vessel. The process should be repeated till the wax is perfectly cleansed.

But as wax is to become so important, and as the above methods are slow, wasteful, and apt to give a poor quality of

FIG. 111.

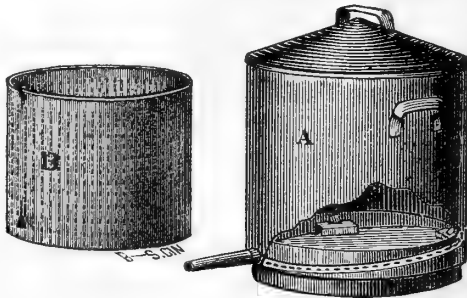

Swiss Wax Extractor.

wax, specialists, and even amateurs who keep as many as ten or twenty colonies of bees, may well procure a wax extractor (Fig. 111). This is also a foreign invention, the first being

made by Prof. Gerster, of Berne, Switzerland. These cost from five to seven dollars, are made of tin, are very convenient and admirable, and can be procured of any dealer in apian supplies.

The comb is placed in the perforated vessel, and this in the larger can, which is set on a kettle of boiling water. The clean, pure wax passes out the spout. Mr. Jones has improved the common wax extractor (Fig. 112). This is what he

FIG 112.

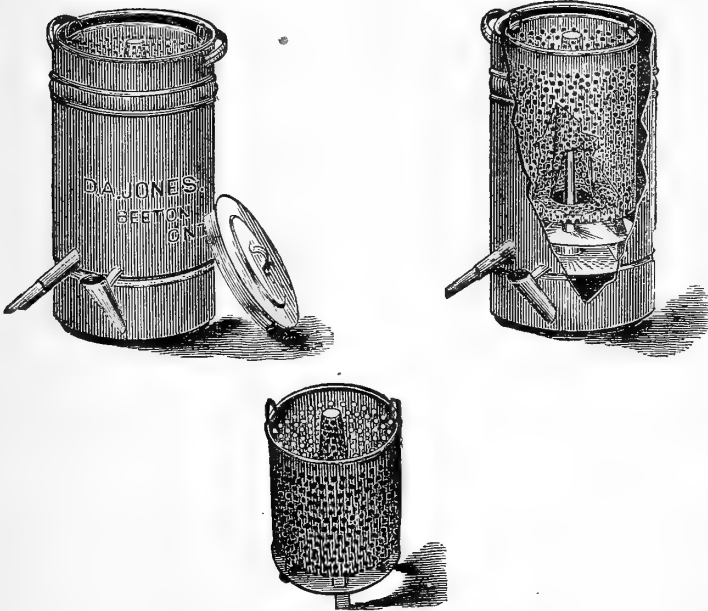

says of it: "Put extractor on stove in the same manner as an ordinary pot, having beforehand filled lower tank with water, and the perforated basket above tank with broken comb or whatever material you wish to extract wax from. The steam passes through perforated metal walls of basket, melting every particle of wax from the crude material; the wax runs out of a spout for the purpose, turned downwards; under this spout have a receptacle, which have slightly oiled, to keep wax from adhering to its walls. The tube turned upwards serves two very important purposes, viz.: to fill water into lower tank, and to

see if tank requires replenishing, without taking out the basket above. Keep everything but tube for wax closed, in order to lose no steam and give it full force. When not in use as an extractor it is excellent as a capping can; the cappings drop into basket, the honey drains off, leaving the remainder just where you want them to extract from."

By this invention all the wax, even of the oldest combs, can be secured, in beautiful condition, and as it is perfectly neat, there is no danger of provoking the "best woman in the world," as we are in danger of doing by use of either of the above methods—for what is more untidy and perplexing than to have wax boil over on the stove, and perhaps get on the floor, and be generally scattered about!

All pieces of comb should be put into a close box, and if any larvæ are in it, the comb should be melted so frequently that it will not smell badly. By taking pains, both in collecting and melting, the apiarist will be surprised at the close of the season, as he views his numerous and beautiful cakes of wax, and rejoice as he thinks how little trouble it has all cost.

CHAPTER XVI.

MARKETING HONEY.

No subject merits more attention by the apiarist than that of marketing honey. There is no question but that the supply is going to continually increase, hence, to sustain the price we must stimulate the demand, and by doing this we shall not only supply the people with a food element which is necessary to health, but we shall also supersede in part the commercial syrups, which are so adulterated as not only to be crowded with filth the most revolting, but are often even teeming with poison. (Report of Michigan Board of Health for 1874, pp. 75-79.) To bring, then, to our neighbor's table the pure, wholesome, delicious nectar, right from the hive, is philanthropy, whether he realizes it or not.

Nor is it difficult to stimulate the demand. I have given special attention to this topic for the last few years, and am free to say that not a tithe of the honey is consumed in our country that might and should be.

HOW TO INVIGORATE THE MARKET.

First. See that no honey goes to market from your apiary that is not in the most inviting form possible. Grade *all the honey thoroughly*, and expect prices to correspond with the grade. See that every package and vessel is not only attractive, but so arranged as not to make the dealer any trouble or cause him any vexation. One leaky can or crate may do great injury.

Second. See that every grocer in your vicinity has honey constantly on hand. Do all you can to build up a home market. The advice to sell to only one or two dealers is, I think, wrong. Whether we are to buy or sell, we shall find almost always that it will be most satisfactory to deal with men whom we know, and who are close at hand. Only when you outgrow your home market should you ship to distant places. This course will limit the supply in large cities, and thus raise the prices in the great marts, whose prices fix those in the country. Be sure to keep honey constantly in the markets.

Third. Insist that each grocer make the honey *very* conspicuous. If necessary, supply large, fine labels, with your own name almost as prominent as is that of the article.

Fourth. Deliver the honey in small lots, so that it will be sure to be kept in inviting form, and, if possible, attend to the delivery yourself, that you may know that all is done "decently and in order."

Fifth. Instruct your grocers that they may make the honey show to the best effect, and thus captivate the purchaser through the sight alone.

Sixth. *Call local and general conventions*, that all in the community may know and practice the best methods, so that the markets may not be demoralized by poor, unsalable honey.

It is of the greatest importance to encourage State, inter-State, and National Associations. Happily, our civilization makes every person effected by the acts of each person. Selfishness, not less than Christianity, urges us all to be interested in each other. The honey traffic reaches from State to State. Bee-keeping will never be perfect as an art till all beekeepers act as one man. He is short-sighted that decries conventions. It is the experience of the world that they are valuable in other arts. Bee-keeping is no exception. Let us all urge that the associations act in unison, from the local to the general, that all other apiarian interests no less than the markets shall be in the highest degree fostered. Each association, from the most local to the most general, has its special mission which no other can perform.

PREPARATION FOR MARKETS.

Of course, the method of preparation will depend largely upon the style of honey to be sold, so we will consider these kinds separately.

EXTRACTED HONEY.

As before intimated, extracted honey has all the flavor, and is in every way equal, if not superior—comb itself is innutritious and very indigestible, to comb-honey. When people once know its excellence—know that it is not "strained"—then the demand for this article will be vastly increased, to the advantage both of the consumer and the apiarist.

Explain to each grocer what we mean by the word extract-

ed, and ask him to spread wide the name and character of the honey. Leave cups of honey with the editors and men of influence, and get them to discuss its origin and merits. I speak from experience, when I say that in these ways the reputation and demand for extracted honey can be increased to a surprising degree, and with astonishing rapidity.

HOW TO TEMPT THE CONSUMER.

First. Have it chiefly in small cups or pails. Many persons will pay twenty-five cents for an article, when if it cost fifty cents they would not think of purchasing.

Second. Study the kinds of receptacles that will take best with the buyers. Some persons will prefer such vessels as jelly cups or glass fruit jars, etc., that will be useful in every household when the honey is gone. Others will prefer more

FIG. 113.

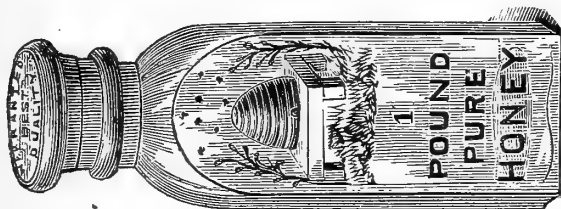

showy vessels, like the Muth one pound and two pound jars (Fig 113), even though they cost more. At present the neat tin pails (Fig. 114) holding from one-half pound to twelve pounds, are very popular in the markets. The covers shut

FIG. 114.



inside, and if the honey is granulated they are very excellent. The bails make them more convenient and salable. Mr. Jones has a pail that is easily sealed with wax strings, and is beautifully decorated with chromoed labels. Such pails are

cheap, convenient, and leave little to be desired. Their beauty aids the sale. Mr. A. I. Root pronounces them the best receptacle for extracted honey.

If the honey is to be sent to a distant market it should be in soft wood—spruce, pine, or hemlock—kegs (Fig. 115).

FIG. 115.



These are lighter than barrels, and by thorough soaking in water before use they need no waxing. Hard wood barrels must be waxed, then if the honey granulates the hoops must be loosened to take out the head. This cracks the wax and a leak results.

Third. Explain to the grocer that if kept above the temperature of 70° or 80° F., it will not granulate, that granulation is a pledge of purity and superiority, and show him how easy it is to reduce the crystals, and ask him to explain this to his customers. If necessary, liquify some of the granulated honey in his presence. Put on the labels directions for reliquifying candied honey. Honey, like many other substances, will not granulate if heated to 200° F., and then sealed while hot. This does no injury to the honey, but it is trouble, and makes the honey less convenient to ship, though at times it may pay till we educate our patrons in reference to the excellence of granulated honey.

Lastly. If you do not deliver the honey yourself, be sure that the vessels will not leak in transit. It is best, in case jelly cups are used, that they be filled at the grocery. And do not forget the large label, which gives the kind of honey, grade, and producer's name.

If the honey is extracted before it is fully ripened—before the bees cap it—it should always be kept in an open can or barrel, covered with cloth, and in a warm room. Thus arranged it will thicken as well as in the hive. *No honey should ever be kept in a cool, damp room.*

The admirable work of Mr. C. F. Muth in Cincinnati, ed-

ucating people in reference to extracted honey, fighting all adulteration, pushing it into the candy, tobacco, and confectionary establishments, deserves our hearty gratitude. Mr. Muth's market has become stupendous, and graphically shows what this trade is to be in the near future, when all our cities have a Muth to work for us. I would also recommend to all the very valuable little pamphlet of Mr. Chas. Dadant, on the production and sale of extracted honey. It is most interesting reading to the honey producer, and shows what energy and thought may accomplish in this direction.

COMB-HONEY.

This, from its wondrous beauty, especially when light-colored and immaculate, will always be a coveted article for the table, and will ever, with proper care, bring the highest price paid for honey. So it will always be best to work for this, even though we may not be able to procure it in such ample profusion as we may the extracted. He who has all kinds will be able to satisfy every demand, and will most surely meet with success.

RULES TO BE OBSERVED.

This, too, should be chiefly in small sections (Fig. 55) for, as before stated, such are the packages that surely sell. Sections from three to six inches square will just fill a plate nicely, and look very tempting to the proud housewife, especially if some epicurean friends are to be entertained.

The sections should surely be in place at the dawn of the white clover season, so that the apiarist may secure the most of this irresistible nectar, chaste as if capped by the very snow itself. They should be taken away as soon as capped, as delay makes them highways of travel for the bees, which always mars their beauty.

When removed, if demanded, glass the sections, but before this we should place them in hives one upon another, or special boxes made tight, with a close cover, in which to store either brood-frames in winter or sections at any season, and fume them with burning sulphur. This is quickly and easily done by use of the smoker. Get the fire in the smoker well to burning, add the sulphur, then place this in the top hive, or top of the special box. The sulphurous fumes will descend

and deal out death to all moth larvæ. *This should always be done* before shipping the honey, if we regard our reputations as precious. It is well to do this immediately upon removal, and also two weeks after, so as to destroy the moth larvæ not hatched when the sections are removed.

If separators have been used, these sections are in good condition to be glassed, and are also in nice shape to ship even without glass, as they may stand side by side and not mar the comb.

The shipping-crate (Fig. 116) should be strong, neat and cheap, with handles as seen in Fig. 116—such handles are also

FIG. 116.

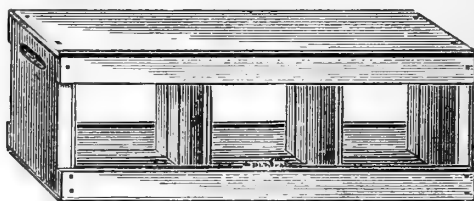

convenient in the ends of the hives, and can be cut in an instant by having the circular-saw set to wobble. With handles the crate is more convenient, and is more sure to be set on its bottom. The crate should also be glassed, as the site of the comb will say: "Handle with care."

Mr. Heddon makes a larger crate (Fig. 117), which is neat and cheap. Muth's crate is like Heddon's, only smaller.

It may be well to wrap the sections in paper, as thus breakage of one will not mean general ruin.

In shipping in freight cars, it is desirable that the sections be set lengthwise of the cars, as the danger from the shocks of starting and stopping will be much less.

In groceries, where the apiarist keeps honey for sale, it will pay him to furnish his own boxes. These should be made of white wood, very neat and glassed in front to show the honey, and the cover so fixed that unglazed sections—and these, probably, will soon become the most popular—cannot be punched or fingered. Be sure, too, that the label, with kind of honey, grade and name of apiarist, be so plain that "he who runs may read."

Comb-honey that is to be kept in the cool weather of autumn, or the cold of winter, must be kept in warm rooms, or the comb will break from the sections when handled. By

FIG. 117.

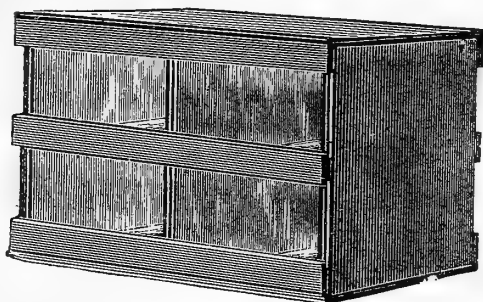

keeping it quite warm for some days previous to shipment, it may be sent to market even in winter, but must be handled very carefully, and must make a quick transit.

Above all, let *"taste and neatness" ever be your motto.*

MARKETING BEES.

Before leaving this subject, let me say a word about selling bees.

SELLING QUEENS.

As queen rearing and shipping have already been sufficiently described, it only remains to be said that the vender of queens can not be too prompt or fair or cautious. Success no less than morality demands the most perfect honesty. If, for any reason, queens can not be sent promptly, the money should at once be returned, explanation made, and, if reasonable, delay may be requested. The breeder who by careful selection, and care in following the rules of breeding, shall secure a type of bees pronounced in excellence, has won in the race.

I have described shipping bees. The rules just given should guide here also.

SELLING BEES BY THE POUND.

This is now quite a business. The bees are put, by use of a large tin tunnel, into a cage (Fig. 118) made of sections as

FIG. 118.

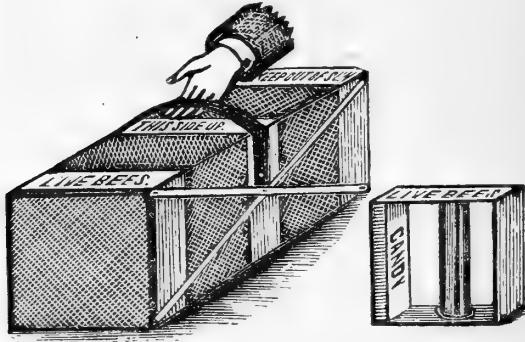

shown in the figure. The handle makes it easy to carry them, and they get careful handling without any special request.

VINEGAR FROM HONEY.

Mr. T. F. Bingham utilizes the cappings secured while extracting, to produce wax and a most excellent quality of vinegar. The honey is drained from the cappings, which are then covered for an hour or two with water. The cappings from 1,000 pounds of honey will sweeten enough water for 45 gallons of vinegar. The water is now drained into an open barrel, which should be kept covered with cloth. The scum should be removed as it rises. In about a year the change to first-class vinegar will have been accomplished. After the water is drained from the cappings they can be converted into pure wax, as already described.

FAIRS AND THE MARKET.

Our English friends have demonstrated that large honey exhibitions are a most powerful aid in developing the honey market.

Till within two years our American honey exhibits have been a disgrace and a hindrance, and they are largely so today. A little second-rate honey sandwiched in with sugar

and syrups, and supplemented by a cake or two of black dirty wax, describes the honey exhibit at most of our fairs to-day. The premiums range from twenty-five cents to fifty cents.

WHAT SHOULD WE HAVE?

Our industry demands a separate building, filled with tons, not pounds, of honey, and exhibiting every thing that is valuable in modern apiculture. In one corner of the building there should be a room (Fig. 119) partitioned off with mosquito-

FIG. 119.

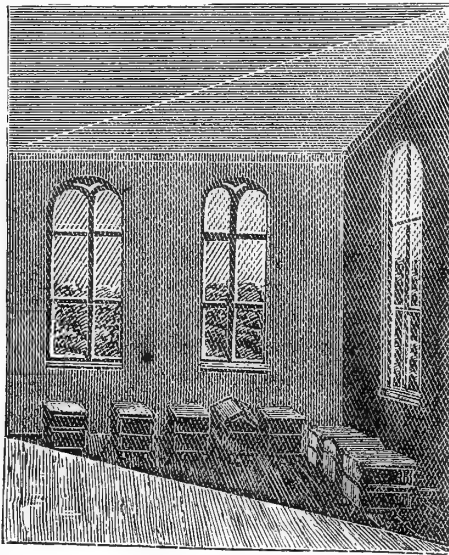

to netting, or wire cloth, where the bees should be exhibited, and where daily manipulation at a certain time should take place. Openings through the wall of the building (Fig. 120, *B. C.* etc.) should permit the bees to fly entirely outside the building, or if the building is at the margin of the grounds entirely outside the limits of the fair. It should be arranged with the managers that sales of honey and all apparatus be

made at any time at this building, on conditions that the exhibit should be in nowise interfered with. The premiums

FIG. 120.

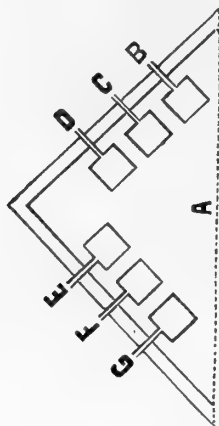

should range from one dollar to twenty, and the total should reach to the hundreds.

We find here in Michigan that all that is necessary to effect this grand and invaluable transformation is a little life and energy on the part of the bee-keepers.

EFFECTS OF SUCH EXHIBITS.

They would show that apiculture is no second rate business. They would attract attention and educate as nothing else would. They would go hand in hand with local conventions in instructing bee-keepers so that no inferior honey would go onto the markets. They would enable bee-keepers to see and buy just what they need in the more intelligent prosecution of their business. They would scatter the little pint, half-pint, and gill pails of honey into thousands of homes, and develop a knowledge and taste that would stimulate the honey market most powerfully. Tons of honey have been sold at the Toronto Fairs, the influence of which has been a lasting surprise even to the most enterprising producers. I believe that the great quartet that is to advance apiculture is fairs, associations, planting for honey, and improved bees.

CHAPTER XVII.

HONEY PLANTS.

As bees are dependent mainly upon flowers for honey, it of course follows that the apiarist's success will depend largely upon the abundance of honey-secreting plants in the vicinity of his apiary. True it is that certain bark and plant lice secrete a kind of liquid sweet—honey of doubtful reputation—which, in the dearth of anything better, the bees seem glad to appropriate. I have thus seen the bees thick about a large bark-louse which attacks the tulip tree, and thus often destroys one of our best honey trees.

I have described this insect (Fig. 121) under the name of *Lecanium Tulipifera*. In 1870 it did no small injury to our

FIG. 121.

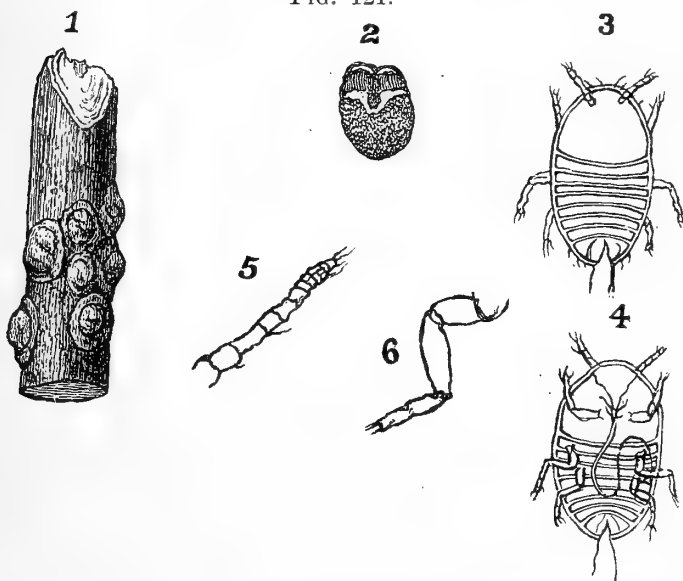
*Tulip-Tree Bark Louse.*

1—Scale on Twig.
3, 4—Young Lice.
5—Leg.

2—Under side of Scale.
6—Antenna.

tulip trees here at the college. It has seriously injured this tree in the states bordering the Ohio river. The tulip is often called poplar, which is quite incorrect. The poplar belongs to the willow family, the tulip to the magnolia. This louse is of double interest to bee-keepers. It ruins one of our best honey trees, and supplies a poor substitute for plant nectar to the bees. All bark lice, which include the orange tree scale lice of the south, are best destroyed by use of whale oil soap—strong solution—or kerosene oil. This latter is best applied in the form of an emulsion, with soap solution or milk. Whitman's Fountain Pump is admirable for making such applications.

I have also seen the bees thick about several species of plant lice. One, the *Erisoma imbricator*, Fitch, works on the beech tree. Its abdomen is thickly covered with long wool, and it makes a comical show as it wags this up and down upon the least disturbance. The leaves of trees attacked by this louse, as also those beneath the trees, are fairly gummed with a sweetish substance. I have found that the bees avoid this substance, except at times of extreme drouth and long protracted absence of honeyed bloom.

Another species, *Thalaxes ulmicola*, gives rise to certain solitary galls, which appear on the upper surface of the leaves of the red elm. These galls are hollow, with a thin skin, and within the hollows are the lice, which secrete an abundant sweet that often attracts the bees to a feast of fat things, as the gall is torn apart, or cracks open, so that the sweet exudes. This sweet is anything but disagreeable, and may not be unwholesome to the bees. The larch louse, *Lachnus laricis*, secretes a liquid that is greedily taken by the bees.

Another of the aphides, of a black hue, works on the branches of our willows, which they often entirely cover, and thus greatly damage another tree valuable for both honey and pollen. Were it not that they seldom are so numerous two years in succession, they would certainly banish from among us one of our most ornamental and valuable honey-producing trees. These are fairly thronged in September and October, and not unfrequently in spring and summer if the lice are abundant, by bees, wasps, ants, and various two-winged flies, all eager to lap up the oozing sweets. This louse is the *Lachnus dentatus*, of Le Baron, and the *Aphis saliceti* of Harris.

The past summer I have received from apiarists of Indiana and Ohio, a very large, dark gray, plant louse which worked on the sycamore, and is reported from both states as keeping the bees actively employed for some weeks. This louse is one-fourth of an inch long. The winged lice measure three-eighths of an inch to the tips of their wings.

The veins of the wings, as also the short nectaries—the tubes at the posterior part of the abdomen—show that this louse (Fig. 122) belongs to the *Genus Lachnus*. The lice of the *Genus Aphis*—of which there are innumerable species—have

FIG. 122.

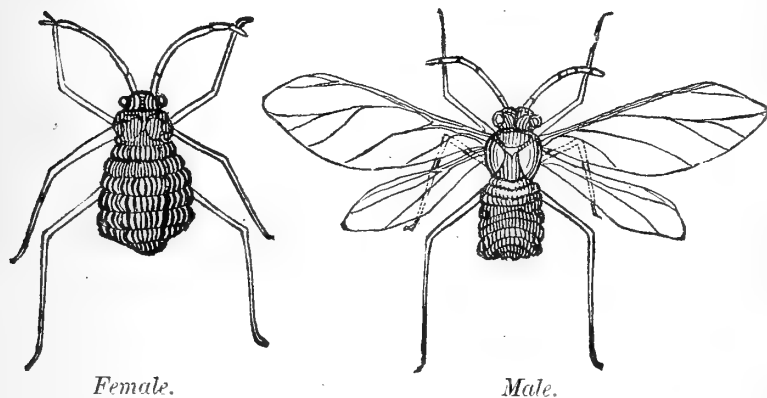
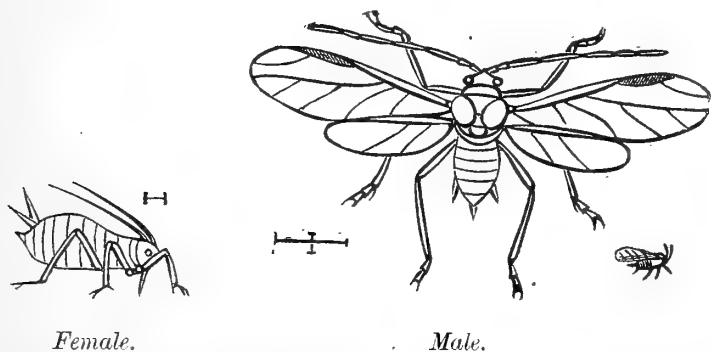

FIG 123.



longer nectaries (Fig. 123), from which ooze large drops of nectar. This is much relished by the ants, which often care for these lice as tenderly as for their own young.

Doubtless many have supposed that the bees were gathering a real honey dew, when closer inspection would have shown that some species of plant lice was wholly responsible. I think that very often this nectar from plant lice is entirely wholesome and unobjectionable.

REAL HONEY DEW.

Bees also get, in some regions, a sort of honey-dew, which enables them to add to their stores with surprising rapidity.

FIG. 124.



Cow Pea.

a, a—Glands.

b—Flower.

c—Pods.

I remember one morning while riding on horseback along the Sacramento river, in California, I broke off a willow twig

beside the road when, to my surprise, I found it was fairly decked with drops of honey. Upon further examination I found the willow foliage was abundantly sprinkled by these delicious drops. These shrubs were undisturbed by insects, nor were they under trees. Here then was a real case of honey-dew, which must have been distilled through the night by the leaves. I never saw any such phenomenon in Michigan, yet others have. Dr. A. H. Atkins, an accurate and conscientious observer, has noted this honey-dew more than once here in Central Michigan. Many bee-keepers have noticed the same thing.

Many plants, like the Cotton and Cow Pea (Fig. 124) of the South, have extra floral glands which secrete nectar. In case of the Cow Pea these glands are on the peduncles or flower stems, just at the base of the flowers (Fig. 124, *a, a*). Prof. Trelease thinks that this nectar serves the plant by attracting bees, wasps, etc., which keep injurious insects from attacking it.

SWEET SAP AND JUICES.

Bees often gather much nectar from the stubble of wheat that is cut early, while the straw is yet green. The sap from the maple and other trees and plants also furnishes them sweets. They gather juices of questionable repute from about cider mills, some from grapes and other fruit which have been crushed, or eaten and torn by wasps and other insects. That bees ever tear the grapes is a question of which I have failed to receive any personal proof, though for years I have been carefully seeking it. I have lived among the vineyards of California, and have often watched bees about vines in Michigan, but never saw bees tear open the grapes. I have laid crushed grapes in the apiary, when the bees were not gathering, and were ravenous for stores, which, when covered with sipping bees, were replaced with sound grape-clusters, which in no instance were mutilated. I have even shut bees in empty hives on warm days and closed the entrance with grape clusters, which even then were not cut. I have thus been led to doubt if bees ever attack sound grapes, though quick to improve the opportunities which the oriole's beak and the stronger jaws of wasps offer them. My friend Prof. Prentiss suggests that when the weather is very warm and damp, and

the grapes very ripe, the juice may ooze through small openings of the grapes and so attract the bees. It is at just such times that attacks are observed. Still, Dr. C. V. Riley feels sure that bees are sometimes thus guilty, and Mr. Bidwell tells me he has seen bees rend sound grapes, which they did with their feet. Yet, if this is the case, it is certainly of rare occurrence, and is more than compensated by the great aid which the bees afford the fruit-grower in the great work of cross-fertilization, which is imperatively necessary to his success, as has been so well shown by Dr. Asa Gray and Mr. Chas. Darwin. It is true that cross-fertilization of the flowers, which can only be accomplished by insects, and early in the season by the honey-bee, is often, if not always, necessary to a full yield of fruit and vegetables. In diecious plants, like the willows and most nut bearing trees, the stamens that bear the pollen or male element, are on one plant, and the pistils that grow the ovules—the female element—on another. Here then insects must act as “marriage priests” that fructification may be accomplished at all. In other plants where the organs are all in the same flower, fertilization is wholly dependent on insects. In cases like the red clover where fertilization is possible without aid, my colleague, Prof. Beal, has shown that unless insects are present, the yield of seed is meager indeed. The seeds in the uncovered blossoms were to those in the covered as 236:5. There is then entire reciprocity between the bees and flowers. The bees are as necessary to the plants as are the plants to the bees. I am informed by Prof. W. W. Tracy, that the gardeners in the vicinity of Boston keep bees that they may perform this duty. Even then, if Mr. Bidwell and Prof. Riley are right, and the bee does, rarely—for surely this is very rare, if ever—destroy grapes, still they are, beyond any possible question, invaluable aids to the pomologist. That bees ever injure blossoms and thus effect damage to the fruitage of such plants as buckwheat—or to any plants—as is sometimes claimed, is utterly absurd and without foundation.

But the principal source of honey is still from the flowers.

WHAT ARE THE VALUABLE HONEY PLANTS?

In the northeastern part of our country the chief reliance, for May, is the fruit-blossoms, willows, and sugar maples. In

June, white clover, Alsike clover, and raspberries yield largely of the most attractive honey, both as to appearance and flavor. In July, the incomparable basswood makes both bees and apiarist jubilant. In August, buckwheat offers a tribute, which we welcome, though it be dark and pungent in flavor, while with us in Michigan, August and September give us a profusion of bloom which yields to no other in the richness of its capacity to secrete honey, and is not cut off till the autumn frosts—usually about September 15.

Thousands of acres of golden rod, boneset, asters, and other autumn flowers of our new northern counties, as yet have blushed unseen, with fragrance wasted. This unoccupied territory, unsurpassed in its capability for fruit production, covered with grand forests of maple and basswood, and spread with the richest of autumn bloom, offers opportunities to the practical apiarist rarely equaled except in Texas and the Pacific States. In these localities one or two hundred pounds a season to the colony and its increase, is no surprise to the apiarist, while even four or five hundred are not isolated cases.

In the following table will be found a list of valuable honey plants. Those in the first column are annual, biennial, or perennial; the annual being enclosed in a parenthesis thus: (); the biennial enclosed in brackets thus: []; while those in the second column are shrubs or trees; the names of shrubs being enclosed in a parenthesis. The date of the commencement of bloom is, of course, not invariable. The one appended, in case of plants which grow in our State, is about average for Central Michigan. Those plants whose names appear in small capitals yield very superior honey. Those with (*a*) are useful for other purposes than honey secretion. All but those with a * are native or very common in Michigan. Those written in the plural refer to more than one species. Those followed by a † are very numerous in species. Of course I have not named all, as that would include some hundreds which have been observed at the college, taking nearly all of the two great orders, Compositæ and Rosaceæ. I have only aimed to give the most important, omitting many foreign plants of notoriety, as I have had no personal knowledge of them.

Date.	Annuals or Perennials.
April.....	Skunk Cabbage.
April and May.....	Dandelion.
April and May.....	Strawberry. (a)
April and May.....	*BALL, BLACK OR BLUE SAGE—California.
May.....	*WHITE SAGE—California.
May.....	(Seven-Top Turnip).
May and June.....	*Horehound—California.
May and June.....	*Sumac—California.
May and June.....	*Coffee Berry—California.
May and June.....	*HORSE MINT—South.
May and June.....	False Indigo.
May and June.....	Lupine.
May to August.....	Ground Ivy or Sill.
May to Fall.....	(Cow Pea.) (a)—South.
June.....	*Stone Crop, South.
June.....	Mammoth Red Clover. (a)
June.....	*California Figwort—California.
June.....	(Hemp). (a).
June to July.....	WHITE CLOVER. (a)
June to July.....	ALSIKE CLOVER. (a)
June to July.....	*[SWEET CLOVER.]
June to July.....	*Horehound.
June to July.....	Ox-eyed Daisy—Bad Weed.
June to July.....	Bush Honeysuckle.
June and July.....	*Partridge Pea.
June to August.....	Matrimony Vine.
June to August.....	*Sage.
June to August.....	Mother-wort.
June to frost.....	*Borage.
June to frost.....	*Cotton. (a).
June to frost.....	Silk or Milk Weeds.
June to frost.....	(Mustard)†
June to frost.....	*Rape. (a).
June to frost.....	St. John's Wort.
June to frost.....	(MIGNONETTE). (a)
July.....	(Corn). (a)
July.....	*Teasel. (a)
July to August.....	Basils or Mt. Mint.
July to August.....	Catnip. (a)
July to August.....	Asparagus. (a)
July to August.....	*Rocky Mountain Bee Plant).
July to August.....	*Viper's Rugloss (Blue Thistle).
July to August.....	Blue Vervain or Verbena.
July to August.....	White Vervain or Verbena.
July to August.....	Marsh Milk-Weed.
July to frost.....	Boneset.
July to frost.....	Bergamot.
July to frost.....	Figwort.
July to frost.....	Giant Hyssop.
July to frost.....	Malva.
July to frost.....	Iron Weed.
July to frost.....	Culver's Root.
July to frost.....	Indian Plantains.
August.....	(Buckwheat). (a)
August.....	(Snap-dragon).
August.....	(Touch Me Not or Swamp Balsam).
August.....	(Great Willow Herb Fire Weed.)
August to September.....	Golden Honey Plant.
August to September.....	Large Smart Weed.
August to frost.....	*[SPIDER FLOWER].
August to frost.....	(GOLDEN ROD). †
August to frost.....	ASTERS. †
August to frost.....	Marsh Sunflower. †
August to frost.....	Tick-Seed. †
August to frost.....	Beggar-Ticks. †
August to frost.....	Spanish Needles. †
August to frost.....	Rattlesnake Root or Tall White Lettuce.

Date.	Shrubs or Trees.
January to May.....	*Manzanita—California.
January to May.....	*(Willow) †—California.
February to June.....	(Gall Berry)—South.
March.....	*Orange, South.
April.....	Box Elder or Ash-Leaf Maple.
April.....	Red or Soft Maple. (a)
April.....	Poplar or Aspen.
April.....	Silver Maple.
April.....	*Judas Tree—South.
April and May.....	(Willows) † also Trees.
April and May.....	*Judas Tree—South.
May.....	(Shad-Bush).
May.....	(Alder).
May.....	Maples—Sugar Maple. (a)
May.....	Crab Apple.
May.....	(Hawthorns).
May.....	Fruit Trees—Apple, Plum, Cherry, Pear, etc. (a)
May.....	(Currant and Gooseberry). (a)
May.....	*(Wistaria Vine—South).
May.....	(Chinese Wistaria Vine—South).
May.....	(Japan Privet)—South.
May.....	Varnish Tree—South.
May.....	Acacia—South.
May.....	Black Gum—South.
May.....	(Bladder Nut).
May.....	Persimmon (a)—South.
May.....	SAW PALMETTO—South.
May.....	Buckeye.
May and June.....	(Barberry).
May and June.....	(Grape-Vine). (a).
May and June.....	Tulip-tree.
May and June.....	(Sumac).
May and June.....	Buch Thorn—South.
May and June.....	BLACK MANGROVE—Florida.
June.....	Magnolias—South.
June.....	Honey Locust.
June.....	Wild-Plum.
June.....	(Black Raspberry). (a)
June.....	Locusts.
June.....	(RED RASPBERRY). (a)
June to July.....	(Blackberry).
June to July.....	*Sourwood—South.
July.....	(Button Bush).
July.....	BASSWOOD. (a)
July.....	(Virginia Creeper). (a)
June and July.....	*CABBAGE PALMETTO—South.
July.....	*Blue Gum—California.
July.....	Catalpa. (a)
July to August.....	*Pepper-tree—California.
July to September.....	*(St. John's Worts).
August.....	(Late Sumac).
August to September.....	Indian Currant or Coral Berry.
August to frost.....	*Red Gum—California.
August to December.....	Japan Plum—South.
August to January.....	(Germander or Wood Sage).

DESCRIPTION, WITH PRACTICAL REMARKS.

As this subject of bee pasturage is of such prime importance, and as the interest in the subject is so great and widespread, I feel that details with illustrations will be more than warranted.

We have abundant experience to show that forty or fifty

FIG. 125.

*Sugar Maple.*

colonies of bees, take the seasons as they average, are all that a single place will sustain to the greatest advantage. Then how significant the fact, that when the season is the best, full three

times that number of colonies will find ample resources to keep all employed. So this subject of artificial pasturage becomes one well worthy close study and observation. The subject, too, is a very important one in reference to the location of the apiary.

It is well to remember in this connection, that while bees do sometimes go from five to seven miles for nectar, two or three miles should be regarded as the limit of profitable gathering. That is, apiaries of from fifty to one hundred or more colonies, should not be nearer than four or five miles of each other.

MARCH PLANTS.

In Florida the orange gives early bloom, and the thousands of trees in that land, not only of flowers but of honey, will have no small influence in building up the colonies for the grand harvest of mangrove and palmetto soon to follow.

The gall-berry of the south commences to bloom even in February, and yields abundant nectar. In Florida this shrub gives the main supply of honey during the swarming season.

APRIL PLANTS.

As we have already seen, the apiarist does not secure the best results, even in the early spring, unless the bees are encouraged by the increase of their stores of pollen and honey; hence, in case we do not practice stimulative feeding—and many will not—it becomes very desirable to have some early bloom. Happily, in all sections of the United States our desires are not in vain.

Early in spring there are many scattering wild flowers, as skunk cabbage, *Symplocarpus fetidus*, which supplies abundant pollen and some honey; the blood-root, *Sanguinaria Canadensis*, liver-leaf, *Hepatica acutiloba*, and various others of the crow-foot family, as also many species of cress, which belong to the mustard family, and the gay dandelion, *Taraxacum dens-leonis*, which keeps on blooming for weeks, etc., all of which are valuable and important.

The maples (Fig. 125), which are all valuable honey plants, also contribute to the early stores. Especially valuable are the silver maples, *Acer dasycarpum*, the red or soft maples, *Acer rubrum*, and the box elder or ash-leaf maple, *Negundo aceroides*, as they bloom so very early, long before the leaves

appear. The bees work on these, here in Michigan, the first week of April, and often in March. They are also magnificent shade trees, especially those that have the weeping habit. Their early bloom is very pleasing, their summer form and fo-

FIG. 126.



Willow.

FIG. 127.



Judas Tree.

liage beautiful, while their flaming tints in autumn are indescribable. The foreign maples, sycamore, *Acer pseudo-platanus*, and Norway, *Acer platanoides*, are also very beautiful. Whether superior to ours as honey plants, I am unable to say.

The willows, too, (Fig. 126) rival the maples in the early period of bloom. Some are very early, blossoming in March, while others, like the white willow, *Salix alba* (Fig. 126), bloom in May. The flowers on one tree or bush of the willow are all pistillate, that is, have pistils but no stamens, while on others they are all staminate, having no pistils. On the former, bees can gather only honey, on the latter only pollen. That the willow furnishes both honey and pollen is attested by the fact that I saw both kinds of trees, the pistillate and the staminate, thronged with bees the past season. The willow, too, from its elegant form and silvery foliage, is one of our finest shade trees. It grows everywhere in the United States.

In the south of Michigan, and thence southward to Kentucky, and even beyond, the Judas tree, or red-bud, *Cercis Canadensis* (Fig. 127), is not only worthy of cultivation as a honey plant, but is also very attractive, and well deserving of attention for its ornamental qualities alone. This blooms from March to May, according to the latitude.

The poplars—not the tulip—also bloom in April, and are freely visited by the bees. The wood is immaculate, and is used for toothpicks. Why not use it for sections?

In California, the unique and exquisite Manzanitas (species of *Arctostaphylos*) together with the willows and many other flowering plants keep the bees busy from January till May.

MAY PLANTS.

In May we have the grand sugar maple, *Acer saccharinum* (Fig. 125), incomparable for beauty, also all our various fruit trees, peach, cherry, plum, apple, etc.; in fact all the Rosaceæ

FIG. 128.



American Wistaria.

family. Our beautiful American Wistaria, *Wistaria frutescens* (Fig. 128), the very ornamental climber, or the still more lovely Chinese Wistaria, *Wistaria sinensis* (Fig. 129), which has longer racemes than the native, and often blossoms twice in the season. These are the woody twiners for the apiarist.

The barberry, too, *Berberis vulgaris* (Fig. 130), comes after fruit blossoms, and is thronged with bees in search of nectar

FIG. 129.



Chinese Wistaria.

FIG. 130.



Barberry.

in spring, as with children in winter, in quest of the beautiful scarlet berries, so pleasingly tart.

In California, the sumac, the horehound, the famous black sage (Fig. 131), *Audibertia Palmeri*, or more correctly *Trechostema lanatum*, (there are two other species less common,) with its most beautiful and delicious honey, and the more common, and hardly less excellent white sage, *Audibertia polystachia*, (Fig. 132), keep the bees roaring with activity, in favorable seasons, from April even into June.

FIG. 131.



Ball or Black Sage.

FIG. 132.



White Sage.

In the South, as I learn from that able apiarist, Dr. J. H. P. Brown, they are no less favored. The Japan Privet, the varnish tree, the acacia, the black gum and the persimmon, stir the bees up to their best endeavor in May. The banana blooms not only in May, but, as Mr. W. S. Hart, of Florida, writes me, it is in blossom the year around. So rich are the flower tubes in nectar that Mr. Hart says he could soon gather a tea-cup full by hand of clear beautiful nectar of good flavor.

FIG. 133.

*Horse Mint.*

The horse-mint (Fig. 133), *Monarda aristata*, is sending the bees loaded to their hives with its peculiar aromatic nectar. This with the buckthorn yields honey into June.

The Saw Palmetto, *Sable serulata*, forms a dense growth and makes clearing the land no small expense in Florida. The slim trunk creeps along the ground for twenty feet and sends roots beneath for nourishment. The leaves arise from this stem and are from four to six feet long. The clusters of small yellowish-white blossoms are immense in size. The blossoms last from the middle of April till June. The honey is yellow, thick and fine. The fruit of this palm is about twice the size of the Concord grape, and from October till Christmas the oozing nectar keeps the bees at work. This is dark honey but very good for stimulative feeding.

JUNE PLANTS.

With June comes the incomparable white or Dutch clover, *Trifolium repens* (Fig. 134), whose chaste and modest bloom betokens the beautiful, luscious, and unrivaled sweets which

FIG. 134.

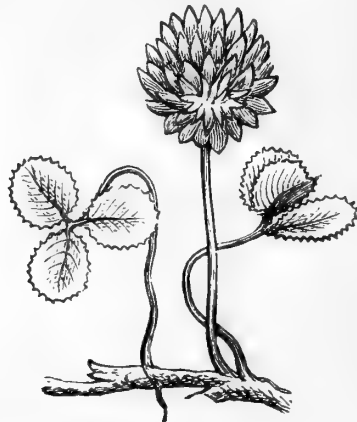

White or Dutch Clover.

are hidden in its corolla tube. Also its sister, Alsike or Swedish, *Trifolium hybrida* (Fig. 135), which seems to resemble both the white and red clover. It is a stronger grower than the white, and has a whitish blossom tinged with pink. This forms excellent pasture and hay for cattle, sheep, etc., and may well be sown by the apiarist. It will often pay apiarists to furnish neighboring farmers with seed as an inducement to grow this excellent honey plant. Like white clover, it

blooms all through June into July. Both of these should be sown early in spring with timothy, five or six pounds of seed to the acre, in the same manner that red clover seed is sown. By cutting Alsike clover just as it commences to bloom it may be made to come into blossom the second time, so as just to fill the vacant space in August. This is a very important fact, and may well be acted upon.

Sweet clover, yellow, and white, *Melilotus officinalis* (Fig. 136) and *Melilotus alba*, are well named. They bloom from the middle of June to the first of October. Their perfume scents the air for long distances, and the hum of bees that throng their flowers is like music to the apiarist's ear. The honey, too, is just exquisite. These clovers are biennial, not blooming the first season, and dying after they bloom the second season. They perpetuate themselves, however, through the seed so as to really become perennial. A disagreeable fact is that they have little value except for honey. It is asserted by some that they give fair pasturage for stock and are excellent for soiling and green manuring. They are said to become pernicious weeds if allowed to spread. The Bokhara clover is only a variety of the above, though Mr. D. A. Jones thinks it quite superior to the others.

The other clovers—lucerne, yellow trefoil, scarlet trefoil, and alfalfa—have not proved of any value with us, perhaps owing to locality.

FIG. 135.

*Alsike Clover.*

FIG. 136.



Melilot Clover.

Borage, *Borago officinalis* (Fig. 137), an excellent bee plant, blooms from June till frost, and is visited by bees even

FIG. 137.



Borage.

FIG. 138.



Mignonette.

in very rainy weather. It seems not to be a favorite, but is eagerly visited when all others fail to yield nectar.

Mignonette, *Reseda odorata* (Fig. 138), blooms from the middle of June till frost, is unparalleled for its sweet odor, furnishes nectar in profusion, and is well worthy cultivation. It does not secrete well in wet weather, but in favorable weather it is hardly equalled.

FIG. 139.



Okra.

Okra, or gumbo, *Hibiscus esculentus* (Fig. 139), also blooms

FIG. 140.



Mint.

in June. It is as much sought after by the bees in quest of honey, as by the cook in search of a savory vegetable, or one to give tone to soup.

Sage, *Salvia officinalis*, horehound, *Marrubium vulgare*, motherwort, *Leonurus cardiaca*, and catnip, *Nepeta cataria*, which latter does not commence to bloom till July, all furnish nice white honey, remain in bloom a long time, and are very

FIG. 141.

*Motherwort.*

desirable, as they are in bloom in the honey dearth of July and August. They, like many others of the mint family (Fig. 140), are thronged with bees during the season of bloom. The first and last are of commercial importance, while very

few of our native plants afford so much nectar, are such favorites with the bees, and are so independent of weather as motherwort (Fig. 141). It is crowded with bees from the dawn of its bloom till the last flower withers. By cutting it back in May it can be made to blossom just at the dearth of nectar-secreting bloom; otherwise it comes in June and early July, just when Linden is yielding its precious harvest. Few plants are more desirable to sow in waste places.

The silk or milk-weed furnishes abundant nectar from June to frost, as there are several species of the genus *Asclepias*, which is wide-spread in our country. This is the plant which has large pollen masses which often adhere to the legs of bees (Fig. 142), and sometimes so entrap them as to cause their death. Prof. Riley once very graciously advised planting them to kill bees. I say graciously, as I have watched these very closely, and am sure they do little harm, and are rich in nectar. Seldom a bee gets caught so as to hold it long, and

FIG. 143.



FIG. 142.

Pollen of Milk-Weed.

Black Mustard.

when these awkward masses are carried away with the bee, they are usually left at the door of the hive, where I have often seen them in considerable numbers. The river bank

hard by our apiary is lined with these sweet-smelling herbs, and we would like even more.

Black mustard, *Sinapis nigra* (Fig. 143), white mustard, *Sinapis alba*, and rape, *Brassica campestris* (Fig. 144), all look much alike, and are all admirable bee plants, as they furnish much and beautiful honey. The first, if self-sown, blooms with us July 1st, the others June 1st; the first about eight weeks after sowing, the others about four. The mustards bloom for four weeks, rape for three. These are all specially commendable, as they may be made to bloom during the honey dearth of July and August, and are valuable plants to raise for seed. Rape seems to be very attractive to insects, as the flea beetles and the blister beetles are often quite too much for it, though they do not usually destroy the plants till after they have blossomed. I have several times purchased what purported

FIG. 144.



Rape.

to be Chinese mustard, dwarf and tall, but Prof. Beal, than whom there is no better authority, tells me they are only the white and black, and certainly they are no whit better as bee plants. These plants, with buckwheat, the mints, borage, and mignonette, are specially interesting, as they cover, or may be made to cover, the honey dearth from about July 20th to August 20th.

The mustards and rape may be planted in drills about eight inches apart, any time from May 1st to July 15th. Four quarts will sow an acre.

In this month blooms the tulip tree, *Liriodendron tulipifera* (Fig. 145)—often called poplar in the South, which is not only an excellent honey producer, but is one of our most stately and admirable shade-trees. Now bloom the sumacs,

FIG. 145



though one species blooms in May, the wild plum, the raspberries, whose nectar is unsurpassed in color and flavor, and

the blackberry. Corn yields largely of honey as well as pollen, and the teasel, *Dipsacus fullonum* (Fig. 146), is said, not only by Mr. Doolittle, but by English and German apiarists, to yield richly of beautiful honey. This last has commercial importance. The blackberry opens its petals in June, and also the fragrant locust, which, from its rapid growth, beautiful form and handsome foliage, would rank among our first shade trees, were it not that it is so tardy in spreading its canopy of green, and so liable to ruinous attack by the borers, which

FIG. 146.

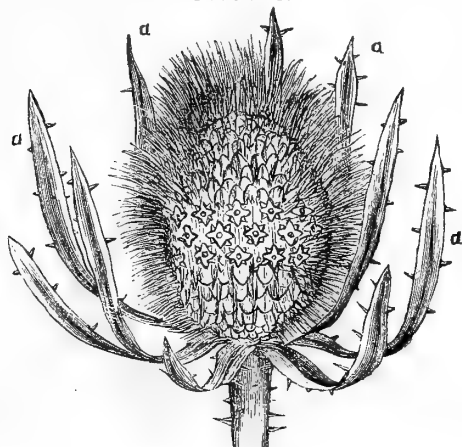

Teasel.

last peculiarity it shares with the incomparable maples. Washing the trunks of the trees in June and July with soft soap will in great part remove this trouble.

In June the Mammoth Red Clover, *Trifolium pratense*, comes out in one mass of crimson. This, unlike common red clover, has flower tubes short enough for even the ligula of the black bee. It is pretty coarse for hay but excellent for pasture and for green manuring. The Partridge pea, *Cassia chamaecrista* (Fig. 147), furnishes abundant nectar, and like the Cow pea of the South has extra floral as well as floral glands. Lupine, *Lupinus perennis*, and gill or ground ivy, *Nepeta glechoma*, commenced to blossom in May and now are fully out. This last is a mint, a near relative of catnip. The Matrimony Vine, *Lycium vulgare*, and the beautiful honey locust, *Gliditschia*

triacanthos (Fig. 148), are now full of life, as the bees come and go full-loaded with nectar. In California, the fig-wort,

FIG. 147.



Partridge Pea.

Scrophularia Californica, contributes to the honey supply. Our brothers of the South reap a rich harvest from the great staple, cotton, *Gossypium herbaceum* (Fig. 149), which commences to bloom early in June, and remains in blossom even to October. This belongs to the same family—Mallow—as the hollyhock, and like it blooms and fruits through the season.

The Cow pea (Fig. 124) is not only good for bees, but for feed, and to enrich the soil. The Stone Crop, *Sedum pulchellum*, is another valuable honey plant of the South. In June the Magnolias (Fig. 150)—there are several species in the South—are in bloom. In many parts they commence to blos-

som in May. One of the finest of these is the *Magnolia glauca* (Fig. 150).* One would suspect at once that it was a near relative of the Tulip tree.

FIG. 148.

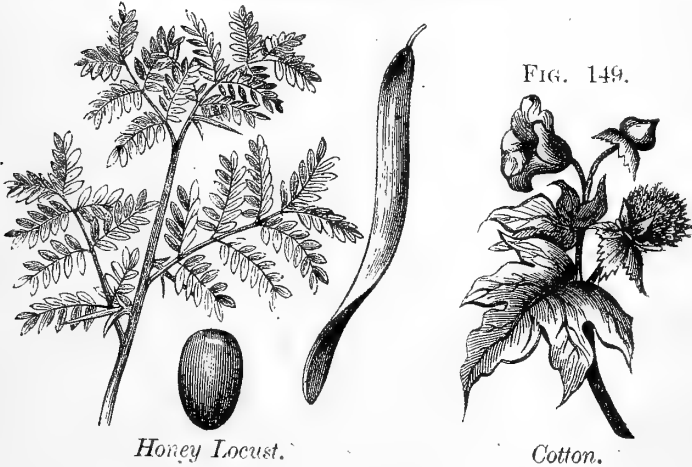

Honey Locust.

Cotton.

JULY PLANTS.

Early in this month opens the far-famed basswood or linden, *Tilia Americana* (Fig. 151), which for the profusion and

FIG. 150.

*Magnolia.*

quality of its honey has no superior. Mr. Doolittle got 66 pounds of honey from this source by a single colony in three days. There is rarely a year that it does not give us some of

its incomparable nectar. The tree, too, from its great spreading top and fine foliage, is magnificent for shade. Five of these

FIG. 151.



Basswood.

trees are within two rods of my study window, and their grateful fragrance and beautiful form and shade have often been the subject of remark by visitors.

Figwort, *Scrophularia nodosa* (Fig. 152), often called Rattle-Weed, as the seeds will rattle in the pod, and Carpenter's Square, as it has a square stalk, is an insignificant looking weed, with

FIG. 152.

*Figwort.*

inconspicuous flowers, that afford abundant nectar from the middle of July till frost. I have received almost as many for identification as I have of the asters and golden-rods. Prof. Beal remarked to me a year or two since, that it hardly seemed

FIG. 153.



Rocky Mountain Bee-Plant.

FIG. 154.



. Bonaset.

possible that it could be so valuable. We cannot always rightly estimate by appearances alone. It is a very valuable plant to be scattered in waste places.

That beautiful and valuable honey plant, from Minnesota, Colorado and the Rocky Mountains, cleome, or the Rocky Mountain bee-plant, *Cleome integrifolia* (Fig. 153), if self-sown, or sown early in the spring, blooms by the middle of July and lasts for long weeks. Nor can anything be more gay than these brilliant flowers, alive with bees all through the

FIG. 155.

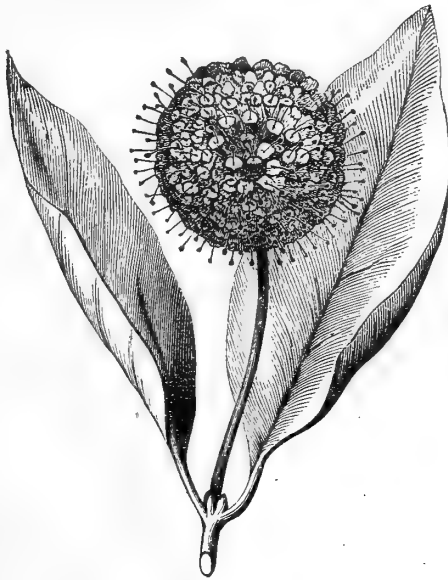

Button Ball.

long fall. This should be planted in fall in drills two feet apart, the plants six inches apart in the drills. It will not grow if planted in the spring. The seeds, which grow in pods, are very numerous, and are said to be valuable for chickens. It does best on light soil. Now commence to bloom the numerous Eupatoriums, or bonesets, or thoroughworts (Fig. 154), which fill the marshes of our country, and the hives as well, with their rich golden nectar. These are precursors of that

profusion of this composite order, whose many species are even now budding in preparation for the sea of flowers which will deck the marsh-lands of August and September. Wild bergamot, also, *Monarda fistulosa*, which like the thistles is of importance to the apiarist, blooms in July. As before re-

FIG. 156.

*Sour Wood.*

marked this is one of the plants whose long flower tubes are pierced by the *Bombus*, and *Xylocopa* bees. Then the honey-bees help to gather the abundant nectar. This is a near relative of the southern horse mint which, as will be seen, it closely resembles. The golden honey plant, *Actinomeris squarrosa*, so praised by Dr. Tinker, and rattle-snake root, *Nabalus altissi-*

mus, which swarms with bees all the day long, are also composite plants.

The little shrub of our marshes, appropriately named button-bush, *Cephalanthus occidentalis* (Fig. 155); also shares the attention of the bees with the linden; while apiarists of the South find the sour-wood, or sorrel tree, *Oxydendrum arboreum* (Fig. 156), a valuable honey tree. This belongs to the Heath family, which includes the far-famed heather bloom of England. It also includes our whortleberry, cranberry, blueberry, and one plant which has no enviable reputation, as furnishing honey which is very poisonous, even fatal to those who eat, the mountain laurel, *Kalmia latifolia*. Yet, a near relative which grows at the South, *Andromeda nitida*, is said to furnish beautiful and wholesome honey in great quantities. The Virginia creeper also blooms in July. I wish I could say that this beautiful vine, transplendent in autumn, is a favorite with the honey-bee. Though it often, nay always, swarms with wild bees when in blossom, yet I never saw a honey-bee visit the ample bloom amidst its rich, green, vigorous foliage.

The St. John's wort, *Hypericum*, with its many species, both shrubby and herbaceous, offers bountiful contributions to the delicious stores of the honey-bee. The catnip, *Nepeta cataria*, and asparagus—which if uncut in spring will bloom in June—so delectable for the table, and so elegant for trimming table meats and for banquets in autumn, come now to offer their nectarian gifts.

Basil or mountain mint, *Pyenanthemum lanceolatum*—we might almost include all the mints, the blue and white vervains, or verbenas, *Verbena hastata*, and *V. stricta*; the iron weeds, *Veronias*; the malvas, culvers root, *Veronica Virginica*—another of the figwort family; indian plantains, *Cacalias*, and vipers' bugloss—the so called blue thistle—all contribute to the apiary in July; the vipers' bugloss, *Echium vulgare*, though most common south is very abundant at Beeton, Canada. Mr. Jones has it growing all about his apiaries. I have never seen it in Michigan. It is a near relation of borage, and does not belong even to the family—Compositæ—of the thistles.

In California, the blue gum and the red gum, *Eucalyptus globulus*, and *E. rostrata*, introduced from Australia, furnish honey from July and August till December.

The catalpa, a very rapid growing tree, throws its large,

showy blossoms to the breeze and bees in July. It is rapidly growing in favor as a shade tree, and is incomparable for posts. It lasts for a great many years when imbedded in the earth. But, "the noblest Roman of them all" is the cabbage palmetto, *Chamerops palmetto* (Fig. 157), as Mr. Hart, of Florida, says

FIG. 157.

*Cabbage Palmetto.*

this is the linden of the south. It yields abundant honey, which, as all who saw and tasted it at the late Convention at Cincinnati, can vouch, is unsurpassed in flavor. Mr. Muth well said that he wished no finer. This tree grows to the height of seventy feet. The trunk is leafless to near the top, and varies little in size from the earth to the top. The small, white blossoms nestle among the long palm leaves in profusion, and are rich in both nectar and pollen, from June 1st till August. The tree is found from the Carolinas to the Gulf.

At the same time with the above, the white blossoms of the black mangrove, *Avicennia tomentosa*, and its near relative, *Avicennia oblongifolia*, come forth with their abundant and incomparable nectar which hangs in drops. The honey from this and the cabbage palmetto is clear, and as fine and beauti-

ful as that of white clover. This tree is confined to the Peninsula of Florida, where it is regarded as the best honey plant that grows in that locality.

Here we see the danger of common names. This is not a mangrove at all, though the leaves resemble those of the true

FIG. 158.



True Mangrove.

mangrove, they are more tomentose or hairy, and, like that tree, it grows down to the very waters' edge, so it is not affected

by drouth. This is an evergreen, and forms an impenetrable thicket on the muddy shores of the sea. It belongs to the same family as our verbenas—the vervain family.

The true mangrove (Fig. 158) has yellow blossoms, and like the renowned Banyan tree, sends numerous stems to the earth, each of which takes root. This tree belongs to the mangrove family, and is *Rhizophora mangle*.

AUGUST AND SEPTEMBER PLANTS.

The cultivated buckwheat, *Fagopyrum esculentum* (Fig. 159), usually blooms in August, as it is sown the first of July—three pecks per acre is the amount to sow—but by sowing the first of June, it may be made to bloom the middle of July,

FIG. 159.



Buckwheat.

when there is generally, in most localities, an absence of nectar-secreting flowers. The honey is inferior in color and flavor, though some people prefer this to all other honey. The silver-leaf buckwheat blooms longer, has more numerous flowers, and thus yields more grain than the common variety.

Now come the numerous golden-rods. The species of the genus *Solidago* (Fig. 160), in the Eastern United States, number nearly two-score, and occupy all kinds of soils, and

are at home on upland, prairie and morass. These abound in all parts of the United States. They yield abundance of rich, golden honey, with flavor that is unsurpassed by any other. Fortunate the apiarist who can boast of a thicket of *Solidagoes* in his locality.

The many plants usually styled sun-flowers, because of their resemblance to our cultivated plants of that name, which deck the hill-side, meadow, and marsh-land, now unfurl their

FIG. 160.



Golden-Rod.

FIG. 161.



Aster.

showy involucre, and open their modest corollas, to invite the myriad insects to sip the precious nectar which each of the clustered flowers secretes. Our cultivated sunflowers, I think, are indifferent honey plants, though some think them big with beauty, and their seeds are relished by poultry. But the asters (Fig. 161), so wide-spread, the beggar-ticks, *Bidens*, and Spanish-needles of our marshes, the tick-seed, *Coreopsis*, also, of the low, marshy places, with hundreds more of the great family *Compositæ*, are replete with precious nectar, and with favorable seasons make the apiarist who dwells in their midst jubi-

lant, as he watches the bees which fairly flood the hives with the rich and delicious honey. In all of this great family,

FIG. 162.



the flowers are small and inconspicuous, clustered in compact heads, and when the plants are showy with bloom, like the

sun-flowers, the brilliancy is due to the involucre, or bracts which serve as a frill to decorate the more modest flowers.

The great Willow Herb, or Fire Weed, *Epilobium angustifolium*, is often the source of immense honey harvests. The downy seeds blow to great distances, and finding a lodgment, their vitality makes them burst forth whenever brush is burned or forest fires rage. Hence the name, Fire Weed. Another excellent fall honey plant of wide range is the Coral Berry or Indian Currant, *Symphoricarpos vulgaris*. The honey product of this plant is worthy its name. I close this account with mention of another *Cleome*, the famous Spider Plant (Fig. 162), *Cleome pungens*. This plant thrives best in rich, damp clay soil. It is only open for a little time before night-fall and at early dawn, but when open its huge drops of nectar keep the bees wild with excitement, calling them up even before daylight, and enticing them to the field long after dusk.

I have thus mentioned the most valuable honey plants of our country. Of course there are many omissions. Let all apiarists, by constant observation, help to fill up the list.

BOOKS ON BOTANY.

I am often asked what books are best to make apiarists botanists. I am glad to answer this question, as the study of botany will not only be valuable discipline, but will also furnish abundant pleasure, and give important practical information. Gray's Lessons and Manual of Botany, in one volume, published by Ivison, Phinney, Blakeman & Co., New York, is the most desirable treatise on this subject. A more recent work by Prof. C. E. Bessey, and published by Henry Holt & Co., is also very excellent.

PRACTICAL CONCLUSIONS.

It will pay well for the apiarist to decorate his grounds with soft and silver maples, for their beauty and early bloom. If his soil is rich, sugar maples and lindens may well serve a similar purpose. The Judas and tulip trees, both North and South, may well be made to ornament his home. For vines, obtain the wistarias.

Sow and encourage the sowing of Alsike clover and silver-leaf buckwheat in your neighborhood. Be sure that your wife, children, and bees can often repair to a large bed of the new giant or grandiflora migonette, and remember that it, with figwort, spider plant, Rocky Mountain bee plant, and borage, bloom till frost. Study the bee plants of your region, and then study the above table, and provide for a succession, remembering that the mustards, rape, and buckwheat may be made to bloom almost at pleasure, by sowing at the proper time. Do not forget that borage and the mustards seem comparatively indifferent to wet weather. Be sure that all waste places are stocked with motherwort, catnip, figwort, cleome, viper's bugloss, asters, etc.

The above dates, unless specially mentioned, are only correct for Michigan, Northern Ohio, and similar latitudes, and for more Southern latitudes must be varied, which, by comparison of a few, as the fruit trees, becomes no difficult matter.

CHAPTER XVIII.

WINTERING BEES.

This is a subject, of course, of paramount importance to the apiarist of the Northern States, as this is the rock on which some of even the most successful have recently split. Yet I come fearlessly to consider this question, as from all the multitude of disasters I see no occasion for discouragement. If the problem of successful wintering has not been solved already, it surely will be, and that speedily. So important an interest was never yet vanquished by misfortune, and there is no reason to think that history is now going to be reversed. Of course this chapter has no practical value to the apiarists of the South and Pacific Coast. There safe wintering is assured, except as the careless bee-keeper permits starvation.

THE CAUSES OF DISASTROUS WINTERING.

I fully believe, and to no branch of this subject have I given more thought, study, and observation, that all the losses may be traced to either unwholesome food, failure in late breeding of the previous year, extremes of temperature, or protracted cold with excessive dampness. I know from actual and wide-spread observation, that the severe loss of 1870 and 1871 was attended in this part of Michigan with unsuitable honey in the hive. The previous autumn was unprecedentedly dry. Flowers were rare, and storing was largely from insect secretion, and consequently the stores were unwholesome. I tasted of honey from many hives only to find it nauseating.

Again, suppose that after the basswood season in July, there is no storing of honey, either from want of space, or from lack of bloom; in this case brood-rearing ceases, yet if the weather is dry and warm, as of course it will be in August and September, the bees continue to wander about, and death comes apace, and by autumn the bees are reduced in numbers, old in days, and illy prepared to brave the winter and perform the duties of spring. I fully believe that if all the colonies of our State and country had been kept breeding by proper use of the extractor and feeding, even till into

October, we should have had a different record, especially as to spring dwindling and consequent death. In the autumn of 1872, I kept my bees breeding till the first of October. The following winter I had no loss, while my neighbors lost all of their bees.

Extremes of heat and cold are also detrimental to the bees. If the temperature of the hive becomes too high, the bees become restless, eat more than they ought, and if confined to their hives are distended with their feces, become diseased, besmear their comb and hives, and die. If when they become thus disturbed, they could have a purifying flight, all would be well. Again, if the temperature becomes extremely low, the bees to keep up the animal heat must take more food; they are uneasy, exhale much moisture, which may settle and freeze on the outer combs about the cluster, preventing the bees from getting the needed food, and thus in this case both dysentery and starvation confront the bees. That able and far-seeing apiarist, the lamented M. Quinby, was one of the first to discover this fact; and here, as elsewhere, gave advice that if heeded would have saved great loss and sore disappointment. I have little doubt, in fact I know from actual investigation, that in the past severe winters, those bees which under confinement have been subject to severe extremes, were the ones that invariably perished. Had the bees been kept in a uniform temperature, ranging from 35° to 45° F., the record would have been materially changed.

Excessive moisture, especially in cases of protracted cold, is always to be avoided. Bees, like all other animals, are constantly giving off moisture, which of course will be accelerated if the bees become disturbed and are thus led to consume more food. This moisture not only acts as explained above, but also induces fungous growths. The mouldy comb is not wholesome, though it may never cause death. Hence another necessity for sufficient warmth to drive this moisture from the hive and some means to absorb it without opening the hive above and permitting a current, which will disturb the bees, and cause the greater consumption of honey.

THE REQUISITE TO SAFE WINTERING—GOOD FOOD.

To winter safely, then, demands that the bees have thirty pounds, by weight not guess—I have known three cases when

guessing meant *starvation*, of good capped honey (coffee A sugar is just as good). If desired this may be fed as previously explained, which should be done so early that all will be capped during the warm days of October.

The bees should be able to pass over or through the combs. Hill's device—bent pieces placed above the frames so as to raise the cloth cover—will permit the first, while small holes cut through the combs will enable the bees to pass from one comb to another without having to pass around. These holes may be cut with a knife, or a tin tube the size of one's finger may be driven through the comb, and left in if desired, in which case the comb should be pushed out of the tube, and the tube should be no longer than the comb is thick. This preparatory work I always do early in October, when I extract all uncapped honey, take out all frames after I have given each colony the thirty pounds, *by weight*, of honey, confine the space with a division-board, cover with the quilt and chaff, and then leave undisturbed till the cold of November calls for further care. I prefer that the combs have no pollen in them, and that they be so full of honey that six or eight will be enough. Pollen usually does no harm, though sometimes it is injurious. The combs may well be one-half inch apart. If the bees have been neglected, and mid-winter finds them destitute of stores, then they should not be fed liquid honey, though this has sometimes been done with success, but either the Good or Viallon or some other solid candy should be placed on the frames just above the cluster. Or we may run the candy into a frame and hang it in the hive.

SECURE LATE BREEDING.

Keep the bees breeding till the first of October. Except in years of excessive drouth, this will occur in many parts of the country without extra care. Failure may result from the presence of worthless queens. Any queens which seem not to be prolific should be superseded whenever the fact becomes evident. *I regard this as most important.* Few know how much is lost by tolerating feeble, impotent queens in the apiary, whose ability can only keep the colonies alive. Never keep such queens about. Here, then, is another reason for always keeping extra queens on hand. Even with excellent

queens, a failure in the honey yield may cause breeding to cease. In such cases, we have only to feed as directed under the head of feeding.

TO SECURE AND MAINTAIN THE PROPER TEMPERATURE.

We ought also to provide against extremes of temperature. It is desirable to keep the temperature between 35° and 50° F., through the entire winter, from November to April. If no cellar or house is at hand, this may be accomplished as follows: Some pleasant, dry day in late October or early November, raise the stand and place straw beneath; then surround the hive with a box a foot outside the hive, with movable top, and open on the east; or else have a long wooden tube, opposite the entrance, to permit flight; this tube should be six or eight inches square to permit easy examination in winter. The same end may be gained by driving stakes and putting boards around. Then we crowd between the box and the hive either cut straw, chaff or shavings. After placing a good thickness of cut straw above the hive, lay on the cover of the box, or cover with boards. This preserves against changes of temperature during the winter, and also permits the bees to fly, if it becomes necessary from a protracted period of warm weather. I have thus kept all our bees safely during two of the disastrous winters. This plan usually succeeds well, but will fail in a very severe winter like that of 1880-81. As some may wish to try, and possibly to adopt it, I will describe the box used at our College, which costs but one dollar and is convenient to store away in summer.

BOX FOR PACKING.

The sides of this (Fig. 163, *a, a*) facing east and west are three and a half feet long, two feet high at the south end, and two and a half feet at the north. They are in one piece, which is secured by nailing the boards which form them to cleats, which are one inch from the ends. The north end (Fig. 163, *b*) is three feet by two and a half feet, the south (Fig. 163, *b*), three feet by two, and made the same as are the sides. The slanting edges of the side (Fig. 163, *a, a*) are made by using for the upper boards, the strips formed by sawing diagonally from corner to corner a board six inches wide and

three feet long. The cover (Fig. 163, *g*), which is removed in figure, is large enough to cover the top and project one inch at both ends. It should be battened, and held in one piece by cleats (Fig. 163, *h*) four inches wide, nailed on to the ends. These will drop over the ends of the box, and thus hold the cover in place, and prevent rain and snow from driving in. When in place this slanting cover permits the rain to run off easily, and will dry quickly after a storm. By a single nail at each corner the four sides may be tacked together about the hive, when it can be packed in with cut

FIG. 163.

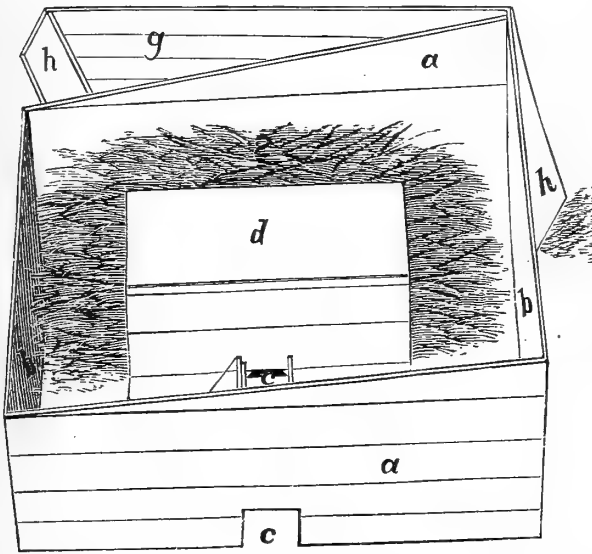

straw (Fig. 163), or fine chaff, which should be carefully done, if the day is cold, so as not to disquiet the bees. At the centre and bottom of the east side (Fig. 163, *c*), cut out a square, eight inches each way, and between this and the hive place a bottomless tube (the top of this tube is represented as removed in figure to show entrance to hive), before putting in the cut straw or chaff and adding the cover. This box should be put in place before the bleak cold days of November, and retained in position till the stormy winds of April are

passed. This permits the bees to fly when very warm weather comes in winter or spring, and requires no attention from the apiarist. By placing two or three hives close together in autumn—*yet never move the colonies more than three or four feet at any one time*, as such removals involve the loss of many bees—one box may be made to cover all, and at less expense. This will also be more trustworthy in very cold winters. Late in April these boxes may be removed and packed away, and the straw or chaff carried away, or removed a short distance and burned.

CHAFF HIVES.

Messrs. Townley, Butler, Root, Poppleton and others, prefer chaff hives, which are simply double-walled hives, with the four or five inch chambers filled with chaff. The objections to these I take to be: first, they are not proof against severe and long-continued cold, like the winter of 1880-81; second, such cumbersome hives are inconvenient to handle in summer; and, third, they are expensive. That they would in part supply the place of shade, is, perhaps, in their favor, while Mr. A. I. Root thinks they are not expensive.

Mr. O. O. Poppleton, one of our most intelligent bee-keepers, shows practically that the first objection given above is not valid. So very likely the failure in so many apiaries in 1880-81 was rather due to improper use. Mr. Poppleton claims numerous advantages for these hives:

- 1st. In his hands, success.
- 2d. They permit early preparation for winter.
- 3d. They give entire freedom from care of the bees from September till March.
- 4th. Preparation for winter requires only slight labor.
- 5th. We can easily get at the bees at any time.
- 6th. The bees are not excited by a slight rise in temperature, and so are not lost by flying on cold days; do not breed in winter and spring when they need quiet, and do not "dwindle" in spring.
- 7th. They are valuable aids in building up nuclei and weak colonies at cold periods at any one time of the year.
- 8th. They are specially desirable to protect the bees in April and May, and prevent "spring dwindling."

RULES FOR THEIR USE.

Mr. Poppleton urges the following important points:

1st. Pack early in Autumn before cold weather, and do

FIG. 164.

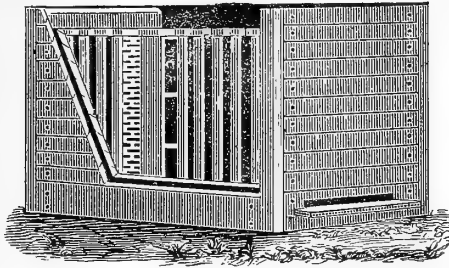

not remove the packing till the warm weather has come to stay.

FIG. 165.

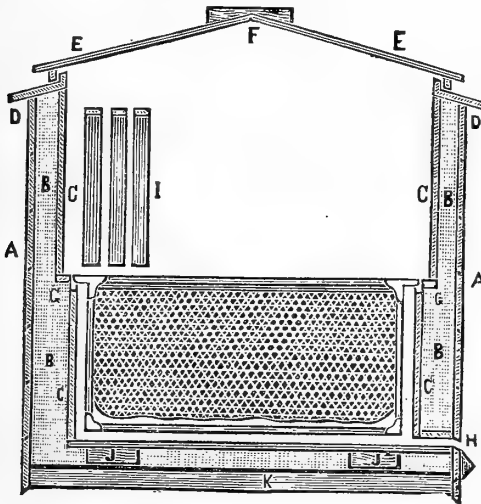

2d. Have five or six inches on *all sides* of bees, of *fine chaff*—timothy is best—entirely freed from straw.

3d. Be sure and have the chaff below the bees as well as above and on the sides.

4th. Do not put the chaff above the bees on loose, but confine in sacks. This is for convenience and neatness.

5th. Have as much empty space as possible inside the hive and outside the packing; and never let the cover to the hive rest immediately on the packing.

6th. Crowd the bees on to a few frames—never more than eight—and the packing close to the bees.

7th. Winter passages should be made through all the combs.

Mr. Jones prefers that the outer wall of the chaff hive (Fig. 164) should be of narrow boards so as to be more pervious to dampness. He also uses fine dry saw-dust instead of chaff. Mr. Root in his two-story hives (Fig. 165) uses a thicker layer of chaff below, but carries it to the top. Of course the double wall need not extend on the sides of the frames. The division boards on the sides of the frames may make the double wall.

WINTERING IN BEE HOUSE.

As Mr. D. A. Jones has tested bee houses on a very large scale, and met with success, I will quote directly from him:

“The house should be so constructed that the out-door temperature cannot affect that of the bee house; and in order to accomplish this its walls should be packed tightly with two feet of dry sawdust or three feet of chaff, packing overhead same thickness, and the bottom so protected that no frost can penetrate. Next, it should have a ventilating tube at the top, of not less than one square inch to each colony of bees. It should have sub-earth ventilation by means of a tube laid below the depth frost will penetrate, and from one to three hundred feet in length, coming in contact with outside atmosphere at the other end; as air passes through this tube it is tempered by the distance through the earth, and comes into the house at an even temperature. By means of slides at these ventilators, the temperature can be arranged in the bee house, which should stand from 43° to 46° , and in no case should it fall lower than 42° . There should be tight-fitting tripple doors, which will make two dead-air spaces.

“When the bee house is filled, and during warm weather in the spring—the bees should not be let out on the summer stands until the first pollen appears (which is generally from the Tag Alder or Black Willow)—it is necessary that the temperature of the room be kept at the wintering standpoint. This may

be done by means of an ice-box or refrigerator, filled with ice or snow, and suspended at top of room in close proximity to the ceiling. The bottom of the box must be so constructed that while the warm air may be allowed to pass up through the refrigerator, the drippings will not drop to the floor and create moisture. This latter may be prevented by means of a tube running from the box down through the floor.

“Winter passages should be made through combs, between which a space of half an inch should be left. During the last sunshining days in fall remove the lid and cloth from hive and allow the sun to shine in; this purifies and dries them. Then put on cloth free from propolis; that same evening carry bees carefully into the house, placing them on a bench 10 to 12 inches from the floor or ground; this keeps them out of the carbonic acid gas, which is given off by the bees in the hive, and which sinks to the lowest part of the bee house. The lids should be removed, and only cloth or cushion of chaff or sawdust allowed to remain on hive. Leave entrance wide open.

“If more than one row of hives are placed in the house, place them one above the other, arranging so that the hives shall break joints. Place the weaker colonies at the top and keep two thermometers in the room, one at the level of the lower row and the other on a line with the highest hives.”

WINTERING IN CELLAR.

With only a few colonies, a cellar is not only more convenient, but I think it is safer than a house entirely above ground. In fact, I fully believe that a good cellar, thoroughly ventilated with a sub-earth ventilator, so as to always give a uniform temperature, is unsurpassed for wintering bees. Our cellar thus arranged has given perfect success. We have yet to lose our first colony in it. I know of several similar cases. I know of no exception.

A cellar in which we are sure of our ability to control the temperature, needs to be dark and quiet, and ventilated as described above. As already stated, the ventilator to bring air may well be made of tile, and pass through the earth for one or two hundred feet and then open at the bottom of the cellar. If possible, the ventilator that carries the foul air off should be connected with a stove-pipe in a room above, with its lower end reaching to the bottom of the cellar.

This arrangement secures perfect ventilation, and as the fresh air is brought through the earth below the line of frost, it is warmed in winter and cooled in spring, so that the refrigerator mentioned above is not necessary. This makes a cellar much superior to a house. The pipe should join the stove-pipe in the room above, so high as not to destroy the draft to the stove. I would have this pipe four inches in diameter, and the sub-earth pipe at least six inches.

The College apiary cellar is grouted throughout, which makes it more dry and neat. Of course it should be thoroughly drained, and entirely mouse-tight.

The colonies should be put into the depository when the hives are dry, *before cold weather*, and should remain till April; though in January and March, if there are days that are warm, they may be taken out and the bees permitted to fly, though never unless they seem uneasy and soil the entrances to their hives. Such uneasiness shows that either our cellar or our preparation is faulty. *Always*, when taken out, they should be placed on their old stands, so that no bees may be lost. Towards night, when all are quiet, return them to the cellar. I would not remove bees till towards night, as it is better that they have a good flight, and then become quiet. When moved out it is *very* desirable to brush away all dead bees, which is an argument in favor of a movable bottom-board. In moving the hives into the cellar, great care should be exercised not to jar them. It were better if the bees should not know that they were being moved at all.

That the moisture may be absorbed, it may be well to cover the bees with a bag filled with chaff, or fine dry saw-dust, even in the cellar, though I doubt if this is necessary. I make the bag so long that the chaff or saw-dust may not only cover above, but extend close down outside the division-boards. I partially or wholly remove the cover to the hive while in the cellar. With others, I have found that water in a cellar is not injurious, especially if the room be well ventilated. In fact, water which may be contained in a cistern or pass into and out of the cellar through tile, with the outlet a little higher than the inlet, serves admirably to preserve a uniform temperature, which is of the greatest importance. It not only keeps the temperature up in severe weather but down in spring, and saves all expense of sub-earth ventilation.

I have found it advantageous, when preparing my bees for winter, in October, to contract the chamber by use of a division-board. This is *very* desirable if wintered out doors, and with frames a foot square is very easily accomplished. By use of eight frames the space (one cubic foot) is very compact, and serves to economize the heat, not only in winter, but in spring. By thus using division-boards with only three frames, I have been very successful in wintering nuclei. We have only to guard against low temperature.

Perhaps I ought to say that all colonies should be strong in autumn; but I have said before, never have weak colonies. Yet for fear some have been negligent, I remark that weak colonies and nuclei should be united in preparing for winter. To do this, approximate the colonies each day, four or five feet, till they are side by side. Now remove the poorest queen, then smoke thoroughly, sprinkle both colonies with sweetened water scented with essence of peppermint, put a sufficient number of the best frames and all the bees into one of the hives, and then set this midway between the position of the hives at the commencement of the uniting. The bees will unite peaceably, and make a strong colony. In case of nuclei I usually unite three for winter. Uniting colonies may pay at other seasons. It may seem rash to some, yet I fully believe that if the above suggestions are carried out in full, I may guarantee successful wintering. But if we do lose our bees, having all our hives, combs, and honey, we can buy colonies in the spring with a perfect certainty of making 200 or 300 per cent. on our investment. Even with the worst condition of things, we are still ahead, in way of profit, of most other vocations.

BURYING BEES, OR CLAMPS.

In principle this is the same as cellar wintering. There are two serious objections to it. First, we do not know that the temperature is just right, and secondly, if aught goes wrong we know nothing of it—the bees are away out of sight. If this is practiced, the ground should either be sandy or *well drained*. If we can choose a side-hill it should be done. Beneath the hives and around them, straw should be placed. I should advise leaving the entrance well open, yet secure against mice. *The hives should all be placed beneath the surface*

level of the earth, then form a mound above them sufficient to preserve against extreme warmth or cold. A trench about the mound to carry the water off quickly is desirable. In this arrangement the ground acts as a moderator. I would urge the suggestion that no one try this with more than a few colonies, for several years, till repeated successes show that it is reliable in all seasons.

SPRING DWINDLING.

As already suggested, this is not to be feared if we keep our bees breeding till late autumn, prepare them well and early for winter, and use a good cellar for wintering. It may be further prevented by forbidding late autumn flights, frequent flights in winter, when the weather is warm, and too early flying in spring. These may all be curtailed or prevented by the packing system as described above, as thus prepared the bees will not feel the warmth, and so will remain quiet in the hive.

I am aware that this matter of spring dwindling is most stoutly urged as an objection to cellar wintering, and as an argument in favor of chaff hives. I have had excellent success in cellar wintering, and never yet lost a colony by "spring dwindling." Crowd the bees up onto a few frames in September or early October; cover warmly above and at sides of division-boards with generous bags of saw-dust, and leave these on the hives till the next June if the weather remains cool, and bees from the cellar—a good cellar—will come through the spring in excellent condition. In the winter of '81-'82, I put some chaff hives into my cellar alongside of my single-walled hives, arranged as just described, and the bees in them did no better in spring after removal from the cellar than in other hives. Be sure in early spring that the bees have no more combs than they can cover, and spring dwindling will lose its terror. The division board and saw-dust pillow are antidotes for this malady. Never set bees permanently on their summer stands from the cellar till the flowers and warmth will enable them to work.

I have little doubt but that bees will do better if no breeding takes place in winter. Perfect quiet should be our desire. If the bees have no pollen, of course no breeding will take place, and so I advised its removal. It is not for winter use.

CHAPTER XIX.

THE HOUSE APIARY AND BEE HOUSE.

The House Apiary is a frost-proof house in which the bees are kept the year through. The entrances to the hives are through the sides of the house, and all manipulation of the bees is carried on inside. From what I have said about wintering, it at once appears that such a house should preserve a uniform temperature. As many such houses were built a few years ago, and are now, with very few exceptions, used for other purposes, I will only say that if such houses are ever desirable it is only when queen rearing is to occupy the chief attention of the apiarist.

BEE HOUSES.

As a good and convenient bee-house is very desirable in every apiary of any considerable size, I will proceed to give a few hints in reference to its construction.

First. I should have a good cellar under the house, entirely frost proof, mouse and rat proof, thoroughly grouted, and ventilated as already described. I would have three doors to this from the north, the outer one inclined. I should have the entrance an inclined plane, which, especially if the apiary is large, should be so gradual in its descent that a car could pass down it into the cellar, on a temporary track. The cellar should be well drained, or if water be permitted to pass through it, this should be kept in prescribed channels. In case of large apiaries the track and car make the removal of the bees to and from the cellar an easy matter. The first floor I should have, if my apiary was large, on a level with the ground. This (Fig. 166) should contain three rooms, one on the north for a shop, one on the south-east for comb honey, and one on the south-west for extracting, and storing extracted honey and brood combs. For 100 colonies of bees, this building need not be more than sixteen by twenty feet. The room for comb will then be eight by twelve feet, that for extracting, eight by sixteen, and the shop in the form of an L. A chimney should pass from the attic at the common angle of these

three rooms through the roof. Wide doors on the south, if the apiary is large, should permit the car to enter either of the rooms on an extemporized track, whenever extracting or taking off comb honey is in operation.

The house should be so constructed as to be always free from rats and mice. In summer, wire gauze doors should be used, and the same material should be tacked on the outside of the window casing of the two south rooms. This gauze should extend from four to six inches above, and be held out

FIG. 166.

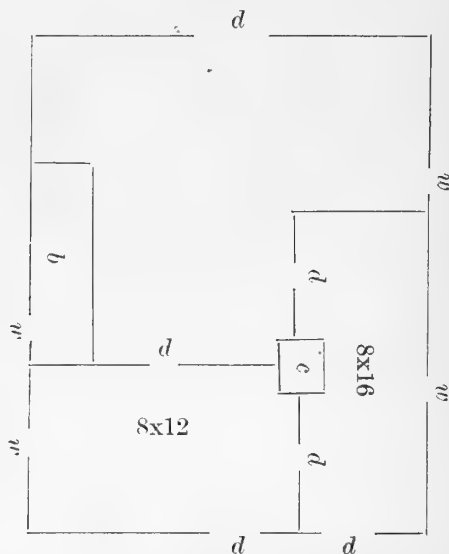
*Bee House.**d, d, etc.*,—Doors.*w, w, etc.*,—Windows.*b*—Work-bench.
c—Chimney.

from the wall by one-fourth inch strips. This permits all bees to leave the house, while the character of the opening precludes outside bees from entering. Inside doors should permit our passing directly from any of these rooms to the others. The position of the chimney makes it easy to have a fire in any of the rooms. This would be desirable in the shop, in winter, when hive making, etc., is in operation, or when visiting with other bee-keepers was in progress. The ripening of honey or late extracting makes it often desirable to have a fire

in the extracting room. If comb-honey is kept in the designated room late in the season, it may be desirable to warm that room. Of course a large stove in the shop might be made to heat any or all of the rooms. I would have the comb-honey room very tight, and ventilated by an easily regulated slide into the chimney for the purpose of easy fumigation. Platforms a little out from the wall on which the honey may rest for a time are desirable, as the honey will not be so fine if immediately crated for market.

The extractor-room should have close, moth proof cupboards for receiving brood combs. Those in our house are high enough for three rows of frames, and wide enough to just receive the top-bar of a frame cross-wise. Cleats nailed on to the inside hold the frames, which are turned diagonally a little to pass them to the lower tier. This room ought also to have a table for work, and large open tanks, open barrels, or extractor cans, to hold the honey while it ripens. If the building is painted dark, this room will be warmer in summer. The warmer it becomes the more rapidly the honey thickens.

A chamber above costs but little, and serves admirably as a place for storage. This may be entered by stairs from the shop.

A neat bench (Fig. 166, *b*), and sharp tools, all conveniently placed, make the shop a very desirable fixture to every Apiary.

I have spoken of a car and track in large apiaries; such an arrangement, which costs but little, is exceedingly desirable. The tracks run close to the rows of hives, and by means of simple switches, the car can be run anywhere in the apiary.

CHAPTER XX.

EVILS THAT CONFRONT THE APIARIST.

There are various dangers that are likely to vex the apiarist, and even to stand in the way of successful apiculture. Yet, with knowledge, most, if not all, of these evils may be wholly vanquished. Among these are: Robbing among the bees, disease, and depredations from other animals.

ROBBING.

This is a trouble that often very greatly annoys the inexperienced. Bees only rob at such times as the general scarcity of nectar forbids honest gains. When the question comes: Famine or theft, like many another, they are not slow to choose the latter. It is often induced by working with the bees at such times, especially if honey is scattered about or left lying around the apiary. It is especially to be feared in spring, when colonies are apt to be weak in both honey and bees, and thus are unable to protect their own meager stores. The remedies for this evil are not far to seek:

First. Strong colonies are *very rarely* molested, and are almost sure to defend themselves against marauders; hence it is only the weaklings of the apiarist's flock that are in danger. Therefore, regard for our motto, "Keep all colonies strong," will secure against harm from this cause.

Second. Italians,—the Cyprians and Syrians are even more spirited in this work of defense than are the Italians—as before stated, are fully able, and quite as ready, to protect their rights against neighboring tramps. Woe be to the thieving bee that dares to violate the sacred rights of the home of our beautiful Italians, for such temerity is almost sure to cost the intruder its life.

But weak colonies, like our nuclei, and black bees, are still easily kept from harm. Usually, the closing of the entrance so that but a single bee can pass through, is all sufficient. With the hive we have recommended, this is easily accomplished by simply moving the hive back or using the triangular blocks.

Another way to secure such colonies against robbing is to move them into the cellar for a few days. This is a further advantage, as less food is eaten, and the strength of the individual bees is conserved by the quiet, and as there is no nectar in the fields no loss is suffered.

In all the work of the apiary at times of no honey gathering, we cannot be too careful to keep all honey from the bees unless placed in the hives. The hives, too, should not be kept open long at a time. Neat, quick work should be the watch-word. During times when robbers are essaying to practice their nefarious designs, the bees are likely to be more than usually irritable, and likely to resent intrusion; hence the importance of more than usual caution, if it is desired to introduce a queen. Working under the bee-tent (Fig. 101) prevents all danger of inciting the bees to rob.

DISEASE.

The common dysentery—indicated by the bees soiling their hives, as they void their feces within instead of without—which so frequently works havoc in our apiaries, is, without doubt, I think, consequent upon wrong management on the part of the apiarist, as already suggested in Chapter XVIII. As the methods to prevent this have already been sufficiently considered, we pass to the terrible

FOUL BROOD.

This disease, said to have been known to Aristotle—though this is doubtful, as a stench attends common dysentery—though it has occurred in our State as well as in States about us, is not familiar to me, I having never seen but one case, and that on Kelly's Island, in the summer of 1875, where I found it had reduced the colonies on that Island to two. Of late I receive samples of this affected brood each season. It is causing sad havoc in many regions of our country. No bee malady can compare with this in malignancy. By it Dzierzon once lost his whole apiary of 500 colonies. Mr. E. Rood, first President of the Michigan Association, has lost his bees two or three times by this terrible plague.

The symptoms are as follows: Decline in the prosperity of the colony, because of failure to rear brood. The brood seems to putrefy, becomes "brown and salvy," and gives off a stench

which is by no means agreeable, while later the caps are concave instead of convex, and many will have a little hole through them.

There is no longer any doubt as to the cause of this fearful plague. Like the fell "Pebrine," which came so near exterminating the silk worm, and a most lucrative and extensive industry in Europe, it, as conclusively shown by Drs. Preusz and Shönfeld, of Germany, is the result of fungous or vegetable growth. Shönfeld not only infected healthy bee larvæ but those of other insects, both by means of the putrescent foul brood and by taking the spores.

Fungoid growths are very minute, and the spores are so infinitesimally small as often to elude the sharp detection of the expert microscopist. Most of the terrible, contagious diseases that human flesh is heir to, like typhus, diphtheria, cholera, small pox, etc., etc., are now thought to be due to microscopic germs, and hence to be spread from home to home, and from hamlet to hamlet, it is only necessary that the spores, the minute seeds, either by contact or by some sustaining air current, be brought to new soil of flesh, blood, or other tissue—their garden spot—when they at once spring into growth, and thus lick up the very vitality of their victims. The huge mushroom will grow in a night. So, too, these other plants—the disease germs—will develop with marvelous rapidity; and hence the horrors of yellow fever, scarlatina, and cholera.

To cure such diseases the fungi must be killed. To prevent their spread the spores must be destroyed, or else confined. But as these are so small, so light, and so invisible—easily borne and wafted by the slightest zephyr of summer, this is often a matter of the utmost difficulty.

In "Foul Brood" these germs feed on the larvæ of the bees, and thus convert life and vigor into death and decay. If we can kill this miniature forest of the hive, and destroy the spores, we shall extirpate the terrible plague.

Some of the facts connected with "Foul Brood" would lead us to think that the germs or spores of this fungus are only conveyed in the honey. This supposition, alone, enables us to understand one of the remedies which some of our ablest apiarists hold to be entirely sure.

REMEDIES.

If we can find a substance that will prove fatal to the fungi and yet not injure the bees, the problem is solved. Our German scientists—those masters in scientific research and discovery, have found this valuable fungicide in salicylic acid, an extract from the same willows that give us pollen and nectar. This cheap white powder is easily soluble in alcohol, and, when mixed with borax, in water.

Mr. Hilbert, one of the most thoughtful of German beekeepers, was the first to affect a radical cure of foul brood in his apiary by the use of this substance. He dissolved fifty grains of the acid in five hundred grains of pure spirits. One drop of this in a grain of distilled water is the mixture he applied. Mr. C. F. Muth, from whom the above facts as to Herr Hilbert are gathered, suggests a variation in the mixture.

Mr. Muth suggests an improvement, which takes advantage of the fact that the acid, which alone is very insoluble in water, is, when mixed with borax, soluble. His recipe is as follows: Eight grains of salicylic acid, eight grains of soda-borax, and one ounce of water. This remedy is applied as follows: First, uncap all the brood, then throw the fluid over the comb in a fine spray. This will not injure the bees, but will prove fatal to the fungi. Mr. Muth found on trial that though this method would cure, the labor and danger of spreading the disease in the operation was so great that actual cremation of all affected stocks was often to be preferred. An improvement which is just as successful and without the objections, is suggested by Mr. Muth as follows: Drum the bees all out into a clean hive, filled with foundation, shut them in this hive and feed them honey or syrup, after adding to each quart one ounce of the above compound, except that sixteen ounces each of the salicylic acid and soda-borax are used, thus making the solution of double the strength. The honey should be extracted and boiled, the old combs melted into wax, and the hive scalded or burned. Great caution should be exercised that none of the honey be eaten by bees till it has been scalded.

Mr. D. A. Jones is successful with what he terms the starvation method: The bees are removed to an empty hive, and given no food for three or four days, till they have digested

all the honey in their stomachs. They are then given foundation and food, and the combs, honey, and hive treated as described above. It would seem that the spores are in the honey, and by taking that the contagion is administered to the young bees. The honey may be purified from these noxious germs by subjecting it to the boiling temperature, which is generally, if not always, fatal to the spores of fungoid life. By immersing the combs in a salicylic acid solution, or sprinkling them with the same, they would be rendered sterile, and could be used without much fear of spreading contagion. It is better, however, to melt them at once. The disease is probably spread by robber bees visiting affected hives, and carrying with them in the honey the fatal germs.

(I have found that a paste made of gum tragacanth and water is very superior, and I much prefer it for either general or special use to gum Arabic. Yet it soon sours—which means that it is nourishing these fungoid plants—and thus becomes disagreeable. I have found that a very little salicylic acid will render it sterile, and thus preserve it indefinitely.)

ENEMIES OF BEES.

Swift was no mean entomologist, as shown in the following stanza:

“The little fleas that do us tease,
Have lesser fleas to bite them,
And these again have lesser fleas,
And so *ad infinitum*.”

Bees are no exception to this law, as they have to brave the attacks of reptiles, birds, and other insects. In fact, they are beset with perils at home and perils abroad, perils by night and perils by day.

THE BEE MOTH—*Galleria cereana*, Fabr.

This insect belongs to the family of snout moths, *Pyralidæ*. This snout is not the tongue, but the palpi, which fact was not known by Mr. Langstroth, who is usually so accurate, as he essayed to correct Dr. Harris, who stated correctly that the tongue, the ligula, was “very short and hardly visible.” This family includes the destructive hop moth, and the noxious meal and clover moths, and its members are very readily recognized by their usually long palpi, the so-called snouts.

The eggs of the bee moth are white, globular and very small. These are usually pushed into crevices by the female moth as she extrudes them, which she can easily do by aid of her spy-glass-like ovipositor. They may be laid in the hive, in the crevice underneath it, or about the entrance. Soon these eggs hatch, when the gray, dirty looking caterpillars, with brown heads, seek the comb on which they feed. To

FIG. 167.



FIG. 168.

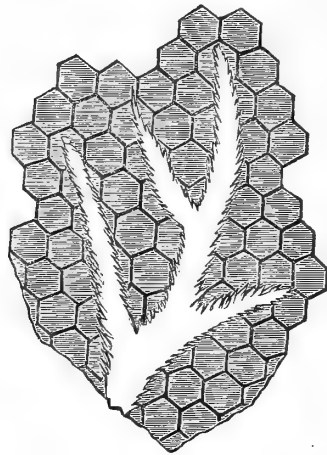

better protect themselves from the bees, they wrap themselves in a silken tube (Fig. 167) which they have power to spin. They remain in this tunnel of silk during all their growth, enlarging it as they eat. By looking closely, the presence of these larvæ may be known by this robe of glistening silk, as it extends in branching outlines (Fig 168) along the surface of the comb. A more speedy detection, even, than the defaced comb, comes from the particles of comb, intermingled with the powder-like droppings of the caterpillars, which will always be seen on the bottom-board in case the moth-larvæ are at work. Soon, in three or four weeks, the larvæ are full grown (Fig. 169). Now the six jointed, and the ten prolegs—making sixteen in all, the usual number possessed by caterpillars—are plainly visible. These larvæ are about an inch

long, and show by their plump appearance that *they at least* can digest comb. They now spin their cocoons, either in some crevice about the hive, or, if very numerous, singly (Fig. 170, *a*) or in clusters (Fig. 170, *b*) on the comb, or even in the drone-cells (Fig. 170, *c*), in which they become pupæ, and in two weeks, even less sometimes, during the extreme heat of summer, the moths again appear. In winter they may re-

FIG. 169.

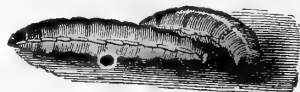

main as pupæ for months. The moths or millers—sometimes incorrectly called moth-millers—are of an obscure gray color, and thus so mimic old boards that they are very readily passed unobserved by the apiarist. They are about three-fourths of an inch long, and expand (Fig. 171) nearly one

FIG. 170.

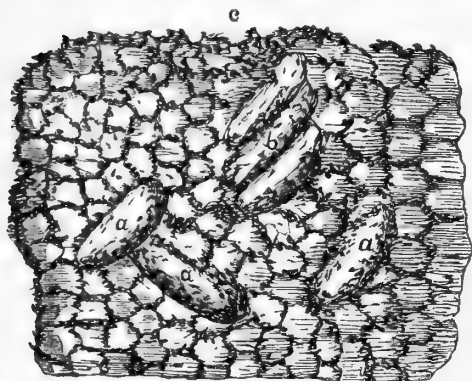

FIG. 171.



and one-fourth inches. The females are darker than the male, possess a longer snout, and are usually a little larger. The wings, when the moths are quiet, are flat on the back for a narrow space, then slope very abruptly. They rest by day, yet, when disturbed, will dart forth with great swiftness, so Réuamur styled them “nimble-footed.” They are active by night, when they essay to enter the hive and deposit their one or two hundred eggs. If the females are held in the hand

they will often extrude their eggs; in fact, they have been known to do this even after the head and thorax were severed from the abdomen, and, still more strange, while the latter was being dissected.

It is generally stated that these are two-brooded, the first moths occurring in May, the second in August. Yet, as I have seen these moths in every month from May to September, and as I have proved by actual observation that they may pass from egg to moth in less than six weeks, I think under favorable conditions there may be even three broods a year. It is true that the varied conditions of temperature—as the moth larvæ may grow in a deserted hive, in one with few bees, or one crowded with bee life—will have much to do with the rapidity of development. Circumstances may so retard growth and development that there may not be more than two, and possibly, in extreme cases, not more than one brood in a season.

It is stated by Mr. Quinby that a freezing temperature will kill these insects in all stages, while Mr. Betsinger thinks that a deserted hive is safe; neither of which assertions is correct. I have seen hives whose bees were killed by the severe winter, crowded with moth pupæ or chrysalids the succeeding summer. I have subjected both larvæ and pupæ to the freezing temperature without injuring them. I believe, in very mild winters, the moth and the chrysalids might be so protected as to escape unharmed, even outside the hive. It is probable, too, that the insects may pass the winter in any one of the various stages.

HISTORY.

These moths were known to writers of antiquity, as even Aristotle tells of their injuries. They are wholly of oriental origin, and are often referred to by European writers as a terrible pest. The late Dr. Kirtland, the able scientist, and first President of our American Bee Convention, once said in a letter to Mr. Langstroth that the moth was first introduced into America in 1805, though bees had been introduced long before. They first seemed to be very destructive. It is quite probable, as has been suggested, that the bees had to learn to fear and repel them; for, unquestionably, bees do grow in wisdom. In fact, may not the whole of instinct be inherited knowledge, which once had to be acquired by the animal? Surely bees and other

animals learn to battle new enemies, and vary their habits with changed conditions, and they also transmit this knowledge and their acquired habits to their offspring, as illustrated by setter and pointer dogs. In time, may not this account for all those varied actions, usually ascribed to instinct? At least, I believe the bee to be a creature of no small intelligence.

REMEDIES.

In Europe, late writers give very little space to this moth. Once a serious pest, it has now ceased to alarm, or even disquiet the intelligent apiarist. In fact, we may almost call it a blessed evil, as it will destroy the bees of the heedless, and thus prevent injury to the markets by their unsalable honey, while to the attentive bee-keeper it will work no injury at all. Neglect and ignorance are the moth breeders.

As already stated, Italian bees are rarely injured by moths, and strong colonies never. As the enterprising apiarist will only possess these, it is clear that he is free from danger. The intelligent apiarist will also provide not only against weak, but queenless colonies as well, which from their abject discouragement are the surest victims to moth invasion. Knowing that destruction is sure, they seem, if not to court death, to make no effort to delay it.

As my friend, Judge J. H. Andrews, asserts, no bees, black or Italian, will be troubled with these insects so long as all the combs are covered with bees.

In working with bees an occasional web will be seen glistening in the comb, which should be picked out with a knife till the manufacturer—the ruthless larva—is found, when it should be crushed. Any larva seen about the bottom board, seeking place to spin its cocoon, or any pupæ, either on comb or in a crack, should also be killed. If, through carelessness, a colony has become thoroughly victimized by these filthy wax devourers, then the bees and any combs not attacked should be transferred to another hive, after which the old hive should be sulphured by use of the smoker, as before described then by giving one or two each of the remaining combs to strong colonies, after killing any pupæ that may be on them, they will be cleaned and used, while by giving the enfeebled colony brood; and if necessary a good queen, if it has any vigor remaining it will soon be rejoicing in strength and prosperity.

We have already spoken of caution as to comb honey and frames of comb, and so need not speak further of them.

TWO DESTRUCTIVE BEETLES.

There are two destructive beetles that often work on the comb, more, however, for the pollen and dead bees than for the wax. One of these, *Tenebrionellus molitor*, Linn., is the common flour or meal beetle. It is dark brown in color, and five-eighths of an inch (16 mm.) long. The larva or grub is of a lighter color and when fully developed is one inch (25 mm.) long. It resembles very closely the larva of our Elater beetles—the wire worms.* The other is the bacon beetle, *Dermestes lardarius*, Linn., which is a sore pest in museums, as it feeds on all kinds of dried animal tissues. The beetle is black, while nearly one-half of the wing covers, next to the thorax, are yellowish gray, lined in the middle with black. The beetle is three-eighths of an inch (10 mm.) long. The larva is some longer, very hairy, and ringed with brown and black bands. These beetles are not very troublesome in the apiary and can be readily destroyed by use of bisulphide of carbon. Care is necessary, however, in the use of this very explosive liquid.

ROBBER FLIES.

There are several of these flies that prey upon bees. The

FIG. 172.



most common is *Asilus Missouriensis*, Riley. This is a two-winged fly, of the predacious family *Asilidæ*, which attacks

and takes captive the bee and then feeds upon its fluids. It is more common in the southern part of our country. The fly (Fig. 172) has a long, pointed abdomen, strong wings, and is very powerful. I have seen an allied species attack and overcome the powerful tiger-beetle, whereupon I took them both with my net, and now have them pinned, as they were captured, in our College cabinet. These flies delight in the warm sunshine, are very quick on the wing, and so are not easily captured. It is to be hoped that they will not become very numerous. If they should, I hardly know how they could be kept from their evil work. Frightening them or catching with a net might be tried, yet these methods would irritate the bees, and need to be tried before they are recommended. I have received specimens of this fly from nearly every Southern State. During the past summer this same fly has been well employed here in Michigan. It has been observed to kill the cabbage butterflies by scores.

I have also a fly of the same family, with the same bee-destroying habits, a species of *Erax* (Fig. 173). In form it re-

FIG. 173.



FIG. 174, a.



FIG. 174.



sembles the one referred to above. The wing (Fig. 174), as will be seen, is quite different in its venation. I received this species from Louisiana. Fig. 174, a, shows the antennæ magnified. The Nebraska bee-killer, *Promachus bastardi*, is the same in general appearance as the above. The second vein of the primary wing, not the third, as in case of *Asilus*, forks. In *Erax*, as seen in the figure, this branch is disconnected.

There are two other insects of this family, *Mallophora orcina* and *Mallophora bomboides*, which differ greatly in form from those mentioned above; they look more like bumble-bees, for which they have been mistaken.

I have received these insects from several of our enterprising bee-keepers of the South—Tennessee, Georgia, and Flor-

FIG. 175.

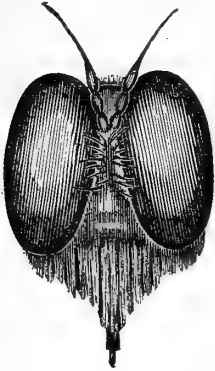

FIG. 176.



ida—with the information that they dart forth from some convenient perch, and with swift and sure aim grasp a bee, and bear it to some bush, when they leisurely suck out all but the mere crust and cast away the remains.

The insects in question belong to Loew's third group, *Asilina*, as the antennæ end in a bristle (Fig. 175), while the sec-

FIG. 177.

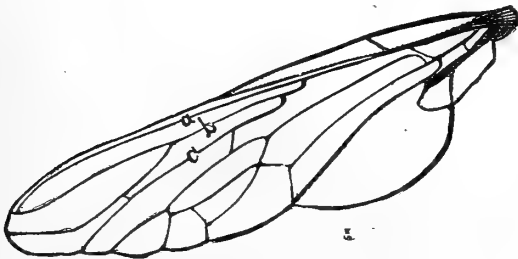

ond longitudinal vein of the wing (Fig. 177, *b*) runs into the first (Fig. 177, *a*).

The genus is *Mallophora*. The venation of the wings much resembles that of the genus *Promachus*, though the form of these insects is very different.

In *Mallophora* and *Promachus* the venation is as represented in Fig. 177, where, as will be seen, the second vein (Fig. 177, *b*) forks, while in the genus *Asilus* (Fig. 172) the third vein is forked, though in all three genera the third joint of the antennæ (Fig. 175) ends in a prolonged bristle.

One of the most common of these pests, which I am informed by Dr. Hagen is *Mallophora orcina*, Weid., (Fig. 178) is one inch long, and expands one and three-fourths inches (Fig. 179). The head (Fig. 175) is broad, the eyes black and prominent, the antennæ three-jointed, the last joint terminating in a bristle, while the beak is very large, strong, and, like the eyes and antennæ, coal black. This is mostly concealed by the light yellow hairs, which are crowded thick about the mouth and between the eyes.

The thorax is prominent and thickly set with light yellow hairs. The abdomen is narrow, tapering, and covered with

FIG. 178.



FIG. 179.



yellow hairs except the tip, which is black. Beneath, the insect is clear black, though there are scattering hairs of a grayish yellow color on the black legs. The pulvilli, or feet pads (Fig. 176, *b*), are two in number, bright yellow in color, surmounted by strong, black claws (Fig. 176, *a*), while below and between is the sharp spine (Fig. 176, *c*), technically known as the empodium.

The habits of the flies are interesting, if not to our liking. Their flight is like the wind, and perched near the hive, they rush upon the unwary bee returning to the hive with its full load of nectar, and grasping it with their hard strong legs,

they bear it to some perch near by, when they pierce the crust, suck out the juices, and drop the carcass, and are then ready to repeat the operation. A hole in the bee shows the cause of its sudden taking off. The eviscerated bee is not always killed at once by this rude onslaught, but often can crawl some distance away from where it falls, before it expires.

Another insect nearly as common is the *Mallophora bomboides*, Weid. This fly might be called a larger edition of the one just described, as in form, habits, and appearance, it closely resembles the other. It belongs to the same genus, possessing all the generic characters already pointed out. It is very difficult to capture them, as they are so quick and active.

This fly is one and five-sixteenths inches long, and expands two and a half inches. The head and thorax are much as in the other species. The wings are very long and strong, and, as in the other species, are of a smoky brown color. The abdomen is short, pointed, concave from side to side on the under surface, while the grayish yellow hairs are abundant on the legs and whole under portion of the body. The color is a lighter yellow than in the other species. These insects are powerfully built, and if they become numerous must prove a formidable enemy to the bees.

Another insect very common and destructive in Georgia, though it closely resembles the two just described, is of a different genus. It is the *Laphria thoracica* of Fabricius. In this genus the third vein is forked, and the third joint of the antenna is without the bristle, though it is elongated and tapering. The insect is black, with yellow hair covering the upper surface of the thorax. The abdomen is wholly black both above and below, though the legs have yellow hairs on the femurs and tibiæ. This insect belongs to the same family as the others, and has the same habits. It is found North as well as South.

THE STINGING-BUG.—*Phymata Erosa*, Fabr.

This insect is very widely distributed throughout the United States. I have received it from Maryland to Missouri on the South, and from Michigan to Minnesota on the North. The insect will lie concealed among the flowers, and upon occasion will grasp a bee, hold it off at arm's length, and suck out its blood and life.

This is a Hemipteron, or true bug, and belongs to the family *Phymatidæ*, Uhler. It is the *Phymata erosa*, Fabr., the specific name *erosa* referring to its jagged appearance. It is also called the "stinging bug," in reference to its habit of repelling intrusion by a painful thrust with its sharp, strong beak.

The "stinging bug" (Fig. 180) is somewhat jagged in appearance, about three-eighths of an inch long, and generally of a yellow color, though this latter seems quite variable.

FIG. 180.



Side view, natural size.

FIG. 181.



Magnified twice.

FIG. 182.

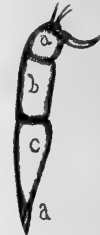

Beak, much magnified.

Frequently there is a distinct greenish hue. Beneath the abdomen, and on the back of the head, thorax, and abdomen, it is more or less specked with brown; while across the dorsal

FIG. 183.



Antenna much magnified.

FIG. 184.

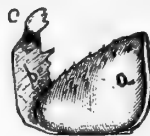

Interior view.

FIG. 185.



Exterior view.

Anterior leg magnified.

aspect of the broadened abdomen is a marked stripe of brown (Fig. 181, *d, d*). Sometimes this stripe is almost wanting, sometimes a mere patch, while rarely the whole abdomen is very slightly marked, and as often we find it almost wholly

brown above and below. The legs (Fig. 181, *b*), beak and antennæ (Fig. 181, *a*), are greenish yellow. The beak (Fig. 182) has three joints (Fig. 182, *a, b, e*), and a sharp point (Fig. 182, *d*). This beak is not only the great weapon of offense, but also the organ through which the food is sucked. By the use of this, the insect has gained the soubriquet of "stinging bug." This compact jointed beak is peculiar to all true bugs, and by observing it alone we are able to distinguish all the very varied forms of this group. The antenna (Fig. 183) is four-jointed. The first joint (Fig. 183, *a*) is short, the second and third (Fig. 183, *b* and *c*) are long and slim, while the terminal one (Fig. 183, *d*) is much enlarged. This enlarged joint is one of the characteristics of the genus Phymata, as described by Latreille. But the most curious structural peculiarity of this insect and the chief character of the genus Phymata, is the enlarged anterior legs (Figs. 184 and 185). These, were they only to aid in locomotion, would seem like awkward, clumsy organs, but when we learn that they are used to grasp and hold their prey, then we can but appreciate and admire their modified form. The femur (Fig. 184, *b*) and the tarsus (Fig. 184, *a*) are toothed, while the latter is greatly

FIG. 187.

FIG. 186.

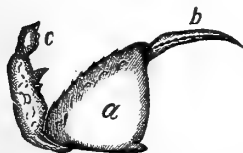

Claw, enlarged.

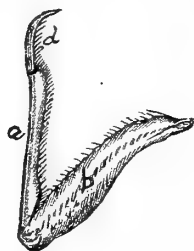

Middle leg, much magnified.

enlarged. From the interior lower aspect of the femur (Fig. 186) is the small tibia, while on the lower end of the tarsus (Fig. 185, *d*) is a cavity in which rests the single claw. The other four legs (Fig. 187) are much as usual.

This insect, as already intimated, is very predacious, lying in wait, often almost concealed, among flowers, ready to capture and destroy unwary plant-lice, caterpillars, beetles, but-

terflies, moths, and even bees and wasps. We have already noticed how well prepared it is for this work by its jaw-like anterior legs, and its sharp, strong, sword-like beak.

It is often caught on the golden rod. This plant, from its color, tends to conceal the bug, and from the character of the plant—being attractive as a honey plant to bees—the slow bug is enabled to catch the spry and active honey-bee.

As Prof. Uhler well says of the “stinging-bug:” “It is very useful in destroying caterpillars and other vegetable-feeding insects, but is not very discriminating in its tastes, and would as soon seize the useful honey-bee as the pernicious saw-fly.” And he might have added that it is equally indifferent to the virtues of our friendly insects like the parasitic and predacious species.

We note, then, that this bug is not wholly evil, and as its destruction would be well-nigh impossible, for it is as widely scattered as are the flowers in which it lurks, we may well rest its case, at least until its destructiveness becomes more serious than at present.

BEE-HAWK.—*Libellulae.*

These large, fine, lace-wings are neuropterous insects. They work mostly in the Southern States and are called Mosquito-hawks. Insects of this genus are called dragon flies, devil's darning-needles, etc. These are exceedingly predacious. In fact, the whole sub-order is insectivorous. From its four netted, veined wings, we can tell it at once from the asilus flies before mentioned, which have but two wings. The Bee or Mosquito-hawks, are resplendent with metallic hues, while the Bee-killers are of sober gray. The Mosquito-hawks are not inaptly named, as they not only prey upon other insects, swooping down upon them with the dexterity of a hawk, but their graceful gyrations, as they sport in the warm sunshine at noon-day, are not unlike those of our graceful hawks and falcons. These insects are found most abundant near water, as they lay their eggs in water, where the larvæ live and feed upon other animals. The larvæ are peculiar in breathing by gills in the rectum. The same water that bathes these organs and furnishes oxygen, is sent out in a jet, and thus sends the insect darting along. The larvæ also possess enormous jaws, which formidable weapons are masked till it is desired to use

them, when the dipper-shaped mask is dropped or unhinged and the terrible jaws open and close upon the unsuspecting victim, which has but a brief time to bewail its temerity.

A writer from Georgia, in *Gleanings*, volume 6, page 35, states that these destroyers are easily scared away, or brought down by boys with whips, who soon become as expert in capturing the insects as are the latter in seizing the bees. One of the largest and most beautiful of these is *Anax junius*. It has a wide range in the United States, North and South, and everywhere preys upon the bees.

TACHINA FLY.

From descriptions which I have received, I feel certain that there is a two-winged fly, probably of the genus *Tachina* (Fig. 188), that works on bees. I have never seen these,

FIG. 188.

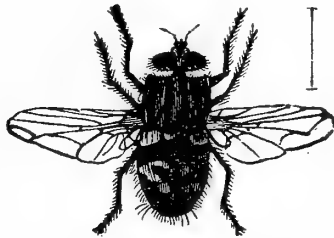

though I have repeatedly requested those who have to send them to me. My friend, Mr. J. L. Davis, put some sick looking bees into a cage, and hatched the flies which he told me looked not unlike a small house-fly. It is the habit of these flies, which belong to the same family as our house-flies, which they much resemble, to lay their eggs on other insects. Their young, upon hatching, burrow into the insect that is being victimized, and grow by eating it. It would be difficult to cope with this evil, should it become of great magnitude. We may well hope that this habit of eating bees is an exceptional one with it. The affected bees will be found dead at early dawn in front of the hives.

BEE-LOUSE.—*Braula Cæca*, Nitsch.

This louse (Fig. 189) is a wingless Dipteron, and one of the uniques among insects. It is a blind, spider-like parasite,

and serves as a very good connecting link between insects and spiders, or, still better, between the Diptera, where it belongs, and the Hemiptera, which contains the bugs and most of the lice. It assumes the semi-pupa state almost as soon as hatched,

FIG. 189.

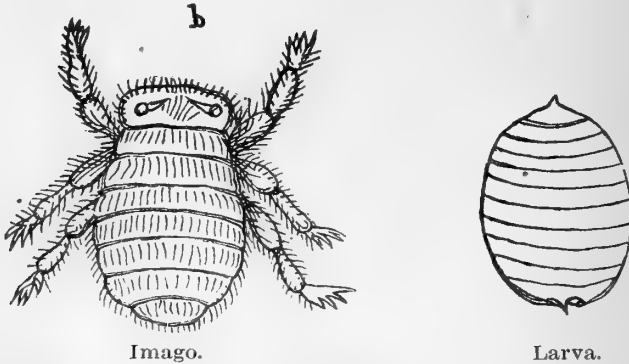

and, strangest of all, is, considering the size of the bee on which it lives and from which it sucks its nourishment, enormously large. Two or three, and sometimes as many as ten, are found on a single bee. When we consider their great size, we cannot wonder that they soon devitalize the bees.

These have done little damage except in the South of Continental Europe, Cyprus and other parts of the Orient. The reason that they have not been naturalized in other parts of Europe and in America may be owing to climate, though I think more likely it is due to improved apiculture. Mr. Frank Benton, who has had much experience with these bee lice in Cyprus, writes me that the *Braula* is no serious pest if the bees are properly cared for. "In fact, if hives are kept clean inside, and colonies supplied with young queens and kept strong, the damage done by the *Braula* is very slight if anything. In old immovable-comb hives, where the combs are black and thickened, and in case the queens are old, or where through some extraneous cause the colonies have become weak, these lice are numerous on queens and workers. I have not noticed them on the drones. Since they are found on workers as well as the queen, their removal from the latter will bring but temporary relief. About ten is the greatest number

that I have seen on one queen. I have only thought it necessary to remove them in case there were three or more on a queen. The only way to remove them is to pick them off with a knife, scissors, forceps or similar instrument. They are quick-footed and glide from one place to another like the wax-moth. I hold the queen between the thumb and first finger of the left hand, and with pocket-knife or clipping-scissors shave off the parasite. It is no easy matter to get them the first time, as when you attempt their removal they glide around to the other side of the queen so adroitly that you have to turn the queen over to try again." Mr. Benton says that it is not practicable to remove these lice by lessening the size of the entrance to the hive. He thinks that with the attention given to bees in America, the *Braula* will never become a serious pest, if introduced here.

ANTS.

These cluster about the hives in spring for warmth, and seldom, if ever, I think, do any harm. Should the apiarist feel nervous, he can very readily brush them away, or destroy them by use of any of the fly poisons which are kept in the markets. As these poisons are made attractive by adding sweets, we must be careful to preclude the bees from gaining access to them. As we should use them in spring, and as we then need to keep the quilt or honey-board close above the bees, and as the ants cluster above the brood chamber, it is not difficult to practice poisoning. One year I tried Paris green with success. There are several reports of ants entering the hives and killing the bees; even the queen is said to have been thus destroyed. In such cases, if they occur, it is best to put a sweet poisonous mixture in a box and permit the ants to enter through an opening too small to admit bees, and thus poison the ants. Or we may find the ants' nest, and with a crowbar make a hole in it, turn in this an ounce of bisulphide of carbon, and quickly plug it up. The liquid will kill the ants. This better be done when the ants are mostly in their nest.

THE COW-KILLER.

This ant-like insect, *Mutilla coccinea*, has been sent me from Illinois and the South as far as Texas. It is a formidable

enemy of the bees. The male has wings and no sting. The female has no wings, but is possessed of a powerful sting. She is an inch (25 *m*, *m*) long, very hairy, and black, except the top of her head and thorax, and a broad basal band and the tip of the upper part of her abdomen, which are bright red. A central band of black divides the red spaces of the abdomen. The entire under part of the body and all the members are black.

So hard and dense is the chitinous crust of these insects, that they enter the hives fearlessly, and unmindful of stings deliberately kill the bees and feed on the young. The males are said to sting. This is certainly a mistake. The sting is a modified ovipositor—an organ not possessed by males. These insects belong to the family Mutillidæ, so called because the females are wingless. They are closely allied in structure to the ants, which they much resemble.

THE PRAYING MANTIS.

This strange insect I have received from Indiana and other Southern and Western States. Its scientific name is *Mantis Carolina*, Linn. It is very predacious, and the female has been known to eat up her mate immediately after the sexual act. No wonder that they make our friends of the hive contribute to their support. This insect (Fig 190) is a sort of

FIG. 190.

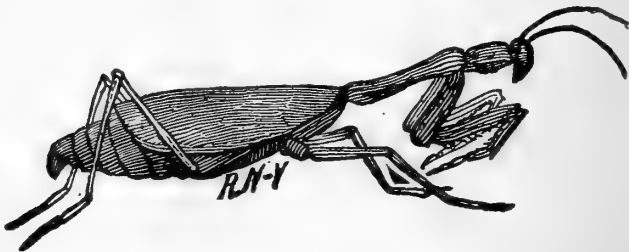

non-descript. In the South it is known as Devil's Race-Horse. It is a corpulent "walking-stick" with wings. In fact it is closely related to our own "walking-sticks" of the North. Its anterior legs are very curious. As it rests upon them, it appears as if in the attitude of devotion, hence the name Praying Mantis. It might well be preying mantis. These pecu-

liar anterior legs, like the same in *Phymata erosa*, are used to grasp its victims. It is reported to move with surprising rapidity, as it grasps its prey.

Its eggs (Fig. 191) are glued to some twig, in a scale-like mass, and covered with a sort of varnish. Some of these

FIG. 191.

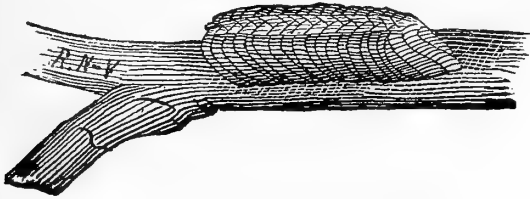

hatched out in one of my boxes, and the depravity of these insects was manifest in the fact that those first hatched fell to and ate the others.

BLISTER BEETLES.

I have received from Mr. Rainbow, of Fall Brook, California, the larvæ (Fig. 192, *a*) of some blister beetles, probably *Melœ barbarus*, Lec., as that is a common species in Califor-

FIG. 192.

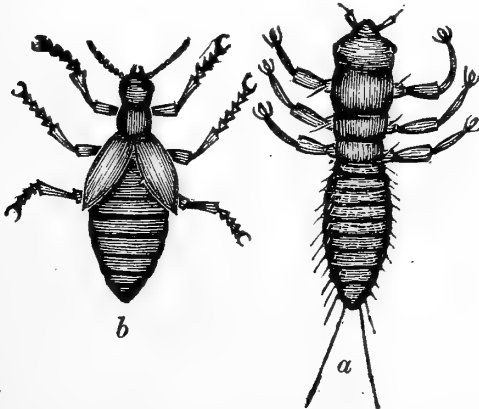

nia. Mr. Rainbow took as many as seven from one worker bee. Fig. 192, *b*, represents the female of *Melœ angusticollis*, a common species in Michigan and the East. As will be seen,

the wing covers are short, and the beetle's abdomen fairly drags with its weight of eggs. The eggs are laid in the earth. The larvæ when first hatched crawl upon some flower, and as occasion permits, crawl upon a bee and thus are borne to the hive, where they feast on eggs, honey, and pollen. These insects undergo what M. Faber styles hyper-metamorphosis, as the larva appears in four different forms instead of one. The Spanish fly—*Cantharides* of the shops—is an allied insect. Some of our common blister beetles are very destructive to plants.

WASPS.

I have never seen bees injured by wasps. In the South, as in Europe, we hear of such depredations. I have received wasps, sent by our southern brothers, which were caught destroying bees. The wasp sent me is the large handsome *Stizus speciosus*, Drury. It is black, with its abdomen imperfectly ringed with yellow. The wasps are very predacious, and do immense benefit by capturing and eating our insect pests. I have seen wasps carry off "currant-worms" with a celerity that was most refreshing.

As the solitary wasps are too few in numbers to do much damage—even if they ever do any—any great damage which may occur would doubtless come from the social paper-makers. In this case, we have only to find the nests and apply the torch, or hold the muzzle of a shot-gun to the nest and shoot. This should be done at nightfall when the wasps have all gathered home. Let us not forget that the wasps do much good, and so not practice wholesale slaughter unless we have strong evidence against them.

SPIDERS.

These sometimes spread their nets so as to capture bees. If porticoes—which are, I think, worse than a useless expense—are omitted, there will very seldom be any cause for complaints against the spiders, which on the whole are friends. As the bee-keeper who would permit spiders to worry his bees would not read books, I will discuss this subject no further.

THE KING BIRD—*Tyrannus Carolinensis*.

This bird, often called the bee-martin, is one of the fly-catchers, a very valuable family of birds, as they are wholly

insectivorous, and do immense good by destroying our insect pests. The king bird is the only one of them in the United States that deserves censure. Another, the chimney swallow of Europe, has the same evil habit. Our chimney swallow has no evil ways. I am sure, from personal observation, that these birds capture and eat the workers, as well as drones; and I dare say, they would pay no more respect to the finest Italian queen. Yet, in view of the good that these birds do, unless they are far more numerous and troublesome than I have ever observed them to be, I should certainly be slow to recommend the death warrant.

TOADS.

The same may be said of the toads, which may often be seen sitting demurely at the entrance of the hives, and lapping up the full-laden bees with the lightning-like movement of their tongues, in a manner which can but be regarded with interest, even by him who suffers loss. Mr. Moon, the well known apiarist, made this an objection to low hives; yet, the advantage of such hives far more than compensates, and with a bottom-board, such as described in the chapter on hives, we shall find that the toads do very little damage.

MICE.

These little pests are a consummate nuisance about the apiary. They enter the hives in winter, mutilate the comb, irritate, perhaps destroy, the bees, and create a very offensive stench. They often greatly injure comb which is outside the hive, destroy smokers, by eating leather off the bellows, and if they get at the seeds of honey plants, they never retreat till they make complete the work of destruction.

In the house and cellar, unless they are made as they should always be—mouse proof, these plagues should be, by use of cat or trap, completely exterminated. If we winter on the summer stands, the entrance should be so contracted that mice cannot enter the hive. In case of packing as I have recommended, I should prefer a more ample opening, which may be safely secured by taking a piece of wire cloth or perforated tin or zinc, and tacking it over the entrance, letting it come within one-fourth of an inch of the bottom-board. This will give more air, and still preclude the entrance of these miserable vermin.

SHREWS.

These are mole-like animals, and look not unlike a mouse with a long pointed nose like the moles, to which they are closely related. They are insectivorous and have needle shaped teeth, quite unlike those of the *Rodentia* which includes the true mice. I have received from Illinois and Missouri species of the short-tailed shrews—*Blarina*—which enter the hives in winter and eat the bees, only refusing the head and wings. They injure the combs but little. As they will pass through a space three-eighths of an inch wide, it is not easy to keep them out of hives where the bees are wintered on their summer stands. I have received a short-tailed shrew, *Blarina brevicauda*, Gray, which was taken in the hives by Mr. Little, of Illinois.

CHAPTER XXI.

CALENDAR AND AXIOMS.

WORK FOR DIFFERENT MONTHS.

Though every apiarist will take one, at least, of the several excellent journals relating to this art, printed in our country, in which the necessary work of each month will be detailed, yet it may be well to give some brief hints in this place.

These dates are arranged for the Northern States, where the fruit trees blossom about the first of May. By noting these flowers, the dates can be easily changed to suit any locality.

JANUARY.

During this month the bees will need little attention. Should the bees in the cellar or depository become uneasy, which will not happen if the requisite precautions are taken, and there comes a warm day, it were well to set them on their summer stands, that they may enjoy a purifying flight. At night when all are again quiet return them to the cellar. While out I would clean the bottom-boards, especially if there are many dead bees. This is the time to read, visit, study, and plan for the ensuing season's work.

FEBRUARY.

No advice is necessary further than that given for January, though if the bees have a good fly in January, they will scarcely need attention in this month. The presence of snow on the ground need not deter the apiarist from giving his bees a flight, providing the day is warm and still. It is better to let them alone if they are quiet.

MARCH.

Bees should still be kept housed, and those outside still retain about them the packing of straw, shavings, etc. Frequent flights do no good, and wear out the bees. Colonies that are uneasy and besmear their hives should be set out and allowed a good flight and then returned.

APRIL.

Early in this month the bees may all be set out. It will be best to feed all, and give all access to flour, when they will work at it, though usually they can get pollen as soon as they can fly out to advantage. Keep the brood chamber contracted so that the frames will all be covered, and cover well above the bees to economize heat.

The colony or colonies from which we desire to rear queens and drones should now be fed, to stimulate breeding. By careful pruning, too, we may and should prevent the rearing of drones in any but the best colonies. If from lack of care the previous autumn, any of our stocks are short of stores, now is when it will be felt. In such cases feed either honey, sugar, or syrup, or place candy on top of the frames beneath the oil-cloth cover.

MAY.

Prepare nuclei to start extra queens. Feed sparingly till bloom appears. Give room for storing. Extract if necessary, and keep close watch, that you may anticipate and forestall any attempt to swarm. Now, too, is the best time to transfer.

JUNE.

Keep all colonies supplied with vigorous, prolific queens. Divide the colonies as may be desired, especially enough to prevent attempts at swarming. Extract if necessary, or best, adjust frames or sections, if comb honey is desired, and be sure to keep all the white clover honey, in whatever form taken, separate from all other. Now is the best time to Italianize.

JULY.

The work this month is about the same as that of June. Supersede all poor and feeble queens. Keep the basswood honey by itself, and remove boxes or frames as soon as full. Be sure that queens and workers have plenty of room to do their best, and do not suffer the hot sun to strike the hives.

AUGUST.

Do not fail to supersede impotent queens. Between basswood and fall bloom it may pay to feed sparingly. Give plenty of room for queen and workers, as fall storing commences.

SEPTEMBER.

Remove all surplus boxes and frames as soon as storing ceases, which usually occurs about the middle of this month; feed sparingly till the first of October. If necessary to feed honey or sugar for winter, it should be done the last of this month.

OCTOBER.

Prepare colonies for winter. See that all have at least thirty pounds, by weight, of good, capped honey, and that all are strong in bees. Contract the chamber by using division boards and cover well with the cloth cover and chaff cushion. If the bees are to be packed, it should be done in October. Be sure that the frames of comb have a central hole through which the bees can pass.

NOVEMBER.

Before the cold days come, remove the bees to the cellar or depository, or place them in the clamp or earth.

DECEMBER.

Now is the time to make hives, honey-boxes, etc., for the coming year. Also labels for hives. These may just contain the name of the colony, in which case the full record will be kept in a book; or the label may be made to contain a full register as to time of formation, age of queen, etc., etc. Slates are also used for the same purpose.

I know from experience that any who heed all of the above may succeed in bee-keeping—may win a double success—receive pleasure and make money. I feel sure that many experienced apiarists will find advice that it may pay to follow. It is probable that errors abound, and certain that much remains unsaid, for of all apiarists it is true that what they do not know is greatly in excess of what they do know.

AXIOMS.

The following axioms, given by Mr. Langstroth, are just as true to-day as they were when written by that noted author:

There are a few *first principles* in bee-keeping which ought to be as familiar to the Apiarist as the letters of the alphabet.

First. Bees gorged with honey never volunteer an attack.

Second. Bees may always be made peaceable by inducing them to accept of liquid sweets.

Third. Bees, when frightened by smoke or by drumming on their hives, fill themselves with honey and lose all disposition to sting, unless they are hurt.

Fourth. Bees dislike any *quick* movements about their hives, especially any motion which *jars* their combs.

Fifth. In districts where forage is abundant only for a short period, the largest yield of honey will be secured by a *very* moderate increase of stocks.

Sixth. A moderate increase of colonies in any one season, will, in the long run, prove to be the easiest, safest, and cheapest mode of managing bees.

Seventh. Queenless colonies, unless supplied with a queen, will inevitably dwindle away, or be destroyed by the bee-moth, or by robber-bees.

Eighth. The formation of new colonies should ordinarily be confined to the season when bees are *accumulating* honey; and if this, or any other operation, must be performed when forage is scarce, the greatest precautions should be used to prevent robbing.

The essence of all profitable bee-keeping is contained in Oettl's Golden Rule: KEEP YOUR STOCKS STRONG. If you cannot succeed in doing this, the more money you invest in bees, the heavier will be your losses; while, if your stocks are strong, you will show that you are a *bee-master*, as well as a bee-keeper, and may safely calculate on generous returns from your industrious subjects.

“Keep all colonies strong.”

GENERAL INDEX.

	PAGE		PAGE
A B C of Bee Culture	12	Barberry	262
Acacia	265	figure of.....	262
Albino Bees.....	37	Bark louse.....	249
Alighting board.....	126	figure of.....	249
figure of	126	how to destroy.....	250
Alimentary canal.....	55	Barrels	213
figure of	55	waxing.....	213
Alsike clover.....	266	Basil—Mt. Mint.....	285
figure of	268	Bass-wood.....	278
time of bloom changed.....	267	figure of.....	279
Amateur Bee-keepers	1, 5	Bee Books (see books).....	11
American Bee Journal.....	9	Bee bread (see pollen).....	107
Anatomy and physiology.....	43	Bee glue (see propolis).....	109
of bees.....	66	Bee hawk.....	324
of insects.....	43	Bee house.....	300, 305
Anatomy of insects.....	43	figure of	306
external.....	43	for winter.....	300
internal.....	52	Bee-keepers' Exchange.....	11
Antennæ of insects.....	46	Bee-keepers' Guide.....	11
use of	47, 49	Bee-keepers' and Poultry Jour- nal	11
Ants	24, 251, 327	Bee keeping.....	2
enemies of bees.....	327	how to commence.....	113
fondness for plant lice.....	251	form a plan.....	114
Apathus.....	29	get bees.....	114
Apiary—		kind of hives.....	115
arrangement of.....	152	kind to buy.....	115
grape vine.....	153	price to pay.....	116
figure of	154, 155	when to buy.....	115
location of	116	where to locate.....	116
position of.....	152	as to forage.....	117
starting an.....	113	as to market.....	117
Apiary grounds.....	152	as to society.....	116
arrangement of.....	152	inducements to.....	2
for each colony.....	153	adaptation to amateurs.....	5
Apidæ.....	25	adaptation to women.....	5
description of.....	26	adds wealth to the coun- try.....	8
larva of.....	26	excellent as an avoca- tion.....	5
parasites among.....	24, 26	excellent for mental cul- ture.....	7
Apis.....	30	furnishes good food.....	7
Apis dorsata.....	32	profits from.....	3
nativity of.....	34	recreation	2
search for.....	32	requirements for successful.....	8
Aristotle	39	aid from associations.....	9
Arthropoda.....	20	aid from books and pa- pers.....	9
Articulate animals.....	19	experience	8
Artificial increase.....	190	enthusiasm	14
Asparagus	285	mental effort.....	8
Asters.....	289	persistence	15
figure of.....	289		
Axioms	336		
Bacon Beetle.....	317		
Banana.....	265		

Index.

PAGE	PAGE
promptitude.....	14
visits to others.....	9
Bee killers.....	317
Georgia.....	319
figure of.....	319, 320
Louisiana.....	318
figure of.....	318
Missouri.....	317
figure of.....	317
Nebraska.....	318
Bee louse.....	325
figure of.....	326
Bee moth.....	312
cocoons of.....	314
figure of.....	314
galleries of.....	313
figure of.....	313
history of.....	315
imago of.....	314
figure of.....	314
larva of.....	313
figure of.....	814
natural history of.....	313
remedies for.....	316
Bee papers (see papers).....	9
Bee poison—	
inoculation with.....	2
Bees—	
collections of.....	30
how to move.....	204
induced into sections.....	216
kinds in each colony.....	66
never injurious to bloom.....	254
sold by the pound.....	246
species of.....	34
to quiet.....	220
by smoke.....	221
other ways.....	221
valuable to plants.....	254
who may keep.....	1
amateurs.....	1
specialists.....	1
who should not keep.....	2
Beetles.....	317
destructive.....	317
bacon.....	317
meal.....	317
Bee tent.....	212, 224
figure of.....	212, 225
Bee trees.....	162
how to find.....	162
Bee veil.....	219
figure of.....	219
Beggar ticks.....	289
Benton, Frank.....	32
effort to get <i>A. dorsata</i>	32
experience with other bees..	34
importing bees.....	32
Bergamont.....	284
Bevel gauge.....	125
figure of.....	125
Bibliography.....	39, 110
Bingham smoker.....	222
figure of.....	221
Black bees.....	35
points of superiority.....	195
Blackberry.....	275
Black gum.....	265
Black sage.....	262
figure of.....	263
Blister beetles.....	329
figure of.....	329
Blood of insects.....	54
Blood root.....	259
Blue thistle—viper's bugloss.....	285
Bombus.....	27
Bonnet.....	41
Boneset.....	283
figure of.....	282
Books.....	11
A B C of Bee Culture.....	11
Apiary, or Bees and Honey..	13
Bee-keeper's Guide Book.....	13
Bees and Honey.....	12
Bevan on the Honey Bee.....	13
Blessed Bees.....	13
Dzierzon's Rational Bee	
Keeping.....	13
King's Text Book.....	12
Langstroth on the Honey	
Bee.....	11
Manual of Bee Keeping.....	13
Mysteries of Bee Keeping....	12
Quinby's Mysteries.....	12
Rational Bee Keeping.....	13
Text Book.....	12
On Botany.....	291
On Entomology.....	42, 110
Borage.....	269
figure of.....	269
Borers in locust.....	275
Botany.....	291
Bessey's.....	291
Gray's.....	291
Bottom board.....	125
figure of.....	126
stationary.....	127
Box hives.....	118
Branch arthropoda.....	20
Branch of the honey Bee.....	19
Breathing system.....	21, 54
figure of.....	21
British Bee Journal.....	13
Buckthorn.....	265
Buckwheat.....	288
figure of.....	288
Bumble Bees.....	27
Burying Bees.....	303
Button bush.....	285
figure of.....	283
Cages.....	202
Peet.....	202
figure of.....	203
Caging queens.....	198
Judge Andrews' method.....	198
Calendar.....	333
Candy.....	203
Good.....	203
Viallon.....	203
Carniolan Bees.....	38
Carpenter Bees.....	28

Index.

	PAGE		PAGE
Catalpa	285	Young's	201
Catnip	271, 285	figure of	201
Caucasian	38	Conventions	9, 240
Cellar	301	aid markets	240
for wintering	301	valuable	9
Chaff hives	298	Coleoptera	24
advantages of	298	Columella	39
figure of	133, 299	Corn	275
rules for use	299	Cotton	276
Chloroform	223	figure of	277
to introduce queen	223	Cow pea	252, 276
to quiet bees	223	figure of	252
Circulatory organs	52	Cow killer	327
Clamps for wintering	303	Crate	24
Clark cold draft smoker	222	shipping	244
figure of	222	figure of	244, 245
Class of the honey-bee	20	Crustacea	19, 20
Clipping queens	177	Culver's root	285
why done	177	Cuvier	42
how done	178	Cyprian Bees	37, 196
Clover—		importation of	37
Alsike	266	points of superiority	37
Mammoth	275	Dadant	243
Sweet	267	pamphlet of	243
White	266	Dalmatian Bees	38
Cold draft smoker	222	Dandelion	259
figure of	222	De Geer	40
Colonies—		Digestive apparatus	55
how to move	204	figure of	55
Cover—		Diptera	23
for frames	135	Diseases of bees	309
cloth	135	Dissection of insects	45, 61
honey-board	136	microscopes for	46
for hive	129	figure of	46
figure of	129	Dividing	190
Comb	103	Division boards	136
cells of	105	figure of	133, 136
figure of	104	of perforated zinc	147
function of	106	figure of	146
how to fasten	160	Dollar Queens	201
figure of	160	rearing of	202
why opaque	106	Doolittle—income from bees	4
Comb-box or basket	211	Drones	79
figure of	211	development of	81
Comb foundation	226	figure of	80
American	227	function of	82
figure of	226	jaws of	80
history of	226	figure of	88
machines	227	leg of	80
roller	227	figure of	80
figure of	228	mating of	81
press	229	organs of	80
figure of	229	figure of	58
Comb-honey	243	pure if queen is	82
apparatus for procuring	141	Dunham foundation machine	228
desirable	214	figure of	228
fumigation of	217, 243	Dysentery	309
high priced	243	Dzierzon	74
how secured	214	theory of	74
marketing of	243	Dzierzon's Rational Bee-keep- ing	13
rules for	243	Eggs of insects	62
shipping crate for	244	development of	62
stored before shipping	217	figure of	64
Comb stands	200		
Valentine's	200		
figure of	200		

Index.

	PAGE		PAGE
Egyptian Bees.....	38	Feeding.....	163
Enemies of bees.....	312	caution in.....	168
ants.....	327	how much.....	163
bacon beetles.....	317	how done.....	164
bee hawks.....	324	in winter.....	295
bee killers.....	317	reason for.....	163
blister beetles.....	329	what.....	164
cow killer.....	327	Female organs.....	60
king bird.....	330	figure of.....	59
louse.....	325	Fertile workers.....	84
meal beetle.....	317	remedy for.....	179
mice.....	331	when found.....	179
moth.....	312	Figwort.....	280
praying mantis.....	328	California.....	276
shrews.....	332	figure of.....	280
spiders.....	330	Fire weed.....	291
stinging bug.....	321	Food.....	164, 295
tachina fly.....	325	Foot power saw.....	150
toads.....	331	Barnes'.....	150
wasps.....	330	Foreign books and papers.....	13
Entomological books.....	42	Apiary, or Bees and Bee Cul- ture.....	13
Eyes.....	30	Bee Keepers' Guide Book.....	13
of insects.....	49	British Bee Journal.....	13
simple.....	49	Manual of Bee Keeping.....	13
compound.....	49	Modern Bee Keeping.....	13
of bees.....	30	Rational Bee Keeping.....	13
figure of.....	31	Fossil honey comb.....	106
Extracted honey.....	212	figure of.....	106, 107
barrels for.....	213	Foul brood.....	309
granulation of.....	242	cause.....	310
prevented.....	342	remedy.....	311
reduced.....	242	symptoms.....	309
how kept.....	212	Foundation.....	226
marketing.....	241	American.....	227
rules for.....	241	cutters.....	231
ripening of.....	242	figure of.....	231
tin cans for.....	213	figure of.....	226
vessels for.....	241	history of.....	226
figures of.....	241, 242	how cut.....	231
jars.....	241	how fastened.....	233
kegs.....	242	how made.....	230
pails.....	241	in wired frames.....	235
Extracting and the extractor.....	205	use of.....	231
Extractor (see honey extractor).....	206	in brood frames.....	232
figure of.....	206	in sections.....	232
wax (see wax extractor).....	236	wax sheets for.....	230
Fabricius.....	41	how made.....	230
Fairs.....	246	Fountain pump.....	250
exhibiting at.....	246	Frames.....	130
effect of.....	248	cover for.....	135
figure of.....	247	D. A. Jones'.....	133
Family Apidæ.....	25	figure of.....	133
Family of Honey Bee.....	25	figure of.....	130, 132
Feeders.....	163	for sections.....	145
can.....	165	figure of.....	144
close bottom board for.....	167	Gallup.....	131
division board.....	165	figure of.....	130
figure of.....	165	guide for making.....	134
Shuck's.....	166	figure of.....	135
figure.....	166	how made.....	132
Simplicity.....	166	Langstroth.....	131
figure of.....	166	figure of.....	130
Smith's.....	167	large.....	131, 146
figure of.....	167	Quinby.....	130

Index.

PAGE	PAGE
figure of.....	130
uniform.....	131
wiring.....	133
Genus apis.....	30
species of.....	31, 34
Genus of the Honey Bee.....	30
Geoffrey.....	40
German Bees.....	35
Gill or ground ivy.....	275
Given press.....	229
figure of.....	229
Glands of insects.....	56, 57
Gleanings in Bee Culture.....	10
Gloves.....	219
Glucose.....	164
Golden honey plant.....	284
Golden rod.....	288
figure of.....	289
Good candy.....	203
Grapes and Bees.....	253
Gum—	
blue.....	285
red.....	285
Handling Bees.....	218
rules for.....	218
Harbison.....	4
great honey yield of.....	4
Heatherington.....	4
honey secured by.....	4
Head of insects.....	43
organs of.....	43
labium.....	43
figure of.....	67, 85
jaws.....	43
figure of.....	44, 88
maxillæ.....	45
figure of.....	44, 88
antennæ.....	46
Hearing of insects.....	47
Heart of insects.....	52
Heath Bees.....	38
Herzegovinian Bees.....	38
Hexapoda.....	22
Hives.....	118
alighting board of.....	126
figure of.....	126
Bingham.....	139
figure of.....	140
bottom board of.....	125
figure of.....	126
stationary.....	127
box.....	118
cover of.....	127
DeBeauvoys's.....	120
Dzierzon.....	120
early frame.....	119
entrance to.....	126
height of.....	127
Huber.....	137
Langstroth.....	120
figure of.....	122
movable comb.....	118
Munn.....	119
figures of.....	119, 120
new idea.....	147
not patented.....	118
observing.....	141
figure of.....	141
portico of.....	130
Quinby.....	138
figure of.....	138
Schmidt.....	120
story and one-half.....	129
figure of.....	122, 123
two story.....	128
figure of.....	122, 128
Hives and sections.....	118
Hivingswarms.....	183, 185
figure of.....	186
Honey.....	99
as food.....	7
changed nectar.....	100
composition of.....	99
granulated.....	100, 210
how to melt.....	210
test of purity.....	100
ripening of.....	100, 210
source of.....	99, 249
Honey-comb.....	103
fossil.....	106
figure of.....	106, 107
Honey extractor.....	205
how to use.....	211
modern.....	206
figure of.....	206
origin of.....	205
styles of.....	206
use of.....	208
when to use.....	209
wire attachment.....	207
figure of.....	207
Honey knives.....	208
figures of.....	208
Honey locust.....	275
figure of.....	277
Honey plants (see plants).....	249
April.....	259
May.....	261
June.....	266
July.....	278
August.....	288
table of.....	256, 257
Honey vinegar.....	246
Horehound.....	262, 271
Horse mint.....	265
figure of.....	265
House apiary.....	305
Huber hive.....	137
Bingham style.....	138
figure of.....	140
Quinby style.....	138
figure of.....	138
Hunting bee trees.....	162
Hymenoptera.....	23
highest of insects.....	24
parasitic.....	24
Ichneumon flies.....	25
Indian currant.....	291
Indian plantain.....	285

Index.

PAGE	PAGE		
Imago of insects.....	23, 65	Manual of bee keeping.....	13
Increase of colonies.....	182	Manzanita.....	261
dividing.....	189	Maples.....	259, 261
to prevent.....	184	sugar.....	261
Iron weed.....	285	figure of.....	258
Insecta.....	20	Marketing.....	239
Insects.....	22	bees by the pound.....	246
Instinct in bees and ants.....	23, 24	how caged.....	246
Intestines of bee.....	56	figures of.....	246
Italians.....	35, 192	comb honey.....	243
importation of.....	35	crates for.....	244
origin of.....	35, 37	kept for.....	244
superior.....	193	preparation for.....	244
Italianizing.....	196	extracted honey.....	240
rules for.....	239	Mason bees.....	29
Japan privet.....	265	Mating of queen.....	72
Jars for honey.....	241	delay in.....	73
figure of.....	241	in confinement.....	73
Jones, D. A.....	32	marks of.....	73
importing bees.....	32	only once.....	73
Judas tree.....	261	on wing.....	73
figure of.....	260	Matrimony vine.....	275
Kansas bee keeper.....	11	Meal.....	169
Kegs for honey.....	242	feeding of.....	169
figure of.....	242	Meal beetle.....	317
King bird.....	330	Megachile.....	28
Lamarck.....	42	Melipona.....	27
Lamp nursery.....	176	Mice.....	331
Langstroth, L. L.....	121	Microscopes.....	46
Langstroth frame.....	131	figure of.....	46
figure of.....	130	Milk weed.....	272
Langstroth hive.....	120	pollen of.....	272
figure of.....	122	figure of.....	272
size of.....	123	Mignonette.....	270
Longstroth on the honey bee.....	11	figure of.....	269
Larva of insects.....	22, 63	Mimicry.....	23
figures of.....	63, 64	Mint.....	271
Latreille.....	41	figure of.....	270
Leach.....	42	Mites.....	22
Legs of insects.....	51	Modern Bee Keeping.....	13
figure of.....	21, 89	Mollusks.....	20
Lepidoptera.....	24	Moth (see bee moth).....	312
Ligurian (see Italian).....	35	Motherwort.....	271
Linneus.....	259	figure of.....	271
Liver leaf.....	40	time of bloom changed.....	272
Locust.....	275	Mountain laurel.....	285
honey.....	275	Mouth organs.....	43
figure of.....	277	variable.....	45
Locust borer.....	275	Movable frame hives.....	128
remedy for.....	275	Munn hive.....	119
Lupine.....	275	Muscles of insects.....	52
Lyonnet.....	41	Mustard.....	273
Magnolia.....	277	black.....	273
figure of.....	278	figure of.....	272
Mailing queens.....	204	Chinese.....	273
Male organs.....	58	white.....	273
figure of.....	58	Muth C. F.....	242
Mangrove.....	286	Myriapods.....	21
black.....	286	Mysteries of Bee Keeping.....	12
true.....	288	Natural History of Bee.....	19
figure of.....	287	Nectar.....	249
Malva.....	285	from bark lice.....	249
		from cotton.....	253
		from cow pea.....	253

Index.

	PAGE		PAGE
figure of.....	253	figure of.....	289
from flowers.....	249	banana.....	265
from plant lice, see plant lice	250	barberry.....	262
from sap.....	253	figure of.....	262
Nerves of insects.....	52	basil.....	285
Nomada.....	29	bass-wood.....	278
Nuclei.....	172	figure of.....	279
hives for.....	172	beggar ticks.....	289
how formed.....	173	benefited by bees.....	254
Nursery.....	176	bergamont.....	284
lamp.....	176	blackberry.....	275
queen.....	177	black gum.....	265
Observing hive.....	141	blood root.....	259
figure of.....	141	Bokhara clover.....	267
Okra.....	270	boneset.....	283
figure of.....	270	figure of.....	282
Order of honey bee.....	23	borage.....	269
Osmia.....	29	figure of.....	269
Packing box.....	296	buck thorn.....	265
figure of.....	297	button bush.....	285
Pails for honey.....	241	figure of.....	283
figure of.....	241	buckwheat.....	288
Palmetto.....	286	figure of.....	288
cabbage.....	286	catalpa.....	285
figure of.....	286	catnip.....	271, 285
saw.....	266	corn.....	275
Papers.....	9	cotton.....	276
American Bee Journal.....	9	figure of.....	277
Bee-Keeper's Exchange.....	11	cow pea.....	252, 276
Bee-Keeper's Guide.....	11	figure of.....	252
Bee and Poultry Journal.....	11	culver's root.....	285
British Bee Journal.....	13	dandelion.....	259
Gleanings in Bee Culture.....	10	figwort.....	280
Kansas Bee-Keeper.....	11	California.....	276
Parasitic Bees.....	29	fire weed.....	291
Parthenogenesis.....	74	gill, ground ivy.....	275
seen in ants and wasps.....	74	golden honey plant.....	284
true of drones.....	74	golden rod.....	288
true of plant lice.....	74	grapes.....	253
Partridge pea.....	275	gum, blue and black.....	285
figure of.....	276	honey locust.....	275
Perforated zinc.....	147, 216	figure of.....	277
division board of.....	147	for ornament.....	291
figure of.....	146	honey poisonous.....	285
use of.....	216	horehound.....	262, 271
Periodicals (see papers).....	9	Indian currant.....	291
Persimmon.....	265	Indian plantain.....	285
Piping of queen.....	98	iron weed.....	285
Plant lice.....	250	Japan privet.....	265
apple tree.....	251	Judas tree.....	261
figure of.....	251	figure of.....	260
beech.....	250	locust.....	275
elm.....	250	honey.....	275
larch.....	250	lupine.....	275
sycamore.....	251	Magnolia.....	277
figure of.....	251	figure of.....	278
willow.....	251	Mangrove.....	286
Plants.....	249	black.....	286
acacia.....	265	true.....	288
alsike clover.....	266	figure of.....	287
figure of.....	268	Malva.....	285
asparagus.....	285	Manzanita.....	261
asters.....	289	maples.....	259, 261
		sugar.....	261
		figure of.....	258

Index.

PAGE	PAGE		
matrimony vine	275	wistaria.....	261
milk weed	272	American.....	261
pollen masses of.....	272	figure of.....	261
figure of.....	272	Chinese.....	261
mignonette	270	figure of.....	262
figure of.....	269	Pliny.....	39
mint.....	271	Plum—wild.....	274
figure of.....	270	Poisonous honey.....	285
motherwort.....	271	Pollen—bee-bread.....	107
figure of.....	271	how collected.....	108
time of bloom changed.....	272	how carried.....	108
mountain laurel.....	285	function of.....	108
mustards.....	273	source of.....	108
black.....	273	substitute for.....	169
figure of.....	272	Pollen baskets.....	30
Chinese.....	273	Pollen masses.....	272
white.....	273	figure of milkweed.....	272
okra.....	270	Poplar.....	261
figure of.....	270	Praying Mantis.....	328
palmetto.....	286	figure of.....	328
cabbage.....	286	Products of bees.....	99
figure of.....	286	comb.....	103
saw.....	266	honey.....	99
partridge pea.....	275	pollen.....	107
figure of.....	276	propolis.....	109
persimmon.....	265	wax.....	101
poplar.....	261	Profits of bee-keeping.....	3
rape.....	273	Propolis.....	109
figure of.....	273	function of.....	109
raspberry.....	274	how collected.....	109
rattle-snake weed.....	284	soluble in.....	110
rocky Mt. bee plant.....	283	source of.....	109
figure of.....	281	Protozoa.....	20
sage.....	262, 271	Pupa of insects.....	22, 64
black.....	262	figure of.....	64
figure of.....	263	Queen.....	66
white.....	262	clipping wing of.....	177
figure of.....	264	development of.....	71
saw palmetto.....	266	cause of.....	72
skunk cabbage.....	259	time for.....	72
sour wood, sorrel tree.....	285	drone eggs from.....	75
figure of.....	284	eyes of.....	68
spider plant.....	291	fecundity of.....	77, 78
figure of.....	290	figure of.....	67
St. John's Wort.....	285	food of.....	70
stone crop.....	276	from fecundated egg.....	68
sumac.....	262, 274	function of.....	77
California.....	262	how caged.....	177
sun-flower.....	289	in sections.....	216
figure of.....	289	introduction of.....	196
sweet clover.....	267	longevity of.....	76
figure of.....	269	mating of.....	175
teasel.....	275	how controlled.....	175
figure of.....	275	entrance guard.....	176
tick-seed.....	289	figure of.....	176
tulip tree.....	274	marketing of.....	245
figure of.....	274	aided by fairs.....	246
varnish tree.....	265	organs of.....	67
verbena-vervain.....	285	figure of.....	59
viper's bugloss.....	285	ovaries of.....	67
Virginia creeper.....	285	figures of.....	59
wheat.....	253	rearing of.....	169
white clover.....	266	how done.....	169
figure of.....	266	why important.....	169
wild plum.....	274		

Index.

	PAGE		PAGE
sent by mail.....	204	Sage (see white and black sage).....	262, 271
shipping of.....	202	Saws.....	150
preparation for.....	204	horse power.....	150
sterility of.....	77	figure of.....	151
sting of.....	68	foot power.....	150
tongue of.....	68	Saw flies.....	25
figure of.....	67	Saw Palmetto.....	266
when active.....	78	Saw table.....	151
where to obtain.....	201	figure of.....	151
young virgin.....	176	Scraper.....	180
easily introduced.....	176	figure of.....	180
Queen cage.....	197	Second or after swarms.....	97
figure of.....	197, 198, 203	Secretary organs.....	56, 57, 87
Queen cell.....	69	figure of.....	87
transferring of.....	174	Sections.....	142
figure of.....	174, 175	adjustment of.....	216
Queen rearing.....	69	dove-tailed.....	143
lamp nursery for.....	176	form of.....	145
select carefully.....	170	fumigating.....	243
why necessary.....	169	getting bees from.....	217
Queen register.....	180	getting bees into.....	189, 216
diagram of.....	181	glassing.....	243
Quinby's Mysteries of Bee-keep- ing.....	12	in crates.....	148
Quinby's Smoker.....	222	figure of.....	148, 149
figure of.....	221	in frames.....	145
Races of bees.....	35	figure of.....	147, 148
black or German.....	35	nailed.....	144
Carniolan.....	38	figure of.....	144
Caucasian.....	39	one piece.....	144
Cyprian.....	37	figure of.....	144
Dalmatian.....	38	one pound.....	144
Egyptian.....	38	figure of.....	144
heath.....	38	prize.....	144
Herzegovinian.....	38	figure of.....	144
Italian or Ligurian.....	35	removal of.....	217
Smyrnian.....	39	separators for.....	143
Syrian.....	37	figure of.....	143
Radiates.....	20	small.....	216
Rape.....	273	vener.....	142
figure of.....	273	block for making.....	142
Raspberry.....	274	figure of.....	142
Rational Bee-Keeping.....	13	Sense in insects.....	47
Rattle-snake root.....	284	hearing.....	47
Ray.....	39, 40	smell.....	48
Reaumur.....	40	Separators.....	143
Register for queen.....	180	tin.....	145
figure of.....	181	figure of.....	147, 148, 149
Reproductive organs.....	58	why used.....	145
female.....	60	wood.....	143
figure of.....	59	Shade for bees.....	153
male.....	58	evergreens.....	153
figure of.....	58	grove.....	153
Respiratory organs.....	54	grape vine.....	153
figure of.....	21	figures of.....	154, 155
Robber flies.....	317	Shipping.....	202
figures of.....	317, 318, 320	colonies.....	204
Robbing.....	308	queens.....	202
remedies for.....	308	Shrews.....	332
when to expect.....	308	Sir John Lubbock.....	47, 48
Rocky Mountain bee-plant.....	283	hearing in ants, etc.....	47
figure of.....	281	Skunk cabbage.....	259
when to plant.....	281	Smell in insects.....	48
Royal jelly.....	72	Smoker.....	221
		Bingham.....	222

Index.

	PAGE		PAGE
figure of.....	221	Swarms	96
Clark	222	after	97
figure of.....	222	piping before.....	98
how used.....	222	how secured	185
origin of.....	222	figure of.....	186
Quinby.....	222	second undesirable	187
figure of.....	221	prevented.....	188
Smyrniian bees.....	37	Sweet clover.....	267
Sour wood.....	285	figure of.....	269
figure of.....	284	Syrian bees	37, 196
Specialists as bee-keepers	1	importation of	37
Spermatheca	60	superior how	38
discovery of	60	Tachina fly	325
function of	60	figure of.....	325
Spider plant.....	291	Tailor bee	28
figure of.....	290	cells of	28
Spiders.....	22, 330	Teasel	275
Spring dwindling	304	figure of.....	275
preventive	304	Telephone to warn of swarming	184
Starting an apiary.....	113	Test for honey	100
Sterile queens	77	Thorax	50
Sting of worker	89	muscles of	50
figure of.....	90	figure of.....	51
how used.....	90	organs of.....	50
Stinging bug.....	321	legs	51
figure of.....	322, 323	wings.....	50
Stingless bees	27	Tick seed.....	289
Stings—		Toads.....	331
how to cure.....	223	Tongue	45
how to prevent.....	218	of queen	68
bee tent.....	212, 225	figure of.....	67
bee veil.....	219	of worker.....	84
chloroform	223	figure of.....	85
dress for ladies	220	Trachea	21
gloves	219	figure of.....	21
smoke	221	Transferring.....	158
St. John's wort	285	Heddon's way	158
Stomach of insects.....	56	old method.....	159
Stone crop	276	Transformations of insects.....	22, 61
Storing	216	complete	22, 61
side	216	incomplete	22, 65
top	216	Trigona	27
Sub-class of insects.....	22	Tulip	274
Sub-class of the honey-bee	22	figure of.....	274
Strong colonies.....	214	Tulip tree bark louse	249
how secured	214	figure of.....	249
imperative to comb honey	214	Uniting bees	303
Sumac	262, 274	Varnish tree.....	265
California.....	262	Veil.....	219
Sunflower.....	289	figure of.....	219
figure of.....	289	Verbena-vervain	285
Swarming	96, 182	Viallon candy.....	203
abnormal	98	Viper's bugloss.....	285
cut short.....	98	Virgin queens	73
preparations for	96	drone layers.....	73, 74
prevented.....	188	Virginia creeper.....	285
undesirable.....	182	Vinegar	246
when it occurs.....	96	Virgil	39
why it occurs.....	96	Wasps.....	330
Swarming fever.....	215	Wax	101, 235
prevented how.....	215	composition of.....	102
by manipulation.....	215		
Heddon's method.....	215		
Miller's method.....	215		
Swarmmerdam	39		

Index.

	PAGE		PAGE
expensive.....	102	proper temperature.....	296
from carbohydrates	102	how secured	296
pockets	101	Wire for foundation.....	235
figure of.....	101	Wistaria	261
save all.....	235	American.....	261
how done	236	figure of.....	261
scales.....	101	Chinese	261
figure of.....	101	figure of.....	262
secretion voluntary	103	Women as bee-keepers	5
Wax extractor	236	Worker bees	83
Swiss	236	development of	92
figure of.....	236	figure of.....	83
Jones.....	237	food of larvæ.....	93
figure of.....	237	from impregnated egg.....	92
White clover	266	function of	95
figure of.....	266	old bees	95
Willow.....	260	young bees.....	95
figure of.....	260	glands of.....	86
Wings of bees	30	figure of.....	87
figure of.....	30	how they sip	86
of insects	50	jaws of	88
White sage.....	262	figure of.....	88
figure of.....	264	legs of	88
Wintering	293	figure of.....	89
by packing.....	296	longevity of	94
figure of.....	297	mouth parts of.....	84
disastrous why.....	293	sometimes fertile	83
bad food.....	293	sting of.....	89
extremes of temperature	294	figure of.....	90
moist atmosphere in hive	294	how used	91
old bees	293	stomach of.....	92
in bee house	300	tongue of.....	84
in cellar.....	301	figure of.....	85
in chaff hives	298	very numerous.....	83
figure of.....	133, 299	Worms.....	19, 20
method of	299	Xylocopa	28
in clamps	303	Zinc	216
safe	294	perforated	216
requisites for	294		
good honey	295		
late breeding	295		



THE BEE-KEEPERS' GUIDE

—OR—

MANUAL OF THE APIARY.

By **A. J. COOK**, Lansing Michigan,
Prof. of Entomology in the State Agricultural College.

3000 SOLD IN SIX YEARS.
350 Pages. 192 Illustrations.

This is a new edition of Prof. Cook's Manual of the Apiary, enlarged and elegantly illustrated. The first edition of 3,000 copies was exhausted in about 18 months—a sale unprecedented in the annals of bee-culture.

The tenth 1,000 has been thoroughly revised, much new matter and many costly illustrations added, and has been produced with great care, patient study, and persistent research. It comprises a full delineation of the anatomy and physiology of the honey bee, illustrated with many expensive wood engravings; the products of the Honey Bee; the races of bees; full descriptions of honey-producing plants, trees, shrubs, etc., splendidly illustrated; and last, though not least, detailed instructions for the various manipulations necessary in the apiary.

Read the following opinions of the Book:

I feel like thanking God that we have such a man as Prof. Cook to take hold of the subject of bee-culture in the masterly way in which he has done it.—*Gleanings in Bee Culture.*

It is a book which does credit to our calling; one that every bee-keeper may welcome as a fit exponent of the science which gives pleasure to all who are engaged in it.—*American Bee Journal.*

It is just what might have been expected from the distinguished author—a work acceptable to the ordinary bee-man, and a delight to the student of scientific apiculture.—*Bee Keepers' Magazine.*

Cook's new "Manual of the Apiary," comes with high ecomiums from America, and certainly it appears to have cut the ground from under future book-makers for some time to come.—*British Bee Journal.*

Prof. A. J. Cook's "Manual of the Apiary" contains, besides the description of the anatomy and physiology of the honey bee, beautifully illustrated, the products and races of the bees, honey plants—the instructions for the different operations performed in the hives. All agree that it is the work of a Master, and is of real value.—*L'Apiculteur, Paris.*

I have read with a great deal of interest the copy of Cook's Manual you sent me, and I intend to publish extracts from it in the "Bulletin" of the Society of Apiculture of the Department of the Somme, so that our apiarists may be aware of the value of this estimable work. It is a credit to the author as well as the publishers. I have never yet met with a work, either French or foreign, which I like so much.—*L'Abbe L. DuBois, at La Malmaison Aisne, France.*

Every point connected with the subject is handled in a clear, exhaustive, yet pithy and practical manner.—*Rural New Yorker.*

The most thorough work on the apiary ever published, and the only one illustrating the various bee plants.—*Lansing (Mich.) Republican.*

Treating the art in all its different branches in a clear, concise and interesting manner.—*The Canadian Entomologist.*

It is the fullest, most practical, and most satisfactory treatise on the subject now before the public.—*Country Gentleman.*

Prof. Cook's valuable Manual has been my constant guide in my operations and successful management of the apiary.—*J. P. WEST.*

I have derived more practical knowledge from Prof. Cook's New Manual of the Apiary than from any other book.—*E. H. WYNKOOP.*

With Cook's Manual I am more than pleased. It is fully up with the times in every particular. The richest reward awaits its author.—*A. E. WENZEL.*

We have perused with great pleasure this *vade mecum* of the bee-keeper. It is replete with the best information on everything belonging to apiculture. To all taking an interest in this subject, we say, obtain this valuable work, read it carefully and practice as advised.—*Agriculturist, Quebec.*

I regard it as the best work on bees in the world.—*P. L. VIALLEN.*

It is so greatly superior to all the other works that I recommend no other.—*D. A. JONES.*

Price, by mail, \$1.25. Liberal discount made to dealers, and to newspapers who may desire to send it as a premium.

A. J. COOK,
Lansing, Michigan, Author and Publisher.

DUNHAM FOUNDATION MACHINE

FRANCES DUNHAM,

Inventor and Sole Manufacturer of the

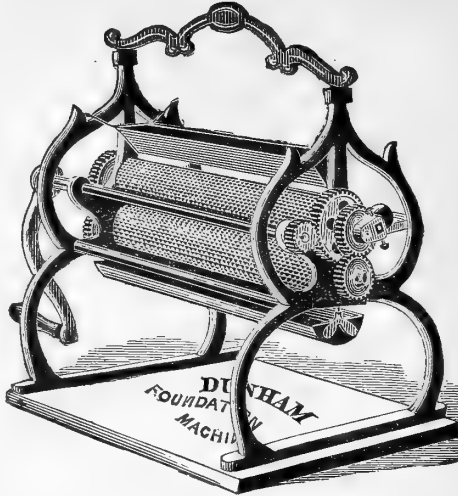

**DUNHAM
COMB FOUNDATION MACHINE.**

DEPERE, BROWN COUNTY, WIS.

Your machifes are undoubtedly the very best in existence for heavy foundation.
November 24th, 1882. **CHARLES DADANT & SON, Hamilton, Ill.**

I send you samples of Foundation which I am manufacturing on one of your machines, in sheets 9x18, which measure 11¼ feet to the pound. I think it superior to any samples of thin foundation I have seen.
August 14th, 1882. **J. G. WHITTEN, Genoa, N. Y.**

I have manufactured tens of thousands of pounds of Foundation on the Dunham machine and find that it does its work exceedingly well—thus far I have found none that will beat it. The bees accept and work out the foundation from this machine much more readily and with more satisfaction than with any I have yet tried. I have also made with it Foundation for section boxes, fully as light, or lighter than any others. I have no interest in the Dunham machine, and the moment I can find its superior, I shall purchase one and discard my old machine.
Beeton, February 10th, 1883. **D. A. JONES.**

PRIZE QUEENS.



Tested Prize Queen, in a two-frame nucleus,	
9x17, each	\$4 00
Same, in nucleus, four-frame, 8x8.....	4 00
Tested Prize Queen, by mail.....	3 00
Prize Queen, warranted purely fertilized	2 00
Queen; not standard size.....	1 00
Full Colony, eight-frames, Prize Queen.....	8 00

Before June 25, add \$1.00 each.
Cash Orders filled in rotation. Address,

E. L. BRIGGS,
Wilton Junction, Iowa.

NEW YORK TRIBUNE.

As a newspaper, THE NEW YORK TRIBUNE is held by readers of a quarter of a century, the best, purest, and most dignified in the United States. It covers the interesting current news of the whole world. Its reports are full and accurate. It is the only New York Newspaper that has its own telegraph line to Washington. No expense is spared. THE TRIBUNE has spent a million and a half dollars in one year. Its present prosperity enables it to disburse money as abundantly as the times ever demand for information in politics, business, education and society.

It treats all sections of the country with liberality and fairness. It has sent special correspondents through the South, the Mining Regions of the West, the Wheat Regions of the Northwest, the Lumber Camps of Puget Sound, and other parts of the United States which have attracted attention. It expects to remain active in this work. It now has an agent in England, sent out especially to write up the operation of Free Trade in that country.

THE TRIBUNE is a safe visitor in any family. Its language is always pure and dignified. It always fights that which degrades humanity, and strives to quicken every proper aspiration. Everybody who reads THE TRIBUNE is the better for it, and many a successful man traces his rise in life to the inspiration of its columns.

The paper remains entirely independent of party dictation and caucus control.

It has the best poems, stories, and current literature of any paper. Its book reviews and art and dramatic criticisms are of marked and special ability.

The paper is cheaper than ever before, and cheaper than any paper of its class in the country. Dr. Townshend, of the Ohio State University, gives it the credit of containing "more that one wants to know, and less that one doesn't want to know," than any paper with which he is acquainted.

It recognizes Agriculture as one of the great industries of the country, and prints more information of value to farmers than any other daily paper.

THE TRIBUNE has always been, and is, a warm advocate of the development of American industry, for the sake of strengthening the Republic, employing the whole population, giving a chance to all young men, and filling the country with peaceful and happy homes.

To the working teacher of American common schools, THE TRIBUNE is a constant friend and daily help. It advocates an increase of pay to teachers. In all that will promote the efficiency and advance the dignity of the common-school system, it will be a cheerful and faithful worker.

THE SEMI-WEEKLY TRIBUNE has nearly all of the news of the DAILY, and is, in some respects, the best, as well as the cheapest paper sent out from THE TRIBUNE Office. It contains all of the literary, agricultural, and domestic miscellany, and all the special articles prepared for THE WEEKLY. It has besides most of its editorial articles not strictly local in their application. It is printed in sixteen-page form. It is immeasurably the most successful Semi-Weekly in the country.

THE WEEKLY TRIBUNE has the largest circulation of its class in the United States. Each week it contains a summary of all the news of the world, in such shape that busy men can read and enjoy. It has the letters giving the best news from foreign lands, and from time to time others describing the resources, attractions and pursuits of different portions of the United States. It has a strong agricultural department, good market reports, and pages written for the benefit of ladies, giving accurate instructions in knitting, crochet, and kindred subjects. It also prints every year several good novels and stories, the cost of which in book form would be several dollars.

A strong point of the paper is that it is printed in large, plain type, suited to the eyes of studious readers.

To those willing to form clubs for THE TRIBUNE, circulars, show bills and sample copies of the paper will be sent in any desired quantity.

TERMS.

THE WEEKLY TRIBUNE.—A single copy, one year, \$2.00; five copies, one year, \$1.50 each; ten copies, one year, \$1.00 each.

THE SEMI-WEEKLY TRIBUNE.—Single copy, one year, \$3.00; five copies, one year, \$2.50 each; ten copies, one year, \$2.00 each.

THE DAILY TRIBUNE, including the Sunday edition, is \$12 per year, \$3 for three months, \$1.20 for one month. Without the Sunday edition, \$10 per year, \$2.50 for three months, \$1 for one month. The Sunday edition alone is \$2 per year.

Remit by draft or Money Order. If the cash is sent, it should always be by registered letter. Address

THE TRIBUNE, New York.

SCOVELL BEE SMOKER.

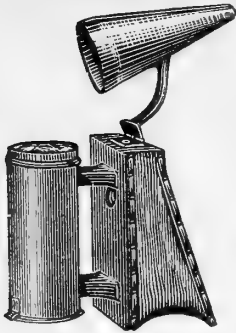

Scovell's Hinged Nozzle Cold Blast Bee Smoker is the result of years of experiment, practically applied by a practical mechanic and well known bee master. The first "Scovell Smoker" was made in the spring of 1875, and was the first bee smoker—of which we have any record—to use the open or direct draft principle. Our smokers are of the largest size in use, of the best material, well made and nicely finished. Read what the people say.

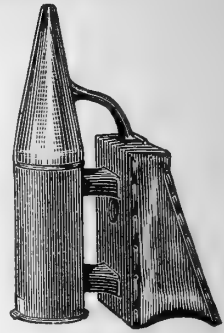

TESTIMONIALS.

DEAR SIR:—Your smoker will soon become very popular here. I never saw one that I like better. W. H. ANDREWS, McKinney, Texas.
I think I have tried every smoker made except the "Quinby Double Draft," and find none better than yours. I shall take pleasure in recommending it.

F. L. WRIGHT, Plainfield, Mich.
I have given the smoker three days trial while extracting, and my little son who runs the smoker, says "it beats Clark's, Bingham's, or the celebrated Root Simplicity, which in principle it resembles. It is the best smoker I ever used.

B. F. CARROLL, Dresden, Texas.
It is simple in construction and not liable to get out of repairs, and completely "cold blast" as by no possibility can a blast of hot air be thrown from it. I consider it the *ne plus ultra* of smokers.

J. E. POND, JR., Foxboro, Mass.
Smoker came O. K., and it's a daisy. E. B. VINCENT, M. D., Sumner, Ind.
The successful use of cotton seed as a smoker fuel, and a smoker to burn the same, is a valuable acquisition to the bee keeper, where good smoker fuel is scarce, especially in the south, where cotton seed is so plentiful. You have indeed a valuable invention. Many thanks for the smoker sent.

Yours, etc., DR., WM. R. HOWARD, Kingston, Texas.
It costs nothing to give our smoker a trial. If it don't give satisfaction, notify us in ten days, by postal card and we will return all moneys paid for it. Regular retail price, \$1.00; by mail, \$1.25.

Address, SCOVELL & ANDERSON, Columbus, Kansas.

THE KANSAS BEE KEEPER.

ESTABLISHED IN 1881.

The BEE KEEPER is a live monthly magazine devoted exclusively to bee culture. It has for its corps of regular correspondents and assistant editors some of the most practical writers and progressive bee keepers of the age.

Prominent among its valuable features for 1883, will be a series of original articles, running through the whole volume, written expressly for beginners in the practice of the art of bee culture, by J. E. Pond, Jr., Foxboro, Mass, and the QUESTION DRAWER, edited by the well known specialist, James Helden, Dowagiac, Mich.

The first aim of the BEE KEEPER is to be the best and foremost bee paper in the world, to the end that bee culture, as a scientific and useful pursuit, may through its agency more rapidly develop into one of the most profitable and important industries of the globe.

PUBLISHED AT SIXTY CENTS A YEAR.

H. SCOVELL, Editor.

WM. R. HOWARD, M. D.,

Address

Kingston, Texas, Associate Editor.

**SCOVELL & ANDERSON, Publishers,
COLUMBUS, KANSAS.**

THE BRITISH BEE JOURNAL

— AND —

BEE KEEPERS' ADVISER.

ESTABLISHED 1873.

Conducted by the Hon. Secretary of the British Bee-Keepers' Association.

THE BRITISH BEE JOURNAL has hitherto been published monthly. Owing to the increased knowledge of Bee Culture, the formation of numerous County Bee-Keepers' Associations, and the development of the industry of Bee-Keeping generally throughout the United Kingdom of Great Britain, it has been found necessary to increase its pages, and to publish it at more frequent intervals.

A new volume commences on May 1st in each year.

ON AND AFTER MAY 1st, 1883,

The BRITISH BEE JOURNAL will be Published on the 1st and 15th of every Month.

Price Threepence; Post Free, Threepence-Halfpenny.

THE BRITISH BEE JOURNAL is devoted to the interest of Bee-keepers, the promotion of Bee-keeping, and Bee-Keepers' Associations and Clubs throughout the United Kingdom. It gives the fullest Reports of all Shows, Meetings, and Lectures, and contains the best articles by the highest authorities upon all subjects bearing upon Bees and Bee-keeping.

A principal feature of the BRITISH BEE JOURNAL is the department allotted to 'Echoes from the Hives,' and 'Queries,' under various headings. Its readers resort to the Editor in all cases of difficulty in the management of their Bees, and no trouble or expense is spared to obtain answers from the best authorities.

SCALE OF CHARGES FOR ADVERTISEMENTS:

SINGLE COLUMN—	£	s.	d.
Three lines	0	1	6
Per line afterwards	0	0	6
Inch of space	0	3	6
Quarter column	0	8	0
Half do.	0	15	0
Whole do.	1	5	0
DOUBLE COLUMN—			
Page	2	10	0
Half page	1	7	6
Third page	1	0	0
Quarter page	0	17	6

Letters to the Editor, should be addressed '*The Editor, BRITISH BEE JOURNAL, care Strangeways & Sons, Tower Street, Upper St. Martin's Lane, London, W.C.*'

1831 THE CULTIVATOR 1883

— AND —

COUNTRY GENTLEMAN.

The Best of the Agricultural Weeklies.

ENLARGED TO TWENTY PAGES.

THE COUNTRY GENTLEMAN is the LEADING JOURNAL of American Agriculture. In amount and practical value of contents, in extent and ability of correspondence, in quality of paper and style of publication, it occupies the FIRST RANK. It is believed to have no superior in either of the three chief divisions of

**Farm Crops and Processes,
Horticulture and Fruit Growing,
Live Stock and Dairying,**

While it also includes all minor departments of rural interest, such as the Poultry Yard, Entomology, Bee-Keeping, Greenhouse and Grapery, Veterinary Replies, Farm Questions and Answers, Fireside Reading, Domestic Economy, and a summary of the News of the Week. Its Market Reports are unusually complete, and much attention is paid to the Prospects of the Crops, as throwing light upon one of the most important of all questions—When to Buy and When to Sell. It is liberally Illustrated, and is intended to supply, in a continually increasing degree, and in the best sense of the term, a

LIVE AGRICULTURAL NEWSPAPER.

The Volume of THE COUNTRY GENTLEMAN has been LARGELY INCREASED in Contents by the addition of a Four Page Supplement, but the terms continue as follow, when paid strictly in advance: ONE COPY, one year, \$2.50; FOUR COPIES, \$10, and an additional copy for the year, free, to the sender of the Club; TEN COPIES, \$20, and an additional copy for the year, free, to the sender of the Club.

☞ SPECIMEN COPIES FREE. Address,

**LUTHER TUCKER & SON, Publishers,
ALBANY, N. Y.**

BARNES' PATENT FOOT-POWER MACHINERY.

COMPLETE OUTFITS.

With which Builders, Cabinet Makers, Wagon Makers, and Jobbers in Miscellaneous Work, can compete as to Quality and Price with Steam-Power Machinery.

WILL SEND MACHINES ON TRIAL IF DESIRED.

Every Bee-Keeper should have an Outfit from these Machines for Hive-Making.

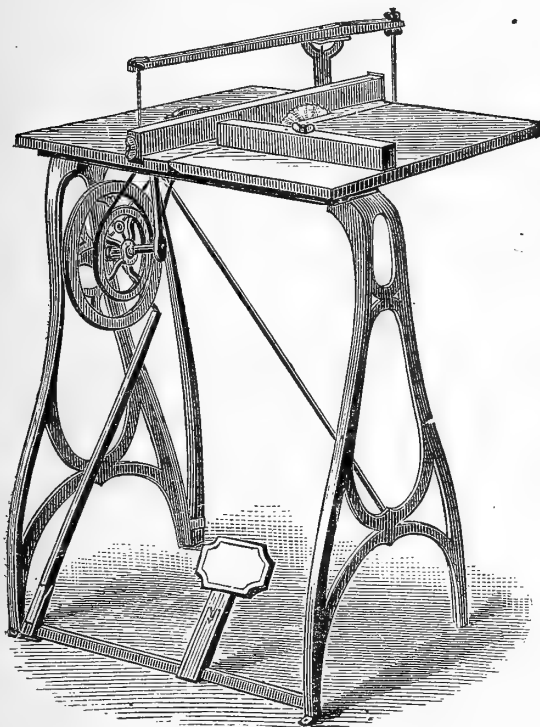

We give the following letter from Mr. W. P. Hogarty, of Wyandotte, Kansas, to show their usefulness. He says: "If any criticise your Circular Saw, you can tell them I use it, and made all my Bee Hives for ninety-five stands of Bees including frames and section brace, and I feel perfectly able to do the work for one hundred and fifty stands." * * * "In order that you may know the amount of work on each of my Hives, will say, they are two feet long, by two feet high, by about two feet wide. They are double walled and double bottomed, with two inch intervening; and in addition to the nine frames, there are fifteen cases, each case containing two honey boxes and two division boards, and three boxes to contain chaff for winter protection. You will see there is an immense amount of sawing to be done, but I have found your Saw equal to the task required of it."

We will send our Illustrated Catalogue FREE on application. Say where you read this, and address

W. F. & JOHN BARNES,
No. 2094 Main Street, Rockford, Winnebago, Co., Ill.

SOMETHING NEW!

THE FIRST BOOK PUBLISHED ON QUEEN-REARING.

Twenty-two Years Experience in Queen-Rearing,

—BY—

HENRY ALLEY, WENHAM, MASSACHUSETTS.

Price by Mail, in Cloth, \$1.00 per Copy.

This work is intended to teach my New Method of Queen-Rearing; it also gives my experience during the past

Twenty-Five Years as a Practical Bee-Keeper,
Twenty-two of which have been devoted to Queen-Rearing. The work is so

WRITTEN AND ILLUSTRATED

That any Bee-keeper may understand the method given. It contains

The Easiest, Simplest, Nearest to the Natural
And most Scientific Method of Queen-Rearing by which

THE CELLS ARE SO UNIFORMLY BUILT

And Spaced, that each can be removed without injury to its neighboring cell, and a larger number of first-class cells produced with a given quantity of bees, than by any other process, and with

LESS LABOR AND EXPENSE.

It also contains new and valuable hints and ideas; and one of the best descriptions of

THE NEW RACES OF BEES

Yet given to the public; also, an essay on the best method of managing the Apiary in order to obtain

THE LARGEST AMOUNT OF SURPLUS HONEY,

Including, preparing and marketing the same, by one of the most prominent, practical and successful "Bee-Masters" in the country. This essay alone is worth ten times the price of the Book.

Enclose the money in the presence of the Postmaster, at my risk.
Send for Prospectus and Circular.

IMPROVED HONEY EXTRACTOR.

1882—New York.

Our Honey Extractors

Have always received the highest awards at all places where they have been placed on exhibition, and they have been exhibited in competition with every Extractor of any reputation in the United States.

First premiums were awarded them at the Michigan State Fair, in 1879, and again at same Fair in 1880 and 1881. First premium at North-Eastern Bee-Keepers' Convention, Feb. 11th to 13th, 1880. Also, 1881 and 1882. First premium at Queens County Agricultural Society, (largest Fair in New York State), Sept. 28th to 30th, 1880, and highest award at the Great American Institute Fair, Sept. 15th to Nov. 27th, 1880. Also in 1882 at the same Fair, they were awarded the medal of "superior excellence" (the highest given).

These Machines (*five different sizes*) are all metal, made up very strong, neat and durable. They are provided with close fitting tin covers, handles, honey gates, etc., extract all sizes of combs, and even small pieces without frames. All bits of comb and specks rise to the top and the honey is run off clear as crystal *without* strainer.

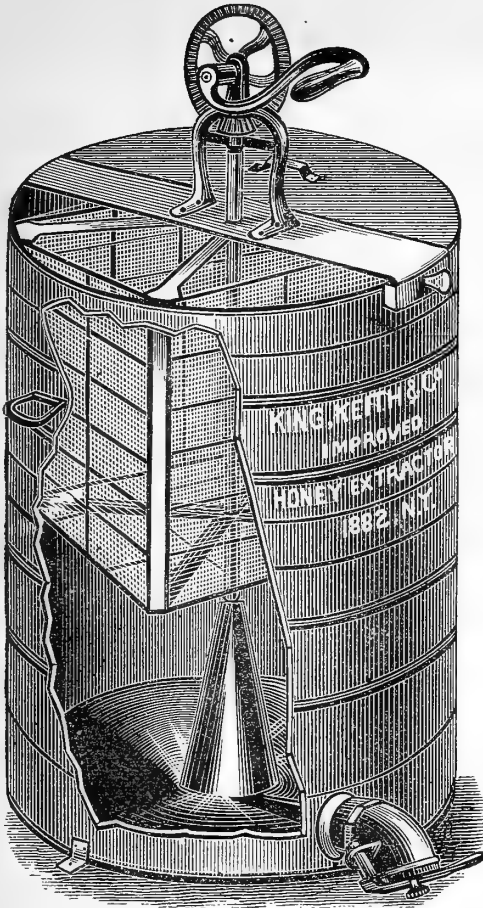

No. 1, 4 frame, holds over 200 lbs. honey, below basket.

Bees-Wax Extractors, Bee Hives and Materials Ready to Nail.

Smokers, Feeders, Bee Gloves, Bee Hats, Bee Books of all Modern Authors, Sections, Honey Jars, Seeds of Honey Plants, Italian and Syrian Bees, Queens, Honey, both Extracted and in the Comb, Foundation and Machines for its Manufacture, etc., etc.

Send for our NEW ILLUSTRATED CATALOGUE, with Prices of all the above and much more.

PUBLISHERS OF THE BEE AND POULTRY MAGAZINE, \$1.25 A YEAR.

KING, KEITH & CO.,

14 Park Place, New York.

THE BEE KEEPERS' EXCHANGE.

A MONTHLY JOURNAL of 32 PAGES

— DEVOTED TO THE INTERESTS OF —

BEE KEEPERS.

Is progressive and keeps abreast of all the modern
improvements, in apiculture,

No Bee Keeper should be without it.

EVERY NUMBER IS WORTH THE PRICE OF A
YEAR'S SUBSCRIPTION.

It Costs only One Dollar per annum, or Three Months
on trial for Twenty-five Cents, Post paid.

Address,

HOUCH & PEET;
CANAJOHARIE, N. Y.

PELHAM'S PATENT FOUNDATION MILL.

(Patented May 23d, 1882.)

Believing it to be to the interest of Bee-Keepers' to make their own Comb Foundation, at home, under their own personal supervision, I have labored for more than three years to devise a Mill that would be both *cheap* and *efficient*.

Having now perfected my invention, I submit it to the judgment of my fellow Bee-Keepers, believing it to be as good as any, and superior to some of the Foundation Machines heretofore made.

The rolls of my Mills are made of hard type-metal. They are not formed into shape with a punch, but are *cast* in sections, by which means I can make the grooves for forming sidewalls $\frac{1}{8}$ of an inch deep in the rolls. It will be readily seen that as the wax does not reach the bottom of the groove, the top of the sidewall is not pressed upon at all, but is left as soft as it is possible for any Machine to make it.

By a simple device the upper roll may be raised to permit the end of the wax-sheet to be passed through at starting, without any impression, far enough to take hold of; the pressure is then put on by moving a single lever and the sheet rolled through.

Samples of Foundation and Descriptive Circular will be sent on application.

WM. C. PELHAM,
Maysville, Kentucky.

MARCH, 1883.

Van Alstine & Howe

106 Tremont Street,

Under Studio Building,

Optical Goods,

ARTIFICIAL EYES, &c.

*A Competent Optician
always in Attendance.*

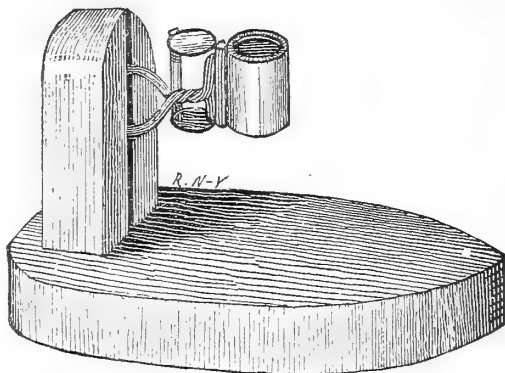

Examinations of the Eye Made without an Extra Charge.

All Kinds of Optical Goods kept constantly on hand.

MICROSCOPES.

We furnish Microscopes and Microscopical Apparatus of all kinds, Foreign and American, at the Lowest Prices.

WE MAKE A SPECIALTY OF CODDINGTON LENSES.

All Goods Warranted the best of the Kind.

S. M. VAN ALSTINE.

BOSTON, MASS.

B. V. HOWE.

THE NEW ENGLAND APIARIAN,

—PUBLISHED BY—

W. W. MERRILL,

Publication Day, 15th of each Month.

P. O. Box, 100.

MECHANIC FALLS, MAINE.

Terms, 75 Cents Per Year, in Advance.

LIBERAL INDUCEMENTS TO AGENTS.

DEVOTED TO THE INTERESTS OF THOSE ENGAGED IN BEE CULTURE.

Each number containing articles of rare interest from the pens of eminent men, among whom may be mentioned.

JAMES HEDDEN, A. J. COOK, DR. McLAUGHLIN,
J. E. POND, JR., J. B. MASON, G. W. DEMAREE,
W. W. DUNHAM, E. A. THOMAS, W. HOYT, &c.

Making each number instructive, rich and racy in matters pertaining to the fascinating profession of the Apiarist.

Being the only Journal of the kind in the New England States, it offers the very best medium for advertisers to reach the many who are more or less engaged in business of supplying the markets with honey.

The editor solicits questions and discussions that may tend to the advancement of light upon any of the interests or work of the Apiarist, and hopes by untiring zeal to make THE NEW ENGLAND APIARIAN a welcome guest to the many homes of those engaged in Bee Culture in the New England States and in many homes in more remote regions.

Will be pleased to send sample copies to any who may desire, as well as to receive YOUR subscription for one year.

All communications, etc., should be addressed to

W. W. MERRILL,

MECHANIC FALLS, ME.

MUTH'S HONEY EXTRACTOR.

All Metal, Always Ready, Easily Cleaned, Everlasting!

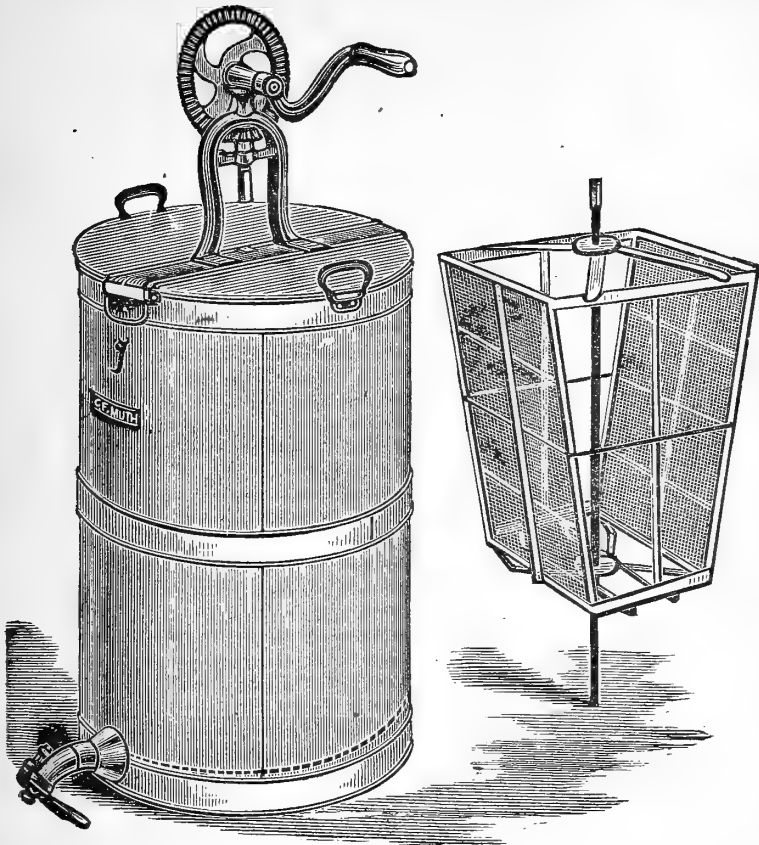

MUTH'S GLASS HONEY JARS.

My one and two pound square Honey Jars have now been tested for years, and have not only found favor among dealers and consumers, but are also the most practical and best jars in the market, all points considered, and require no recommendation. As jars of honey are generally bought for table use, the best honey only should be bottled. A neat label on each jar, with the producer's name plainly printed, will often serve as a reminder to the consumer of the place where the last nice honey was purchased.

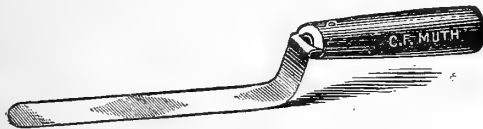

Muth's Uncapping Knife.

CHARLES F. MUTH,

No. 976 Central Ave.,

CINCINNATI, O.

Send 10 Cents, for "Practical Hints to Bee-Keepers." Circulars Free.

GLEANINGS

— IN —

BEE CULTURE,

TERMS, \$1.00 PER YEAR.

GLEANINGS is a 52-page monthly, published the first of each month. A supplement, JUVENILE GLEANINGS, of 16 pages, is published the middle of each month, thus giving reports semi-monthly of the state of Bee Culture in almost all regions of the globe where civilization extends.

A B C OF BEE CULTURE.

A Book of 318 pages, and over 175 Illustrations. This is kept standing in type, and corrected several times a year; thus when you buy it you are sure of a book that is up with the times. Price, in cloth, \$1.25; in paper, \$1.00.

Apiarian Implements and Supplies.

Our customers now number something over 75,000, and goods are shipped to all parts of the world. To keep pace with late improvements and new inventions, our price list is kept constantly standing in type, and new editions are printed in the busy season, frequently as often as once a month. A sample copy of GLEANINGS and a price list, sent free on application.

A. I. ROOT,
MEDINA, OHIO.

THE ORIGINAL PATENT DIRECT-DRAFT SMOKER

Patented 1878 and 1882. Re-issued July 9, 1878.

OVER TWENTY THOUSAND NOW IN USE.

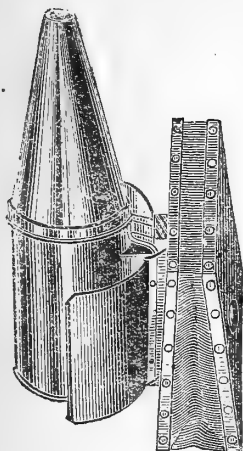

The Michigan Bee-Keepers' Association, having all the Smokers before it, "pronounced Bingham's Patent Smoker the best."

J. P. Moore, Binghamton, New York, after using one some time, said: "My Smoker troubles are all over, and bee-keepers owe you a debt of gratitude."

Professor Cook, of Michigan Agricultural College, says: "It is the best in the market."

R. M. Argo, Lowell, Kentucky, says: "It is all that any bee-keeper could desire."

Paul L. Viallon, Bayou Goula, La., writes, April 6, 1878: "Your Smokers are far superior to any ever invented, and we bee-keepers owe you a vote of thanks for your ingenious invention. Many may try to improve on yours, but I am positive none will make a better one."

BORODINO, N. Y., August 15, 1882.

CYPRIONS CONQUERED.—All summer long it has been "which and tother" with me and the Cyprian colony of bees I have, but at last I am "boss." Bingham's Conqueror Smoker did it. If you want lots of smoke just at the right time, get a Conqueror Smoker of Bingham.

Respectfully,

G. M. DOOLITTLE.

BINGHAM & HETHERINGTON HONEY KNIFE.

Patented May 20, 1879.



The most Extensive Bee-Keepers use them exclusively.

The Knife is so constructed that only the thin beveled edge rests on the combs, and the caps, after being cut off, slide up in large sheets and roll over on the knife, like shavings from a sharp plane. As only the edge of the knife touches the honey, it does not wade and stick like other knives, but glides easily over curves, planes, and hollows, leaving the uncapped honey free from caps, and the cells as clean, perfect and smooth as if they had never been capped. They are two inches wide, tempered and finished like a razor, and will last for a life-time.

We are practical bee-keepers, and first invented the Bingham & Hetherington Honey Knife and the Bingham Smoker for our own use in our own apiaries, because such knives and smokers as bee-keepers need could not be had at any price. We are the patentees and exclusive manufacturers of our knives and smokers, and they are the only supplies we handle. While no other implements ever offered to bee-keepers have had such sale and universal commendation, we are glad to say no word of complaint has ever been made to us, or Knife or smoker returned.

PRICES.—The Conqueror Bingham Smoker.....3 inch, \$1 75
 Large Bingham Smoker, wide shield.....2½ " 1 50
 Extra Standard Bingham Smoker, wide shield.....2 " 1 25
 Plain Standard Bingham Smoker, narrow shield...2 " 1 00
 Little Wonder Bingham Smoker, narrow shield...1¾ " 50
 Bingham & Hetherington Honey Knife.....2 " 1 00

If to be sent by mail, or singly by express, add 25 cents to prepay postage or express charges. To sell again, apply for dozen or half-dozen rate. Send card for Circular. Address,

BINGHAM & HETHERINGTON, Abronia, Mich.

BEE KEEPERS' GUIDE

28 Pages, 50 Cents Per Year.

SPECIMEN COPY FREE.

A. G. HILL,
Kendallville, Ind.

A. G. HILL'S BEE KEEPERS' SUPPLIES.

THE WINTER OR IMPROVED AMERICAN BEE HIVE.

A New Chaff Cap, as a Winter Protector for
the above Hive.

Section Honey Boxes, Honey and Wax Extractors,

All of which have been designed by the
Manufacturer.

Send for Prices.

A. G. HILL,
KENDALLVILLE, IND.

ARTIFICIAL SWARMS.

A PAMPHLET OF SIXTEEN PAGES.

A system by which Bees may be increased to the greatest extent, without violating the laws of natural swarming. It gives a plan by which a moderate increase may be obtained, and is a system of Queen rearing. Every novice should read it.

Sent to any address for two 3-cent stamps.

A. G. HILL, Kendallville, Ind.

ALFRED H. NEWMAN,

DEALER IN ALL KINDS OF

SEEDS for HONEY PLANTS

SUCH AS

Melilot, White and Alsike Clovers,
Mammoth Mignonette,
Cleome, Mustard, etc.



Tin Pails for Marketing Honey.

Bee Keepers' Supplies

INCLUDING

Kegs for Extracted Honey,

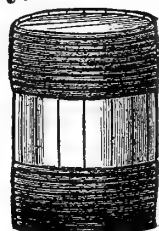

The Excelsior Honey Extractors,
Comb Foundation—all styles,
Bee Hives—nailed and flat,
Sections, Crates and Frames,
Smokers, Honey Knives,
Bee Veils, Gloves, etc.

SEND FOR MY NEW ILLUSTRATED CATALOGUE.

923 West Madison Street, CHICAGO, ILL.

The Only Weekly Bee Paper in the World

AND

THE OLDEST BEE PERIODICAL IN AMERICA.



American Bee Journal

TWO EDITONS—WEEKLY AND MONTHLY.

Weekly, \$2 a year; Monthly, \$1 a year, in advance.

Three or Six Months at the same rate.

A Sample Copy of either free upon application.

THE AMERICAN BEE JOURNAL, established in 1861 as a Monthly, was, in 1881, also issued Weekly, and has not only fully sustained its former reputation, but is always advancing progressive ideas upon the various topics of Bee-Culture.

It is the most Thoroughly Practical Publication on Bees in the World.

The most successful and experienced Bee-Keepers in the World comprise its Corps of Contributors.

As an Advertising Medium it is Unsurpassed.

THOMAS G. NEWMAN,

EDITOR AND PROPRIETOR,

925 WEST MADISON STREET, CHICAGO, ILL.

F R I E N D S !

If you are in any way interested in

BEEES OF HONEY

We will, with pleasure, send you a sample copy of our

Monthly Gleanings in Bee Culture,

With a Descriptive Price List of the latest improvements in

HIVES, HONEY EXTRACTORS, ARTIFICIAL COMB,

SECTION HONEY BOXES,

All Books and Journals, and Everything Pertaining to Bee Culture.

NOTHING PATENTED.

Simply send your address on a postal card, written plainly, to

A. I. ROOT,
Medina, Ohio.

HEADQUARTERS IN THE SOUTH

— For the Manufacture and Sale of —

BEE-KEEPERS' SUPPLIES.

The Only Steam Factory of Bee Hives in the South.

COMB FOUNDATION, MADE ON ROOT AND DUNHAM MILLS.

ITALIAN BEES AND QUEENS A SPECIALTY,

All bred from Imported Mothers of my own Importations. For further particulars, send for my Illustrated Catalogue.

P. L. VIALON, Bayou Goula, La.

BEES AND QUEENS.

I will Mail my 20 page Price List of

Italian, Cyprian and Holy Land Bees and Nuclei Colonies,

Either in the American or Langstroth Frame,

CHOICE TESTED, WARRANTED and DOLLAR QUEENS

AND APIARIAN SUPPLIES,

To all who send me their name and address written plainly on a postal.

H. H. BROWN, Light Street, Col. Co., Pa.

HEADQUARTERS

— FOR —

PURE ITALIAN QUEENS, COLONIES AND NUCLEI,

Extractors, Bellows-Smokers, Knives, Foundation,
Veils, Gloves, Bee Books, Sample Hive, etc.

Being only 2½ hours from San Francisco, my facilities for shipping Colonies by Sea cannot be equalled. Can superintend all Colonies on board Steamer at San Francisco, if required. For particulars and Price List, address,

J. D. ENAS, Sunnyside, Napa P. O., Cal.

HEADQUARTERS IN TEXAS

For the Manufacture and Sale of All Kinds of

BEE-KEEPERS' SUPPLIES.

HOWARD'S SOUTHERN BEE HIVE, GALLUP FRAME a Specialty.

WIRED COMB FOUNDATION, in Gallup and Langstroth Frames, to Order,
on the Given Press.

ITALIAN BEES, QUEENS, etc., AT REASONABLE RATES.

Send for Catalogue and Price List.

Address DR. WM. R. HOWARD, Kingston, Hunt County, Texas.

Whitman's Fountain Pump.

As a remedy to prevent Bees going to the woods, we have never found anything half as useful as the Fountain Pump — *Bee-Keepers' Magazine.*

THE FOUNTAIN PUMPS

Are used for showering Bees when swarming, to cause them to light and cluster.

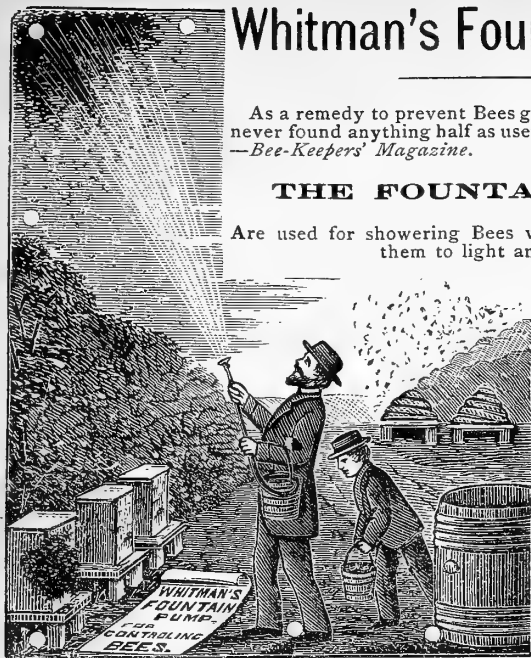

A Lady or Child can use it easily.

WASH BUGGIES.

Sprinkling Plants and Vines. Used in any position.

Send for large Illustrated Circular.

J. A. WHITMAN,
Patentee and Manufacturer
Providence, R. I.

FOUNDATION.

WHOLESALE AND RETAIL.

Dealers in Bee Supplies will do well to send for our Wholesale Prices of Foundation. We now have the most extensive Manufactory of Foundation in the country. We send to all parts of the U. S.

We make all standard styles, and our wax is nowhere to be equaled for cleanliness, purity, and beauty. Extra thin and bright for sections. All shapes and all sizes. Samples free on request.

CHAS. DADANT & SON,

Hamilton, Hancock Co., Ill.

W. Z. HUTCHINSON,
Rogersville, Genesee County, Mich.,

— Makes a Specialty of Rearing Fine —

ITALIAN QUEENS.

All Queens bred from Imported Mothers, and from the best Home-bred Mothers; and the Cells built in full Colonies. No Black Bees in this vicinity.
 Tested Queens, before June 1st, \$3.00 each. During June, \$2.50 each. After July 1st, \$2.00 each. Untested Queens, before June 1st, \$1.50 each. During June, Single Queen, \$1.25; Six, or more, \$1.00 each. After July 1st, Single Queen, \$1.00, Six for \$5.50, Twelve for \$10.00. Safe arrival guaranteed.
 Make Money Orders payable at Flint.

Hives, Sections, &c.

Langstroth, Simplicity and other Hives.

We make the one-piece, two-piece, or four piece dovetail or nailed Sections, any size, from half-pound to 6x6x2 inches, or any other SUPPLIES for Bee-keepers, made of wood.

4 1/4 x 4 1/4 of any of the above kinds of Sections, \$4.50
 All other sizes, larger to 6x6 5.00
 Half-pound Sections 3.50

Send for Price List and Illustrations of our NEW HIVE for Comb Honey— Something new, just out. Price Lists will only be sent to those that write for them.

G. B. LEWIS, Watertown, Jeff. Co., Wis., January 1, 1883.



The Lewis One-Piece Section.



The Lewis Two-Piece Sections.

I. R. GOOD,
OF NAPANEE, ELKHART COUNTY, IND.,

— Makes the Rearing of Fine —

HOLY LAND AND ITALIAN QUEENS A SPECIALTY.

Over One Hundred Colonies of Holy Land Bees in Holy Land Apiary.

MANUFACTURER OF GIVEN COMB FOUNDATION.

Highest Cash Price Paid for Bees-Wax. Send for Price List.

300 COLONIES of BEES for SALE.

Also, Hives, Foundation, Extractors, Sections, Smokers, Frames, &c.

I keep a complete Stock of everything needed in a first-class Apiary. I make a specialty of Queen-Rearing, and can fill orders promptly for all the different varieties of Bees. My Nucleus Colonies, and Full Colonies, give perfect satisfaction. I keep constantly on hand, Seeds for Bee Pasturage. Satisfaction guaranteed.

Send for Circular and Price List, to

E. T. FLANAGAN,

— PROPRIETOR OF —

ROSE HILL, LAKE, CAHOKIA and FALLING SPRING APIARIES.

Bellville, St. Clair County, Ill.

The very best reference given as to Financial Standing if desired.

D. A. JONES,

BEETON, ONTARIO, CANADA.

—Dealer in all Kinds of—

APIARIAN SUPPLIES,

Bees and Honey.

My honey and experimental bee farms are in and around Beeton, and my queen-rearing establishments are located on Georgian Bay, far from shore, and a sufficient distance from each other to insure pure fertilization.

I am the first importer of the famous Holy Land bees from Palestine and Syria, and I now import Holy Land, Cyprian and Italian bees; but those raised at my breeding establishments on the Georgian Bay are just as pure as the imported stock, and are superior, as they are bred with great care, and they do not have to stand the long journey across the waters from Asia.

HONEY KNIVES.

My honey knives are acknowledged to have no equal. They were invented and designed by myself, after a thorough test and trial of all others of note, and they combine the good qualities of all the others. They are manufactured of the finest razor steel, and bear a very fine edge and mirror polish.

HONEY LABELS.

My honey labels are the finest and cheapest in the world. They are designed for both comb and extracted honey; are printed in nine different colors, all blended together, making a fine chromo label, and varnished, and got up in sizes to suit packages from 2 ounces upward. Should they become soiled, they may be wiped off by a damp cloth.

GENERAL SUPPLIES.

A full supply of Hives, Smokers, Foundation (both brood and section), Sections, Perforated Metal, Bee-Guards, etc., etc.

Honey Tins in all sizes, from 2 ounces to 5 pounds.

I can supply everything required in the management of the smallest or largest apiary.

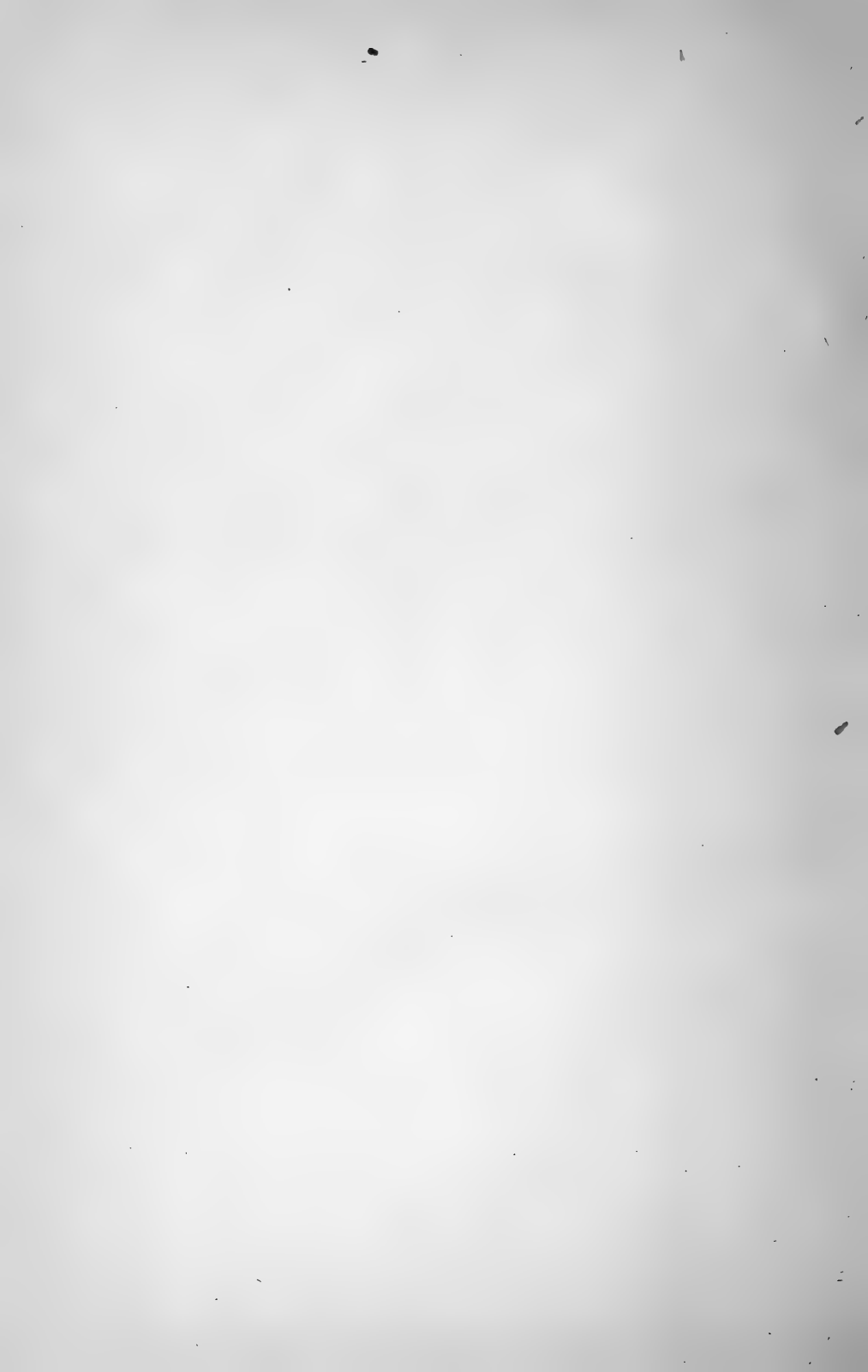

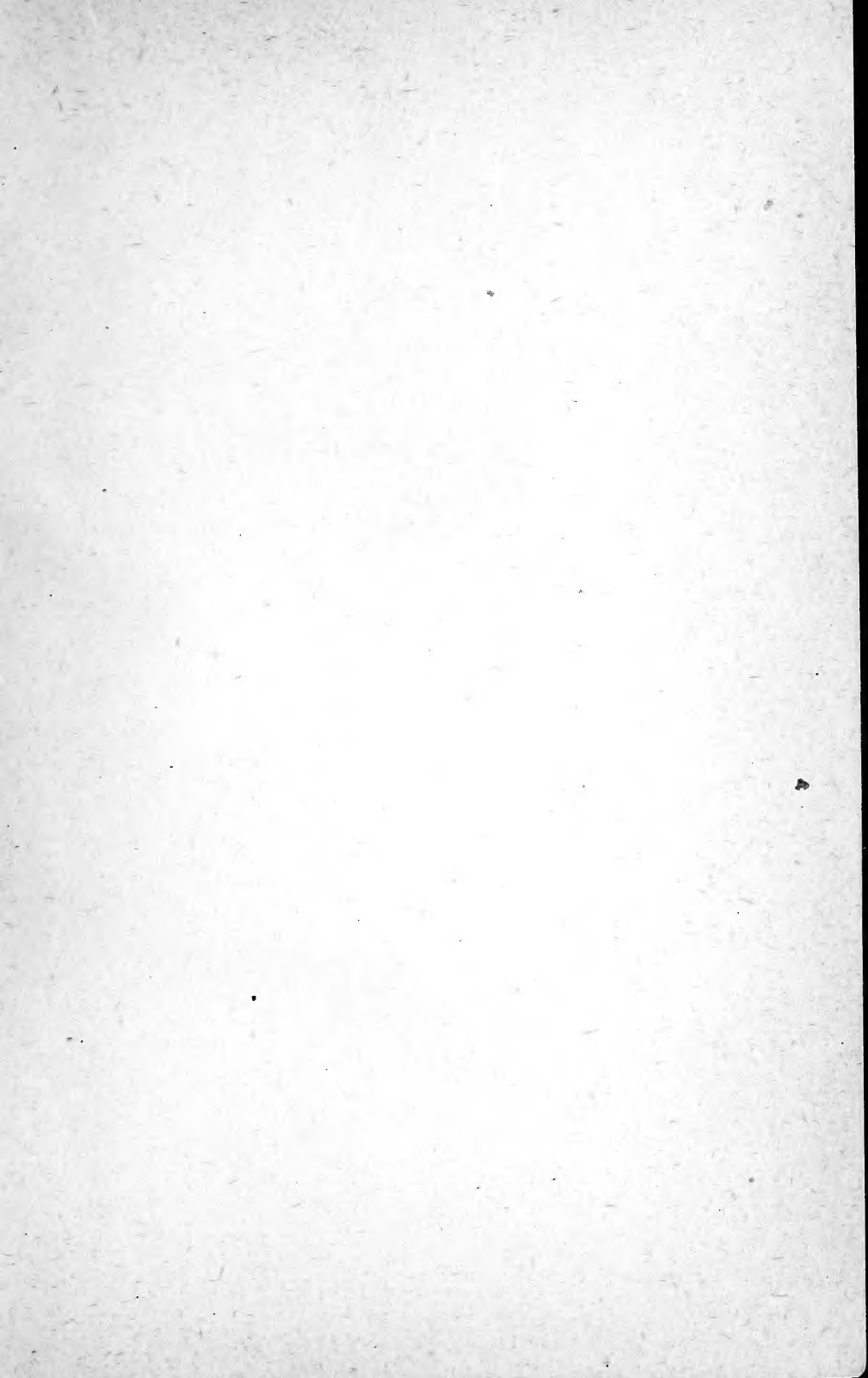



LIBRARY OF CONGRESS



0 002 837 428 8